

SH5A

Quick Start Guide

1. Appearance description

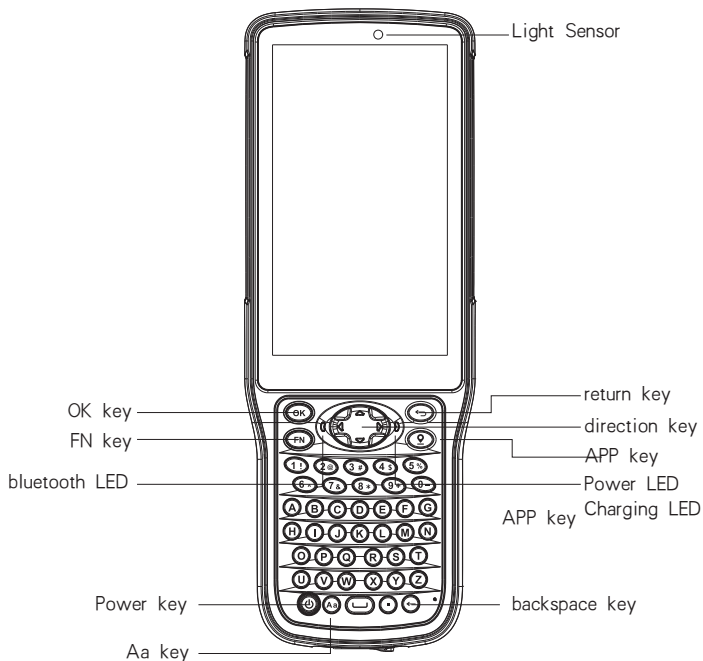

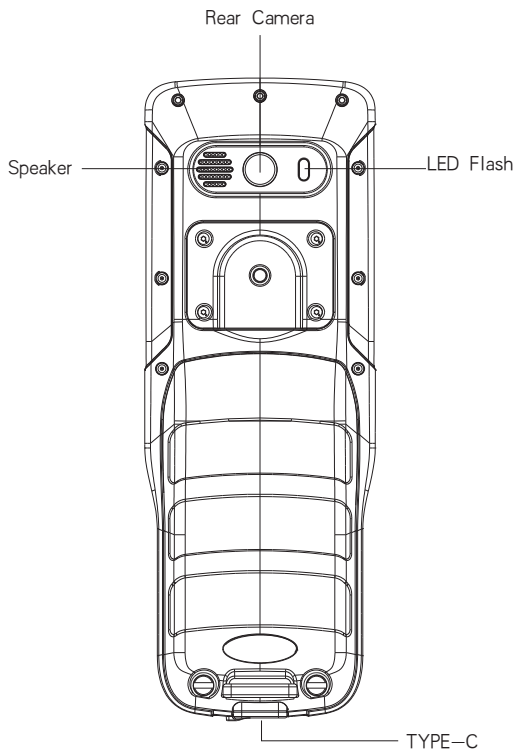

KEY DESCRIPTION

OK key: Function confirmation key

Fn Key: fn Is To Switch The Character Next To The Number, Fn Long Press
Fn Coordinates The Direction Up And Down Key To Carry On The Volume Adjustment

Bluetooth Led: the Data Transmission Is Always On, And The Bluetooth Light Will Be On When The Bluetooth Configuration Is Successful

Power Key: long Press The Power Button To Display Shutdown, Flight Mode, Restart And Screen Capture

Aa Key :case Switch, Press, The System Has A Top Icon, This Time The Input Is Uppercase

Return Key: back Up One Level

Direction Key: up, Down, Left And Right

App Key: program Associated Shortcuts

Power Led/charging Led: when Battery Capacity Is On, > 70% Green Light Is Always On And 20%-70% Green Light Flashes. Less Than 20% Of The Red Light Is Always On, Shutdown Charging State, Charging Red Light Is Always On, Full Green Light Is Always On

Backspace Key: delete Key

2、 battery charge

Use the travel charger

Insert the small end plug of the USB cable into the host TYPE-C connector, insert the big end plug of the USB cable into the travel charging plug, and then plug the travel charging plug into the power socket for charging.

Charging with a USB cable

Plug the small end plug of the USB cable into the host TYPE-C connector and plug the big end plug into the computer's USB port for charging.

3、 Install SIM card, memory card, battery

Turn off the power of the main unit before installing or removing the SIM card, memory card, or battery.

Turn the main unit to the back and push the back cover to the open position as indicated in Figure 1. Remove the battery compartment cover and install the SIM card and TF card according to the battery compartment label, as shown in Figure 1.

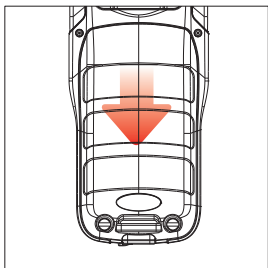

Figure 1

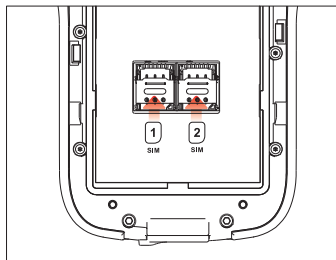

Figure 2

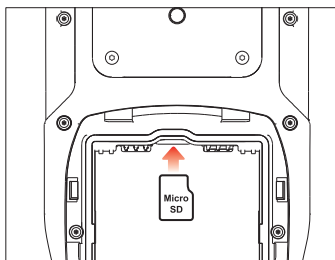

Figure 3

Push the SIM card metal contacts all the way down into the slot, paying attention to the chamfering direction. Figure 2

Push the metal contacts of the Micro SD memory card down into the slot, paying attention to the chamfering direction. Figure 3

Align the copper part of the battery with the copper contact end of the battery compartment and gently insert the battery.

After the battery is installed, install the battery compartment cover and push the rear cover to the locked position to lock the battery compartment cover.

4. Switching machine

To power on, firmly press the [Power Button] on the bottom right side until the boot screen appears. Screenshots and other options, select the shutdown option, then shut down.

In the power on state, click [Power button] to close the screen and enter the sleep mode; click [Power button] again to wake up the screen, and slide the screen up on the screen to unlock the screen; the host will automatically turn off the screen and enter the sleep mode after a period of inactivity.

5. Home screen operation

From the home screen, you can view device status and access applications. The main screen has multiple panels, and swipe left or right on the screen to view each panel.



At the top of the main screen is the status bar, which contains the notification area, status area, and display area; the bottom is the shortcut panel with the middle of the app icon . As shown in Figure 4.



Figure 4.

- Use the "app icon  "

"App icon  Include all apps inside. Tap the app icon " The application panel and widget panel pop up. Tap the [Home button] at the bottom of the screen to close it and return to the home screen.

Notice

1. Some special places, such as airports, hospitals, gas stations and other places, do not allow the use of electronic equipment. Please comply with the rules and do not use this product in these places.
2. For your safety and the safety of others, please do not use this product while driving a vehicle.
3. In order to avoid potential safety problems, do not put this product near the vehicle's airbag.
4. For your safety, please do not use this product during thunderstorms.
5. Although this product is waterproof, do not leave this product for long periods of time in areas with water or moisture.
6. This product has an operating temperature range of $-20^{\circ}\text{C}\sim+45^{\circ}\text{C}$ and a storage temperature range of $-40^{\circ}\text{C}\sim+70^{\circ}\text{C}$. Extreme temperatures can affect the device's performance and service life.
7. Please use an original rechargeable lithium battery. Low-quality batteries will affect the performance and service life of the device, and may even have the danger of explosion.
8. Although the product has been tested to withstand harsh operating environments, do use the product in an improper manner.
9. Please do not disassemble this product. In case of failure, please send to our authorized service centres to proceed with repairs.
10. After the device has reached the end of its service life, please discard in a proper way to avoid environmental pollution.
11. When replacing the battery or during the use of an external power supply, shut down the device completely before removing the battery or disconnecting the external power supply to prevent damage.
12. This product is a Class B product, which may cause radio interference. The user may be required to take necessary preventive measures.
13. Only use AC adaptor with 3-pin and 2-pin detachable pin for Singapore.
14. This device is restricted to indoor use where operated in frequency 5150MHz ~ 5250MHz to reduce the potential for interference.

Battery Instructions

1. This product uses a rechargeable lithium battery as a power source. When the power is low, please charge the battery. To maintain battery life, it is recommended to deplete the battery's power before charging.
2. When the battery charger is not in use, please remove it from the power supply. Do not connect the charger to the battery for more than one week. Excessive charging will shorten the battery life.
3. Temperature affects the battery charging limit. Therefore, the battery may need to be cooled or warmed up before charging.
4. Please use the battery for its original intended purpose to prevent short-circuiting the battery. A short circuit will occur when a conductive material connects the battery's positive and negative terminals.
5. Do not use a battery that is damaged.
6. Placing the battery in extremely cold or hot places will lead to shortened battery life. Exposing the battery to extreme temperatures may cause the phone to malfunction, even if the battery is fully charged.
7. Do not put the battery in a fire. Please discard the battery in a proper manner or take the battery to a battery recycling station. Please dispose waste batteries in accordance with local laws and regulations.

Imported by STONEX SRL - Part of UniStrong

Viale dell'Industria 53 20037 - Paderno Dugnano(MI) - Italy; Phone: +39 02 78619201

Manufacturer : Shenzhen UniStrong Science & Technology Co.,Ltd.

B Zone, No.4-4 Workshop Zhengcheng 2nd Road, Fuyong Street,Bao'an District, Shenzhen City, Guangdong Province, P.R. China

This equipment has been tested and found to comply with the limits for a Class B digital device, pursuant to part 15 of the FCC Rules. These limits are designed to provide reasonable protection against harmful interference in a residential installation. This equipment generates, uses and can radiate radio frequency energy and, if not installed and used in accordance with the instructions, may cause harmful interference to radio communications. However, there is no guarantee that interference will not occur in a particular installation. If this equipment does cause harmful interference to radio or television reception, which can be determined by turning the equipment off and on, the user is encouraged to try to correct the interference by one or more of the following measures:

- Reorient or relocate the receiving antenna.
- Increase the separation between the equipment and receiver.
- Connect the equipment into an outlet on a circuit different from that to which the receiver is connected.
- Consult the dealer or an experienced radio/TV technician for help.

Caution: Any changes or modifications to this device not explicitly approved by manufacturer could void your authority to operate this equipment.

This device complies with part 15 of the FCC Rules. Operation is subject to the following two conditions: (1) This device may not cause harmful interference, and (2) this device must accept any interference received, including interference that may cause undesired operation.

The device has been evaluated to meet general RF exposure requirement. The device can be used in portable exposure condition without restriction.

NOTICE:

The SAR limit of FCC and ISED is 1.6 W/kg averaged over one gram of tissue. Device types SH5A (FCC ID:Y44-SH5A and IC: 9932A-SH5A) has also been tested against this SAR limit. The highest SAR value reported under this standard during product certification for use on the body is 1.482 W/kg. This device was tested for typical body -worn operations with the back of the handset kept 0 cm from the body. To maintain compliance with FCC and ISED RF exposure requirements, use accessories that maintain a 0 cm separation distance between the user's body and the back of the handset. The use of belt clips, holsters and similar accessories should not contain metallic components in its assembly. The use of accessories that do not satisfy these requirements may not comply with FCC and ISED RF exposure requirements, and should be avoided.

<http://www.stonex.it>