

# TEST REPORT

Report No.: SHE20080008-02GE

Date: 2020-09-03

Page 1 of 71

**Applicant** : STONEX SRL  
**Address of Applicant** : Via Zucchi 1, Monza(MB) 20900, Italy

**Product Name** : Handheld data collection terminal  
**Model No.** : SH5A  
**Sample No.** : E20080008-01#01;  
E20080008-01#02  
**FCC ID** : Y44-SH5A  
**ISED Number** : 9932A-SH5A

**Standards** : FCC CFR47 Part 15, Subpart C  
RSS-Gen (Issue 5, March 2019)  
RSS-247 (Issue 2, February 2017)

**Date of Receipt** : 2020-08-05  
**Date of Test** : 2020-08-22 ~ 2020-09-02  
**Date of Issue** : 2020-09-03

**Remark:**

*This report details the results of the testing carried out on one sample, the results contained in this report do not relate to other samples of the same product. The manufacturer should ensure that all products in series production are in conformity with the product sample detailed in this report.*

Prepared by:

Jennifer Zhou  
(Jennifer Zhou)

Reviewed by:

Oliver Xiang  
(Oliver Xiang)

Approved by:

Guoyou Chi  
(Authorized signatory: Guoyou Chi)

# TEST REPORT

Report No.: SHE20080008-02GE

Date: 2020-09-03

Page 2 of 71

## Revision Record

Version	Date	Revisions	Revised By
1.0	2019-10-31	Original	--

# TEST REPORT

Report No.: SHE20080008-02GE

Date: 2020-09-03

Page 3 of 71

## Contents

<b>1</b>	<b>GENERAL INFORMATION</b>	<b>4</b>
1.1	TESTING LABORATORY	4
1.2	DETAILS OF APPLICATION	4
1.3	DETAILS OF EUT	4
1.4	TEST METHODOLOGY	4
<b>2</b>	<b>TEST CONDITION</b>	<b>6</b>
2.1	TEST FACILITY	6
2.2	ENVIRONMENTAL CONDITIONS	6
2.3	EQUIPMENT LIST	6
2.4	MEASUREMENT UNCERTAINTY	6
<b>3</b>	<b>TEST SET-UP AND OPERATION MODES</b>	<b>7</b>
3.1	DETAILS OF TEST MODE	7
3.2	SPECIAL ACCESSORIES AND AUXILIARY EQUIPMENT	8
3.3	SUPPORT SOFTWARE	8
3.4	TEST SETUP DIAGRAM	9
<b>4</b>	<b>TEST RESULTS</b>	<b>11</b>
4.1	TRANSMITTER REQUIREMENT & TEST SUITES	11
4.1.1	<i>Antenna Requirement</i>	11
4.1.2	<i>Peak Output Power and E.I.R.P</i>	12
4.1.3	<i>6dB Bandwidth and 99% Bandwidth</i>	16
4.1.4	<i>Power Spectral Density</i>	30
4.1.5	<i>Conducted Spurious Emission &amp; Authorized-band band-edge</i>	37
4.1.6	<i>Spurious Emission</i>	64
4.1.7	<i>Band Edge (Restricted-band band-edge)</i>	65
4.2	MAINS EMISSIONS	66
4.2.1	<i>Conducted Emission on AC Mains</i>	66
<b>5</b>	<b>APPENDIXES</b>	<b>69</b>
5.1	PHOTOGRAPHS OF THE SAMPLE	69
5.2	SET-UP FOR CONDUCTED EMISSIONS	70
5.3	SET-UP FOR CONDUCTED RF TEST AT ANTENNA PORT	70
5.4	SET-UP FOR SPURIOUS EMISSIONS BELOW 1GHZ	71
5.5	SET-UP FOR SPURIOUS EMISSIONS ABOVE 1GHZ	71

# TEST REPORT

Report No.: SHE20080008-02GE

Date: 2020-09-03

Page 4 of 71

## 1 General Information

### 1.1 Testing Laboratory

Company Name	ICAS Testing Technology Service (Shanghai) Co., Ltd.
Address	No.1298 Pingan Rd, Minhang District, Shanghai, China
Telephone	0086 21-51682999
Fax	0086 21-54711112
Homepage	www.icasiso.com

### 1.2 Details of Application

Company Name	STONEX SRL
Address	Via Zucchi 1, Monza(MB) 20900, italy
Contact Person	Ivana Bucci
Telephone	+390278619201
Email	Ivana.Bucci@stonex.it

### 1.3 Details of EUT

Product Name	Handheld data collection terminal
Brand Name	Stonex
Model No.	SH5A
FCC ID	Y44-SH5A
ISED Number	9932A-SH5A
Mode of Operation	WLAN 802.11b/g/n(HT20/40)
Frequency Range	2400MHz ~ 2483.5MHz
Channel Separation	5 MHz
Modulation Type	DSSS, OFDM
Antenna Type	Internal Antenna
Antenna Gain	2.80 dBi
Extreme Temperature Range	-20°C ~ +55°C
Test Voltage	DC 3.8V

### 1.4 Test Methodology

47 CFR Part 15, Subpart C (10-1-16 Edition)	Miscellaneous Wireless Communications Services
KDB Publication 558074 D01 v05r02	15.247 Meas Guidance.
KDB Publication 662911 D01 v02r01	Emissions Testing of Transmitters with Multiple Outputs in the Same Band (e.g., MIMO, Smart Antenna, etc)
RSS-Gen	General Requirements for Compliance of Radio Apparatus

# TEST REPORT

Report No.: SHE20080008-02GE

Date: 2020-09-03

Page 5 of 71

(Issue 5, March 2019)	
RSS-247 (Issue 2, February 2017)	Digital Transmission Systems (DTs), Frequency Hopping Systems (FHSs) and Licence-Exempt Local Area Network (LE-LAN) Devices
ANSI C63.10-2013	American National Standard for Testing Unlicensed Wireless Devices

**Note(s):**

All test items were verified and recorded according to the standards and without any addition/deviation/exclusion during the test.

# TEST REPORT

Report No.: SHE20080008-02GE

Date: 2020-09-03

Page 6 of 71

## 2 Test Condition

### 2.1 Test Facility

### 2.2 Environmental conditions

Temperature (°C)	18-25
Humidity (%RH)	40-65
Barometric Pressure (mbar)	960-1060

### 2.3 Equipment List

Name of Equipment	Manufacturer	Model	Serial No.	Cal. Due Date
Spectrum Analyzer	Keysight	N9020B	MY59260184	2021-08-18
Spectrum Analyzer	Rohde & Schwarz	FSV40N	101450	2021-06-08
EMI Test Receiver	Rohde & Schwarz	ESPI3	100173	2021-06-08
EMI Test Receiver	Rohde & Schwarz	ESR 7	101911	2021-06-08
V-network	SCHWARZBECK	NSLK 8127	8127-902	2021-02-20
Wideband Radio Communication Tester	Rohde & Schwarz	CMW 500	100687	2021-08-18
Broadband Antenna	SCHWARZBECK	VULB9163	9163-1037	2021-06-08
Horn Antenna-18G	SCHWARZBECK	BBHA9120D	9120D-1775	2021-06-08
Loop Antenna	SCHWARZBECK	FMZB 1513	N/A	2021-03-19
Horn Antenna-40G	YINGLIAN	LB-180400-KF	N/A	2021-07-26
EMC chamber 9*6*6 (L*W*H)	CHANGNING	966	N/A	2021-06-08
Shielded Enclosure 8*5*4 (L*W*H)	CHANGNING	854	N/A	2021-06-08
Test Software	BL	BL410_E	N/A	N/A

### 2.4 Measurement Uncertainty

Parameter	Frequency	Uncertainty
Antenna Port Conducted Emission	< 1GHz	± 1.5 dB
	> 1GHz	± 1.5 dB
Radiated Emission	30 MHz – 1 GHz	± 3 dB
	> 1GHz	± 3 dB

# TEST REPORT

Report No.: SHE20080008-02GE

Date: 2020-09-03

Page 7 of 71

## 3 Test Set-up and Operation Modes

### 3.1 Details of Test Mode

Using test software was control EUT work in continuous transmitter and receiver mode. Select test channel as below:

For 802.11b/g/n (HT20)

Channel	Frequency
The lowest channel(CH1)	2412MHz
The middle channel(CH6)	2437MHz
The Highest channel(CH11)	2462MHz

For 802.11n(HT40)

Channel	Frequency
The lowest channel(CH3)	2422MHz
The middle channel(CH6)	2437MHz
The Highest channel(CH9)	2452MHz

Through Pre-scan under all rate at lowest channel, the data rate as below table described is the worst case, so we choose these data rate for test.

Type	Data rate
802.11b	5.5Mbps
802.11g	48Mbps
802.11n(20M)	MCS7
802.11n(40M)	MCS3

The basic operation modes are:

- A. On
  - 1. WLAN mode
    - a. Transmitting
      - i. Low Channel
      - ii. Middle Channel
      - iii. High Channel
    - b. Receiving
- B. Standby
- C. Off

# TEST REPORT

Report No.: SHE20080008-02GE

Date: 2020-09-03

Page 8 of 71

## 3.2 Special Accessories and Auxiliary Equipment

Description	Manufacturer	Model No.	Serial No.
Laptop	Lenovo	TP00083A	N/A

## 3.3 Support Software

Description	Manufacturer	Software Name
Software	UniStrong	mtk



# TEST REPORT

Report No.: SHE20080008-02GE

Date: 2020-09-03

Page 9 of 71

## 3.4 Test Setup Diagram

Diagram of Measurement Configuration for Radiation Test

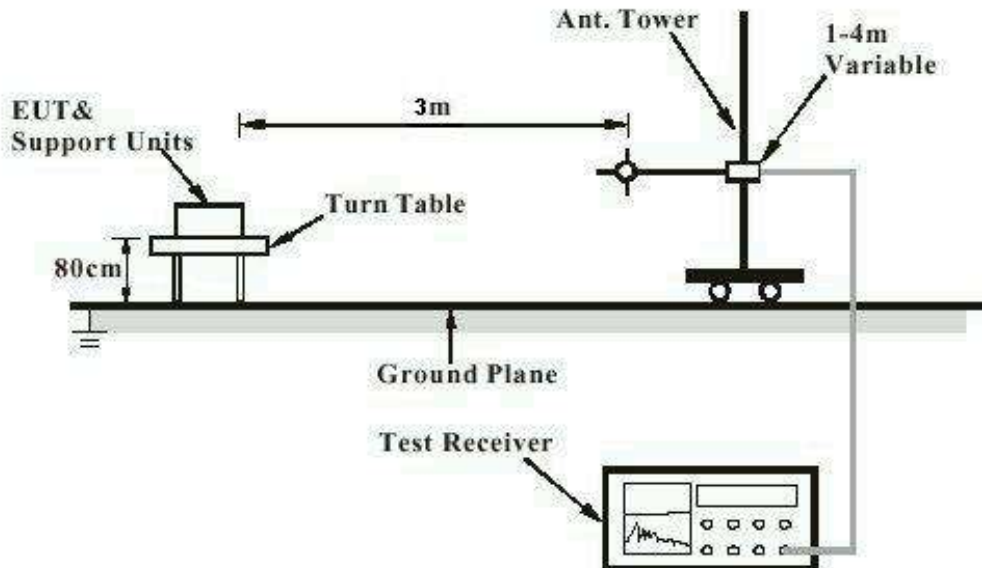

Note: Measurements above 1GHz are done with a table height of 1.5m. In addition, there is RF absorbing material on the floor of the test site for above 1GHz measurement.

Diagram of Measurement Equipment Configuration for Conduction Measurement

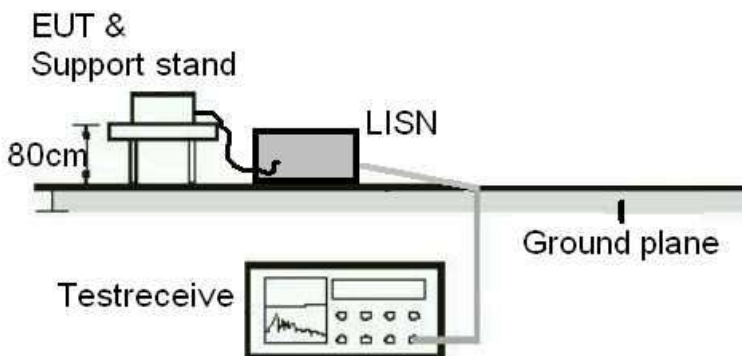

# TEST REPORT

Report No.: SHE20080008-02GE

Date: 2020-09-03

Page 10 of 71

## Diagram of Measurement Equipment Configuration for Transmitter Measurement

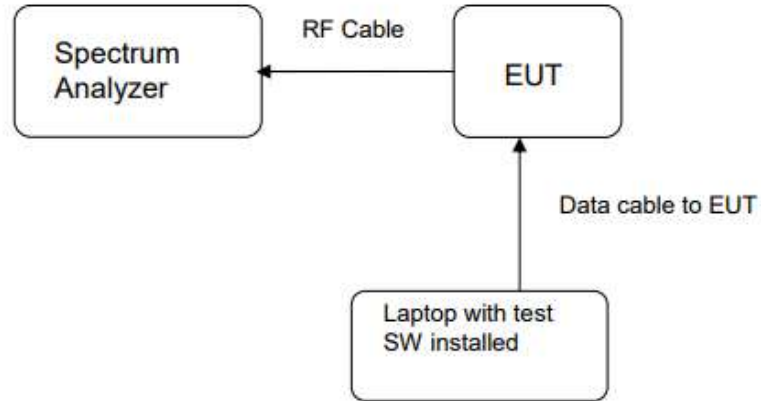

# TEST REPORT

Report No.: SHE20080008-02GE

Date: 2020-09-03

Page 11 of 71

## 4 Test Results

### 4.1 Transmitter Requirement & Test Suites

#### 4.1.1 Antenna Requirement

**RESULT:** **PASS**

Test standard : FCC Part 15.247(b)(4), Part 15.203  
RSS-247 5.4(6)

Requirement : The use of approved antennas only with directional gains that do not exceed 6 dBi

According to the manufacturer declaration, the EUT has an antenna with a directional gain of 2.80 dBi. The antenna is an internal antenna with no possibility of replacement with a non-approved antenna by the end-user.

Therefore, the EUT is considered to comply with this provision.

# TEST REPORT

Report No.: SHE20080008-02GE

Date: 2020-09-03

Page 12 of 71

## 4.1.2 Peak Output Power and E.I.R.P

RESULT:

PASS

Test standard : FCC Part 15.247(b)(3)  
RSS-247 5.4(4)  
Requirement : ANSI C63.10-2013, KDB 558074  
Kind of test site : Shielded room

### Test setup

Test Channel : Low/Middle/High  
Operation Mode : A.1.a  
Ambient temperature : 25°C  
Relative humidity : 52%

Table 1: Peak Output Power

Test Mode	Test Channel (MHz)	Measured Peak Power		Limit (W)
		(dBm)	(mW)	
802.11b	2412	14.29	26.85	< 1
	2437	14.33	27.10	
	2462	14.25	26.61	
802.11g	2412	13.77	23.82	
	2437	14.03	25.29	
	2462	13.97	24.95	
802.11n(HT20)	2412	13.88	24.43	
	2437	13.96	24.89	
	2462	14.15	26.00	
802.11n(HT40)	2422	13.98	25.00	
	2437	13.84	24.21	
	2452	14.15	26.00	

# TEST REPORT

Report No.: SHE20080008-02GE

Date: 2020-09-03

Page 13 of 71

Table 2: E.I.R.P

Test Mode	Test Channel (MHz)	Measured Peak Power		Limit (W)
		(dBm)	(mW)	
802.11b	2412	17.09	51.17	< 4
	2437	17.13	51.64	
	2462	17.05	50.70	
802.11g	2412	16.57	45.39	
	2437	16.83	48.19	
	2462	16.77	47.53	
802.11n(HT20)	2412	16.68	46.56	
	2437	16.76	47.42	
	2462	16.95	49.55	
802.11n(HT40)	2422	16.78	47.64	
	2437	16.64	46.13	
	2452	16.95	49.55	

Duty cycle factor =  $10 \cdot \log(1/\text{duty cycle})$

802.11b > 98%

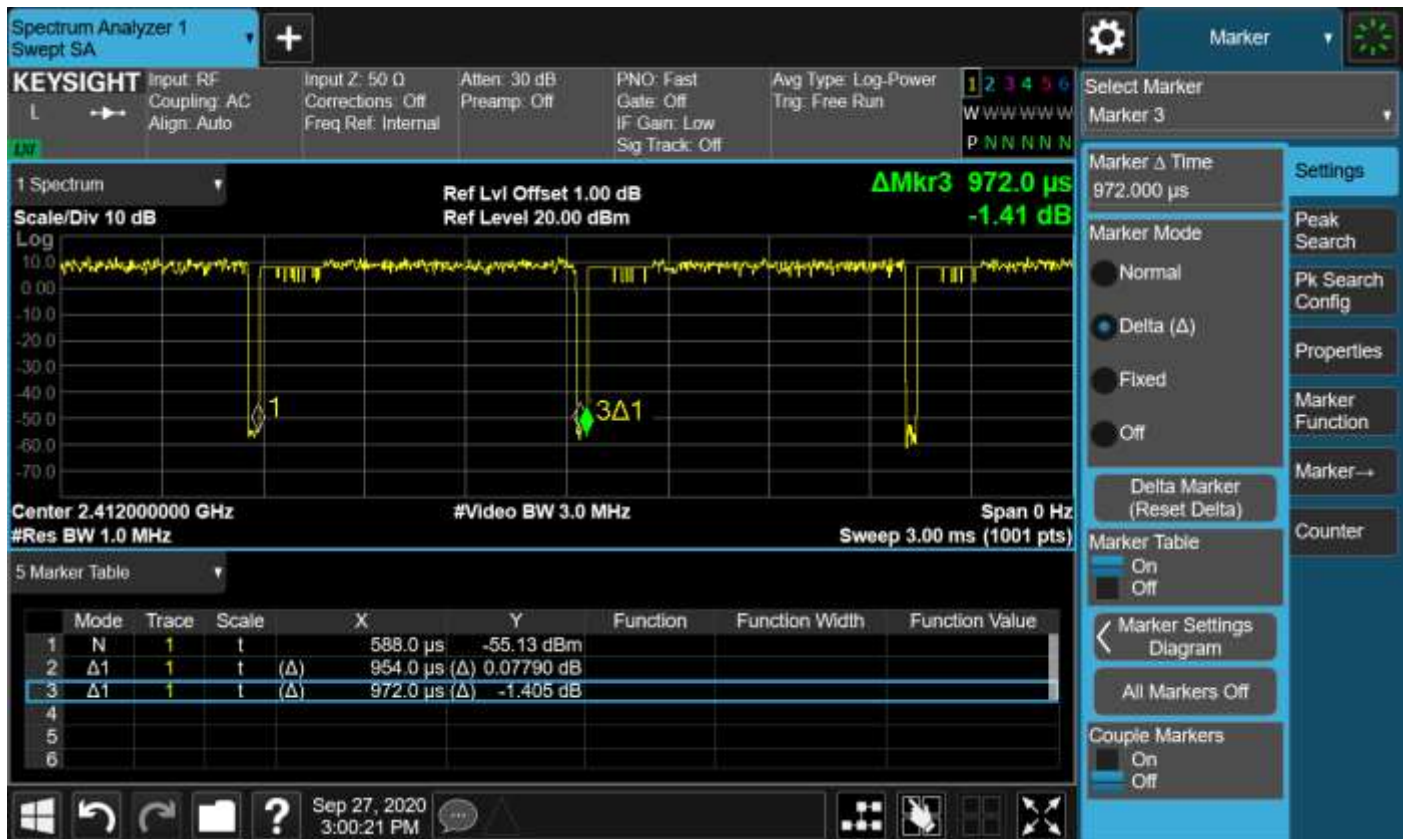

# TEST REPORT

Report No.: SHE20080008-02GE

Date: 2020-09-03

Page 14 of 71

802.11g >98%

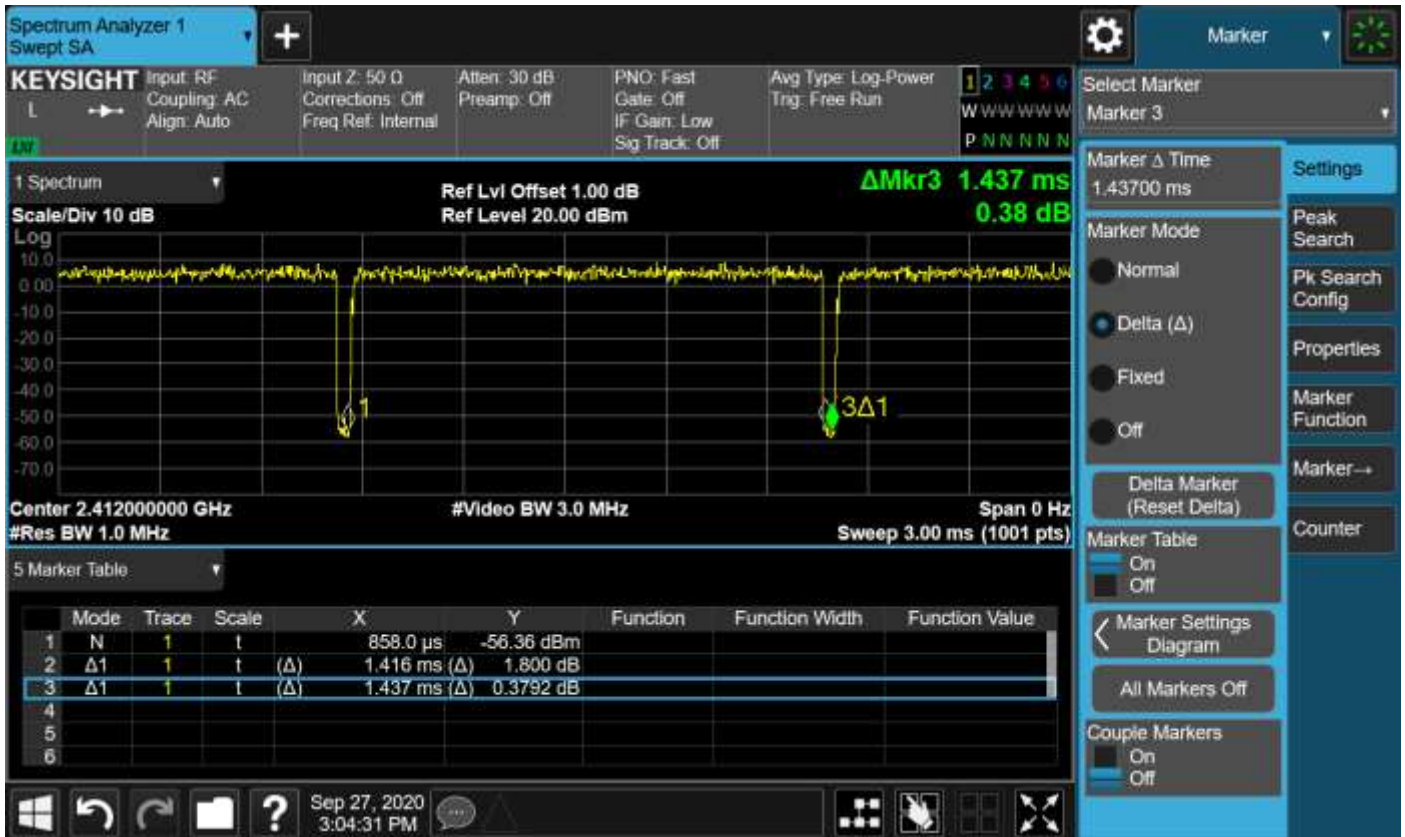

802.11n20>98%

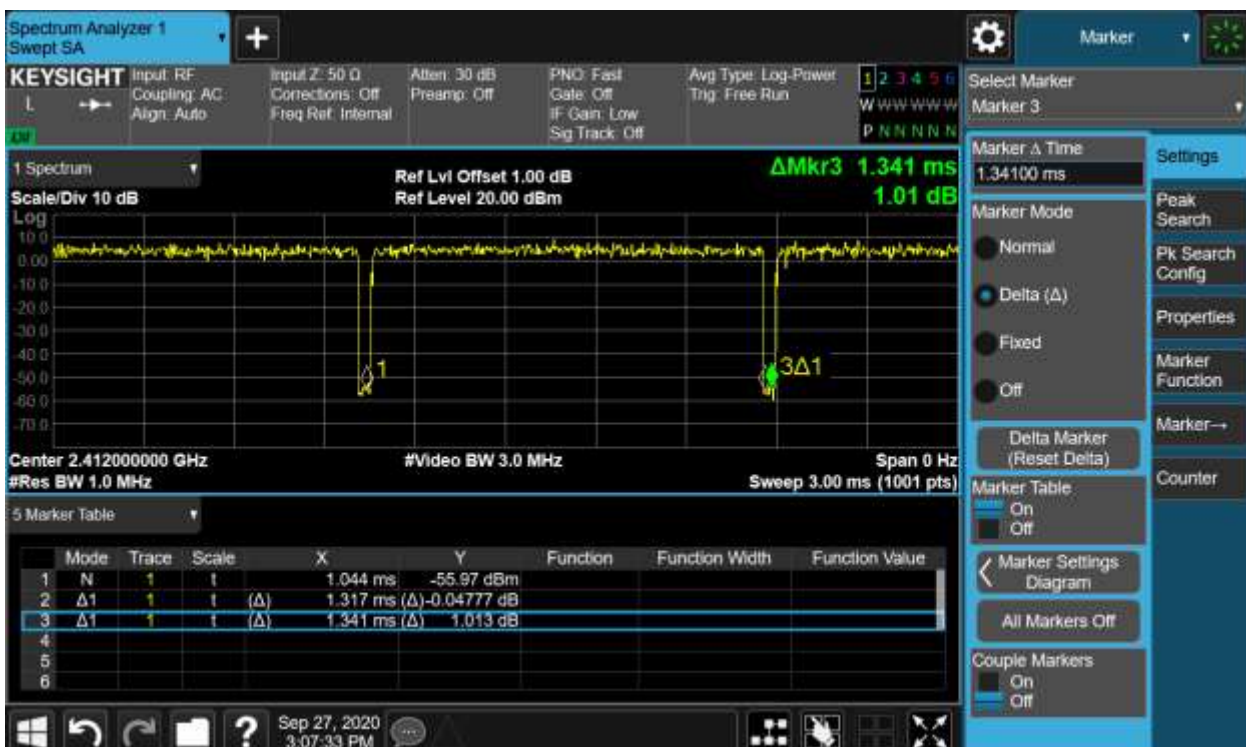

# TEST REPORT

Report No.: SHE20080008-02GE

Date: 2020-09-03

Page 15 of 71

$$802.11n40=10*\log(1/(666/687))=0.14$$

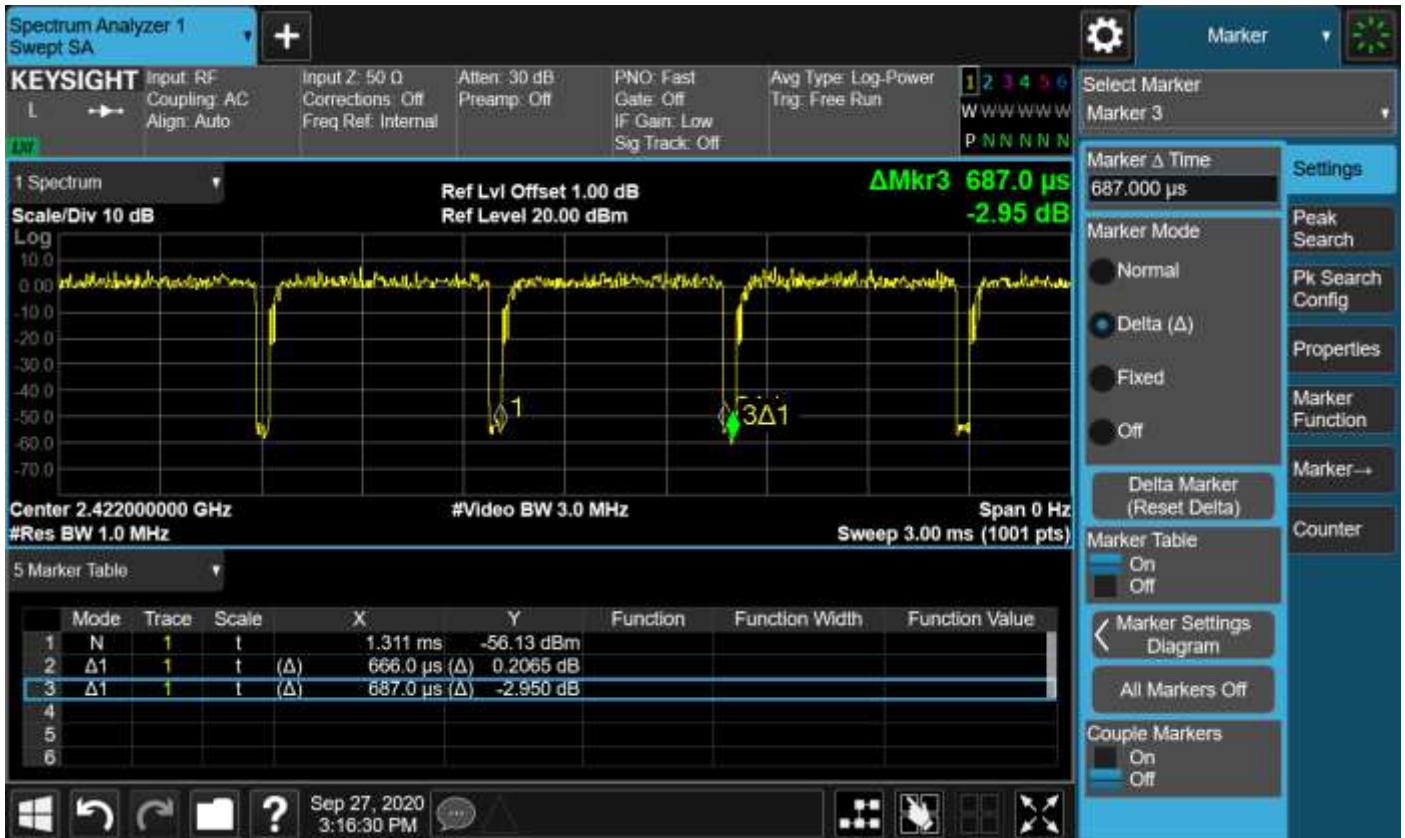

# TEST REPORT

Report No.: SHE20080008-02GE

Date: 2020-09-03

Page 16 of 71

## 4.1.3 6dB Bandwidth and 99% Bandwidth

RESULT:

**PASS**

Test standard : FCC Part 15.247(a)(2)  
 RSS-247 5.2(1)  
 RSS-Gen 6.6

Requirement : ANSI C63.10-2013, KDB 558074

Kind of test site : Shielded room

### Test setup

Test Channel : Low/Middle/High

Operation Mode : A.1.a

Ambient temperature : 25°C

Relative humidity : 52%

**Table 3: 6dB Bandwidth and 99% Bandwidth**

Test Mode	Test Channel (MHz)	6dB Bandwidth (MHz)	99% Bandwidth (MHz)	6 dB Bandwidth Limit (MHz)
802.11b	2412	8.510	12.570	0.5
	2437	8.110	12.782	
	2462	7.460	12.765	
802.11g	2412	15.820	16.699	
	2437	16.470	16.836	
	2462	15.820	16.831	
802.11n(HT20)	2412	16.320	17.835	
	2437	17.720	18.000	
	2462	14.970	17.922	
802.11n(HT40)	2422	35.170	35.455	
	2437	36.470	36.502	
	2452	35.770	35.512	



# TEST REPORT

Report No.: SHE20080008-02GE

Date: 2020-09-03

Page 17 of 71

Figure 1: 6dB Bandwidth and 99% Bandwidth, 802.11b, 2412MHz



# TEST REPORT

Report No.: SHE20080008-02GE

Date: 2020-09-03

Page 18 of 71

Figure 2: 6dB Bandwidth and 99% Bandwidth, 802.11b, 2437MHz



# TEST REPORT

Report No.: SHE20080008-02GE

Date: 2020-09-03

Page 19 of 71



# TEST REPORT

Report No.: SHE20080008-02GE

Date: 2020-09-03

Page 20 of 71

Figure 3: 6dB Bandwidth and 99% Bandwidth, 802.11b, 2462MHz



# TEST REPORT

Report No.: SHE20080008-02GE

Date: 2020-09-03

Page 21 of 71

Figure 4: 6dB Bandwidth and 99% Bandwidth, 802.11g, 2412MHz



# TEST REPORT

Report No.: SHE20080008-02GE

Date: 2020-09-03

Page 22 of 71

Figure 5: 6dB Bandwidth and 99% Bandwidth, 802.11g, 2437MHz



# TEST REPORT

Report No.: SHE20080008-02GE

Date: 2020-09-03

Page 23 of 71

Figure 6: 6dB Bandwidth and 99% Bandwidth, 802.11g, 2462MHz



# TEST REPORT

Report No.: SHE20080008-02GE

Date: 2020-09-03

Page 24 of 71

Figure 7: 6dB Bandwidth and 99% Bandwidth, 802.11n(HT20), 2412MHz





# TEST REPORT

Report No.: SHE20080008-02GE

Date: 2020-09-03

Page 25 of 71

Figure 8: 6dB Bandwidth and 99% Bandwidth, 802.11n(HT20), 2437MHz



# TEST REPORT

Report No.: SHE20080008-02GE

Date: 2020-09-03

Page 26 of 71

Figure 9: 6dB Bandwidth and 99% Bandwidth, 802.11n(HT20), 2462MHz



# TEST REPORT

Report No.: SHE20080008-02GE

Date: 2020-09-03

Page 27 of 71

Figure 10: 6dB Bandwidth and 99% Bandwidth, 802.11n(HT40), 2422MHz



# TEST REPORT

Report No.: SHE20080008-02GE

Date: 2020-09-03

Page 28 of 71

Figure 11: 6dB Bandwidth and 99% Bandwidth, 802.11n(HT40), 2437MHz



# TEST REPORT

Report No.: SHE20080008-02GE

Date: 2020-09-03

Page 29 of 71

Figure 12: 6dB Bandwidth and 99% Bandwidth, 802.11n(HT40), 2452MHz



# TEST REPORT

Report No.: SHE20080008-02GE

Date: 2020-09-03

Page 30 of 71

## 4.1.4 Power Spectral Density

### RESULT:

**PASS**

Test standard : FCC Part 15.247(e)  
RSS-247 5.2(2)  
Requirement : ANSI C63.10-2013, KDB 558074  
Kind of test site : Shielded room

### Test setup

Test Channel : Low/Middle/High  
Operation Mode : A.1.a  
Ambient temperature : 25°C  
Relative humidity : 52%

**Table 4: Power Spectral Density**

Test Mode	Test Channel (MHz)	Measured Result (dBm/3kHz)	Limit (dBm/3kHz)
802.11b	2412	-10.01	8
	2437	-10.34	
	2462	-9.82	
802.11g	2412	-12.22	
	2437	-12.18	
	2462	-12.17	
802.11n(HT20)	2412	-12.43	
	2437	-12.02	
	2462	-12.25	
802.11n(HT40)	2422	-12.90	
	2437	-14.81	
	2452	-11.54	

# TEST REPORT

Report No.: SHE20080008-02GE

Date: 2020-09-03

Page 31 of 71

Figure 13: Power Spectral Density, 802.11b, 2412MHz



Figure 14: Power Spectral Density, 802.11b, 2437MHz



# TEST REPORT

Report No.: SHE20080008-02GE

Date: 2020-09-03

Page 32 of 71

Figure 15: Power Spectral Density, 802.11b, 2462MHz



Figure 16: Power Spectral Density, 802.11g, 2412MHz

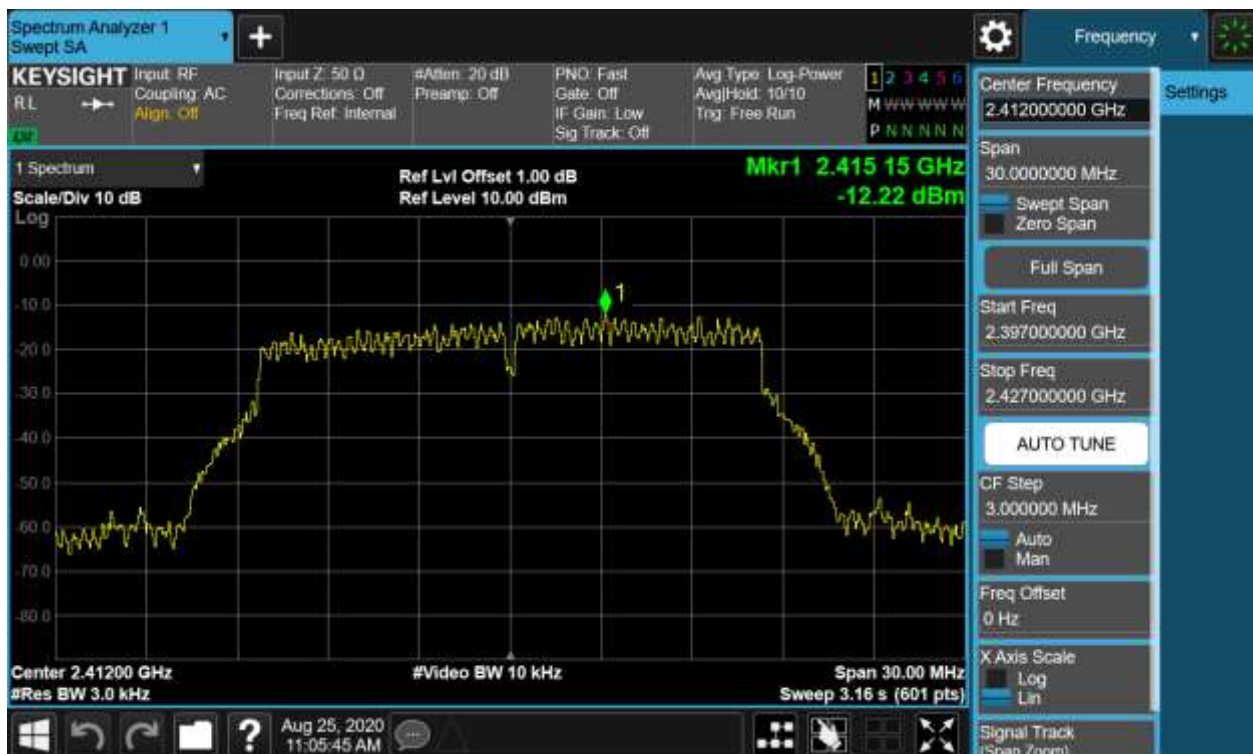



# TEST REPORT

Report No.: SHE20080008-02GE

Date: 2020-09-03

Page 33 of 71

Figure 17: Power Spectral Density, 802.11g, 2437MHz



Figure 18: Power Spectral Density, 802.11g, 2462MHz

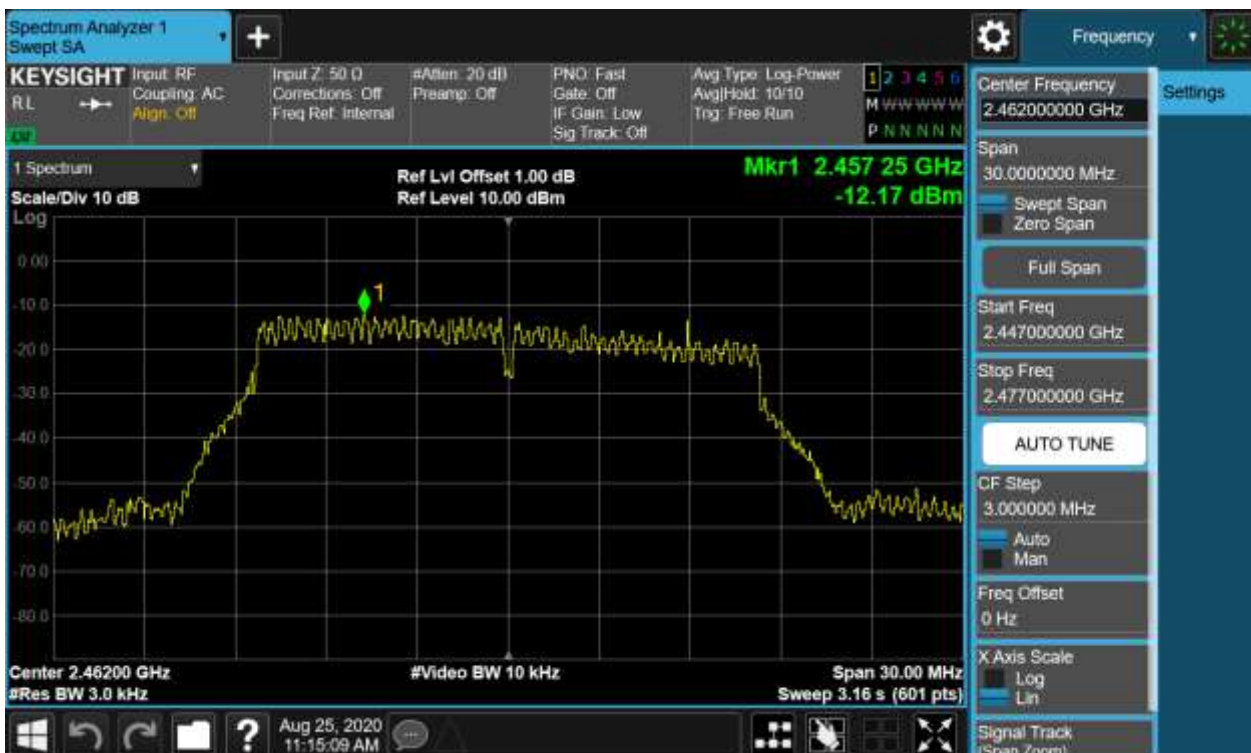

# TEST REPORT

Report No.: SHE20080008-02GE

Date: 2020-09-03

Page 34 of 71

Figure 19: Power Spectral Density, 802.11n(HT20), 2412MHz

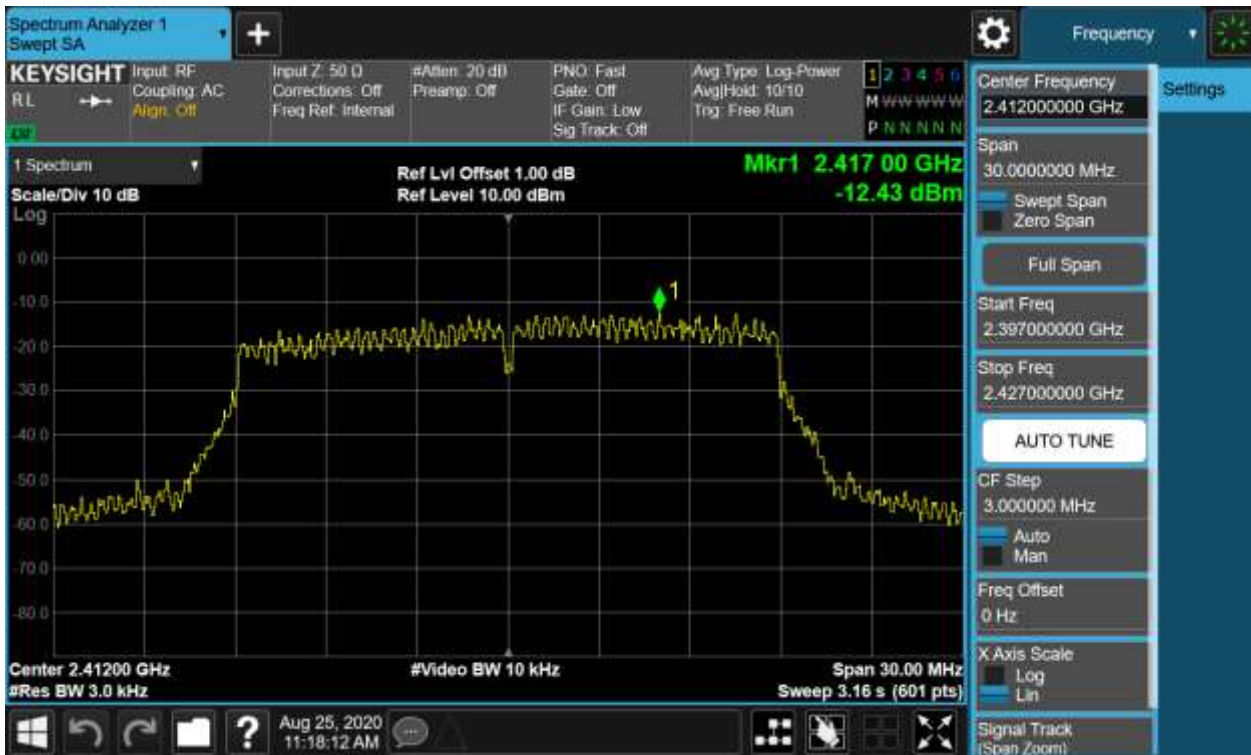

Figure 20: Power Spectral Density, 802.11n(HT20), 2437MHz



# TEST REPORT

Report No.: SHE20080008-02GE

Date: 2020-09-03

Page 35 of 71

Figure 21: Power Spectral Density, 802.11n(HT20), 2462MHz



Figure 22: Power Spectral Density, 802.11n(HT40), 2422MHz



# TEST REPORT

Report No.: SHE20080008-02GE

Date: 2020-09-03

Page 36 of 71

Figure 23: Power Spectral Density, 802.11n(HT40), 2437MHz

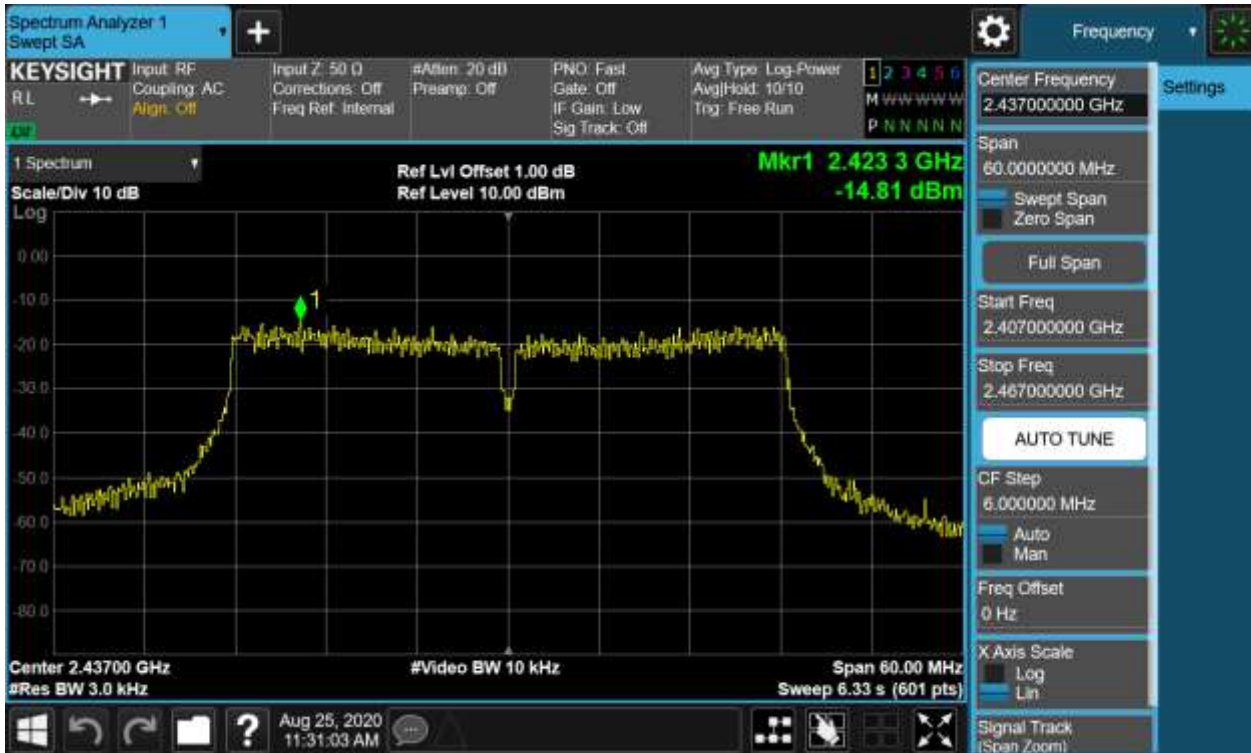
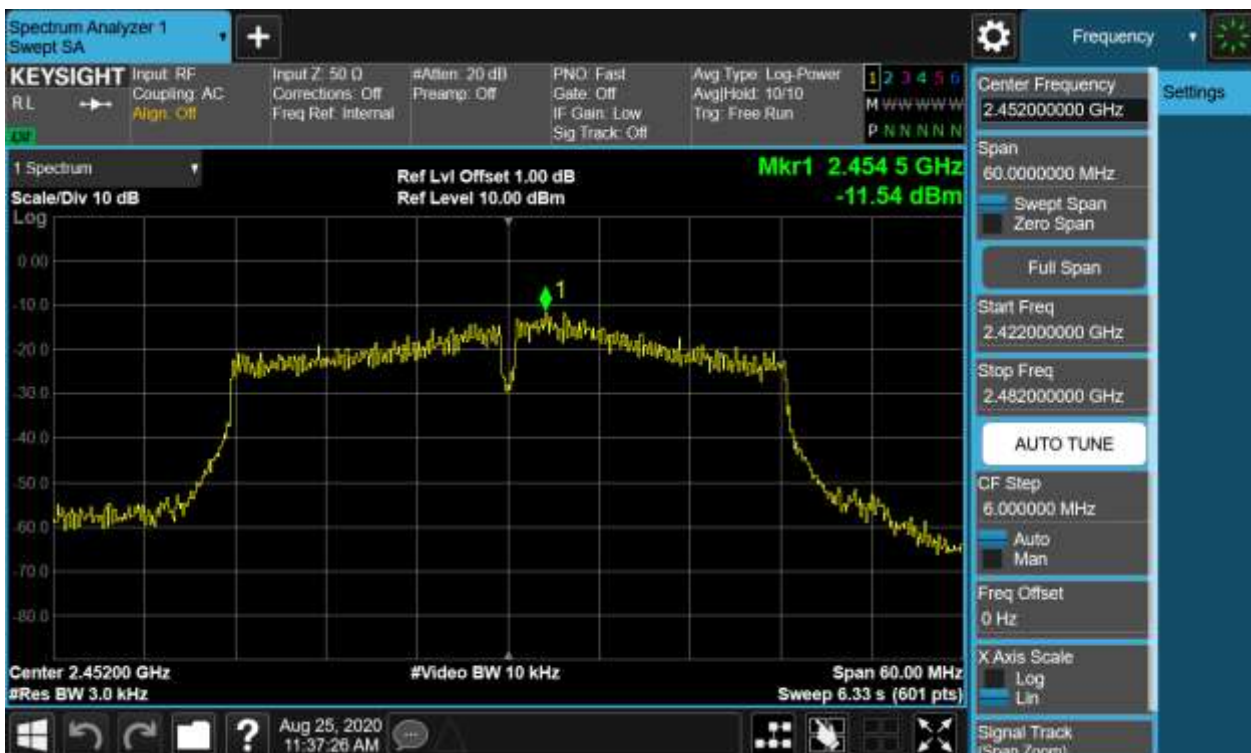

Figure 24: Power Spectral Density, 802.11n(HT40), 2452MHz



# TEST REPORT

Report No.: SHE20080008-02GE

Date: 2020-09-03

Page 37 of 71

## 4.1.5 Conducted Spurious Emission & Authorized-band band-edge

RESULT:

**PASS**

Test standard : FCC Part 15.247(d), 15.209  
RSS-247 5.5  
RSS-Gen 8.9  
Requirement : ANSI C63.10-2013, KDB 558074  
Kind of test site : Shielded room

### Test setup

Test Channel : Low/Middle/High for spurious, Low/High for Band  
Edge  
Operation Mode : A.1.a  
Ambient temperature : 25°C  
Relative humidity : 52%

For details refer to following test plot.

# TEST REPORT

Report No.: SHE20080008-02GE

Date: 2020-09-03

Page 38 of 71

Figure 25: Conducted Spurious Emission & Authorized-band band-edge, 802.11b, 2412MHz Carrier Level



Band Edge

# TEST REPORT

Report No.: SHE20080008-02GE

Date: 2020-09-03

Page 39 of 71



## Conducted spurious emissions 30MHz-25GHz

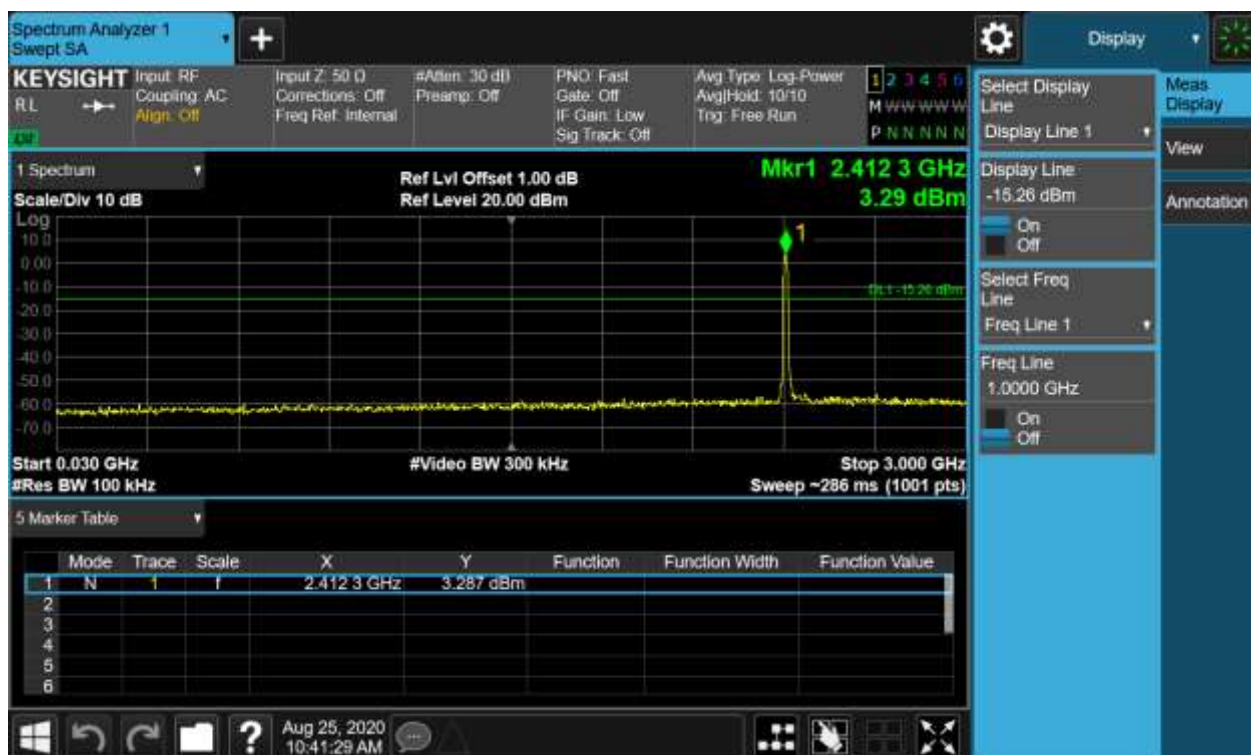

# TEST REPORT

Report No.: SHE20080008-02GE

Date: 2020-09-03

Page 40 of 71



Figure 26: Conducted Spurious Emission & Authorized-band band-edge, 802.11b, 2437MHz Carrier Level



# TEST REPORT

Report No.: SHE20080008-02GE

Date: 2020-09-03

Page 41 of 71



## Conducted spurious emissions 30MHz-25GHz



# TEST REPORT

Report No.: SHE20080008-02GE

Date: 2020-09-03

Page 42 of 71



Figure 27: Conducted Spurious Emission & Authorized-band band-edge, 802.11b, 2462MHz Carrier Level



# TEST REPORT

Report No.: SHE20080008-02GE

Date: 2020-09-03

Page 43 of 71

## Band Edge



## Conducted spurious emissions 30MHz-25GHz

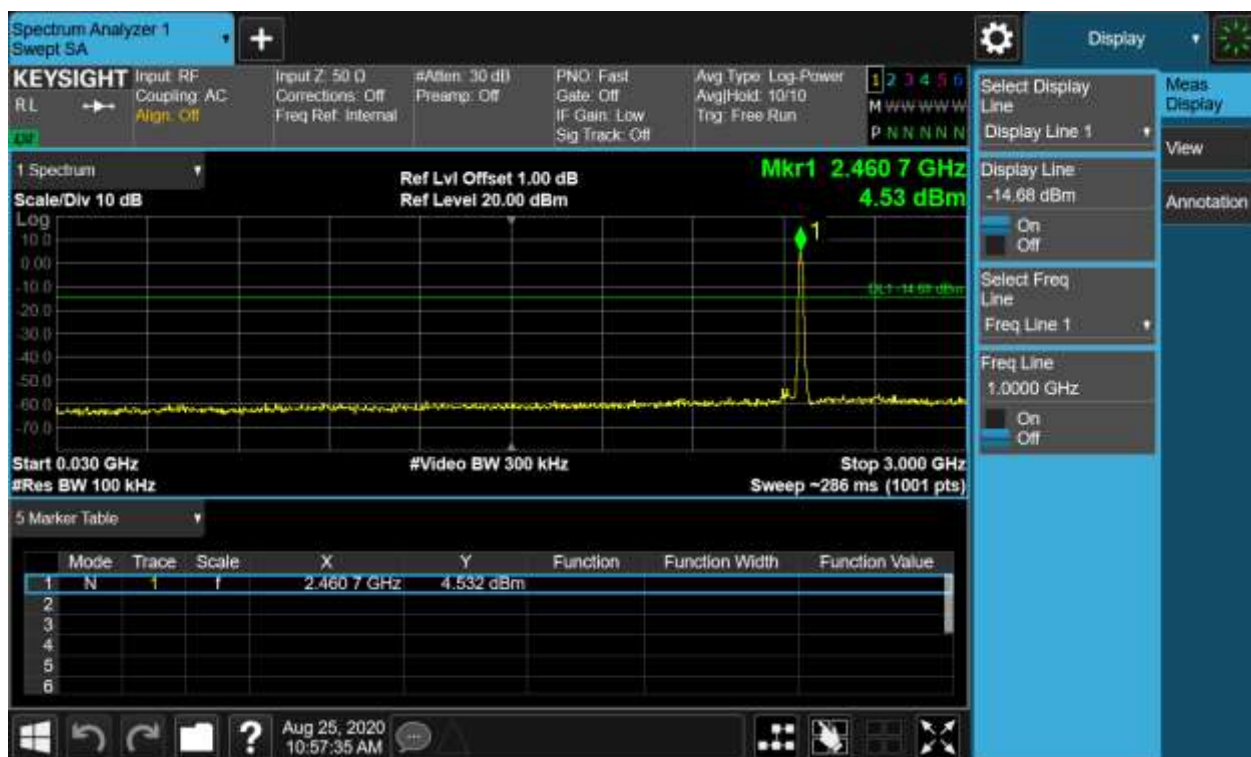

# TEST REPORT

Report No.: SHE20080008-02GE

Date: 2020-09-03

Page 44 of 71



Figure 28: Conducted Spurious Emission & Authorized-band band-edge, 802.11g, 2412MHz Carrier Level



# TEST REPORT

Report No.: SHE20080008-02GE

Date: 2020-09-03

Page 45 of 71

## Band Edge



Conducted spurious emissions 30MHz-25GHz

# TEST REPORT

Report No.: SHE20080008-02GE

Date: 2020-09-03

Page 46 of 71



Figure 29: Conducted Spurious Emission & Authorized-band band-edge, 802.11g, 2437MHz

# TEST REPORT

Report No.: SHE20080008-02GE

Date: 2020-09-03

Page 47 of 71

## Carrier Level



## Conducted spurious emissions 30MHz-25GHz



# TEST REPORT

Report No.: SHE20080008-02GE

Date: 2020-09-03

Page 48 of 71



Figure 30: Conducted Spurious Emission & Authorized-band band-edge, 802.11g, 2462MHz Carrier Level



# TEST REPORT

Report No.: SHE20080008-02GE

Date: 2020-09-03

Page 49 of 71



## Band Edge



Conducted spurious emissions 30MHz-25GHz

# TEST REPORT

Report No.: SHE20080008-02GE

Date: 2020-09-03

Page 50 of 71



# TEST REPORT

Report No.: SHE20080008-02GE

Date: 2020-09-03

Page 51 of 71

Figure 31: Conducted Spurious Emission & Authorized-band band-edge, 802.11n(HT20), 2412MHz Carrier Level



## Band Edge



# TEST REPORT

Report No.: SHE20080008-02GE

Date: 2020-09-03

Page 52 of 71

## Conducted spurious emissions 30MHz-25GHz



# TEST REPORT

Report No.: SHE20080008-02GE

Date: 2020-09-03

Page 53 of 71

Figure 32: Conducted Spurious Emission & Authorized-band band-edge, 802.11n(HT20), 2437MHz Carrier Level



Conducted spurious emissions 30MHz-25GHz

# TEST REPORT

Report No.: SHE20080008-02GE

Date: 2020-09-03

Page 54 of 71

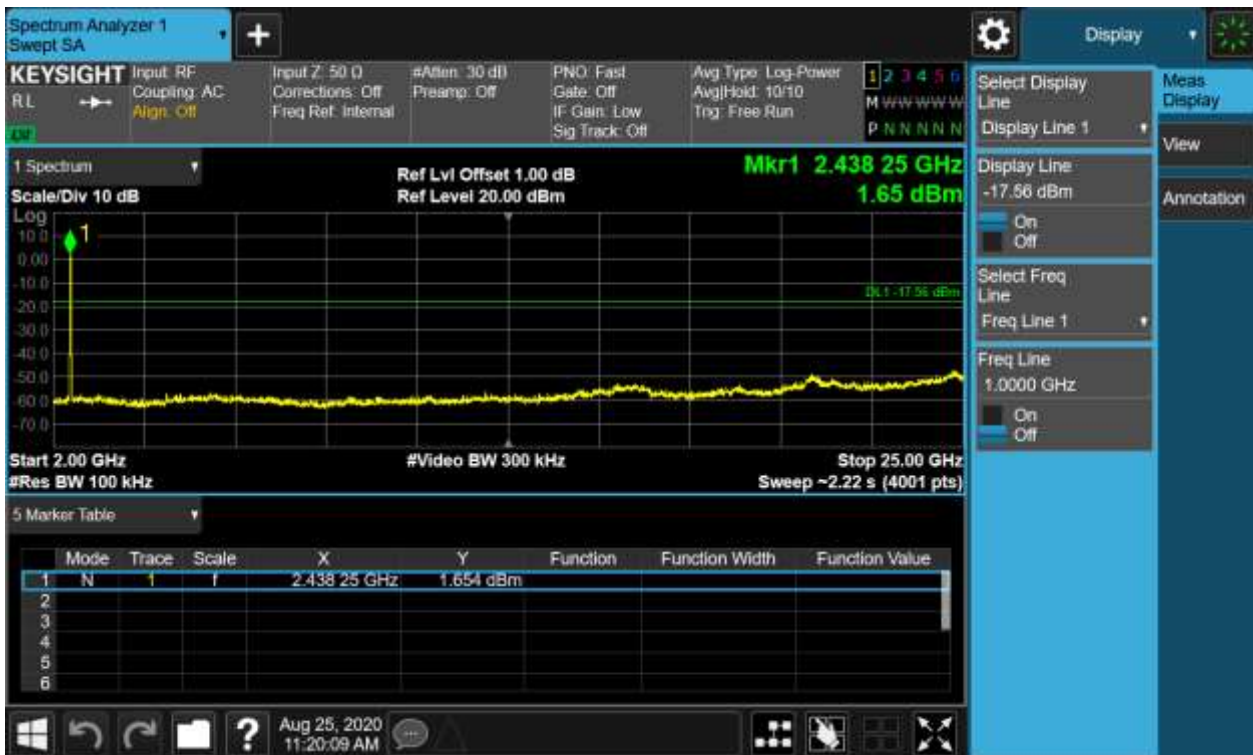
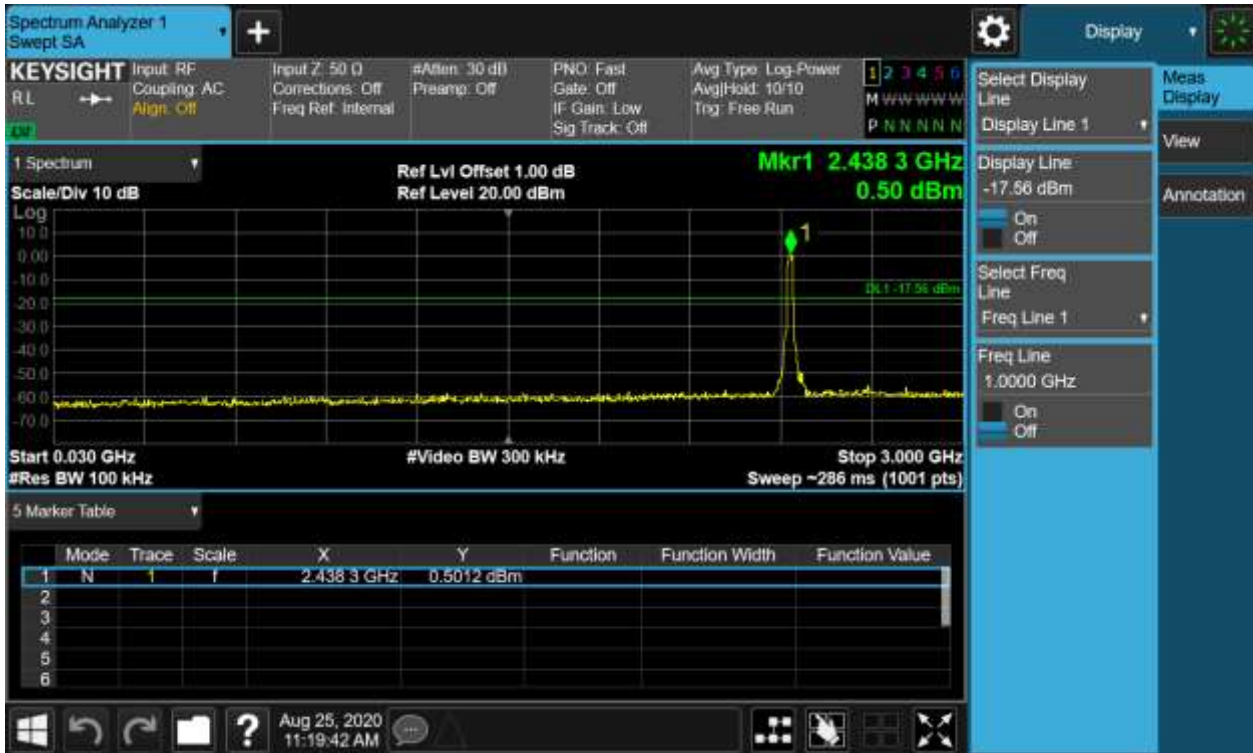

Figure 33: Conducted Spurious Emission & Authorized-band band-edge, 802.11n(HT20), 2462MHz Carrier Level

# TEST REPORT

Report No.: SHE20080008-02GE

Date: 2020-09-03

Page 55 of 71



# TEST REPORT

Report No.: SHE20080008-02GE

Date: 2020-09-03

Page 56 of 71

## Band Edge



## Conducted spurious emissions 30MHz-25GHz





# TEST REPORT

Report No.: SHE20080008-02GE

Date: 2020-09-03

Page 57 of 71



Figure 34: Conducted Spurious Emission & Authorized-band band-edge, 802.11n(HT40), 2422MHz Carrier Level



# TEST REPORT

Report No.: SHE20080008-02GE

Date: 2020-09-03

Page 58 of 71

## Band Edge



## Conducted spurious emissions 30MHz-25GHz

# TEST REPORT

Report No.: SHE20080008-02GE

Date: 2020-09-03

Page 59 of 71

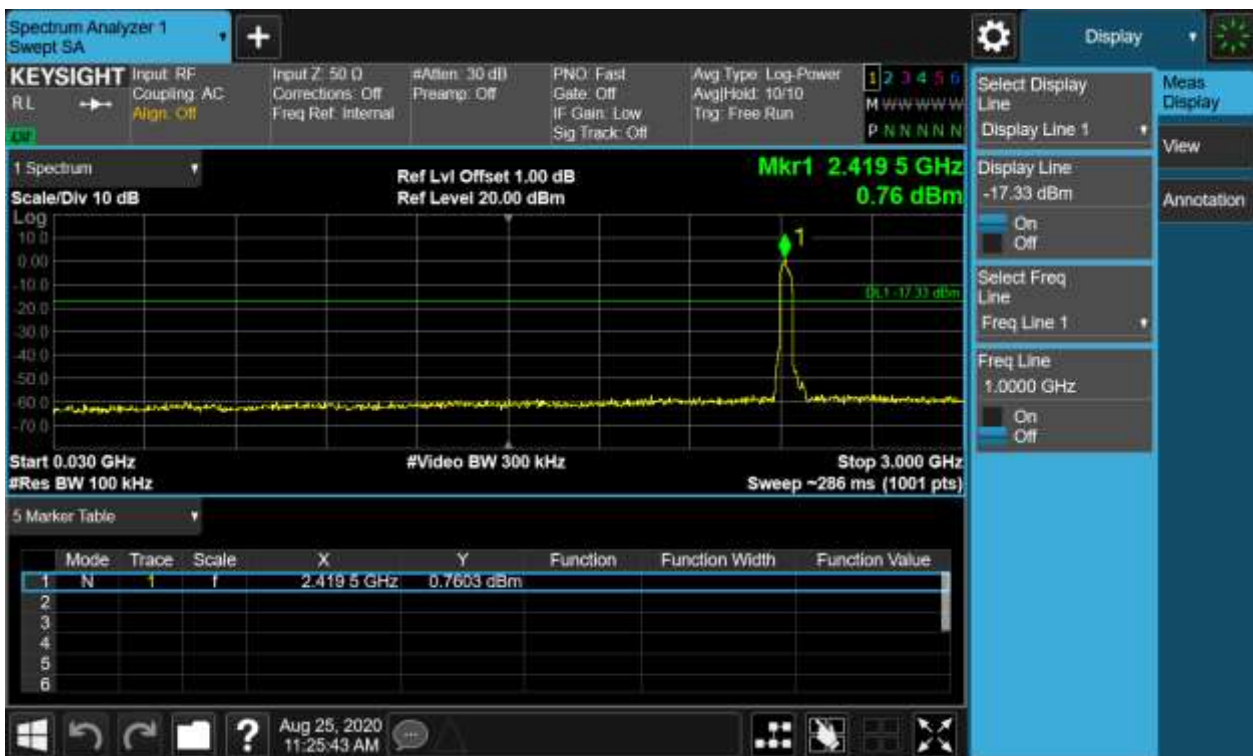
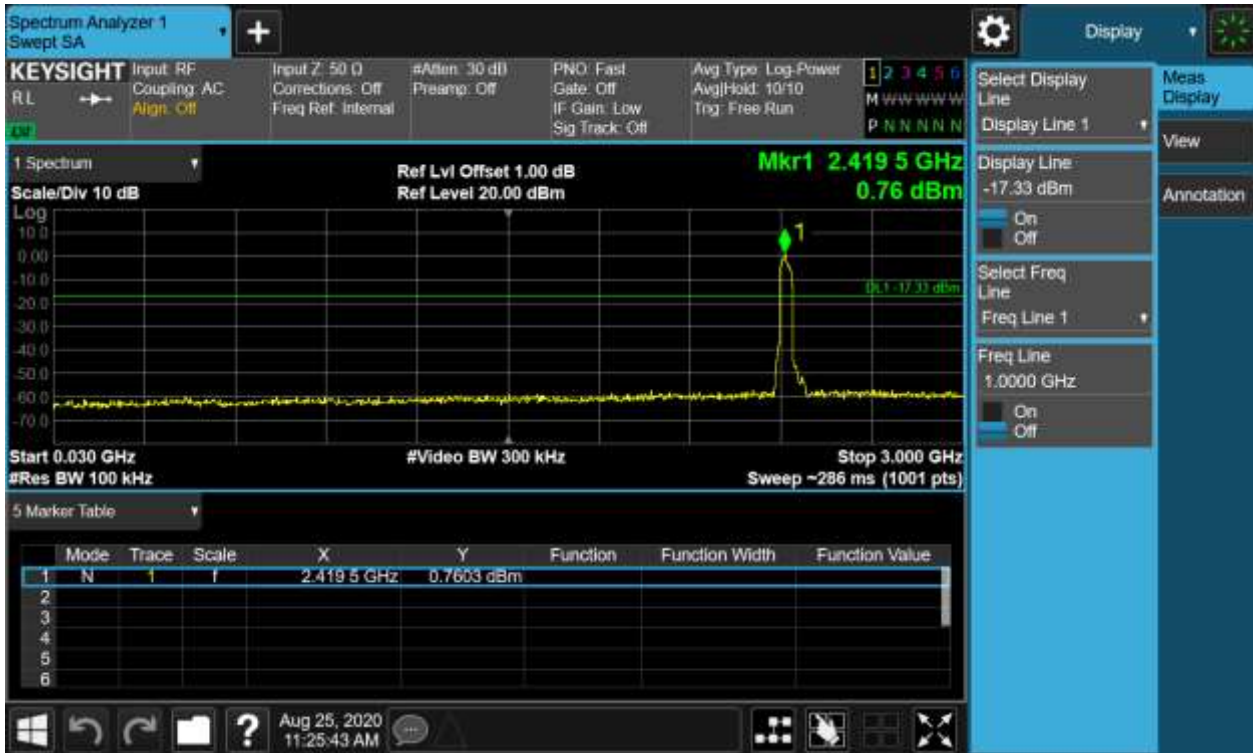

Figure 35: Conducted Spurious Emission & Authorized-band band-edge, 802.11n(HT40), 2437MHz

# TEST REPORT

Report No.: SHE20080008-02GE

Date: 2020-09-03

Page 60 of 71

## Carrier Level



## Conducted spurious emissions 30MHz-25GHz

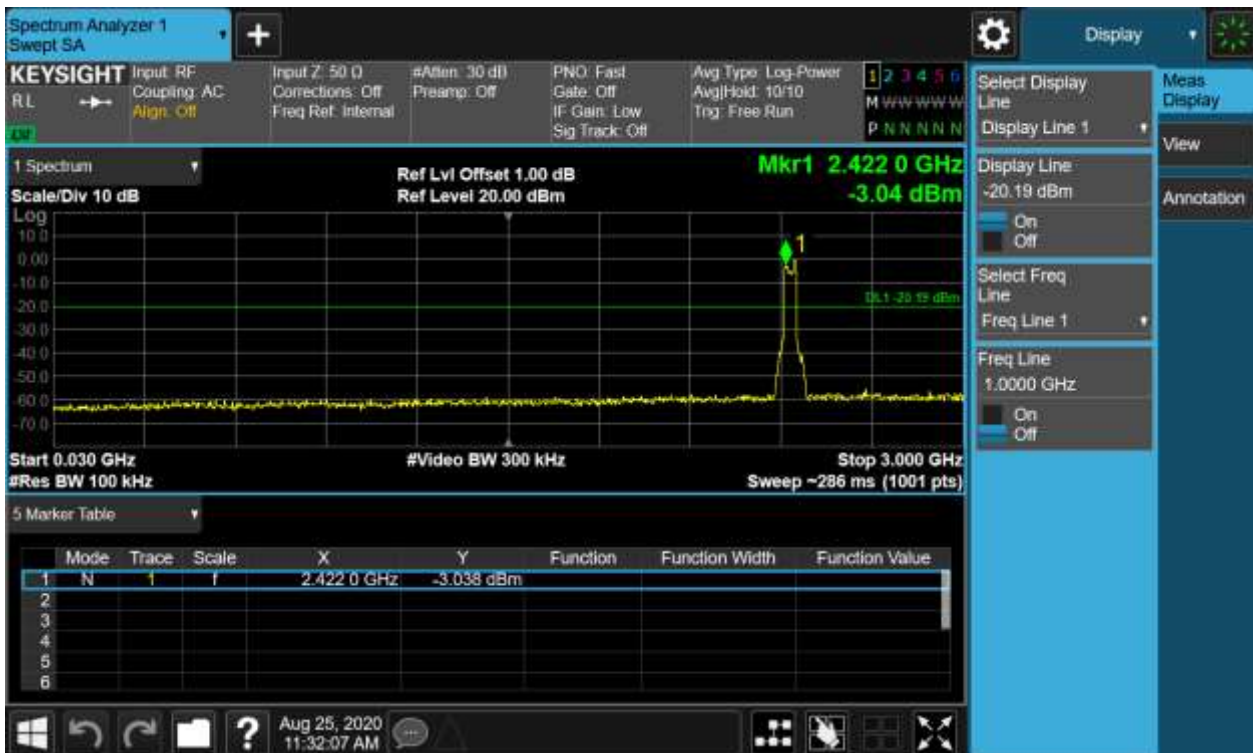

# TEST REPORT

Report No.: SHE20080008-02GE

Date: 2020-09-03

Page 61 of 71



Figure 36: Conducted Spurious Emission & Authorized-band band-edge, 802.11n(HT40), 2452MHz Carrier Level

# TEST REPORT

Report No.: SHE20080008-02GE

Date: 2020-09-03

Page 62 of 71



## Band Edge



Conducted spurious emissions 30MHz-25GHz

# TEST REPORT

Report No.: SHE20080008-02GE

Date: 2020-09-03

Page 63 of 71

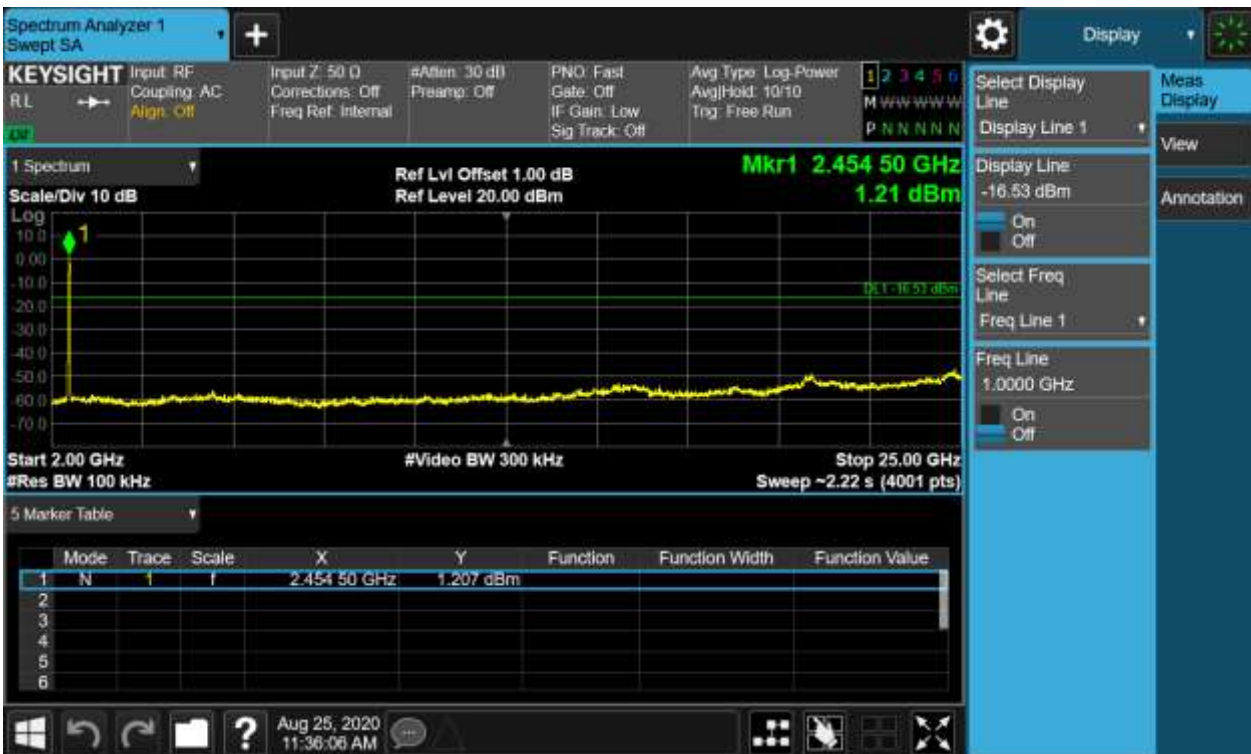

# TEST REPORT

Report No.: SHE20080008-02GE

Date: 2020-09-03

Page 64 of 71

## 4.1.6 Spurious Emission

RESULT:

**PASS**

Test standard : FCC Part 15.247(d), 15.205, 15.209  
RSS-247 5.5  
Requirement : ANSI C63.10-2013, KDB 558074  
Kind of test site : 3m Semi-Anechoic Chamber

### Test setup

Test Channel : Low/Middle/High  
Operation Mode : A  
Ambient temperature : 25°C  
Relative humidity : 52%

### Notes

*Test plots please refer to the annex document "WLAN 2.4GHz-TX EXHIBIT A of SHE20080008-02GE".*

1. For 9 kHz ~ 30 MHz, the amplitude of spurious emissions that are attenuated by more than 20dB below the permissible. The value has no need to be reported.
2. The spurious above 18GHz is noise only and 20dB below the limit. The value has no need to be reported.
3. The EUT is working in the Normal link mode below 1 GHz.



# TEST REPORT

Report No.: SHE20080008-02GE

Date: 2020-09-03

Page 65 of 71

## 4.1.7 Band Edge (Restricted-band band-edge)

RESULT:

**PASS**

Test standard : FCC Part 15.247(d), 15.205, 15.209  
RSS-247 5.5  
Requirement : ANSI C63.10-2013, KDB 558074  
Kind of test site : 3m Semi-Anechoic Chamber

### Test setup

Test Channel : Low/Middle/High  
Operation Mode : A.1  
Ambient temperature : 25°C  
Relative humidity : 52%

### Notes:

*Test plots please refer to the annex document "WLAN 2.4GHz-TX EXHIBIT A of SHE20080008-02GE".*

# TEST REPORT

Report No.: SHE20080008-02GE

Date: 2020-09-03

Page 66 of 71

## 4.2 Mains Emissions

### 4.2.1 Conducted Emission on AC Mains

RESULT:

**PASS**

Test standard : FCC Part 15.207(a)  
RSS-Gen 8.8  
Requirement : ANSI C63.10-2013  
Kind of test site : Shielded room

#### Test setup

Input Voltage : AC 120V, 60Hz; AC 240V, 50Hz  
Operation Mode : A  
Earthing : Not Connected  
Ambient temperature : 25°C  
Relative humidity : 52%

For details refer to following test plot.

# TEST REPORT

Report No.: SHE20080008-02GE

Date: 2020-09-03

Page 67 of 71

**Note:**

The all configurations were tested respectively, but only the worst configuration shown here.

**Figure 37: Conducted Emission on AC Mains, L Phase**

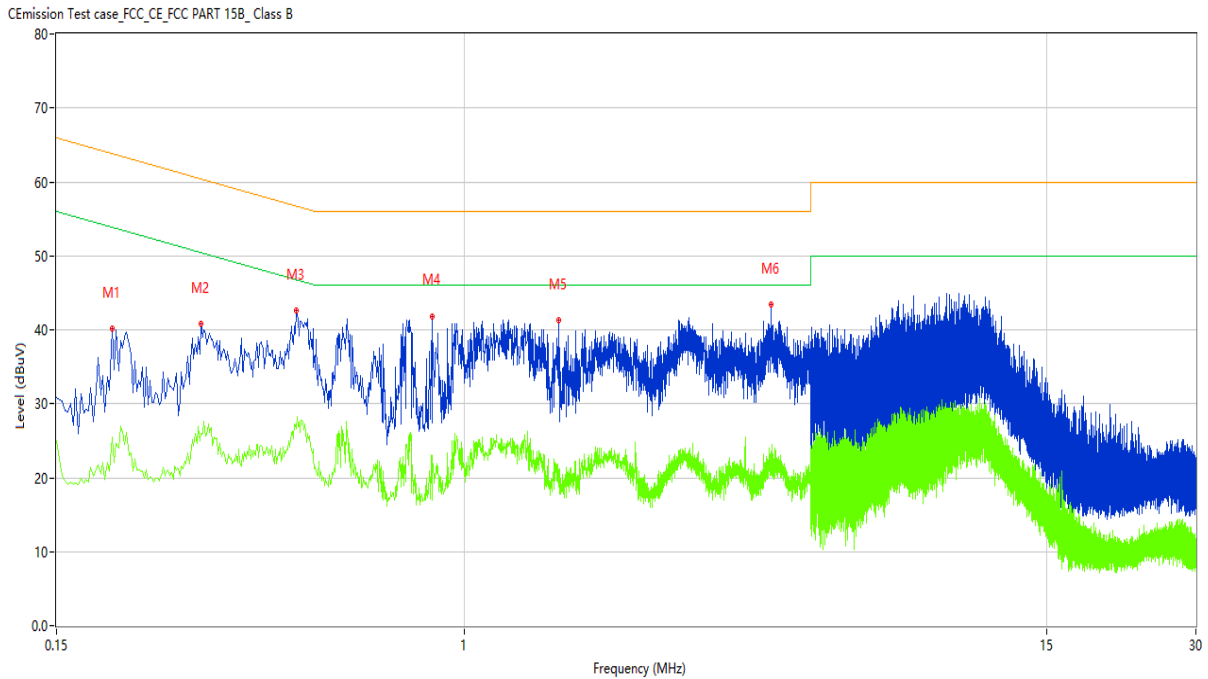

No.	Frequency (MHz)	Results (dBuV)	Factor (dB)	Limit (dBuV)	Over Limit (dB)	Detector	Line	Verdict
1	0.194	40.98	10.15	63.86	-22.88	Peak	L	Pass
1*	0.194	32.45	10.15	63.86	-31.41	QP	L	Pass
1**	0.194	25.42	10.15	53.86	-28.44	AV	L	Pass
2	0.294	41.70	10.14	60.41	-18.71	Peak	L	Pass
2*	0.294	35.03	10.14	60.41	-25.38	QP	L	Pass
2**	0.294	25.89	10.14	50.41	-24.52	AV	L	Pass
3	0.458	42.78	10.15	56.73	-13.95	Peak	L	Pass
3*	0.458	36.14	10.15	56.73	-20.59	QP	L	Pass
3**	0.458	26.56	10.15	46.73	-20.17	AV	L	Pass
4	0.862	42.30	10.15	56.00	-13.70	Peak	L	Pass
4*	0.862	30.98	10.15	56.00	-25.02	QP	L	Pass
4**	0.862	22.96	10.15	46.00	-23.04	AV	L	Pass
5	1.548	41.21	10.17	56.00	-14.79	Peak	L	Pass
5*	1.548	31.74	10.17	56.00	-24.26	QP	L	Pass
5**	1.548	21.13	10.17	46.00	-24.87	AV	L	Pass
6	4.156	42.20	10.25	56.00	-13.80	Peak	L	Pass
6*	4.156	32.74	10.25	56.00	-23.26	QP	L	Pass
6**	4.156	21.72	10.25	46.00	-24.28	AV	L	Pass

# TEST REPORT

Report No.: SHE20080008-02GE

Date: 2020-09-03

Page 68 of 71

**Figure 26: Conducted Emission on AC Mains, N Phase**

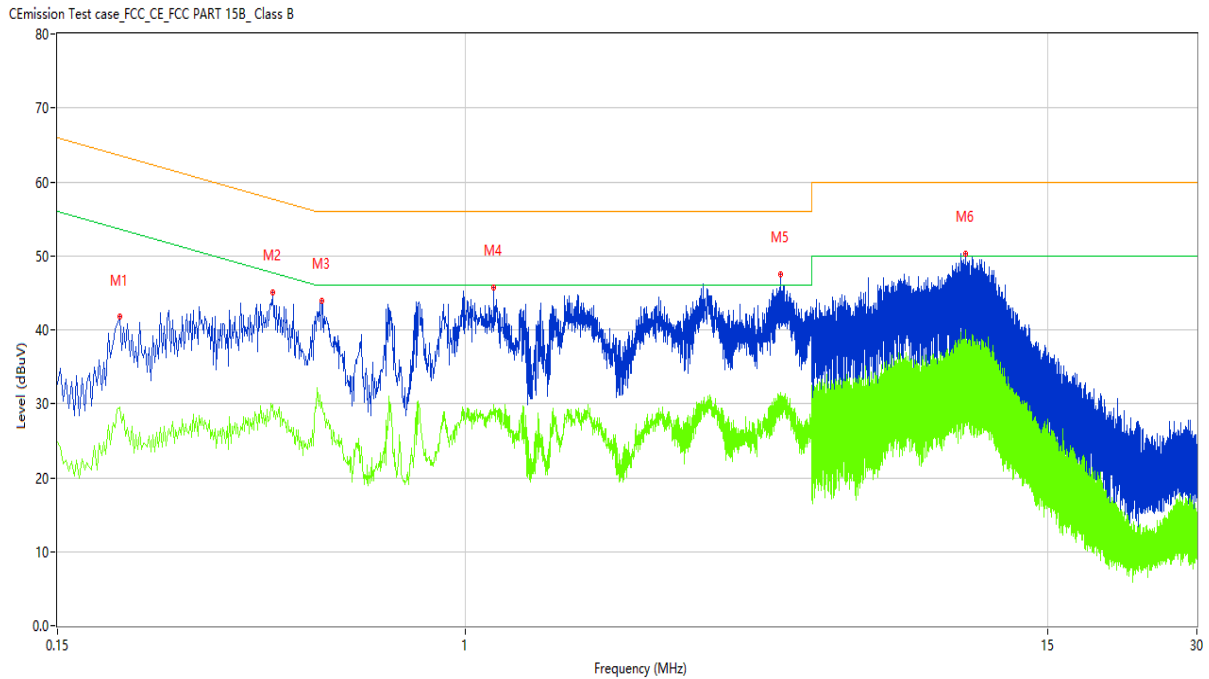

No.	Frequency (MHz)	Results (dBuV)	Factor (dB)	Limit (dBuV)	Over Limit (dB)	Detector	Line	Verdict
1	0.200	43.46	10.15	63.61	-20.15	Peak	N	Pass
1*	0.200	38.46	10.15	63.61	-25.15	QP	N	Pass
1**	0.200	29.62	10.15	53.61	-23.99	AV	N	Pass
2	0.408	47.02	10.15	57.69	-10.67	Peak	N	Pass
2*	0.408	39.37	10.15	57.69	-18.32	QP	N	Pass
2**	0.408	29.92	10.15	47.69	-17.77	AV	N	Pass
3	0.512	46.25	10.15	56.00	-9.75	Peak	N	Pass
3*	0.512	39.67	10.15	56.00	-16.33	QP	N	Pass
3**	0.512	30.13	10.15	46.00	-15.87	AV	N	Pass
4	1.142	46.21	10.16	56.00	-9.79	Peak	N	Pass
4*	1.142	38.55	10.16	56.00	-17.45	QP	N	Pass
4**	1.142	29.90	10.16	46.00	-16.10	AV	N	Pass
5	4.324	47.28	10.25	56.00	-8.72	Peak	N	Pass
5*	4.324	40.27	10.25	56.00	-15.73	QP	N	Pass
5**	4.324	31.48	10.25	46.00	-14.52	AV	N	Pass
6	10.228	50.78	10.41	60.00	-9.22	Peak	N	Pass
6*	10.228	43.49	10.41	60.00	-16.51	QP	N	Pass
6**	10.228	33.69	10.41	50.00	-16.31	AV	N	Pass

# TEST REPORT

Report No.: SHE20080008-02GE

Date: 2020-09-03

Page 69 of 71

## 5 Appendixes

### 5.1 Photographs of the Sample



Front of the sample



Rear of the sample

# TEST REPORT

Report No.: SHE20080008-02GE

Date: 2020-09-03

Page 70 of 71

## 5.2 Set-up for Conducted Emissions



## 5.3 Set-up for Conducted RF test at Antenna Port



# TEST REPORT

Report No.: SHE20080008-02GE

Date: 2020-09-03

Page 71 of 71

## 5.4 Set-up for Spurious Emissions below 1GHz



Below 1 GHz

## 5.5 Set-up for Spurious Emissions above 1GHz



Above 1GHz

\*\*\*End of the report\*\*\*