



FCC TEST REPORT
FCC ID: Y44-R60
On Behalf of
STONEX SRL
Android total station
Model No.: R60 (1"), R60 (2")

Prepared for : STONEX SRL
Address : via dei Mille 4 20900 Monza-MB Italy

Prepared By : Shenzhen Alpha Product Testing Co., Ltd.
Address : Building i, No.2, Lixin Road, Fuyong Street, Bao'an District,
518103, Shenzhen, Guangdong, China

Report Number : A2211349-C01-R14
Date of Receipt : February 8, 2023
Date of Test : February 8, 2023-April 20, 2023
Date of Report : April 23, 2023
Version Number : V0

TABLE OF CONTENTS

Description	Page
1.GENERAL INFORMATION -----	5
1.1.Description of Device (EUT) -----	5
1.2.Accessories of Device (EUT) -----	6
1.3.Tested Supporting System Details -----	6
1.4.Block Diagram of connection between EUT and simulators -----	6
2.EMC EQUIPMENT LIST -----	7
3.SUMMARY OF MEASUREMENT -----	8
3.1. Summary of test result-----	8
3.2. Equipment Type -----	8
3.3. Channel list -----	9
3.4. Test Conditions and channel -----	12
3.5. Measurement Uncertainty (95% confidence levels, k=2)-----	12
4.DFS PARAMETERS -----	13
4.1. DFS Parameters -----	13
4.2. Calibration Setup and DFS Test Results -----	19
4.2.1. Calibration of Radar Waveform -----	19
4.2.1.1.Radar Waveform Calibration Procedure -----	19
4.2.1.2.Radiated Calibration Setup-----	19
4.2.1.3.Calibration Deviation-----	19
4.2.1.4.Radar Waveform Calibration Result-----	20
4.3. In-Service Monitoring: Channel Move Time, Channel Closing Transmission Time and Non-Occupancy Period -----	21
4.3.1. Limit of In-Service Monitoring -----	21
4.3.2. Test Procedures -----	21
4.3.3. Test Setup-----	22
4.3.4. Test Deviation -----	22
4.3.5. Result of Channel Move Time, Channel Closing Transmission Time and Non-Occupancy Period for Client Beacon Test	23
4.3.6. Channel Move Time, Channel Closing Transmission Time and Non-Occupancy Period for Client Beacon Test Plots-----	24
4.3.7. Data Traffic and Noise Floor Plots-----	25

TEST REPORT DECLARATION

Applicant : STONEX SRL
 Address : via dei Mille 4 20900 Monza-MB Italy
 Manufacturer : SUZHOU FOIF CO.,LTD
 Address : 18 Tong Yuan Road, Suzhou, China
 EUT Description : Android total station
 (A) Model No. : R60 (1"), R60 (2")
 (B) Trademark : N/A

Measurement Standard Used:

FCC Part 15 Subpart E, FCC KDB 905462 D02, FCC KDB 905462 D03

The device described above is tested by Shenzhen Alpha Product Testing Co., Ltd. to determine the maximum emission levels emanating from the device. The maximum emission levels are compared to the FCC limits. The test results are contained in this test report and Shenzhen Alpha Product Testing Co., Ltd. is assumed of full responsibility for the accuracy and completeness of these tests.

After the test, our opinion is that EUT compliance with the requirement of the above standards.

This report applies to above tested sample only. This report shall not be reproduced in parts without written approval of Shenzhen Alpha Product Testing Co., Ltd.

Tested by (name + signature).....: Yannis Wen
 Project Engineer



Approved by (name + signature).....: Reak Yang
 Project Manager



Date of issue.....: April 23, 2023

Revision History

Revision	Issue Date	Revisions	Revised By
V0	April 23, 2023	Initial released Issue	Yannis Wen

1. GENERAL INFORMATION

1.1. Description of Device (EUT)

EUT Name	: Android total station
Trademark	: N/A
Model No.	: R60 (1"), R60 (2")
DIFF.	: The angle measurement accuracy between the two models is different, R60 (1 ") angle measurement accuracy is 1". R60 (2 ") has an angle measurement accuracy of 2" and is friction stopped. They use the same wireless module, and all the test were performed on the model R60 (1")
Power supply	: DC 7.2V from battery, AC 120V/60Hz for battery charging
Radio Technology	: 5G WIFI
Operation Frequency	: 802.11ax/a/n(HT20)/ac(HT20): 5180~5240MHz; 5260-5320MHz; 5500-5700MHz; 5745~5825MHz 802.11ax/n(HT40)/ac(HT40): 5190~5230MHz; 5260-5320MHz; 5510-5670MHz; 5755~5795MHz 802.11ax/ac(HT80): 5210MHz, 5290MHz, 5530MHz, 5775MHz
Channel separation	: 20MHz for 802.11a x20/802.11a/ 802.11ac20/ 802.11n(HT20) 40MHz for 802.11a x40/802.11ac40/ 802.11n(HT40) 80MHz for 802.11a x80/802.11ac80
Modulation technology:	: IEEE 802.11n: OFDM (64QAM, 16QAM,QPSK,BPSK) IEEE 802.11a: OFDM (64QAM, 16QAM,QPSK,BPSK) IEEE 802.11ac: OFDM (64QAM, 16QAM,QPSK,BPSK) IEEE 802.11ax: OFDMA (1024-QAM, 256-QAM, 64-QAM, QPSK, BPSK)
Antenna Type	: FPC Antenna, max gain 2.97dBi Antenna information is provided by applicant.
Software version	: V1.0
Hardware version	: V1.0
Intend use environment	: Residential, commercial and light industrial environment

1.2. Accessories of Device (EUT)

Accessories	:	Super Si Pro Quick Charger
Manufacturer	:	Shenzhen Times Innovation Technology Co., Ltd
Model	:	CCCJG30CE
Input	:	AC 100-240V, 50/60Hz, 1.2A Max
Type-C Output	:	5.0V=3.0A(15.0W); 9.0V=3.0A(27.0W); 12.0V=2.5A(30.0W); 15.0V=2.0A(30.0W); 20.0V=1.5A(15.0W)
USB Output	:	5.0V=3.0A(15.0W); 9.0V=3.0A(27.0W); 12.0V=2.5A(30.0W); 15.0V=2.0A(30.0W); 20.0V=1.5A(15.0W) 18.0W+12.0W
Type-C + USB Output	:	18W:9.0V=2.0A(18.0W); 12.0V=1.5A(18.0W); 12W: 5.0V=2.4A(12.0W); 9.0V=1.33A(12.0W); 12.0V=1.0A(12.0W)
Accessories	:	Quick Charger
Manufacturer	:	AMC
Model	:	CD272
Input	:	AC 100-240V~50/60Hz, 800mA Max
Type-C Output	:	5V=2A 9V=3 12V=2.75A 15V=2.2A 20V=1.65A 3.3-11VV=3A
Output Power	:	33W Max

1.3. Tested Supporting System Details

No.	Description	Manufacturer	Model	Serial Number	Certification or SDOC
1.	Router(master)	HUAWEI	Echolife HG8245Q	48575443B12E6 D9D	FCC ID: QISHG8245Q
2.	Notebook PC	Lenovo	T430	N/A	N/A

Note: master ping IP 192.168.100.1 for salve.

1.4. Block Diagram of connection between EUT and simulators



2. EMC EQUIPMENT LIST

Equipment	Manufacture	Model No.	Firmware version	Serial No.	Last cal.	Cal Interval
9*6*6 anechoic chamber	CHENYU	9*6*6	/	N/A	2022.05.17	3Year
Spectrum analyzer	ROHDE&SCHWARZ	FSV40-N	2.3	102137	2022.08.22	1Year
Spectrum analyzer	Agilent	N9020A	A.14.16	MY499100060	2022.08.22	1Year
Receiver	ROHDE&SCHWARZ	ESR	2.28 SP1	1316.3003K03-10 2082-Wa	2022.08.22	1Year
Receiver	R&S	ESCI	4.42 SP1	101165	2022.08.22	1Year
Bilog Antenna	Schwarzbeck	VULB 9168	/	VULB 9168#627	2021.08.30	2Year
Horn Antenna	SCHWARZBECK	BBHA 9120 D	/	2106	2021.08.30	2Year
Active Loop Antenna	SCHWARZBECK	FMZB 1519B	/	00059	2021.08.30	2Year
RF Cable	Resenberger	Cable 1	/	RE1	2022.08.22	1Year
RF Cable	Resenberger	Cable 2	/	RE2	2022.08.22	1Year
RF Cable	Resenberger	Cable 3	/	CE1	2022.08.22	1Year
Pre-amplifier	HP	HP8347A	/	2834A00455	2022.08.22	1Year
Pre-amplifier	Agilent	8449B	/	3008A02664	2022.08.22	1Year
L.I.S.N.#1	Schwarzbeck	NSLK8126	/	8126-466	2022.08.22	1Year
L.I.S.N.#2	ROHDE&SCHWARZ	ENV216	/	101043	2022.08.23	1 Year
Horn Antenna	SCHWARZBECK	BBHA9170	/	00946	2021.08.30	2 Year
Preamplifier	SKET	LNPA_1840 -50	/	SK2018101801	2022.08.22	1 Year
Power Meter	Agilent	E9300A	/	MY41496628	2022.08.22	1 Year
Power Sensor	DARE	RPR3006W	/	15100041SNO91	2022.08.22	1 Year
Temp. & Humid. Chamber	Weihuang	WHTH-1000 -40-880	/	100631	2023.04.18	1 Year
Switching Mode Power Supply	JUNKE	JK12010S	/	20140927-6	2022.08.22	1 Year
Adjustable attenuator	MWRftest	N/A	/	N/A	N/A	N/A
10dB Attenuator	Mini-Circuits	DC-6G	/	N/A	N/A	N/A

Software Information

Test Item	Software Name	Manufacturer	Version
RE	EZ-EMC	EZ	Alpha-3A1
CE	EZ-EMC	EZ	Alpha-3A1
RF-CE	MTS 8310	MW	V2.0.0.0

3. SUMMARY OF MEASUREMENT

3.1. Summary of test result

UNII	Bandwidth and Channel	Description	Measured	Limit	Result
U-NII-2C 5250-5350MHz	80MHz (CH58) 5290MHz	Channel Move Time	1.4 sec	10 sec	Pass
		Channel Closing Transmission time	<200ms +3.6 ms (aggregate)	200 ms + aggregate of 60 ms over remaining 10 s period	Pass
		Non-Occupancy Period and Client Beacon Test	No transmission or Beacons occurred	30 minutes	Pass
U-NII-2C 5470-5725MHz	80MHz (CH106) 5530MHz	Channel Move Time	1.4 sec	10 sec	Pass
		Channel Closing Transmission time	<200ms +3.6 ms (aggregate)	200 ms + aggregate of 60 ms over remaining 10 s period	Pass
		Non-Occupancy Period and Client Beacon Test	No transmission or Beacons occurred	30 minutes	Pass

Note: 1. Since the product is client without radar detection function, only Channel Move Time, Channel Closing Transmission Time and Non-Occupancy Period Test are required to be performed.

2. The conclusion of this test report is judged by actual test data without considering measurement uncertainty.

3.2. Equipment Type

Master Device

Client Device(No Ad-Hoc mode, without radar detection function and TPC)

3.3.Channel list

U-NII-1:

Tested mode, channel, and data rate information			
Mode	Data rate(Mbps) see Note	Channel	Frequency (MHz)
IEEE 802.11a	6	CH36	5180
	6	CH44	5200
	6	CH48	5240
IEEE 802.11ac VHT20	6.5	CH36	5180
	6.5	CH44	5200
	6.5	CH48	5240
IEEE 802.11ac VHT40	13.5	CH38	5190
	13.5	CH46	5230
IEEE 802.11ac VHT80	433.3	CH42	5210
IEEE 802.11n HT20	6.5	CH36	5180
	6.5	CH44	5200
	6.5	CH48	5240
IEEE 802.11n HT40	13.5	CH38	5190
	13.5	CH46	5230
IEEE 802.11ax VHT20	6.5	CH36	5180
	6.5	CH44	5200
	6.5	CH48	5240
IEEE 802.11ax VHT40	13.5	CH38	5190
	13.5	CH46	5230
IEEE 802.11ax VHT80	433.3	CH42	5210

Note: According exploratory test and product specification EUT will have maximum output power in those data rate, so those data rate were used for all test.

U-NII-2A:

Tested mode, channel, and data rate information			
Mode	Data rate(Mbps) see Note	Channel	Frequency (MHz)
IEEE 802.11a	6	CH52	5260
	6	CH56	5280
	6	CH64	5320
IEEE 802.11n HT20	6.5	CH52	5260
	6.5	CH56	5280
	6.5	CH64	5320
IEEE 802.11n HT40	13.5	CH54	5270
	13.5	CH62	5310
IEEE 802.11ac VHT20	6.5	CH52	5260
	6.5	CH56	5280
	6.5	CH64	5320
IEEE 802.11ac VHT40	13.5	CH54	5270
	13.5	CH62	5310
IEEE 802.11ac VHT80	433.3	CH58	5290
IEEE 802.11acx VHT20	6.5	CH52	5260
	6.5	CH56	5280
	6.5	CH64	5320
IEEE 802.11ax VHT40	13.5	CH54	5270
	13.5	CH62	5310
IEEE 802.11ax VHT80	433.3	CH58	5290
Note: According exploratory test and product specification EUT will have maximum output power in those data rate, so those data rate were used for all test.			

U-NII-2C:

Tested mode, channel, and data rate information			
Mode	Data rate(Mbps) see Note	Channel	Frequency (MHz)
IEEE 802.11a	6	CH100	5500
	6	CH116	5580
	6	CH140	5700
IEEE 802.11n HT20	6.5	CH100	5500
	6.5	CH116	5580
	6.5	CH140	5700
IEEE 802.11n HT40	13.5	CH102	5510
	13.5	CH134	5670
IEEE 802.11ac VHT20	6.5	CH100	5500
	6.5	CH116	5580
	6.5	CH140	5700
IEEE 802.11ac VHT40	13.5	CH102	5510
	13.5	CH134	5670
IEEE 802.11ac VHT80	433.3	CH106	5530
IEEE 802.11ax VHT20	6.5	CH100	5500
	6.5	CH116	5580
	6.5	CH140	5700
IEEE 802.11ax VHT40	13.5	CH102	5510
	13.5	CH134	5670
IEEE 802.11ax VHT80	433.3	CH106	5530

Note: According exploratory test and product specification EUT will have maximum output power in those data rate, so those data rate were used for all test.

3.4. Test Conditions and channel

Temperature range	21-25°C
Humidity range	40-75%
Pressure range	86-106kPa

Channel List for 802.11a		
Band Frequency	EUT Channel	Test Frequency (MHz)
Band II	CH60	5300
Band III	CH100	5500

Note: (1) The measurements are performed at the lowest available channels.

3.5. Measurement Uncertainty (95% confidence levels, k=2)

Item	MU	Remark
Uncertainty for conducted RF Power	0.37dB	

4. DFS PARAMETERS

4.1. DFS Parameters

Table 1: Applicability of DFS Requirements Prior to Use of a Channel

Requirement	Operational Mode		
	Master	Client Without Radar Detection	Client With Radar Detection
Non-Occupancy Period	Yes	Not required	Yes
DFS Detection Threshold	Yes	Not required	Yes
Channel Availability Check Time	Yes	Not required	Not required
U-NII Detection Bandwidth	Yes	Not required	Yes

Table 2: Applicability of DFS requirements during normal operation

Requirement	Operational Mode		
	Master	Client Without Radar Detection	Client With Radar Detection
DFS Detection Threshold	Yes	Not required	Yes
Channel Closing Transmission Time	Yes	Yes	Yes
Channel Move Time	Yes	Yes	Yes
U-NII Detection Bandwidth	Yes	Not required	Yes
Client Beacon Test	N/A	Yes	Yes

Additional requirements for devices with multiple bandwidth modes	Operational Mode	
	Master or Client With Radar Detection	Client Without Radar Detection
U-NII Detection Bandwidth and Statistical Performance Check	All BW modes must be tested	Not required
Channel Move Time and Channel Closing Transmission Time	Test using widest BW mode available	Test using the widest BW mode available for the link
All other tests	Any single BW mode	Not required
<p style="text-align: center;">Note</p> <p>Frequencies selected for statistical performance check (Section 7.8.4) should include several frequencies within the radar detection bandwidth and frequencies near the edge of the radar detection bandwidth. For 802.11 devices it is suggested to select frequencies in each of the bonded 20 MHz channels and the channel center frequency.</p>		

Table 3: DFS Detection Thresholds for Master Devices and Client Devices With Radar Detection

Maximum Transmit Power	Value (see notes 1, 2, and 3)
EIRP \geq 200 milliwatt	-64 dBm
EIRP < 200 milliwatt and power spectral density < 10 dBm/MHz	-62 dBm
EIRP < 200 milliwatt that do not meet the power spectral density requirement	-64 dBm
<p>Note 1: This is the level at the input of the receiver assuming a 0 dBi receive antenna.</p> <p>Note 2: Throughout these test procedures an additional 1 dB has been added to the amplitude of the test transmission waveforms to account for variations in measurement equipment. This will ensure that the test signal is at or above the detection threshold level to trigger a DFS response.</p> <p>Note 3: EIRP is based on the highest antenna gain. For MIMO devices refer to KDB Publication 662911 D01.</p>	

The radar Detection Threshold, lowest antenna gain is the parameter of Interference radar DFS detection threshold, The Interference Detection Threshold is the (-62dBm) + (0) [dBi]+ 1 dB= -61 dBm.

Table 4: DFS Response Requirement Values

Parameter	Value
<i>Non-occupancy period</i>	Minimum 30 minutes
<i>Channel Availability Check Time</i>	60 seconds
<i>Channel Move Time</i>	10 seconds See Note 1.
<i>Channel Closing Transmission Time</i>	200 milliseconds + an aggregate of 60 milliseconds over remaining 10 second period. See Notes 1 and 2.
<i>U-NII Detection Bandwidth</i>	Minimum 100% of the 99% power bandwidth See Note 3.
<p>Note 1: The instant that the <i>Channel Move Time</i> and the <i>Channel Closing Transmission Time</i> begins is as follows:</p> <ul style="list-style-type: none"> • For the Short pulse radar Test Signals this instant is the end of the <i>Burst</i>. • For the Frequency Hopping radar Test Signal, this instant is the end of the last radar <i>Burst</i> generated. • For the Long Pulse radar Test Signal this instant is the end of the 12 second period defining the radar transmission. <p>Note 2: The <i>Channel Closing Transmission Time</i> is comprised of 200 milliseconds starting at the beginning of the <i>Channel Move Time</i> plus any additional intermittent control signals required to facilitate <i>Channel</i> changes (an aggregate of 60 milliseconds) during the remainder of the 10 second period. The aggregate duration of control signals will not count quiet periods in between transmissions.</p> <p>Note 3: During the <i>U-NII Detection Bandwidth</i> detection test, radar type 0 is used and for each frequency step the minimum percentage of detection is 90%. Measurements are performed with no data traffic.</p>	

Table 5 – Short Pulse Radar Test Waveforms

Radar Type	Pulse Width (μsec)	PRI (μsec)	Number of Pulses	Minimum Percentage of Successful Detection	Minimum Number of Trials
0	1	1428	18	See Note 1	See Note 1
1	1	Test A: 15 unique PRI values randomly selected from the list of 23 PRI values in Table 5a	Roundup $\left\{ \left(\frac{1}{360} \right) \cdot \left(\frac{19 \cdot 10^6}{\text{PRI}_{\mu\text{sec}}} \right) \right\}$	60%	30
		Test B: 15 unique PRI values randomly selected within the range of 518-3066 μsec, with a minimum increment of 1 μsec, excluding PRI values selected in Test A			
2	1-5	150-230	23-29	60%	30
3	6-10	200-500	16-18	60%	30
4	11-20	200-500	12-16	60%	30
Aggregate (Radar Types 1-4)				80%	120
Note 1: Short Pulse Radar Type 0 should be used for the detection bandwidth test, channel move time, and channel closing time tests.					

Table 5a - Pulse Repetition Intervals Values for Test A

Pulse Repetition Frequency Number	Pulse Repetition Frequency (Pulses Per Second)	Pulse Repetition Interval (Microseconds)
1	1930.5	518
2	1858.7	538
3	1792.1	558
4	1730.1	578
5	1672.2	598
6	1618.1	618
7	1567.4	638
8	1519.8	658
9	1474.9	678
10	1432.7	698
11	1392.8	718
12	1355	738
13	1319.3	758
14	1285.3	778
15	1253.1	798
16	1222.5	818
17	1193.3	838
18	1165.6	858
19	1139	878
20	1113.6	898
21	1089.3	918
22	1066.1	938
23	326.2	3066

The aggregate is the average of the percentage of successful detections of Short Pulse Radar Types 1-4. For example, the following table indicates how to compute the aggregate of percentage of successful detections.

Radar Type	Number of Trials	Number of Successful Detections	Minimum Percentage of Successful Detection
1	35	29	82.9%
2	30	18	60%
3	30	27	90%
4	50	44	88%
Aggregate $(82.9\% + 60\% + 90\% + 88\%)/4 = 80.2\%$			

Long Pulse Radar Test Waveform

Table 6 – Long Pulse Radar Test Waveform

Radar Type	Pulse Width (μsec)	Chirp Width (MHz)	PRI (μsec)	Number of Pulses per <i>Burst</i>	Number of <i>Bursts</i>	Minimum Percentage of Successful Detection	Minimum Number of Trials
5	50-100	5-20	1000-2000	1-3	8-20	80%	30

Figure 1 provides a graphical representation of the Long Pulse Radar Test Waveform.

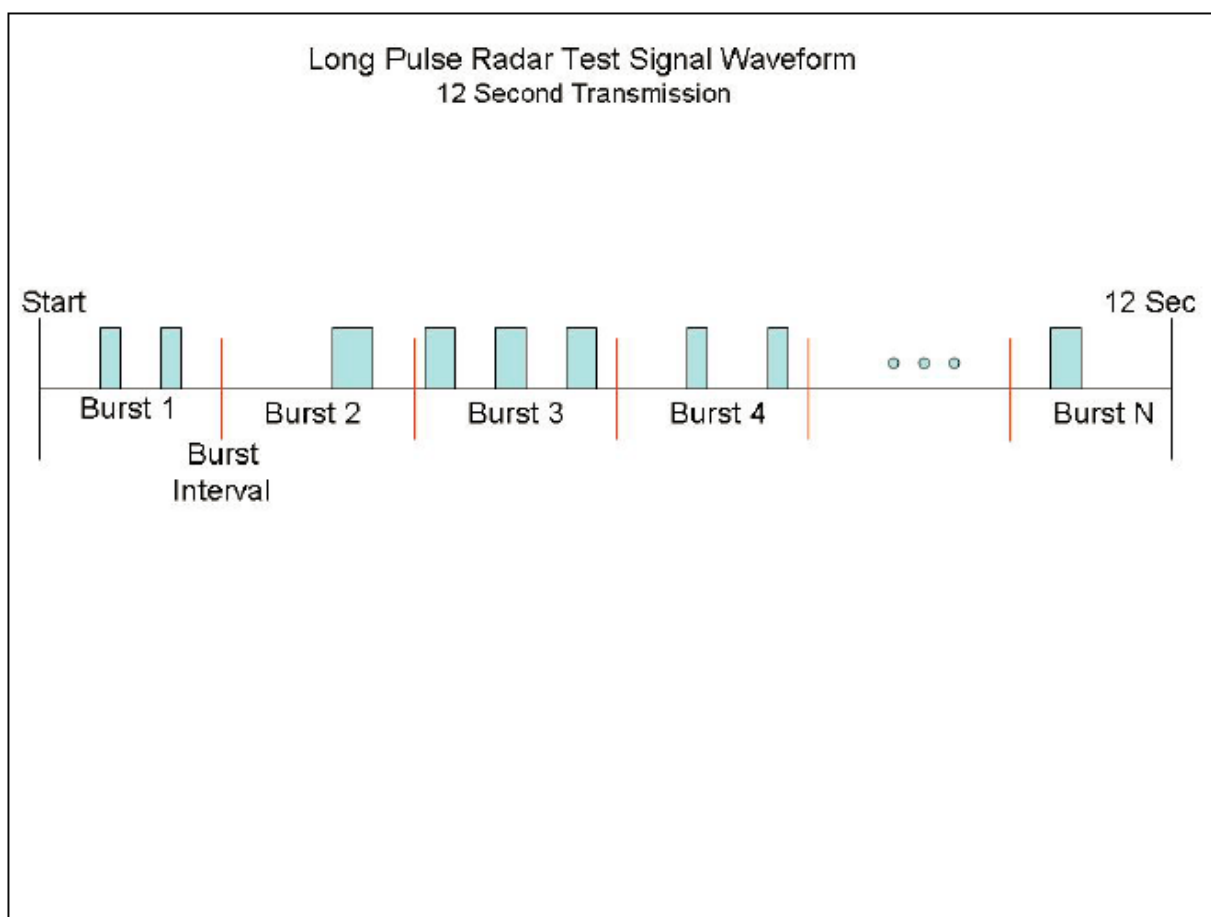
**Table 7 – Frequency Hopping Radar Test Waveform**

Radar Type	Pulse Width (μsec)	PRI (μsec)	Pulses per Hop	Hopping Rate (kHz)	Hopping Sequence Length (msec)	Minimum Percentage of Successful Detection	Minimum Number of Trials
6	1	333	9	0.333	300	70%	30

4.2. Calibration Setup and DFS Test Results

4.2.1. Calibration of Radar Waveform

4.2.1.1. Radar Waveform Calibration Procedure

The Interference **Radar Detection Threshold Level** is $(-62\text{dBm}) + (0) [\text{dBi}] + 1 \text{ dB} = -61\text{dBm}$ that had been taken into account the output power range and antenna gain. The following equipment setup was used to calibrate the radiated Radar Waveform. A vector signal generator was utilized to establish the test signal level for radar type 0. During this process there were no transmissions by either the Master or Client Device. The spectrum analyzer was switched to the zero span (Time Domain) at the frequency of the Radar Waveform generator. Peak detection was used. The spectrum analyzer resolution bandwidth (RBW) and video bandwidth (VBW) were set to 3 MHz to measure the type 0 radar waveform. The spectrum analyzer had offset -8.26dB to compensate receiving horn antenna gain 11.80dBi and RF cable loss 3.54dB. The vector signal generator amplitude was set so that the power level measured at the spectrum analyzer was $(-62\text{dBm}) + (0) [\text{dBi}] + 1 \text{ dB} = -61 \text{ dBm}$. Capture the spectrum analyzer plots on short pulse radar waveform.

4.2.1.2. Radiated Calibration Setup

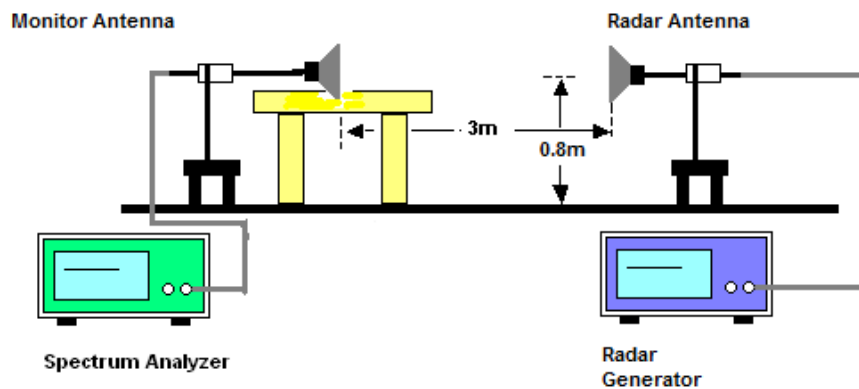

4.2.1.3. Calibration Deviation

There is no deviation with the original standard.

4.2.1.4. Radar Waveform Calibration Result

<a / 5300 MHz> In-Service Monitoring

Radar / DFS detection threshold level and the burst of pulses on the Channel frequency

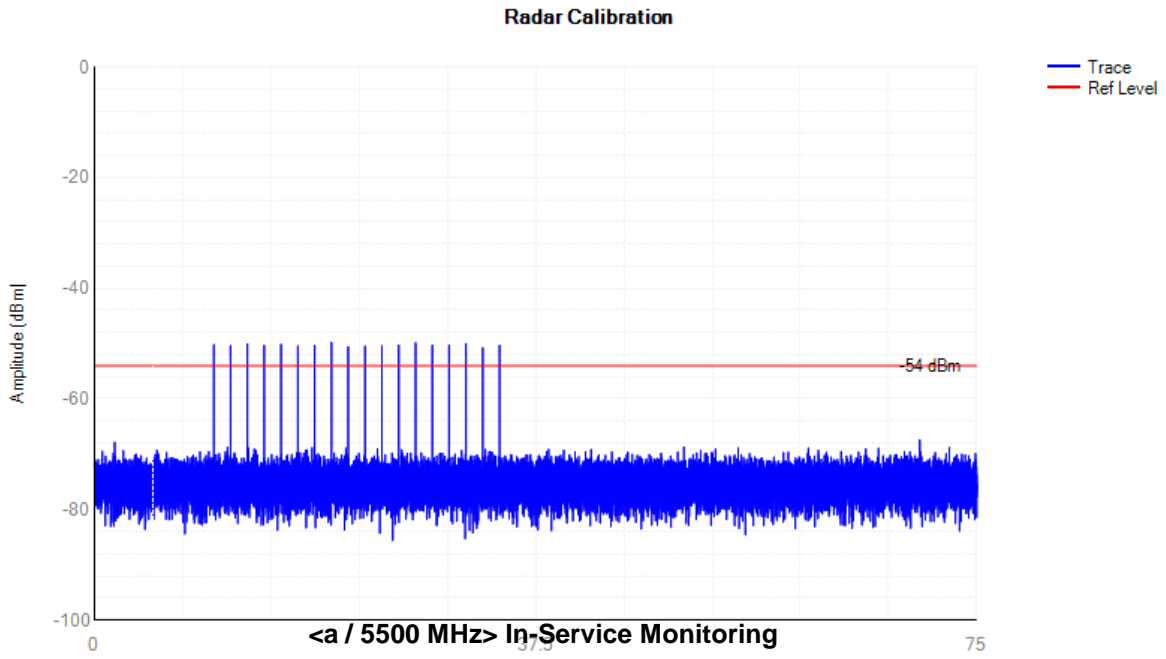

Radar / DFS detection threshold level and the burst of pulses on the Channel frequency

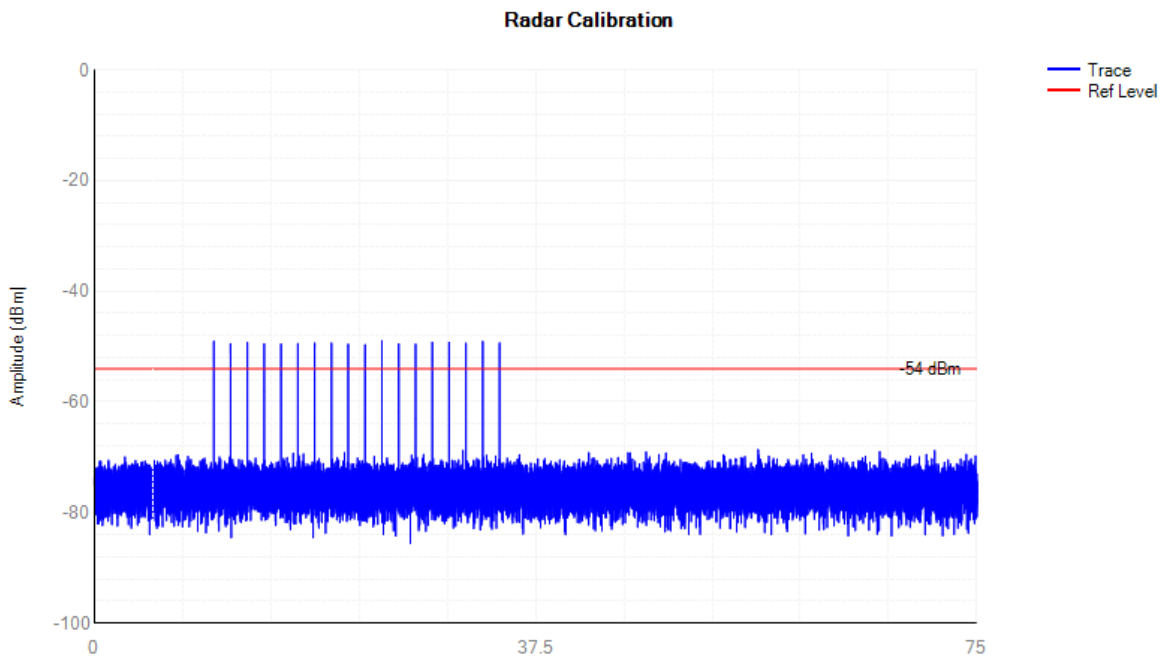

Note: All the test modes completed for test. The worst case of Ant 1, the test data of this mode was reported.

4.3. In-Service Monitoring: Channel Move Time, Channel Closing Transmission Time and Non-Occupancy Period

4.3.1. Limit of In-Service Monitoring

The EUT has In-Service Monitoring function to continuously monitor the radar signals, If radar is detected, it must leave the channel (Shutdown). The Channel Move Time to cease all transmissions on the current Channel upon detection of a Radar Waveform above the DFS Detection Threshold within 10 sec. The total duration of *Channel Closing Transmission Time* is comprised of 200 milliseconds starting at the beginning of the *Channel Move Time* plus any additional intermittent control signals required to facilitate *Channel* changes (an aggregate of 60 milliseconds) during the remainder of the 10 second period. The aggregate duration of control signals will not count quiet periods in between transmissions.

Non-Occupancy Period time is 30 minute during which a Channel will not be utilized after a Radar Waveform is detected on that Channel. The non-associated Client Beacon Test is during the 30 minutes observation time. The EUT should not make any transmissions in the DFS band after EUT power up.

4.3.2. Test Procedures

- a. The radar pulse generator is setup to provide a pulse at frequency that the Master and Client are operating. A type 0 radar pulse with a 1us pulse width and a 1428 us PRI is used for the testing.
- b. The vector signal generator is adjusted to provide the radar burst (18 pulses) at a level of approximately -62dBm at the antenna of the Master device.
- c. A trigger is provided from the pulse generator to the DFS monitoring system in order to capture the traffic and the occurrence of the radar pulse.
- d. A U-NII device operating as a Client Device will associate with the Master at Channel. The MPEG file "TestFile.mpg" specified by the FCC is streamed from the "file computer" through the Master to the Client Device and played in full motion video using Media Player Classic Ver. 6.4.8.6 in order to properly load the network for the entire period of the test.
- e. When a radar Burst with a level equal to the DFS Detection Threshold + 1dB is generated on the Operating Channel of the U-NII device. At time T0 the Radar Waveform generator sends a Burst of pulse of the radar waveform at Detection Threshold + 1dB.
- f. Observe the transmissions of the EUT at the end of the radar Burst on the Operating Channel. Measure and record the transmissions from the EUT during the observation time (Channel Move Time). One 12 seconds plot is reported for the Short Pulse Radar Types 1. The plot for the Short Pulse Radar Types start at the end of the radar burst. The Channel Move Time will be calculated based on the zoom in 600ms plot of the Short Pulse Radar Type.
- g. Measurement of the aggregate duration of the Channel Closing Transmission Time method. With the spectrum analyzer set to zero span tuned to the center frequency of the EUT operating channel at the radar simulated frequency, peak detection, and max hold, the dwell time per bin is given by: **Dwell (0.4ms) = S (12000ms) / B (30000)**, where Dwell is the dwell time per spectrum analyzer sampling bin, S is the sweep time and B is the number of spectrum analyzer sampling bins. An upper bound of the aggregate duration of the intermittent control signals of Channel Closing

Transmission Time is calculated by: $C \text{ (ms)} = N \times \text{Dwell (0.4 ms)}$, where C is the Closing Time, N is the number of spectrum analyzer sampling bins (intermittent control signals) showing a U-NII transmission and Dwell is the dwell time per bin.

- h. Measure the EUT for more than 30 minutes following the channel move time to verify that no transmissions or beacons occur on this Channel.

4.3.3. Test Setup

Radiated Test Setup Photo

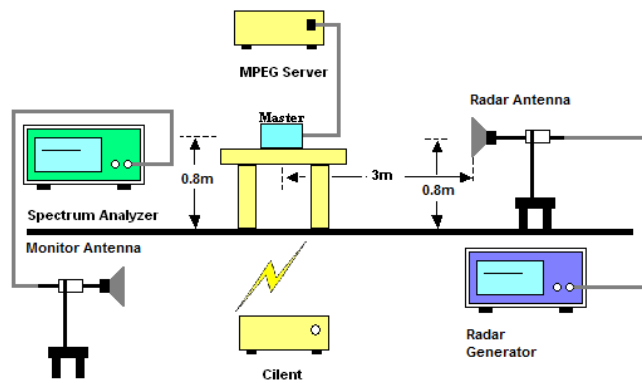

4.3.4. Test Deviation

There is no deviation with the original standard.

4.3.5. Result of Channel Move Time, Channel Closing Transmission Time and Non-Occupancy Period for Client Beacon Test

BW / Channel	Test Item	Test Result	Limit	Pass/Fail
160MHz / 5570 MHz	Channel Move Time	1.4s	< 10s	Pass
	Channel Closing Transmission Time	200ms + 3.6ms	< 260ms	Pass
	Non-Occupancy Period	≥ 30	≥ 30 min	Pass

Note: The Channel Closing Transmission Time is comprised of 200 milliseconds starting at the beginning of the Channel Move Time plus any additional intermittent control signals required to facilitate a Channel move (an aggregate of 60 milliseconds) during the remainder of the 10 seconds period. The aggregate duration of control signals will not count quiet periods in between transmissions.

4.3.6. Channel Move Time, Channel Closing Transmission Time and Non-Occupancy Period for Client Beacon Test Plots

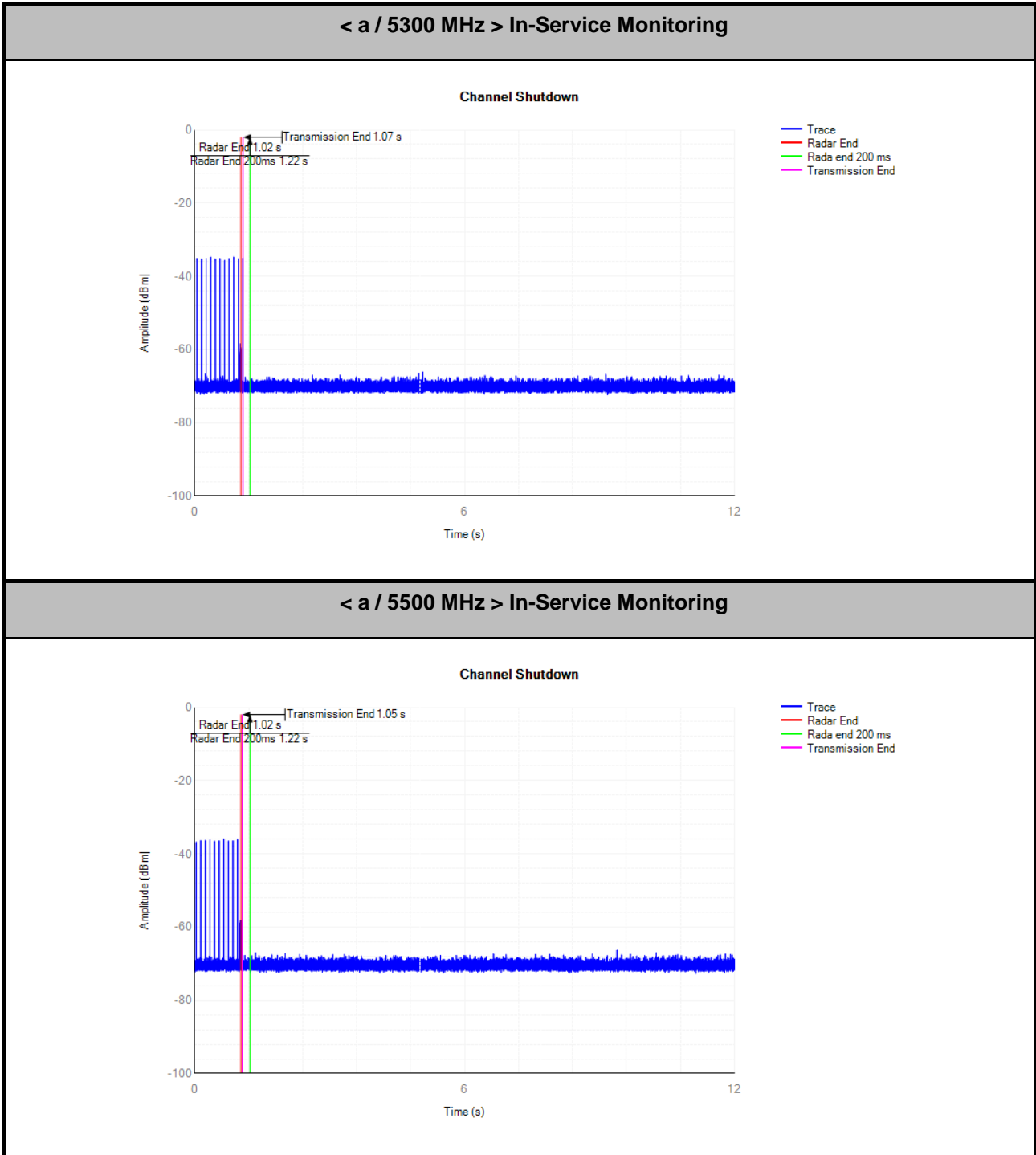

Note: All the test modes completed for test, and the test data of this mode was reported

4.3.7. Data Traffic and Noise Floor Plots

Noise Floor (No transmission)

< a / 5300 MHz Non-Occupancy >

Non-Occupancy period

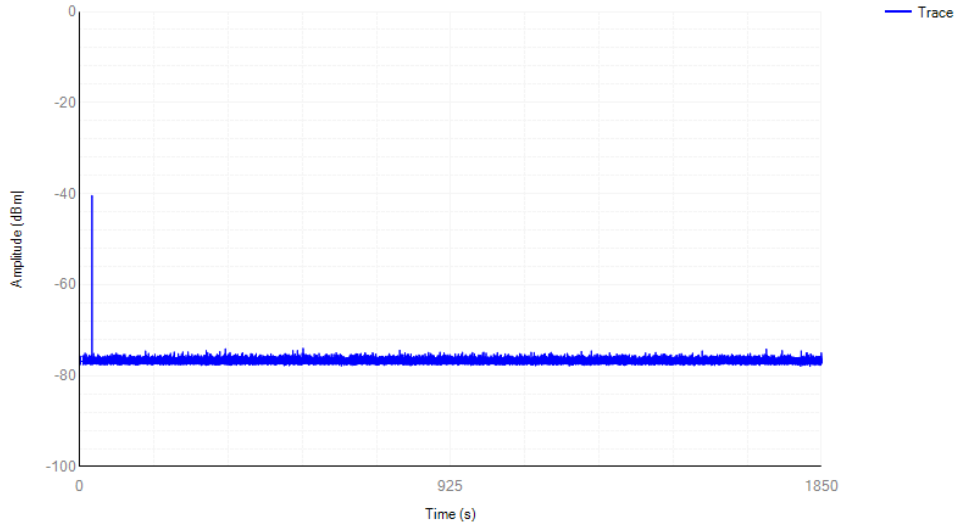

< a / 5500 MHz Non-Occupancy >

Non-Occupancy period

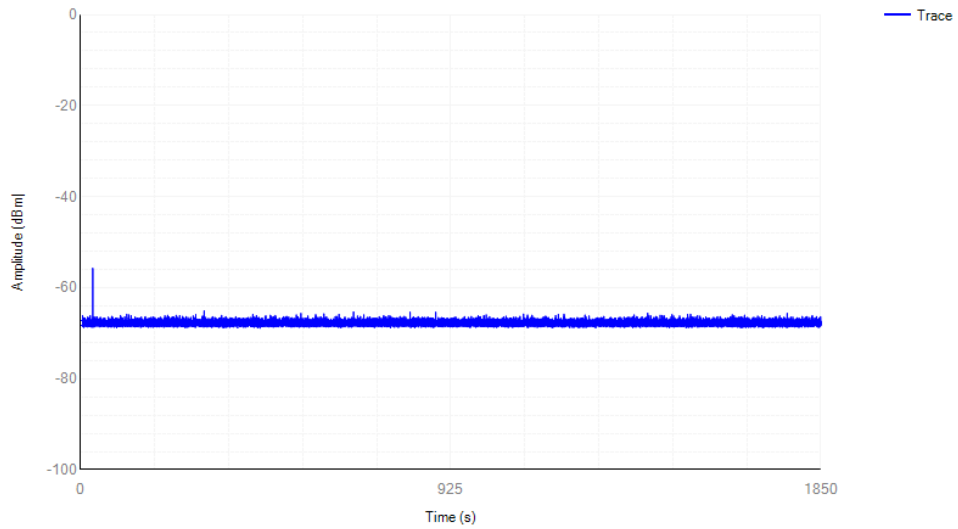

Note: All the test modes completed for test, the test data of this mode was reported.

-----END OF REPORT-----