

Mechanic Information

RX

Receiver CC3865

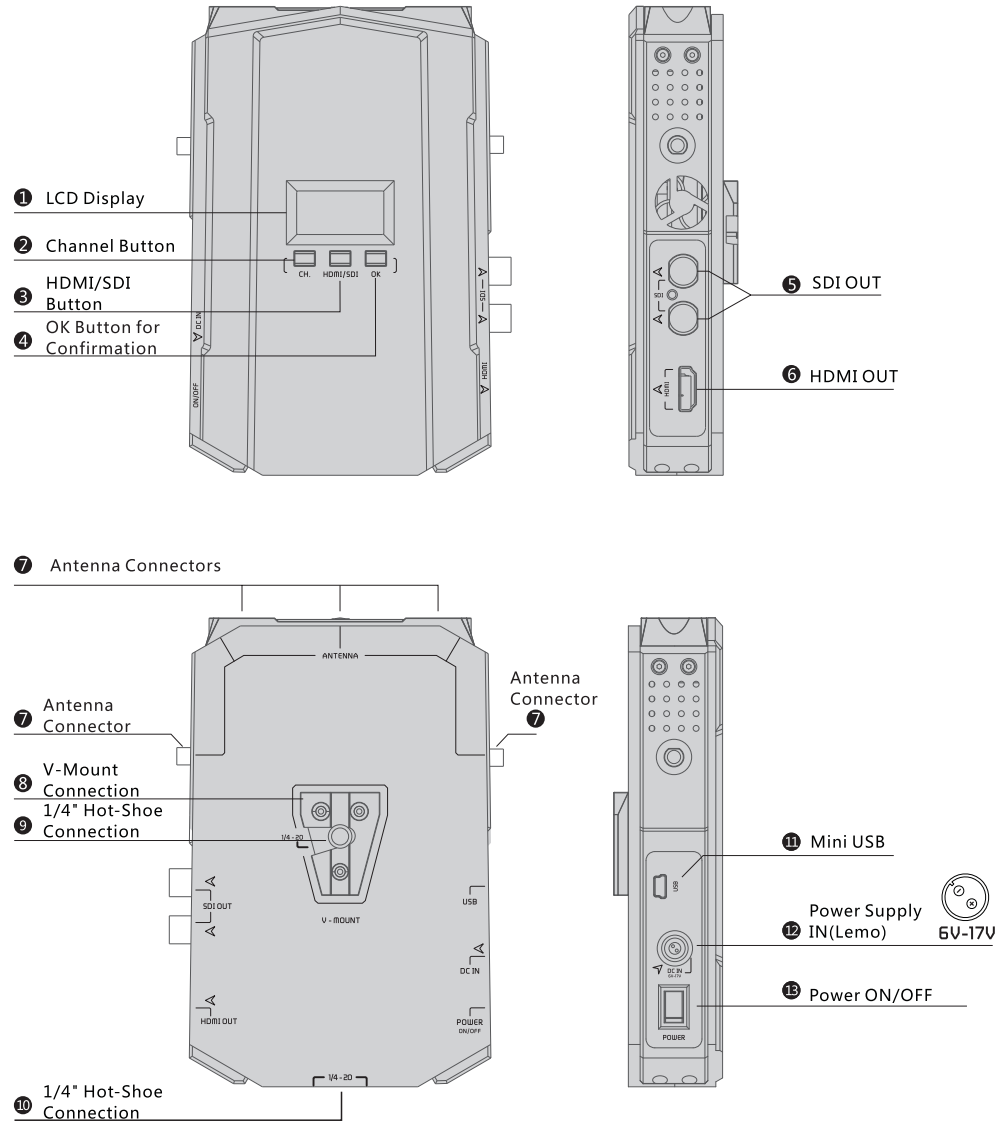

Structure	
1	LCD Display Displays information of Channel, input selection, signal status and battery capacity
2	Channel Select Button Select the same channel to TX
3	HDMI/SDI Button Select HDMI or SDI OUTPUT to the display device.
4	OK Button for Confirmation Confirm the Selection
5	SDI OUT Connect to the HD Digital Monitor which support 3G-SDI, HD-SDI
6	HDMI OUT Connect to the HD Display TV/Monitor with HDMI Input
7	Antenna Connectors RPSMA Connectors for Antennas
8	V-Mount Connection * Optional Support V-Mount Connection
9,10	1/4" Hot-shoe Connection Supports Hot-shoe Mounting
11	Mini USB For System Upgrading
12	Power Supply IN(Lemo) * Support 6-17V Support connecting to the power supply of the camera, or power adaptor Notice: BE AWARE OF POLARITY BEFORE APPLIES TO POWER SUPPLY!
13	Power ON/OFF Power ON/OFF

Installation

TX

For transmitter

1. Fix the antennas to the transmitter, and arrange them to be right angle as figured below to get better performance.

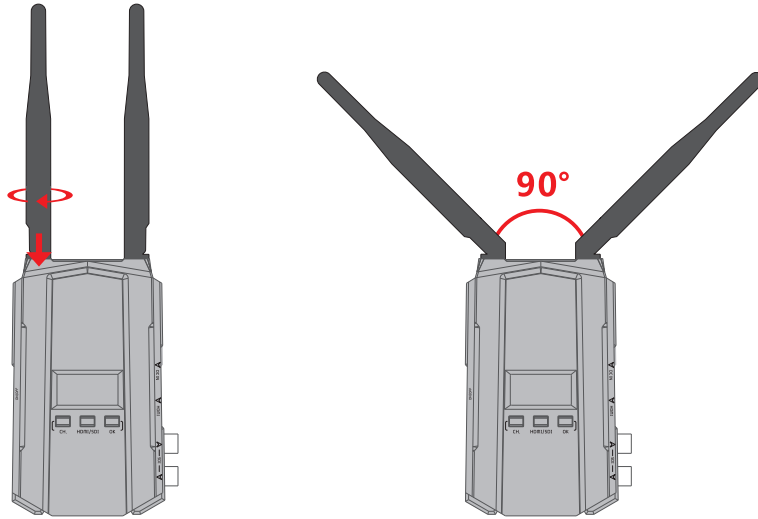

2. Connect the transmitter to the power supply. Connect the SDI/HDMI cable to the Video Source.

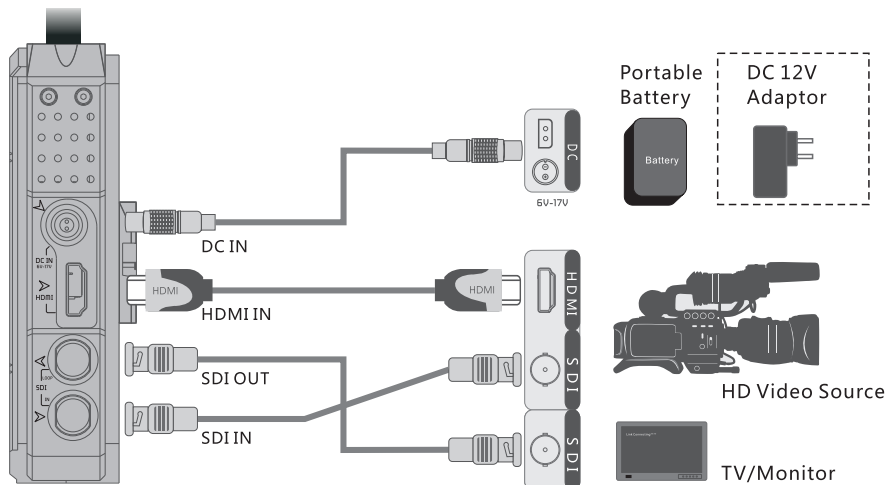

3. Turn ON the power supply and make sure the transmitter start to work.

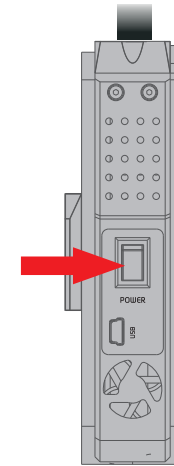

4. Press the "CH" button to select the wireless channel that corresponding to the Receiver, then press the "OK" button to confirm. When the video is transferred, the LCD Screen will display "VIDEO" .

Note: The devices support broadcasting mode as factory setting. User just need to set the TX & RX to the same channel and the RX device will be linked wirelessly to TX.

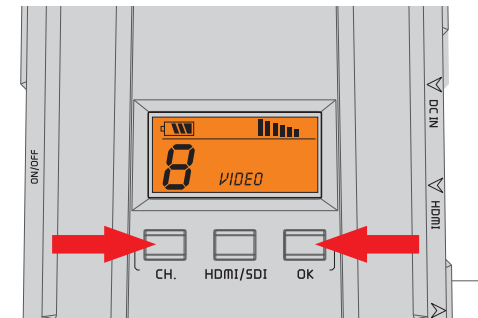

Installation

For Receiver

RX

1. Fix the antennas to the transmitter, and arrange them to be right angle as figured below to get better performance.

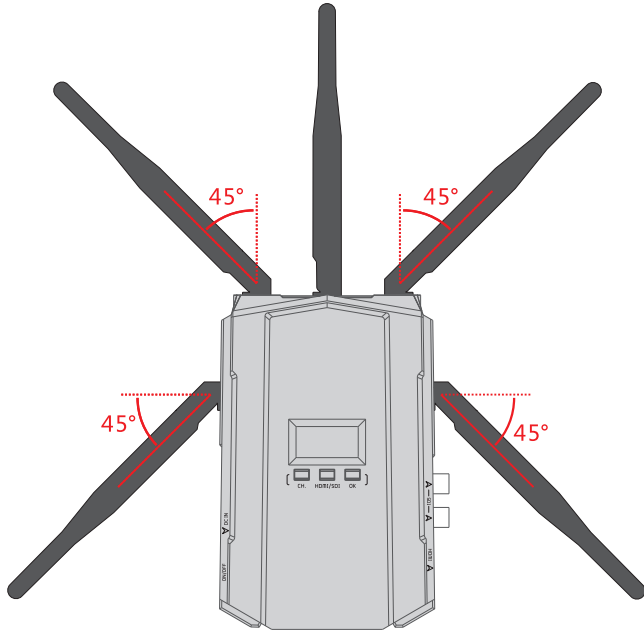

2. Connect the SDI/HDMI cable to the TV/Monitor.

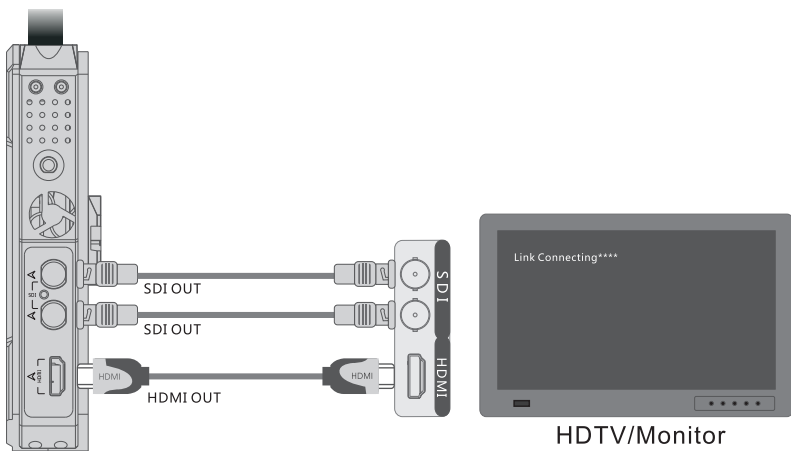

3. Connect the receiver to the power supply via the power cable. then turn ON the power supply and make sure the receiver start to work.

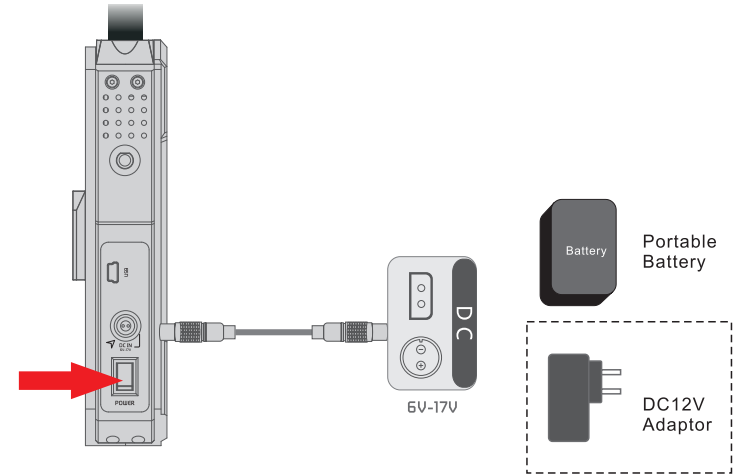

4. Press the "CH" button to select the wireless channel that be the same to the Transmitter, then press the "OK" button to confirm. When the Networking is connected, the LCD Screen will display "LINK" . When the video is transferred, the LCD Screen will display "VIDEO" ; Then the screen of TV/Monitor will display the HD images simultaneously from the video source.

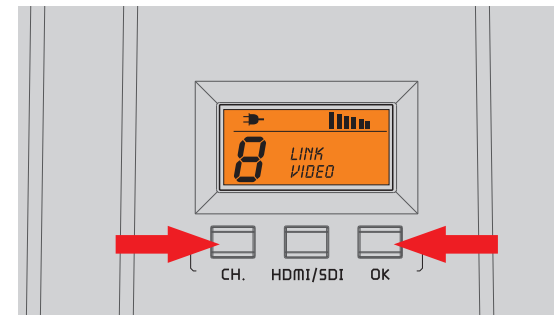

LCD Display

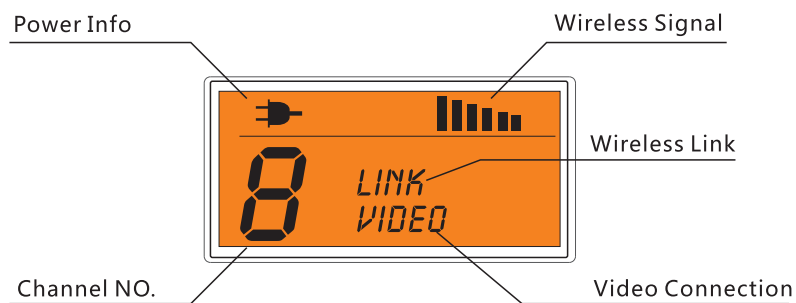

- Power Info: Display the current power supply status
- Channel NO.: Display the current Channel NO. of device
- Wireless Signal: Display the network signal strength
- LINK: LINK means the wireless connection is OK (* Only for RX)
- VIDEO: VIDEO means the video input/output is OK

Trouble Shooting

	Troubles & Possible Reasons:	Solutions:
OSD Information on TV	Displaying "Link Connecting..." for a long time	
	Transmitter is not powered up.	Power on the transmitter.
	Transmitter or receiver is not placed correctly.	Place the TX or RX correctly.
	The transmitter and receiver are too far away.	Move the receiver closer to the transmitter.
	Several solid wall partition TX and RX.	Reduce the number of solid walls between TX and RX.
	There are too many obstacles between TX and RX.	Move the receiver closer to the transmitter.
	Other transmitter is working on the same or adjacent channel	Turn off other transmitter, or change channel.
	No Video Signal received	
	Transmitter and video source are not connected.	Connect the transmitter to video source by SDI/HDMI cable.
	The video source is turned OFF.	Power ON the video source.
Video source were NOT switched to SDI/HDMI output.	Switch the Video source to SDI/HDMI output.	
Bad contact of cable of transmitter	Remove and then re-plug the cable of transmitter	
Abnormal working of transmitter	Reboot the transmitter.	
Problem with cable between TX and video source	Change the SDI/HDMI cable.	
Player NOT support the output resolution format.	Switch the output video resolution to other modes.	
The TV/Monitor NOT support HDCP authentication.	Replaced with HDCP-certified TV/Monitor.	
Image	No signal input to Receiver or TV/Monitor	
	Receiver is turned OFF.	Power on receiver.
	Receiver and TV are not connected.	Connect receiver to TV/Monitor via SDI/HDMI cable.
	TV/Monitor NOT switched to SDI/HDMI input.	Switch TV/Monitor to SDI/HDMI input.
	Bad contact of the cable of receiver or TV/monitor	Remove then re-plug the SDI/HDMI cable.
	TV/Monitor turn into standby mode	Switch the TV/Monitor to normal operation mode.
	Abnormal working of receiver.	Reboot the receiver.
	No image appear on TV/Monitor	
	Bad contact of receiver or cable.	Re-plug the cable of the receiver or TV/Monitor
	Abnormal working of receiver	Reboot the receiver
	Receiver failure	Please contact your retailer
	Abnormal color on TV screen	
	Bad contact of cable of receiver or TV/monitor.	Unplug and then plug the HDMI cable of the receiver or TV.
Bad contact of cable of transmitter or video source.	Unplug and then plug the HDMI cable of the TX and player.	
Abnormal working of transmitter or receiver	Reboot the transmitter and receiver.	

FCC Statement

This equipment has been tested and found to comply with the limits for a Class B digital device, pursuant to part 15 of the FCC rules. These limits are designed to provide reasonable protection against harmful interference in a residential installation. This equipment generates, uses and can radiate radio frequency energy and, if not installed and used in accordance with the instructions, may cause harmful interference to radio communications. However, there is no guarantee that interference will not occur in a particular installation. If this equipment does cause harmful interference to radio or television reception, which can be determined by turning the equipment off and on, the user is encouraged to try to correct the interference by one or more of the following measures:-Reorient or relocate the receiving antenna. Increase the separation between the equipment and receiver. Connect the equipment into an outlet on a circuit different from that to which the receiver is connected. Consult the dealer or an experienced radio/TV technician for help. To assure continued compliance, any changes or modifications not expressly approved by the party responsible for compliance could void the user's authority to operate this equipment. (Example use only shielded interface cables when connecting to computer or peripheral devices).

FCC Radiation Exposure Statement

This equipment complies with FCC RF radiation exposure limits set forth for an uncontrolled environment. This transmitter must not be co-located or operating in conjunction with any other antenna or transmitter. This equipment complies with Part 15 of the FCC Rules.

Operation is subject to the following two conditions:

- (1) This device may not cause harmful interference, and
- (2) This device must accept any interference received, including interference that may cause undesired operation.

Cautions!

The manufacturer is not responsible for any radio or TV interference caused by unauthorized modifications to this equipment. Such modifications could void the user authority to operate the equipment.

FCC Radiation Exposure Statement:

This equipment complies with FCC radiation exposure limits set forth for an uncontrolled environment. This equipment should be installed and operated with minimum distance 20cm between the radiator& your body.

This transmitter must not be co-located or operating in conjunction with any other antenna or transmitter.