



# FCC Radio Test Report

## FCC ID: Y3HCB880120110222

This report concerns (check one) :  Original Grant  Class II Change

**Issued Date** : Mar. 07, 2011  
**Project No.** : 1102C069  
**Equipment** : HD wireless video transmitter  
**Model Name** : CB8801; CV8801; 8801/6620; 8801/5801  
**Applicant** : Shenzhen Crystal Video Technology Co.,LTD  
**Address** : F13, F518 Idea Land, Baoyuan Road, Baoan Central Area, Shenzhen, China

**Tested by:**

Neutron Engineering Inc. EMC Laboratory

**Date of Receipt:** Feb. 22, 2011

**Date of Test:**

Feb. 22, 2011 ~ Mar. 06, 2011

Testing Engineer :

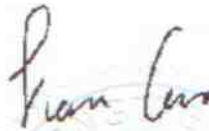
  
\_\_\_\_\_  
(Ivan Cao)

Technical Manager :

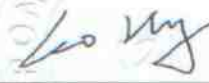
  
\_\_\_\_\_  
(Leo Hung)

Authorized Signatory :

  
\_\_\_\_\_  
(Steven Lu)

### Neutron Engineering Inc.

No.3, Jinshagang 1st Road, ShiXia, Dalang  
Town, Dong Guan, China.  
TEL : (0769) 8318-3000 FAX : (0769) 8319-6000



### **Declaration**

**Neutron** represents to the client that testing is done in accordance with standard procedures as applicable and that test instruments used has been calibrated with the standards traceable to National Measurement Laboratory (**NML**) of **CHINA**, or National Institute of Standards and Technology (**NIST**) of **U.S.A.**

**Neutron's** reports apply only to the specific samples tested under conditions. It is manufacture's responsibility to ensure that additional production units of this model are manufactured with the identical electrical and mechanical components. **Neutron** shall have no liability for any declarations, inferences or generalizations drawn by the client or others from **Neutron** issued reports.

**Neutron's** reports must not be used by the client to claim product endorsement by the authorities or any agency of the Government.

This report is the confidential property of the client. As a mutual protection to the clients, the public and **Neutron-self**, extracts from the test report shall not be reproduced except in full with **Neutron's** authorized written approval.

**Neutron's** laboratory quality assurance procedures are in compliance with the **ISO Guide 17025** requirements, and accredited by the conformity assessment authorities listed in this test report.

### **Limitation**

For the use of the authority's logo is limited unless the Test Standard(s)/Scope(s)/Item(s) mentioned in this test report is (are) included in the conformity assessment authorities acceptance respective.



<b>Table of Contents</b>	<b>Page</b>
<b>1 . CERTIFICATION</b>	<b>5</b>
<b>2 . SUMMARY OF TEST RESULTS</b>	<b>6</b>
2.1 TEST FACILITY	7
2.2 MEASUREMENT UNCERTAINTY	7
<b>3 . GENERAL INFORMATION</b>	<b>8</b>
3.1 GENERAL DESCRIPTION OF EUT	8
3.2 DESCRIPTION OF TEST MODES	10
3.3 TABLE OF PARAMETERS OF TEXT SOFTWARE SETTING	10
3.4 BLOCK DIGRAM SHOWING THE CONFIGURATION OF SYSTEM TESTED	11
3.5 DESCRIPTION OF SUPPORT UNITS	12
<b>4 . EMC EMISSION TEST</b>	<b>13</b>
4.1 CONDUCTED EMISSION MEASUREMENT	13
4.1.1 POWER LINE CONDUCTED EMISSION LIMITS	13
4.1.2 MEASUREMENT INSTRUMENTS LIST AND SETTING	13
4.1.3 TEST PROCEDURE	14
4.1.4 DEVIATION FROM TEST STANDARD	14
4.1.5 TEST SETUP	14
4.1.6 EUT OPERATING CONDITIONS	14
4.1.7 TEST RESULTS	15
4.2 RADIATED EMISSION MEASUREMENT	17
4.2.1 RADIATED EMISSION LIMITS	17
4.2.2 MEASUREMENT INSTRUMENTS LIST ANS SETTING	18
4.2.3 TEST PROCEDURE	19
4.2.4 DEVIATION FROM TEST STANDARD	19
4.2.5 TEST SETUP	20
4.2.6 EUT OPERATING CONDITIONS	20
4.2.7 TEST RESULTS (BETWEEN 30 – 1000 MHZ)	21
4.2.8 TEST RESULTS (ABOVE 1000 MHZ)	23
<b>5 . BANDWIDTH TEST</b>	<b>35</b>
5.1 APPLIED PROCEDURES / LIMIT	35
5.1.1 MEASUREMENT INSTRUMENTS LIST	35
5.1.2 TEST PROCEDURE	35
5.1.3 DEVIATION FROM STANDARD	35
5.1.4 TEST SETUP	35
5.1.5 EUT OPERATION CONDITIONS	35
5.1.6 TEST RESULTS	36



<b>Table of Contents</b>	<b>Page</b>
<b>6 . PEAK OUTPUT POWER TEST</b>	<b>38</b>
<b>6.1 APPLIED PROCEDURES / LIMIT</b>	<b>38</b>
6.1.1 MEASUREMENT INSTRUMENTS LIST	38
6.1.2 TEST PROCEDURE	38
6.1.3 DEVIATION FROM STANDARD	38
6.1.4 TEST SETUP	38
6.1.5 EUT OPERATION CONDITIONS	38
6.1.6 TEST RESULTS	39
<b>7 . ANTENNA CONDUCTED SPURIOUS EMISSION</b>	<b>41</b>
<b>7.1 APPLIED PROCEDURES / LIMIT</b>	<b>41</b>
7.1.1 MEASUREMENT INSTRUMENTS LIST	41
7.1.2 TEST PROCEDURE	41
7.1.3 DEVIATION FROM STANDARD	41
7.1.4 TEST SETUP	41
7.1.5 EUT OPERATION CONDITIONS	41
7.1.6 TEST RESULTS	42
<b>8 . POWER SPECTRAL DENSITY TEST</b>	<b>47</b>
<b>8.1 APPLIED PROCEDURES / LIMIT</b>	<b>47</b>
8.1.1 MEASUREMENT INSTRUMENTS LIST	47
8.1.2 TEST PROCEDURE	47
8.1.3 DEVIATION FROM STANDARD	47
8.1.4 TEST SETUP	47
8.1.5 EUT OPERATION CONDITIONS	47
8.1.6 TEST RESULTS	48
<b>9 . RF EXPOSURE TEST</b>	<b>52</b>
<b>10 . EUT TEST PHOTO</b>	<b>53</b>



## 1. CERTIFICATION

Equipment : HD wireless video transmitter  
Brand Name : N/A  
Model Name : CB8801; CV8801; 8801/6620; 8801/5801  
Applicant : Shenzhen Crystal Video Technology Co.,LTD  
Date of Test : Feb. 22, 2011 ~ Mar. 06, 2011  
Test Item : ENGINEERING SAMPLE  
Standards : FCC Part15, Subpart C(15.247) / ANSI C63.4 : 2003

The above equipment has been tested and found compliance with the requirement of the relative standards by Neutron Engineering Inc. EMC Laboratory.

The test data, data evaluation, and equipment configuration contained in our test report (Ref No. NEI-FCCP-1-1102C069) were obtained utilizing the test procedures, test instruments, test sites that has been accredited by the Authority of NVLAP and TAF according to the ISO-17025 quality assessment standard and technical standard(s).



## 2. SUMMARY OF TEST RESULTS

Test procedures according to the technical standards:

<b>FCC Part15 (15.247) , Subpart C</b>				
Standard	Section	Test Item	Judgment	Remark
15.207		Conducted Emission	PASS	
15.247(d)		Antenna conducted Spurious Emission	PASS	
15.247(a)(2)		6dB Bandwidth	PASS	
15.247(b)(3)		Peak Output Power	PASS	
15.209/15.205		Radiated Spurious Emission	PASS	
15.247(e)		Power Spectral Density	PASS	
15.203		Antenna Requirement	PASS	

**NOTE:**

(1) "N/A" denotes test is not applicable in this Test Report



**2.1 TEST FACILITY**

The test facilities used to collect the test data in this report is **DG-CB03/DG-C02** at the location of No.3, Jinshagang 1st Road, ShiXia, Dalang Town, Dong Guan, China.523792  
 Neutron's test firm number is 319330

**2.2 MEASUREMENT UNCERTAINTY**

Where relevant, the following measurement uncertainty levels have been estimated for tests performed on the EUT as specified in CISPR 16-4-2:

The reported uncertainty of measurement  $y \pm U$ , where expanded uncertainty U is based on a standard uncertainty multiplied by a coverage factor of  $k=2$ , providing a level of confidence of approximately 95 %.

**A. Conducted Measurement :**

Test Site	Method	Measurement Frequency Range	U , (dB)	NOTE
DG-C02	CISPR	150 KHz ~ 30MHz	1.94	

**B. Radiated Measurement :**

Test Site	Method	Measurement Frequency Range	Ant. H / V	U , (dB)	NOTE
DG-CB03	CISPR	30MHz ~ 200MHz	V	3.82	
		30MHz ~ 200MHz	H	3.60	
		200MHz ~ 1,000MHz	V	3.86	
		200MHz ~ 1,000MHz	H	3.94	



**3. GENERAL INFORMATION**

**3.1 GENERAL DESCRIPTION OF EUT**

Equipment	HD wireless video transmitter	
Brand Name	N/A	
Model Name	CB8801; CV8801; 8801/6620; 8801/5801	
OEM Brand/Model Name	N/A	
Model Difference	Only difference is Model name.	
Product Description	The EUT is a HD wireless video transmitter.	
	Operation Frequency:	5725~5850 MHz
	Modulation Type:	OFDM
	Bit Rate of Transmitter	3Gbps
	Number of Channel	3 CH, Please see Note 2. (please see page 9)
	Antenna Designation:	Please see Note 3.
	Antenna Gain(Peak)	(please see page 9)
	Conducted Peak Output Power:	11.33 dBm-ANT1 11.14 dBm-ANT2 14.56 dBm-Total (ANT1+ANT2)
	Conducted Average Output Power:	4.54 dBm-ANT1 2.25 dBm-ANT2 4.92 dBm-Total (ANT1+ANT2)
		Based on the application, features, or specification exhibited in User's Manual, the EUT is considered as an ITE/Computing Device. More details of EUT technical specification, please refer to the User's Manual.
Power Source	#1 DC Voltage supplied from AC/DC adapter. Brand name:KUANTEN Model name:SSA051F050100USU	
Power Rating	#1 I/P AC 100-240V~50/60Hz 0.2A O/P DC 5V 1A	
Connecting I/O Port(s)	Please refer to the User's Manual	
Products Covered	N/A	

Note:

1. For a more detailed features description, please refer to the manufacturer's specifications or the User's Manual.





2.

Channel	Frequency (MHz)	Channel	Frequency (MHz)	Channel	Frequency (MHz)
01	5750	02	5785	03	5825

3.

Table for Filed Antenna

Ant.	Brand	Model Name	Antenna Type	Connector	Gain (dBi)
1	Jiaxing Jiali	LA5220P5510-A15	Multi-layer Ceramics	N/A	2.0



**3.2 DESCRIPTION OF TEST MODES**

To investigate the maximum EMI emission characteristics generates from EUT, the test system was pre-scanning tested base on the consideration of following EUT operation mode or test configuration mode which possible have effect on EMI emission level. Each of these EUT operation mode(s) or test configuration mode(s) mentioned above was evaluated respectively.

Pretest Mode	Description
Mode 1	TX MODE CHANNEL 01//02/03
Mode 2	Normal Link

The EUT system operated these modes were found to be the worst case during the pre-scanning test as Following:

For Conducted Test	
Final Test Mode	Description
Mode 2	Normal Link

For Radiated Test	
Final Test Mode	Description
Mode 1	TX MODE CHANNEL 01//02/03

Note:

- (1) The measurements are performed at the highest, middle, lowest available channels.

**3.3 TABLE OF PARAMETERS OF TEXT SOFTWARE SETTING**

During testing channel & power controlling software provided by the customer was used to control the operating channel as well as the output power level. The RF output power selection is for the setting of RF output power expected by the customer and is going to be fixed on the firmware of the final end product

Test software Version	Appcom		
Frequency	5750 MHz	5785 MHz	5825 MHz
	1	1	1



**3.4 BLOCK DIGRAM SHOWING THE CONFIGURATION OF SYSTEM TESTED**

Radiated Mode:

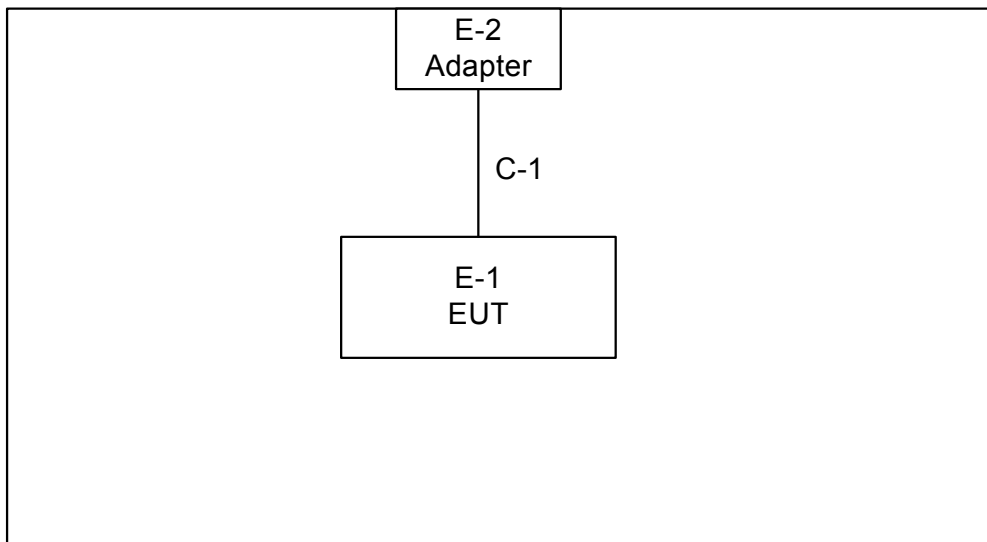

C-1: DC Cable



**3.5 DESCRIPTION OF SUPPORT UNITS**

The EUT has been tested as an independent unit together with other necessary accessories or support units. The following support units or accessories were used to form a representative test configuration during the tests.

Item	Equipment	Mfr/Brand	Model/Type No.	FCC ID	Series No.	Note
E-1	HD wireless video transmitter	N/A	CB8801	Y3HCB8801201 10222	N/A	EUT
E-2	Adapter	KUANTEN	SSA051F050 100USU	N/A	N/A	

Item	Shielded Type	Ferrite Core	Length	Note
C-1	YES	NO	0.8M	

Note:

- (1) The support equipment was authorized by Declaration of Confirmation.
- (2) For detachable type I/O cable should be specified the length in cm in 『Length』 column.



**4. EMC EMISSION TEST**

**4.1 CONDUCTED EMISSION MEASUREMENT**

**4.1.1 POWER LINE CONDUCTED EMISSION Limits (Frequency Range 150KHz-30MHz)**

FREQUENCY (MHz)	Class A (dBuV)		Class B (dBuV)		Standard
	Quasi-peak	Average	Quasi-peak	Average	
0.15 -0.5	79.00	66.0	66 - 56 *	56 - 46 *	CISPR
0.50 -5.0	73.00	60.00	56.00	46.00	CISPR
5.0 -30.0	73.00	60.00	60.00	50.00	CISPR

0.15 -0.5	79.00	66.00	66 - 56 *	56 - 46 *	FCC
0.50 -5.0	73.00	60.00	56.00	46.00	FCC
5.0 -30.0	73.00	60.00	60.00	50.00	FCC

Note:

- (1) The tighter limit applies at the band edges.
- (2) The limit of " \* " marked band means the limitation decreases linearly with the logarithm of the frequency in the range.

**4.1.2 MEASUREMENT INSTRUMENTS LIST AND SETTING**

Item	Kind of Equipment	Manufacturer	Type No.	Serial No.	Calibrated until
1	LISN	EMCO	3816/2	00052765	May.26.2011
2	LISN	Rolf Heine	NNB-2-16Z	99044	May.26.2011
3	50Ω Terminator	SHX	TF2-3G-A	08122901	May.26.2011
4	Transient Limiter	Agilent	11947A	3107A03668	May.26.2011
5	Test Cable	N/A	C-06_C03	N/A	Nov.15.2011
6	Test Receiver	R&S	ESCI	100382	May.26.2011

Remark: " N/A" denotes No Model Name. , Serial No. or No Calibration specified.

The following table is the setting of the receiver

Receiver Parameters	Setting
Attenuation	10 dB
Start Frequency	0.15 MHz
Stop Frequency	30 MHz
IF Bandwidth	9 kHz

#### 4.1.3 TEST PROCEDURE

- a. The EUT was placed 0.8 meters from the horizontal ground plane with EUT being connected to the power mains through a line impedance stabilization network (LISN). All other support equipments powered from additional LISN(s). The LISN provide 50 Ohm/ 50uH of coupling impedance for the measuring instrument.
- b. Interconnecting cables that hang closer than 40 cm to the ground plane shall be folded back and forth in the center forming a bundle 30 to 40 cm long.
- c. I/O cables that are not connected to a peripheral shall be bundled in the center. The end of the cable may be terminated, if required, using the correct terminating impedance. The overall length shall not exceed 1 m.
- d. LISN at least 80 cm from nearest part of EUT chassis.
- e. For the actual test configuration, please refer to the related Item –EUT Test Photos.

#### 4.1.4 DEVIATION FROM TEST STANDARD

No deviation

#### 4.1.5 TEST SETUP

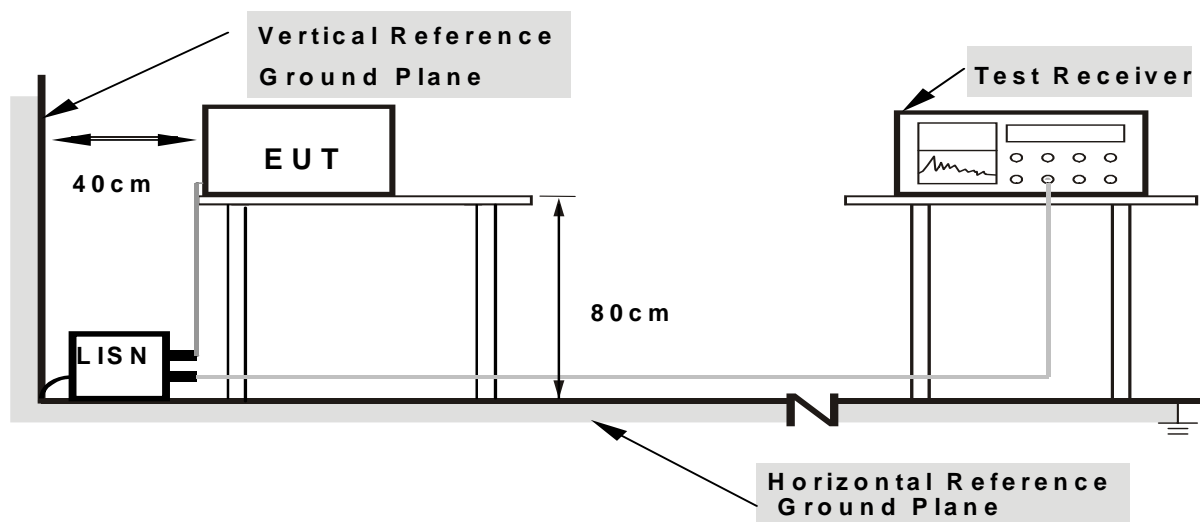

**Note: 1. Support units were connected to second LISN.**

**2. Both of LISNs (AMN) are 80 cm from EUT and at least 80 from other units and other metal planes**

#### 4.1.6 EUT OPERATING CONDITIONS

The EUT was configured for testing in a typical fashion (as a customer would normally use it). The EUT has been programmed to continuously transmit during test. This operating condition was tested and used to collect the included data.

The EUT was programmed to be in continuously transmitting mode.



**4.1.7 TEST RESULTS**

EUT :	HD wireless video transmitter	Model Name :	CB8801
Temperature :	21 °C	Relative Humidity :	50 %
Pressure :	1010hPa	Test Power :	AC 120V/60Hz
Test Mode :	Mode 2		

Freq. (MHz)	Terminal L/N	Measured(dBuV)		Limits(dBuV)		Margin (dB)	Note
		QP-Mode	AV-Mode	QP-Mode	AV-Mode		
0.40	Line	51.40	39.61	57.93	47.93	-6.53	(QP)
0.49	Line	52.94	44.14	56.24	46.24	-2.10	(AV)
0.60	Line	49.77	34.74	56.00	46.00	-6.23	(QP)
0.87	Line	49.72	34.27	56.00	46.00	-6.28	(QP)
1.03	Line	51.32	33.57	56.00	46.00	-4.68	(QP)
2.70	Line	48.84	31.34	56.00	46.00	-7.16	(QP)

**Remark**

- (1) All readings are QP Mode value unless otherwise stated AVG in column of 'Note'. If the QP Mode Measured value compliance with the QP Limits and lower than AVG Limits, the EUT shall be deemed to meet both QP & AVG Limits and then only QP Mode was measured, but AVG Mode didn't perform. In this case, a "\*" marked in AVG Mode column of Interference Voltage Measured.
- (2) Measuring frequency range from 150KHz to 30MHz.

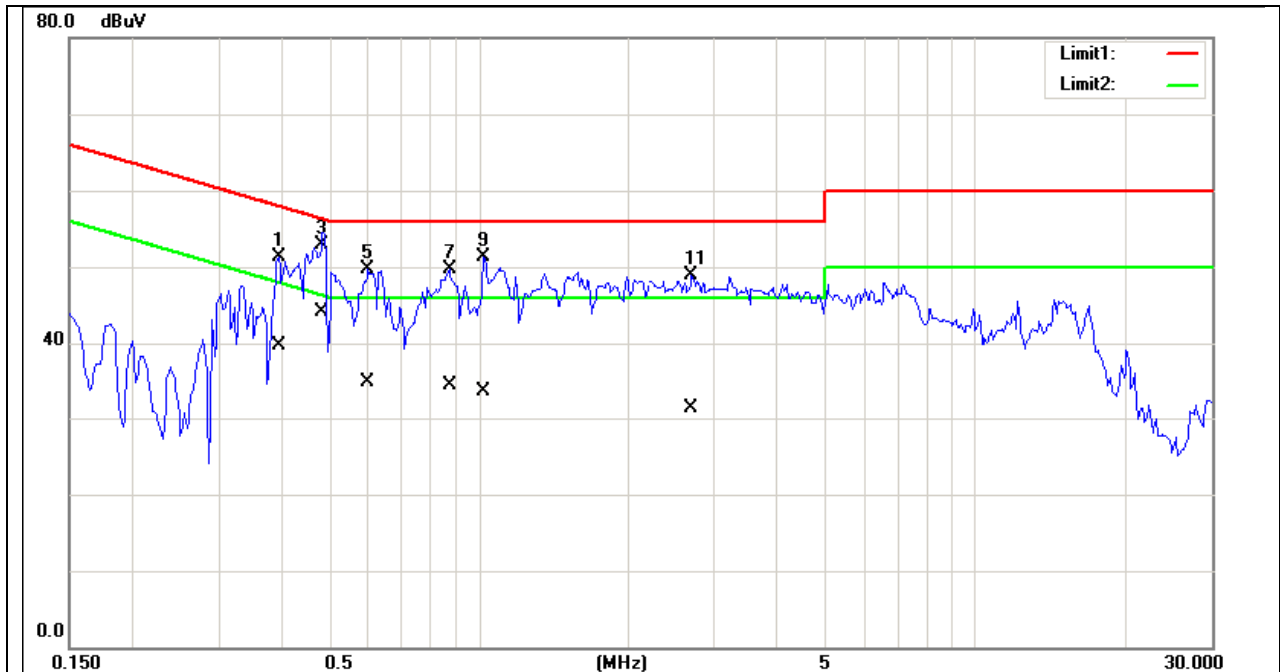



EUT :	HD wireless video transmitter	Model Name :	CB8801
Temperature :	21 °C	Relative Humidity :	50 %
Pressure :	1010hPa	Test Power :	AC 120V/60Hz
Test Mode :	Mode 2		

Freq. (MHz)	Terminal L/N	Measured(dBuV)		Limits(dBuV)		Margin (dB)	Note
		QP-Mode	AV-Mode	QP-Mode	AV-Mode		
0.40	Neutral	51.33	36.78	57.94	47.94	-6.61	(QP)
0.47	Neutral	52.83	30.39	56.44	46.44	-3.61	(QP)
0.60	Neutral	49.89	36.80	56.00	46.00	-6.11	(QP)
0.87	Neutral	49.71	30.82	56.00	46.00	-6.29	(QP)
1.11	Neutral	50.39	30.23	56.00	46.00	-5.61	(QP)
1.35	Neutral	49.17	28.54	56.00	46.00	-6.83	(QP)

**Remark**

- (1) All readings are QP Mode value unless otherwise stated AVG in column of 'Note'. If the QP Mode Measured value compliance with the QP Limits and lower than AVG Limits, the EUT shall be deemed to meet both QP & AVG Limits and then only QP Mode was measured, but AVG Mode didn't perform. In this case, a "\*" marked in AVG Mode column of Interference Voltage Measured.
- (2) Measuring frequency range from 150KHz to 30MHz.

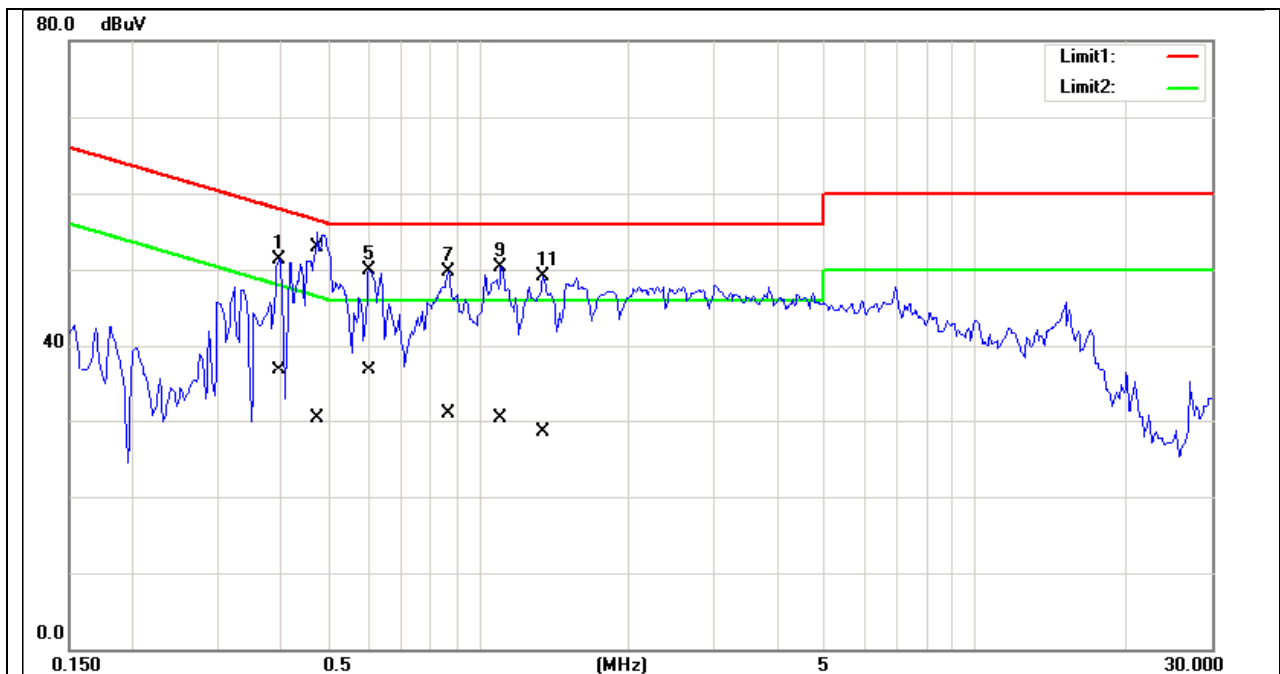





**4.2 RADIATED EMISSION MEASUREMENT**

**4.2.1 RADIATED EMISSION LIMITS (Frequency Range 9KHz-1000MHz)**

20dBc in any 100 kHz bandwidth outside the operating frequency band. In case the emission fall within the restricted band specified on 15.205(a), then the 15.209(a) limit in the table below has to be followed.

Frequencies (MHz)	Field Strength (micorvolts/meter)	Measurement Distance (meters)
0.009~0.490	2400/F(KHz)	300
0.490~1.705	24000/F(KHz)	30
1.705~30.0	30	30
30~88	100	3
88~216	150	3
216~960	200	3
Above 960	500	3

**LIMITS OF RADIATED EMISSION MEASUREMENT (Above 1000MHz)**

FREQUENCY (MHz)	(dBuV/m) (at 1.5m)	
	PEAK	AVERAGE
Above 1000	80	60

Notes:

- (1) The limit for radiated test was performed according to FCC PART 15C.
- (2) The tighter limit applies at the band edges.
- (3) Emission level (dBuV/m)=20log Emission level (uV/m).  
 The limits above 5GHz shall be extrapolated to the specified distance using an extrapolation factor of 20dB/decade form 3m to 1.5m  
 Distance extrapolation factor = 20 log (3m/1.5m) dB ;  
 Limit line = specific limits (dBuV) + 6 dB

**FREQUENCY RANGE OF RADIATED MEASUREMENT (For unintentional radiators)**

Highest frequency generated or Upper frequency of measurement used in the device or on which the device operates or tunes (MHz)	Range (MHz)
Below 1.705	30
1.705 – 108	1000
108 – 500	2000
500 – 1000	5000
Above 1000	5 <sup>th</sup> harmonic of the highest frequency or 40 GHz, whichever is lower



**4.2.2 MEASUREMENT INSTRUMENTS LIST AND SETTING**

Item	Kind of Equipment	Manufacturer	Type No.	Serial No.	Calibrated until
1	Triple Loop Antenna	R&S	HFH2-Z2	830749/020	May.27.2011
2	Bi-log Antenna	Schwarzbeck	VULB9160	9160-3232	May.26.2011
3	Horn Antenna	ETS	3115	00075789	May.12.2011
4	Broad-Band Horn Antenna	Schwarzbeck	BBHA 9170	9170340	Dec.14.2011
5	Amplifier	HP	8447D	2944A09673	May.26.2011
6	Amplifier	Agilent	8449B	3008A02274	May.26.2011
7	Amplifier	EMC	EMC265404 5	980039	Aug.12.2011
8	Test Receiver	R&S	ESCI	100895	May.26.2011
9	Spectrum Analyzer	R&S	FSP 40	100185	Nov.26.2011
10	Test Cable	N/A	C-01_CB03	N/A	Jul.05.2011
11	Test Cable	HUBER+SUHNER	SUCOFLEX_ 8m	313794/4	Apr.12.2011
12	Controller	CT	SC100	N/A	N/A

Remark: " N/A" denotes No Model Name / Serial No. and No Calibration specified.

Spectrum Parameter	Setting
Attenuation	Auto
Start Frequency	1000 MHz
Stop Frequency	10th carrier harmonic
RB / VB (Emission in restricted band)	1MHz / 1MHz for Peak, 1 MHz / 10Hz for Average

Receiver Parameter	Setting
Attenuation	Auto
Start ~ Stop Frequency	9kHz~150kHz / RB 200Hz for QP
Start ~ Stop Frequency	150kHz~30MHz / RB 9kHz for QP
Start ~ Stop Frequency	30MHz~1000MHz / RB 120kHz for QP



#### **4.2.3 TEST PROCEDURE**

- a. The measuring distance of at 3 m shall be used for measurements at frequency up to 1GHz. For frequencies above 1GHz, any suitable measuring distance may be used.
- b. The EUT was placed on the top of a rotating table 0.8 meters above the ground at a 3 meter semi-anechoic chamber. The table was rotated 360 degrees to determine the position of the highest radiation.
- c. The height of the equipment or of the substitution antenna shall be 0.8 m; the height of the test antenna shall vary between 1 m to 4 m. Both horizontal and vertical polarizations of the antenna are set to make the measurement.
- d. The initial step in collecting conducted emission data is a spectrum analyzer peak detector mode pre-scanning the measurement frequency range. Significant peaks are then marked and then Quasi Peak detector mode re-measured.
- e. If the Peak Mode measured value compliance with and lower than Quasi Peak Mode Limit, the EUT shall be deemed to meet QP Limits and then no additional QP Mode measurement performed.
- f. For the actual test configuration, please refer to the related Item –EUT Test Photos.

#### **4.2.4 DEVIATION FROM TEST STANDARD**

No deviation

**4.2.5 TEST SETUP**

(A) Radiated Emission Test Set-Up Frequency Below 1 GHz

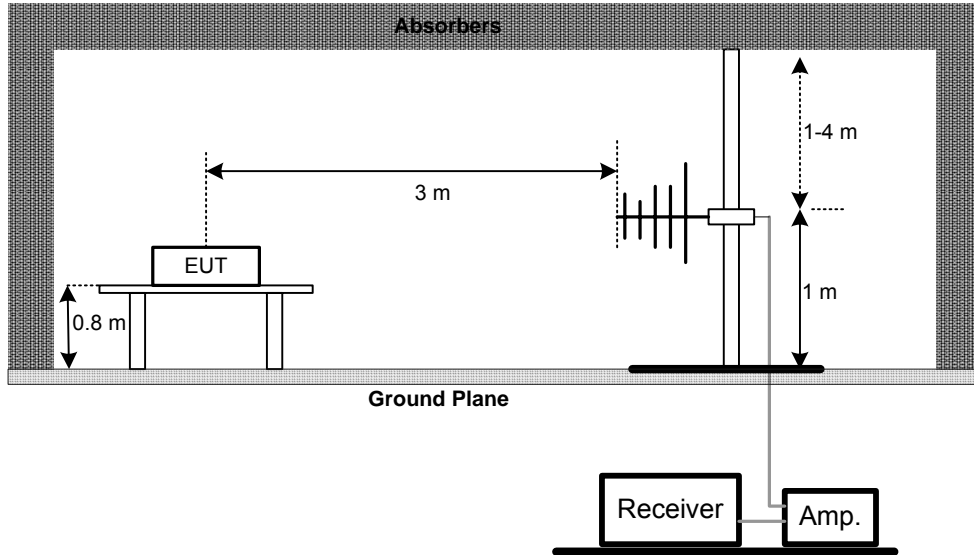

(B) Radiated Emission Test Set-Up Frequency Above 1 GHz

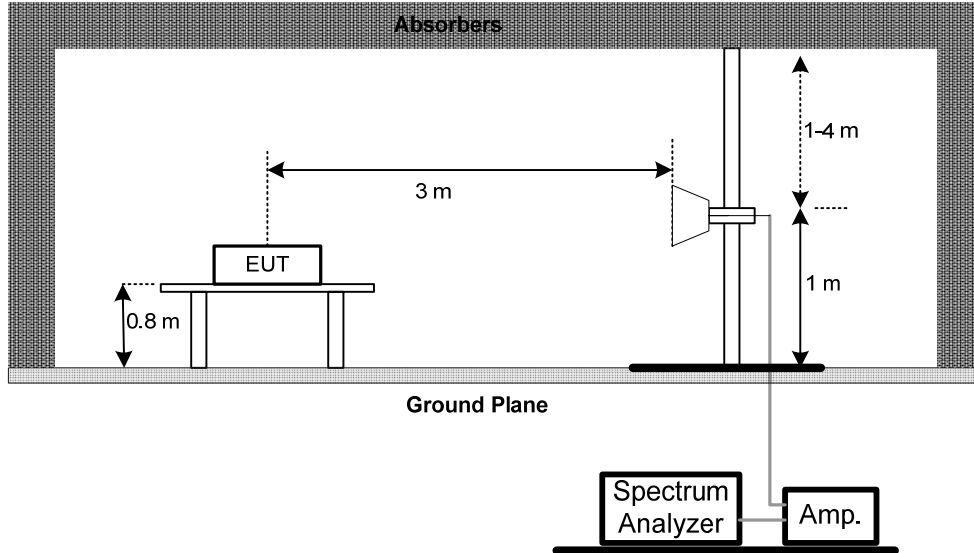

**4.2.6 EUT OPERATING CONDITIONS**

The EUT tested system was configured as the statements of 4.1.6 Unless otherwise a special operating condition is specified in the follows during the testing.



**4.2.7 TEST RESULTS (BETWEEN 30 – 1000 MHZ)**

EUT :	HD wireless video transmitter	Model Name :	CB8801
Temperature :	23 °C	Relative Humidity :	51 %
Pressure :	1010 hPa	Test Voltage :	AC 120V/60Hz
Test Mode :	TX MODE 5750MHz		

Freq. (MHz)	Ant. H/V	Reading(RA) (dBuV)	Corr.Factor(CF) (dB)	Measured(FS) (dBuV/m)	Limits(QP) (dBuV/m)	Margin (dB)	Note
53.68	V	41.15	-17.51	23.64	40.00	- 16.36	
98.76	V	46.89	-18.42	28.47	43.50	- 15.03	
134.29	V	43.71	-17.95	25.76	43.50	- 17.74	
189.65	V	47.82	-16.73	31.09	43.50	- 12.41	
237.08	V	47.45	-15.30	32.15	46.00	- 13.85	
298.11	V	40.56	-12.07	28.49	46.00	- 17.51	

**Remark :**

- (1) Reading in which marked as QP or Peak means measurements by using are Quasi-Peak Mode or Peak Mode with Detector BW=120KHz ; SPA setting in RBW=120KHz, VBW =120KHz, Swp. Time = 0.3 sec./MHz ◦
- (2) All readings are Peak unless otherwise stated QP in column of 『Note』 . Peak denotes that the Peak reading compliance with the QP Limits and then QP Mode measurement didn't perform ◦
- (3) Measuring frequency range from 30MHz to 1000MHz ◦
- (4) If the peak scan value lower limit more than 20dB, then this signal data does not show in table ◦

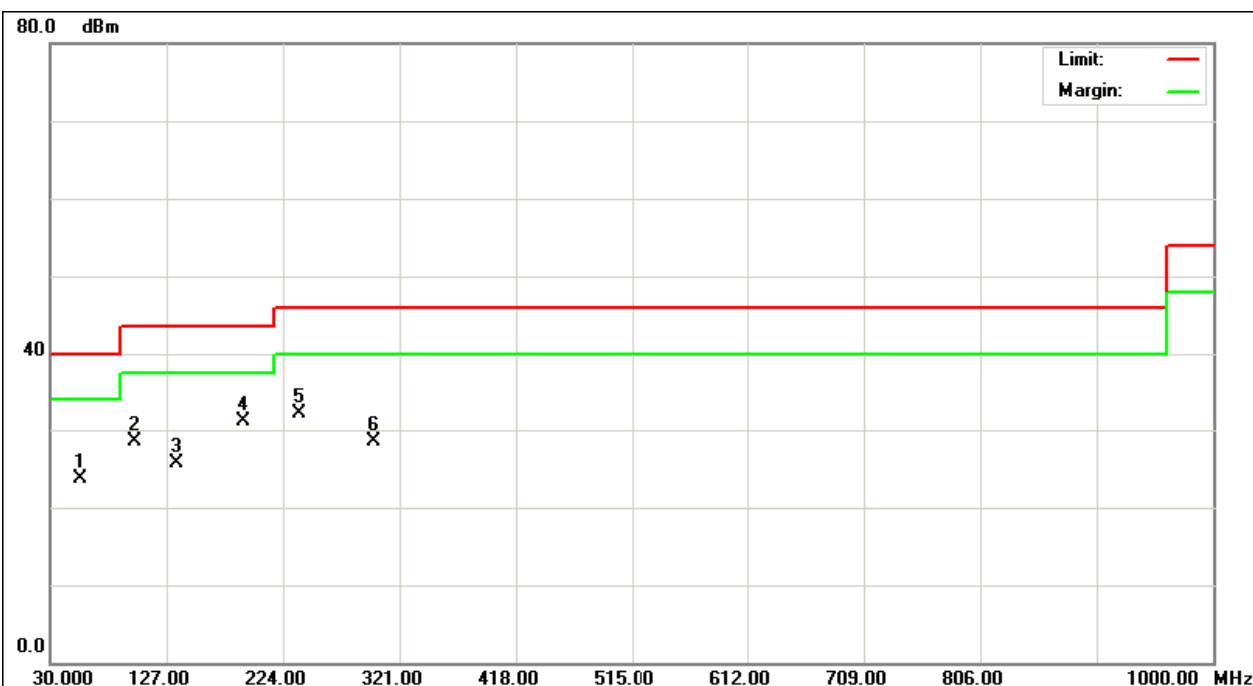



EUT :	HD wireless video transmitter	Model Name :	CB8801
Temperature :	23 °C	Relative Humidity :	51 %
Pressure :	1010 hPa	Test Voltage :	AC 120V/60Hz
Test Mode :	TX MODE 5750MHz		

Freq. (MHz)	Ant. H/V	Reading(RA) (dBuV)	Corr.Factor(CF) (dB)	Measured(FS) (dBuV/m)	Limits(QP) (dBuV/m)	Margin (dB)	Note
43.52	H	39.31	-16.87	22.44	40.00	- 17.56	
86.78	H	46.96	-19.10	27.86	40.00	- 12.14	
153.22	H	43.99	-17.58	26.41	43.50	- 17.09	
196.85	H	41.58	-16.62	24.96	43.50	- 18.54	
231.76	H	47.51	-15.54	31.97	46.00	- 14.03	
297.46	H	42.78	-12.06	30.72	46.00	- 15.28	

**Remark :**

- (1) Reading in which marked as QP or Peak means measurements by using are Quasi-Peak Mode or Peak Mode with Detector BW=120KHz ; SPA setting in RBW=120KHz, VBW =120KHz, Swp. Time = 0.3 sec./MHz ◦
- (2) All readings are Peak unless otherwise stated QP in column of 『Note』 . Peak denotes that the Peak reading compliance with the QP Limits and then QP Mode measurement didn't perform ◦
- (3) Measuring frequency range from 30MHz to 1000MHz ◦
- (4) If the peak scan value lower limit more than 20dB, then this signal data does not show in table ◦

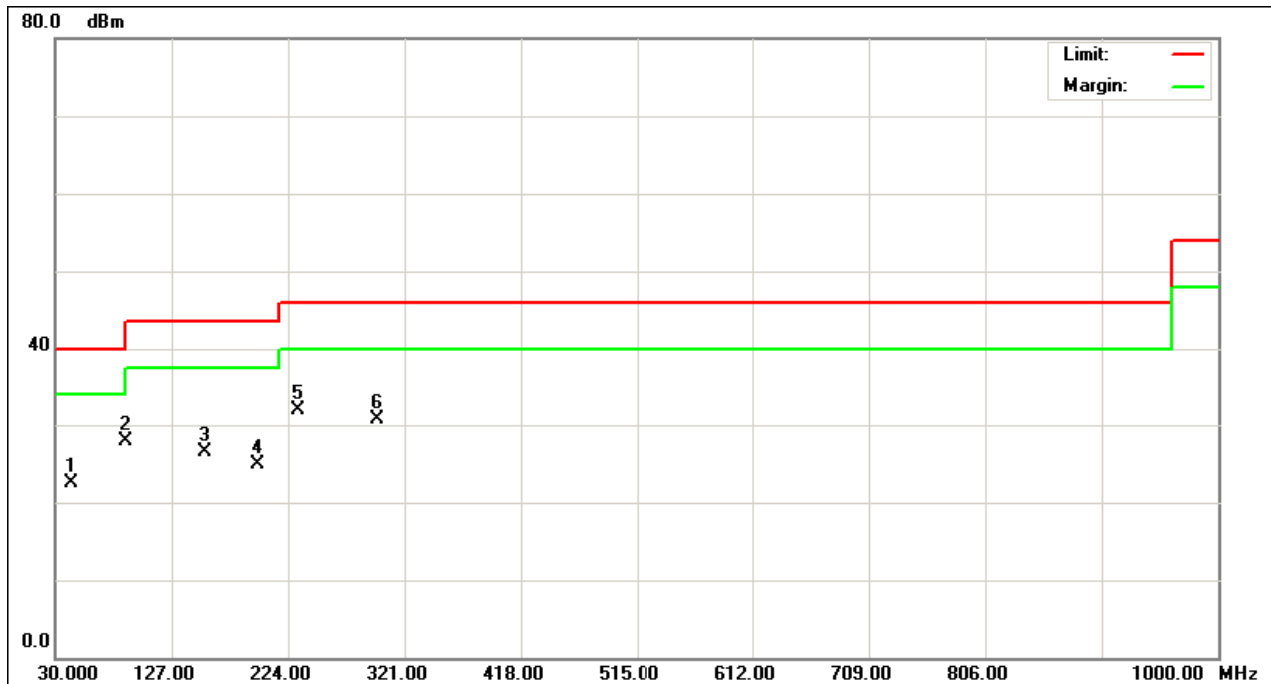



**4.2.8 TEST RESULTS (ABOVE 1000 MHZ)**

EUT :	HD wireless video transmitter	Model Name :	CB8801
Temperature :	20 °C	Relative Humidity :	50 %
Pressure :	1010 hPa	Test Voltage :	AC 120V/60Hz
Test Mode :	TX MODE 5750MHz		

Freq. (MHz)	Ant.Pol. HV	Reading		Ant./CF CF(dB)	Act.		Limit		Note
		Peak (dBuV)	AV (dBuV)		Peak (dBuV/m)	AV (dBuV/m)	Peak (dBuV/m)	AV (dBuV/m)	
5725.00	V	34.32	15.82	40.90	75.22	56.72	80.00	60.00	X/E
<b>5764.00</b>	<b>V</b>	<b>60.81</b>	<b>42.15</b>	<b>41.05</b>	<b>101.86</b>	<b>83.08</b>			<b>X/F</b>
11500.39	V	53.56	41.87	13.29	66.85	55.16	80.00	60.00	X/H

Remark :

- (1) All readings are Peak unless otherwise stated QP in column of 『Note』 . Peak denotes that the Peak reading compliance with the QP Limits and then QP Mode measurement didn't perform ◦
- (2) Measuring frequency range from 30MHz to 1000MHz or the 10th harmonic of highest fundamental frequency ◦ "F" denotes fundamental frequency; "H" denotes spurious frequency. "E" denotes band edge frequency. (This judgment method includes the Band Edge Requirement.)
- (3) Radiated emissions measured in frequency range above 1000MHz were made with an instrument using Peak detector mode and AV detector mode of the emission ◦
- (4) Data of measurement within this frequency range shown " \* " in the table above means the reading of emissions are attenuated more than 20dB below the permissible limits or the field strength is too small to be measured.
- (5) A preamp and high pass filter were used for this test in order to provide sufficient measurement sensitivity.
- (6) EUT Orthogonal Axis :  
"X" - denotes Laid on Table ; "Y" - denotes Vertical Stand ; "Z" - denotes Side Stand
- (7) During the measurements above 1 GHz it is taken care of that the EUT is always within the 3 dB cone of radiation BW of the used antenna
- (8) The limits above 5GHz shall be extrapolated to the specified distance using an extrapolation factor of 20dB/decade form 3m to 1.5m  
Distance extrapolation factor =  $20 \log (3m/1.5m)$  dB ;  
Limit line = specific limits (dBuV) + 6 dB



TX CH01 (Above 1000 MHz, Vertical)

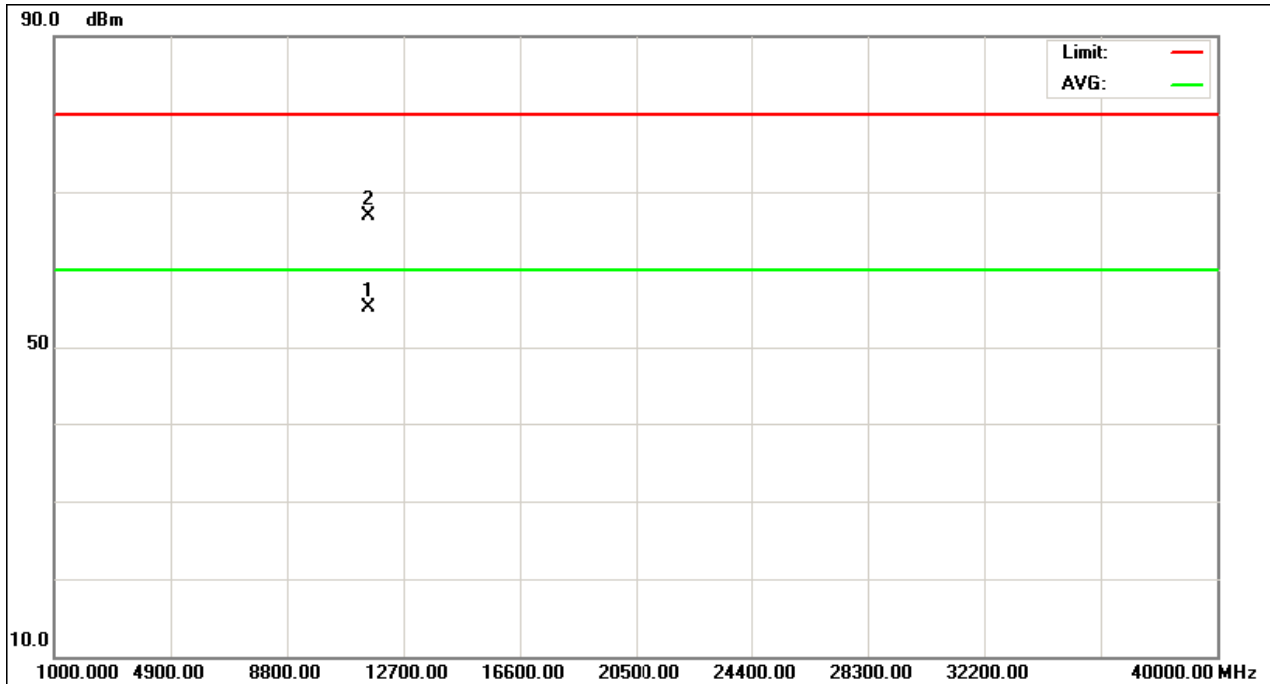
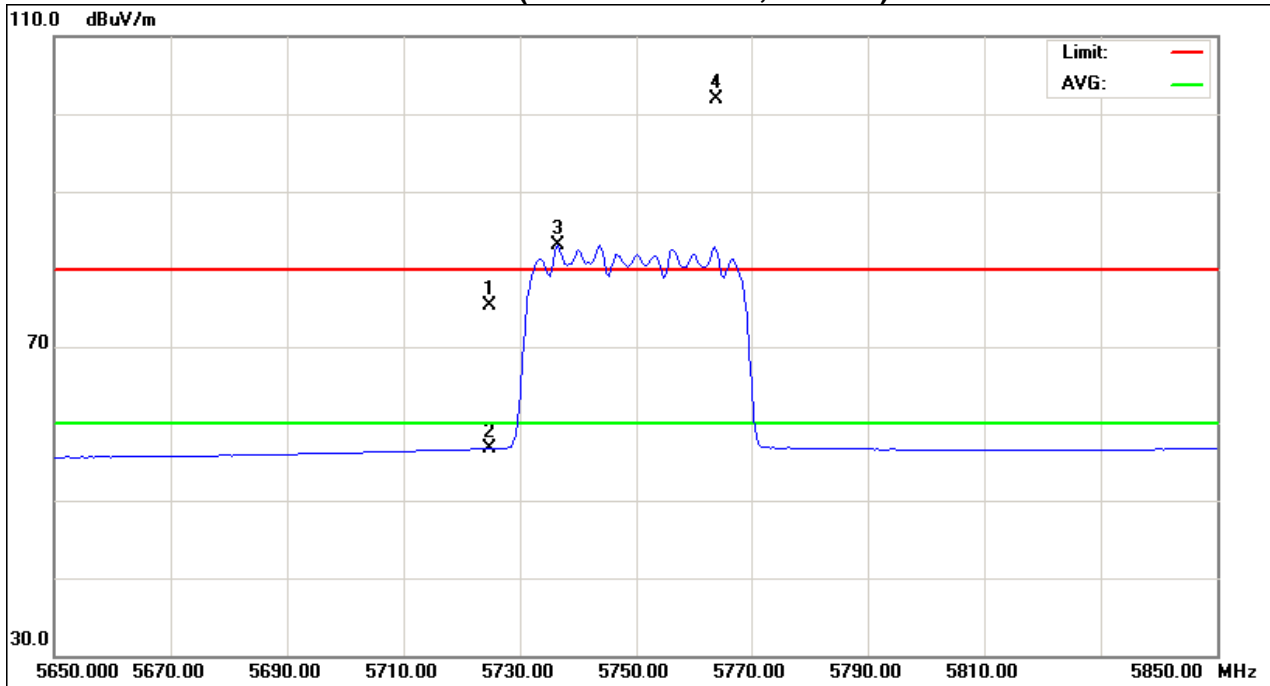





EUT :	HD wireless video transmitter	Model Name :	CB8801
Temperature :	20 °C	Relative Humidity :	50 %
Pressure :	1010 hPa	Test Voltage :	AC 120V/60Hz
Test Mode :	TX MODE 5750MHz		

Freq. (MHz)	Ant.Pol. HV	Reading		Ant./CF CF(dB)	Act.		Limit		Note
		Peak (dBuV)	AV (dBuV)		Peak (dBuV/m)	AV (dBuV/m)	Peak (dBuV/m)	AV (dBuV/m)	
5725.00	H	25.79	15.78	40.90	66.69	56.68	80.00	60.00	X/E
<b>5733.20</b>	<b>H</b>	<b>55.56</b>	<b>38.48</b>	<b>40.92</b>	<b>96.48</b>	<b>79.49</b>			<b>X/F</b>
11500.52	H	52.16	32.91	13.29	65.45	46.20	80.00	60.00	X/H

Remark :

- (1) All readings are Peak unless otherwise stated QP in column of 『Note』 . Peak denotes that the Peak reading compliance with the QP Limits and then QP Mode measurement didn't perform ◦
- (2) Measuring frequency range from 30MHz to 1000MHz or the 10th harmonic of highest fundamental frequency ◦“F” denotes fundamental frequency; “H” denotes spurious frequency. “E” denotes band edge frequency. (This judgment method includes the Band Edge Requirement.)
- (3) Radiated emissions measured in frequency range above 1000MHz were made with an instrument using Peak detector mode and AV detector mode of the emission ◦
- (4) Data of measurement within this frequency range shown “ \* ” in the table above means the reading of emissions are attenuated more than 20dB below the permissible limits or the field strength is too small to be measured.
- (5) A preamp and high pass filter were used for this test in order to provide sufficient measurement sensitivity.
- (6) EUT Orthogonal Axis :  
“X” - denotes Laid on Table ; “Y” - denotes Vertical Stand ; “Z” - denotes Side Stand
- (7) During the measurements above 1 GHz it is taken care of that the EUT is always within the 3 dB cone of radiation BW of the used antenna
- (8) The limits above 5GHz shall be extrapolated to the specified distance using an extrapolation factor of 20dB/decade form 3m to 1.5m  
Distance extrapolation factor = 20 log (3m/1.5m) dB ;  
Limit line = specific limits (dBuV) + 6 dB



TX CH01 (Above 1000 MHz, Horizontal)

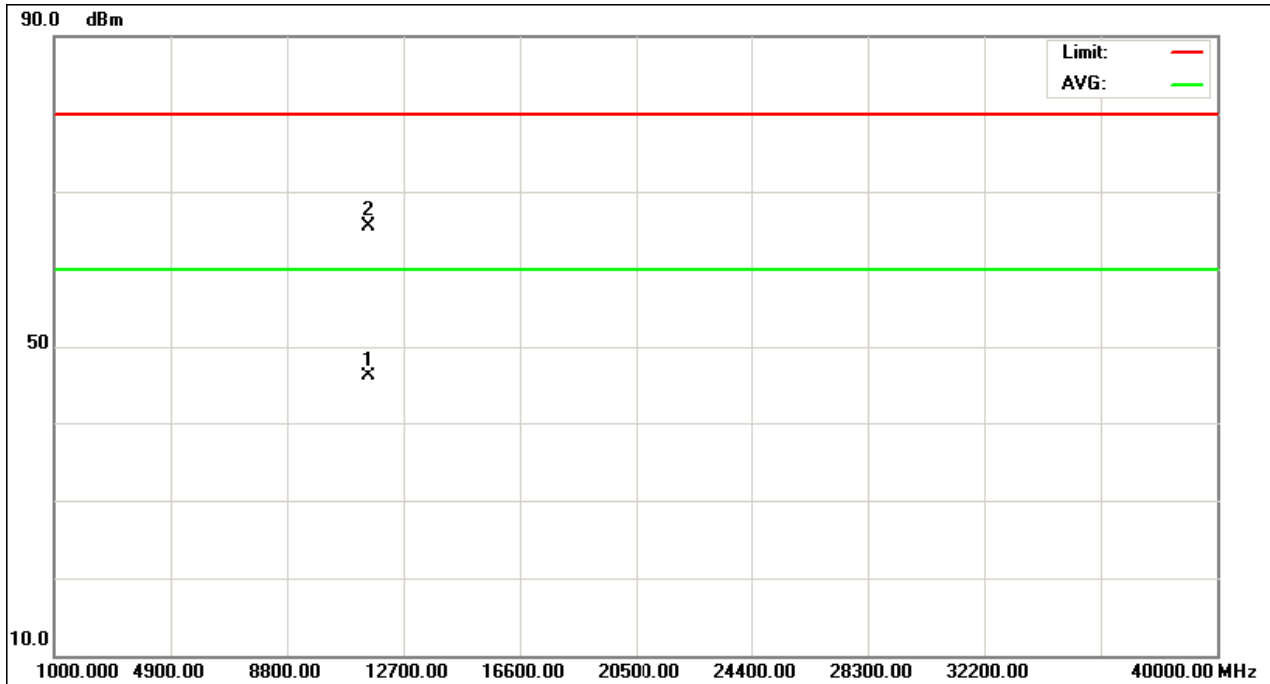
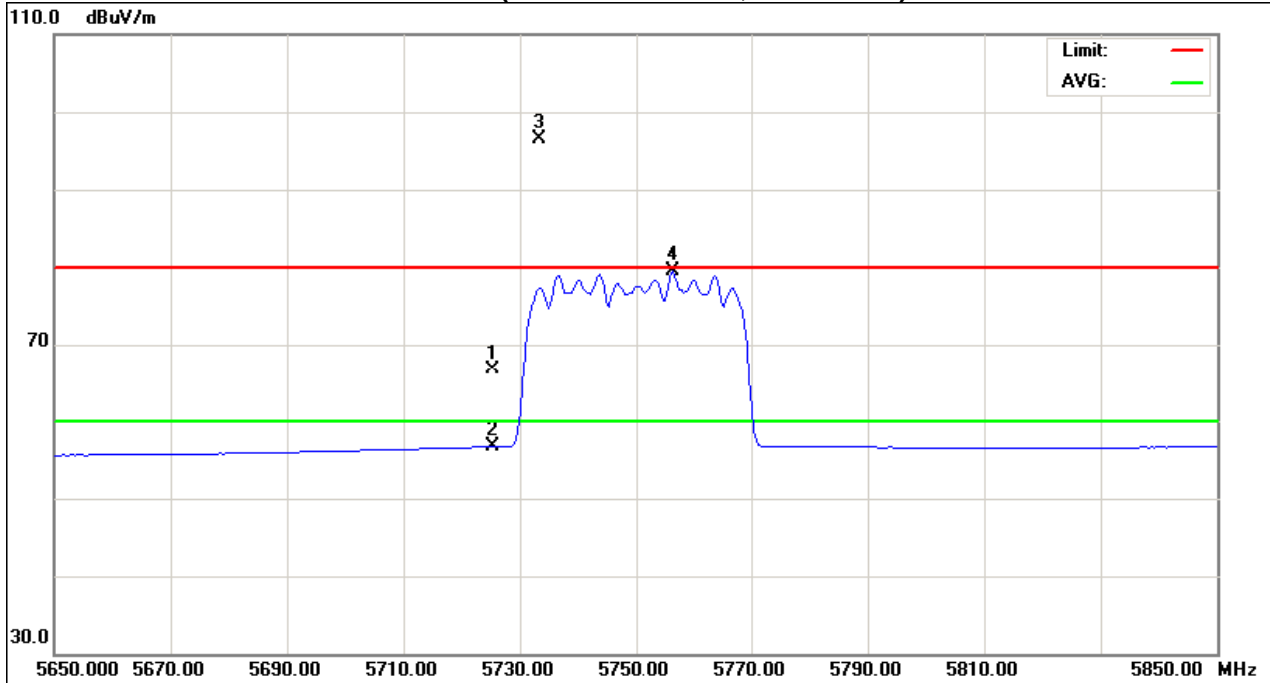



EUT :	HD wireless video transmitter	Model Name :	CB8801
Temperature :	20 °C	Relative Humidity :	50 %
Pressure :	1010 hPa	Test Voltage :	AC 120V/60Hz
Test Mode :	TX MODE 5785MHz		

Freq.	Ant. Pol.	Reading		Ant./CF	Act.		Limit		Note
		Peak	AV		Peak	AV	Peak	AV	
(MHz)	H/V	(dBuV)	(dBuV)	CF(dB)	(dBuV/m)	(dBuV/m)	(dBuV/m)	(dBuV/m)	
<b>5769.00</b>	<b>V</b>	<b>62.18</b>	<b>41.84</b>	<b>41.06</b>	<b>103.24</b>	<b>83.03</b>			<b>X/F</b>
11569.46	V	54.12	43.36	13.36	67.48	56.72	80.00	60.00	X/H

Remark :

- (1) All readings are Peak unless otherwise stated QP in column of 『Note』 . Peak denotes that the Peak reading compliance with the QP Limits and then QP Mode measurement didn't perform ◦
- (2) Measuring frequency range from 30MHz to 1000MHz or the 10th harmonic of highest fundamental frequency ◦ "F" denotes fundamental frequency; "H" denotes spurious frequency. "E" denotes band edge frequency. (This judgment method includes the Band Edge Requirement.)
- (3) Radiated emissions measured in frequency range above 1000MHz were made with an instrument using Peak detector mode and AV detector mode of the emission ◦
- (4) Data of measurement within this frequency range shown " \* " in the table above means the reading of emissions are attenuated more than 20dB below the permissible limits or the field strength is too small to be measured.
- (5) A preamp and high pass filter were used for this test in order to provide sufficient measurement sensitivity.
- (6) EUT Orthogonal Axis :  
 "X" - denotes Laid on Table ; "Y" - denotes Vertical Stand ; "Z" - denotes Side Stand
- (7) During the measurements above 1 GHz it is taken care of that the EUT is always within the 3 dB cone of radiation BW of the used antenna
- (8) The limits above 5GHz shall be extrapolated to the specified distance using an extrapolation factor of 20dB/decade form 3m to 1.5m  
 Distance extrapolation factor =  $20 \log (3m/1.5m)$  dB ;  
 Limit line = specific limits (dBuV) + 6 dB



TX CH02 (Above 1000 MHz, Vertical)

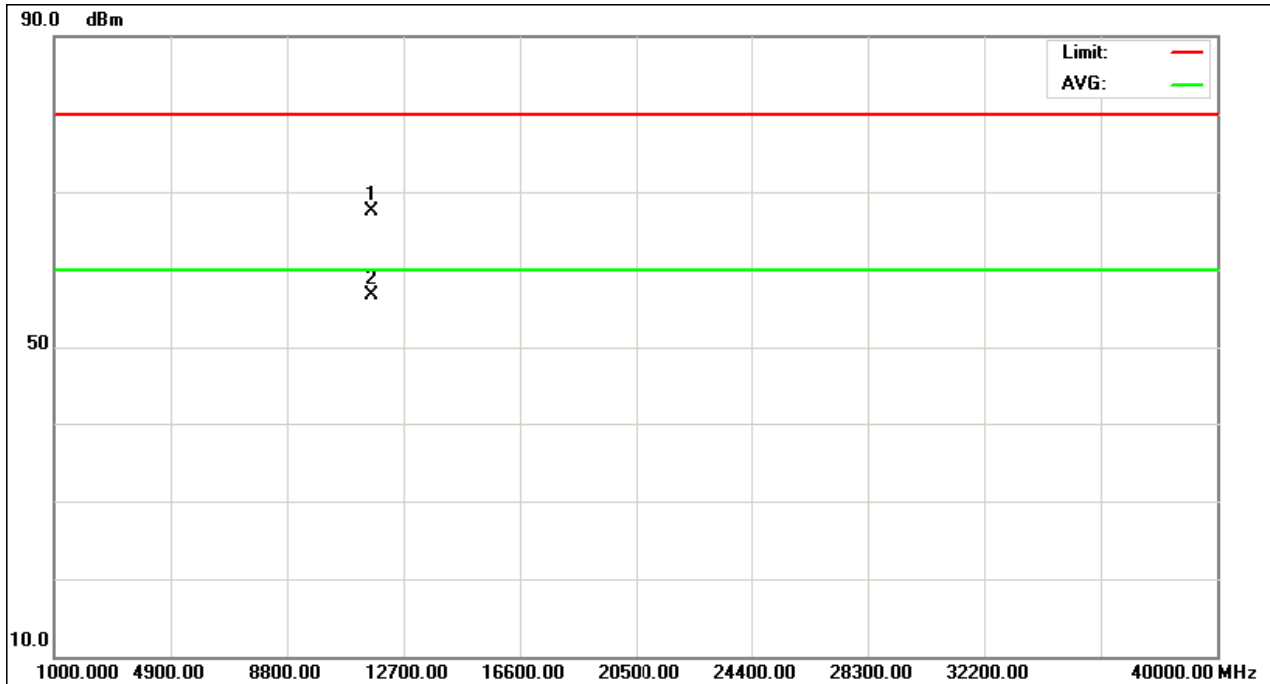
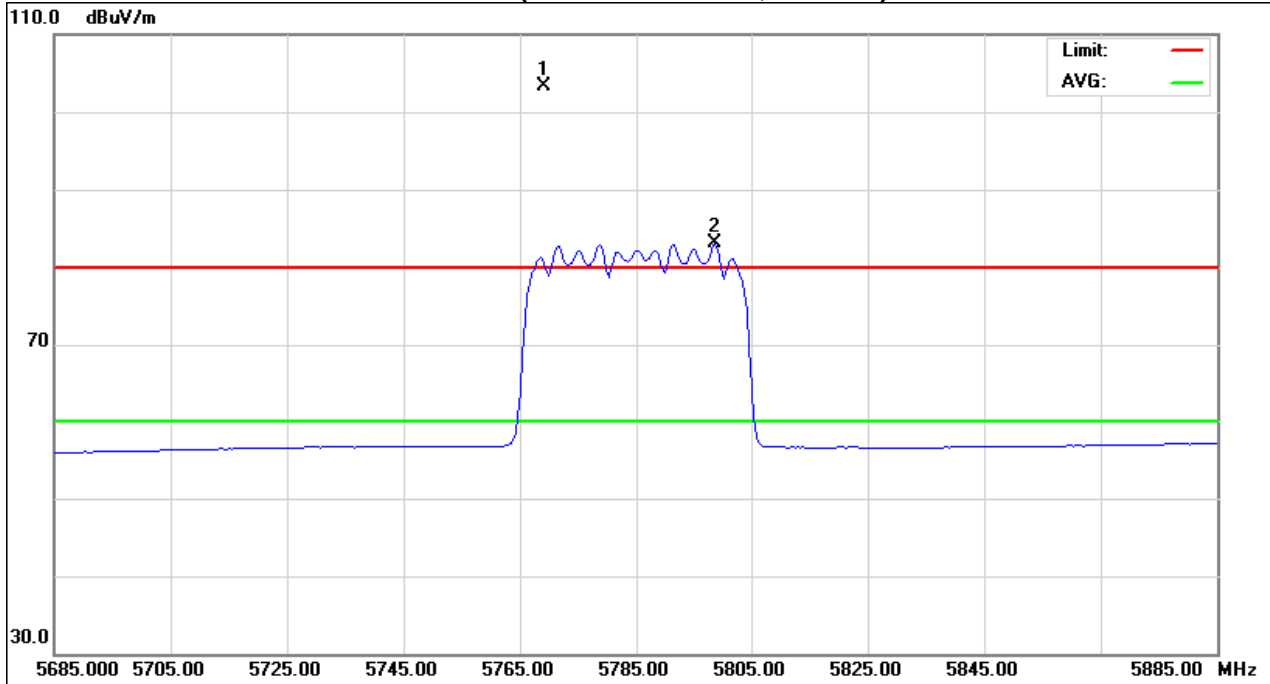



EUT :	HD wireless video transmitter	Model Name :	CB8801
Temperature :	20 °C	Relative Humidity :	50 %
Pressure :	1010 hPa	Test Voltage :	AC 120V/60Hz
Test Mode :	TX MODE 5785MHz		

Freq.	Ant.Pol.	Reading		Ant./CF	Act.		Limit		Note
		Peak	AV		Peak	AV	Peak	AV	
(MHz)	H/V	(dBuV)	(dBuV)	CF(dB)	(dBuV/m)	(dBuV/m)	(dBuV/m)	(dBuV/m)	
<b>5768.60</b>	<b>H</b>	<b>56.19</b>	<b>37.64</b>	<b>41.06</b>	<b>97.25</b>	<b>78.74</b>			<b>X/F</b>
11570.31	H	50.90	33.96	13.36	64.26	47.32	80.00	60.00	X/H

Remark :

- (1) All readings are Peak unless otherwise stated QP in column of 『Note』 . Peak denotes that the Peak reading compliance with the QP Limits and then QP Mode measurement didn't perform ◦
- (2) Measuring frequency range from 30MHz to 1000MHz or the 10th harmonic of highest fundamental frequency ◦ "F" denotes fundamental frequency; "H" denotes spurious frequency. "E" denotes band edge frequency. (This judgment method includes the Band Edge Requirement.)
- (3) Radiated emissions measured in frequency range above 1000MHz were made with an instrument using Peak detector mode and AV detector mode of the emission ◦
- (4) Data of measurement within this frequency range shown " \* " in the table above means the reading of emissions are attenuated more than 20dB below the permissible limits or the field strength is too small to be measured.
- (5) A preamp and high pass filter were used for this test in order to provide sufficient measurement sensitivity.
- (6) EUT Orthogonal Axis :  
 "X" - denotes Laid on Table ; "Y" - denotes Vertical Stand ; "Z" - denotes Side Stand
- (7) During the measurements above 1 GHz it is taken care of that the EUT is always within the 3 dB cone of radiation BW of the used antenna
- (8) The limits above 5GHz shall be extrapolated to the specified distance using an extrapolation factor of 20dB/decade form 3m to 1.5m  
 Distance extrapolation factor =  $20 \log (3m/1.5m)$  dB ;  
 Limit line = specific limits (dBuV) + 6 dB



TX CH02 (Above 1000 MHz, Horizontal)

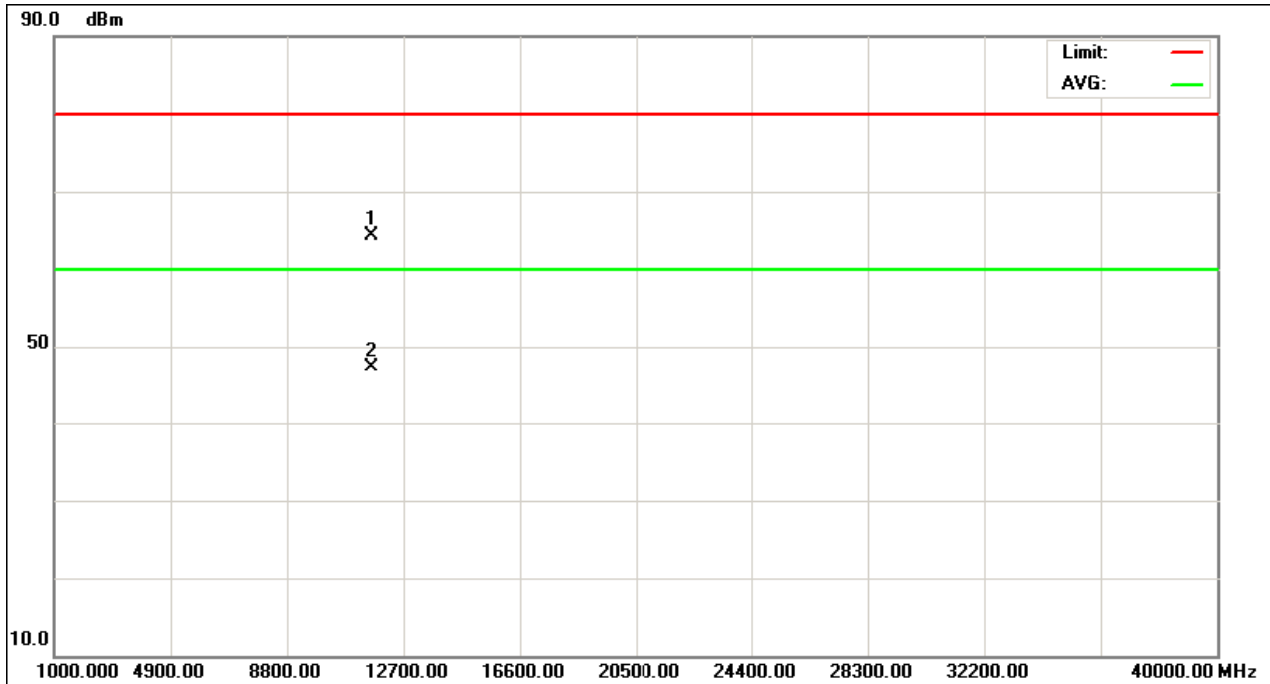
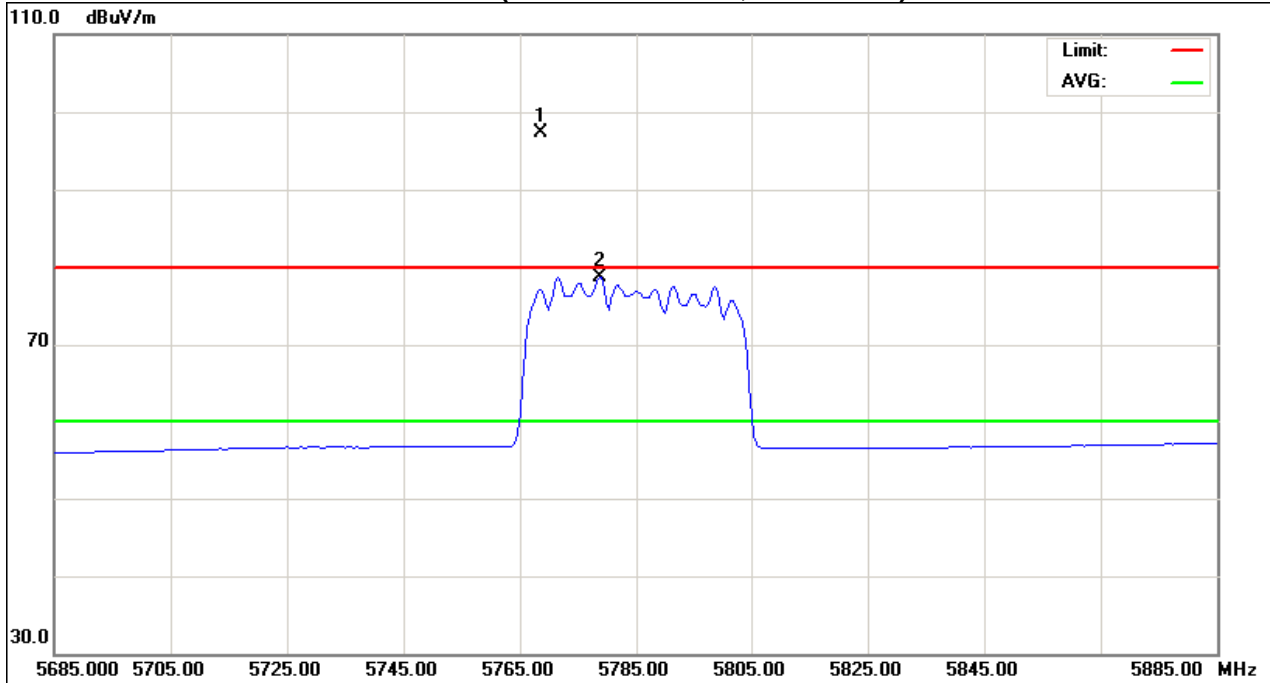



EUT :	HD wireless video transmitter	Model Name :	CB8801
Temperature :	20 °C	Relative Humidity :	50 %
Pressure :	1010 hPa	Test Voltage :	AC 120V/60Hz
Test Mode :	TX MODE 5825MHZ-		

Freq.	Ant.Pol.	Reading		Ant./CF	Act.		Limit		Note
		Peak	AV		Peak	AV	Peak	AV	
(MHz)	H/V	(dBuV)	(dBuV)	CF(dB)	(dBuV/m)	(dBuV/m)	(dBuV/m)	(dBuV/m)	
<b>5839.00</b>	<b>V</b>	<b>59.88</b>	<b>41.25</b>	<b>41.34</b>	<b>101.22</b>	<b>82.56</b>			<b>X/F</b>
5850.00	V	33.09	15.40	41.38	74.47	56.78	80.00	60.00	X/E
11650.28	V	55.09	42.88	13.43	68.52	56.31	80.00	60.00	X/H

Remark :

- (1) All readings are Peak unless otherwise stated QP in column of 『Note』 . Peak denotes that the Peak reading compliance with the QP Limits and then QP Mode measurement didn't perform ◦
- (2) Measuring frequency range from 30MHz to 1000MHz or the 10th harmonic of highest fundamental frequency ◦ "F" denotes fundamental frequency; "H" denotes spurious frequency. "E" denotes band edge frequency. (This judgment method includes the Band Edge Requirement.)
- (3) Radiated emissions measured in frequency range above 1000MHz were made with an instrument using Peak detector mode and AV detector mode of the emission ◦
- (4) Data of measurement within this frequency range shown " \* " in the table above means the reading of emissions are attenuated more than 20dB below the permissible limits or the field strength is too small to be measured.
- (5) A preamp and high pass filter were used for this test in order to provide sufficient measurement sensitivity.
- (6) EUT Orthogonal Axis :  
 "X" - denotes Laid on Table ; "Y" - denotes Vertical Stand ; "Z" - denotes Side Stand
- (7) During the measurements above 1 GHz it is taken care of that the EUT is always within the 3 dB cone of radiation BW of the used antenna
- (8) The limits above 5GHz shall be extrapolated to the specified distance using an extrapolation factor of 20dB/decade form 3m to 1.5m  
 Distance extrapolation factor =  $20 \log (3m/1.5m)$  dB ;  
 Limit line = specific limits (dBuV) + 6 dB



TX CH03 (Above 1000 MHz, Vertical)

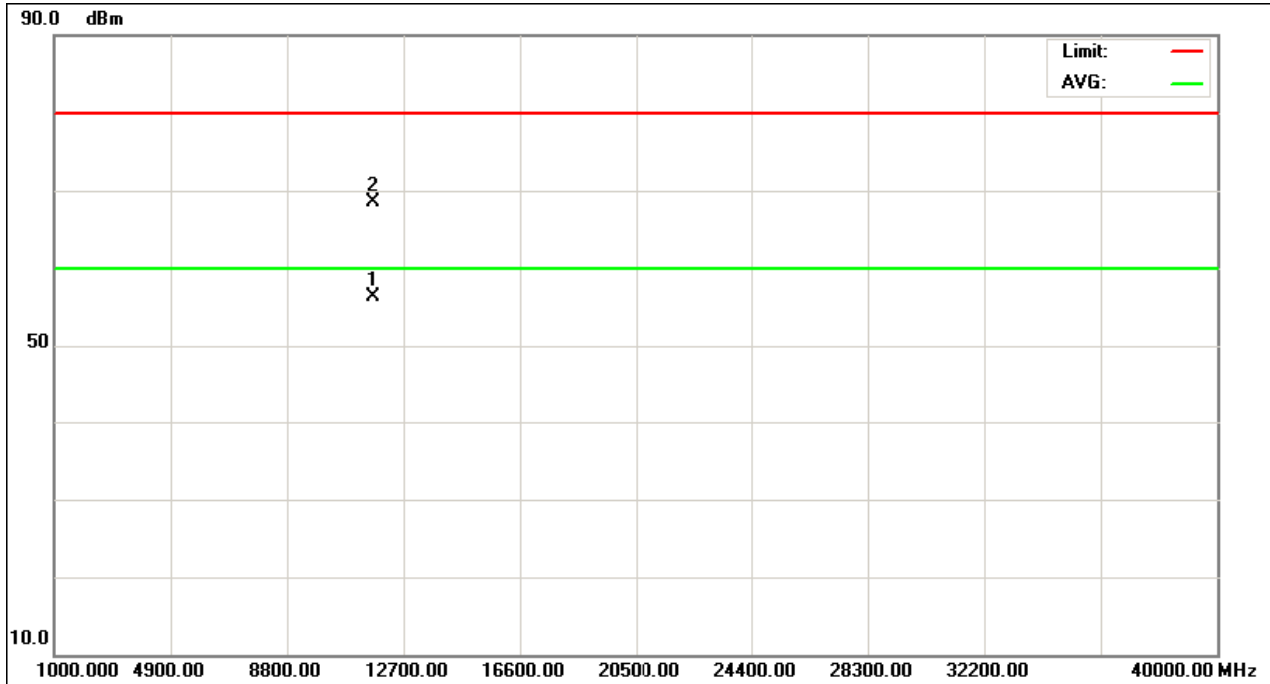
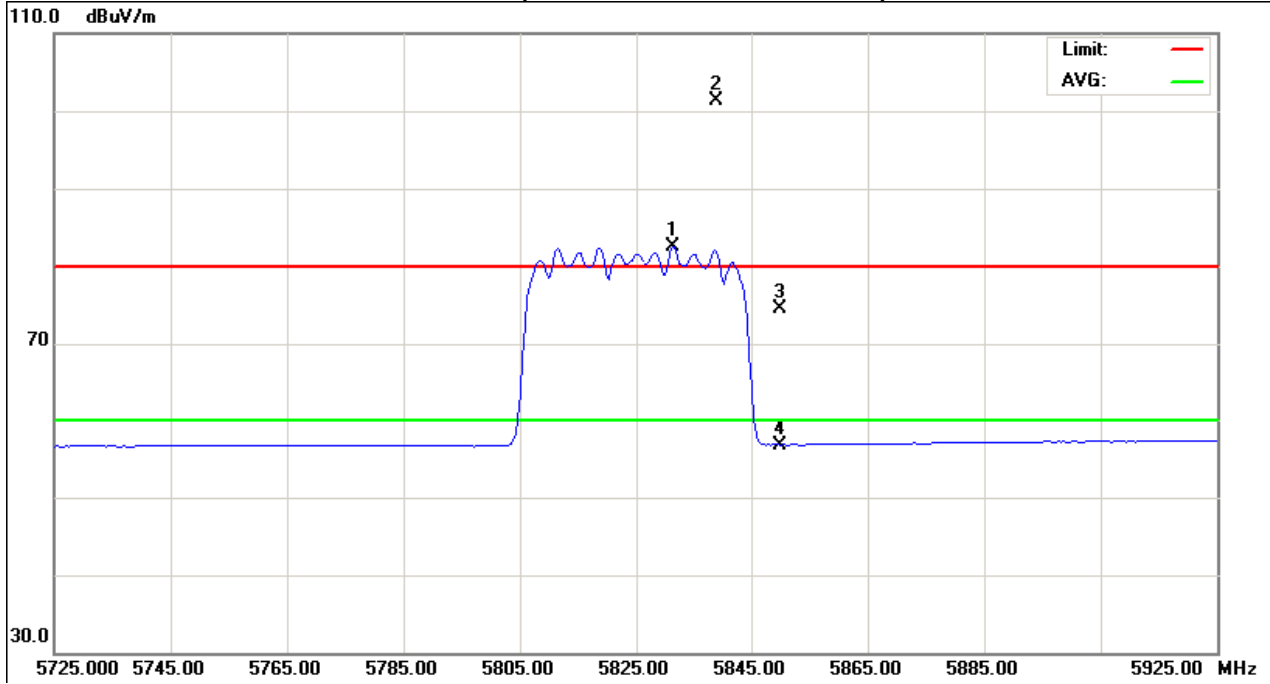





EUT :	HD wireless video transmitter	Model Name :	CB8801
Temperature :	20 °C	Relative Humidity :	50 %
Pressure :	1010 hPa	Test Voltage :	AC 120V/60Hz
Test Mode :	TX MODE 5825MHz		

Freq. (MHz)	Ant.Pol. H/V	Reading		Ant./CF CF(dB)	Act.		Limit		Note
		Peak (dBuV)	AV (dBuV)		Peak (dBuV/m)	AV (dBuV/m)	Peak (dBuV/m)	AV (dBuV/m)	
<b>5809.00</b>	<b>H</b>	<b>54.27</b>	<b>35.76</b>	<b>41.22</b>	<b>95.49</b>	<b>76.99</b>			<b>X/F</b>
5850.00	H	26.69	15.32	41.38	68.07	56.70	80.00	60.00	X/E
11649.68	H	48.88	32.63	13.43	62.31	46.06	80.00	60.00	X/H

Remark :

- (1) All readings are Peak unless otherwise stated QP in column of 『Note』 . Peak denotes that the Peak reading compliance with the QP Limits and then QP Mode measurement didn't perform ◦
- (2) Measuring frequency range from 30MHz to 1000MHz or the 10th harmonic of highest fundamental frequency ◦ "F" denotes fundamental frequency; "H" denotes spurious frequency. "E" denotes band edge frequency. (This judgment method includes the Band Edge Requirement.)
- (3) Radiated emissions measured in frequency range above 1000MHz were made with an instrument using Peak detector mode and AV detector mode of the emission ◦
- (4) Data of measurement within this frequency range shown " \* " in the table above means the reading of emissions are attenuated more than 20dB below the permissible limits or the field strength is too small to be measured.
- (5) A preamp and high pass filter were used for this test in order to provide sufficient measurement sensitivity.
- (6) EUT Orthogonal Axis :  
"X" - denotes Laid on Table ; "Y" - denotes Vertical Stand ; "Z" - denotes Side Stand
- (7) During the measurements above 1 GHz it is taken care of that the EUT is always within the 3 dB cone of radiation BW of the used antenna
- (8) The limits above 5GHz shall be extrapolated to the specified distance using an extrapolation factor of 20dB/decade form 3m to 1.5m  
Distance extrapolation factor =  $20 \log (3m/1.5m)$  dB ;  
Limit line = specific limits (dBuV) + 6 dB



TX CH03 (Above 1000 MHz, Horizontal)

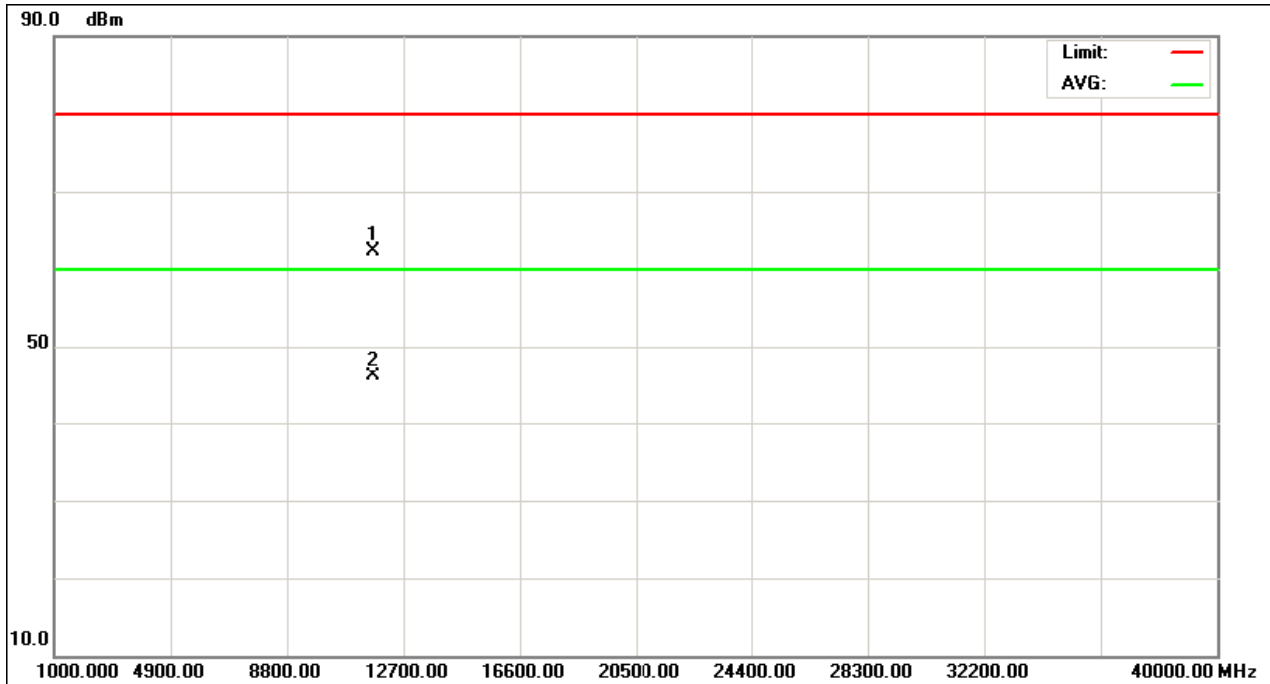
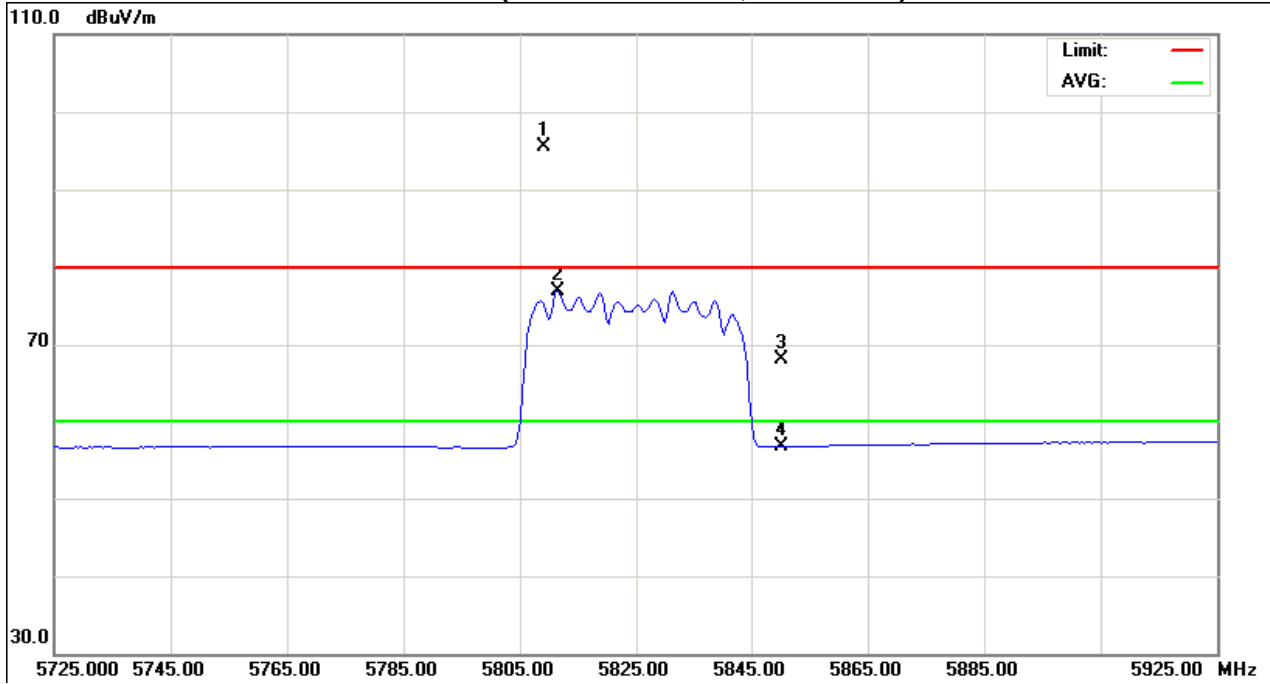



**5. BANDWIDTH TEST**

**5.1 Applied procedures / limit**

FCC Part15 (15.247) , Subpart C				
Section	Test Item	Limit	Frequency Range (MHz)	Result
15.247(a)(2)	Bandwidth	>= 500KHz (6dB bandwidth)	2400-2483.5	PASS

**5.1.1 MEASUREMENT INSTRUMENTS LIST**

Item	Kind of Equipment	Manufacturer	Type No.	Serial No.	Calibrated until
1	Spectrum Analyzer	R&S	FSP_40	100129	Jan. 04, 2012

Remark: " N/A" denotes No Model Name. , Serial No. or No Calibration specified.

**5.1.2 TEST PROCEDURE**

- a. The EUT was directly connected to the spectrum analyzer and antenna output port as show in the block diagram below,
- b. Spectrum Setting : RBW= 100KHz, VBW=100KHz, Sweep time = 20 ms.

**5.1.3 DEVIATION FROM STANDARD**

No deviation.

**5.1.4 TEST SETUP**

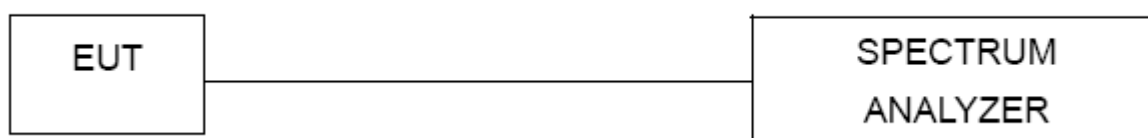

**5.1.5 EUT OPERATION CONDITIONS**

The EUT tested system was configured as the statements of 4.1.6 Unless otherwise a special operating condition is specified in the follows during the testing.



**5.1.6 TEST RESULTS**

EUT :	HD wireless video transmitter	Model Name. :	CB8801
Temperature :	20 °C	Relative Humidity :	50 %
Pressure :	1010 hPa	Test Voltage :	AC 120V/60Hz
Test Mode :	TX MODE /CH01, CH02, CH03		

Test Channel	Frequency (MHz)	Bandwidth (MHz)	99% Occupied BW (MHz)	LIMIT (MHz)
CH01	5750	37.00	37.00	>=500KHz
CH02	5785	37.20	37.20	>=500KHz
CH03	5825	36.00	37.20	>=500KHz

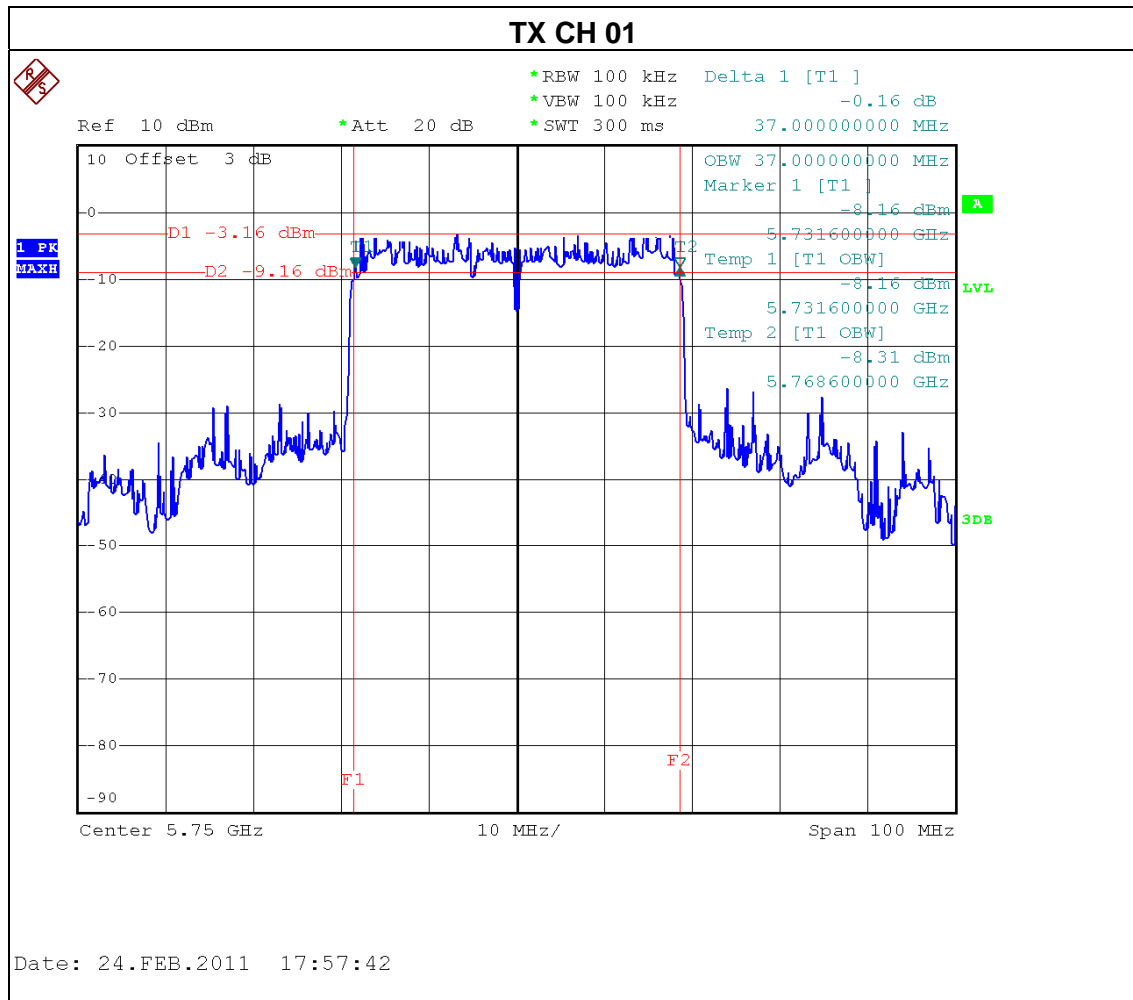

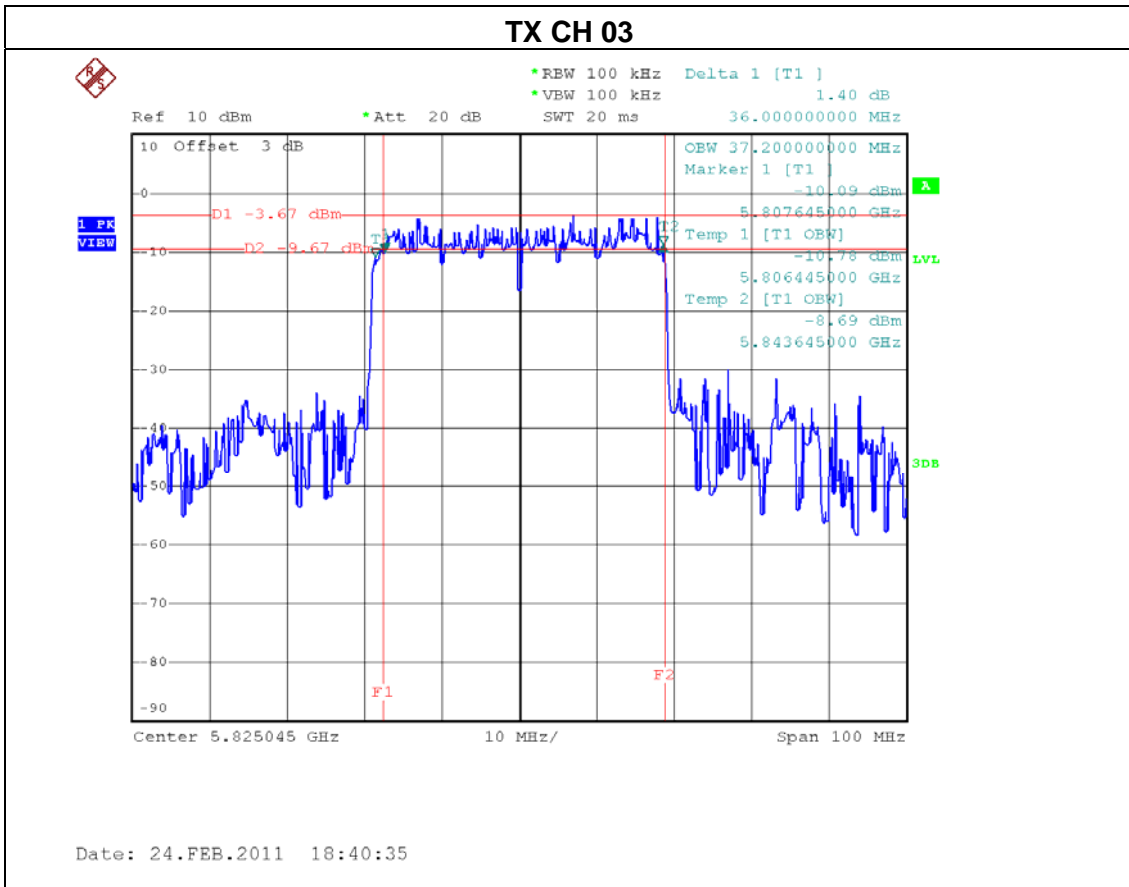
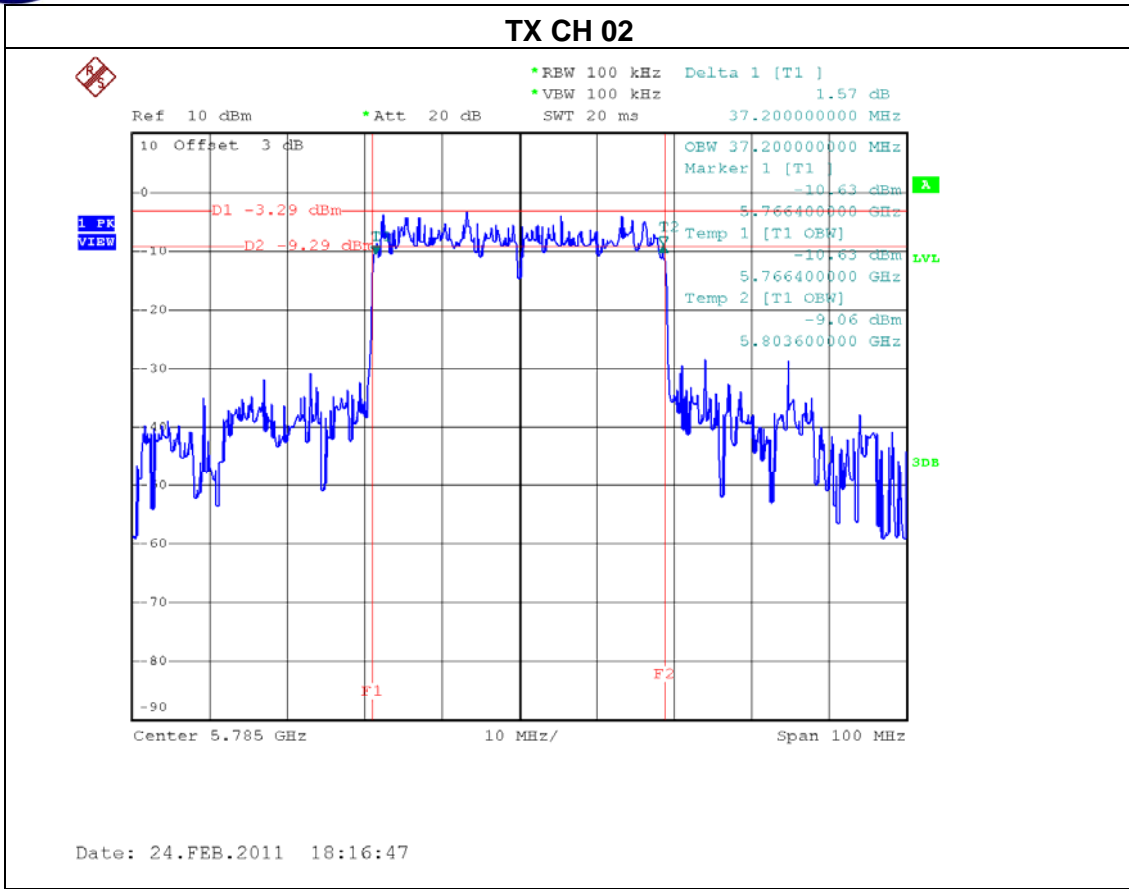



**6. PEAK OUTPUT POWER TEST**

**6.1 Applied procedures / limit**

FCC Part15 (15.247) , Subpart C				
Section	Test Item	Limit	Frequency Range (MHz)	Result
15.247(b)(3)	Peak Output Power	1 watt or 30dBm	2400-2483.5	PASS

**6.1.1 MEASUREMENT INSTRUMENTS LIST**

Item	Kind of Equipment	Manufacturer	Type No.	Serial No.	Calibrated until
1	Spectrum Analyzer	R&S	FSP_40	100129	Jan. 04, 2012

Remark: " N/A" denotes No Model Name. , Serial No. or No Calibration specified.

**6.1.2 TEST PROCEDURE**

- a. The EUT was directly connected to the spectrum analyzer and antenna output port as show in the block diagram below,

**6.1.3 DEVIATION FROM STANDARD**

No deviation.

**6.1.4 TEST SETUP**



**6.1.5 EUT OPERATION CONDITIONS**

The EUT tested system was configured as the statements of 4.1.6 Unless otherwise a special operating condition is specified in the follows during the testing.



**6.1.6 TEST RESULTS**

EUT :	HD wireless video transmitter	Model Name :	CB8801
Temperature :	20 °C	Relative Humidity :	50 %
Pressure :	1010 hPa	Test Voltage :	AC 120V/60Hz
Test Mode :	TX MODE /CH01, CH02, CH03		

**Peak Output Power**

ANT 1				
Test Channel	Frequency (MHz)	Peak Output Power (dBm)	LIMIT (dBm)	LIMIT (W)
CH01	5750 MHz	10.26	30	1
CH02	5785 MHz	11.33	30	1
CH03	5825 MHz	10.89	30	1
ANT 2				
Test Channel	Frequency (MHz)	Peak Output Power (dBm)	LIMIT (dBm)	LIMIT (W)
CH01	5750 MHz	10.06	30	1
CH02	5785 MHz	11.14	30	1
CH03	5825 MHz	10.76	30	1
Total (ANT 1+ ANT 2)				
Test Channel	Frequency (MHz)	Peak Output Power (dBm)	LIMIT (dBm)	LIMIT (W)
CH01	5750 MHz	13.57	30	1
CH02	5785 MHz	14.56	30	1
CH03	5825 MHz	14.18	30	1



EUT :	HD wireless video transmitter	Model Name :	CB8801
Temperature :	20 °C	Relative Humidity :	50 %
Pressure :	1010 hPa	Test Voltage :	AC 120V/60Hz
Test Mode :	TX MODE /CH01, CH02, CH03		

**Average Output Power limit: None ; for reporting purposes only**

ANT 1				
Test Channel	Frequency (MHz)	Average Output Power (dBm)	LIMIT (dBm)	LIMIT (W)
CH01	5750 MHz	1.43	None	None
CH02	5785 MHz	4.54	None	None
CH03	5825 MHz	1.78	None	None
ANT 2				
Test Channel	Frequency (MHz)	Average Output Power (dBm)	LIMIT (dBm)	LIMIT (W)
CH01	5750 MHz	1.23	None	None
CH02	5785 MHz	2.25	None	None
CH03	5825 MHz	1.76	None	None
Total (ANT 1+ ANT 2)				
Test Channel	Frequency (MHz)	Average Output Power (dBm)	LIMIT (dBm)	LIMIT (W)
CH01	5750 MHz	4.34	None	None
CH02	5785 MHz	4.92	None	None
CH03	5825 MHz	4.78	None	None





**7. ANTENNA CONDUCTED SPURIOUS EMISSION**

**7.1 Applied procedures / limit**

20dBc in any 100 kHz bandwidth outside the operating frequency band. In case the emission fall within the restricted band specified on 15.205(a), then the 15.209(a) limit in the table below has to be followed.

Frequencies (MHz)	Field Strength (micorvolts/meter)	Measurement Distance (meters)
0.009~0.490	2400/F(KHz)	300
0.490~1.705	24000/F(KHz)	30
1.705~30.0	30	30
30~88	100	3
88~216	150	3
216~960	200	3
Above 960	500	3

**7.1.1 MEASUREMENT INSTRUMENTS LIST**

Item	Kind of Equipment	Manufacturer	Type No.	Serial No.	Calibrated until
1	Spectrum Analyzer	R&S	FSP_40	100129	Jan. 04, 2012

Remark: " N/A" denotes No Model Name. , Serial No. or No Calibration specified.

**7.1.2 TEST PROCEDURE**

- a. The EUT was directly connected to the spectrum analyzer and antenna output port as show in the block diagram below,
- b. Spectrum Setting : RBW= 100KHz, VBW=100KHz, Sweep time = 10 ms.

**7.1.3 DEVIATION FROM STANDARD**

No deviation.

**7.1.4 TEST SETUP**



**7.1.5 EUT OPERATION CONDITIONS**

The EUT tested system was configured as the statements of 4.1.6 Unless otherwise a special operating condition is specified in the follows during the testing.



**7.1.6 TEST RESULTS**

EUT :	HD wireless video transmitter	Model Name :	CB8801
Temperature :	20 °C	Relative Humidity :	50 %
Pressure :	1010 hPa	Test Voltage :	AC 120V/60Hz
Test Mode :	TX MODE /CH01, CH02 , CH03		

Channel of Worst Data: CH03			
The max. radio frequency power in any 100kHz bandwidth outside the frequency band		The max. radio frequency power in any 100 kHz bandwidth within the frequency band.	
FREQUENCY(MHz)	POWER(dBm)	FREQUENCY(MHz)	POWER(dBm)
5717.20	-51.95	5860.25	-35.99
Result			
In any 100kHz bandwidth outside the frequency band, the radio frequency power is at least 20dB below that in the 100kHz bandwidth within the band that contains the highest level of the desired power.			

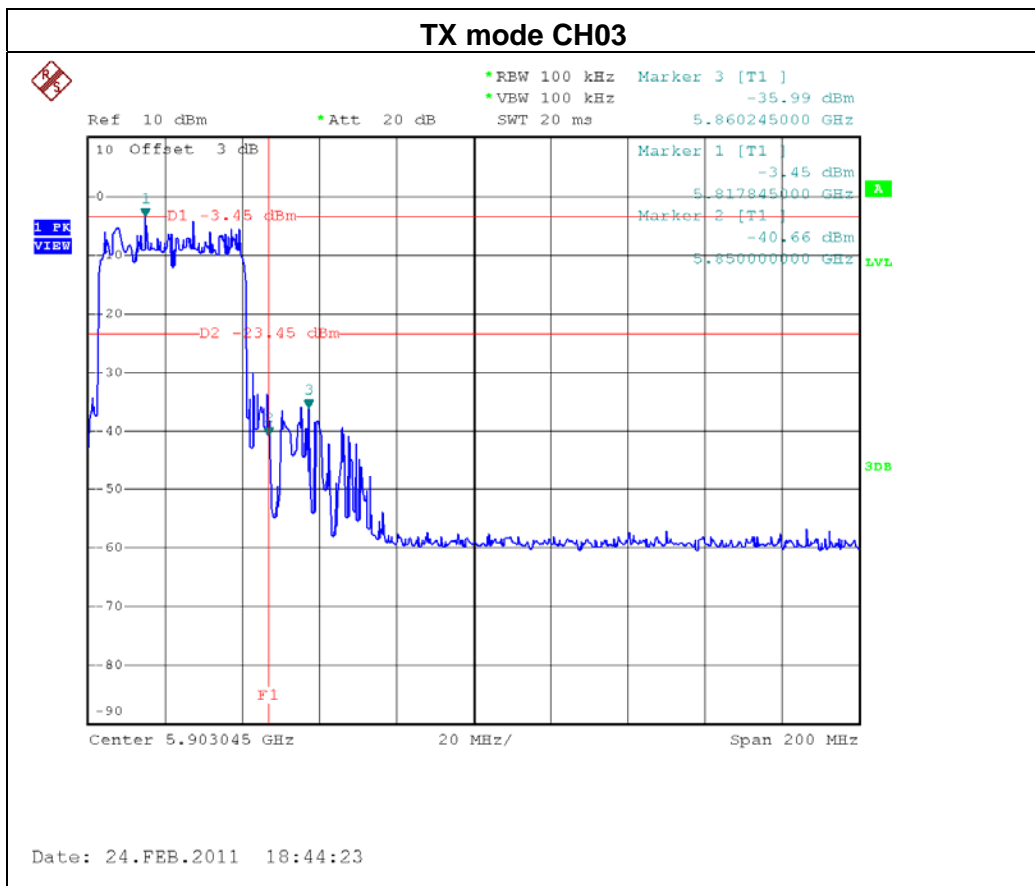
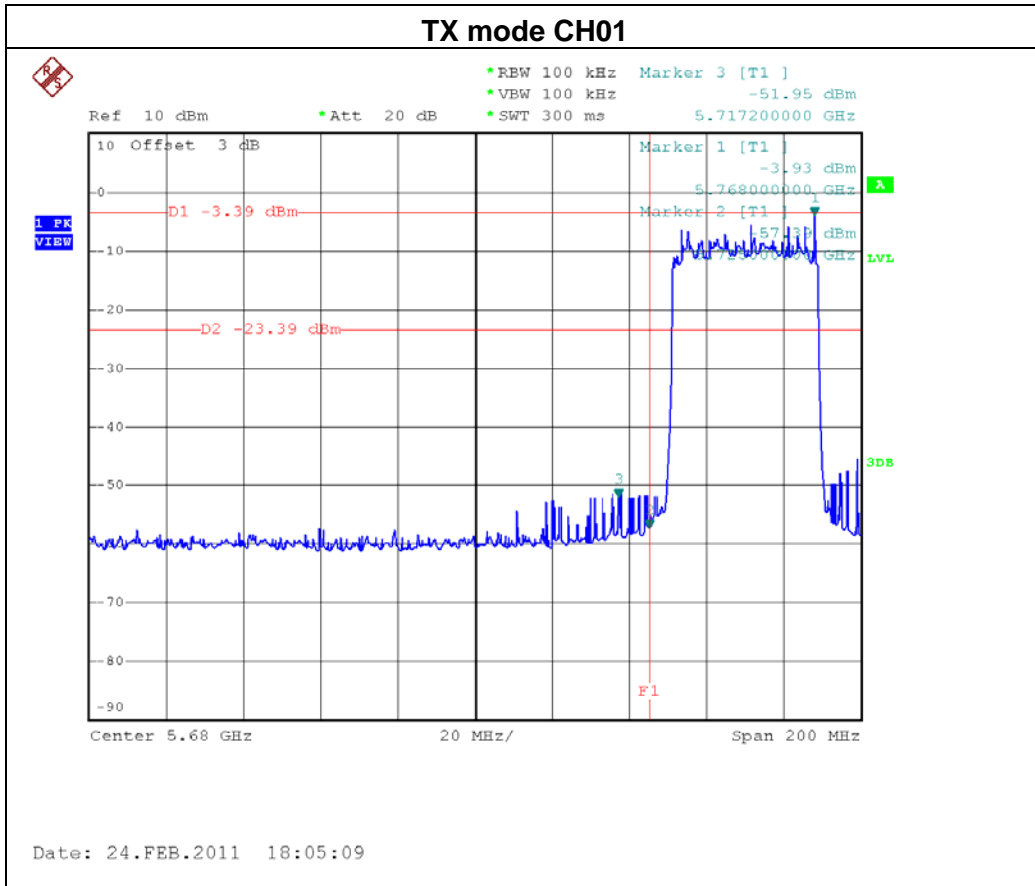

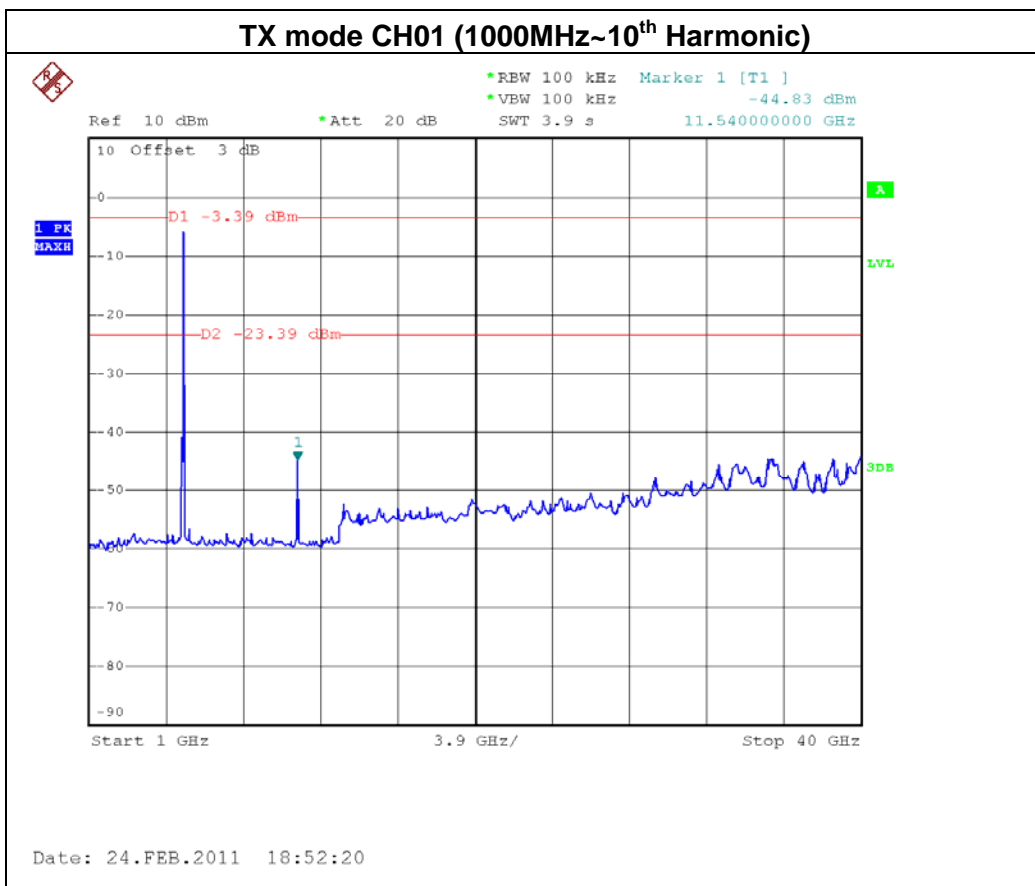
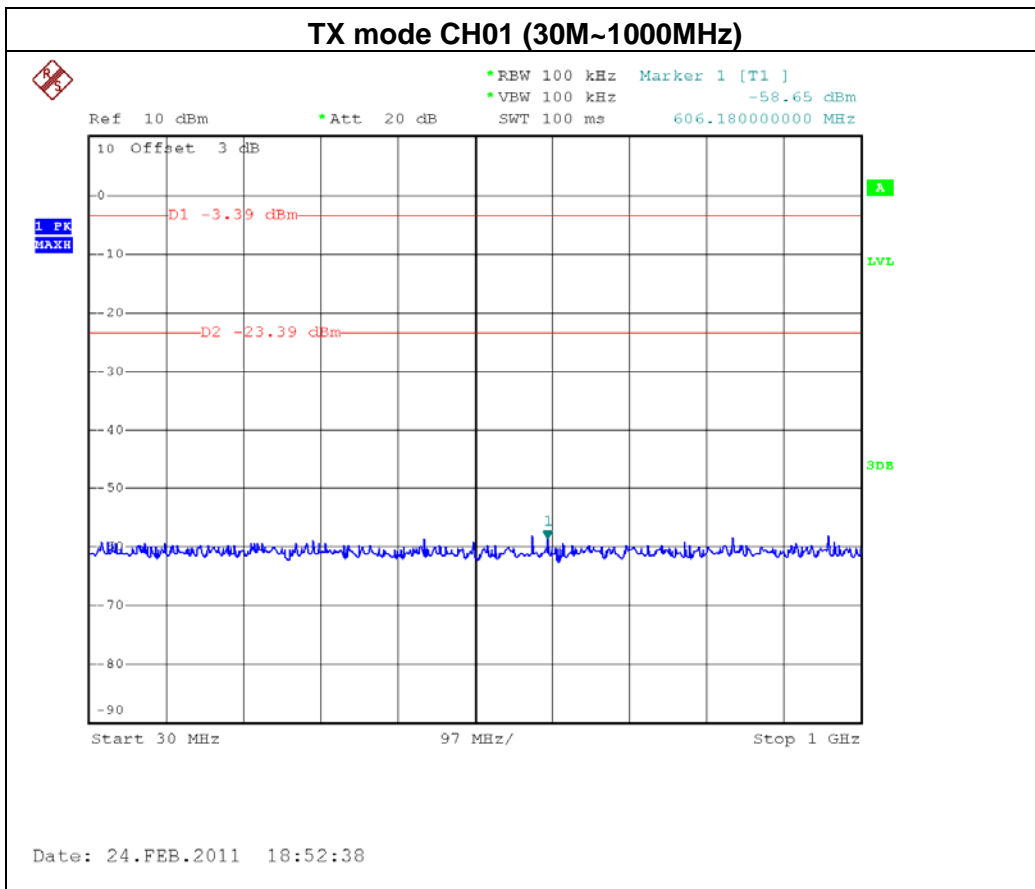

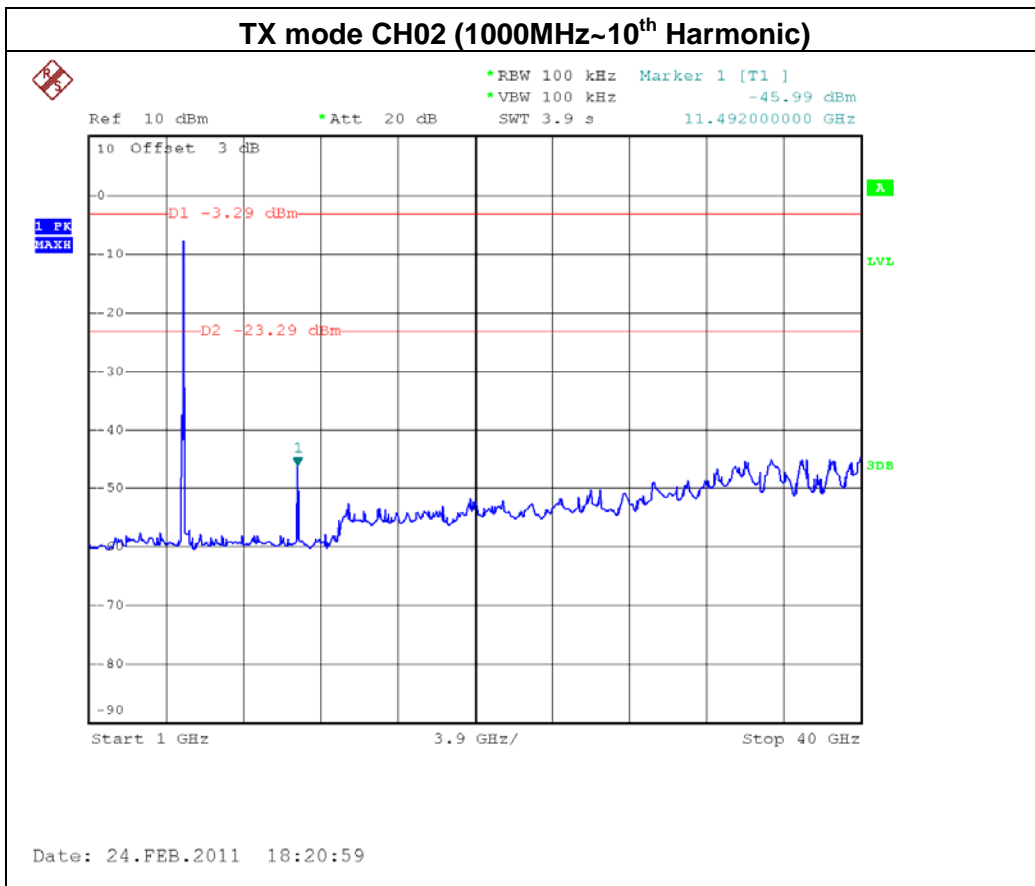
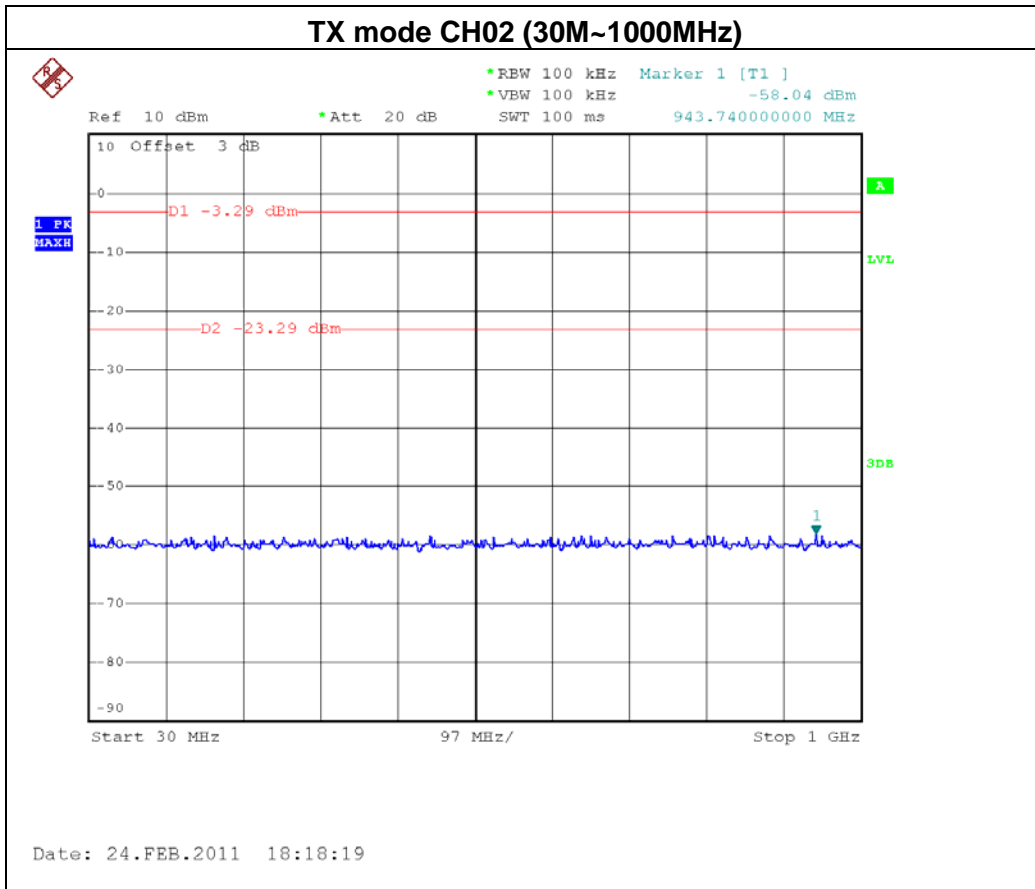

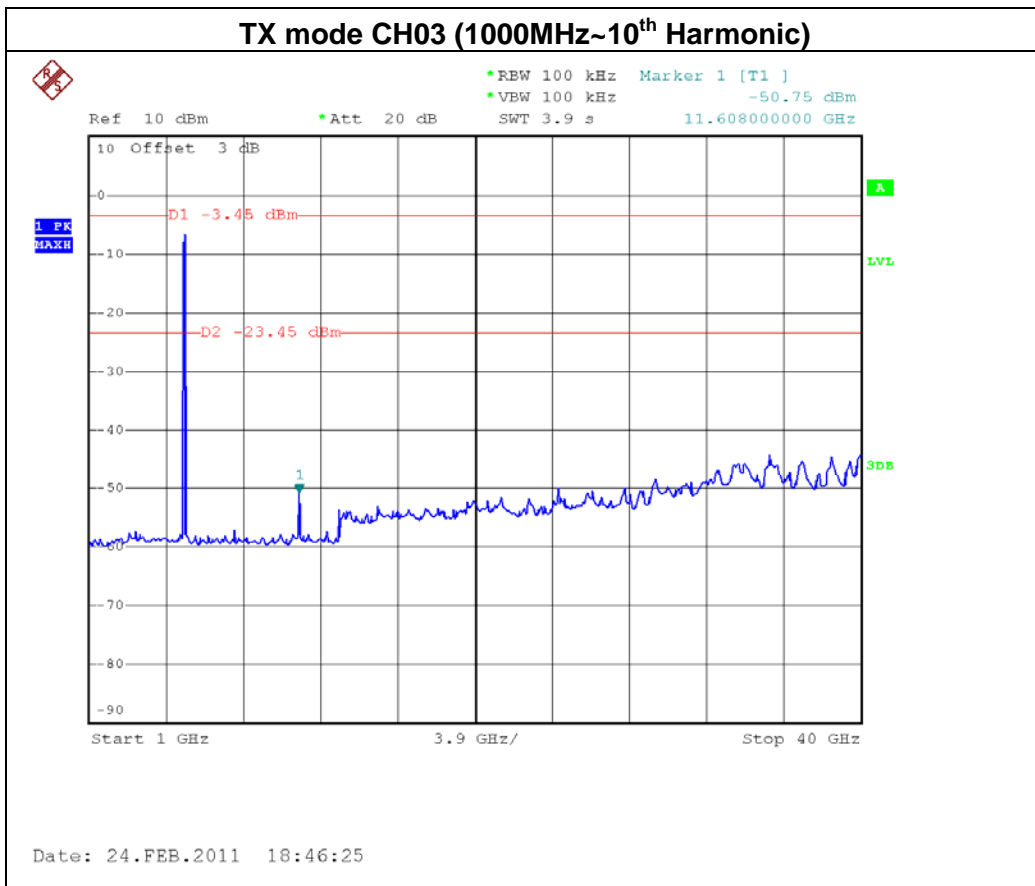
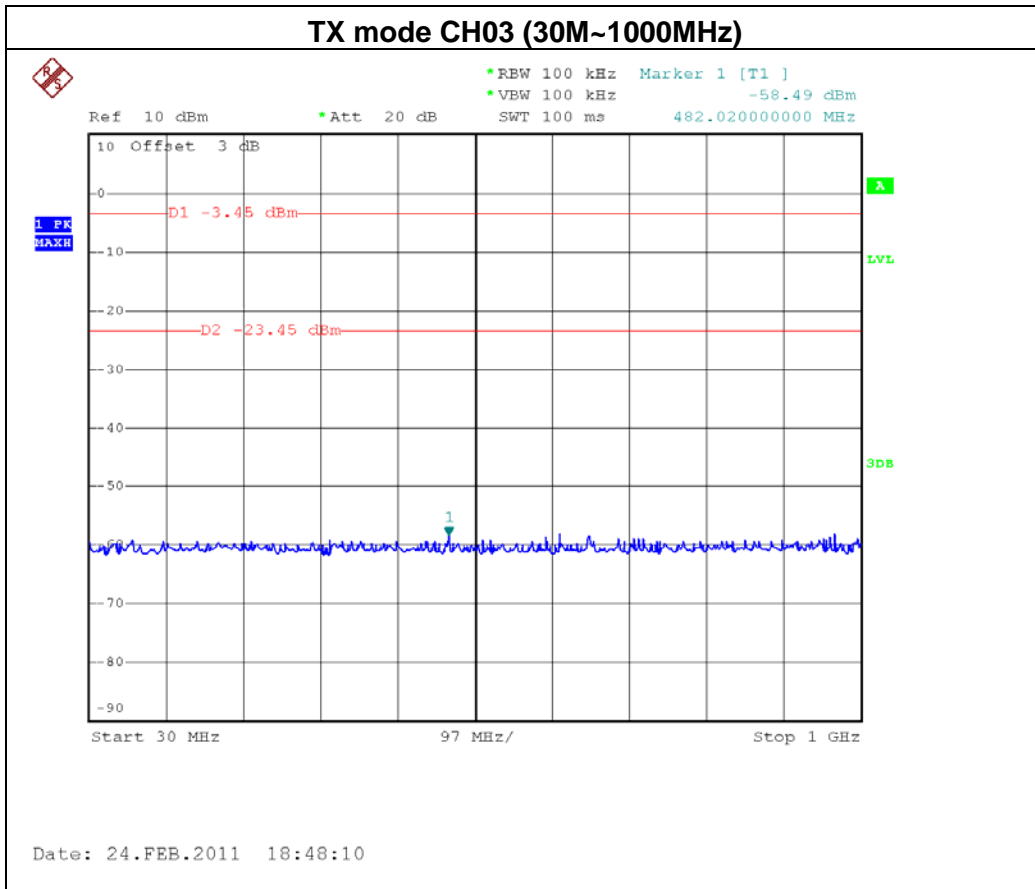



**8. POWER SPECTRAL DENSITY TEST**

**8.1 Applied procedures / limit**

FCC Part15 (15.247) , Subpart C				
Section	Test Item	Limit	Frequency Range (MHz)	Result
15.247(e)	Power Spectral Density	8 dBm (in any 3KHz)	2400-2483.5	PASS

**8.1.1 MEASUREMENT INSTRUMENTS LIST**

Item	Kind of Equipment	Manufacturer	Type No.	Serial No.	Calibrated until
1	Spectrum Analyzer	R&S	FSP_40	100129	Jan. 04, 2012

Remark: " N/A" denotes No Model Name. , Serial No. or No Calibration specified.

**8.1.2 TEST PROCEDURE**

- a. The EUT was directly connected to the spectrum analyzer and antenna output port as show in the block diagram below,
- b. Spectrum Setting : RBW=3KHz, VBW=30 KHz, Sweep time = 500s.

**8.1.3 DEVIATION FROM STANDARD**

No deviation.

**8.1.4 TEST SETUP**



**8.1.5 EUT OPERATION CONDITIONS**

The EUT tested system was configured as the statements of 4.1.6 Unless otherwise a special operating condition is specified in the follows during the testing.



**8.1.6 TEST RESULTS**

EUT :	HD wireless video transmitter	Model Name :	CB8801
Temperature :	23 °C	Relative Humidity :	51 %
Pressure :	1010 hPa	Test Voltage :	AC 120V/60Hz
Test Mode :	TX MODE /CH01, CH02, CH03		

ANT 1			
Test Channel	Frequency (MHz)	Power Density (dBm)	LIMIT (dBm)
CH01	5750 MHz	-21.51	8
CH02	5785 MHz	-23.54	8
CH03	5825 MHz	-24.75	8

ANT 2			
Test Channel	Frequency (MHz)	Power Density (dBm)	LIMIT (dBm)
CH01	5750 MHz	-21.59	8
CH02	5785 MHz	-23.53	8
CH03	5825 MHz	-25.18	8

Total (ANT 1+ ANT 2)			
Test Channel	Frequency (MHz)	Power Density (dBm)	LIMIT (dBm)
CH01	5750 MHz	-18.54	8
CH02	5785 MHz	-20.52	8
CH03	5825 MHz	-21.95	8



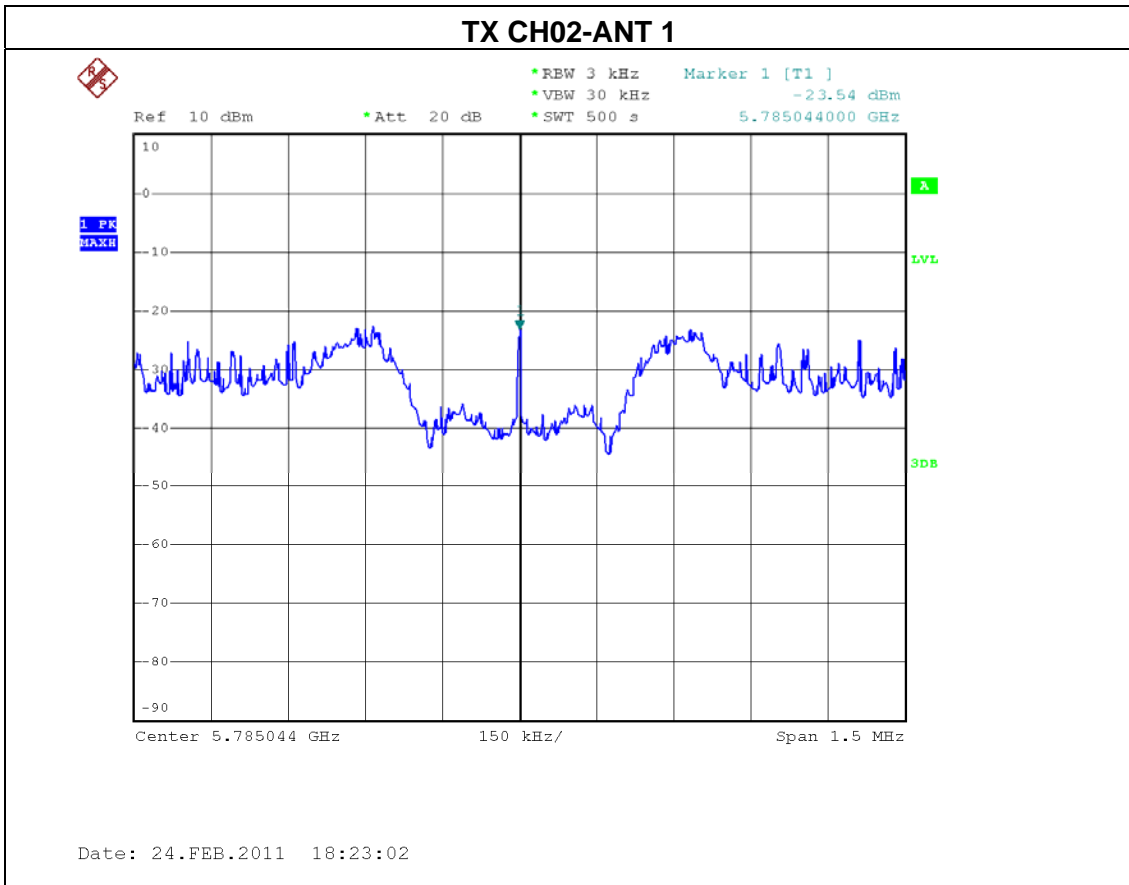
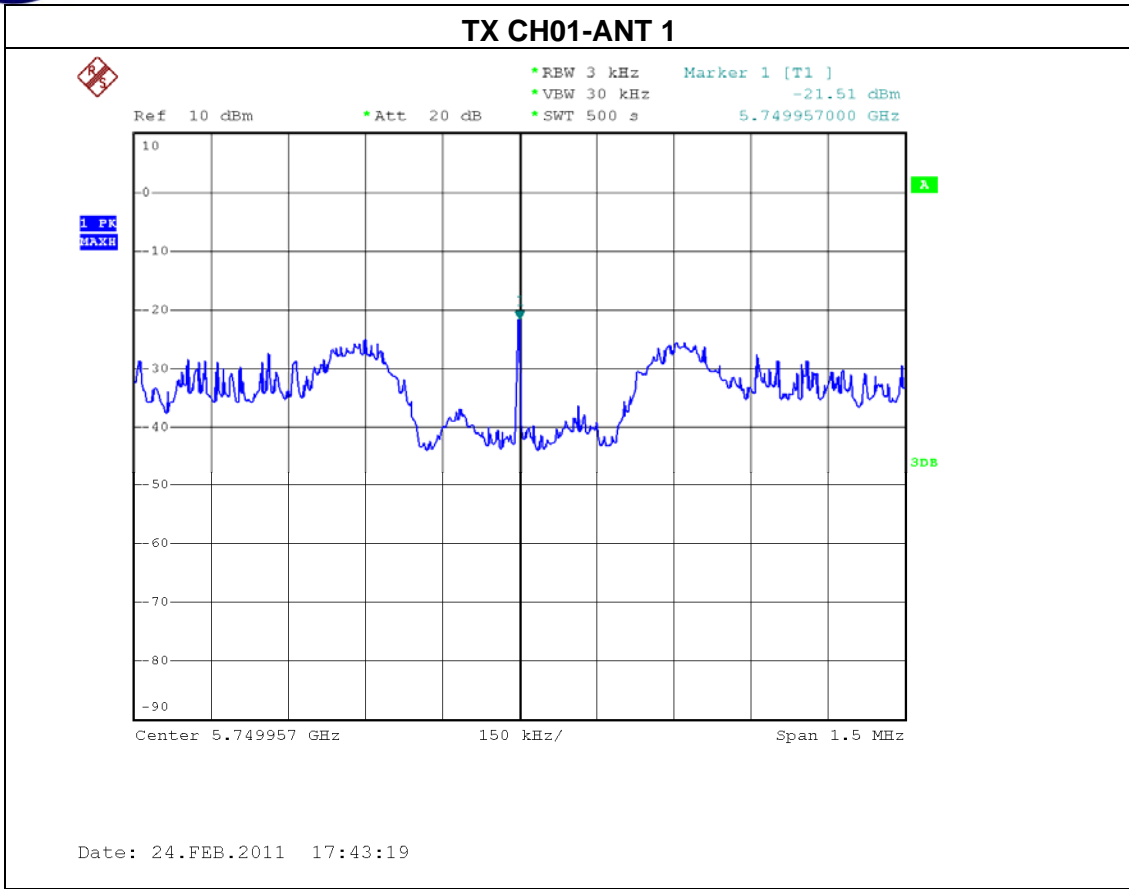

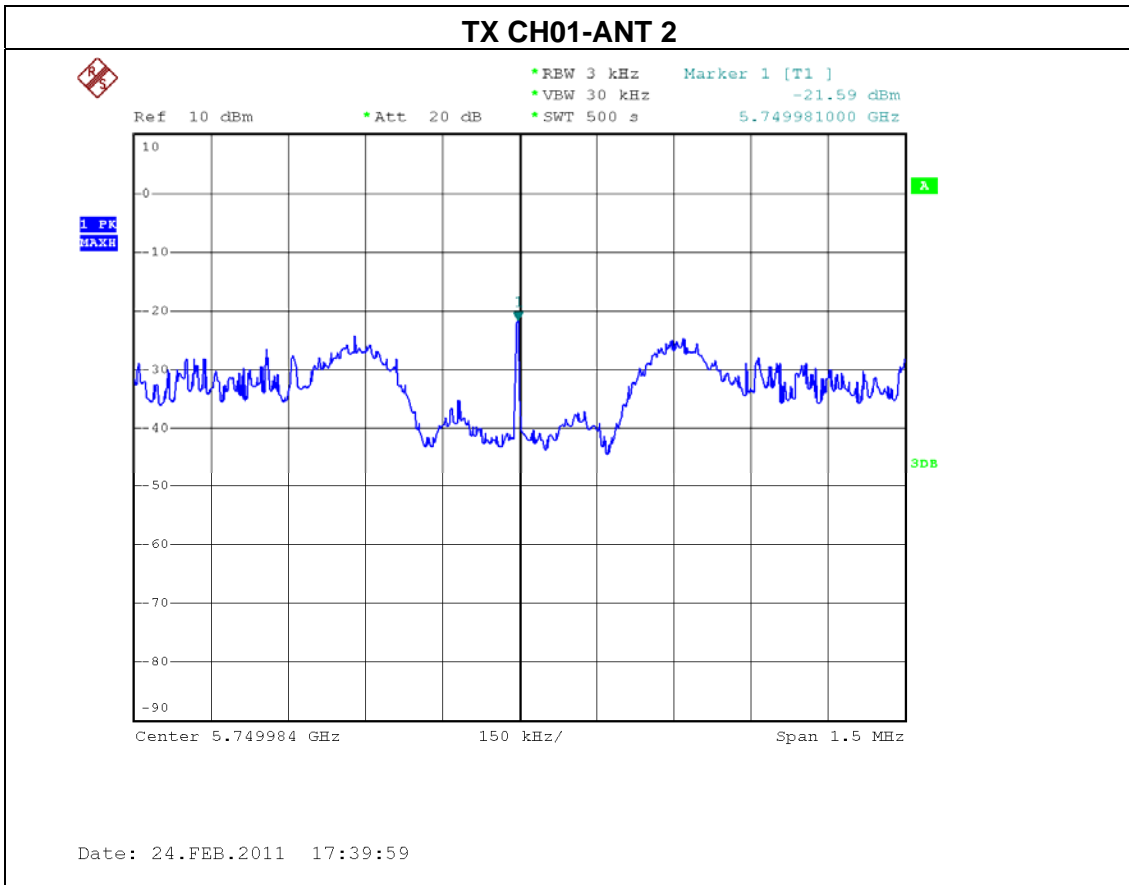
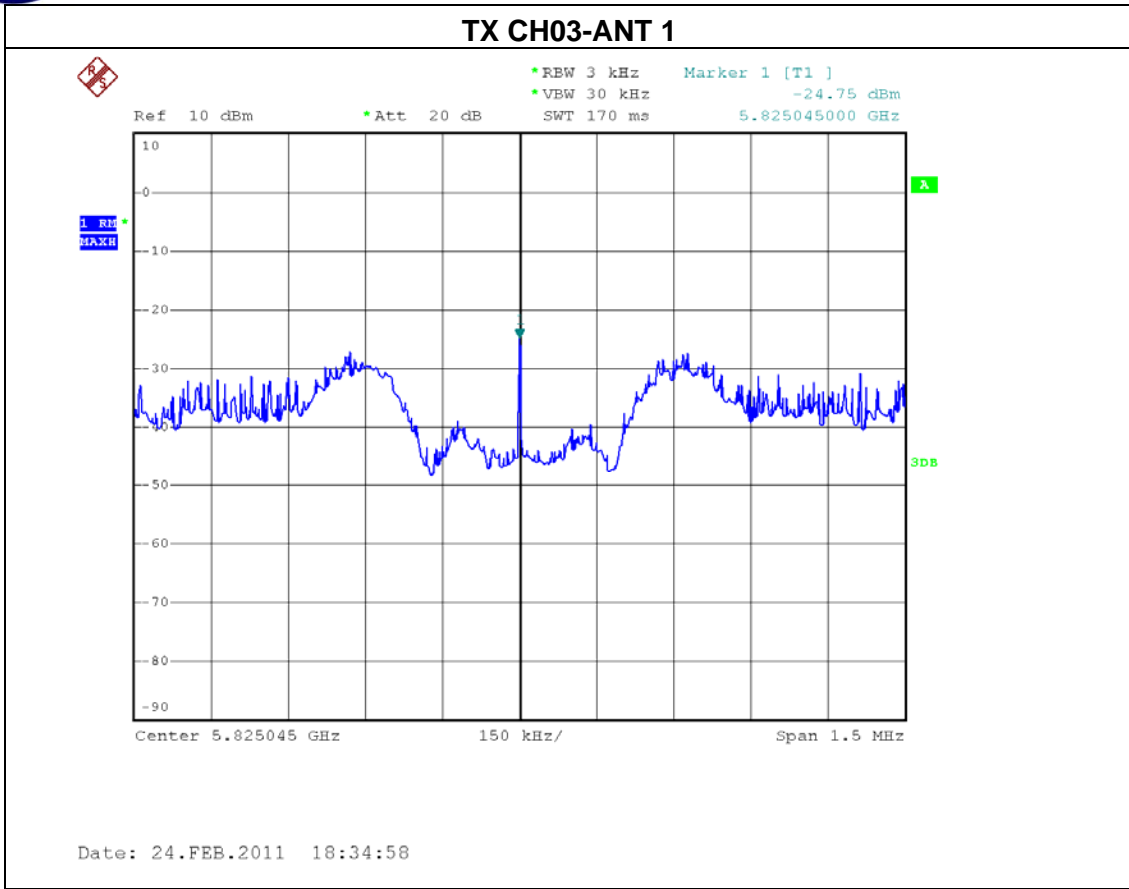

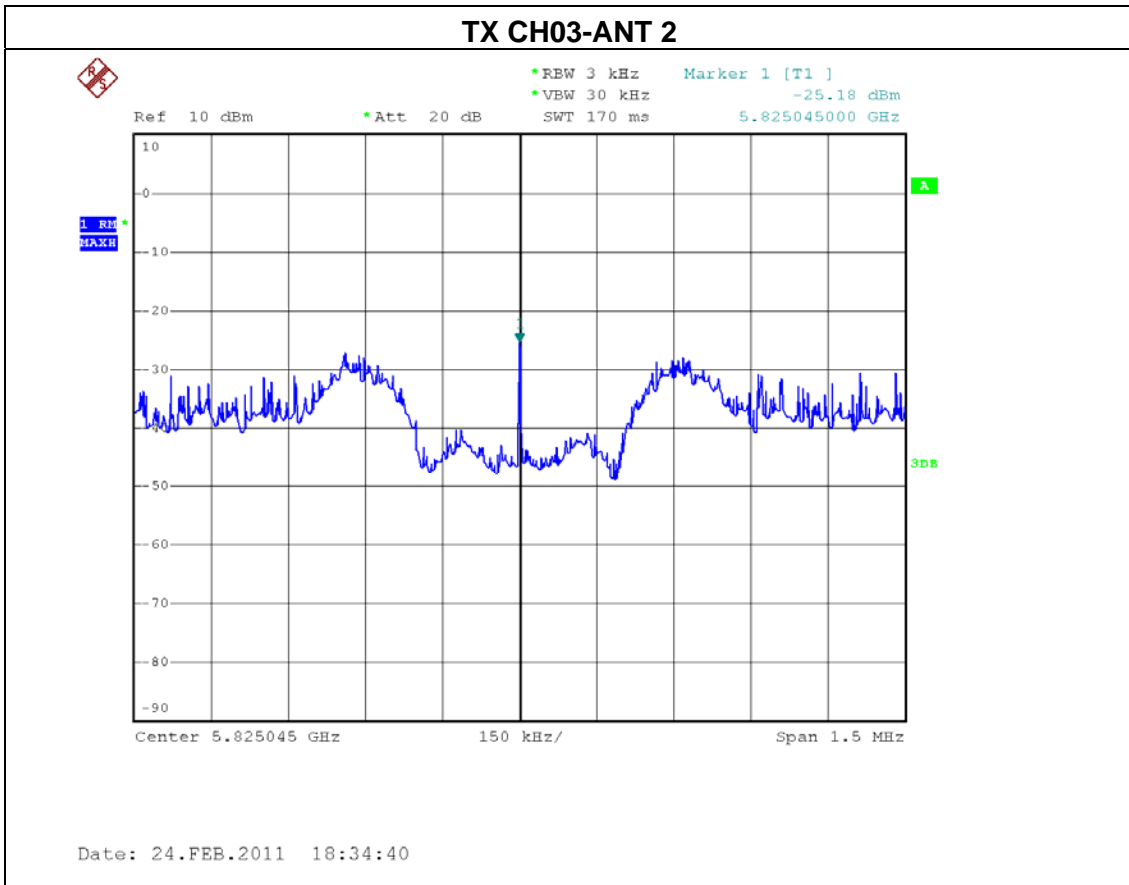
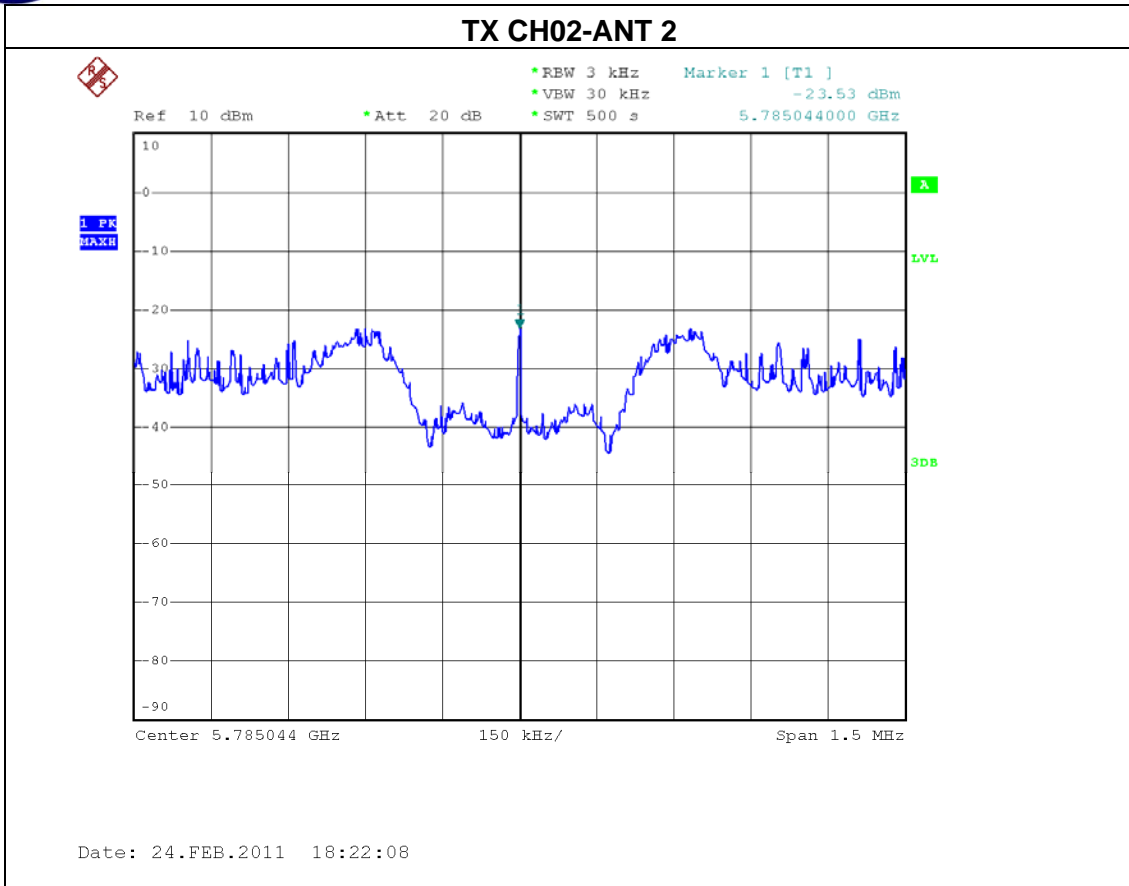



**9. RF EXPOSURE TEST**

**GENERAL CONCLUSION:**

No evaluation required if power is below this threshold:

F(GHz)		P(mW)
Low	5750	10.37
High	5825	

Maximum measured transmitter power:

Average Output Power (dBm)		Average Output Power (mW)
Conducted Power	4.92	3.1046
EIRP Power	6.92	4.9204

Note: Table for Filed Antenna

Ant.	Brand	Model Name	Antenna Type	Connector	Gain (dBi)
1	Jiaxing Jiali	LA5220P5510-A1 5	Multi-layer Ceramics	N/A	2.0

Threshold for no SAR evaluation is 10.37mW.

Transmitter power is 3.1046 mW.

**Conclusion: No SAR evaluation required since transmitter power is below FCC threshold**



**10. EUT TEST PHOTO**

**Conducted Measurement Photos**

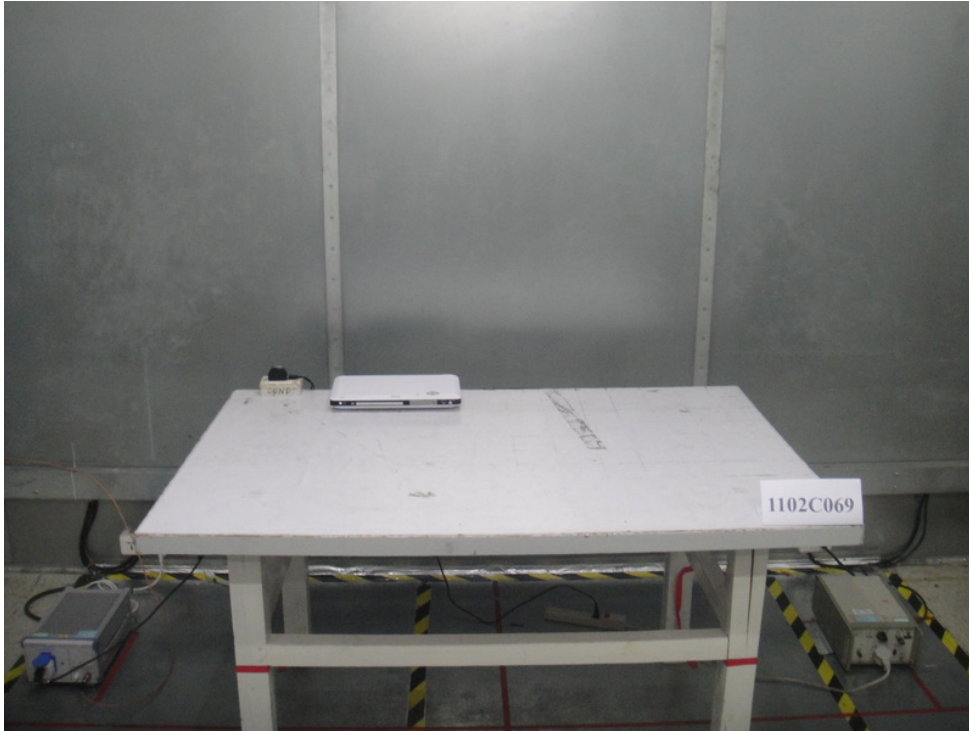



**Radiated Measurement Photos**

