



FCC RADIO TEST REPORT

FCC ID: Y36FD4003

Product : Wireless Mouse

Trade Name : N/A

Model Name : FD4003

Serial Model : N/A

Report No. : NTEK-2012NT1207017F

Prepared for

China Etech Groups Ltd.

4th Floor, A3 Building, Huafeng centery Industrial park, Xixiang town,
Bao'an district, Shenzhen City, China

Prepared by

Shenzhen NTEK Testing Technology Co., Ltd.

1/F, Building E, Fenda Science Park, Sanwei Community, Xixiang Street
Bao'an District, Shenzhen P.R. China

Tel.: +86-0755-61156588 Fax.: +86-0755-61156599

Website: www.ntek.org.cn

TEST RESULT CERTIFICATION

Applicant's name : China Etech Groups Ltd.
Address : 4th Floor, A3 Building, Huafeng centery Industrial park, Xixiang town, Bao'an district, Shenzhen City, China
Manufacture's Name..... : China Etech Groups Ltd.
Address : 4th Floor, A3 Building, Huafeng centery Industrial park, Xixiang town, Bao'an district, Shenzhen City, China

Product description

Product name..... : Wireless Mouse
Model and/or type reference : FD4003
Serial Model : N/A

Standards : FCC Part15.249

Test procedure ANSI C63.4-2003

This device described above has been tested by NTEK, and the test results show that the equipment under test (EUT) is in compliance with the FCC requirements. And it is applicable only to the tested sample identified in the report.

This report shall not be reproduced except in full, without the written approval of NTEK, this document may be altered or revised by NTEK, personal only, and shall be noted in the revision of the document.

Date of Test :
Date (s) of performance of tests : 25 Nov. 2012 ~03 Dec. 2012
Date of Issue..... : 04 Dec. 2012
Test Result..... : **Pass**

Testing Engineer : Apple Huang
(Apple Huang)

Technical Manager : Tom Zhang
(Tom Zhang)

Authorized Signatory : Bovey Yang
(Bovey Yang)

Table of Contents

Page

1 . SUMMARY OF TEST RESULTS	4
1.1 TEST FACILITY	5
1.2 MEASUREMENT UNCERTAINTY	5
2 . GENERAL INFORMATION	6
2.1 GENERAL DESCRIPTION OF EUT	6
2.2 DESCRIPTION OF TEST MODES	8
2.3 BLOCK DIGRAM SHOWING THE CONFIGURATION OF SYSTEM TESTED	9
2.4 DESCRIPTION OF SUPPORT UNITS(CONDUCTED MODE)	10
2.5 EQUIPMENTS LIST FOR ALL TEST ITEMS	11
3 . ANTENNA REQUIREMENT	12
3.1 STANDARD REQUIREMENT	12
3.2 EUT ANTENNA	12
3.3 CONDUCTED EMISSION MEASUREMENT	13
3.3.1 POWER LINE CONDUCTED EMISSION LIMITS	13
3.3.2 TEST PROCEDURE	14
3.3.3 DEVIATION FROM TEST STANDARD	14
3.3.4 TEST SETUP	14
3.2.5 TEST RESULT	15
3.4 RADIATED EMISSION MEASUREMENT	16
3.4.1 RADIATED EMISSION LIMITS	16
3.4.2 TEST PROCEDURE	17
3.4.3 DEVIATION FROM TEST STANDARD	17
3.4.4 TEST SETUP	18
3.4.5 TEST RESULTS (BLOW 30MHZ)	20
3.4.6 TEST RESULTS (BETWEEN 30 – 1000 MHZ)	21
3.4.7 TEST RESULTS (ABOVE 1000 MHZ)	27
3.4.8 TEST RESULTS (RESTRICTED BANDS REQUIREMENTS)	33
4 . BANDWIDTH TEST	37
4.1 TEST PROCEDURE	37
4.2 DEVIATION FROM STANDARD	37
4.3 TEST SETUP	37
4.4 TEST RESULTS	38
5 . EUT TEST PHOTO	41
APPENDIX-PHOTOGRAPHS OF EUT CONSTRUCTIONAL DETAILS	

1. SUMMARY OF TEST RESULTS

Test procedures according to the technical standards:

FCC Part15, Subpart C (15.249)			
Standard Section	Test Item	Judgment	Remark
15.207	Conducted Emission	N/A	
15.203	Antenna Requirement	Pass	
15.249	Radiated Spurious Emission	Pass	
15.205	Band Edge Emission	Pass	
15.249	Occupied Bandwidth	Pass	

1.1 TEST FACILITY

NTEK Testing Technology Co., Ltd

Add. : 1/F, Building E, Fenda Science Park, Sanwei Community, Xixiang Street, Bao'an District, Shenzhen P.R. China.

FCC Registration No.:238937; IC Registration No.:9270A-1

CNAS Registration No.:L5516

1.2 MEASUREMENT UNCERTAINTY

The reported uncertainty of measurement $y \pm U$, where expanded uncertainty U is based on a standard uncertainty multiplied by a coverage factor of $k=2$, providing a level of confidence of approximately **95 %**.

No.	Item	Uncertainty
1	Conducted Emission Test	$\pm 1.38\text{dB}$
2	RF power,conducted	$\pm 0.16\text{dB}$
3	Spurious emissions,conducted	$\pm 0.21\text{dB}$
4	All emissions,radiated(<1G)	$\pm 4.68\text{dB}$
5	All emissions,radiated(>1G)	$\pm 4.89\text{dB}$
6	Temperature	$\pm 0.5^{\circ}\text{C}$
7	Humidity	$\pm 2\%$

2. GENERAL INFORMATION

2.1 GENERAL DESCRIPTION OF EUT

Equipment	Wireless Mouse	
Trade Name	N/A	
Model Name	FD4003	
Serial Model	N/A	
Model Difference	N/A	
Product Description	The EUT is a Wireless Mouse	
	Operation Frequency:	2402~2480MHz
	Modulation Type:	GFSK
	Antenna Designation:	PCB Antenna
	Antenna Gain(Peak)	0.85 dBi
	EIRP	85.76dbuv/m@3m(Average)
Based on the application, features, or specification exhibited in User's Manual, the EUT is considered as an ITE/Computing Device. More details of EUT technical specification, please refer to the User's Manual.		
Rating	DC 1.5V	
Channel List	Please refer to the Note 2.	
Adapter	N/A	
Battery	1.5V*1cell "AA" alkaline battery	

Note:

1. For a more detailed features description, please refer to the manufacturer's specifications or the User's Manual.

2.

Frequency Group				Unit
2402	2422	2449	2462	[MHz]
2403	2423	2443	2463	
2404	2424	2444	2464	
2405	2425	2445	2465	
2406	2426	2446	2466	
2407	2427	2449	2467	
2408	2428	2450	2470	
2410	2431	2451	2471	
2412	2432	2452	2472	
2413	2433	2453	2473	
2414	2434	2454	2474	
2415	2435	2455	2475	
2416	2436	2456	2476	
2417	2437	2457	2477	
2418	2438	2460	2478	
2421	2440	2461	2480	

3.

Table for Filed Antenna

Ant	Brand	Model Name	Antenna Type	Connector	Gain (dBi)	NOTE
1	N/A	N/A	PCB Antenna	NA	0.85	Antenna

2.2 DESCRIPTION OF TEST MODES

To investigate the maximum EMI emission characteristics generates from EUT, the test system was pre-scanning tested base on the consideration of following EUT operation mode or test configuration mode which possible have effect on EMI emission level. Each of these EUT operation mode(s) or test configuration mode(s) mentioned above was evaluated respectively.

Pretest Mode	Description
Mode 1	Low
Mode 2	Mid
Mode 3	High

For Conducted Emission	
Final Test Mode	Description
N/A	N/A

For Radiated Emission	
Final Test Mode	Description
Mode 1	Low
Mode 2	Mid
Mode 3	High

Note:

- (1) The measurements are performed at the highest, middle, lowest available channels. The worst data will reported.
- (2) The EUT use new battery.

2.3 BLOCK DIGRAM SHOWING THE CONFIGURATION OF SYSTEM TESTED

Radiated Spurious Emission Test

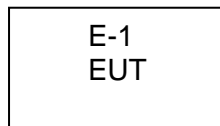

2.4 DESCRIPTION OF SUPPORT UNITS(CONDUCTED MODE)

The EUT has been tested as an independent unit together with other necessary accessories or support units. The following support units or accessories were used to form a representative test configuration during the tests.

Item	Equipment	Mfr/Brand	Model/Type No.	Series No.	Note
E-1	Wireless Mouse	N/A	FD4003	N/A	EUT

Item	Shielded Type	Ferrite Core	Length	Note

Note:

- (1) The support equipment was authorized by Declaration of Confirmation.
- (2) For detachable type I/O cable should be specified the length in cm in 『Length』 column.

2.5 EQUIPMENTS LIST FOR ALL TEST ITEMS

Radiation Test equipment

Item	Kind of Equipment	Manufacturer	Type No.	Serial No.	Calibrated until
1	Spectrum Analyzer	Agilent	E4407B	160400005	Jul. 06. 2013
2	Test Receiver	R&S	ESPI	101318	Jul. 06. 2013
3	Bilog Antenna	TESEQ	CBL6111D	31216	Jul. 06. 2013
4	50Ω Coaxial Switch	Anritsu	MP59B	6200264416	Jul. 06. 2013
5	Spectrum Analyzer	ADVANTEST	R3132	150900201	Jul. 06. 2013
6	Horn Antenna	EM	EM-AH-10180	2011071402	Jul. 06. 2013
7	Horn Ant	Schwarzbeck	BBHA 9170	9170-181	Jul. 06. 2013
8	Amplifier	EM	EM-30180	060538	Jul. 06. 2013
9	Loop Antenna	ARA	PLA-1030/B	1029	Jul. 06. 2013
10	Power Meter	R&S	NRVS	100696	Jul. 06. 2013

Conduction Test equipment

Item	Kind of Equipment	Manufacturer	Type No.	Serial No.	Calibrated until
1	Test Receiver	R&S	ESCI	101160	Jul. 06. 2013
2	LISN	R&S	ENV216	101313	Jul. 06. 2013
3	LISN	EMCO	3816/2	00042990	Jul. 06. 2013
4	50Ω Coaxial Switch	Anritsu	MP59B	6200264417	Jul. 06. 2013
5	Passive Voltage Probe	R&S	ESH2-Z3	100196	Jul. 06. 2013
6	Absorbing clamp	R&S	MOS-21	100423	Jul. 06. 2013

3. ANTENNA REQUIREMENT

3.1 STANDARD REQUIREMENT

15.203 requirement: For intentional device, according to 15.203: an intentional radiator shall be designed to ensure that no antenna other than that furnished by the responsible party shall be used with the device.

3.2 EUT ANTENNA

The EUT antenna is internal Antenna. It comply with the standard requirement.

3.3 CONDUCTED EMISSION MEASUREMENT

3.3.1 POWER LINE CONDUCTED EMISSION Limits (Frequency Range 150KHz-30MHz)

FREQUENCY (MHz)	Class A (dBuV)		Class B (dBuV)		Standard
	Quasi-peak	Average	Quasi-peak	Average	
0.15 -0.5			66 - 56 *	56 - 46 *	CISPR
0.50 -5.0			56.00	46.00	CISPR
5.0 -30.0			60.00	50.00	CISPR

0.15 -0.5			66 - 56 *	56 - 46 *	LP002.
0.50 -5.0			56.00	46.00	LP002.
5.0 -30.0			60.00	50.00	LP002.

Note:

- (1) The tighter limit applies at the band edges.
- (2) The limit of " * " marked band means the limitation decreases linearly with the logarithm of the frequency in the range.

The following table is the setting of the receiver

Receiver Parameters	Setting
Attenuation	10 dB
Start Frequency	0.15 MHz
Stop Frequency	30 MHz
IF Bandwidth	9 kHz

3.3.2 TEST PROCEDURE

- a. The EUT was placed 0.4 meters from the horizontal ground plane with EUT being connected to the power mains through a line impedance stabilization network (LISN). All other support equipments powered from additional LISN(s). The LISN provide 50 Ohm/ 50uH of coupling impedance for the measuring instrument.
- b. Interconnecting cables that hang closer than 40 cm to the ground plane shall be folded back and forth in the center forming a bundle 30 to 40 cm long.
- c. I/O cables that are not connected to a peripheral shall be bundled in the center. The end of the cable may be terminated, if required, using the correct terminating impedance. The overall length shall not exceed 1 m.
- d. LISN at least 80 cm from nearest part of EUT chassis.
- e. For the actual test configuration, please refer to the related Item –EUT Test Photos.

3.3.3 DEVIATION FROM TEST STANDARD

No deviation

3.3.4 TEST SETUP

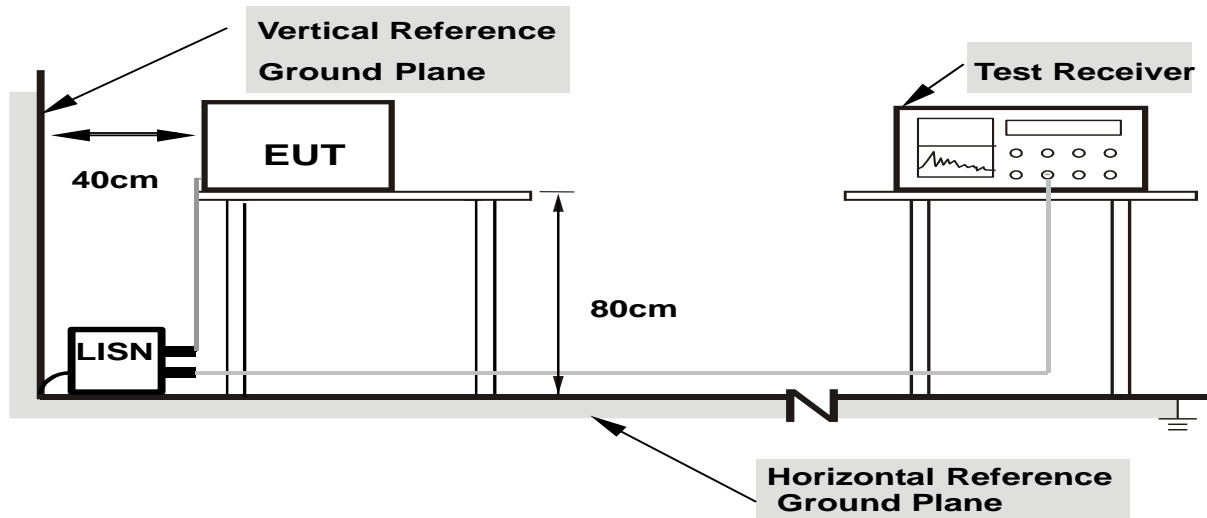

Note: 1. Support units were connected to second LISN.

2. Both of LISNs (AMN) are 80 cm from EUT and at least 80 cm from other units and other metal planes

3.2.5 TEST RESULT

EUT :	Wireless Mouse	Model Name. :	FD4003
Temperature :	26 °C	Relative Humidity :	54%
Pressure :	1010hPa	Phase :	L
Test Voltage :	N/A	Test Mode :	N/A

3.4 RADIATED EMISSION MEASUREMENT

3.4.1 Radiated Emission Limits (FCC 15.209)

Frequencies (MHz)	Field Strength (micorvolts/meter)	Measurement Distance (meters)
0.009~0.490	2400/F(KHz)	300
0.490~1.705	24000/F(KHz)	30
1.705~30.0	30	30
30~88	100	3
88~216	150	3
216~960	200	3
Above 960	500	3

Note:

- (1) The tighter limit applies at the band edges.
- (2) Emission level (dBuV/m)=20log Emission level (uV/m).

LIMITS OF RADIATED EMISSION MEASUREMENT (FCC 15.249)

Frequency of Emission (MHz)	Field Strength of fundamental (millivolts /meter)	Field Strength of Harmonics (microvolts/meter)
2400 - 2483.5	50	500

Notes:

- (1) Emissions radiated outside of the specified frequency bands, except for harmonics, shall be attenuated by at least 50 dB below the level of the fundamental or to the general radiated emission limits in Section 15.209, whichever is the lesser attenuation.

Spectrum Parameter	Setting
Attenuation	Auto
Start Frequency	1000 MHz
Stop Frequency	10th carrier harmonic
RB / VB (emission in restricted band)	1MHz / 1MHz for Peak

Receiver Parameter	Setting
Attenuation	Auto
Start ~ Stop Frequency	9kHz~150kHz / RB 200Hz for QP
Start ~ Stop Frequency	150kHz~30MHz / RB 9kHz for QP
Start ~ Stop Frequency	30MHz~1000MHz / RB 120kHz for QP

3.4.2 TEST PROCEDURE

- a. The measuring distance of at 3 m shall be used for measurements at frequency up to 1GHz. For frequencies above 1GHz, any suitable measuring distance may be used.
- b. The EUT was placed on the top of a rotating table 0.8 meters above the ground at a 3m meter open area test site. The table was rotated 360 degrees to determine the position of the highest radiation.
- c. The height of the equipment or of the substitution antenna shall be 0.8 m; the height of the test antenna shall vary between 1 m to 4 m.
- d. The initial step in collecting conducted emission data is a spectrum analyzer peak detector mode pre-scanning the measurement frequency range. Significant peaks are then marked and then Quasi Peak detector mode re-measured.
- e. If the Peak Mode measured value compliance with and lower than Quasi Peak Mode Limit, the EUT shall be deemed to meet QP Limits and then no additional QP Mode measurement performed.
- f. For the actual test configuration, please refer to the related Item –EUT Test Photos.

Note:

Both horizontal and vertical antenna polarities were tested and performed pretest to three orthogonal axis. The worst case emissions were reported

band edge measurements:

STEP 1 - Perform an in-band field strength measurement of the fundamental emission using the RBW and detector function for the frequency being measured, as required by C63.4 and FCC Rules. For example, for a device operating in the 902-928 MHz band under Section 15.249, use a 120 kHz RBW with a CISPR Quasi-Peak detector. A peak detector with 100 kHz RBW may also be used. For transmitters operating above 1 GHz, use a 1 MHz RBW, a 1 MHz VBW, and a peak detector (as required by Section 15.35). Repeat the measurement with an average detector (i.e., 1 MHz RBW with 10 Hz VBW). Note: For pulsed emissions, other factors (e.g., pulse desensitization correction factor) must be included in the calculations. Also, note that radiated measurements of the fundamental emission of a transmitter operating under 15.247 are not normally required, but they are necessary in connection with this procedure.

STEP 2 - Choose a spectrum analyzer span that encompasses both the peak of the fundamental emission and the band edge emission under investigation. Set the analyzer RBW to 1% of the total span (but never less than 30 kHz) with a video bandwidth equal to or greater than the RBW. Record the peak levels of the fundamental emission and the relevant band edge emission (i.e., run several sweeps in peak hold mode). Observe the stored trace and measure the amplitude delta between the peak of the fundamental and the peak of the band edge emission. This is not a field strength measurement, it is only a relative measurement to determine the amount by which the emission drops at the band edge relative to the highest fundamental emission level.

STEP 3 - Subtract the delta measured in step (2) from the field strengths measured in step (1). The resultant field strengths (CISPR QP, average, or peak, as appropriate) are then used to determine band edge compliance as required by Section 15.205.

STEP 4 - The above delta measurement technique may be used for measuring emissions that are up to two standard bandwidths away from the band edge, where a standard bandwidth is the bandwidth specified by C63.4 for the frequency being measured. For example, for band edge measurements in the restricted band that begins at 2483.5 MHz, C63.4 specifies a measurement bandwidth of at least 1 MHz. Therefore you may use the delta technique for measuring emissions up to 2 MHz removed from the band edge. Radiated emissions that are removed by more than two standard bandwidths must be measured in the conventional manner.

3.4.3 DEVIATION FROM TEST STANDARD

No deviation

3.4.4 TEST SETUP

(A) Radiated Emission Test-Up Frequency Below 30MHz

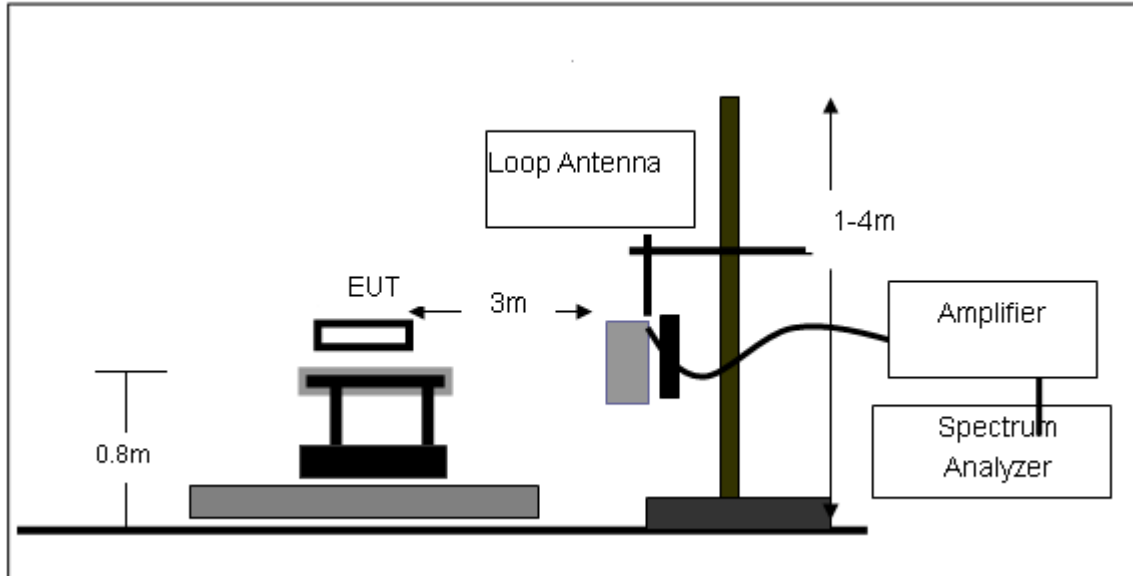

(B) Radiated Emission Test-Up Frequency 30MHz~1GHz

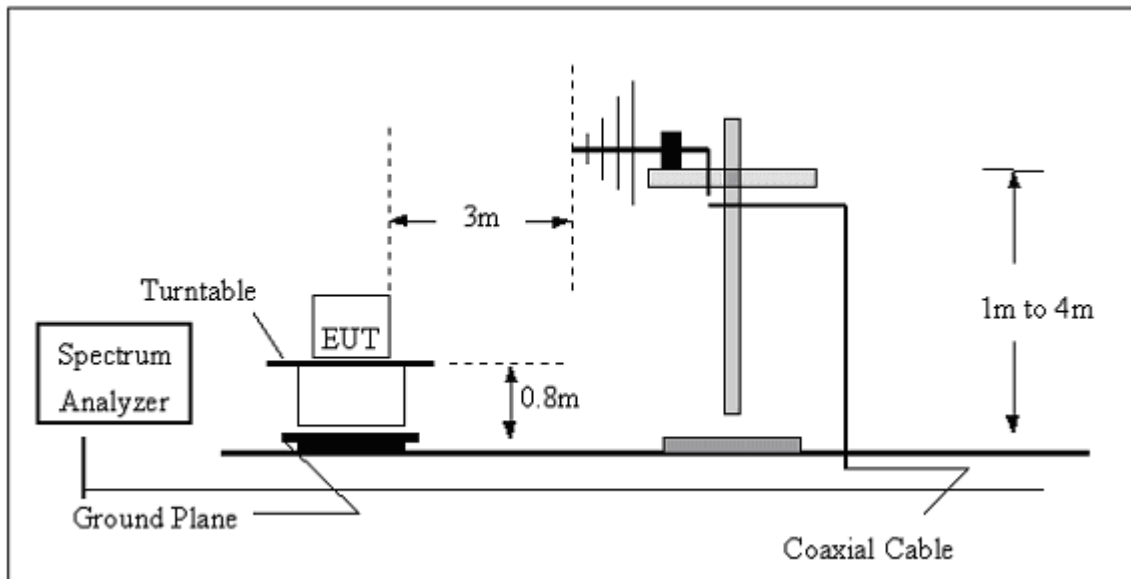

(C) Radiated Emission Test-Up Frequency Above 1GHz

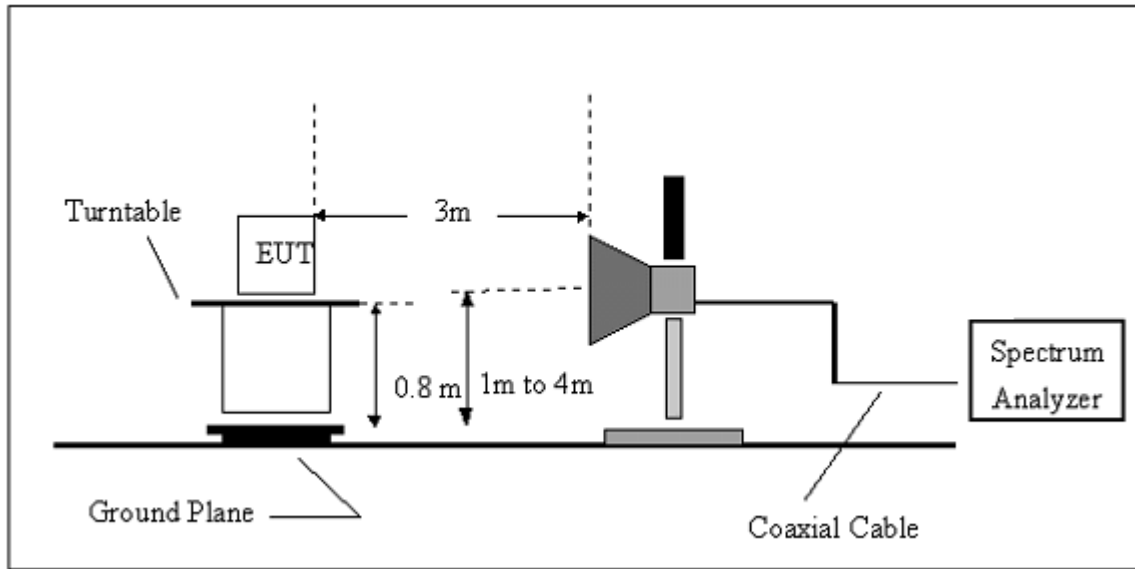

3.4.5 TEST RESULTS (BLOW 30MHz)

EUT :	Wireless Mouse	Model Name. :	FD4003
Temperature :	20 °C	Relative Humidity :	48%
Pressure :	1010 hPa	Test Voltage :	DC 1.5V
Test Mode :	TX	Polarization :	--

Freq.	Reading	Limit	Margin	State
(MHz)	(dBuV/m)	(dBuV/m)	(dB)	P/F
--	--	--	--	PASS
--	--	--	--	PASS

NOTE:

The amplitude of spurious emissions which are attenuated by more than 20dB below the permissible value has no need to be reported.

Distance extrapolation factor = $20 \log (\text{specific distance}/\text{test distance})$ (dB);

Limit line = specific limits(dBuv) + distance extrapolation factor.

3.4.6 TEST RESULTS (BETWEEN 30 – 1000 MHZ)

EUT :	Wireless Mouse	Model Name :	FD4003
Temperature :	20 °C	Relative Humidity :	48%
Pressure :	1010 hPa	Test Voltage :	DC 1.5V
Test Mode :	TX 2402MHz	Polarization :	Vertical

Frequency (MHz)	Meter Reading (dBµV)	Factor (dB)	Emission Level (dBµV/m)	Limits (dBµV/m)	Margin (dB)	Detector Type
104.5361	17.26	11.03	28.29	43.5	-15.21	QP
262.8955	14.15	14.69	28.84	46	-17.16	QP
511.8351	11.22	20.78	32	46	-14	QP

Remark:

1. Factor = Antenna Factor + Cable Loss – Pre-amplifier.

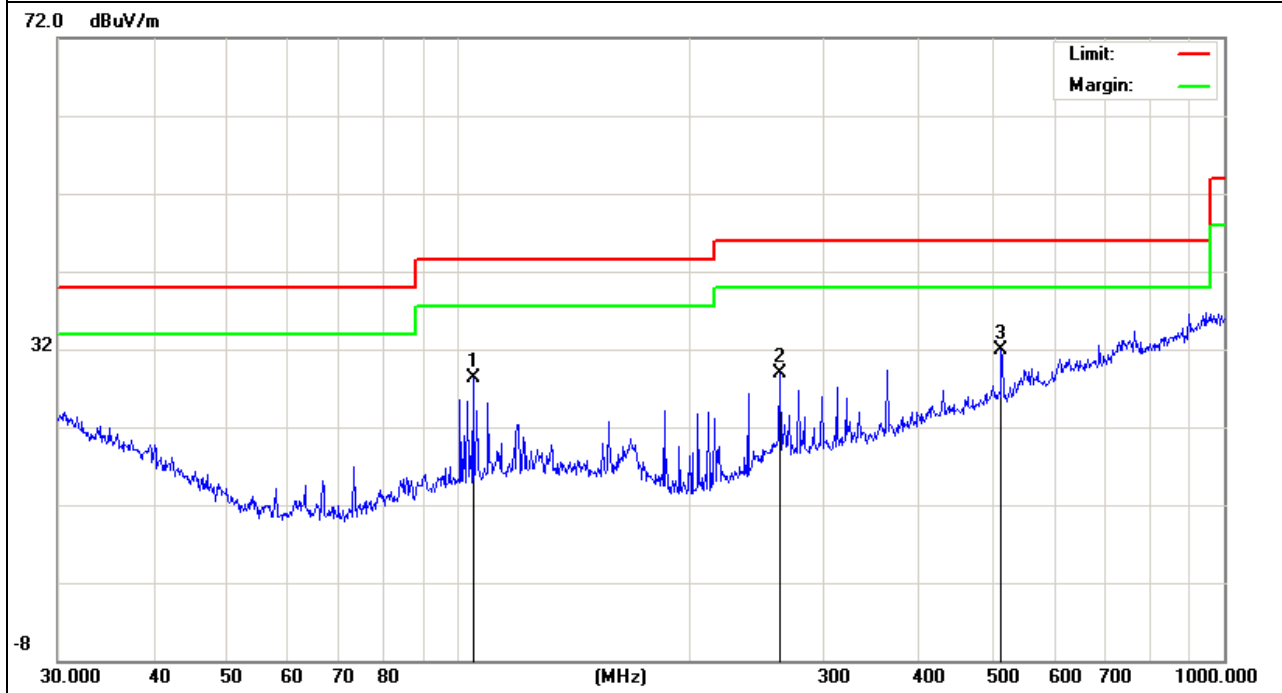

EUT :	Wireless Mouse	Model Name :	FD4003
Temperature :	20 °C	Relative Humidity :	48%
Pressure :	1010 hPa	Test Voltage :	DC 1.5V
Test Mode :	TX 2402MHz	Polarization :	Horizontal

Frequency (MHz)	Meter Reading (dBµV)	Factor (dB)	Emission Level (dBµV/m)	Limits (dBµV/m)	Margin (dB)	Detector Type
159.2247	10.7	11.08	21.78	43.5	-21.72	QP
213.015	17.04	9.82	26.86	43.5	-16.64	QP
359.1859	11.14	16.44	27.58	46	-18.42	QP

Remark:

1. Factor = Antenna Factor + Cable Loss – Pre-amplifier.

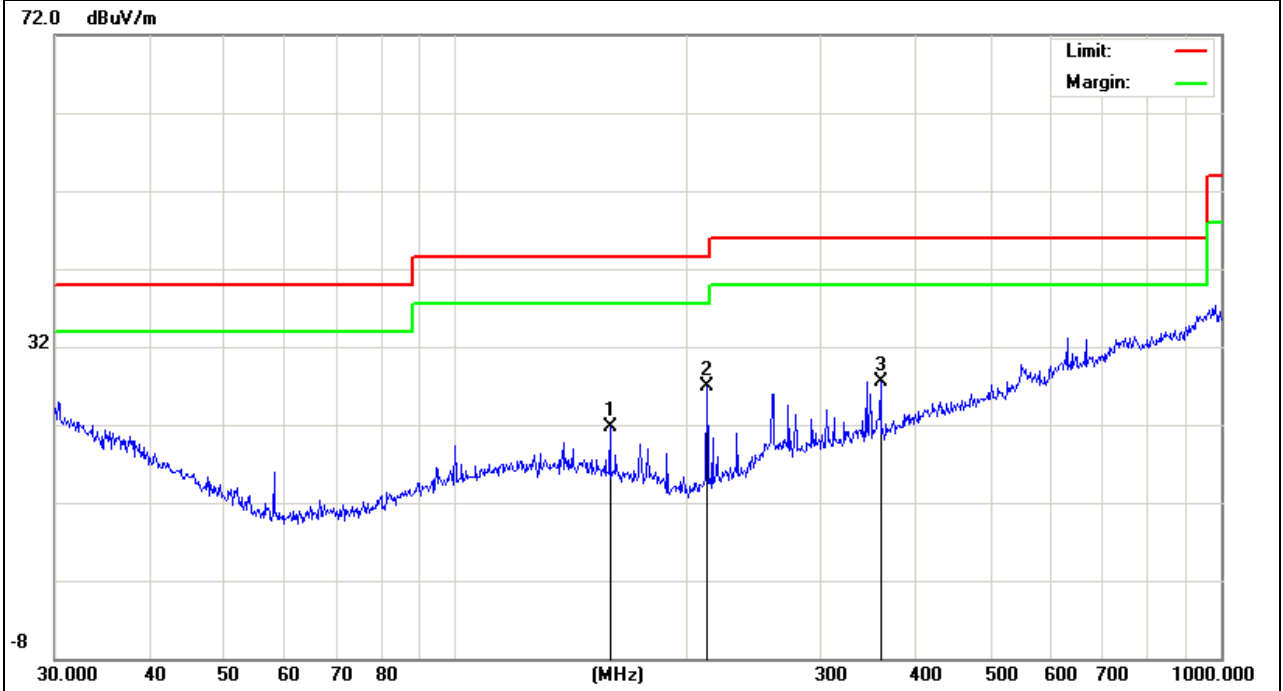

EUT :	Wireless Mouse	Model Name :	FD4003
Temperature :	20 °C	Relative Humidity :	48%
Pressure :	1010 hPa	Test Voltage :	DC 1.5V
Test Mode :	TX 2449MHz	Polarization :	Vertical

Frequency (MHz)	Meter Reading (dBµV)	Factor (dB)	Emission Level (dBµV/m)	Limits (dBµV/m)	Margin (dB)	Detector Type
135.0319	8.22	12.25	20.47	43.5	-23.03	QP
309.9977	10.89	15.04	25.93	46	-20.07	QP
434.0651	14.4	18.84	33.24	46	-12.76	QP

Remark:

- Factor = Antenna Factor + Cable Loss – Pre-amplifier.

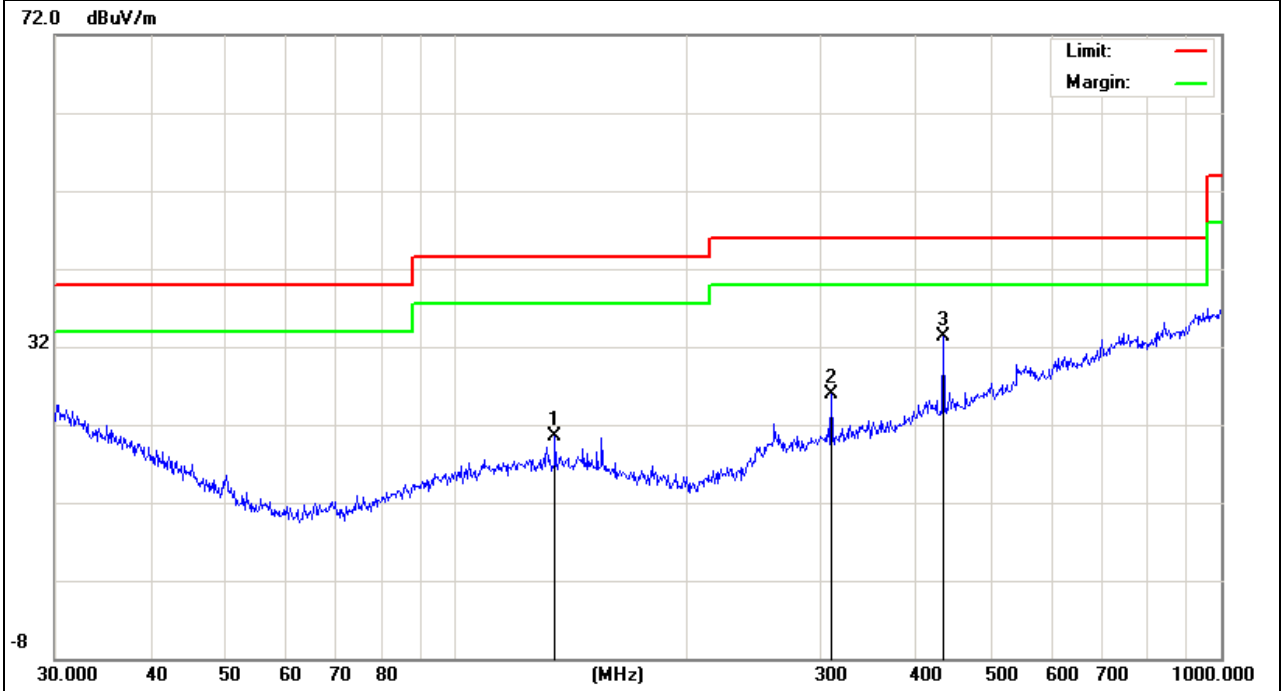

EUT :	Wireless Mouse	Model Name :	FD4003
Temperature :	20 °C	Relative Humidity :	48%
Pressure :	1010 hPa	Test Voltage :	DC 1.5V
Test Mode :	TX 2449MHz	Polarization :	Horizontal

Frequency (MHz)	Meter Reading (dBµV)	Factor (dB)	Emission Level (dBµV/m)	Limits (dBµV/m)	Margin (dB)	Detector Type
53.8818	15.62	6.62	22.24	40	-17.76	QP
134.0882	11.28	12.24	23.52	43.5	-19.98	QP
312.1792	15.1	15.13	30.23	46	-15.77	QP
434.0651	12.89	18.84	31.73	46	-14.27	QP

Remark:

1. Factor = Antenna Factor + Cable Loss – Pre-amplifier.

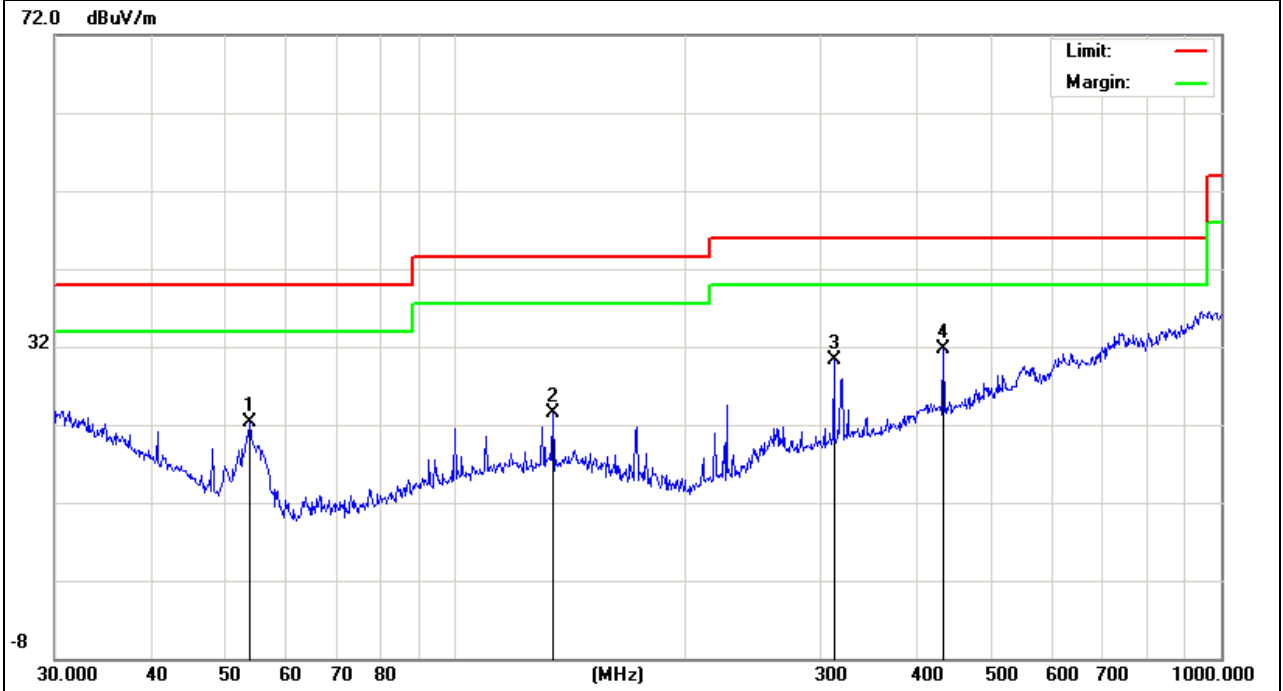

EUT :	Wireless Mouse	Model Name :	FD4003
Temperature :	20 °C	Relative Humidity :	48%
Pressure :	1010 hPa	Test Voltage :	DC 1.5V
Test Mode :	TX 2480MHz	Polarization :	Vertical

Frequency (MHz)	Meter Reading (dBµV)	Factor (dB)	Emission Level (dBµV/m)	Limits (dBµV/m)	Margin (dB)	Detector Type
53.5052	14.63	6.77	21.4	40	-18.6	QP
134.5592	12.48	12.25	24.73	43.5	-18.77	QP
222.9501	19.21	10.58	29.79	46	-16.21	QP
327.8872	13.98	15.76	29.74	46	-16.26	QP

Remark:

1. Factor = Antenna Factor + Cable Loss – Pre-amplifier.

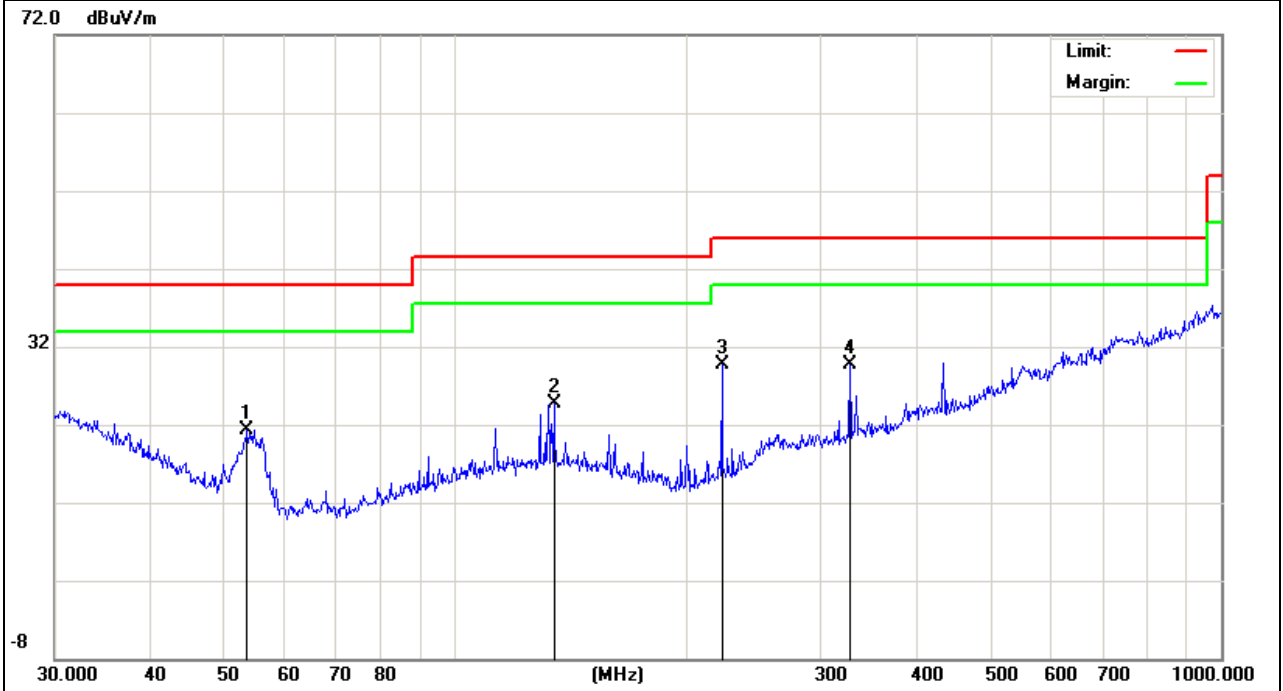

EUT :	Wireless Mouse	Model Name :	FD4003
Temperature :	20 °C	Relative Humidity :	48%
Pressure :	1010 hPa	Test Voltage :	DC 1.5V
Test Mode :	TX 2480MHz	Polarization :	Horizontal

Frequency (MHz)	Meter Reading (dBµV)	Factor (dB)	Emission Level (dBµV/m)	Limits (dBµV/m)	Margin (dB)	Detector Type
159.2251	17.11	11.08	28.19	43.5	-15.31	QP
169.0054	15.66	10.49	26.15	43.5	-17.35	QP
201.393	11.21	9.08	20.29	43.5	-23.21	QP
434.0651	15.18	18.84	34.02	46	-11.98	QP

Remark:

1. Factor = Antenna Factor + Cable Loss – Pre-amplifier.

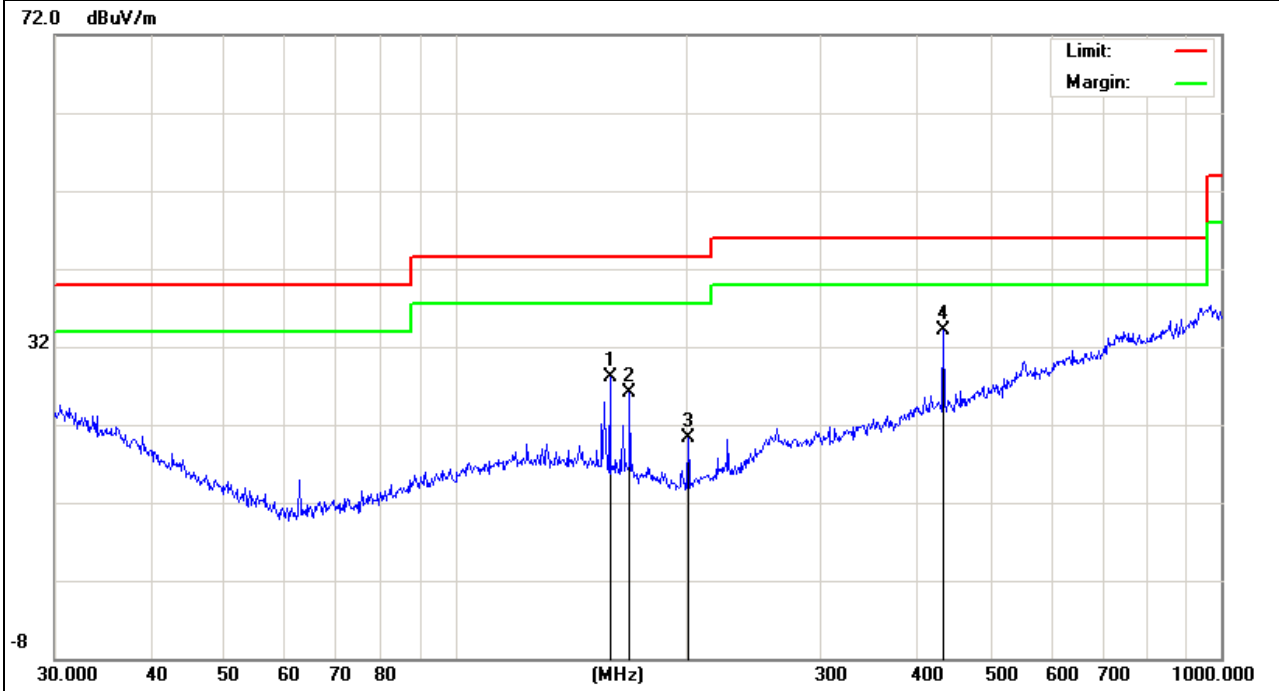

3.4.7 TEST RESULTS (ABOVE 1000 MHZ)

EUT :	Wireless Mouse	Model Name :	FD4003
Temperature :	20 °C	Relative Humidity :	48%
Pressure :	1010 hPa	Test Voltage :	DC 1.5V
Test Mode :	TX /2402MHz	Polarization :	Horizontal

Frequency (MHz)	Meter Reading (dBμV)	Factor (dB)	Emission Level (dBμV/m)	Limits (dBμV/m)	Margin (dB)	Detector Type
2402.125	106.64	-12.99	93.65	114.0 0	-20.35	peak
2402.125	94.51	-12.99	81.52	94.00	-12.48	AVG
4816.000	58.85	-3.62	55.23	74.00	-18.77	peak
4816.000	48.00	-3.62	44.38	54.00	-9.62	AVG

Remark:
 Factor = Antenna Factor + Cable Loss – Pre-amplifier.
 No emission detected above 18GHz.

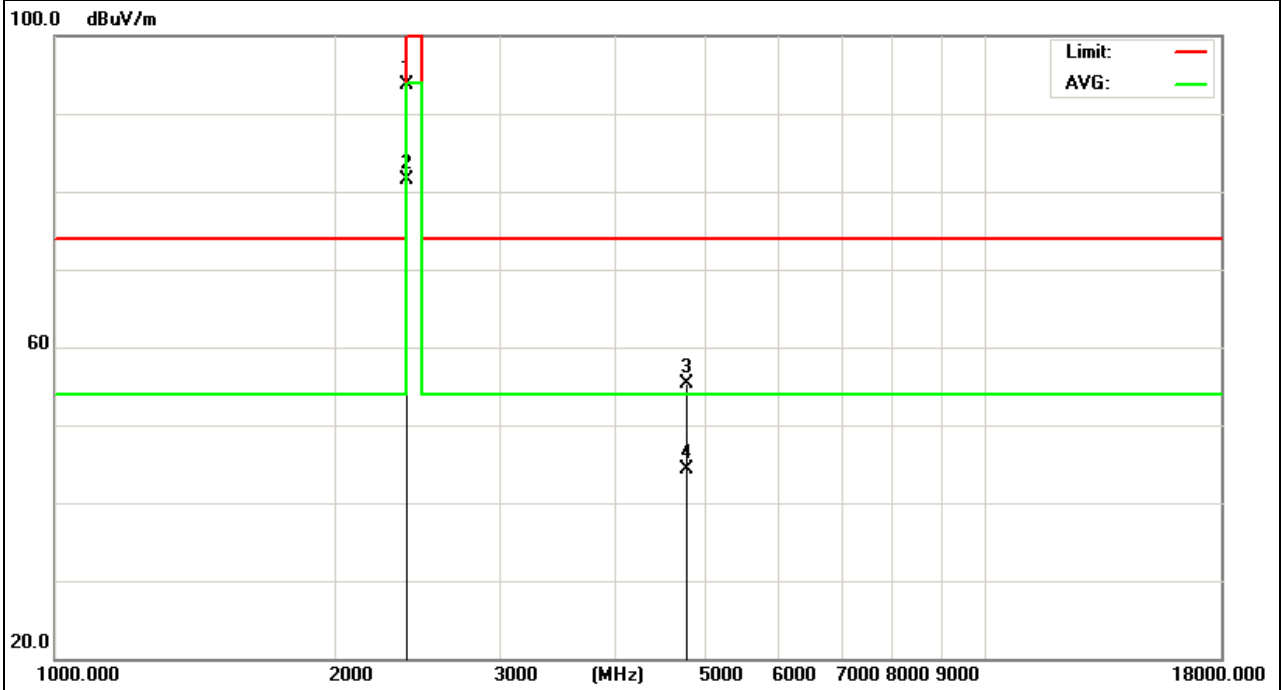

EUT :	Wireless Mouse	Model Name :	FD4003
Temperature :	20 °C	Relative Humidity :	48%
Pressure :	1010 hPa	Test Voltage :	DC 1.5V
Test Mode :	TX /2402MHz	Polarization :	Vertical

Frequency (MHz)	Meter Reading (dBµV)	Factor (dB)	Emission Level (dBµV/m)	Limits (dBµV/m)	Margin (dB)	Detector Type
2402.125	105.35	-12.99	92.36	114.00	-21.64	peak
2402.125	95.36	-12.99	82.37	94.00	-11.63	AVG
4816.000	59.37	-3.62	55.75	74.00	-18.25	peak
4816.000	47.18	-3.62	43.56	54.00	-10.44	AVG

Remark:
 Factor = Antenna Factor + Cable Loss – Pre-amplifier.
 No emission detected above 18GHz.

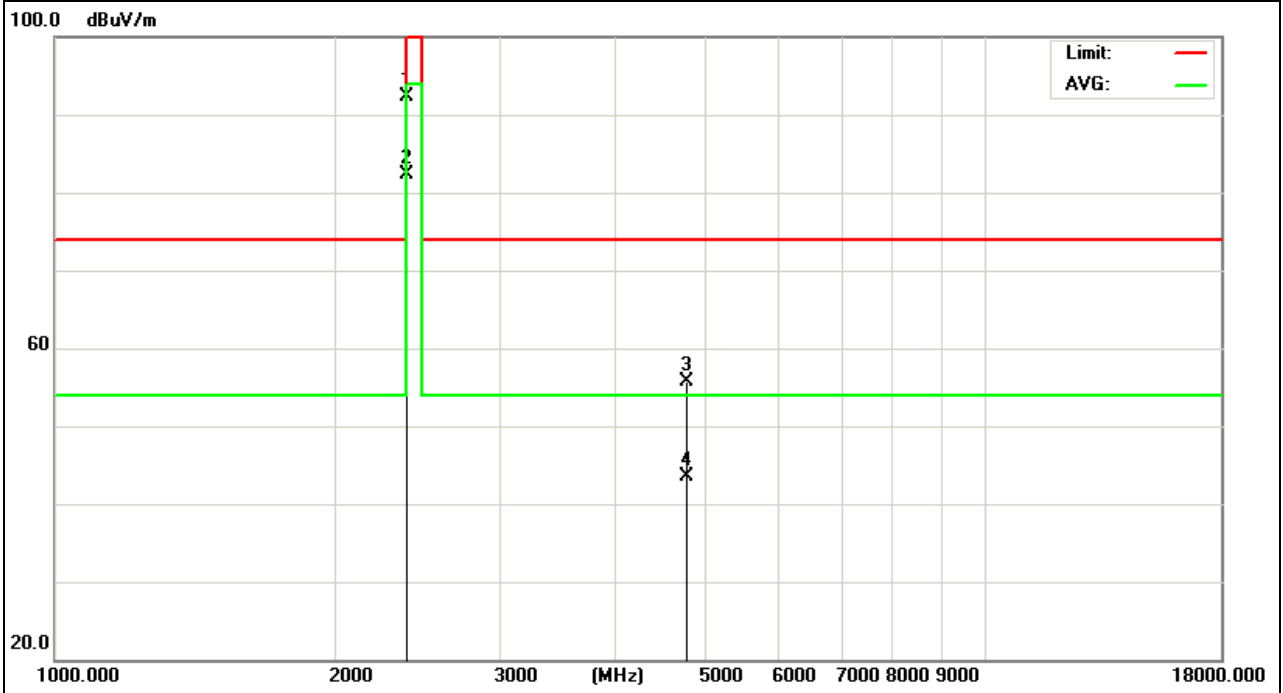

EUT :	Wireless Mouse	Model Name :	FD4003
Temperature :	20 °C	Relative Humidity :	48%
Pressure :	1010 hPa	Test Voltage :	DC 1.5V
Test Mode :	TX /2449MHz	Polarization :	Horizontal

Frequency (MHz)	Meter Reading (dBµV)	Factor (dB)	Emission Level (dBµV/m)	Limits (dBµV/m)	Margin (dB)	Detector Type
2449.000	105.58	-12.92	92.66	114.00	-21.34	peak
2449.000	98.68	-12.92	85.76	94.00	-8.24	AVG
4898.000	56.17	-3.76	52.41	74.00	-21.59	peak
4898.000	45.88	-3.76	42.12	54.00	-11.88	AVG

Remark:
 Factor = Antenna Factor + Cable Loss – Pre-amplifier.
 No emission detected above 18GHz.

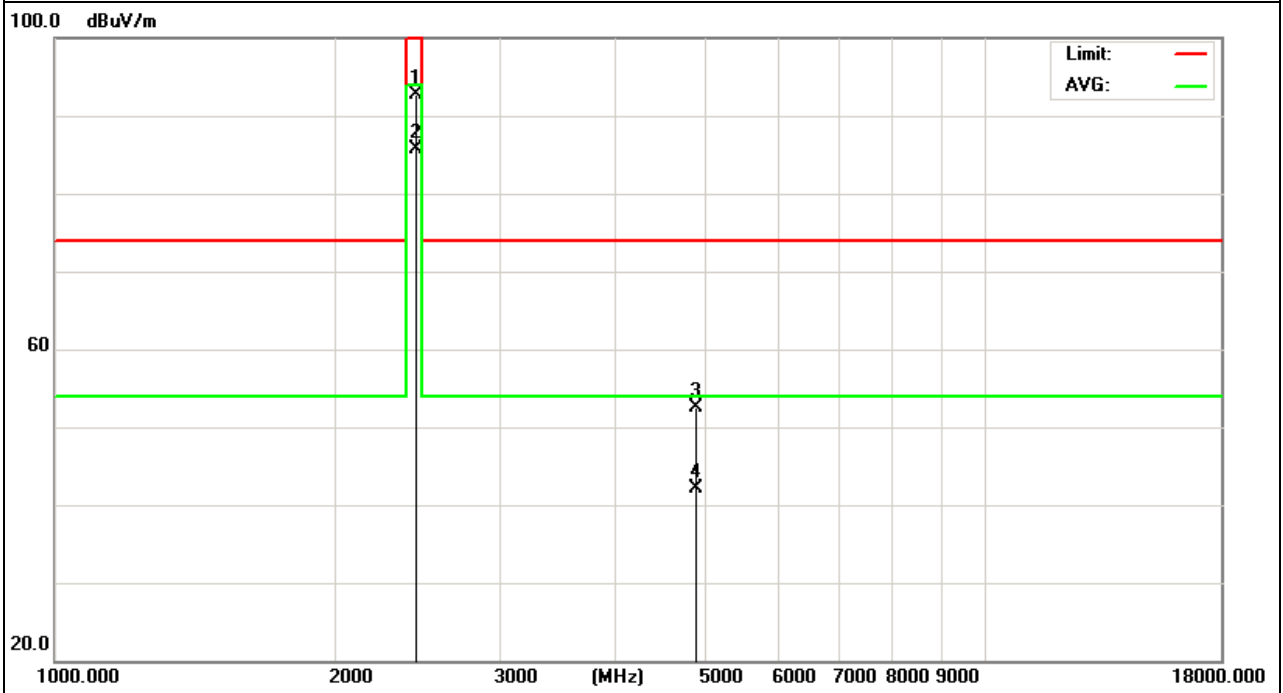

EUT :	Wireless Mouse	Model Name :	FD4003
Temperature :	20 °C	Relative Humidity :	48%
Pressure :	1010 hPa	Test Voltage :	DC 1.5V
Test Mode :	TX /2449MHz	Polarization :	Vertical

Frequency (MHz)	Meter Reading (dBµV)	Factor (dB)	Emission Level (dBµV/m)	Limits (dBµV/m)	Margin (dB)	Detector Type
2449.000	106.39	-12.92	93.47	114.00	-20.53	peak
2449.000	97.54	-12.92	84.62	94.00	-9.38	AVG
4898.000	55.11	-3.760	51.35	74.00	-22.65	peak
4898.000	46.40	-3.760	42.64	54.00	-11.36	AVG

Remark:
 Factor = Antenna Factor + Cable Loss – Pre-amplifier.
 No emission detected above 18GHz.

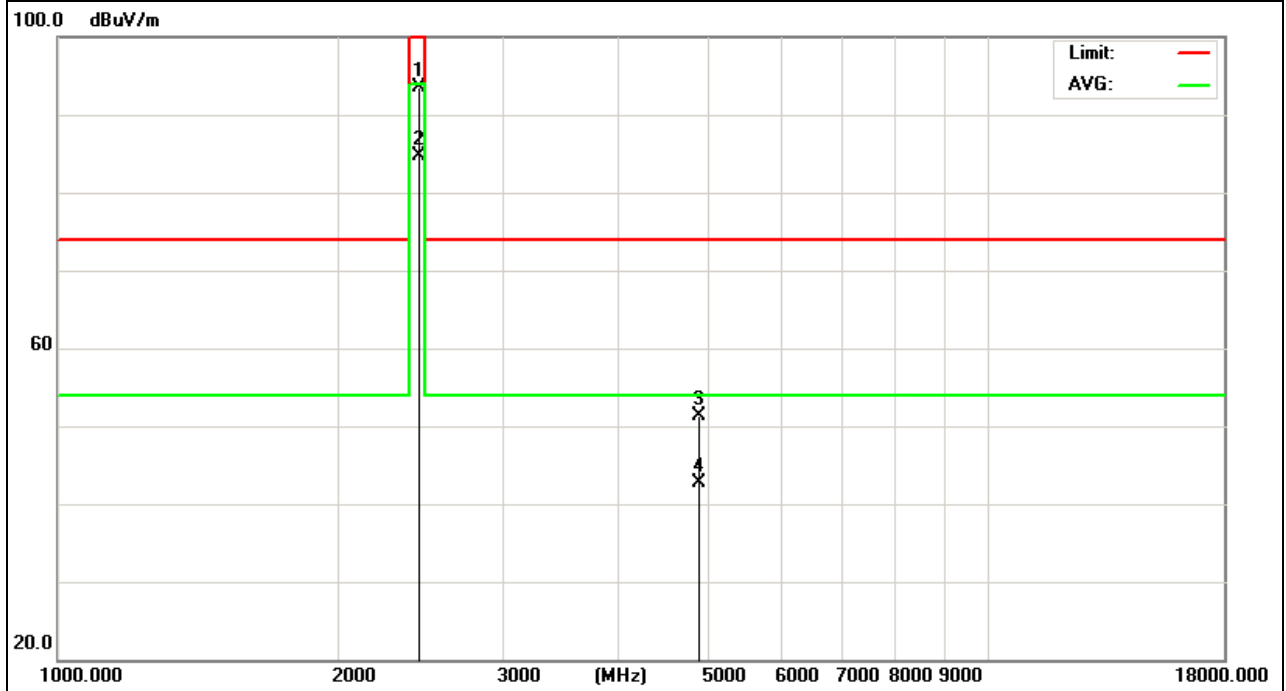

EUT :	Wireless Mouse	Model Name :	FD4003
Temperature :	20 °C	Relative Humidity :	48%
Pressure :	1010 hPa	Test Voltage :	DC 1.5V
Test Mode :	TX /2480MHz	Polarization :	Horizontal

Frequency (MHz)	Meter Reading (dBμV)	Factor (dB)	Emission Level (dBμV/m)	Limits (dBμV/m)	Margin (dB)	Detector Type
2480.000	103.15	-12.79	90.36	114.00	-23.64	peak
2480.000	94.07	-12.79	81.28	94.00	-12.72	AVG
4960.125	56.84	-3.59	53.25	74.00	-20.75	peak
4960.125	46.16	-3.59	42.57	54.00	-11.43	AVG

Remark:
 Factor = Antenna Factor + Cable Loss – Pre-amplifier.
 No emission detected above 18GHz.

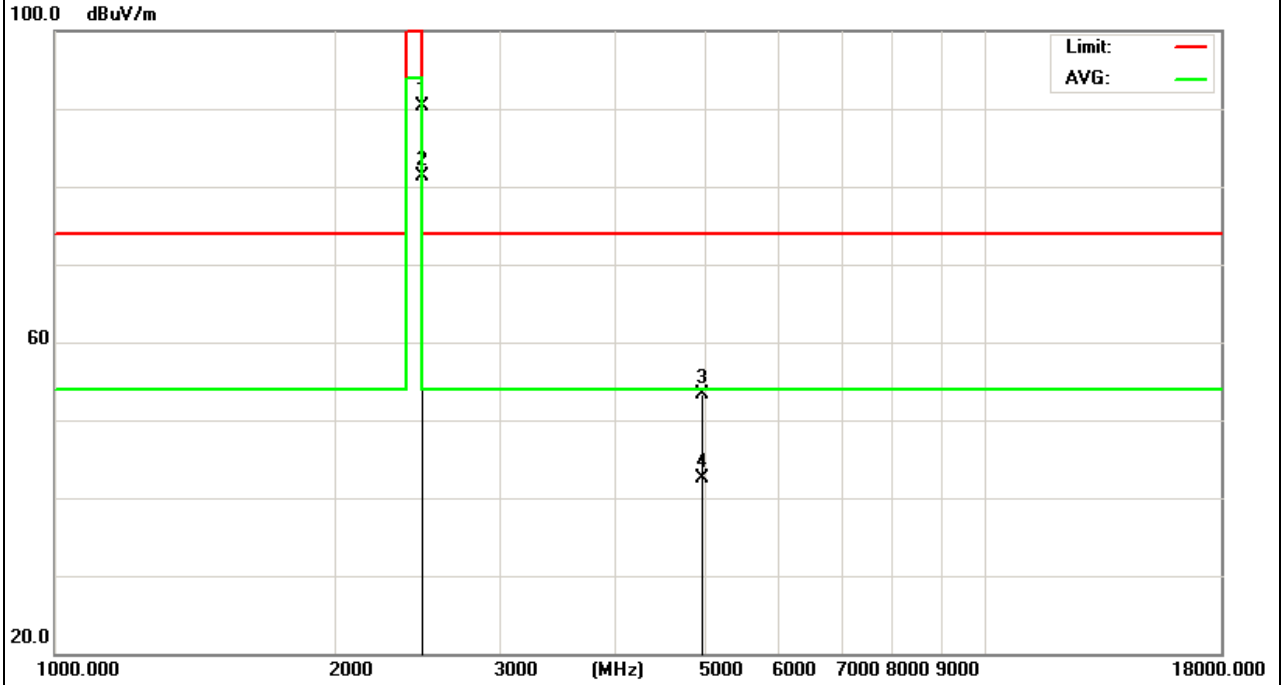

EUT :	Wireless Mouse	Model Name :	FD4003
Temperature :	20 °C	Relative Humidity :	48%
Pressure :	1010 hPa	Test Voltage :	DC 1.5V
Test Mode :	TX /2480MHz	Polarization :	Vertical

Frequency (MHz)	Meter Reading (dBµV)	Factor (dB)	Emission Level (dBµV/m)	Limits (dBµV/m)	Margin (dB)	Detector Type
2480.000	109.18	-12.79	96.39	114.00	-17.61	peak
2480.000	97.14	-12.79	84.35	94.00	-9.65	AVG
4960.000	55.27	-3.59	51.68	74.00	-22.32	peak
4960.000	45.89	-3.59	42.30	54.00	-11.70	AVG

Remark:
 Factor = Antenna Factor + Cable Loss – Pre-amplifier.
 No emission detected above 18GHz.

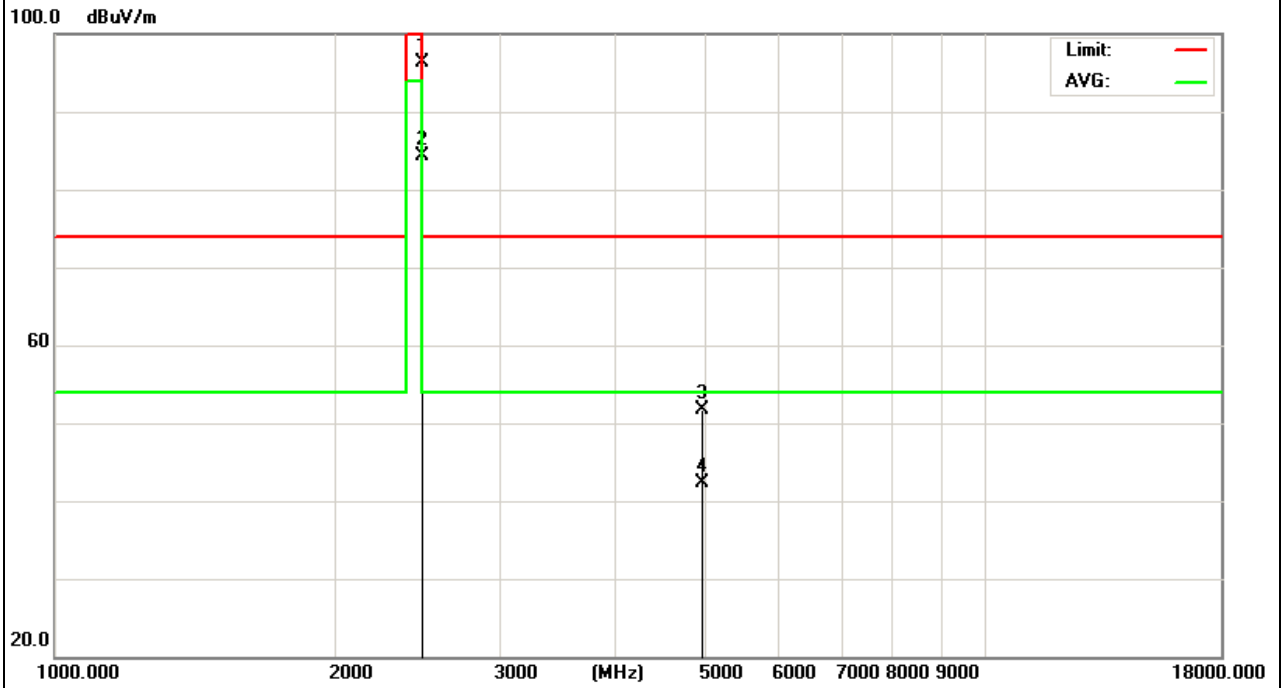

3.4.8 TEST RESULTS (RESTRICTED BANDS REQUIREMENTS)

EUT :	Wireless Mouse	Model Name :	FD4003
Temperature :	20 °C	Relative Humidity :	48%
Pressure :	1010 hPa	Test Voltage :	DC 1.5V
Test Mode :	TX /2402MHz	Polarization :	Vertical

Frequency (MHz)	Meter Reading (dBμV)	Factor (dB)	Emission Level (dBμV/m)	Limits (dBμV/m)	Margin (dB)	Detector Type
2396.96	52.86	-13.02	39.84	74	-34.16	peak
2400	45.34	-12.99	32.35	74	-41.65	peak

Remark:
 Factor = Antenna Factor + Cable Loss – Pre-amplifier.

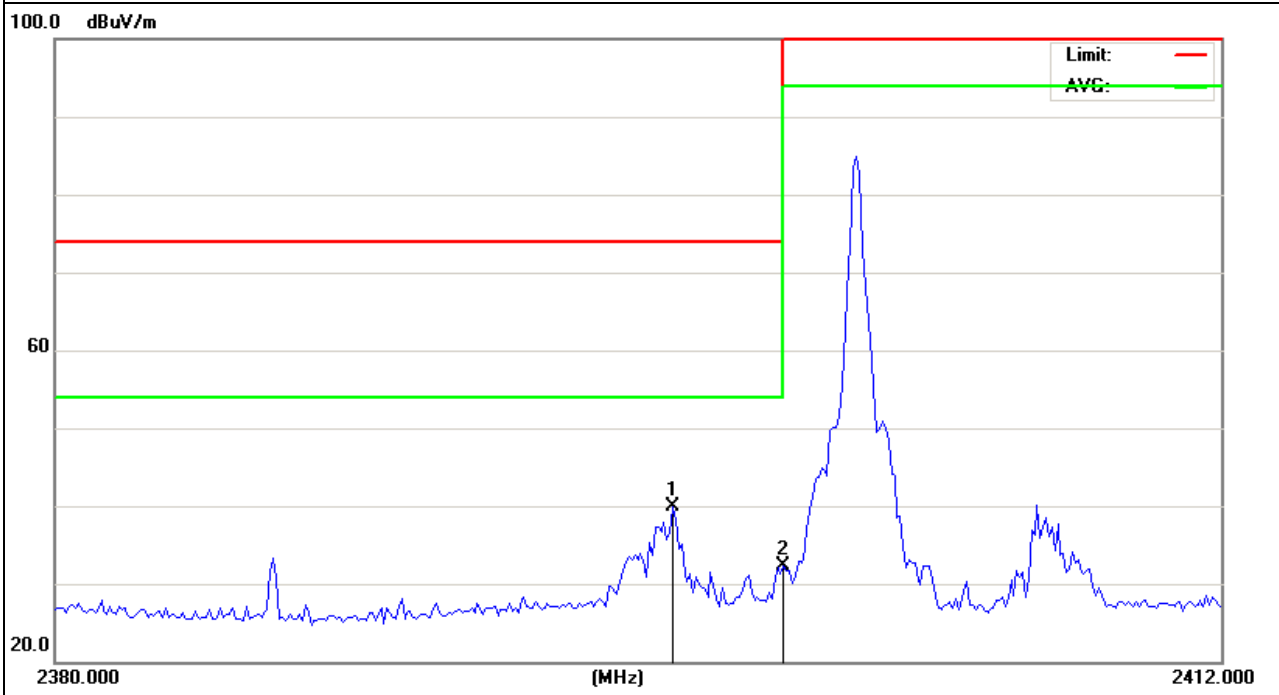

EUT :	Wireless Mouse	Model Name :	FD4003
Temperature :	20 °C	Relative Humidity :	48%
Pressure :	1010 hPa	Test Voltage :	DC 1.5V
Test Mode :	TX /2402MHz	Polarization :	Horizontal

Frequency (MHz)	Meter Reading (dBμV)	Factor (dB)	Emission Level (dBμV/m)	Limits (dBμV/m)	Margin (dB)	Detector Type
2397.12	57.04	-13.02	44.02	74	-29.98	peak
2400	48.08	-12.99	35.09	74	-38.91	peak

Remark:
 Factor = Antenna Factor + Cable Loss – Pre-amplifier.

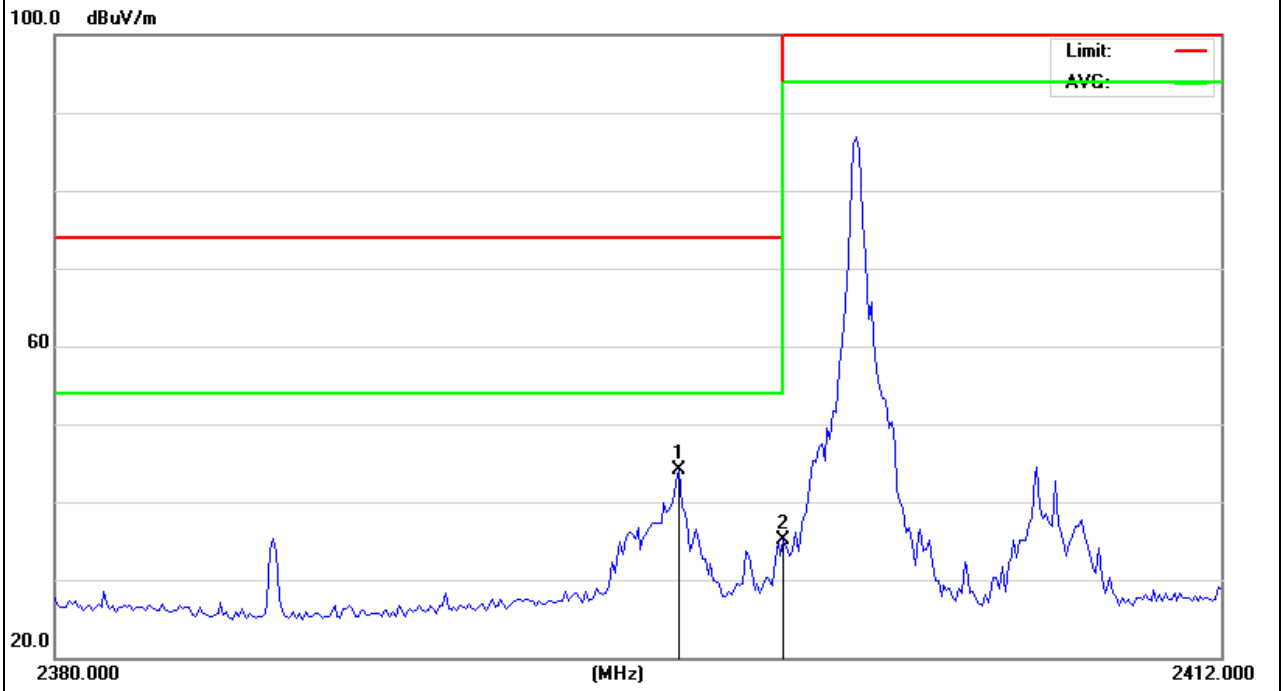

EUT :	Wireless Mouse	Model Name :	FD4003
Temperature :	20 °C	Relative Humidity :	48%
Pressure :	1010 hPa	Test Voltage :	DC 1.5V
Test Mode :	TX /2480MHz	Polarization :	Vertical

Frequency (MHz)	Meter Reading (dBμV)	Factor (dB)	Emission Level (dBμV/m)	Limits (dBμV/m)	Margin (dB)	Detector Type
2483.5	52.01	-12.78	39.23	74	-34.77	peak

Remark:
Factor = Antenna Factor + Cable Loss – Pre-amplifier.



EUT :	Wireless Mouse	Model Name :	FD4003
Temperature :	20 °C	Relative Humidity :	48%
Pressure :	1010 hPa	Test Voltage :	DC 1.5V
Test Mode :	TX /2480MHz	Polarization :	Horizontal

Frequency (MHz)	Meter Reading (dBμV)	Factor (dB)	Emission Level (dBμV/m)	Limits (dBμV/m)	Margin (dB)	Detector Type
2483.5	48.91	-12.78	36.13	74	-37.87	peak

Remark:
Factor = Antenna Factor + Cable Loss – Pre-amplifier.

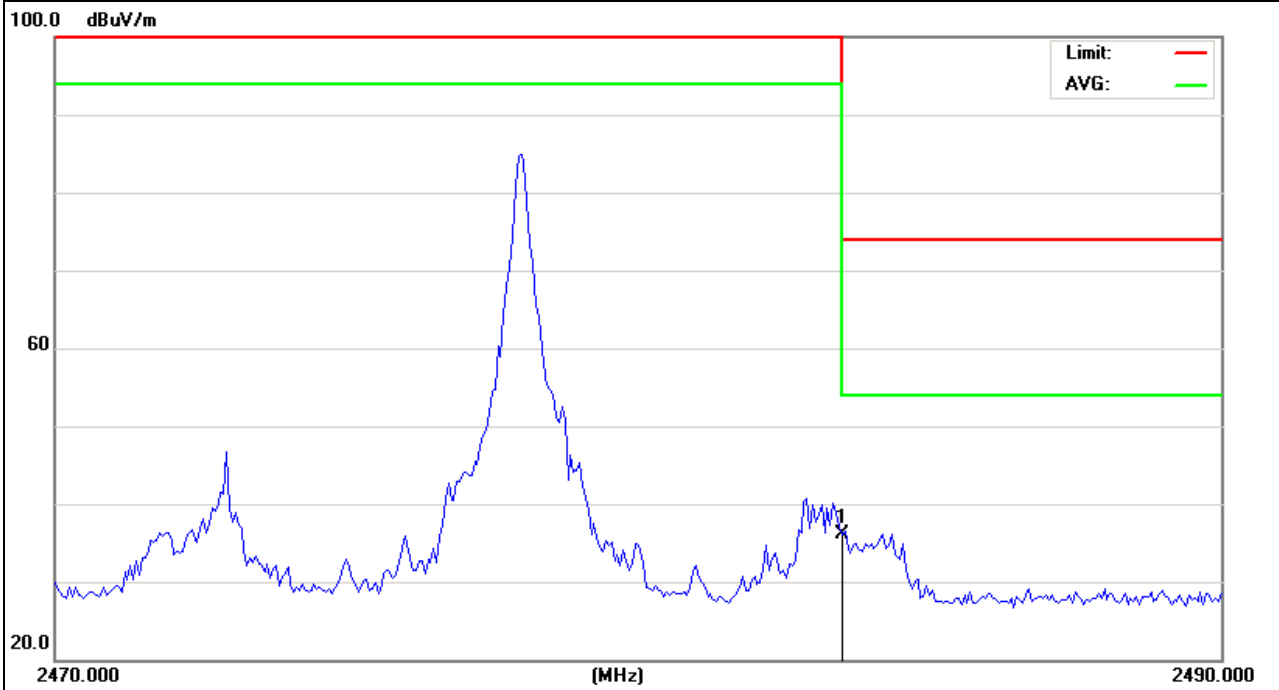

4. BANDWIDTH TEST

4.1 TEST PROCEDURE

- a. The EUT was directly connected to the spectrum analyzer and antenna output port as show in the block diagram below,
- b. Spectrum Setting : RBW= 100KHz, VBW \geq RBW, Sweep time = Auto.

4.2 DEVIATION FROM STANDARD

No deviation.

4.3 TEST SETUP



4.4 TEST RESULTS

EUT :	Wireless Mouse	Model Name :	FD4003
Temperature :	26 °C	Relative Humidity :	53%
Pressure :	1020 hPa	Test Power :	DC 1.5V
Test Channel	Frequency (MHz)	20 dBc Bandwidth (MHz)	99% Bandwidth (MHz)
Low	2402	0.446	0.422
Mid	2449	0.429	0.403
High	2480	0.444	0.414

The Lowest Channel: 2402MHz

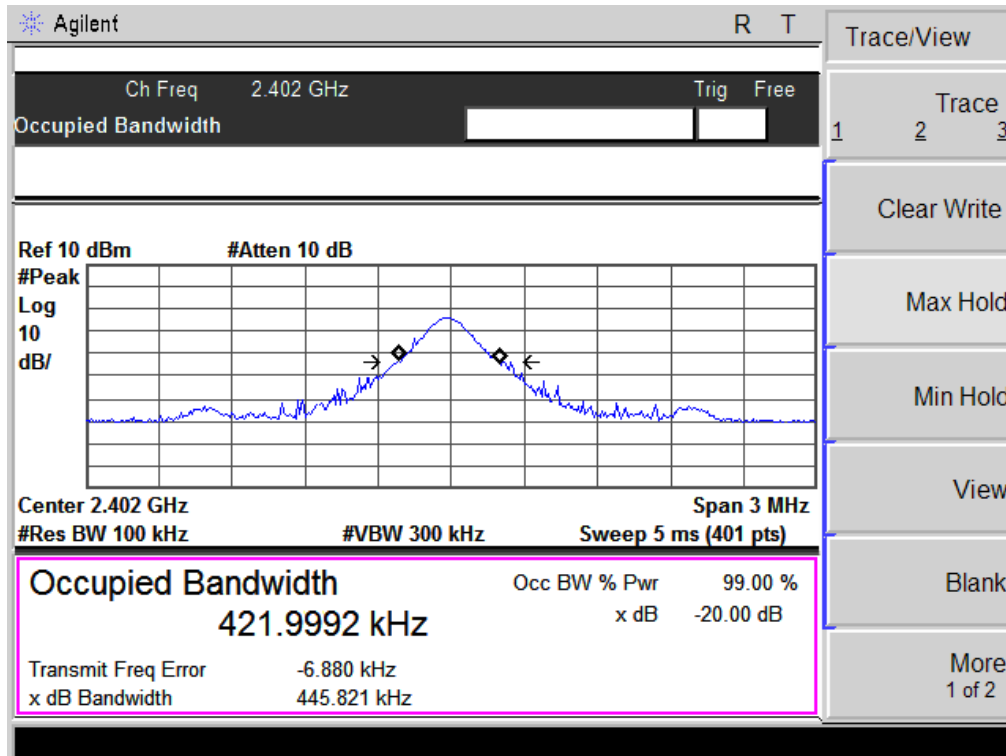

The Middle Channel: 2449MHz

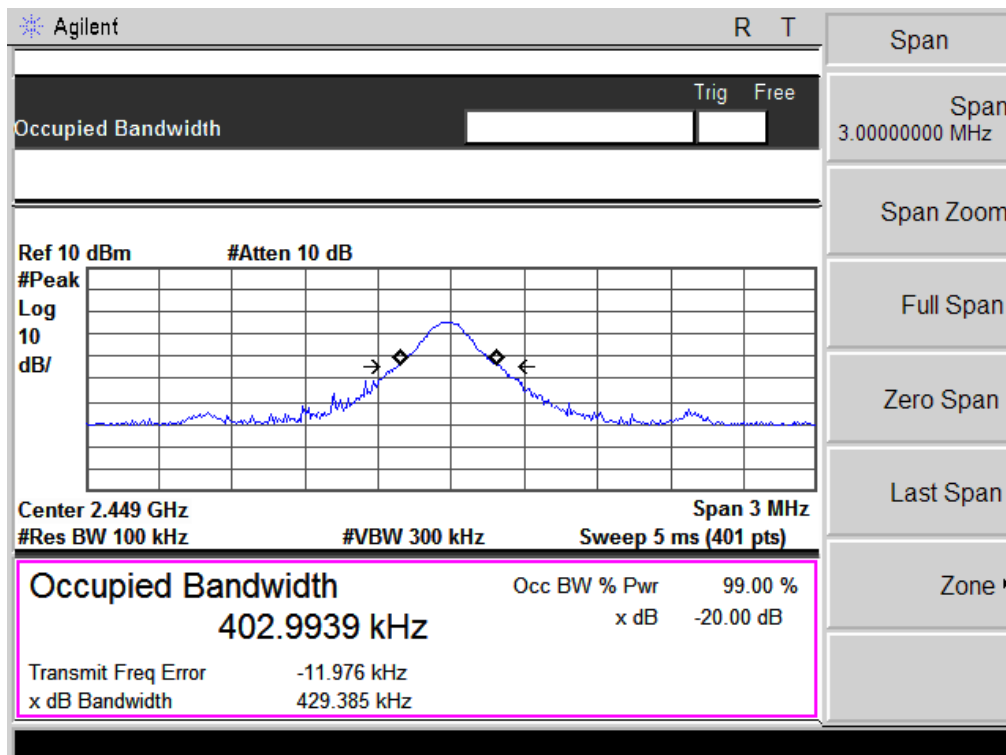

The High Channel:2480MHz

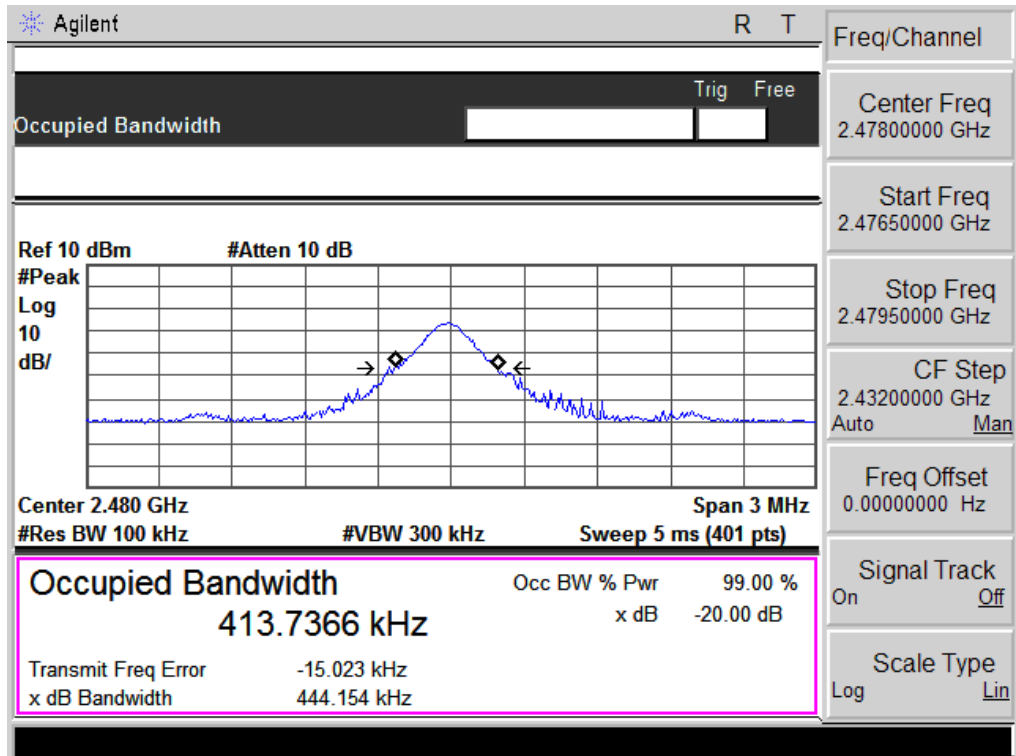

5. EUT TEST PHOTO

Radiated Measurement Photos

