

**FCC&ISED RF TEST REPORT**  
**No. 180402133SHA-002**

Applicant : Libratone A/S  
Sundkaj 9, DK-2150 Nordhavn, Denmark

Manufacturer : Libratone A/S  
Sundkaj 9, DK-2150 Nordhavn, Denmark

Factory : GOERTEK INC.  
NO.268 DONGFANG RD, NEW&HIGH-TECH INDUSTRY  
DEVELOPMENT ZONE, WEIFANG, SHANDONG 261031 CHINA

Product Name : Wireless Speaker

Type/Model : LTH210

**TEST RESULT : PASS**

**SUMMARY**

The equipment complies with the requirements according to the following standard(s) or specification:

**47CFR Part 15 (2017):** Radio Frequency Devices (Subpart C)

**ANSI C63.10 (2014):** American National Standard of Procedures for Compliance Testing of Unlicensed Wireless Devices

**RSS-247 Issue 2 (February 2017):** Digital Transmission Systems (DTSs), Frequency Hopping Systems (FHSs) and Licence-Exempt Local Area Network (LE-LAN) Devices

**RSS-Gen Issue 5 (April 2018):** General Requirements for Compliance of Radio Apparatus

Date of issue: May 10, 2018

Prepared by:



Eric Li (Project engineer)

Reviewed by:



Daniel Zhao (Reviewer)

## Description of Test Facility

Name: Intertek Testing Service Shanghai  
Address: Building No.86, 1198 Qinzhou Road (North), Shanghai 200233, P.R. China

FCC Designation Number: CN1175  
IC Assigned Code: 2042B-1

Name of contact: Jonny Jing  
Tel: 86 21 61278271  
Fax: 86 21 54262353

## Content

<b>SUMMARY</b> .....	<b>1</b>
<b>DESCRIPTION OF TEST FACILITY</b> .....	<b>2</b>
<b>REVISION HISTORY</b> .....	<b>5</b>
<b>1 GENERAL INFORMATION</b> .....	<b>6</b>
1.1 IDENTIFICATION OF THE EUT .....	6
1.2 TECHNICAL SPECIFICATION .....	7
1.3 MODE OF OPERATION DURING THE TEST.....	8
1.4 TEST PERIPHERALS LIST .....	9
1.5 DESCRIPTION OF TEST FACILITY .....	9
<b>2 TEST SPECIFICATIONS</b> .....	<b>10</b>
2.1 INSTRUMENT LIST .....	10
2.2 TEST STANDARD .....	11
2.3 TEST SUMMARY .....	12
2.4 FREQUENCY HOPPING SYSTEM REQUIREMENT .....	13
2.5 MEASUREMENT UNCERTAINTY .....	14
<b>3 20DB BANDWIDTH</b> .....	<b>15</b>
3.1 LIMIT .....	15
3.2 TEST CONFIGURATION .....	15
3.3 TEST PROCEDURE AND TEST SETUP .....	15
3.4 TEST PROTOCOL .....	16
<b>4 CARRIER FREQUENCY SEPARATION</b> .....	<b>19</b>
4.1 TEST LIMIT .....	19
4.2 TEST CONFIGURATION .....	19
4.3 TEST PROCEDURE AND TEST SETUP .....	19
4.4 TEST PROTOCOL .....	20
<b>5 MAXIMUM PEAK OUTPUT POWER</b> .....	<b>23</b>
5.1 TEST LIMIT .....	23
5.2 TEST CONFIGURATION .....	23
5.3 TEST PROCEDURE AND TEST SETUP .....	23
5.4 TEST PROTOCOL .....	24
<b>6 RADIATED SPURIOUS EMISSIONS</b> .....	<b>27</b>
6.1 TEST LIMIT .....	27
6.2 TEST CONFIGURATION .....	27
6.3 TEST PROCEDURE AND TEST SETUP .....	28
6.4 TEST PROTOCOL .....	29
<b>7 CONDUCTED SPURIOUS EMISSIONS &amp; BAND EDGE</b> .....	<b>32</b>
7.1 TEST LIMIT .....	32
7.2 TEST CONFIGURATION .....	32
7.3 TEST PROCEDURE AND TEST SETUP .....	32
7.4 TEST PROTOCOL .....	33
<b>8 POWER LINE CONDUCTED EMISSION</b> .....	<b>47</b>
8.1 LIMIT .....	47
8.2 TEST CONFIGURATION .....	47
8.3 TEST PROCEDURE AND TEST SET UP .....	48
8.4 TEST PROTOCOL .....	49

**9 NUMBER OF HOPPING FREQUENCIES ..... 51**

- 9.1 LIMIT ..... 51
- 9.2 TEST CONFIGURATION ..... 51
- 9.3 TEST PROCEDURE AND TEST SETUP ..... 51
- 9.4 TEST PROTOCOL ..... 51

**10 DWELL TIME ..... 54**

- 10.1 LIMIT ..... 54
- 10.2 TEST CONFIGURATION ..... 54
- 10.3 TEST PROCEDURE AND TEST SETUP ..... 54
- 10.4 TEST PROTOCOL..... 55

## Revision History

Report No.	Version	Description	Date Issued
180402133SHA-002	Rev. 01	Initial issue of report	May 10, 2018

## 1 GENERAL INFORMATION

### 1.1 Identification of the EUT

Product Name : Wireless Speaker  
Type/model : LTH210  
FCC ID : Y2SLTH210  
IC : 9452A-LTH210  
Description of EUT : The EUT is a Wireless Speaker, which has WIFI and Bluetooth functions. There is only one model, we tested it and listed the BT EDR results in this report.  
Rating : 19 Vdc,1.8A  
Category of EUT : Class B  
EUT type :  Table top  
 Floor standing  
Sample received date : March 26, 2018  
Date of test : March 26, 2018 to April 2, 2018

## 1.2 Technical Specification

Operation Frequency : 2402 - 2480 MHz  
 Band  
 Type of Modulation : BT 4.2 (BR+EDR)  
 EUT Modes of Modulation : GFSK,  $\pi/4$  DQPSK, 8DPSK

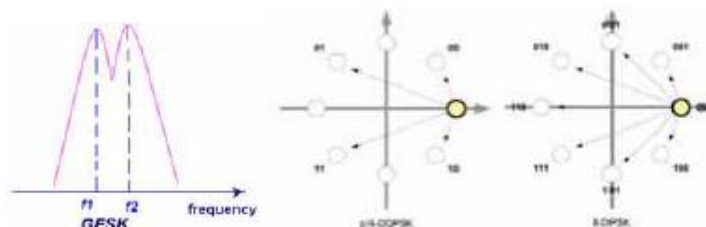

Channel Description : There are 79 channels in all. The designed channel spacing is 1MHz.

Channel Identifier	Frequency (MHz)
low	2402
middle	2441
high	2480

Antenna : Internal PCB antenna, 2.11dBi

**Antenna Requirement:** An intentional radiator shall be designed to ensure that no antenna other than that furnished by the responsible party shall be used with the device. The use of a permanently attached antenna or of an antenna that uses a unique coupling to the intentional radiator shall be considered sufficient to comply with the provisions of this section. The manufacturer may design the unit so that a broken antenna can be replaced by the user, but the use of a standard antenna jack or electrical connector is prohibited.

**The EUT used an internal monopole antenna and used a no-standard electrical connector, so fulfill these requirements.**

### 1.3 Mode of operation during the test

While testing the transmitter mode of the EUT, the internal modulation is applied. All the functions of the host device except the BT module were set on stand-by mode.

The test setting software is offered by the manufactory. The pre-scan for the conducted power with all rates in each modulation and bands was used, and the worst case was found and used in all test cases.

The worst case modulation configuration:

<b>Worst Modulation Used for Conformance Testing</b>			
<b>Bluetooth Mode</b>	<b>Packet Type</b>	<b>Data Rate</b>	<b>Worst Mode</b>
GFSK	BR-1Mbps	DH1, DH3, DH5	<b>BR-1Mbps DH5</b>
$\pi/4$ DQPSK	EDR-2Mbps	2DH1,2DH3,2DH5	
8DPSK	EDR-3Mbps	3DH1,3DH3,3DH5	

The power setting parameter:

<b>The worst case power setting parameter</b>			
Test software Version	CMD Command		
Modulation Mode	2402MHz	2441MHz	2480MHz
BR-1Mbps	Default	Default	Default
EDR-2Mbps	Default	Default	Default
EDR-3Mbps	Default	Default	Default

There have the following test modes:

Radiated test mode:

Mode 1: EUT transmitted signal with BT antenna;

Conducted test mode:

Mode 2: EUT transmitted signal from BT RF port connected to SA directly;

We have verified all test modes, and choose the mode 1 for radiated RF test and mode 2 for conducted RF test as representatively to list the results in this report.



### 1.4 Test peripherals list

Item No.	Name	Brand and Model	Description
1	Laptop computer	HP ProBook 6470b	100-240V AC, 50/60Hz
2	AC-DC adaptor	IU35	Input: 100-240V AC 50/60Hz Output: 19VDC 1.8A

### 1.5 Description of Test Facility

Name : Intertek Testing Service Shanghai

Address : Building 86, No. 1198 Qinzhou Road(North), Shanghai 200233,  
P.R. China

Telephone : 86 21 61278200

Telefax : 86 21 54262353

The test facility is : CNAS Accreditation Lab  
recognized, certified,  
or accredited by these  
organizations

Registration No. CNAS L0139

FCC Accredited Lab  
Designation Number: CN1175  
IC Registration Lab

Registration code No.: 2042B-1

VCCI Registration Lab

Registration No.: R-4243, G-845, C-4723, T-2252

NVLAP Accreditation Lab

NVLAP LAB CODE: 200849-0

A2LA Accreditation Lab

Certificate Number: 3309.02

## 2 TEST SPECIFICATIONS

### 2.1 Instrument list

Conducted Emission					
Used	Equipment	Manufacturer	Type	Internal no.	Due date
<input checked="" type="checkbox"/>	Test Receiver	R&S	ESCS 30	EC 2107	2018-10-18
<input checked="" type="checkbox"/>	A.M.N.	R&S	ESH2-Z5	EC 3119	2018-12-01
<input checked="" type="checkbox"/>	Shielded room	Zhongyu	-	EC 2838	2019-01-08
Radiated Emission					
Used	Equipment	Manufacturer	Type	Internal no.	Due date
<input checked="" type="checkbox"/>	Test Receiver	R&S	ESIB 26	EC 3045	2018-10-18
<input checked="" type="checkbox"/>	Bilog Antenna	TESEQ	CBL 6112D	EC 4206	2018-05-30
<input checked="" type="checkbox"/>	Horn antenna	R&S	HF 906	EC 3049	2018-09-22
<input checked="" type="checkbox"/>	Horn antenna	ETS	3117	EC 4792-1	2018-08-23
<input checked="" type="checkbox"/>	Horn antenna	TOYO	HAP18-26W	EC 4792-3	2020-07-09
<input checked="" type="checkbox"/>	Pre-amplifier	R&S	Pre-amp 18	EC5881	2018-06-19
<input checked="" type="checkbox"/>	Semi-anechoic chamber	Albatross project	-	EC 3048	2018-09-08
RF test					
Used	Equipment	Manufacturer	Type	Internal no.	Due date
<input checked="" type="checkbox"/>	PXA Signal Analyzer	Keysight	N9030A	EC 5338	2018-09-10
<input checked="" type="checkbox"/>	Power sensor	Agilent	U2021XA	EC 5338-1	2019-03-03
<input checked="" type="checkbox"/>	Vector Signal Generator	Agilent	N5182B	EC 5175	2019-03-06
<input checked="" type="checkbox"/>	MXG Analog Signal Generator	Agilent	N5181A	EC 5338-2	2019-03-03
<input checked="" type="checkbox"/>	Mobile Test System	Litepoint	lqxel	EC 5176	2019-01-11
<input checked="" type="checkbox"/>	Test Receiver	R&S	ESCI 7	EC 4501	2019-02-23
Additional instrument					
Used	Equipment	Manufacturer	Type	Internal no.	Due date
<input checked="" type="checkbox"/>	Therom-Hygrograph	ZJ1-2A	S.M.I.F.	EC 3323	2018-06-14
<input checked="" type="checkbox"/>	Therom-Hygrograph	ZJ1-2A	S.M.I.F.	EC 3324	2018-04-09
<input checked="" type="checkbox"/>	Therom-Hygrograph	ZJ1-2A	S.M.I.F.	EC 3325	2019-03-23
<input checked="" type="checkbox"/>	Pressure meter	YM3	Shanghai Mengde	EC 3320	2018-06-28

## **2.2 Test Standard**

47CFR Part 15 (2017)

ANSI C63.10 (2014)

DA 00-705

RSS-247 Issue 2 (February 2017)

RSS-Gen Issue 5 (April 2018)

### 2.3 Test Summary

This report applies to tested sample only. The test results have been compared directly with the limits, and the measurement uncertainty is recorded. This report shall not be reproduced in part without written approval of Intertek Testing Service Shanghai Limited.

TEST ITEM	FCC REFERANCE	IC REFERANCE	RESULT
20dB Bandwidth	15.247(a)(1)	RSS-247 Issue 2 Clause 5	Pass
Carrier Frequency Separation	15.247(a)(1)	RSS-247 Issue 2 Clause 5	Pass
Output power	15.247(b)(1)	RSS-247 Issue 2 Clause 5	Pass
Radiated Spurious Emissions	15.205 & 15.209	RSS-247 Issue 2 Clause 5	Pass
Conducted Spurious Emissions &Band Edge	15.247(d)	RSS-247 Issue 2 Clause 5	Pass
Power line conducted emission	15.207	RSS-Gen Issue 5 Clause 8.8	Pass
Number of Hopping Frequencies	15.247(a)(1)(iii)	RSS-247 Issue 2 Clause 5	Pass
Dwell time	15.247(a)(1)(iii)	RSS-247 Issue 2 Clause 5	Pass
Occupied bandwidth	-	RSS-Gen Issue 4 Clause 6.6	Tested

Notes: 1: NA =Not Applicable

2: This report is for the exclusive use of Intertek's Client and is provided pursuant to the agreement between Intertek and its Client. Intertek's responsibility and liability are limited to the terms and conditions of the agreement. Intertek assumes no liability to any party, other than to the Client in accordance with the agreement, for any loss, expense or damage occasioned by the use of this report. Only the Client is authorized to permit copying or distribution of this report and then only in its entirety. Any use of the Intertek name or one of its marks for the sale or advertisement of the tested material, product or service must first be approved in writing by Intertek. The observations and test results in this report are relevant only to the sample tested. This report by itself does not imply that the material, product, or service is or has ever been under an Intertek certification program.

**2.4 Frequency Hopping System Requirement**

**Test Requirement: Section 15.247 (a)(1), (g), (h) requirement:**

The system shall hop to channel frequencies that are selected at the system hopping rate from a Pseudorandom ordered list of hopping frequencies. Each frequency must be used equally on the average by each transmitter. The system receivers shall have input bandwidths that match the hopping channel bandwidths of their corresponding transmitters and shall shift frequencies in synchronization with the transmitted signals.

Frequency hopping spread spectrum systems are not required to employ all available hopping channels during each transmission. However, the system, consisting of both the transmitter and the receiver, must be designed to comply with all of the regulations in this section should the transmitter be presented with a continuous data (or information) stream. In addition, a system employing short transmission bursts must comply with the definition of a frequency hopping system and must distribute its transmissions over the minimum number of hopping channels specified in this section.

The incorporation of intelligence within a frequency hopping spread spectrum system that permits the system to recognize other users within the spectrum band so that it individually and independently chooses and adapts its hop sets to avoid hopping on occupied channels is permitted. The coordination of frequency hopping systems in any other manner for the express purpose of avoiding the simultaneous occupancy of individual hopping frequencies by multiple transmitters is not permitted.

**Compliance for section 15.247(a)(1)**

According to Bluetooth Core Specification, the pseudorandom sequence may be generated in a nine stage shift register whose 5th and 9th stage outputs are added in a modulo-two addition stage. And the result is fed back to the input of the first stage. The sequence begins with the first ONE of 9 consecutive ONES;

i.e. the shift register is initialized with nine ones.

- Number of shift register stages: 9
- Length of pseudo-random sequence:  $2^9 - 1 = 511$  bits
- Longest sequence of zeros: 8 (non-inverted signal)

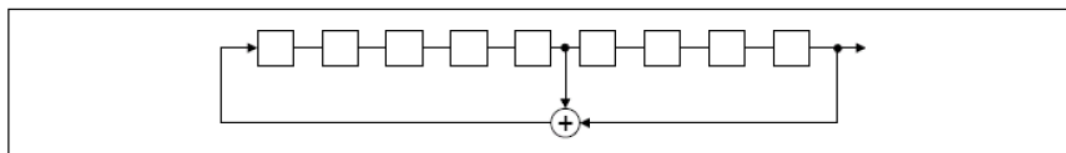

*Linear Feedback Shift Register for Generation of the PRBS sequence*

An example of Pseudorandom Frequency Hopping Sequence as follow:

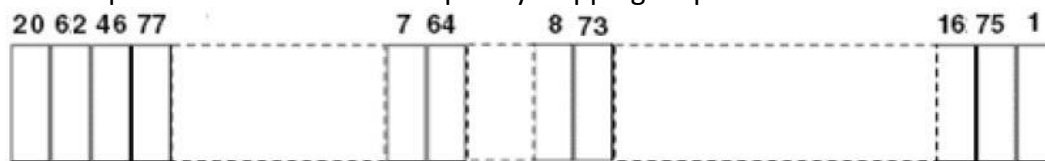

Each frequency used equally on the average by each transmitter.

According to Bluetooth Core Specification, Bluetooth receivers are designed to have input and IF bandwidths that match the hopping channel bandwidths of any Bluetooth transmitters and shift frequencies in synchronization with the transmitted signals.

**Compliance for section 15.247(g)**

According to Bluetooth Core Specification, the Bluetooth system transmits the packet with the pseudorandom hopping frequency with a continuous data and the short burst transmission from the Bluetooth system is also transmitted under the frequency hopping system with the pseudorandom hopping frequency system.

**Compliance for section 15.247(h)**

According to Bluetooth Core specification, the Bluetooth system incorporates with an adaptive system to detect other user within the spectrum band so that it individually and independently to avoid hopping on the occupied channels.

According to the Bluetooth Core specification, the Bluetooth system is designed not have the ability to coordinate with other FHSS System in an effort to avoid the simultaneous occupancy of individual hopping frequencies by multiple transmitter.

**2.5 Measurement uncertainty**

The measurement uncertainty represents an expanded uncertainty expressed at approximately the 95% confidence level using a coverage factor of k=2.

Test item	Measurement uncertainty
Maximum peak output power	± 0.74dB
Radiated Emissions in restricted frequency bands below 1GHz	± 4.90dB
Radiated Emissions in restricted frequency bands above 1GHz	± 5.02dB
Emission outside the frequency band	± 2.89dB
Power line conducted emission	± 3.19dB

### 3 20dB Bandwidth&99% Bandwidth

Test result: Pass

#### 3.1 Limit

- Frequency hopping systems shall have hopping channel carrier frequencies separated by a minimum of 25 kHz or the 20 dB bandwidth of the hopping channel, whichever is greater.
- Frequency hopping systems operating in the 2400–2483.5 MHz band may have hopping channel carrier frequencies that are separated by 25 kHz or two-thirds of the 20 dB bandwidth of the hopping channel, whichever is greater, provided the systems operate with an output power no greater than 125mW.

#### 3.2 Test Configuration

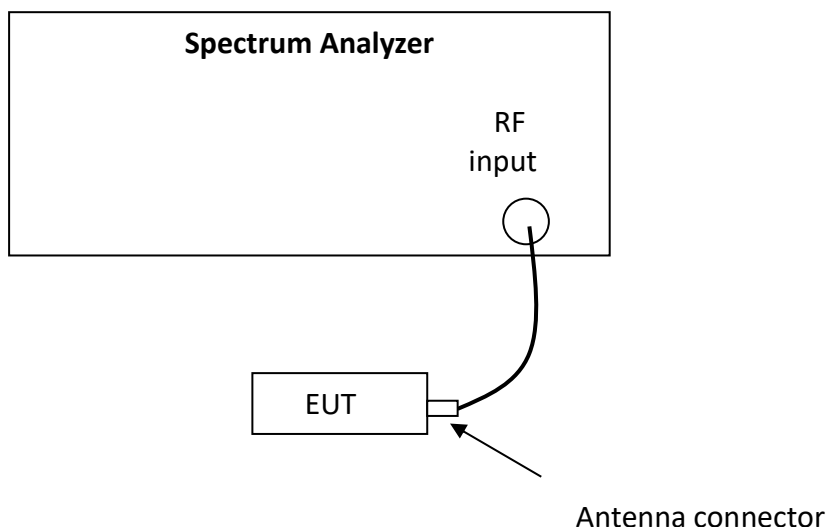

#### 3.3 Test Procedure and test setup

The 20 bandwidth per FCC §15.247(a)(1) is measured using the Spectrum Analyzer with Span =2 to 3 times the 20 dB bandwidth, RBW≥1% of the 20 dB bandwidth, VBW≥RBW, Sweep = auto, Detector = peak, Trace = max hold.

The test was performed at 3 channels (lowest, middle and highest channel).

The EUT was tested according to DA 00-705 (Filing and Measurement Guidelines for Frequency Hopping Spread Spectrum Systems)

### 3.4 Test Protocol

Temperature: 25 °C

Relative Humidity: 55 %

BT Occupied 20dB Bandwidth					
Mode	Test Frequency (MHz)	Packet Type	20dB Bandwidth (kHz)	Two-thirds of Bandwidth(KHz)	Result
GFSK	2402	DH5	975.2	650.13	Pass
GFSK	2441	DH5	978.3	652.20	Pass
GFSK	2480	DH5	946.3	630.87	Pass
DQPSK	2402	2DH5	1349.5	899.67	Pass
DQPSK	2441	2DH5	1341.7	894.47	Pass
DQPSK	2480	2DH5	1350.4	900.27	Pass
8DPSK	2402	3DH5	1340.7	893.80	Pass
8DPSK	2441	3DH5	1334.0	889.33	Pass
8DPSK	2480	3DH5	1319.8	879.87	Pass

BT Occupied 99% Bandwidth				
Mode	Test Frequency (MHz)	Packet Type	99% Bandwidth (kHz)	Result
GFSK	2402	DH5	925.5	Pass
GFSK	2441	DH5	912.7	Pass
GFSK	2480	DH5	901.0	Pass
DQPSK	2402	2DH5	1217.6	Pass
DQPSK	2441	2DH5	1217.8	Pass
DQPSK	2480	2DH5	1219.1	Pass
8DPSK	2402	3DH5	1217.5	Pass
8DPSK	2441	3DH5	1219.2	Pass
8DPSK	2480	3DH5	1202.5	Pass



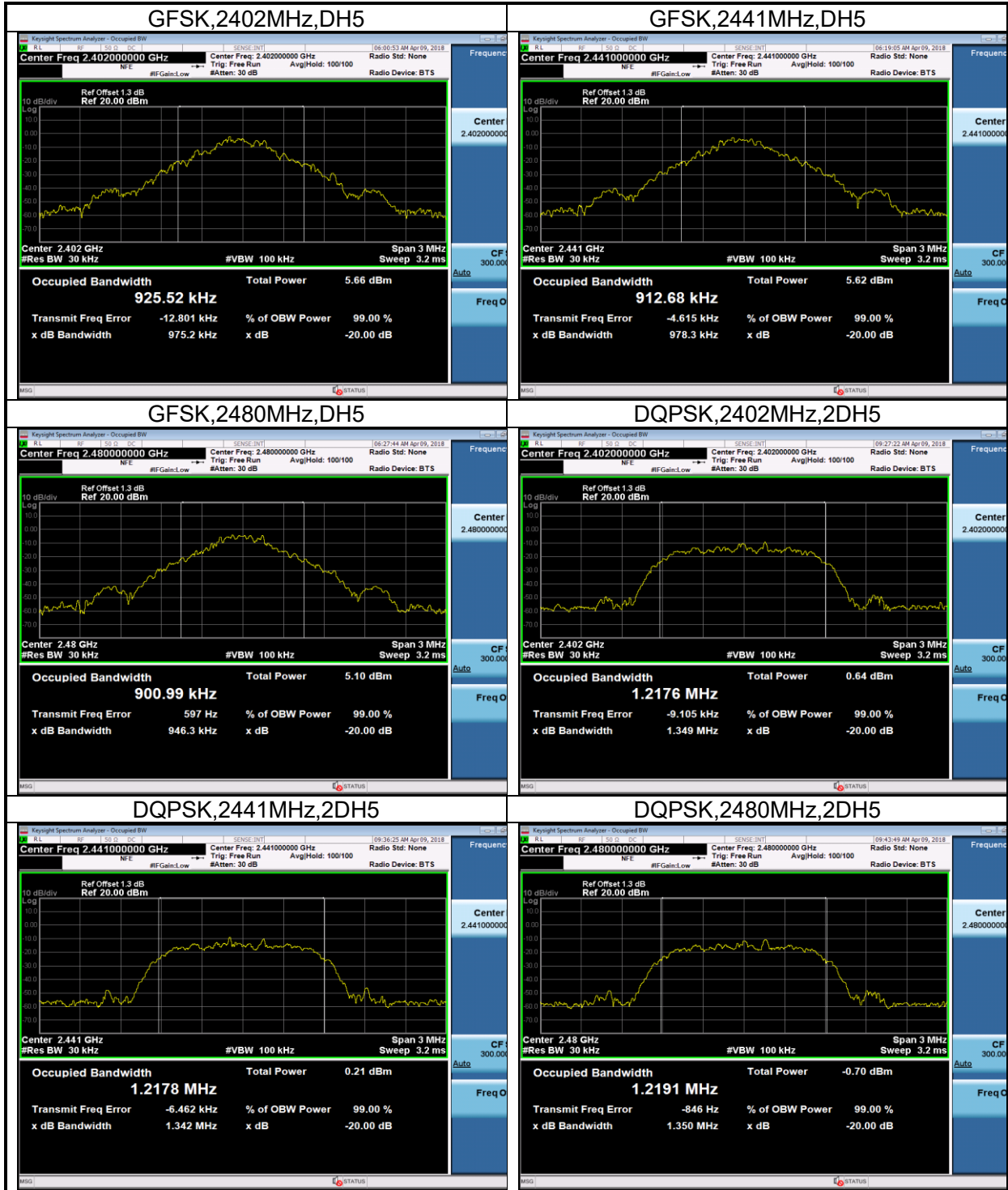

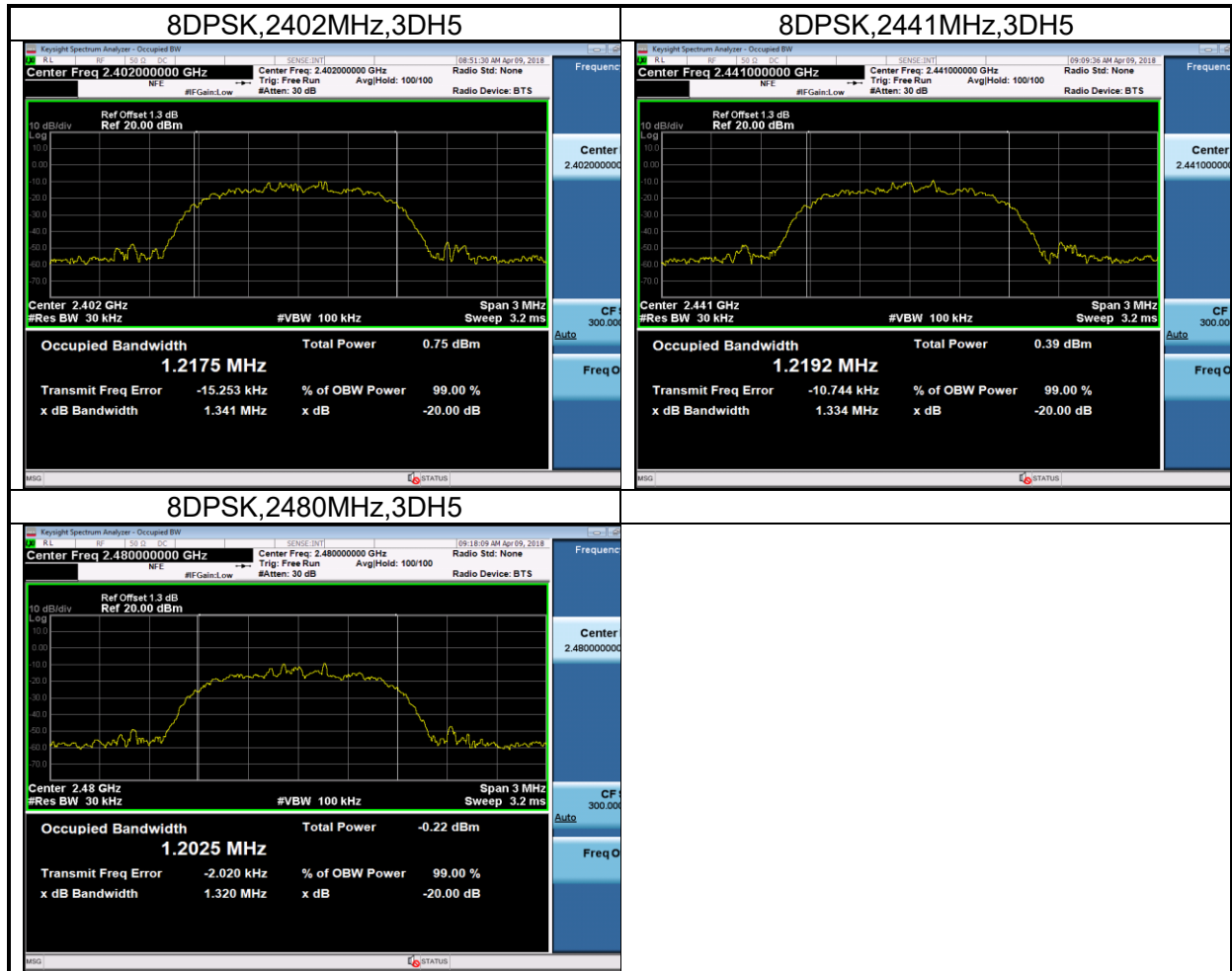

## 4 Carrier Frequency Separation

Test result: Pass

### 4.1 Test limit

- Frequency hopping systems shall have hopping channel carrier frequencies separated by a minimum of 25kHz or the 20 dB bandwidth of the hopping channel, whichever is greater.
- Frequency hopping systems operating in the 2400–2483.5 MHz band may have hopping channel carrier frequencies that are separated by 25 kHz or two-thirds of the 20 dB bandwidth of the hopping channel, whichever is greater, provided the systems operate with an output power no greater than 125mW.

### 4.2 Test Configuration

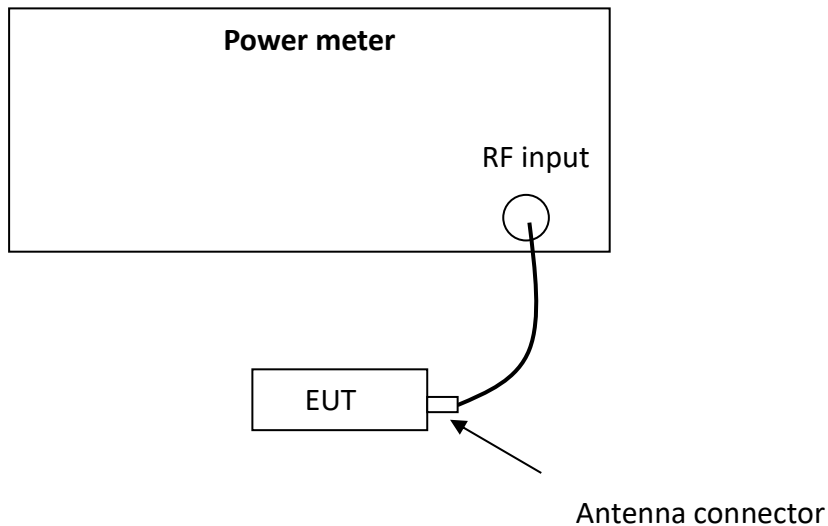

### 4.3 Test procedure and test setup

The Carrier Frequency Separation per FCC §15.247(a)(1) is measured using the Spectrum Analyzer with Span can capture two adjacent channels,  $RBW \geq 1\%$  of the span,  $VBW \geq RBW$ , Sweep = auto, Detector = peak, Trace = max hold.

The test was performed at 3 channels (lowest, middle and highest channel).

The EUT was tested according to DA 00-705 (Filing and Measurement Guidelines for Frequency Hopping Spread Spectrum Systems)

#### 4.4 Test protocol

Temperature: 25 °C

Relative Humidity: 55 %

BT Carrier Frequency Separation					
Mode	Test Frequency (MHz)	Packet Type	Range	Separation (kHz)	Result
GFSK	Hopping	DH5	2401.5MHz~2403.5MHz	753	Pass
GFSK	Hopping	DH5	2440.5Mhz~2442.5Mhz	997	Pass
GFSK	Hopping	DH5	2478.5Mhz~2480.5Mhz	1001	Pass
DQPSK	Hopping	2DH5	2401.5MHz~2403.5MHz	1255	Pass
DQPSK	Hopping	2DH5	2440.5Mhz~2442.5Mhz	995	Pass
DQPSK	Hopping	2DH5	2478.5Mhz~2480.5Mhz	1223	Pass
8DPSK	Hopping	3DH5	2401.5MHz~2403.5MHz	1211	Pass
8DPSK	Hopping	3DH5	2440.5Mhz~2442.5Mhz	767	Pass
8DPSK	Hopping	3DH5	2478.5Mhz~2480.5Mhz	993	Pass



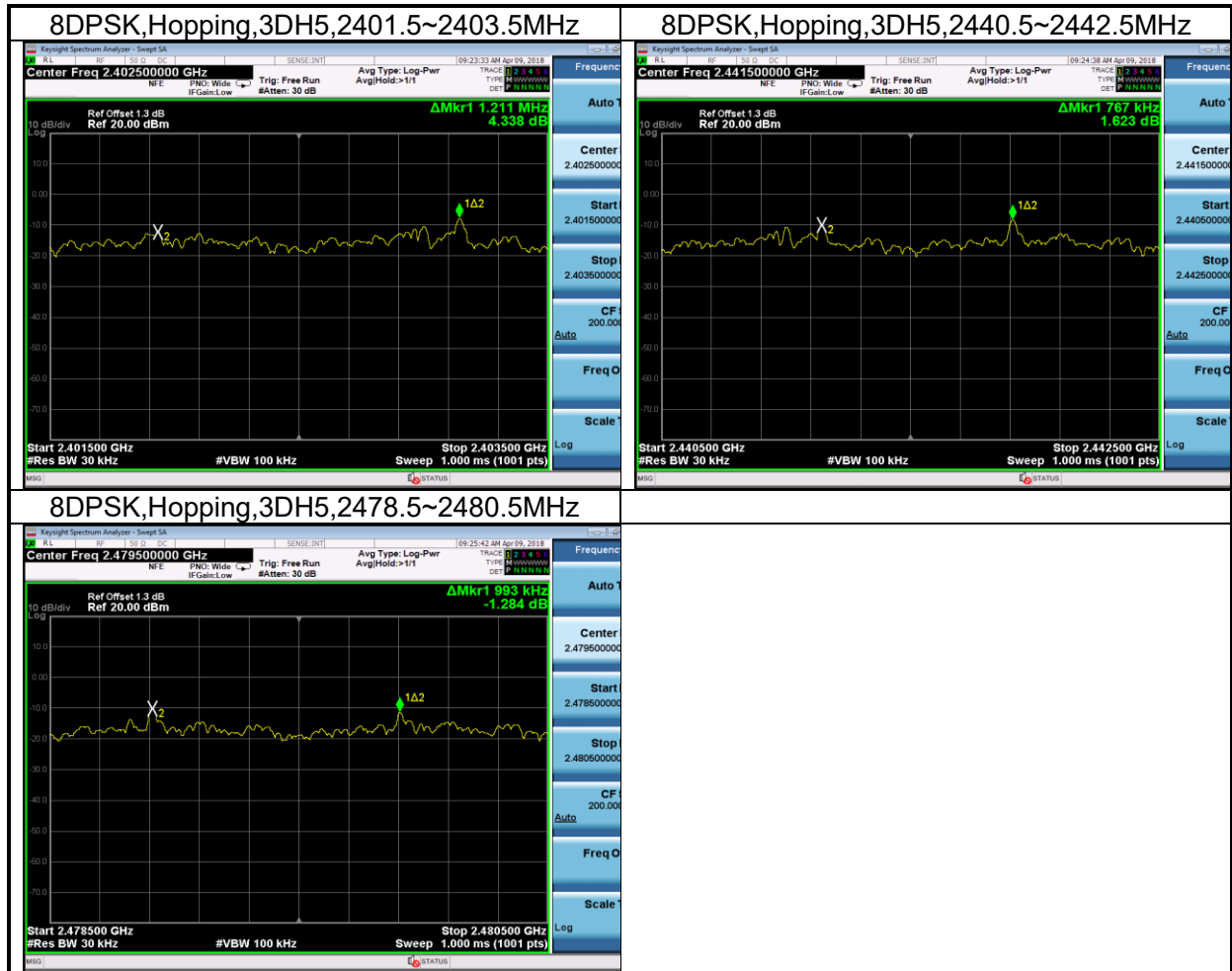

## 5 Maximum peak output power

**Test result:** Pass

### 5.1 Test limit

For frequency hopping systems operating in the 2400-2483.5 MHz band employing at least 75 non-overlapping hopping channels, and all frequency hopping systems in the 5725-5850 MHz band: 1 watt

For all other frequency hopping systems in the 2400-2483.5 MHz band: 0.125 watts  
If the transmitting antenna of directional gain greater than 6dBi is used, the power shall be reduced by the amount in dB that the directional gain of the antenna exceeds 6dBi.  
For systems using digital modulation in the 902-928 MHz, 2400-2483.5 MHz, and 5725-5850 MHz bands: 1 Watt.

### 5.2 Test Configuration

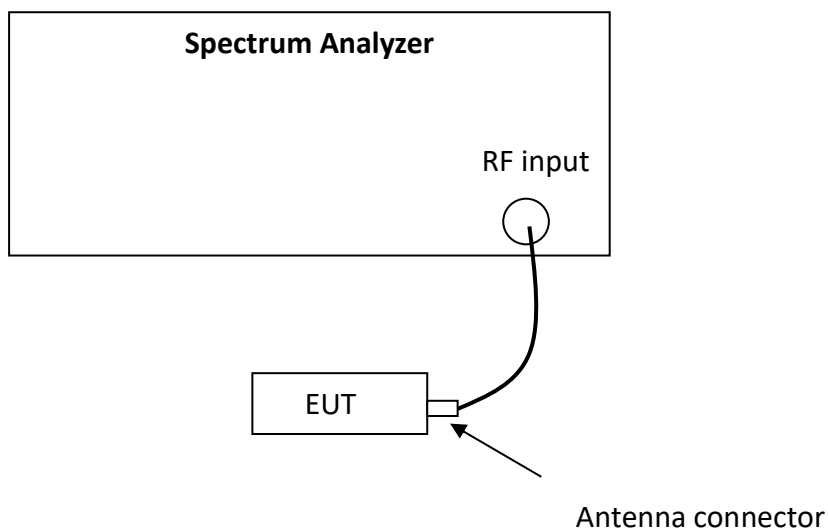

### 5.3 Test procedure and test setup

The power output per FCC §15.247(b) is measured using the Spectrum Analyzer with Span = 5 times the 20 dB bandwidth,  $RBW \geq$  the 20 dB bandwidth,  $VBW \geq RBW$ , Sweep = auto, Detector = peak, Trace = max hold.

The test was performed at 3 channels (lowest, middle and highest channel).

The EUT was tested according to DA 00-705 (Filing and Measurement Guidelines for Frequency Hopping Spread Spectrum Systems)

**5.4 Test Protocol**

Temperature: 25 °C  
Relative Humidity: 55 %

BT Maximum Output Power				
Mode	Test Frequency (MHz)	Packet Type	Power (dBm)	Result
GFSK	2402	DH5	-0.11	Pass
GFSK	2441	DH5	-0.65	Pass
GFSK	2480	DH5	-1.30	Pass
DQPSK	2402	2DH5	-3.78	Pass
DQPSK	2441	2DH5	-4.26	Pass
DQPSK	2480	2DH5	-5.18	Pass
8DPSK	2402	3DH5	-3.35	Pass
8DPSK	2441	3DH5	-3.81	Pass
8DPSK	2480	3DH5	-4.69	Pass



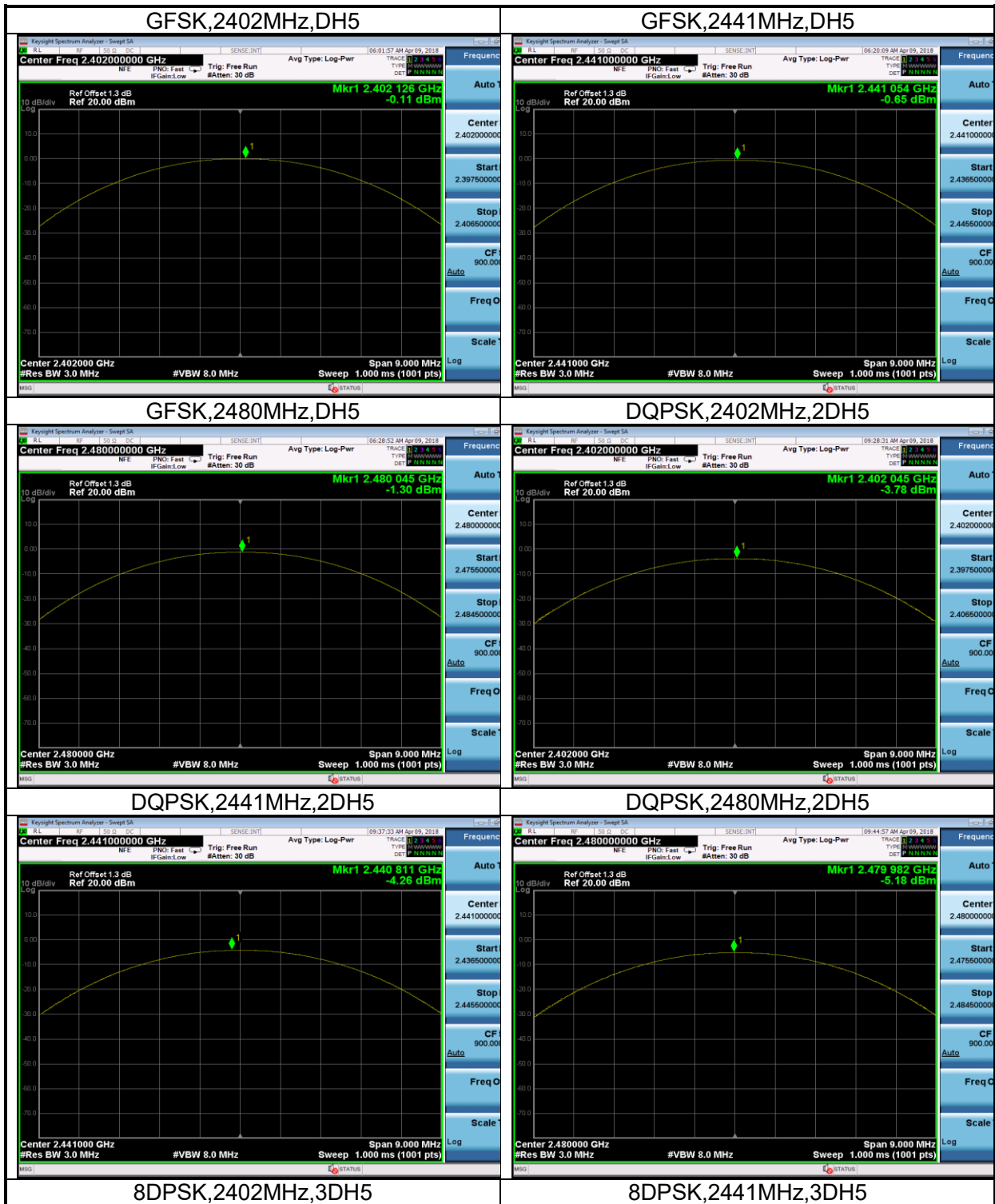



Conclusion: The maximum EIRP = - 0.11dBm+2.11dBi =2dBm = 0.00158W which is lower than the limit of 4W listed in RSS-247.

## 6 Radiated Emissions

Test result: **Pass**

### 6.1 Test limit

The radiated emissions which fall in the restricted bands, as defined in §15.205(a), must also comply with the radiated emission limits specified in §15.209(a) showed as below:

Frequency (MHz)	Field Strength (dBuV/m)	Measurement Distance (m)
30 - 88	40.0	3
88 - 216	43.5	3
216 - 960	46.0	3
Above 960	54.0	3

### 6.2 Test Configuration

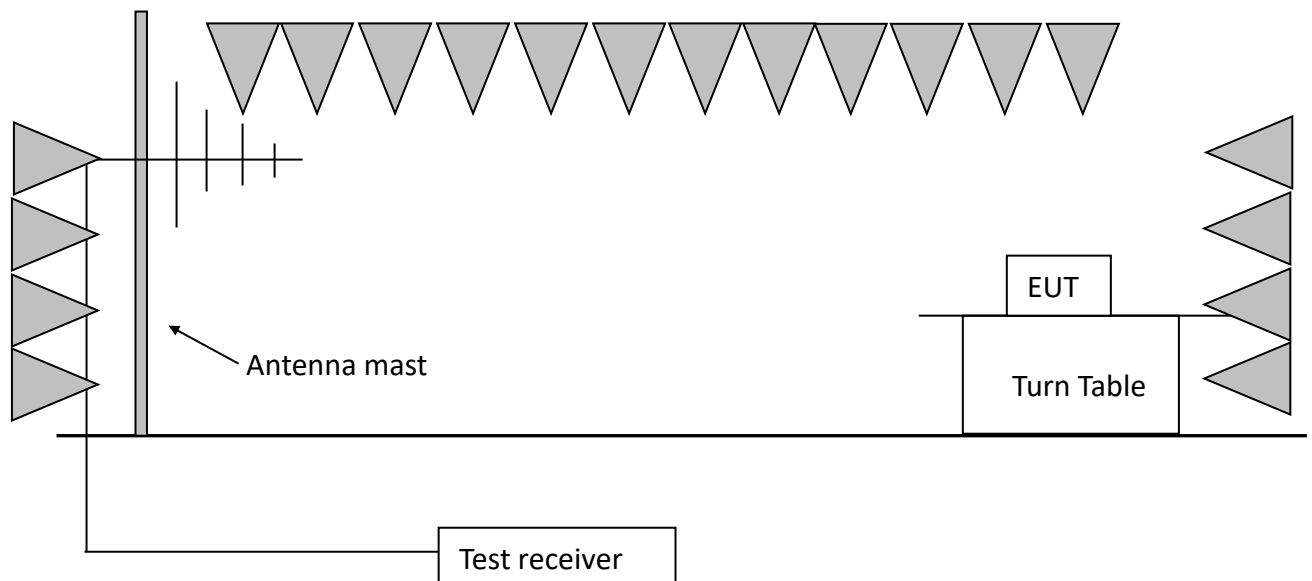

### 6.3 Test procedure and test setup

The measurement was applied in a semi-anechoic chamber. While testing for spurious emission higher than 1GHz, if applied, the pre-amplifier would be equipped just at the output terminal of the antenna.

Tabletop devices shall be placed on a nonconducting platform with nominal top surface dimensions 1 m by 1.5 m. For emissions testing at or below 1 GHz, the table height shall be 80 cm above the reference ground plane. For emission measurements above 1 GHz, the table height shall be 1.5 m.

The turn table rotated 360 degrees to determine the position of the maximum emission level. The EUT was set 3 meters away from the receiving antenna which was mounted on an antenna mast. The antenna moved up and down between from 1meter to 4 meters to find out the maximum emission level.

The EUT was tested according to DA 00-705 (Filing and Measurement Guidelines for Frequency Hopping Spread Spectrum Systems)

The radiated emission was measured using the Spectrum Analyzer with the resolutions bandwidth set as:

RBW = 100 kHz, VBW = 300 kHz (30MHz~1GHz)

RBW = 1MHz, VBW = 3MHz (>1GHz for PK);

- Remark: 1. For fundamental emission, no amplifier is employed.  
2. Correct Factor = Antenna Factor + Cable Loss (-Amplifier, is employed)  
3. Corrected Reading = Original Receiver Reading + Correct Factor  
4. Margin = limit – Corrected Reading  
5. If the PK reading is lower than AV limit, the AV test can be elided.  
6. The emission was conducted from 30MHz to 25GHz.

Example: Assuming Antenna Factor = 30.20dB/m, Cable Loss = 2.00dB,  
Gain of Preamplifier = 32.00dB, Original Receiver Reading = 10dBuV.  
Then Correct Factor = 30.20 + 2.00 – 32.00 = 0.20dB/m; Corrected Reading = 10dBuV  
+ 0.20dB/m = 10.20dBuV/m  
Assuming limit = 54dBuV/m, Corrected Reading = 10.20dBuV/m, then Margin = 54 -10.20 =  
43.80dBuV/m

## 6.4 Test Protocol

Temperature: 25 °C

Relative Humidity: 55 %

The low frequency, which started from 9 kHz to 30MHz, was pre-scanned and the result which was 20dB lower than the limit line per 15.31(o) was not reported.

Horizontal

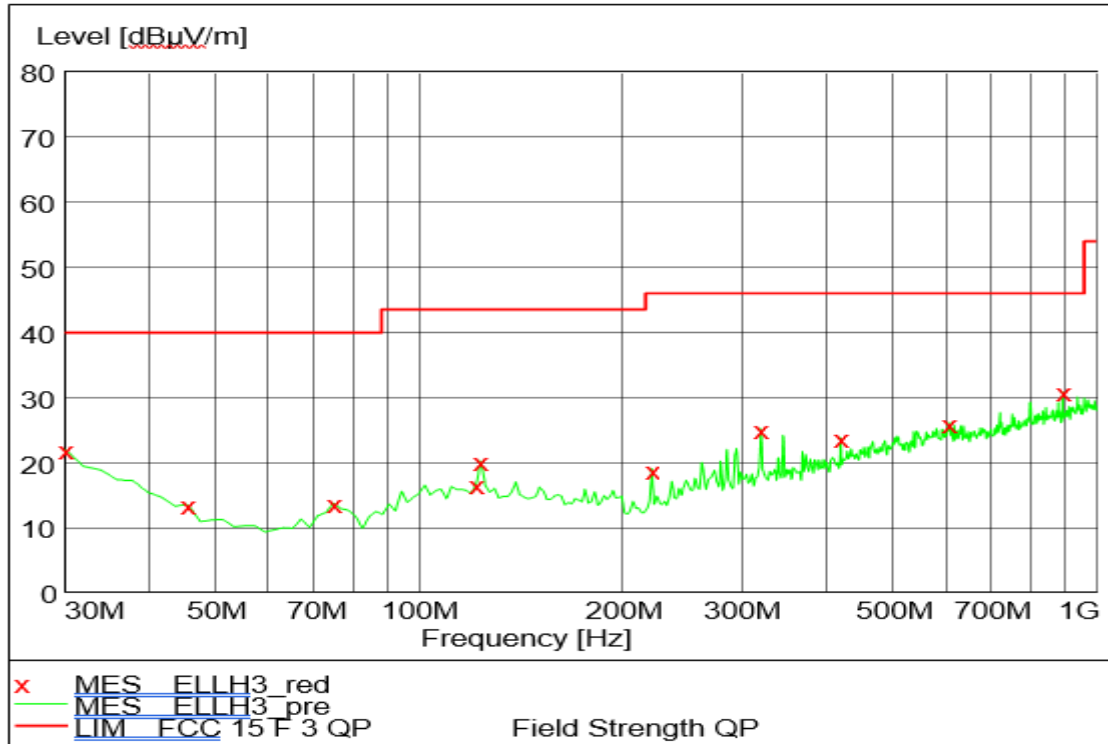

Vertical

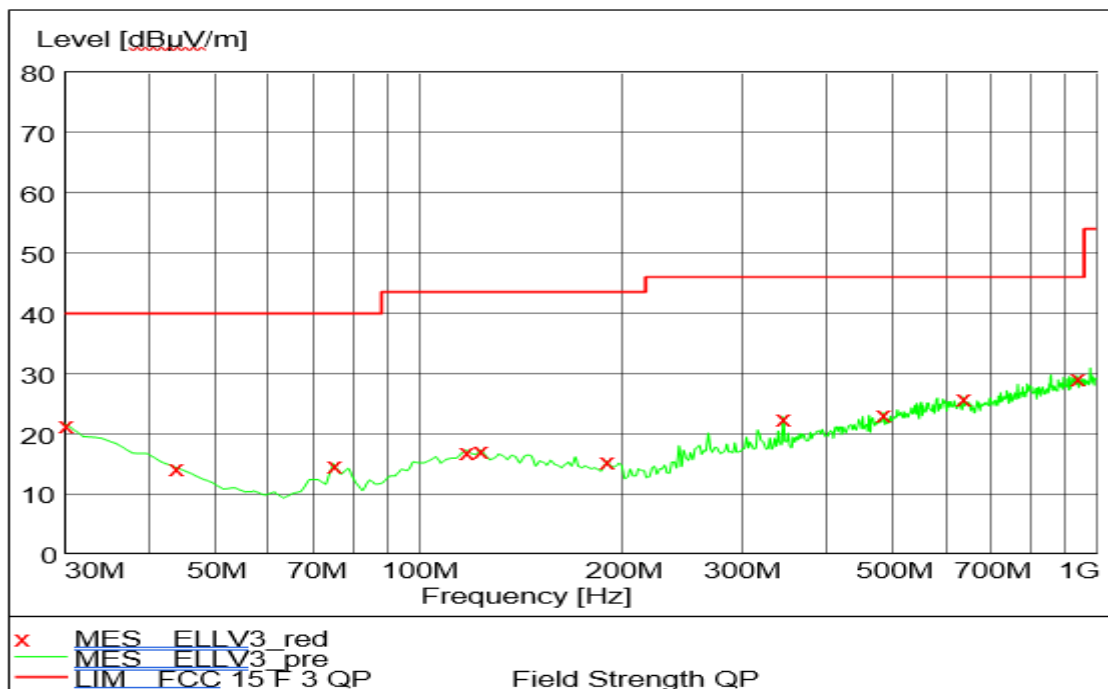

**Test data 30MHz~1GHz:**

Polarization	Frequency (MHz)	Measured level (dBμV/m)	Limits (dBμV/m)	Margin (dB)	Detector
H	30.00	22.10	40.00	17.90	PK
	45.55	13.60	40.00	26.40	PK
	74.71	13.80	40.00	26.20	PK
	121.36	16.70	43.50	26.80	PK
	123.31	20.30	43.50	23.20	PK
	220.50	19.10	46.00	26.90	PK
	319.64	25.30	46.00	20.70	PK
	418.78	23.90	46.00	22.10	PK
	607.33	26.20	46.00	19.80	PK
	891.14	30.90	46.00	15.10	PK
V	30.00	21.70	40.00	18.30	PK
	43.61	14.50	40.00	25.50	PK
	74.71	15.00	40.00	25.00	PK
	117.47	17.30	43.50	26.20	PK
	123.31	17.40	43.50	26.10	PK
	189.40	15.60	43.50	27.90	PK
	344.91	22.90	46.00	23.10	PK
	484.87	23.40	46.00	22.60	PK
	636.49	26.10	46.00	19.90	PK
	937.80	29.60	46.00	16.40	PK

**Test Data (>1GHz):**

GFSK (DH5) Modulation:

H	Antenna	Frequency (MHz)	Corrected Reading (dBuV/m)	Limit (dBuV/m)	Margin (dB)	Detector
L	H	2402.00	91.70	Fundamental	/	PK
	H	2399.98	48.10	74.00	25.90	PK
	H	7206.00	46.70	74.00	27.30	PK
	H	9608.00	46.60	74.00	27.40	PK
M	V	2442.00	91.30	Fundamental	/	PK
	V	4882.00	45.80	74.00	28.20	PK
H	H	2480.00	90.20	Fundamental	/	PK
	V	2483.50	51.60	74.00	22.40	PK
	V	4960.00	45.30	74.00	28.70	PK

$\pi/4$ DQPSK (2DH5) Modulation:

CH	Antenna	Frequency (MHz)	Corrected Reading (dBuV/m)	Limit (dBuV/m)	Margin (dB)	Detector
L	H	2402.00	88.60	Fundamental	/	PK
	H	2390.96	48.90	74.00	25.10	PK
	H	4804.00	45.70	74.00	28.30	PK
M	V	2442.00	88.20	Fundamental	/	PK
	V	4882.00	46.30	74.00	27.70	PK
H	H	2480.00	89.10	Fundamental	/	PK
	V	2483.50	50.50	74.00	23.50	PK
	V	4960.00	45.70	74.00	28.30	PK

8DPSK (3DH5) Modulation:

CH	Antenna	Frequency (MHz)	Corrected Reading (dBuV/m)	Limit (dBuV/m)	Margin (dB)	Detector
L	H	2402.00	88.70	Fundamental	/	PK
	H	2390.90	47.80	74.00	26.20	PK
	H	4804.00	45.20	74.00	28.80	PK
M	V	2442.00	87.90	Fundamental	/	PK
	V	4882.00	45.30	74.00	28.70	PK
H	H	2480.00	90.60	Fundamental	/	PK
	V	2483.50	52.00	74.00	22.00	PK
	V	4960.00	45.70	74.00	28.30	PK

## 7 Conducted Spurious Emissions & Band Edge

Test result: Pass

### 7.1 Test limit

In any 100 kHz bandwidth outside the frequency band in which the spread spectrum intentional radiator is operating, the radio frequency power that is produced by the intentional radiator shall be at least 20 dB below that in the 100 kHz bandwidth within the band that contains the highest level of the desired power.

### 7.2 Test Configuration

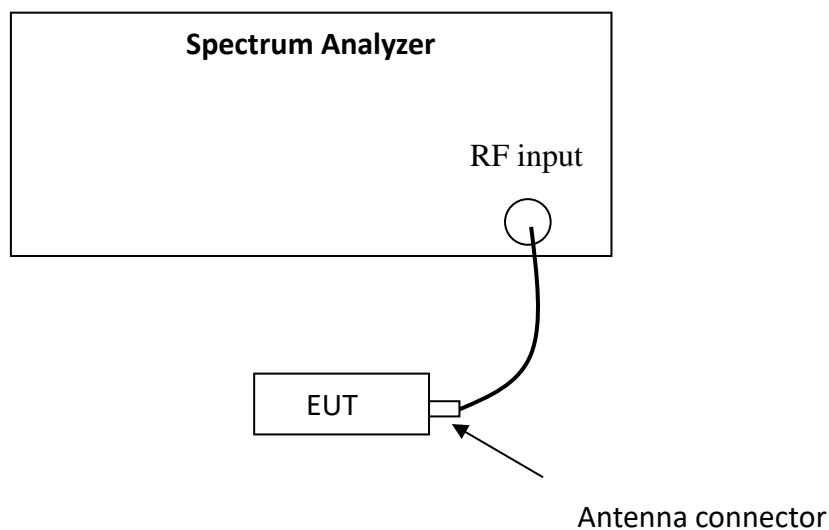

### 7.3 Test procedure and test setup

The Conducted Spurious Emissions per FCC §15.247(d) is measured using the Spectrum Analyzer with Span wide enough capturing all spurious from the lowest emission frequency of the EUT up to 10th harmonics, RBW = 100kHz, VBW ≥ RBW, Sweep = auto, Detector = peak, Trace = max hold.

The test was performed at 2 channels (lowest and highest channel).

The EUT was tested according to DA 00-705 (Filing and Measurement Guidelines for Frequency Hopping Spread Spectrum Systems)



## 7.4 Test Protocol

Temperature: 25 °C

Relative Humidity: 55 %

### GFSK Channel- L

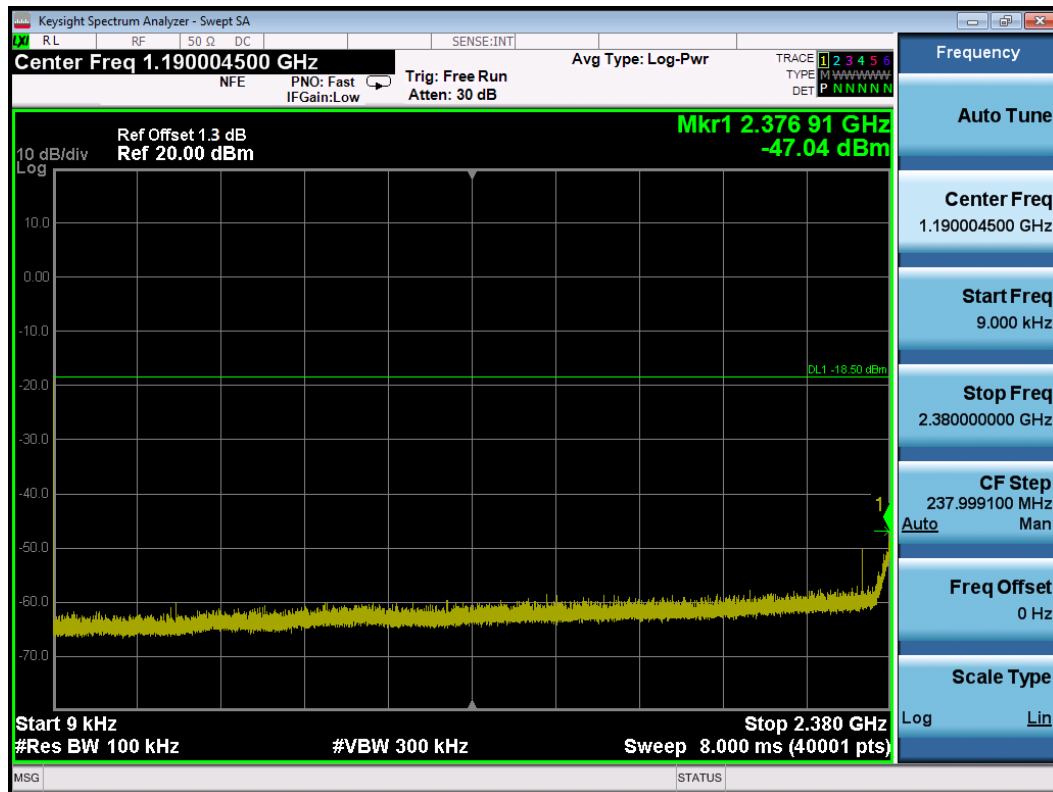
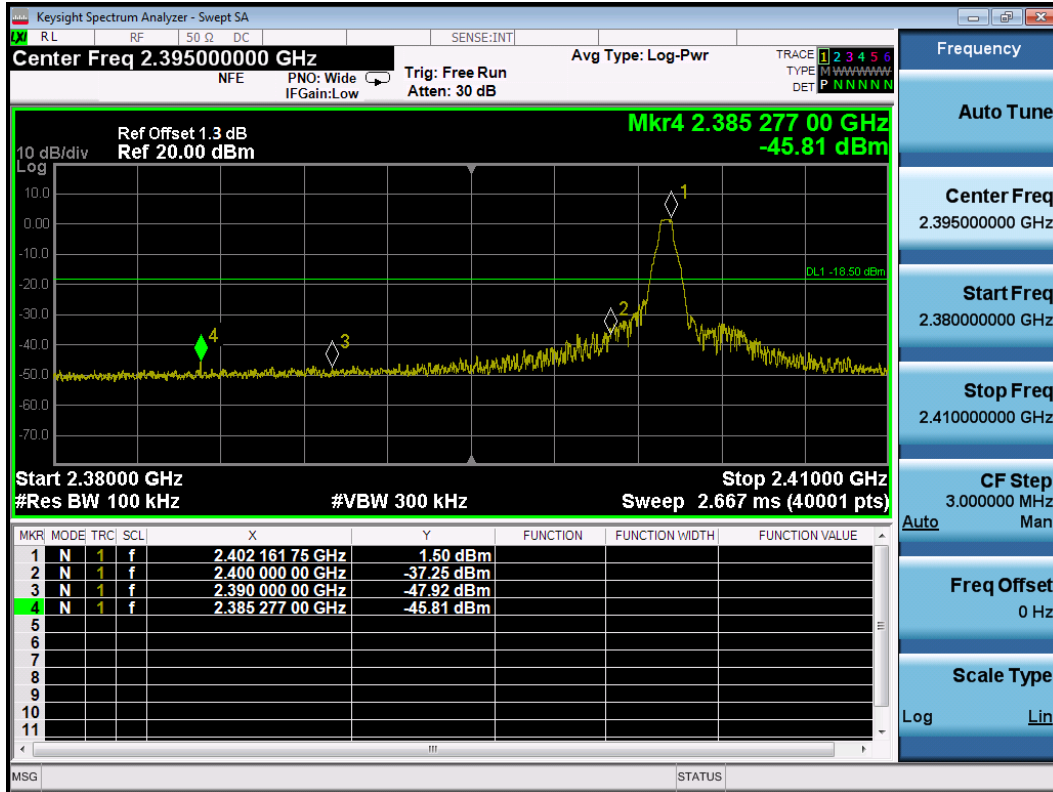

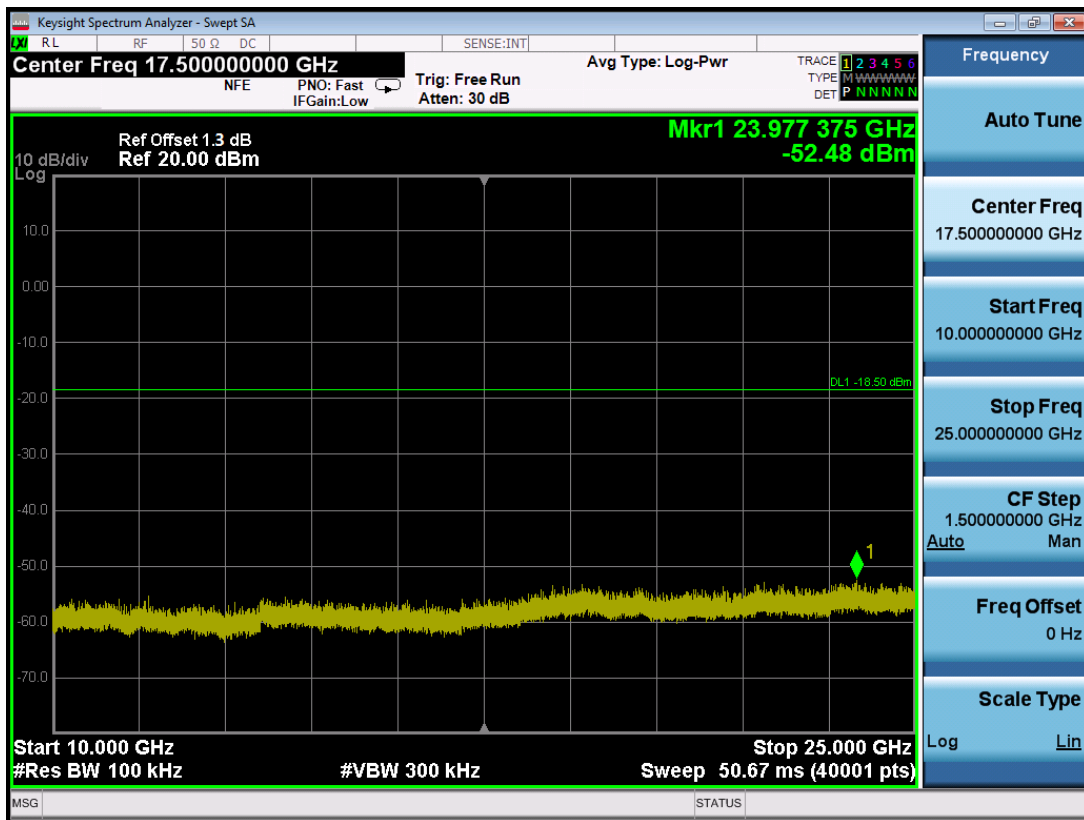
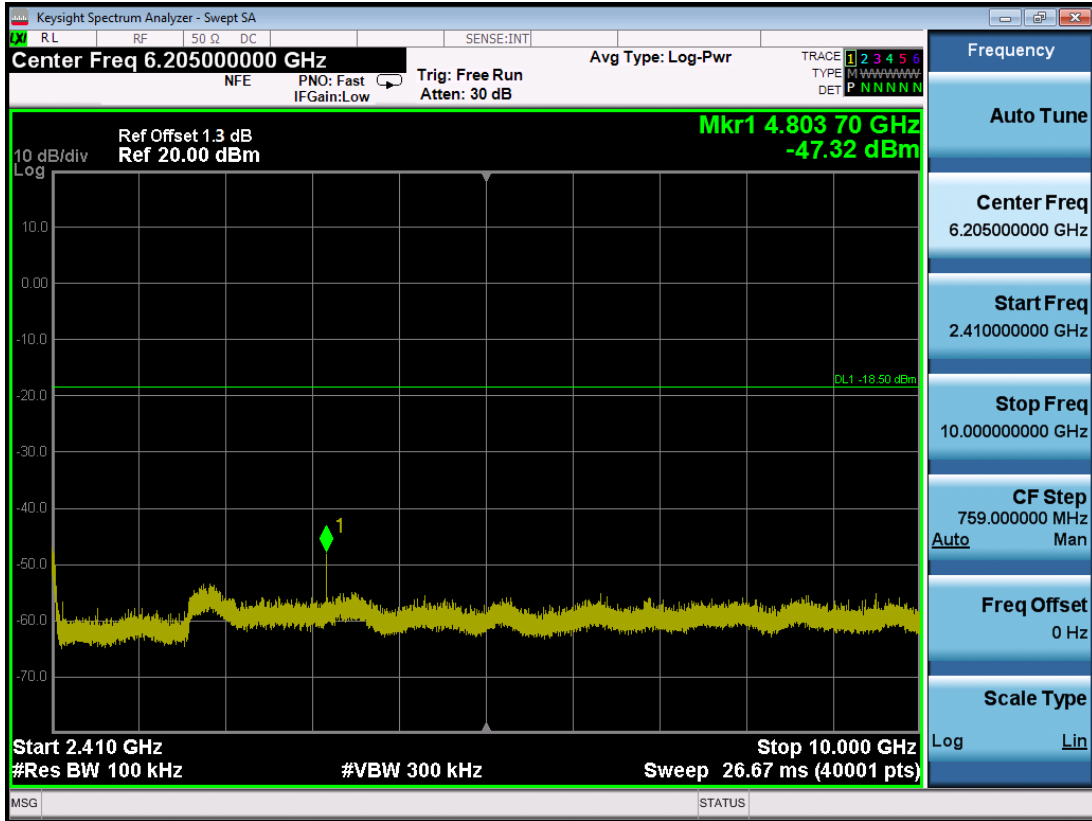

GFSK Channel- H

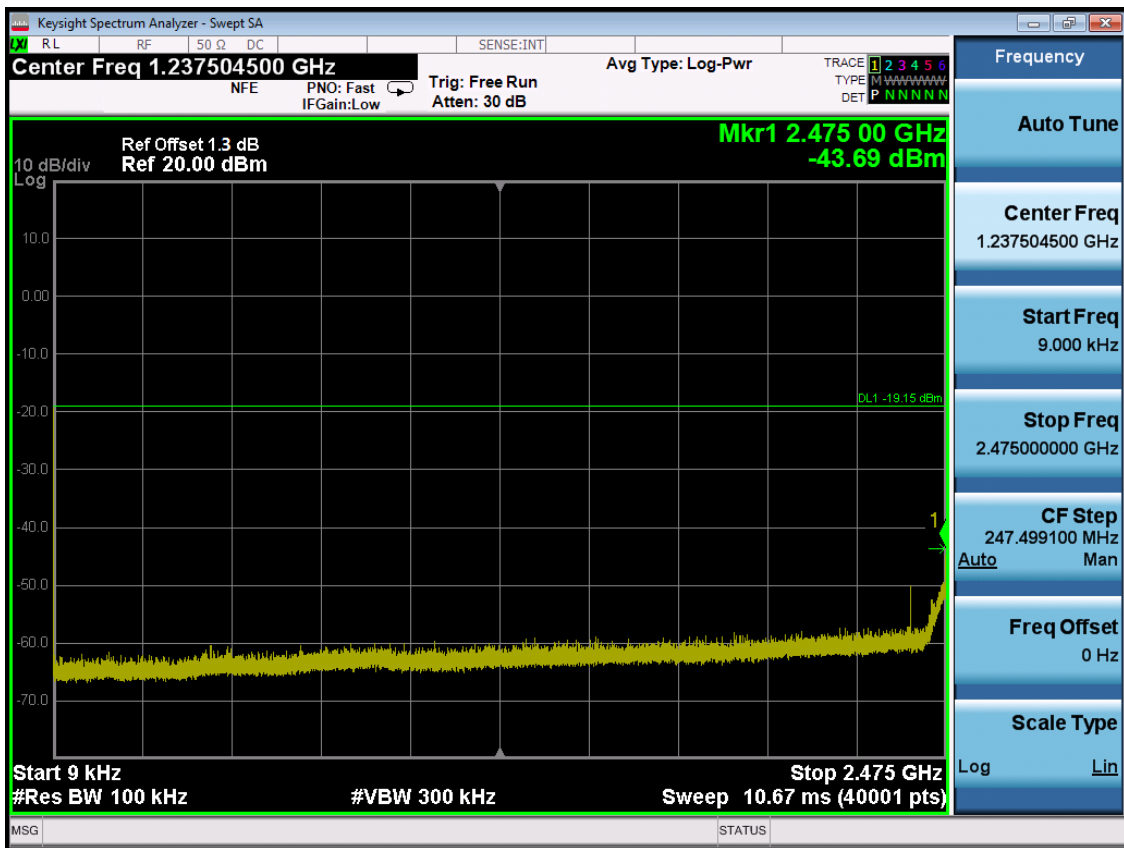
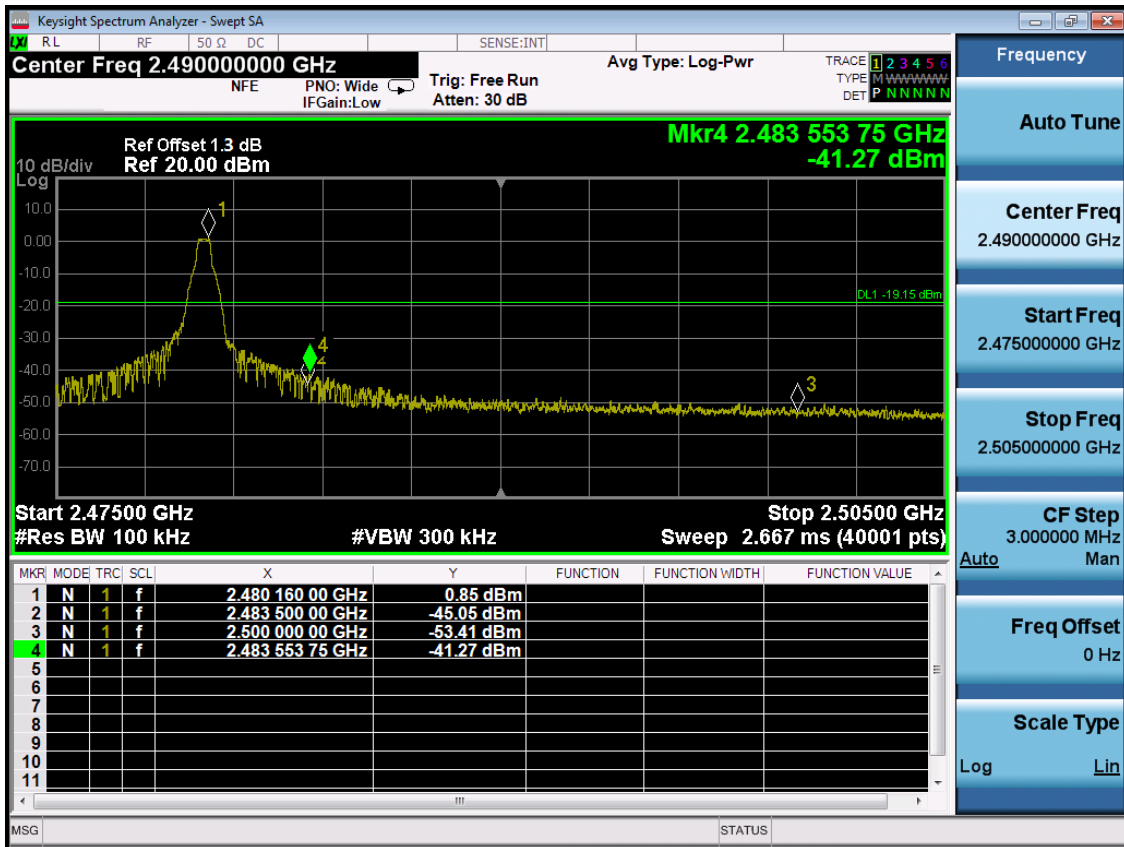

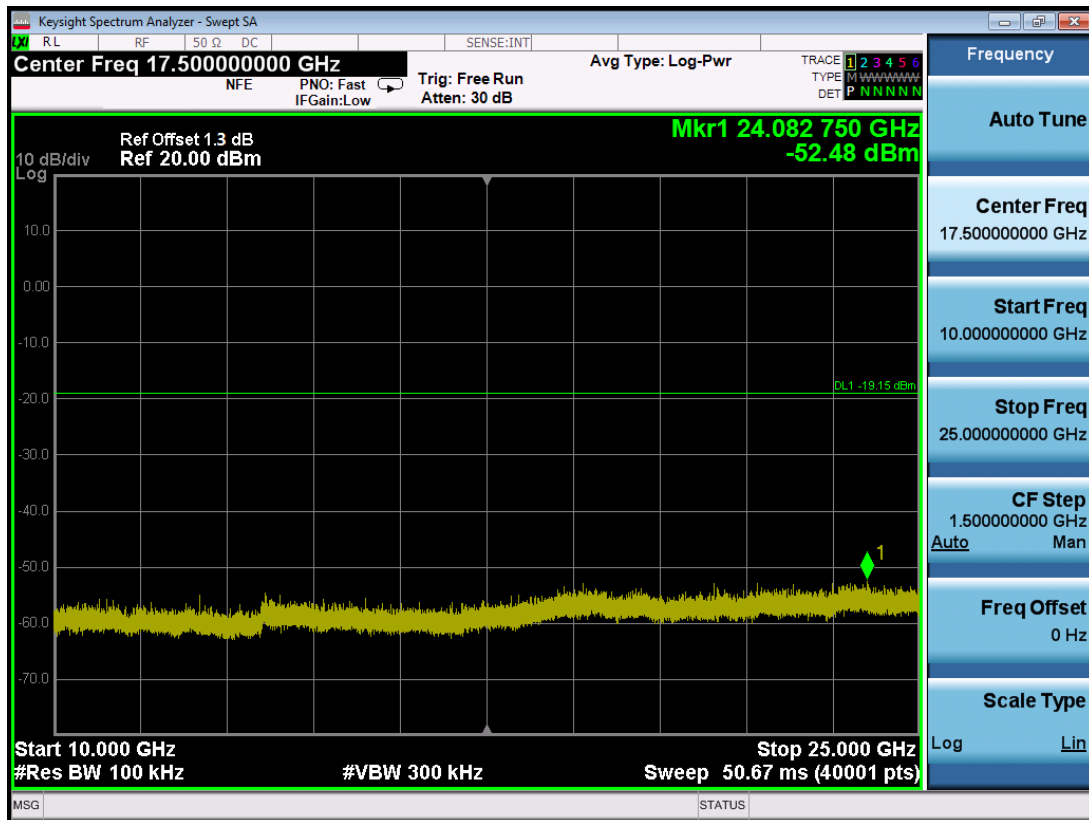
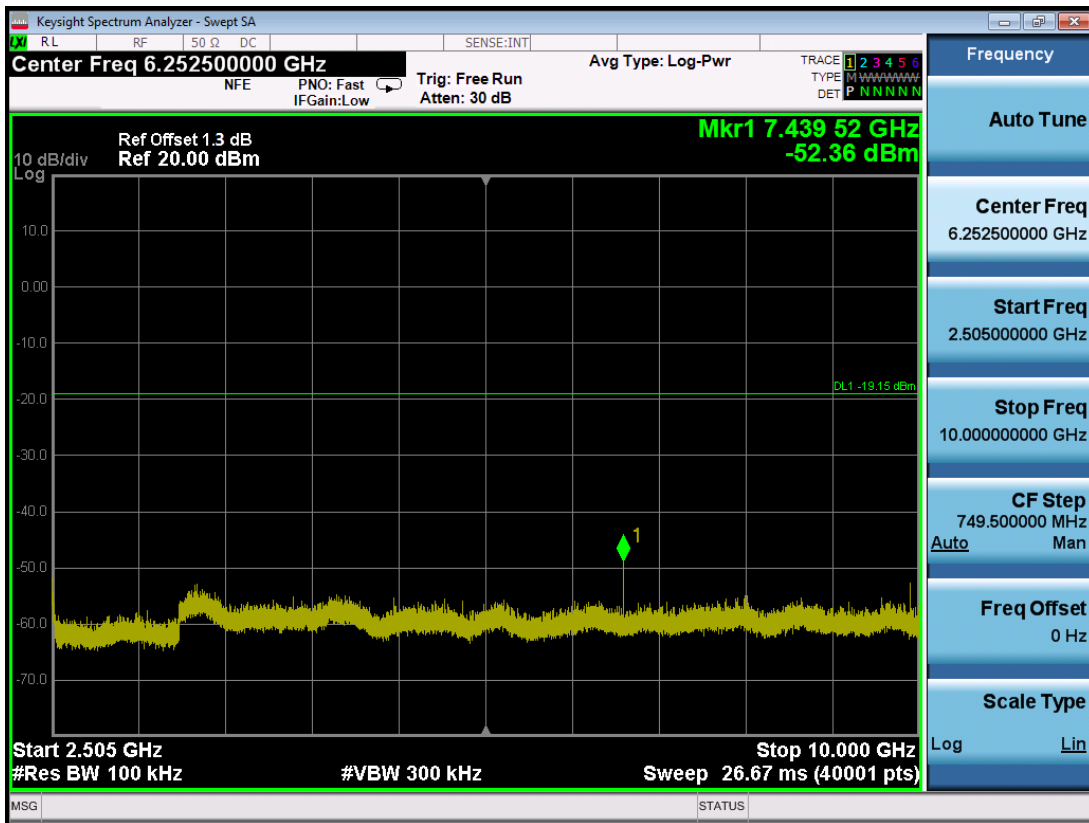

$\pi/4$  DQPSK Channel- L

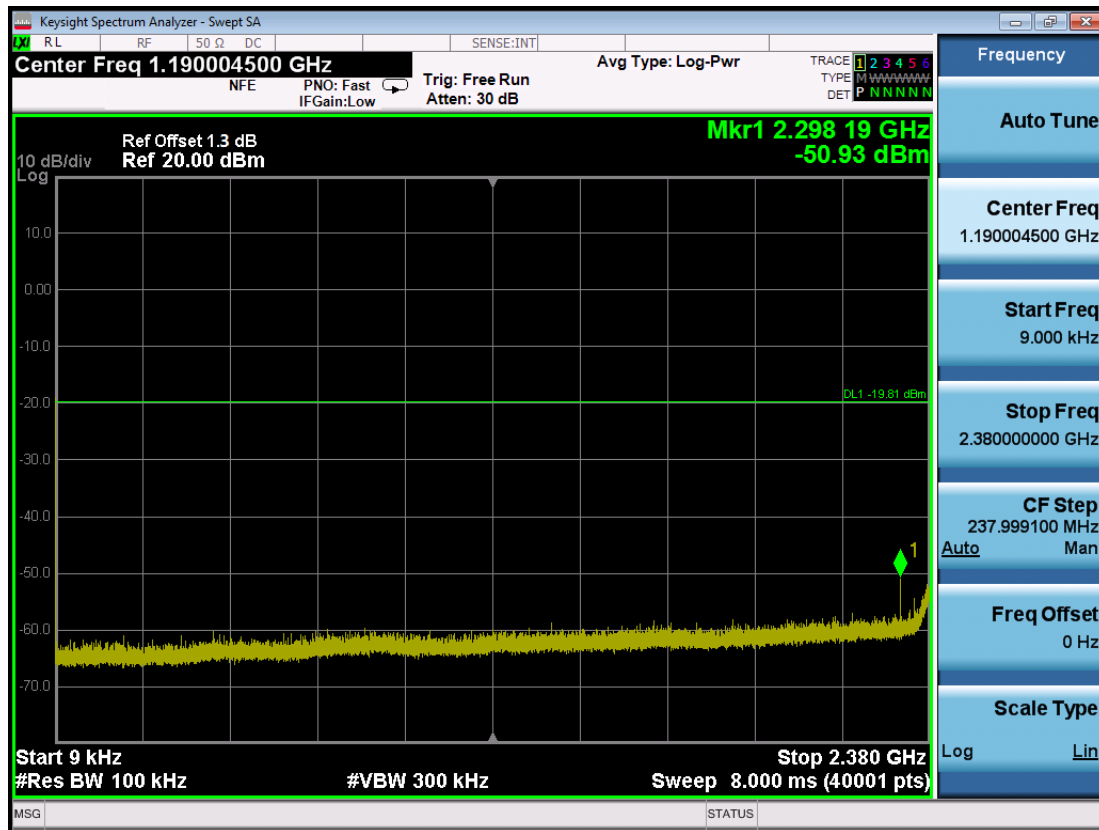
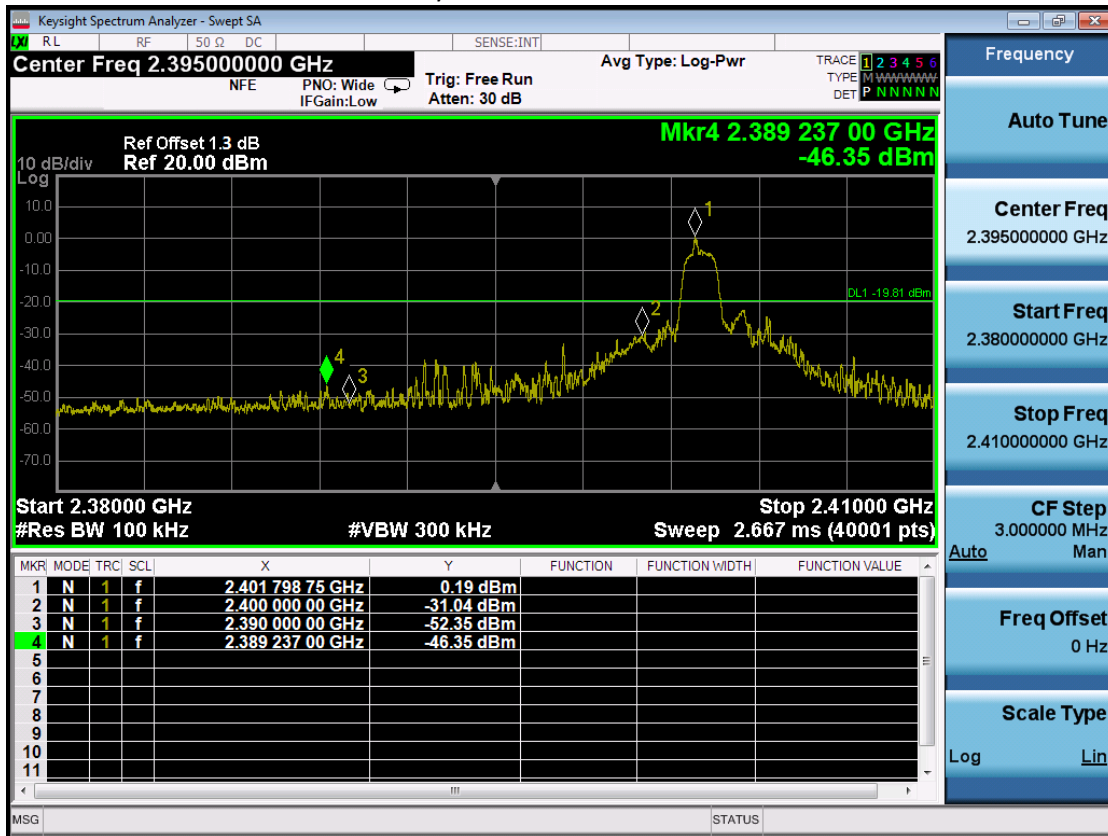

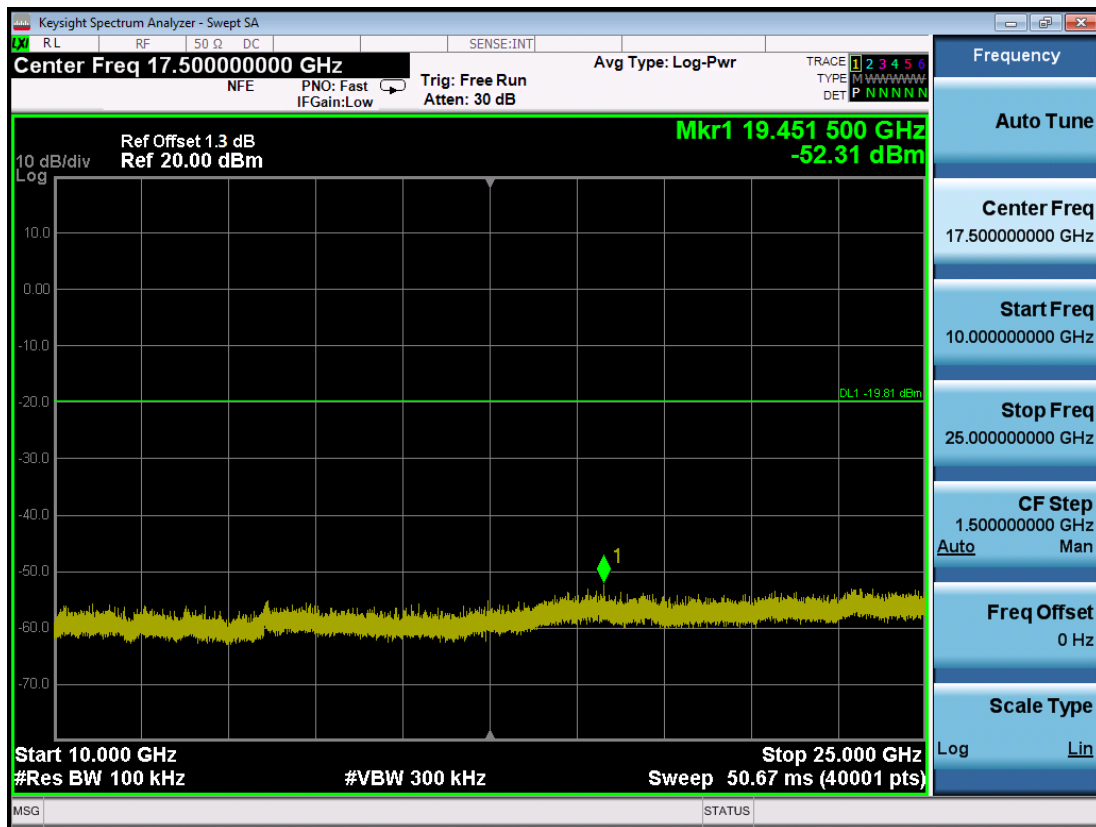
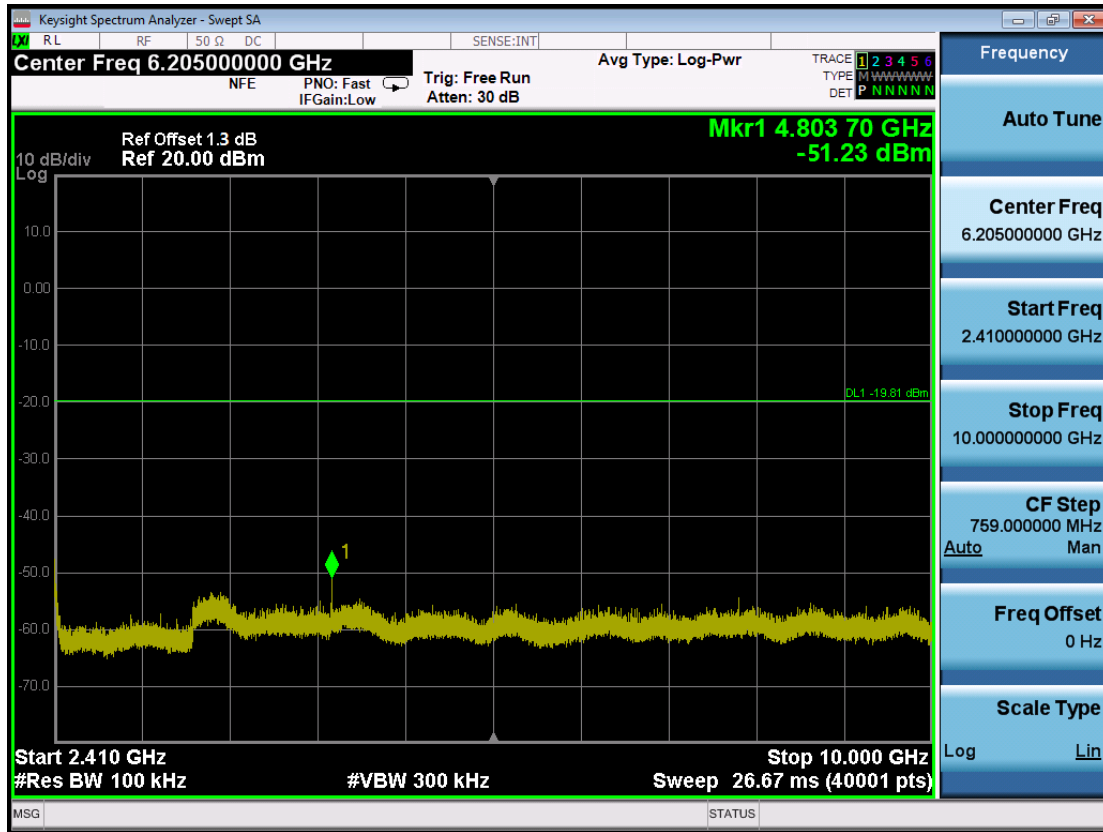

$\pi/4$  DQPSK Channel- H

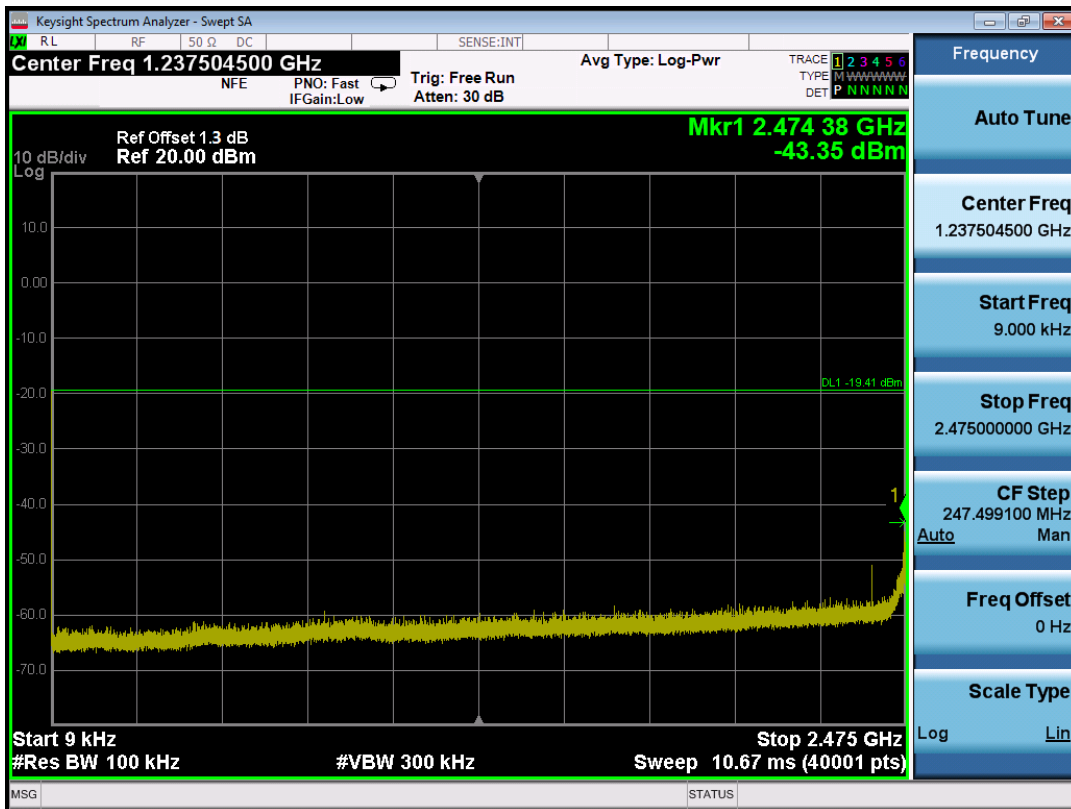
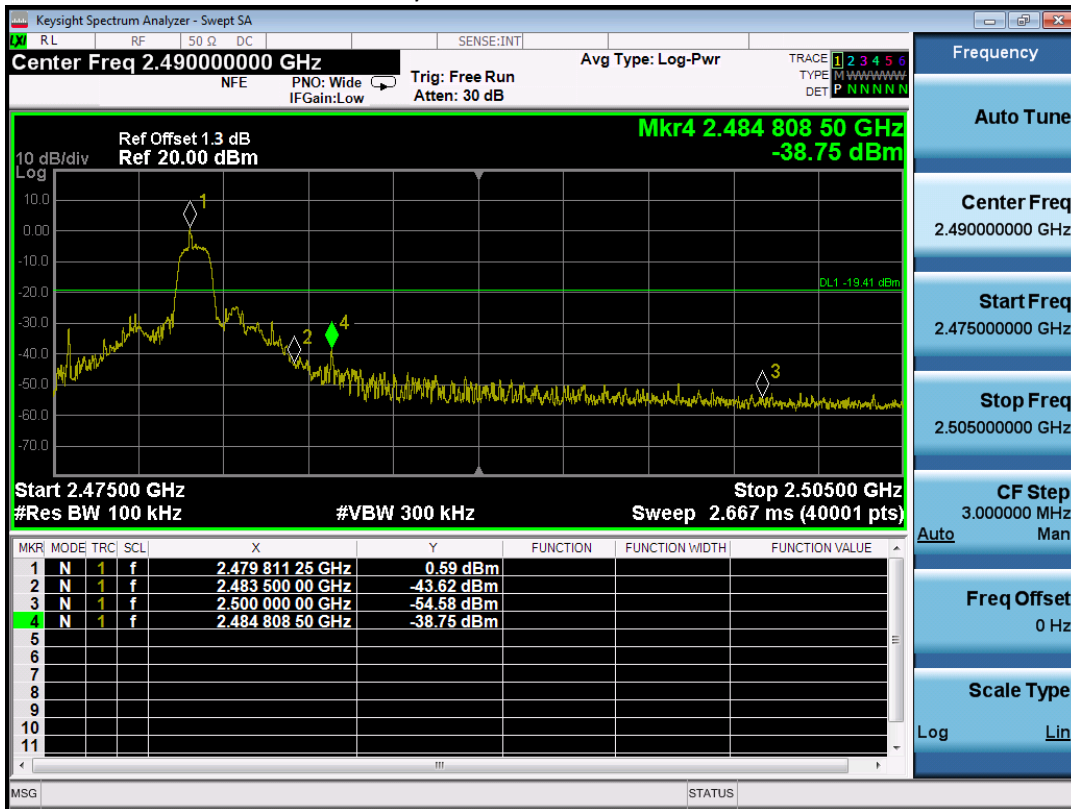



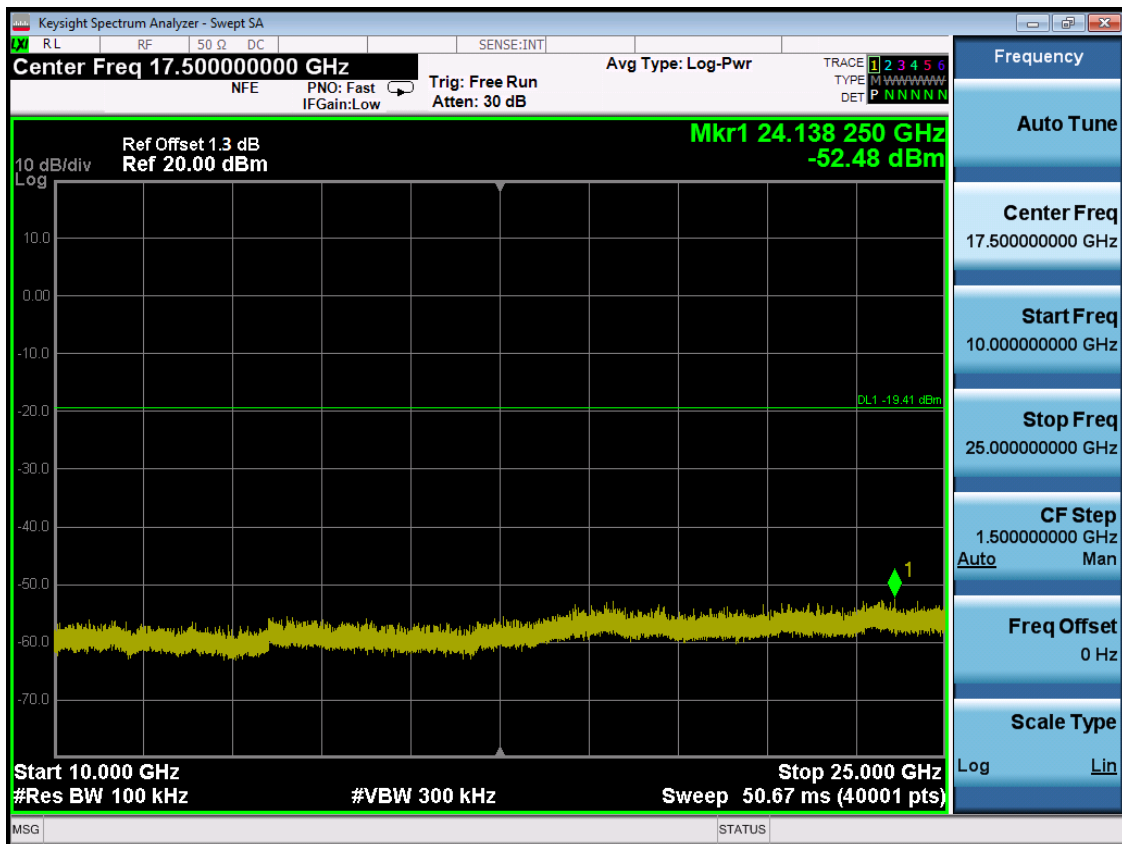
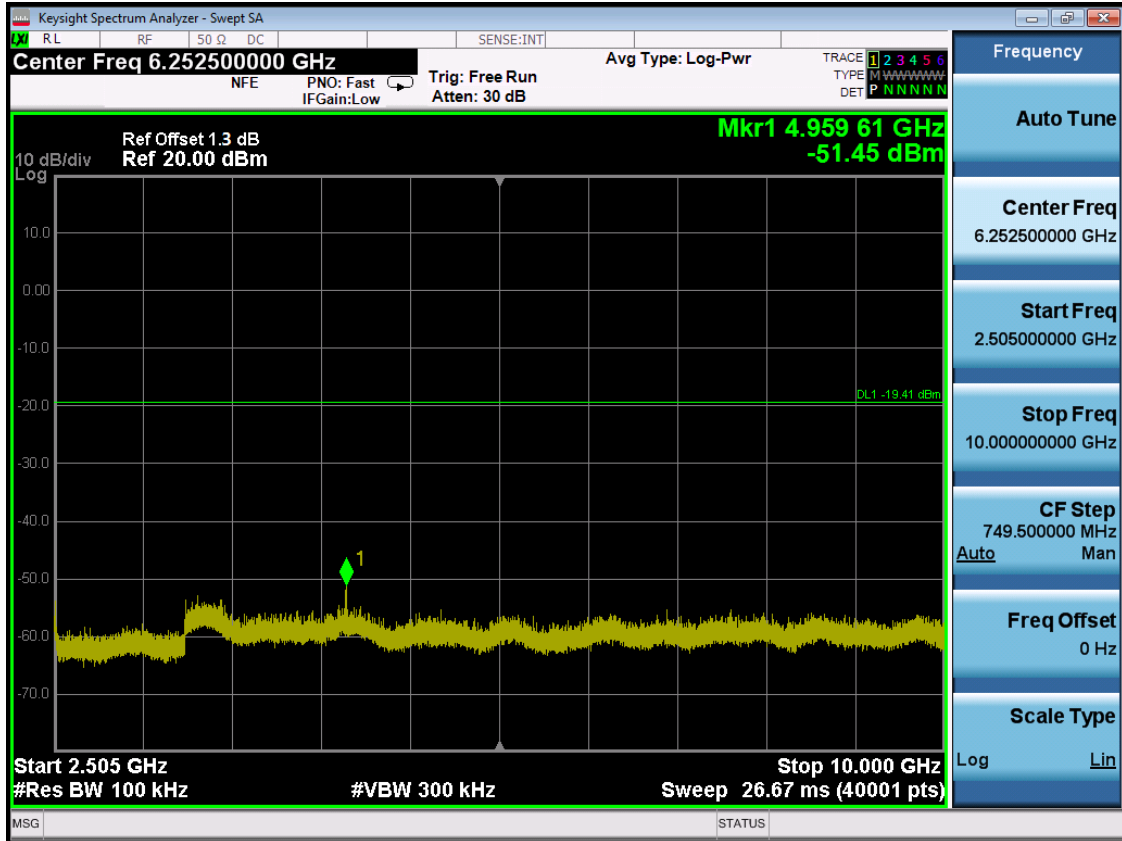



8DPSK Channel- L

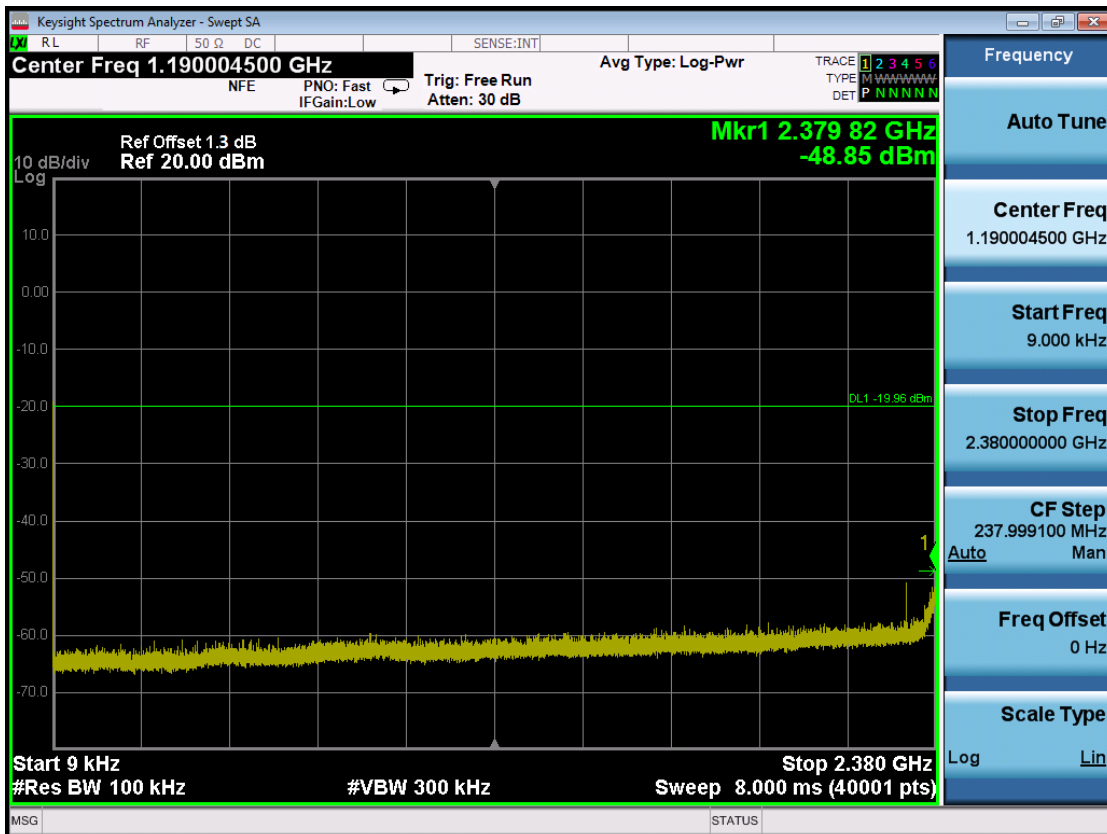
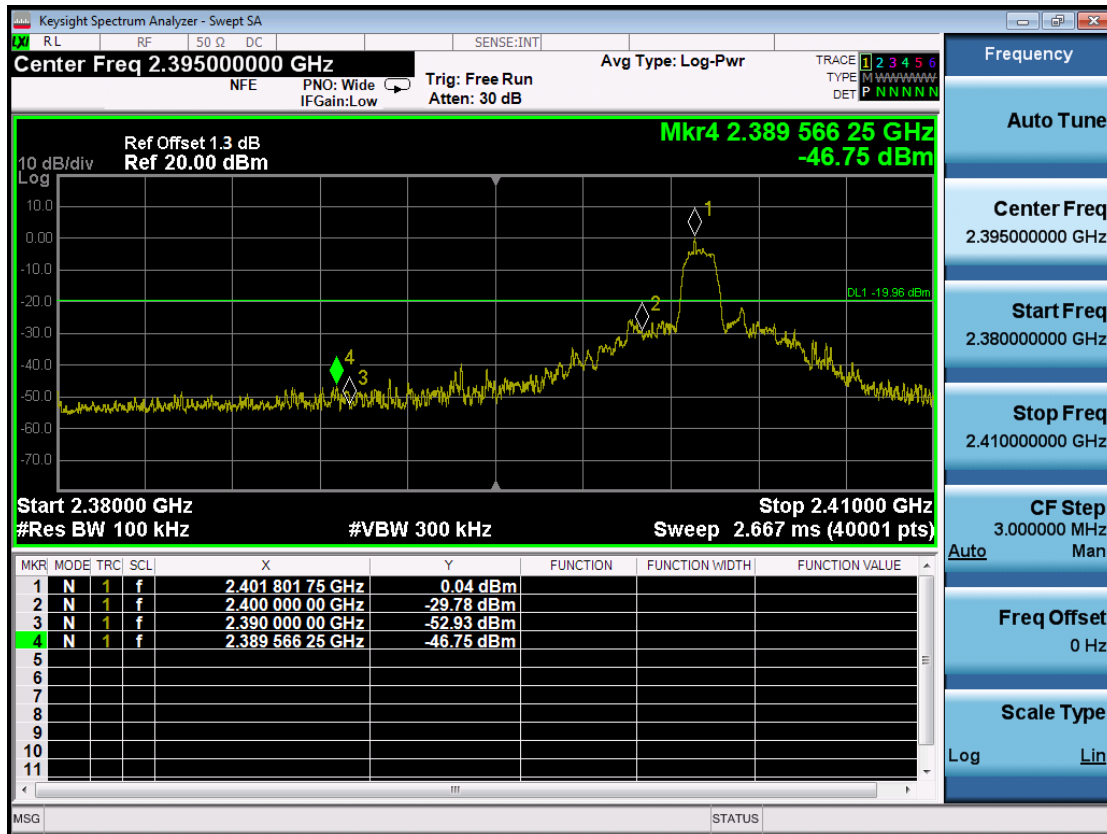

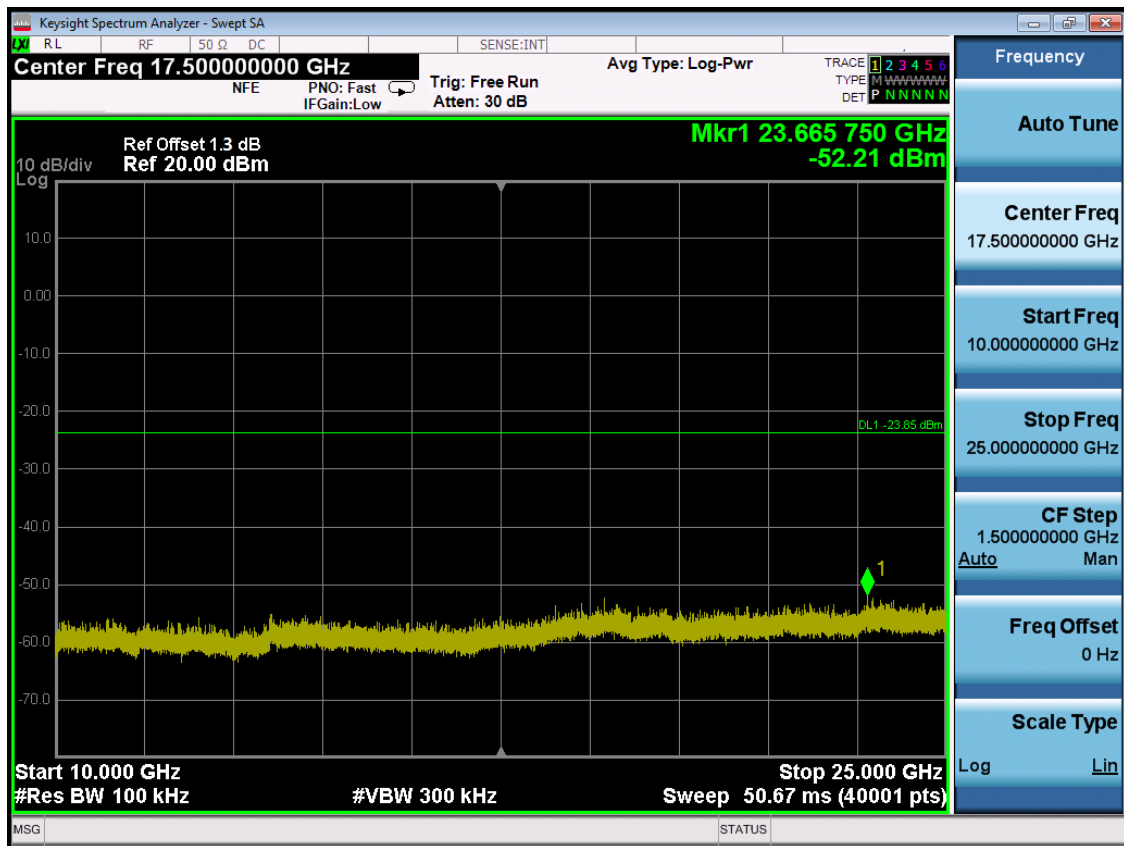
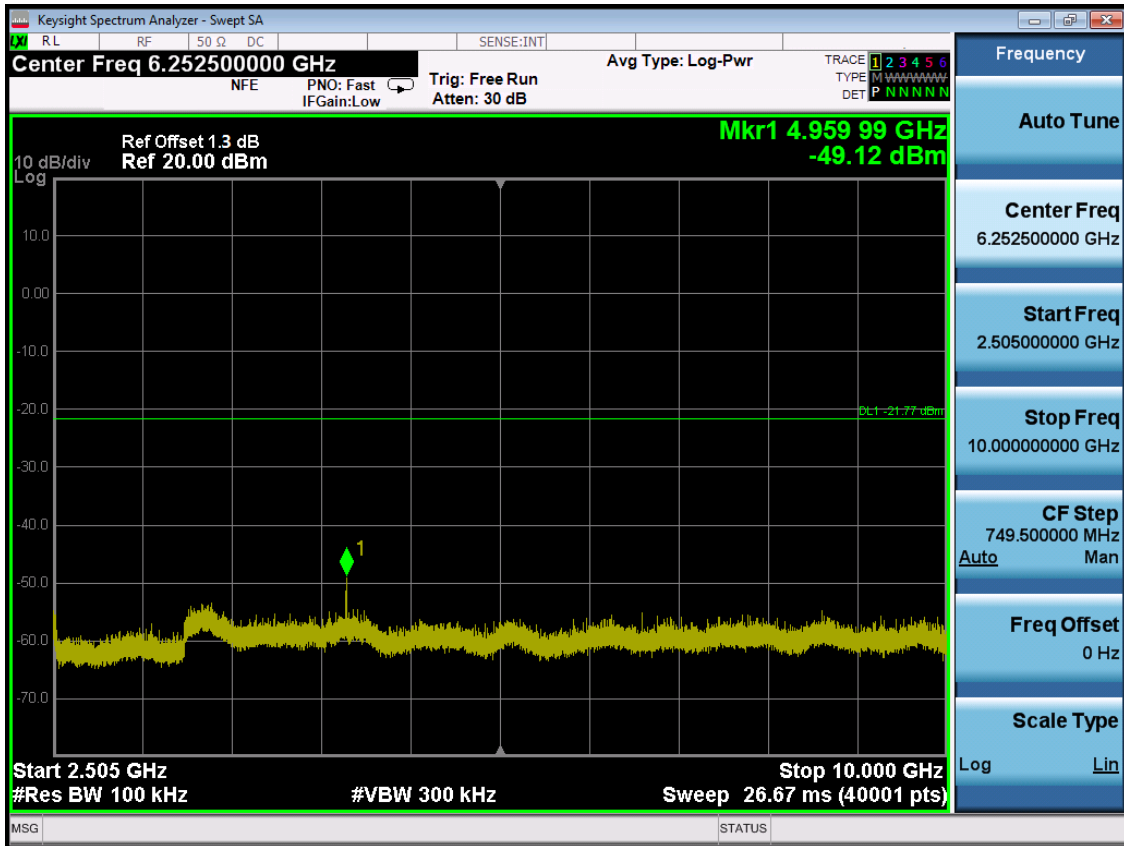

8DPSK Channel- H

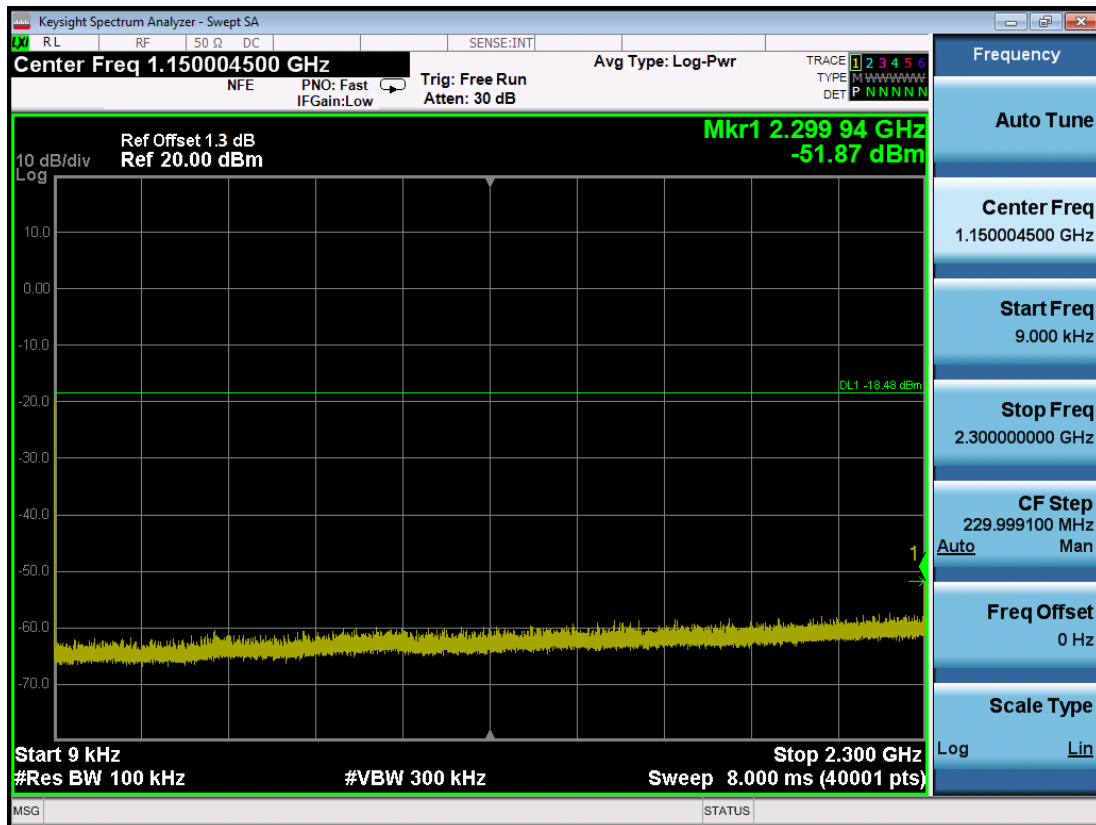
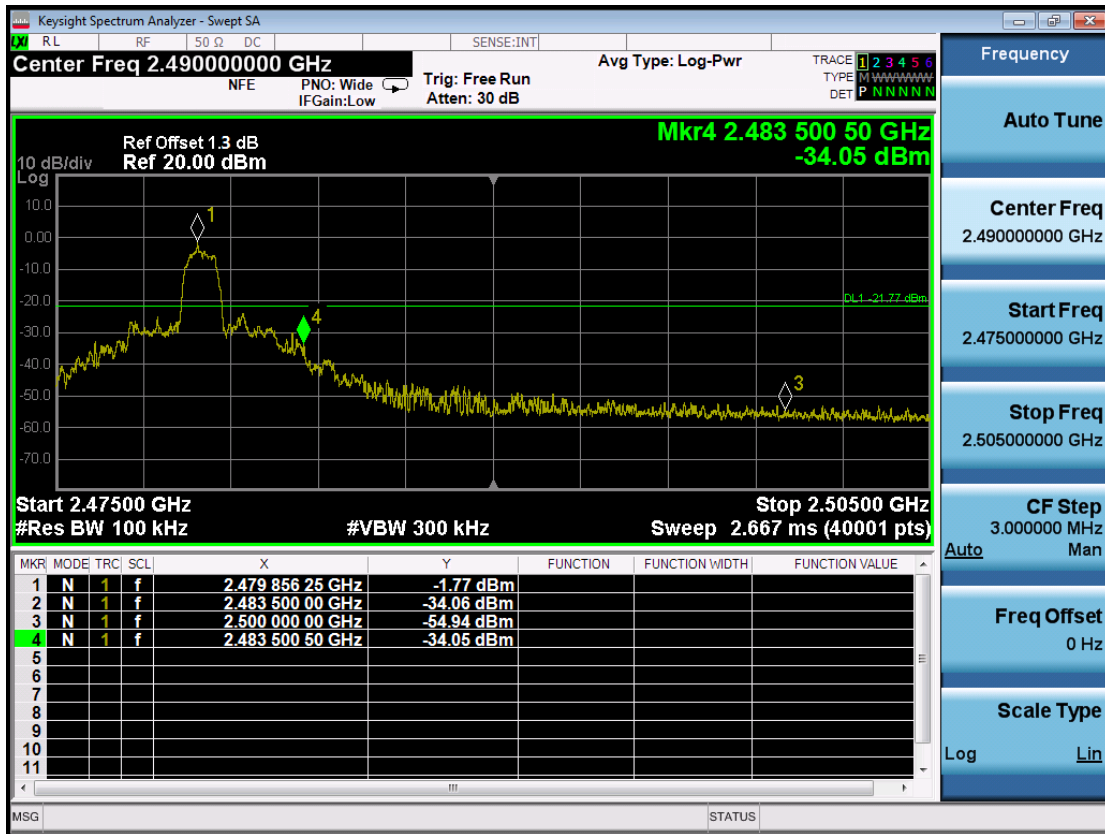

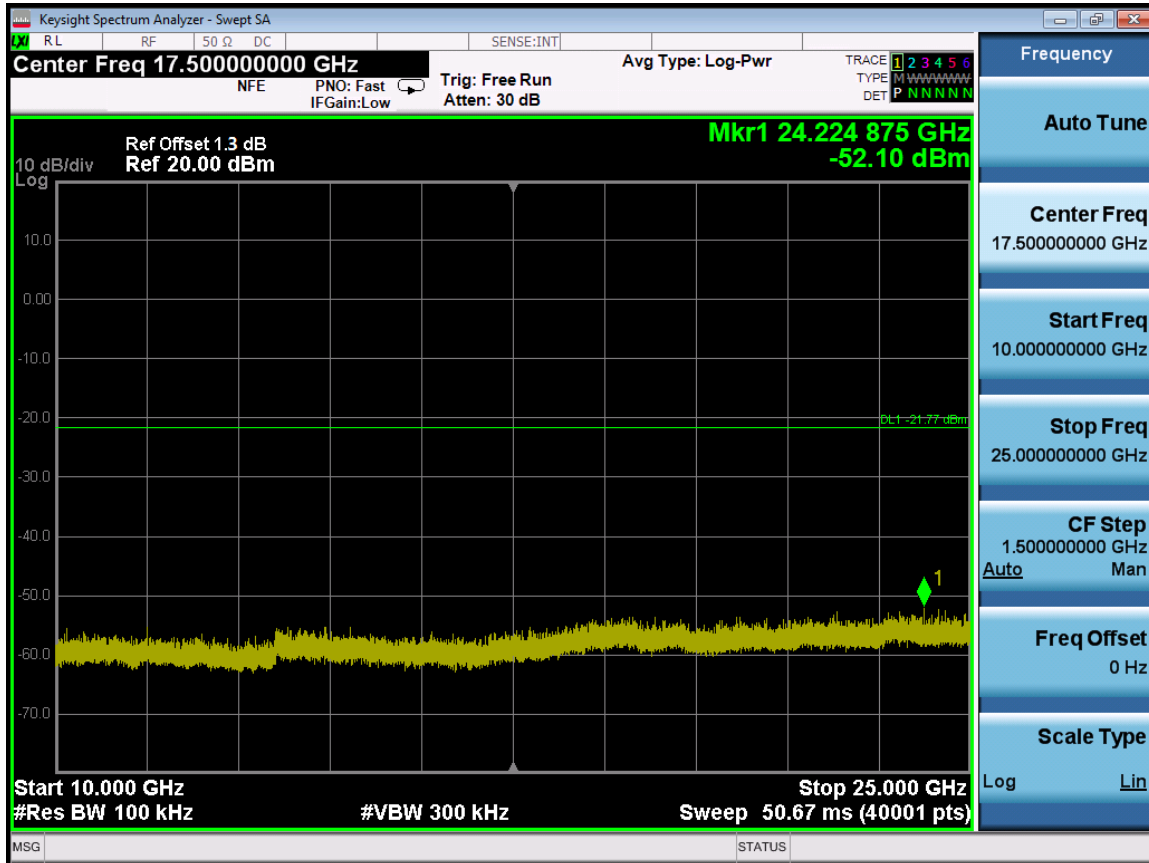
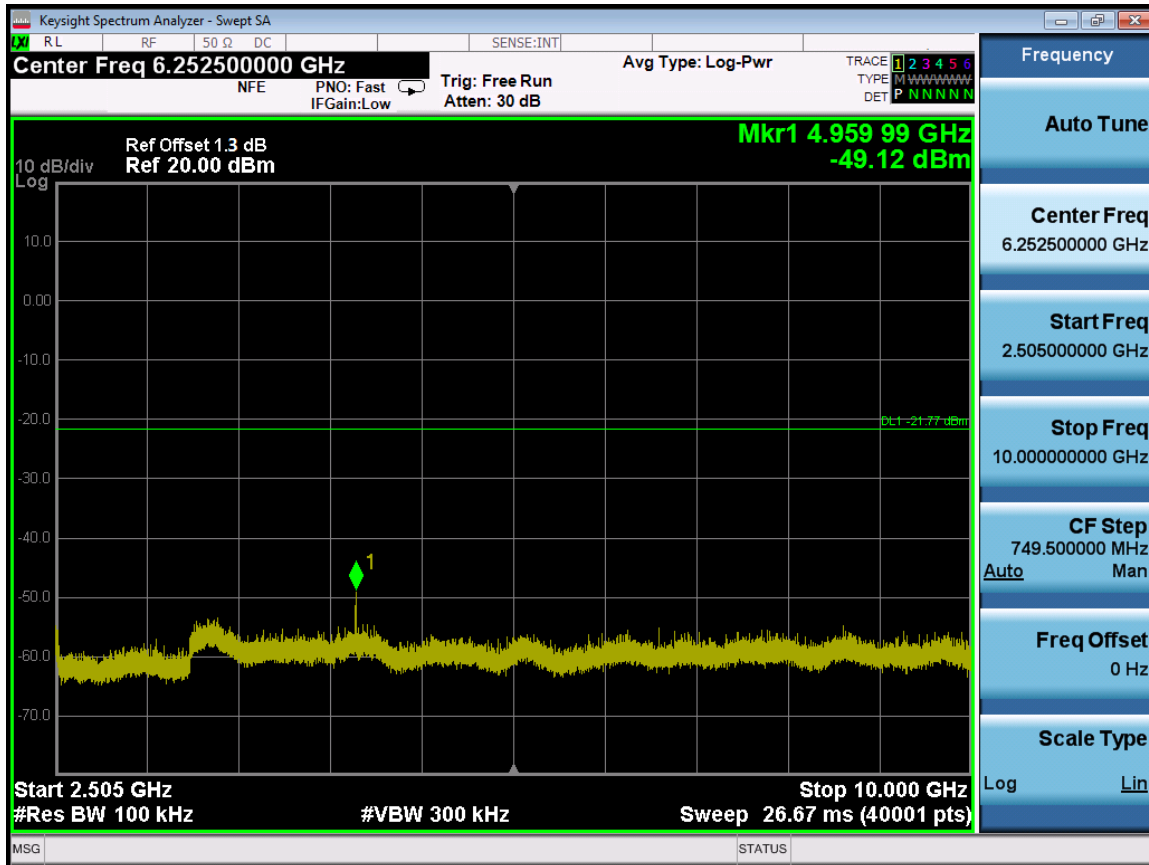

Hopping

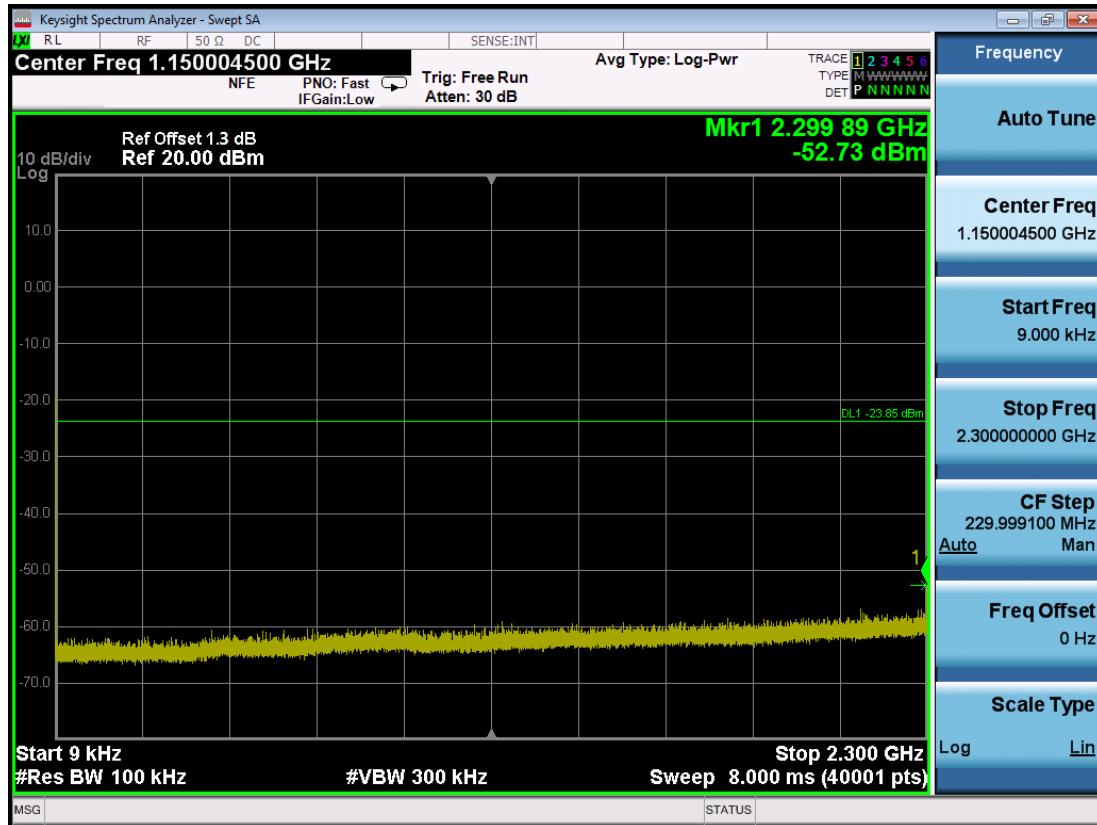
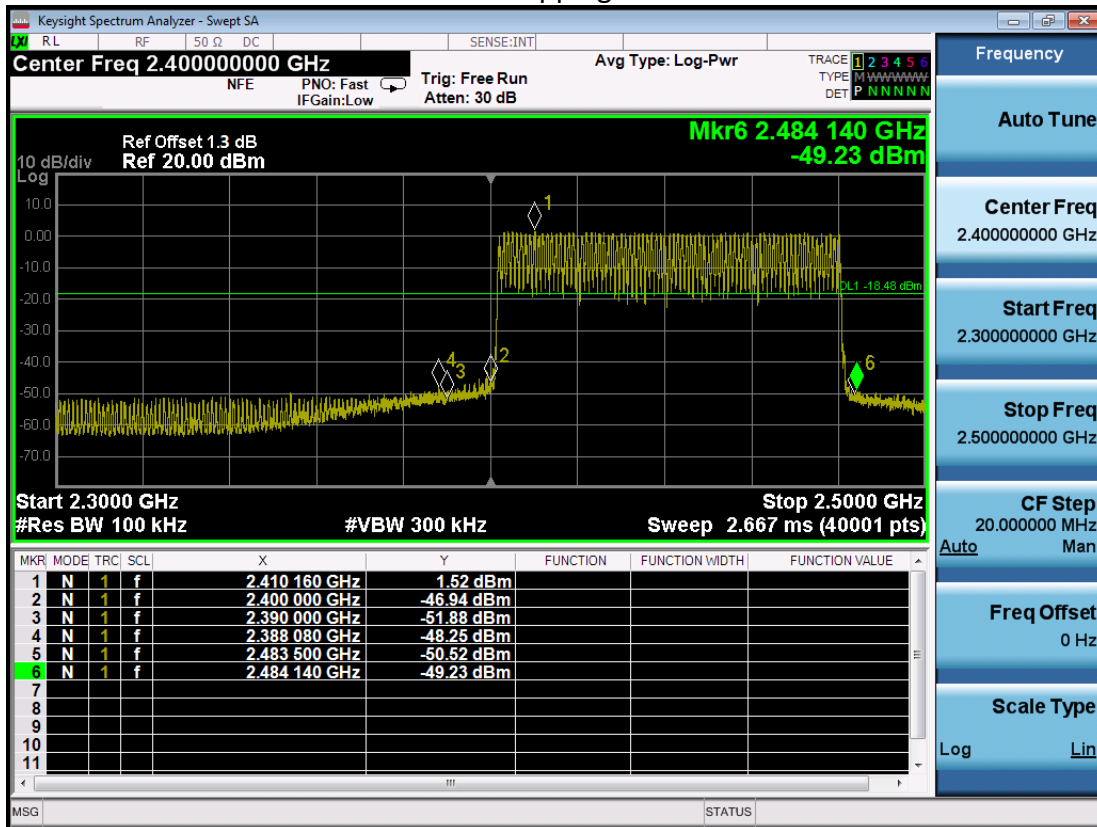

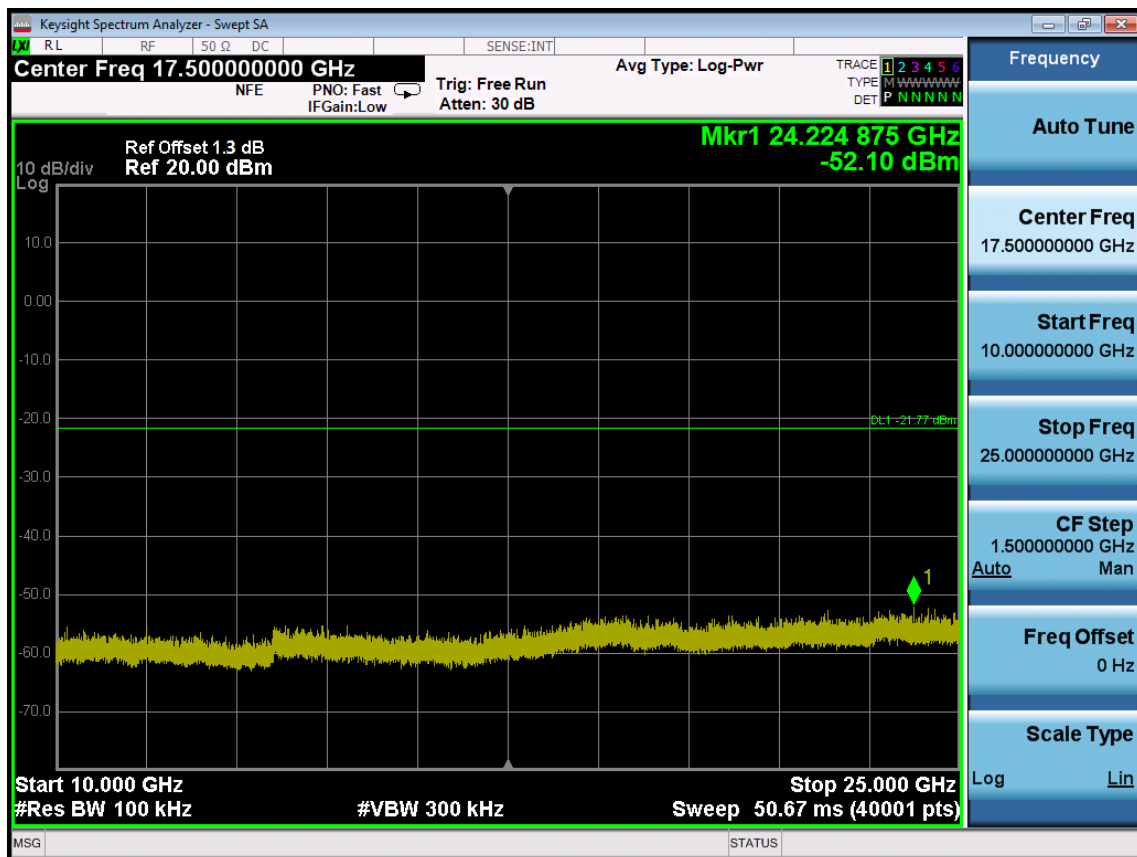
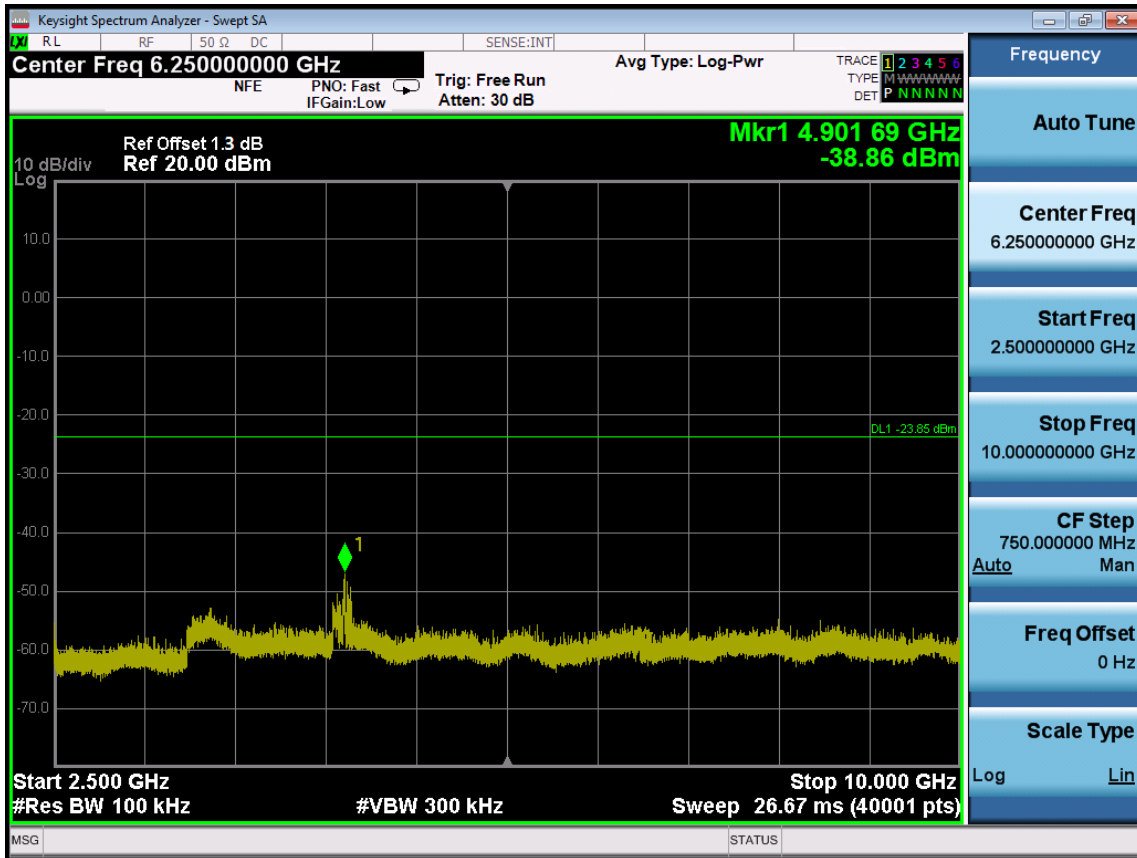

## 8 Power line conducted emission

Test result: Pass

### 8.1 Limit

Frequency of Emission (MHz)	Conducted Limit (dBuV)	
	QP	AV
0.15-0.5	66 to 56*	56 to 46 *
0.5-5	56	46
5-30	60	50

\* Decreases with the logarithm of the frequency.

### 8.2 Test configuration

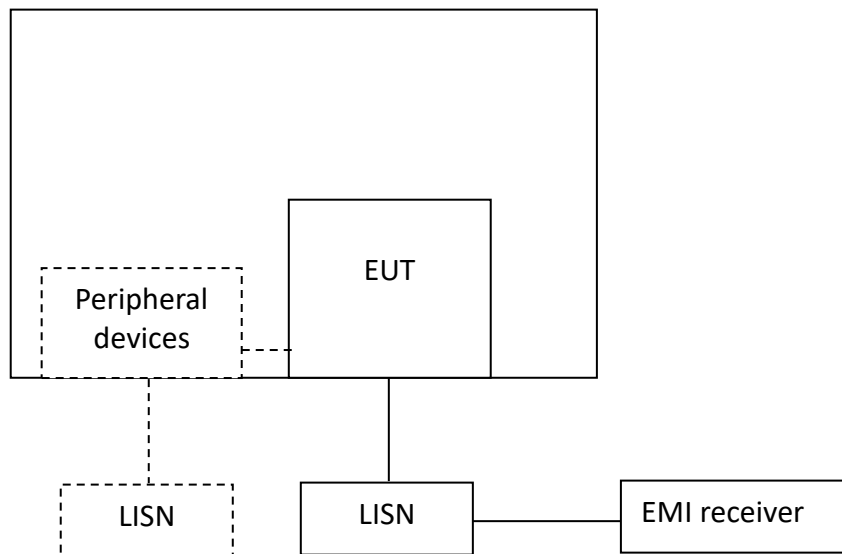

For table top equipment, wooden support is 0.8m height table

For floor standing equipment, wooden support is 0.1m height rack.

### 8.3 Test procedure and test set up

Measured levels of ac power-line conducted emission shall be the emission voltages from the voltage probe, where permitted, or across the 50  $\Omega$  LISN port (to which the EUT is connected), where permitted, terminated into a 50  $\Omega$  measuring instrument. All emission voltage and current measurements shall be made on each current-carrying conductor at the plug end of the EUT power cord by the use of mating plugs and receptacles on the LISN, if used. Equipment shall be tested with power cords that are normally supplied or recommended by the manufacturer and that have electrical and shielding characteristics that are the same as those cords normally supplied or recommended by the manufacturer. For those measurements using a LISN, the 50  $\Omega$  measuring port is terminated by a measuring instrument having 50  $\Omega$  input impedance. All other ports are terminated in 50  $\Omega$  loads.

Tabletop devices shall be placed on a platform of nominal size 1 m by 1.5 m, raised 80 cm above the reference ground plane. The vertical conducting plane or wall of an RF-shielded (screened) room shall be located 40 cm to the rear of the EUT. Floor-standing devices shall be placed either directly on the reference ground-plane or on insulating material as described in ANSI C63.4. All other surfaces of tabletop or floor-standing EUTs shall be at least 80 cm from any other grounded conducting surface, including the case or cases of one or more LISNs.

The bandwidth of the test receiver is set at 9 kHz.



**8.4 Test protocol**

Temperature: 22 °C

Relative Humidity: 52 %

L line

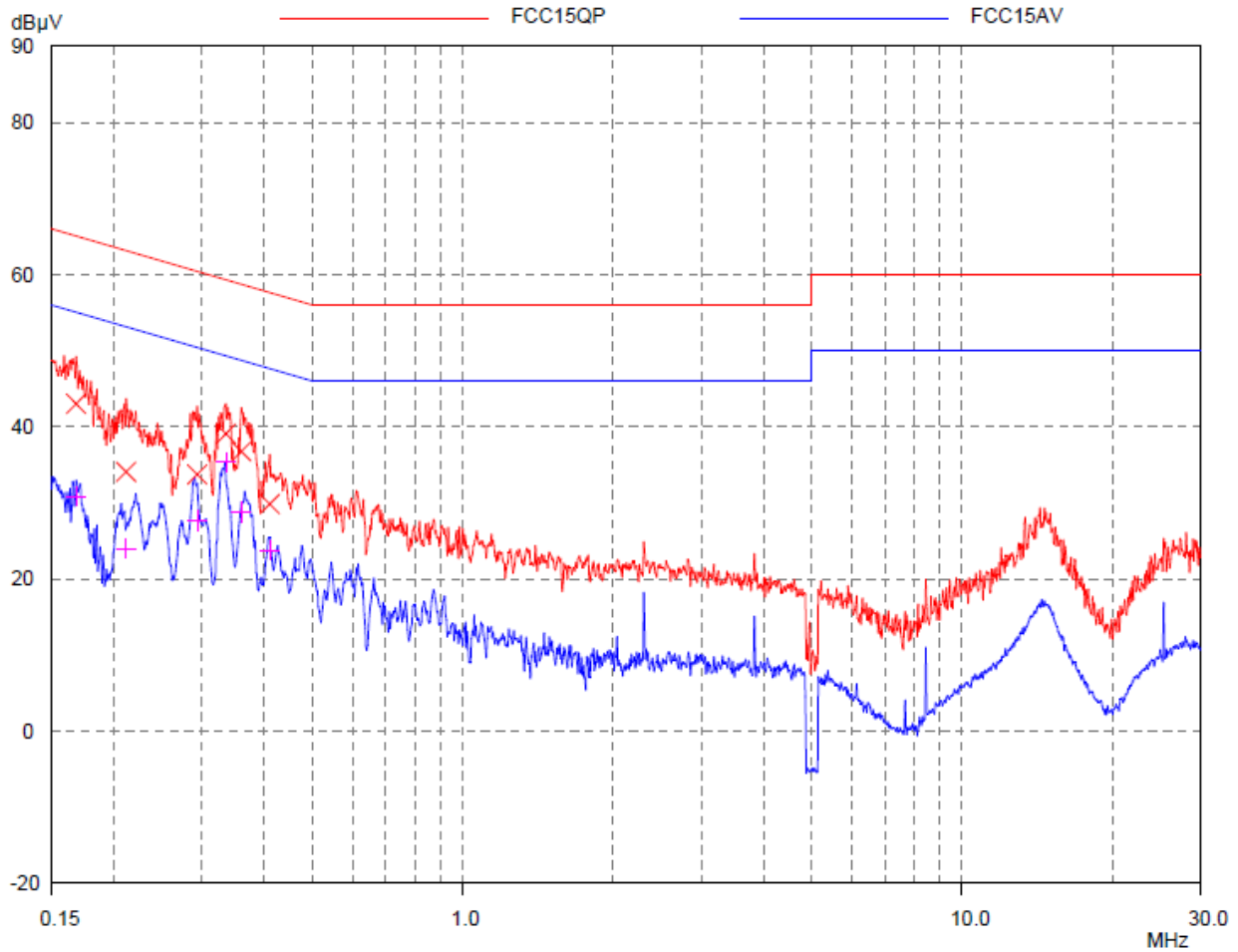

**Test Data:**

Frequency (MHz)	Quasi-peak			Average		
	Corrected Reading (dBuV)	Limit (dBuV)	Margin (dB)	Corrected Reading (dBuV)	Limit (dBuV)	Margin (dB)
0.17	43.03	65.07	22.04	30.85	55.07	24.22
0.21	34.08	63.15	29.07	24.01	53.15	29.14
0.29	33.75	60.43	26.68	27.73	50.43	22.7
0.33	39.09	59.34	20.25	35.38	49.34	13.96
0.36	36.75	58.74	21.99	28.81	48.74	19.93
0.41	29.88	57.64	27.76	23.78	47.64	23.86

Note: All possible modes of operation were investigated. Only the worst case emissions measured.

N line

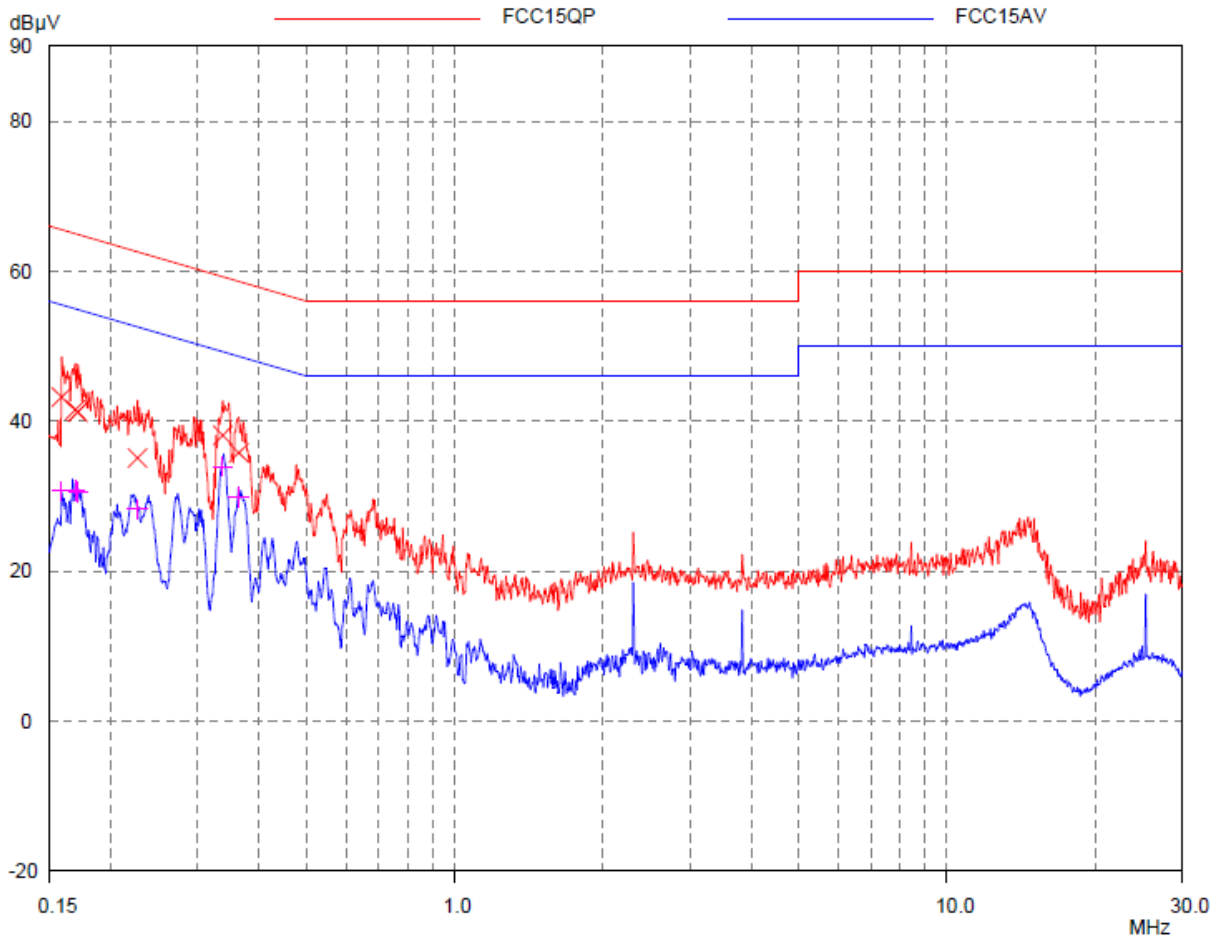

**Test Data:**

Frequency (MHz)	Quasi-peak			Average		
	Corrected Reading (dBuV)	Limit (dBuV)	Margin (dB)	Corrected Reading (dBuV)	Limit (dBuV)	Margin (dB)
0.16	43.22	65.54	22.32	30.70	55.54	24.84
0.17	41.54	65.01	23.47	30.77	55.01	24.24
0.17	41.22	64.91	23.69	30.54	54.91	24.37
0.23	35.09	62.59	27.50	28.29	52.59	24.30
0.34	38.12	59.27	21.15	33.97	49.27	15.30
0.36	35.79	58.64	22.85	29.90	48.64	18.74

Note: All possible modes of operation were investigated. Only the worst case emissions measured.

## 9 Number of Hopping Frequencies

**Test result:** Pass

### 9.1 Limit

Number of Hopping Frequencies in the 2400-2483.5 MHz band shall use at least 15 channels.

### 9.2 Test Configuration

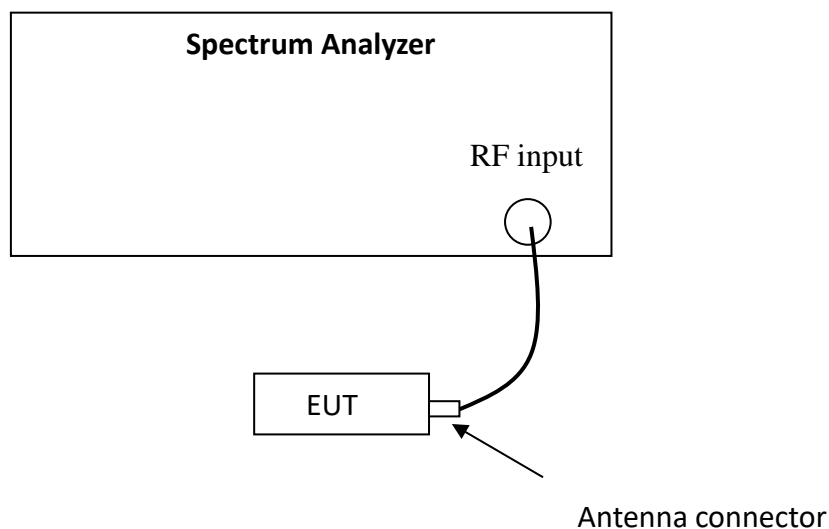

### 9.3 Test procedure and test setup

The channel number per FCC §15.247(a)(1)(iii) is measured using the Spectrum Analyzer with RBW=100kHz, VBW≥RBW, Sweep = auto, Detector = peak, Trace = max hold. The EUT was tested according to DA 00-705 (Filing and Measurement Guidelines for Frequency Hopping Spread Spectrum Systems).

### 9.4 Test protocol

Temperature : 25 °C  
Relative Humidity : 55 %

Channel Number	Limit
79	≥15

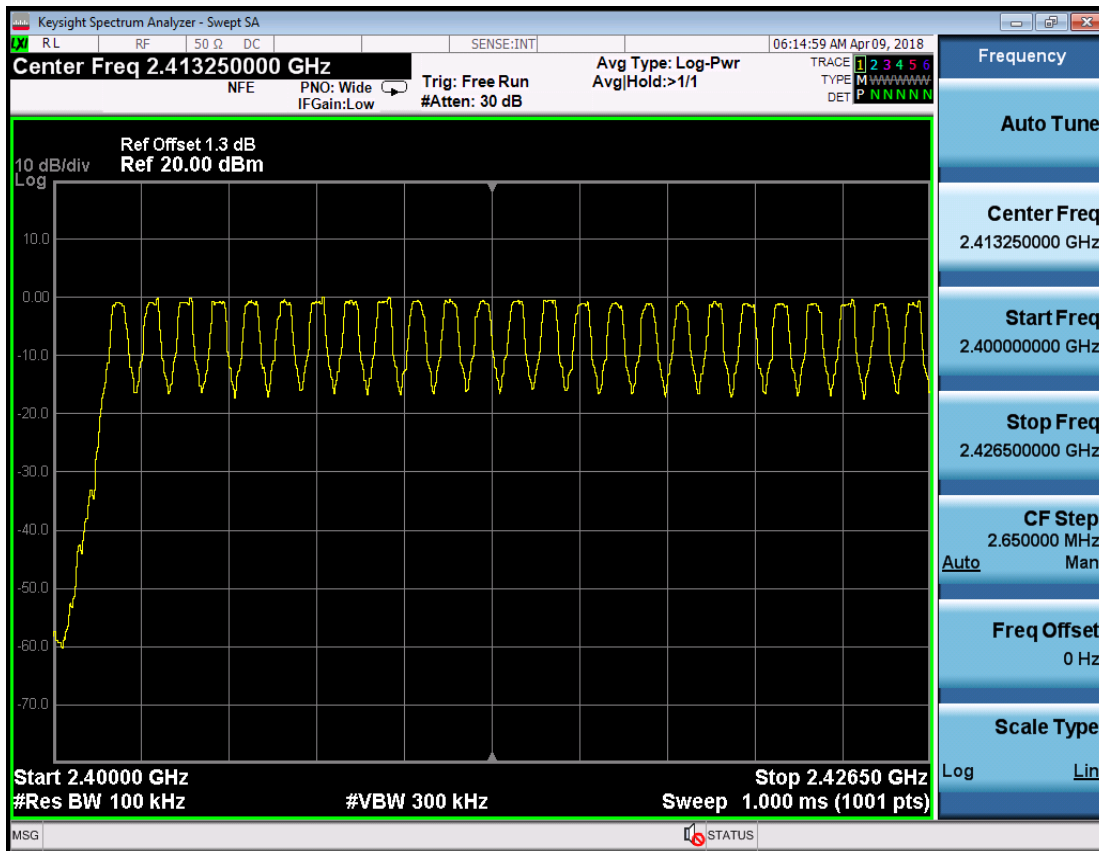
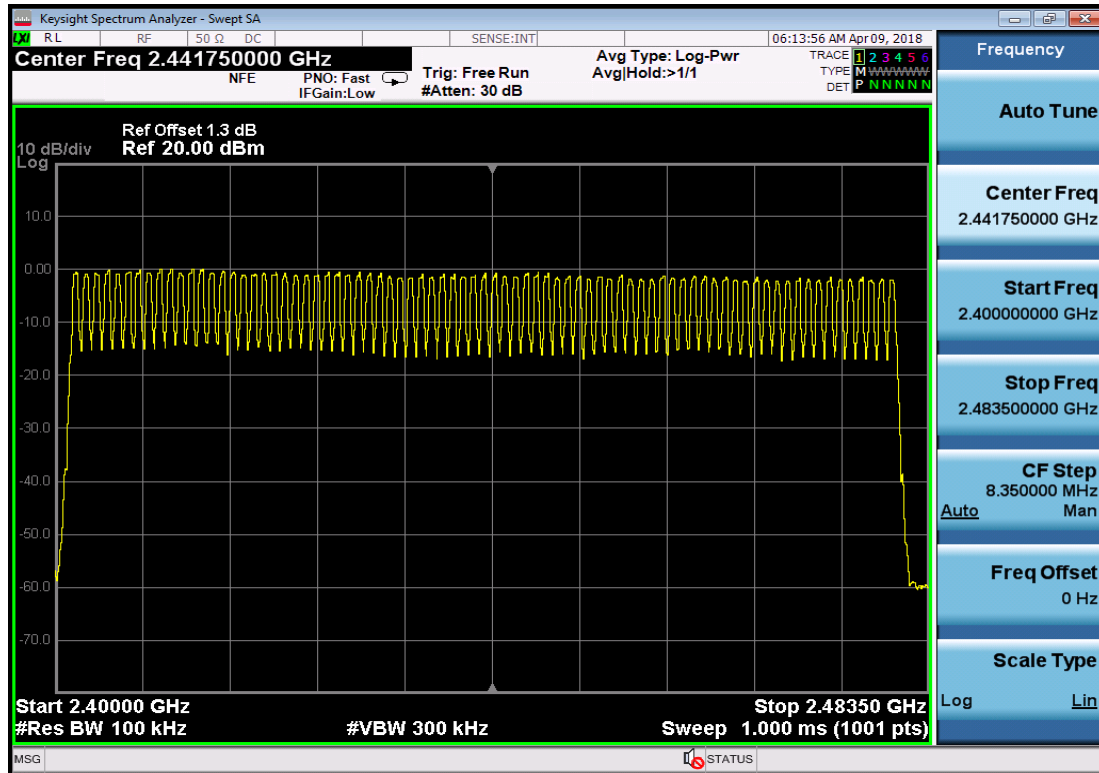

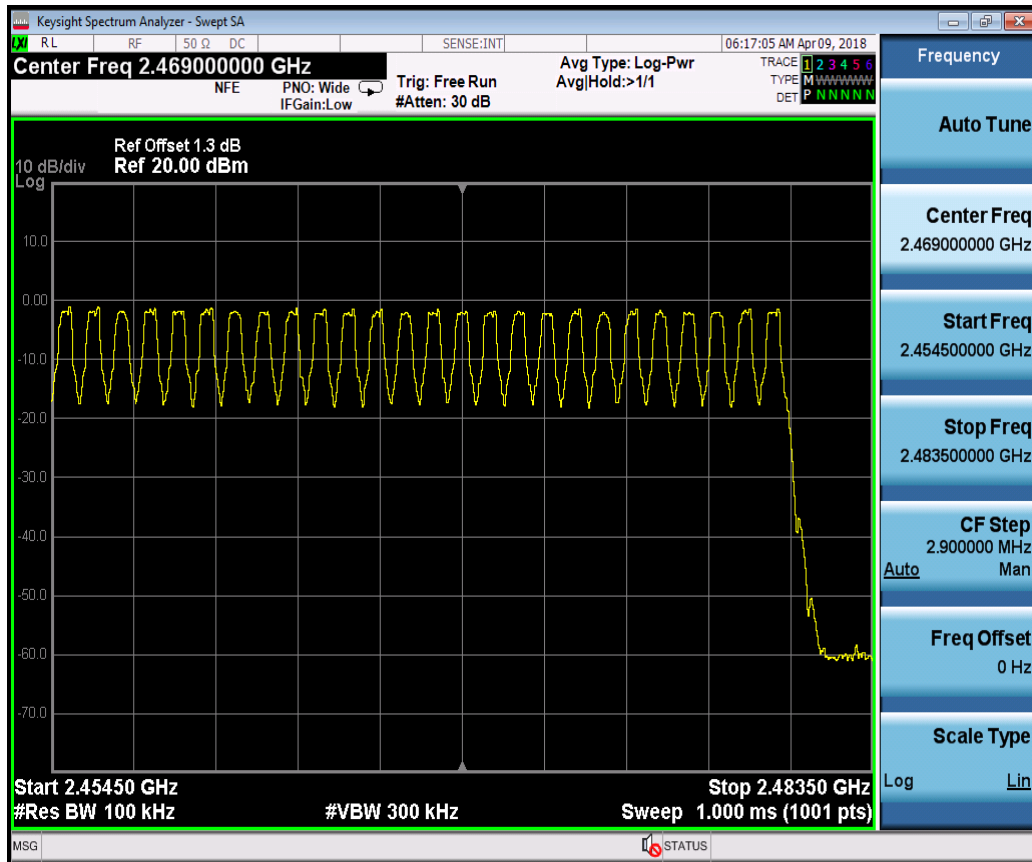
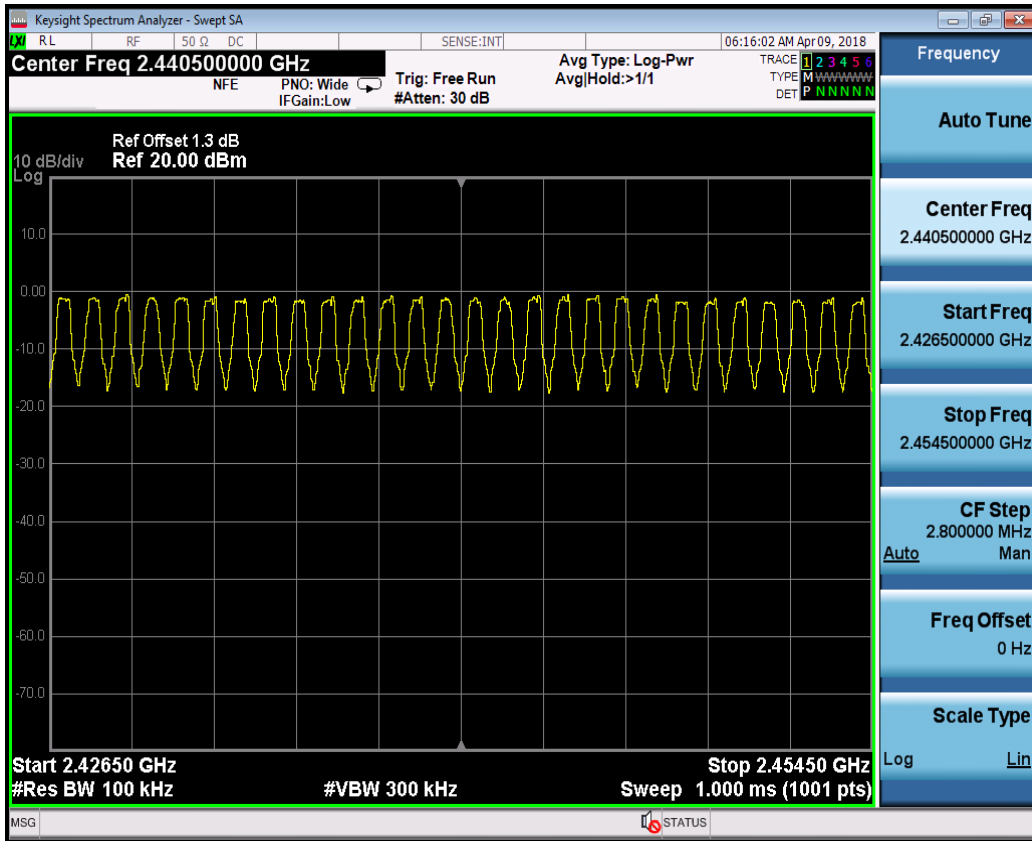

## 10 Dwell Time

Test result: Pass

### 10.1 Limit

The dwell time on any channel shall not be greater than 0.4 seconds within a period of 0.4 seconds multiplied by the number of hopping channels employed. Frequency hopping systems may avoid or suppress transmissions on a particular hopping frequency provided that a minimum of 15 channels are used.

### 10.2 Test Configuration

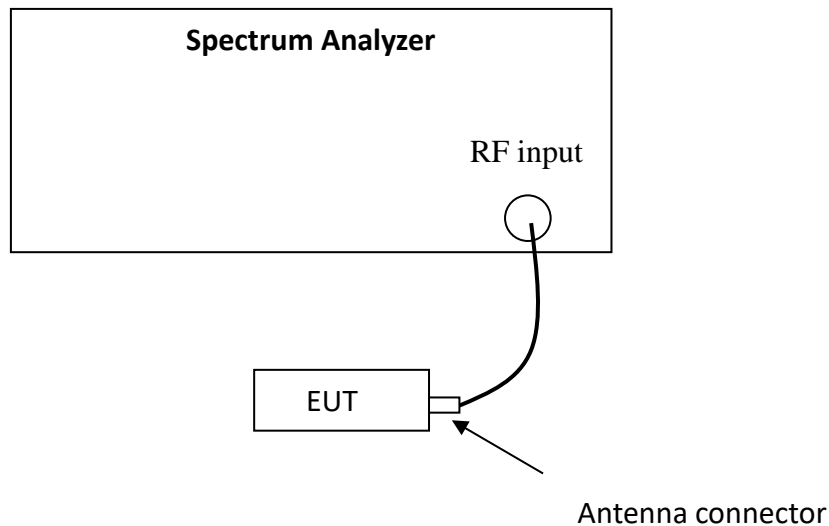

### 10.3 Test procedure and test setup

Dwell time per FCC §15.247(a)(1)(iii) is measured using the Spectrum Analyzer with Span = 0, RBW=1MHz, VBW≥RBW, Sweep can capture the entire dwell time, Detector = peak, Trace = max hold.

The EUT was tested according to DA 00-705 (Filing and Measurement Guidelines for Frequency Hopping Spread Spectrum Systems).

### 10.4 Test protocol

Temperature : 23 °C

Relative Humidity : 51 %

Packet	Occupancy time for single hop (ms) <b>O</b>	Real observed period (s) <b>P</b>	Hops among Observed period <b>I</b>	Dwell time (ms) <b>T</b>	Limit (s)
DH1	0.420	31.6	226	94.83	≤0.4
DH3	1.658	31.6	143	237.14	
DH5	2.887	31.6	100	288.71	

Remark: 1. There are 79 channels in all. So the complete observed period  $P = 0.4 * 79 = 31.6$  s.

DH1

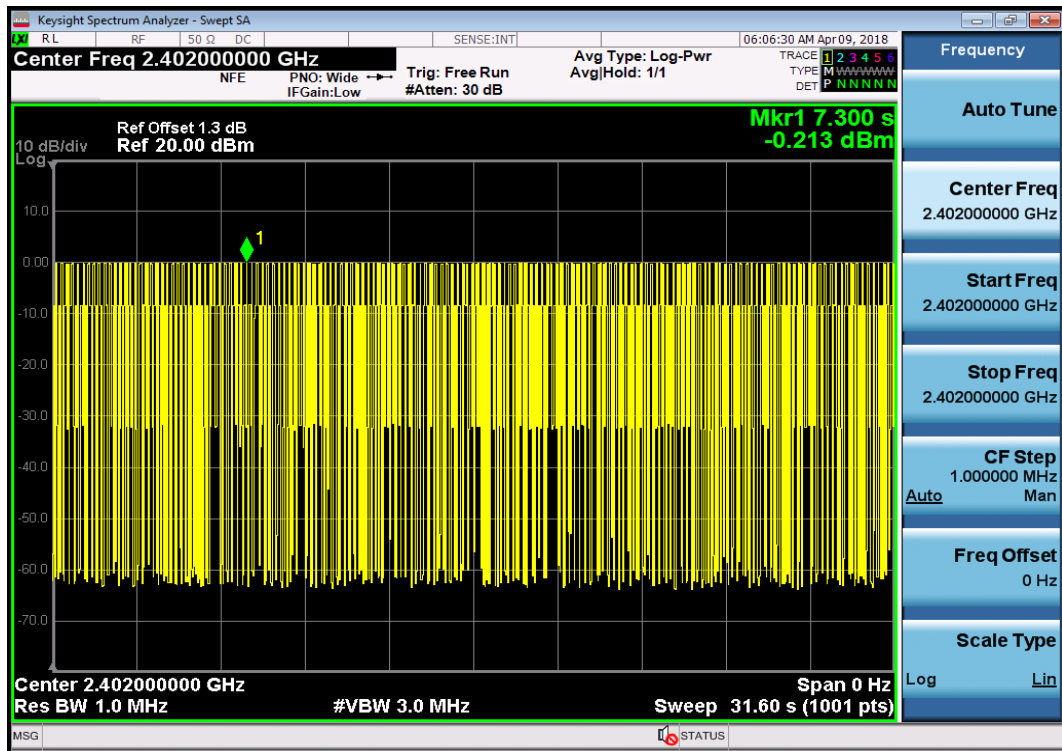
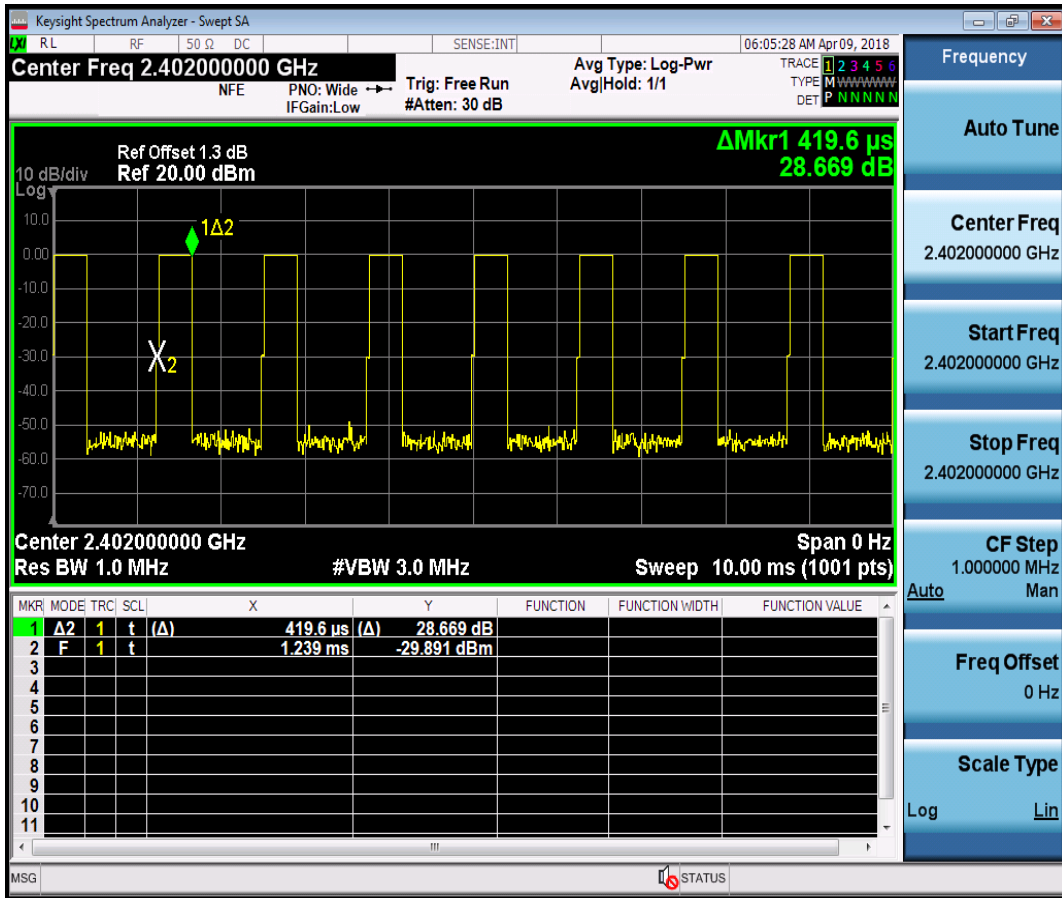



DH3

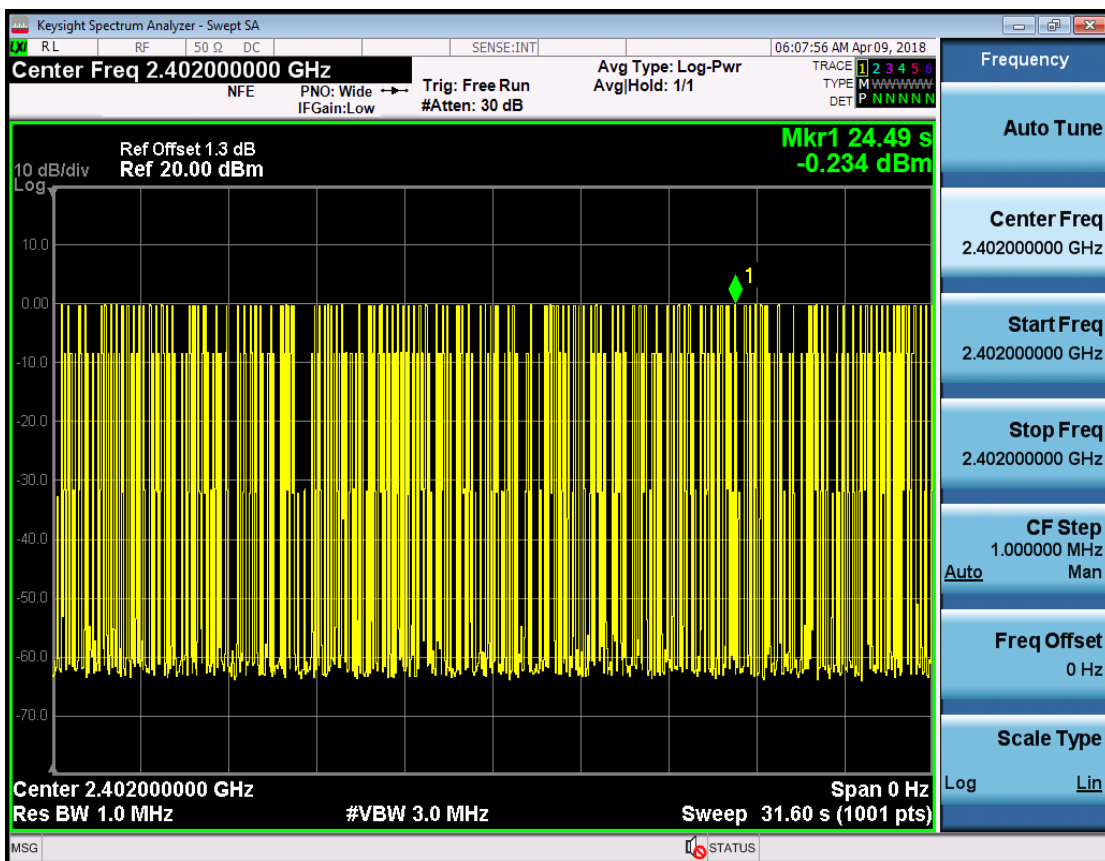
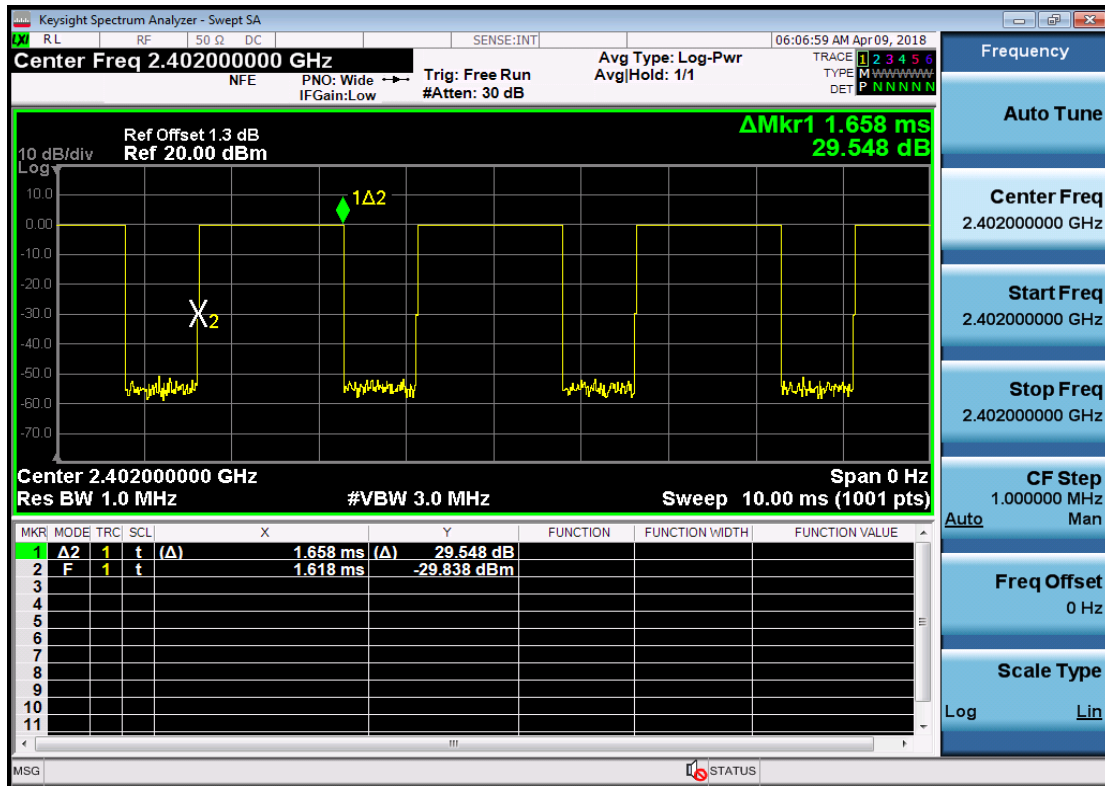

DH5

