



# FCC Part 15E Test Report

## FCC ID: Y2P-WR1200

Product Name:	WR1200
Trademark:	nEX
Model Name :	WR1200 Nex, nEX1200
Prepared For :	Phonex Broadband Corporation dba ReadyNet
Address :	6952 High Tech Drive, Suite B, Midvale, Utah 84047, United States
Prepared By :	Shenzhen BCTC Testing Co., Ltd.
Address :	BCTC Building & 1-2F, East of B Building, Pengzhou Industrial, Fuyuan 1st Road, Qiaotou Community, Fuyong Street, Bao'an District, Shenzhen, China
Test Date:	Sep. 25, 2019 – Oct. 24, 2019
Date of Report :	Oct. 24, 2019
Report No.:	BCTC-LH190901261-1E



### TEST RESULT CERTIFICATION

**Applicant's name** ..... : Phonex Broadband Corporation dba ReadyNet  
**Address** ..... : 6952 High Tech Drive, Suite B, Midvale, Utah 84047, United States  
**Manufacture's Name**..... : SHENZHEN MTN ELECTRONICS CO.,LTD  
**Address** ..... : MTN Industrial Park,No.9 South Futai Road, Pingxi  
 Community, Pingdi Street, Longgang District, Shenzhen  
 City, 518117, China

**Product description**

**Product name** ..... : WR1200  
**Trademark** ..... : nEX  
 Model and/or type reference : WR1200  
 nEX, nEX1200

**Standards** ..... : FCC Part15 15.407  
 ANSI C63.10-2013  
 KDB 662911 D01 v02r01  
 KDB 789033 D02 v02r01

This device described above has been tested by BCTC, and the test results show that the equipment under test (EUT) is in compliance with the FCC requirements. And it is applicable only to the tested sample identified in the report.

This report shall not be reproduced except in full, without the written approval of BCTC, this document may be altered or revised by BCTC, personal only, and shall be noted in the revision of the document.

Prepared by(Engineer): Willem Wang

*Willem Wang*

Reviewer(Supervisor): Eric Yang

*Eric Yang*

Approved(Manager): Zero Zhou





Table of Contents

	Page
<b>1 . SUMMARY OF TEST RESULTS</b>	<b>6</b>
1.1 TEST FACILITY	7
1.2 MEASUREMENT UNCERTAINTY	7
<b>2 . GENERAL INFORMATION</b>	<b>8</b>
<b>3 . EMC EMISSION TEST</b>	<b>14</b>
3.1 CONDUCTED EMISSION MEASUREMENT	14
3.1.1 POWER LINE CONDUCTED EMISSION LIMITS	14
3.1.2 TEST PROCEDURE	15
3.1.3 DEVIATION FROM TEST STANDARD	15
3.1.4 TEST SETUP	15
3.1.5 EUT OPERATING CONDITIONS	15
3.2 RADIATED EMISSION MEASUREMENT	18
3.2.1 APPLICABLE STANDARD	18
3.2.2 CONFORMANCE LIMIT	18
3.2.3 MEASURING INSTRUMENTS	18
3.2.4 TEST CONFIGURATION	19
3.2.5 TEST PROCEDURE	20
3.2.6 TEST RESULTS (9KHZ – 30 MHZ)	21
3.5 TEST RESULTS (30MHZ – 1GHZ)	22
3.2.8 TEST RESULTS (1GHZ-40GHZ)	24
<b>4 . POWER SPECTRAL DENSITY TEST</b>	<b>25</b>
4.1 APPLIED PROCEDURES / LIMIT	25
4.2 TEST PROCEDURE	25
4.3 DEVIATION FROM STANDARD	25
4.4 TEST SETUP	26
4.5 EUT OPERATION CONDITIONS	26
4.6 TEST RESULTS	27
<b>5 . 6DB &amp; 99% EMISSION BANDWIDTH</b>	<b>31</b>
5.1 APPLIED PROCEDURES / LIMIT	31
5.2 TEST PROCEDURE	31
5.3 EUT OPERATION CONDITIONS	32
5.4 TEST RESULTS	33
<b>6 . MAXIMUM CONDUCTED OUTPUT POWER</b>	<b>41</b>
6.1 PPLIED PROCEDURES / LIMIT	41
6.2 TEST PROCEDURE	41



Table of Contents

	Page
6.3 DEVIATION FROM STANDARD	43
6.4 TEST SETUP	43
6.5 EUT OPERATION CONDITIONS	43
6.6 TEST RESULTS	44
<b>7 . OUT OF BAND EMISSIONS</b>	<b>45</b>
7.1 APPLICABLE STANDARD	45
7.2 TEST PROCEDURE	45
7.3 DEVIATION FROM STANDARD	45
7.4 TEST SETUP	45
7.5 EUT OPERATION CONDITIONS	45
7.6 TEST RESULTS	46
<b>8.SPURIOUS RF CONDUCTED EMISSIONS</b>	<b>52</b>
8.1CONFORMANCE LIMIT	52
8.2MEASURING INSTRUMENTS	52
8.3TEST SETUP	52
8.4TEST PROCEDURE	52
8.5TEST RESULTS	52
<b>9. FREQUENCY STABILITY MEASUREMENT</b>	<b>60</b>
9.1 LIMIT	60
9.2 TEST PROCEDURES	60
9.3 TEST SETUP LAYOUT	60
9.4 EUT OPERATION DURING TEST	60
9.5 TEST RESULTS	61
<b>10. ANTENNA REQUIREMENT</b>	<b>64</b>
10.1 STANDARD REQUIREMENT	64
10.2 EUT ANTENNA	64
<b>11. EUT TEST PHOTO</b>	<b>65</b>
<b>12. EUT PHOTO</b>	<b>68</b>



**Revision History**

Report No.	Version	Description	Issued Date
BCTC-LH190901261-1E	Rev.01	Initial issue of report	Oct. 24, 2019



## 1. SUMMARY OF TEST RESULTS

Test procedures according to the technical standards:

FCC Part15 (15.407) , Subpart E			
Standard Section	Test Item	Judgment	Remark
15.209(a), 15.407 (b)(1) 15.407 (b)(4) 15.407 (b)(6)	Spurious Radiated Emissions	PASS	
15.207	Conducted Emission	PASS	
15.407 (a)(3) 15.1049	6 dB and 99% Emission Bandwidth	PASS	
15.407(e)	Minimum 6 dB bandwidth	PASS	
15.407 (a)(3)	Maximum Conducted Output Power	PASS	
2.1051, 15.407(b)(1) 15.407(b)(4)	Band Edge	PASS	
15.407 (a)(3)	Power Spectral Density	PASS	
2.1051, 15.407(b)	Spurious Emissions at Antenna Terminals	PASS	
15.203	Antenna Requirement	PASS	

NOTE:

(1) "N/A" denotes test is not applicable in this Test Report

Outsourcing: The 26G-40G Spurious Radiated Emissions in this test were outsourced to the Shenzhen Academy of Metrology & Quality Inspection



## 1.1 TEST FACILITY

Shenzhen BCTC Testing Co., Ltd.

Add. : BCTC Building & 1-2F, East of B Building, Pengzhou Industrial, Fuyuan 1st Road, Qiaotou Community, Fuyong Street, Bao'an District, Shenzhen, China

FCC Test Firm Registration Number: 712850

IC Registered No.: 23583

## 1.2 MEASUREMENT UNCERTAINTY

The reported uncertainty of measurement  $y \pm U$ , where expanded uncertainty  $U$  is based on a standard uncertainty multiplied by a coverage factor of  $k=2$ , providing a level of confidence of approximately 95 %.

No.	Item	Uncertainty
1	3m chamber Radiated spurious emission(30MHz-1GHz)	U=4.3dB
2	3m chamber Radiated spurious emission(1GHz-18GHz)	U=4.5dB
3	3m chamber Radiated spurious emission(18GHz-40GHz)	U=3.34dB
4	Conducted Adjacent channel power	U=1.38dB
5	Conducted output power uncertainty Above 1G	U=1.576dB
6	Conducted output power uncertainty below 1G	U=1.28dB
7	humidity uncertainty	U=5.3%
8	Temperature uncertainty	U=0.59 °C



2. GENERAL INFORMATION

2.1 GENERAL DESCRIPTION OF EUT

Equipment	WR1200	
Trade Name	nEX	
Model Name	WR1200 nEX, nEX1200	
Model Difference	All the model are the same circuit and RF module, except model names .	
Product Description	IEEE 802.11 WLAN Mode Supported	<input checked="" type="checkbox"/> 802.11a/n/ac(20MHz channel bandwidth) <input checked="" type="checkbox"/> 802.11n/ac(40MHz channel bandwidth) <input checked="" type="checkbox"/> 802.11ac(80MHz channel bandwidth)
	Data Rate	802.11a: 6,9,12,18,24,36,48,54Mbps; 802.11n(HT20/HT40):MCS0-MCS15; 802.11ac(VHT20): NSS1, MCS0-MCS8 802.11ac(VHT40/VHT80):NSS1, MCS0-MCS8
	Modulation	OFDM with BPSK/QPSK/16QAM/64QAM/256QAM for 802.11a/n/ac;
	Operating Frequency Range	<input type="checkbox"/> 5180-5240MHz for 802.11a/n(HT20)/ac20; 5190-5230MHz for 802.11n(HT40)/ac40; 5210MHz for 802.11 ac80; <input checked="" type="checkbox"/> 5745-5825 MHz for 802.11a/n(HT20)/ac20; 5755-5795 MHz for 802.11a/n(HT40)/ac40; 5775MHz for 802.11 ac80;
	Number of Channels	<input type="checkbox"/> 4 channels for 802.11a/n20/ac20 in the 5180-5240MHz band ; 2 channels for 802.11 n40/ac40 in the 5190-5230MHz band ; 1 channels for 802.11 ac80 in the 5210MHz band ; <input checked="" type="checkbox"/> 5 channels for 802.11a/n20/ac20 in the 5745-5825MHz band ; 2 channels for 802.11 n40/ac40 in the 5755-5795MHz band ; 1 channels for 802.11 ac80 in the 5775MHz band ;
Channel List	Please refer to the Note 2.	
Power	Model: RD1202000-C55-80GB Input: 100-240V~50/60Hz 1.0A MAX. Output: 12V 2.0A	
hardware version	N/A	
Software version	N/A	
Connecting I/O Port(s)	Please refer to the User's Manual	





Note:

1. For a more detailed features description, please refer to the manufacturer's specifications or the User's Manual.
2. Frequency and Channel list for 802.11a/n/ac(20 MHz) band IV (5745-5825MHz):

802.11a/n/ac( 20 MHz) Carrier Frequency Channel							
Channel	Frequency (MHz)	Channel	Frequency (MHz)	Channel	Frequency (MHz)	Channel	Frequency (MHz)
149	5745	153	5765	157	5785	161	5805
165	5825	-	-	-	-	-	-

802.11n/ac 40MHz Carrier Frequency Channel					
Channel	Frequency (MHz)	Channel	Frequency (MHz)	Channel	Frequency (MHz)
151	5755	159	5795	-	-

802.11ac 80MHz Carrier Frequency Channel	
Channel	Frequency (MHz)
155	5775

Tx Antenna

Ant.	Brand	Model Name	Antenna Type	Gain (dBi)	NOTE
A	N/A	N/A	External antenna	5	
B	N/A	N/A	External antenna	5	



**2.2 DESCRIPTION OF TEST MODES**

Pretest Mode	Description
Mode 1	802.11a /n/ ac 20 CH149/ CH157/ CH 165
Mode 2	802.11n/ ac40 CH 151 / CH 159
Mode 3	802.11 ac80 CH 42/CH 155
Mode 4	802.11a /n/ ac 20 CH149/ CH157/ CH 165
Mode 5	Link Mode

<b>Conducted Emission</b>	
Final Test Mode	Description
Mode 5	Link Mode

<b>For Radiated Emission</b>	
Final Test Mode	Description
Mode 1	802.11a /n/ ac 20 CH149/ CH157/ CH 165
Mode 2	802.11n/ ac40 CH 151 / CH 159
Mode 3	802.11 ac80 CH 42/CH 155
Mode 4	802.11a /n/ ac 20 CH149/ CH157/ CH 165

Note:

(1) The measurements are performed at all Bit Rate of Transmitter, the worst data was reported.



### 2.3 BLOCK DIGRAM SHOWING THE CONFIGURATION OF SYSTEM TESTED

Conducted Emission Test

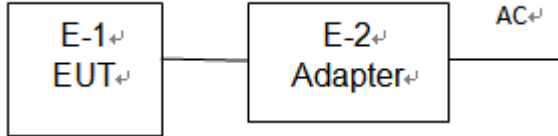

Radiated Spurious Emission

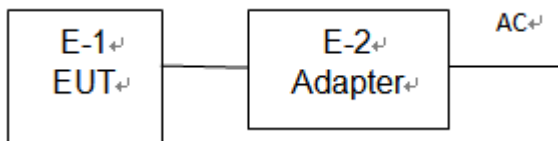

### 2.4 DESCRIPTION OF SUPPORT UNITS(CONDUCTED MODE)

The EUT has been tested as an independent unit together with other necessary accessories or support units. The following support units or accessories were used to form a representative test configuration during the tests.

Item	Equipment	Mfr/Brand	Model/Type No.	Series No.	Note
E-1	WR1200	nEX	WR1200	N/A	EUT
E-2	Adapter	N/A	RD1202000-C55-80GB	N/A	EUT

Item	Shielded Type	Ferrite Core	Length	Note
C-1	NO	NO	1.5M	DC cableunshielded

Note:

- (1) The support equipment was authorized by Declaration of Confirmation.
- (2) For detachable type I/O cable should be specified the length in cm in 『Length』 column.



**2.5 EQUIPMENTS LIST FOR ALL TEST ITEMS**

Radiation Test equipment

Item	Equipment	Manufacturer	Type No.	Serial No.	Last calibration	Calibrated until
1	Spectrum Analyzer (9kHz-26.5GHz)	Agilent	E4407B	MY45109572	Jun. 13, 2019	Jun. 12, 2020
2	Test Receiver (9kHz-7GHz)	R&S	ESR7	101154	Jun. 13, 2019	Jun. 12, 2020
3	Bilog Antenna (30MHz-3GHz)	SCHWARZBECK	VULB9163	VULB9163-942	Jun. 22, 2019	Jun. 21, 2020
4	Horn Antenna (1GHz-18GHz)	SCHWARZBECK	BBHA9120D	1541	Jun. 22, 2019	Jun. 21, 2020
5	Horn Antenna (18GHz-40GHz)	SCHWARZBECK	BBHA9170	822	Jun. 22, 2019	Jun. 21, 2020
6	Amplifier (9KHz-6GHz)	SCHWARZBECK	BBV9744	9744-0037	Jun. 25, 2019	Jun. 24, 2020
7	Amplifier (0.5GHz-18GHz)	SCHWARZBECK	BBV9718	9718-309	Jun. 25, 2019	Jun. 24, 2020
8	Amplifier (18GHz-40GHz)	MITEQ	TTA1840-35-HG	2034381	Jun. 17, 2019	Jun. 16, 2020
9	Loop Antenna (9KHz-30MHz)	SCHWARZBECK	FMZB1519B	014	Jul. 02, 2019	Jul. 01, 2020
10	RF cables1 (9kHz-30MHz)	Huber+Suhnar	9kHz-30MHz	B1702988-0008	Jun. 25, 2019	Jun. 24, 2020
11	RF cables2 (30MHz-1GHz)	Huber+Suhnar	30MHz-1GHz	1486150	Jun. 25, 2019	Jun. 24, 2020
12	RF cables3 (1GHz-40GHz)	Huber+Suhnar	1GHz-40GHz	1607106	Jun. 25, 2019	Jun. 24, 2020
13	Power Metter	Keysight	E4419	\	Jun. 17, 2019	Jun. 16, 2020
14	Power Sensor (AV)	Keysight	E9 300A	\	Jun. 17, 2019	Jun. 16, 2020
15	Signal Analyzer 20kHz-26.5GHz	KEYSIGHT	N9020A	MY49100060	Jun. 13, 2019	Jun. 12, 2020
16	Spectrum Analyzer 9kHz-40GHz	Aglient	FSP40	100363	Jun. 13, 2019	Jun. 12, 2020
17	D.C. Power Supply	LongWei	TPR-6405D	\	\	\
18	Software	Frad	EZ-EMC	FA-03A2 RE	\	\



Conduction Test equipment

Item	Equipment	Manufacturer	Type No.	Serial No.	Last calibration	Calibrated until
1	Test Receiver	R&S	ESR3	102075	Jun. 13, 2019	Jun. 12, 2020
2	LISN	SCHWARZBEC K	NSLK8127	8127739	Jun. 13, 2019	Jun. 12, 2020
3	LISN	R&S	ENV216	101375	Jun. 13, 2019	Jun. 12, 2020
4	RF cables	Huber+Suhnar	9kHz-30MHz	B1702988-00 08	Jun. 25, 2019	Jun. 24, 2020
5	Software	Frad	EZ-EMC	EMC-CON 3A1	\	\



### 3. EMC EMISSION TEST

#### 3.1 CONDUCTED EMISSION MEASUREMENT

##### 3.1.1 POWER LINE CONDUCTED EMISSION Limits (Frequency Range 150KHz-30MHz)

FREQUENCY (MHz)	Class B (dBuV)		Standard
	Quasi-peak	Average	
0.15 -0.5	66 - 56 *	56 - 46 *	CISPR
0.50 -5.0	56.00	46.00	CISPR
5.0 -30.0	60.00	50.00	CISPR

0.15 -0.5	66 - 56 *	56 - 46 *	FCC/ RSS-247
0.50 -5.0	56.00	46.00	FCC/ RSS-247
5.0 -30.0	60.00	50.00	FCC/ RSS-247

Note:

- (1) The tighter limit applies at the band edges.
- (2) The limit of " \* " marked band means the limitation decreases linearly with the logarithm of the frequency in the range.

The following table is the setting of the receiver

Receiver Parameters	Setting
Attenuation	10 dB
Start Frequency	0.15 MHz
Stop Frequency	30 MHz
IF Bandwidth	9 kHz

### 3.1.2 TEST PROCEDURE

- a. The EUT was placed 0.8 meters from the horizontal ground plane with EUT being connected to the power mains through a line impedance stabilization network (LISN). All other support equipments powered from additional LISN(s). The LISN provide 50 Ohm/ 50uH of coupling impedance for the measuring instrument.
- b. Interconnecting cables that hang closer than 40 cm to the ground plane shall be folded back and forth in the center forming a bundle 30 to 40 cm long.
- c. I/O cables that are not connected to a peripheral shall be bundled in the center. The end of the cable may be terminated, if required, using the correct terminating impedance. The overall length shall not exceed 1 m.
- d. LISN at least 80 cm from nearest part of EUT chassis.
- e. For the actual test configuration, please refer to the related Item –EUT Test Photos.

### 3.1.3 DEVIATION FROM TEST STANDARD

No deviation

### 3.1.4 TEST SETUP

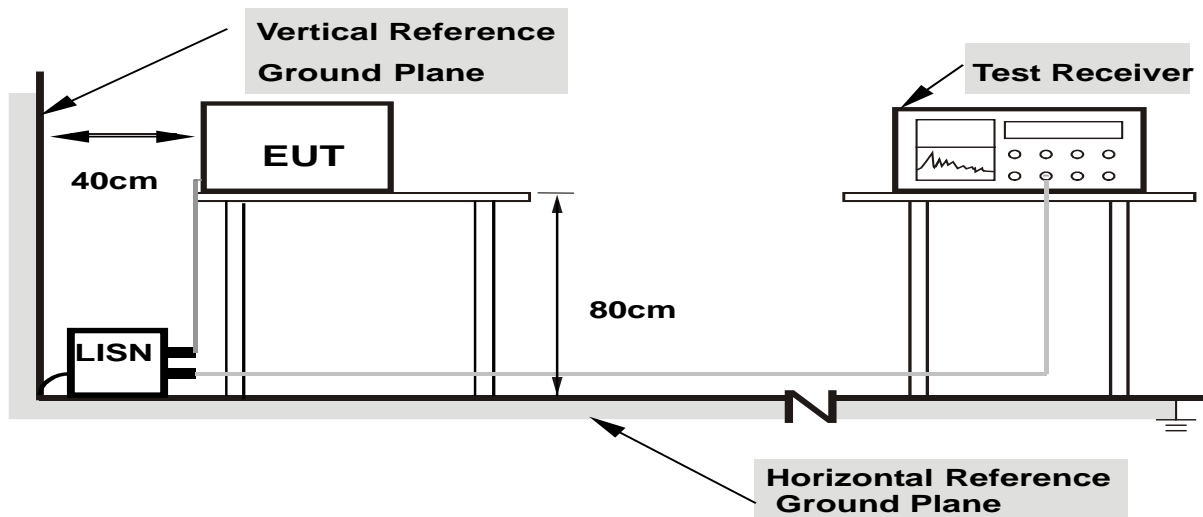

**Note: 1.Support units were connected to second LISN.**

**2.Both of LISNs (AMN) are 80 cm from EUT and at least 80 from other units and other metal planes**

### 3.1.5 EUT OPERATING CONDITIONS

The EUT was configured for testing in a typical fashion (as a customer would normally use it). The EUT has been programmed to continuously transmit during test. This operating condition was tested and used to collect the included data.

We pretest AC 120V and AC 240V, the worst voltage was AC 120V and the data recording in the report.



Temperature :	26 °C	Relative Humidity :	54%
Pressure :	101kPa	Phase :	L
Test Voltage :	AC120V 60Hz	Test Mode :	Mode 5

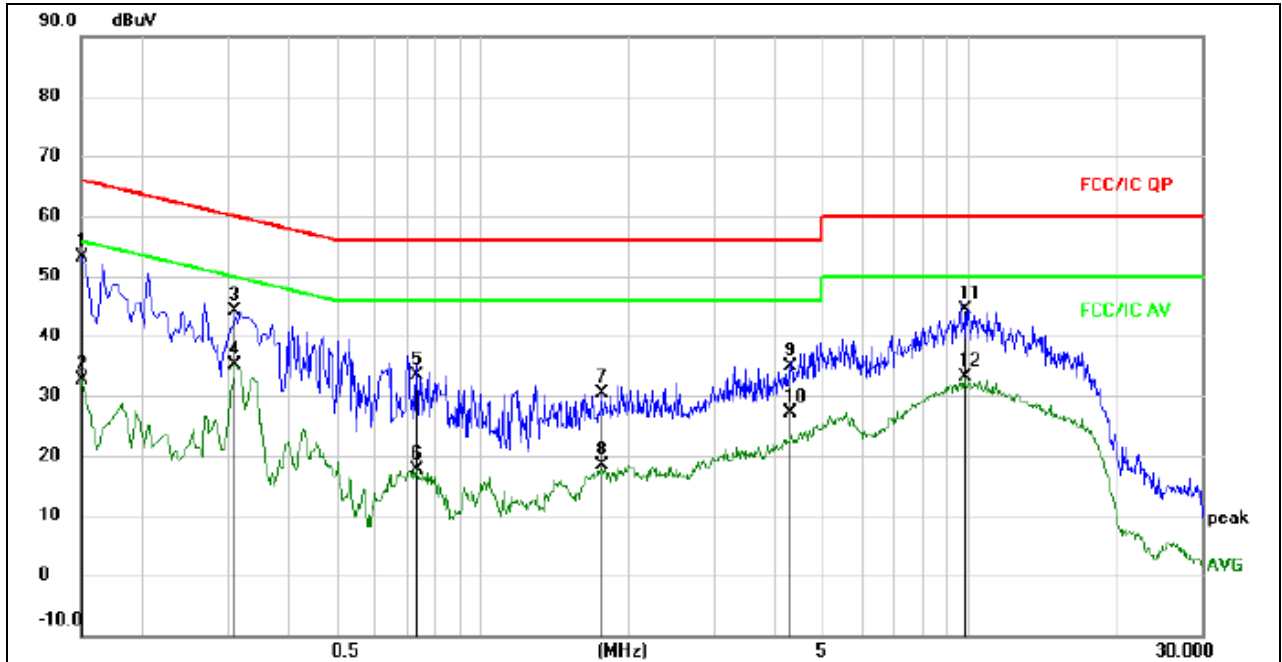

Remark:

1. All readings are Quasi-Peak and Average values.
2. Factor = Insertion Loss + Cable Loss.

No.	Mk.	Freq. MHz	Reading Level dBuV	Correct Factor	Measure- ment dBuV	Limit dBuV	Over dB	Detector	Comment
1	*	0.1500	43.57	9.52	53.09	66.00	-12.91	QP	
2		0.1500	23.22	9.52	32.74	56.00	-23.26	AVG	
3		0.3100	34.60	9.57	44.17	59.97	-15.80	QP	
4		0.3100	25.68	9.57	35.25	49.97	-14.72	AVG	
5		0.7340	23.79	9.64	33.43	56.00	-22.57	QP	
6		0.7340	7.93	9.64	17.57	46.00	-28.43	AVG	
7		1.7580	20.68	9.59	30.27	56.00	-25.73	QP	
8		1.7580	8.67	9.59	18.26	46.00	-27.74	AVG	
9		4.2900	25.23	9.75	34.98	56.00	-21.02	QP	
10		4.2900	17.27	9.75	27.02	46.00	-18.98	AVG	
11		9.7660	34.80	9.69	44.49	60.00	-15.51	QP	
12		9.7660	23.34	9.69	33.03	50.00	-16.97	AVG	





Temperature :	26 °C	Relative Humidity :	54%
Pressure :	101kPa	Phase :	N
Test Voltage :	AC120V 60Hz	Test Mode :	Mode 5

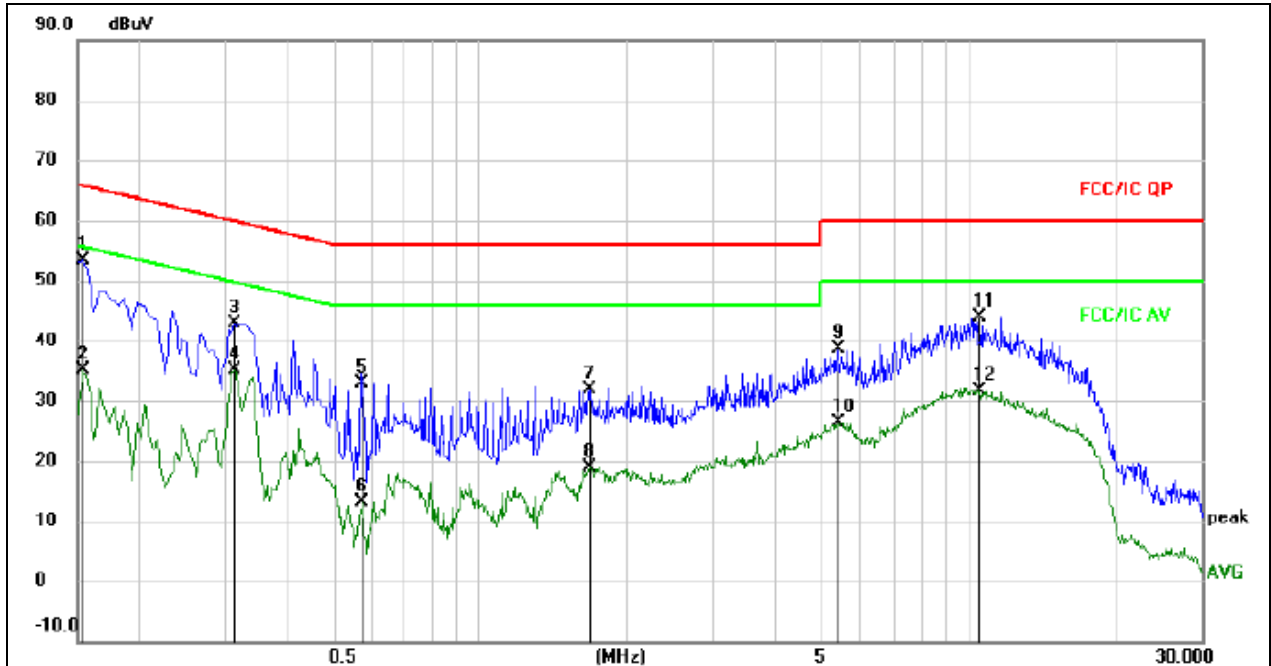

Remark:

1. All readings are Quasi-Peak and Average values.
2. Factor = Insertion Loss + Cable Loss.

No.	Mk.	Freq. MHz	Reading Level dBuV	Correct Factor	Measure- ment dBuV	Limit dBuV	Over dB	Detector	Comment
1	*	0.1539	43.81	9.52	53.33	65.79	-12.46	QP	
2		0.1539	25.72	9.52	35.24	55.79	-20.55	AVG	
3		0.3140	33.39	9.57	42.96	59.86	-16.90	QP	
4		0.3140	25.59	9.57	35.16	49.86	-14.70	AVG	
5		0.5740	22.95	9.89	32.84	56.00	-23.16	QP	
6		0.5740	3.19	9.89	13.08	46.00	-32.92	AVG	
7		1.6740	22.22	9.58	31.80	56.00	-24.20	QP	
8		1.6740	9.30	9.58	18.88	46.00	-27.12	AVG	
9		5.4100	28.78	9.78	38.56	60.00	-21.44	QP	
10		5.4100	16.63	9.78	26.41	50.00	-23.59	AVG	
11		10.5180	34.14	9.69	43.83	60.00	-16.17	QP	
12		10.5180	21.93	9.69	31.62	50.00	-18.38	AVG	



### 3.2 RADIATED EMISSION MEASUREMENT

#### 3.2.1 APPLICABLE STANDARD

According to FCC Part 15.407(d) and 15.209

#### 3.2.2 CONFORMANCE LIMIT

According to FCC Part 15.407(b)(7): radiated emissions which fall in the restricted bands, as defined in §15.205(a), must also comply with the radiated emission limits specified in §15.209(a) (see §15.205(c)).

According to FCC Part 15.205, Restricted bands

MHz	MHz	MHz	GHz
0.090-0.110	16.42-16.423	399.9-410	4.5-5.15
10.495-0.505	16.69475-16.69525	608-614	5.35-5.46
2.1735-2.1905	16.80425-16.80475	960-1240	7.25-7.75
4.125-4.128	25.5-25.67	1300-1427	8.025-8.5
4.17725-4.17775	37.5-38.25	1435-1626.5	9.0-9.2
4.20725-4.20775	73-74.6	1645.5-1646.5	9.3-9.5
6.215-6.218	74.8-75.2	1660-1710	10.6-15
6.26775-6.26825	123-138	2200-2300	14.47-14.5
8.291-8.294	149.9-150.05	2310-2390	15.35-16.2
8.362-8.366	156.52475-156.52525	2483.5-2500	17.7-21.4
8.37625-8.38675	156.7-156.9	2690-2900	22.01-23.12
8.41425-8.41475	162.0125-167.17	3260-3267	23.6-24.0
12.29-12.293	167.72-173.2	3332-3339	31.2-31.8
12.51975-12.52025	240-285	3345.8-3358	36.43-36.5
12.57675-12.57725	322-335.4	3600-4400	(2)
13.36-13.41			

20dBc in any 100 kHz bandwidth outside the operating frequency band. In case the emission fall within the restricted band specified on 15.205(a), then the 15.209(a) limit in the table below has to be followed.

Restricted Frequency(MHz)	Field Strength (µV/m)	Field Strength (dBµV/m)	Measurement Distance
0.009~0.490	2400/F(KHz)	20 log (uV/m)	300
0.490~1.705	2400/F(KHz)	20 log (uV/m)	30
1.705~30.0	30	29.5	30
30-88	100	40	3
88-216	150	43.5	3
216-960	200	46	3
Above 960	500	54	3

Limits of Radiated Emission Measurement(Above 1000MHz)

Frequency(MHz)	Class B (dBuV/m) (at 3M)	
	PEAK	AVERAGE
Above 1000	74	54

Remark :1. Emission level in dBuV/m=20 log (uV/m)

2. Measurement was performed at an antenna to the closed point of EUT distance of meters.

3. Distance extrapolation factor =40log(Specific distance/ test distance)( dB);

Limit line=Specific limits(dBuV) + distance extrapolation factor.

#### 3.2.3 MEASURING INSTRUMENTS

The Measuring equipment is listed in the section 6.3 of this test report.

### 3.2.4 TEST CONFIGURATION

(a) For radiated emissions below 30MHz

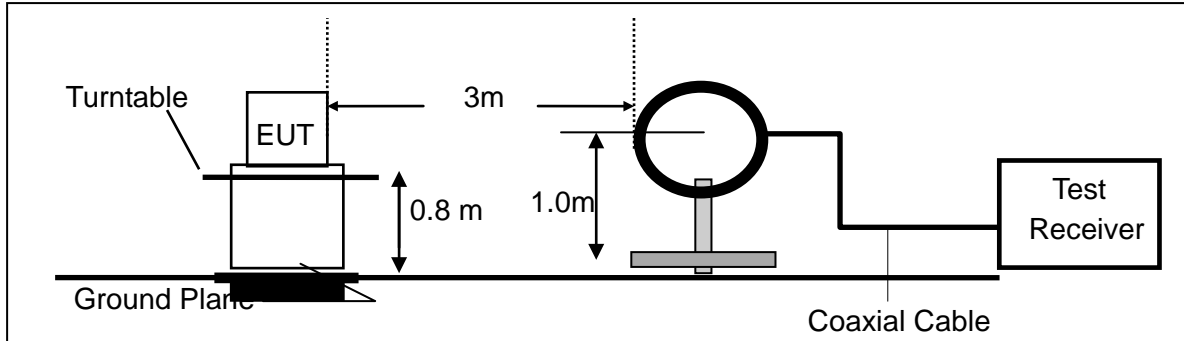

(b) For radiated emissions from 30MHz to 1000MHz

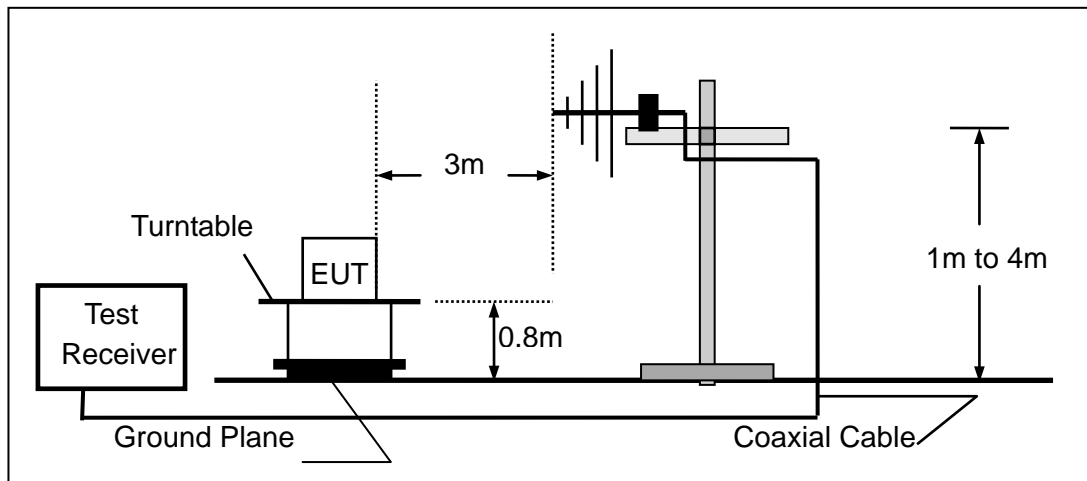

(c) For radiated emissions above 1000MHz

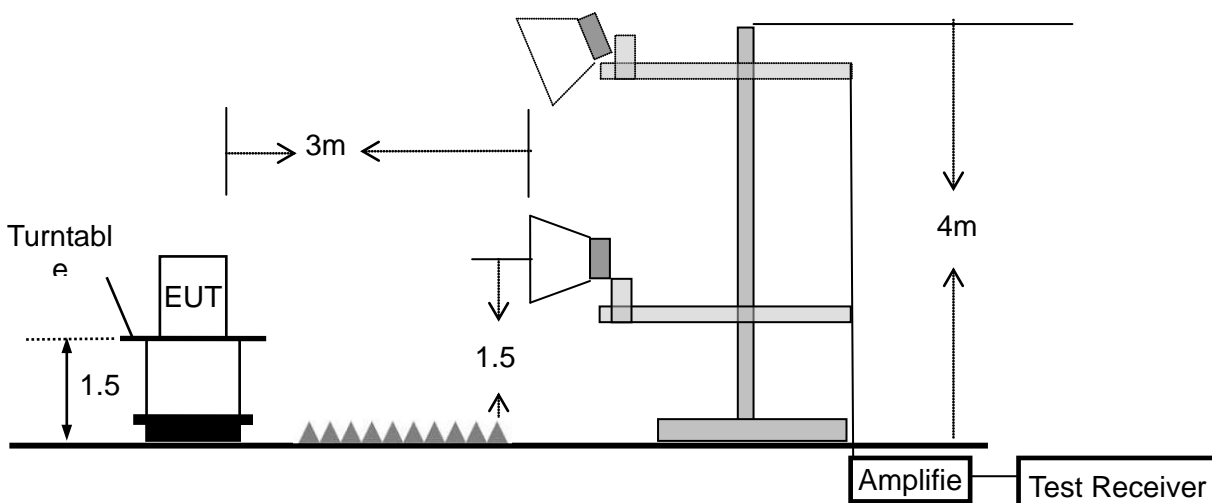



**3.2.5 TEST PROCEDURE**

The test site semi-anechoic chamber has met the requirement of NSA tolerance 4 dB according to the standards: ANSI C63.10-2013. The test distance is 3m. The setup is according to the requirements in Section 13.1.4.1 of ANSI C63.10-2013 and CAN/CSA-CEI/IEC CISPR 22.

This test is required for any spurious emission that falls in a Restricted Band, as defined in Section 15.205. It must be performed with the highest gain of each type of antenna proposed for use with the EUT.

Use the following spectrum analyzer settings:

Spectrum Parameter	Setting
Attenuation	Auto
Start Frequency	1000 MHz
Stop Frequency	10th carrier harmonic
RB / VB (emission in restricted band)	1 MHz / 1 MHz for Peak, 1 MHz / 10Hz for Average

Receiver Parameter	Setting
Attenuation	Auto
Start ~ Stop Frequency	9kHz~150kHz / RB 200Hz for QP
Start ~ Stop Frequency	150kHz~30MHz / RB 9kHz for QP
Start ~ Stop Frequency	30MHz~1000MHz / RB 120kHz for QP

- The measuring distance of at 3 m shall be used for measurements at frequency up to 1GHz. For frequencies above 1GHz, any suitable measuring distance may be used.
- The EUT was placed on the top of a rotating table 0.8 m for below 1GHz and 1.5m for above 1GHz the ground at a 3 meter. The table was rotated 360 degrees to determine the position of the highest radiation.
- The height of the equipment or of the substitution antenna shall be 0.8 m for below 1GHz and 1.5m for above 1GHz; the height of the test antenna shall vary between 1 m to 4 m. Both horizontal and vertical polarizations of the antenna are set to make the measurement.
- The initial step in collecting conducted emission data is a spectrum analyzer peak detector mode pre-scanning the measurement frequency range. Significant peaks are then marked and then Quasi Peak detector mode re-measured.
- If the Peak Mode measured value compliance with and lower than Quasi Peak Mode Limit, the EUT shall be deemed to meet QP Limits and then no additional QP Mode measurement performed.
- For the actual test configuration, please refer to the related Item –EUT Test Photos.

Note:

Both horizontal and vertical antenna polarities were tested and performed pretest to three orthogonal axis. The worst case emissions were reported

During the radiated emission test, the Spectrum Analyzer was set with the following configurations:

Frequency Band (MHz)	Function	Resolution bandwidth	Video Bandwidth
30 to 1000	QP	120 kHz	300 kHz
Above 1000	Peak	1 MHz	1 MHz
	Average	1 MHz	10 Hz

Note: for the frequency ranges below 30 MHz, a narrower RBW is used for these ranges but the measured value should add a RBW correction factor (RBWCF) where  $RBWCF [dB] = 10 \cdot \lg(100 [kHz]/\text{narrower RBW [kHz]})$ . , the narrower RBW is 1 kHz and RBWCF is 20 dB for the frequency 9 kHz to 150 kHz, and the narrower RBW is 10 kHz and RBWCF is 10 dB for the frequency 150 kHz to 30 MHz.



3.2.6 TEST RESULTS (9KHZ – 30 MHZ)

Temperature:	26°C	Relative Humidity:	54%
Pressure:	101kPa	Test Voltage :	AC 120V/60Hz
Test Mode :	Mode 5	Polarization :	--

Freq.	Reading	Limit	Margin	State
(MHz)	(dBuV/m)	(dBuV/m)	(dB)	P/F
--	--	--	--	N/A
--	--	--	--	N/A

**NOTE:**

The amplitude of spurious emissions which are attenuated by more than 20dB below the permissible value has no need to be reported.

Distance extrapolation factor =  $40 \log(\text{specific distance}/\text{test distance})$ (dB);

Limit line = specific limits(dBuv) + distance extrapolation factor.



**3.5 TEST RESULTS (30MHZ – 1GHZ)**

Temperature :	26°C	Relative Humidity :	54%
Pressure :	101 kPa	Polarization :	Horizontal
Test Voltage :	AC 120V/60Hz		
Test Mode :	Mode 5		

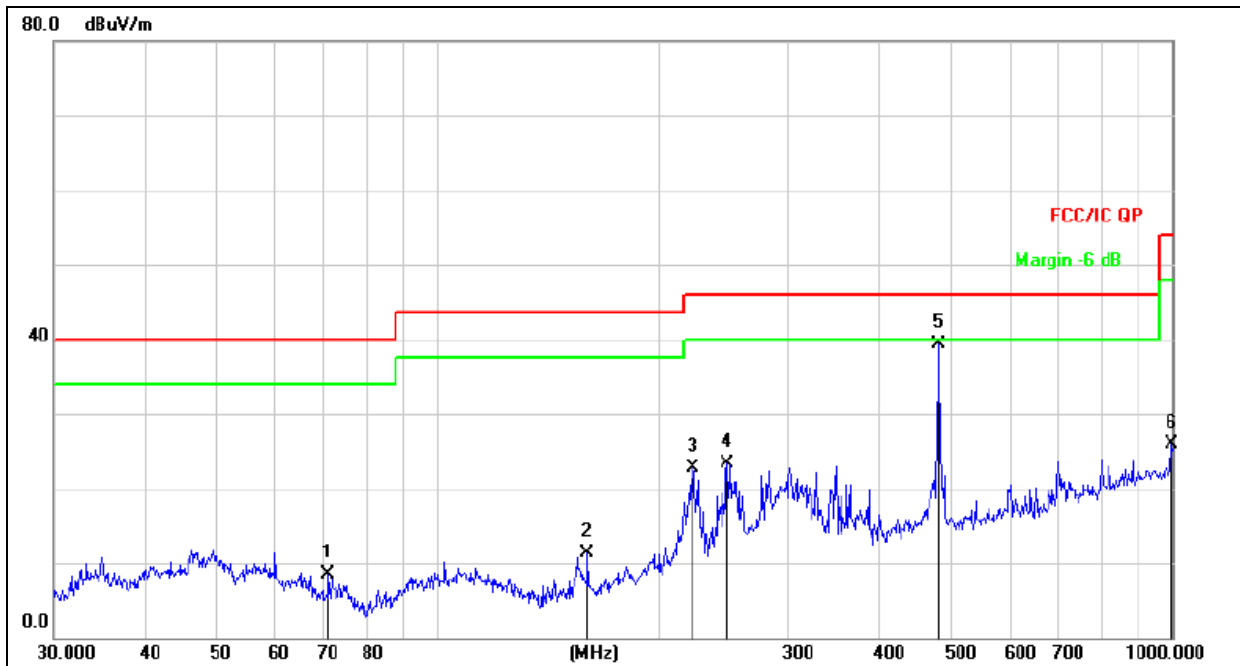

Remark:  
Factor = Antenna Factor + Cable Loss – Pre-amplifier.

No.	Mk.	Freq. MHz	Reading Level dBuV	Correct Factor dB	Measure- ment dBuV/m	Limit dB/m	Over dB	Detector
1		70.8315	26.97	-18.37	8.60	40.00	-31.40	QP
2		159.7844	30.21	-18.87	11.34	43.50	-32.16	QP
3		222.1698	38.49	-15.79	22.70	46.00	-23.30	QP
4		247.6819	38.42	-15.20	23.22	46.00	-22.78	QP
5	*	480.5276	48.56	-9.34	39.22	46.00	-6.78	QP
6		996.4996	26.74	-0.83	25.91	54.00	-28.09	QP



Temperature :	26℃	Relative Humidity :	54%
Pressure :	101kPa	Polarization :	Vertical
Test Voltage :	AC 120V/60Hz		
Test Mode :	Mode 5		

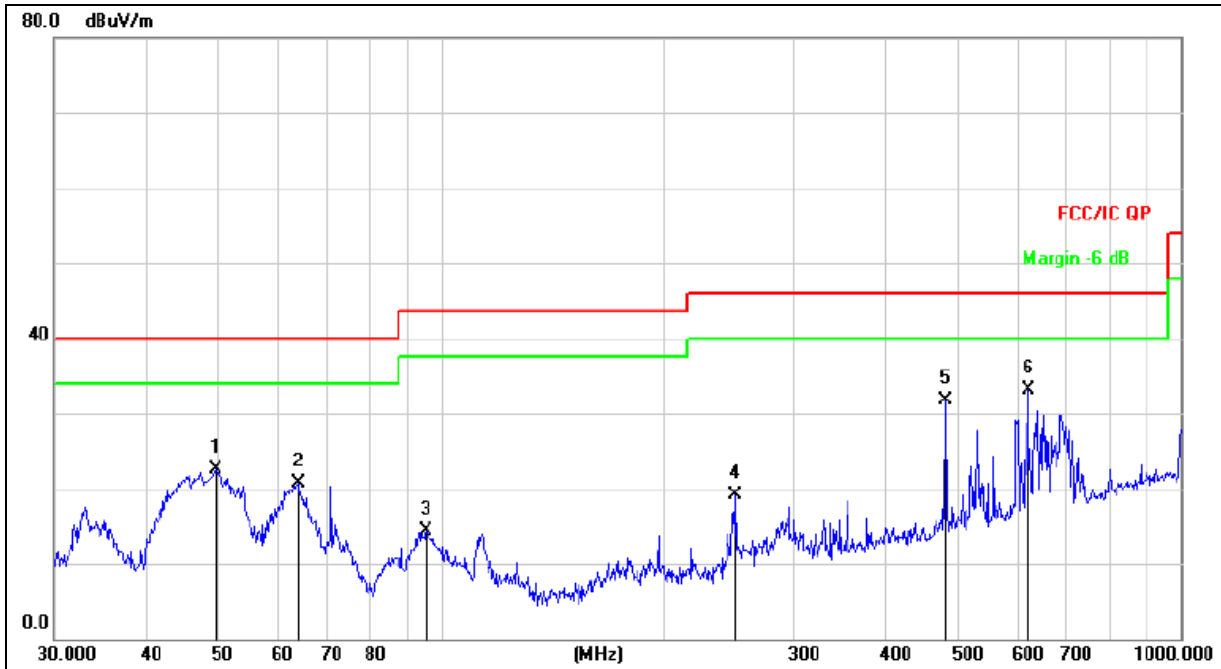

Remark:  
Factor = Antenna Factor + Cable Loss – Pre-amplifier.

No.	Mk.	Freq. MHz	Reading Level dBuV	Correct Factor dB	Measure- ment dBuV/m	Limit dB/m	Over dB	Detector
1		49.5328	37.38	-14.88	22.50	40.00	-17.50	QP
2		63.9828	37.55	-16.82	20.73	40.00	-19.27	QP
3		95.4270	31.32	-17.11	14.21	43.50	-29.29	QP
4		250.3012	34.16	-15.14	19.02	46.00	-26.98	QP
5		480.5276	41.04	-9.34	31.70	46.00	-14.30	QP
6	*	620.7096	39.68	-6.64	33.04	46.00	-12.96	QP



**3.2.8 TEST RESULTS (1GHz-40GHz)**

Test Mode :	TX (5.8G) -- 802.11a
-------------	----------------------

Polar	Frequency	Meter Reading	Cable loss	Antenna Factor	Preamp Factor	Emission Level	Limits	Margin	Detector Type
(H/V)	(MHz)	(dBuV)	(dB)	dB/m	(dB)	(dBuV/m)	(dBuV/m)	(dB)	
Low Channel (5745 MHz)-Above 1G									
Vertical	4679.195	59.96	5.94	35.40	44.00	57.3	74.00	-16.7	Pk
Vertical	4679.195	39.62	5.94	35.40	44.00	36.96	54.00	-17.04	AV
Vertical	11490.364	59.58	8.46	39.75	44.50	63.29	74.00	-10.71	Pk
Vertical	11490.364	42.23	8.46	39.75	44.50	45.94	54.00	-8.06	AV
Vertical	17235.101	55.64	10.12	38.80	44.10	60.46	74.00	-13.54	Pk
Vertical	17235.101	38.37	10.12	38.80	42.70	44.59	54.00	-9.41	AV
Horizontal	4679.332	57.94	5.94	35.18	44.00	55.06	74.00	-18.94	Pk
Horizontal	4679.332	44.53	5.94	35.18	44.00	41.65	54.00	-12.35	AV
Horizontal	11490.164	56.83	8.46	38.71	44.50	59.5	74.00	-14.5	Pk
Horizontal	11490.164	40.33	8.46	38.71	44.50	43	54.00	-11	AV
Horizontal	17235.196	58.67	10.12	38.38	44.10	63.07	74.00	-10.93	Pk
Horizontal	17235.196	42.46	10.12	38.38	44.10	46.86	54.00	-7.14	AV
middle Channel (5785 MHz)-Above 1G									
Vertical	4592.228	59.88	6.48	36.35	44.05	58.66	74.00	-15.34	Pk
Vertical	4592.228	43.26	6.48	36.35	44.05	42.04	54.00	-11.96	AV
Vertical	11570.203	61.47	8.47	37.88	44.51	63.31	74.00	-10.69	Pk
Vertical	11570.203	43.29	8.47	37.88	44.51	45.13	54.00	-8.87	AV
Vertical	17355.147	59.52	10.12	38.8	44.10	64.34	74.00	-9.66	Pk
Vertical	17355.147	42.42	10.12	38.8	42.70	48.64	54.00	-5.36	AV
Horizontal	4592.526	58.63	6.48	36.37	44.05	57.43	74.00	-16.57	Pk
Horizontal	4592.526	43.18	6.48	36.37	44.05	41.98	54.00	-12.02	AV
Horizontal	11570.123	60.22	8.47	38.64	44.50	62.83	74.00	-11.17	Pk
Horizontal	11570.123	42.51	8.47	38.64	44.50	45.12	54.00	-8.88	AV
Horizontal	17355.269	57.27	10.12	38.38	44.10	61.67	74.00	-12.33	Pk
Horizontal	17355.269	42.22	10.12	38.38	44.10	46.62	54.00	-7.38	AV
High Channel (5825 MHz)-Above 1G									
Vertical	6039.199	57.43	7.10	37.24	43.50	58.27	74.00	-15.73	Pk
Vertical	6039.199	42.22	7.10	37.24	43.50	43.06	54.00	-10.94	AV
Vertical	11652.562	58.98	8.46	37.68	44.50	60.62	74.00	-13.38	Pk
Vertical	11652.562	41.13	8.46	37.68	44.50	42.77	54.00	-11.23	AV
Vertical	17473.128	58.23	10.12	38.8	44.10	63.05	74.00	-10.95	Pk
Vertical	17473.128	40.36	10.12	38.8	42.70	46.58	54.00	-7.42	AV
Horizontal	6039.232	59.62	7.10	37.24	43.50	60.46	74.00	-13.54	Pk
Horizontal	6039.232	43.32	7.10	37.24	43.50	44.16	54.00	-9.84	AV
Horizontal	11652.319	52.28	8.46	38.57	44.50	54.81	74.00	-19.19	Pk
Horizontal	11652.319	40.11	8.46	38.57	44.50	42.64	54.00	-11.36	AV
Horizontal	17474.062	57.79	10.12	38.38	44.10	62.19	74.00	-11.81	Pk
Horizontal	17474.062	40.36	10.12	38.38	44.10	44.76	54.00	-9.24	AV

Note:"802.11a(5G)" mode is the worst mode. PK value is lower than the Average value limit, So average didn't record.

The amplitude of spurious emissions that are attenuated by more than 20dB below the permissible value has no need to be reported.

Emission level (dBuV/m) = 20 log Emission level (uV/m).

Corrected Reading: Antenna Factor + Cable Loss + Read Level - Preamp Factor = Level.





## 4. POWER SPECTRAL DENSITY TEST

### 4.1 APPLIED PROCEDURES / LIMIT

#### According to FCC §15.407(a)(3)

For the band 5.725-5.85 GHz

(3) For the band 5.725-5.85 GHz, the maximum power spectral density shall not exceed 30 dBm in any 500-kHz band. If transmitting antennas of directional gain greater than 6 dBi are used, both the maximum conducted output power and the maximum power spectral density shall be reduced by the amount in dB that the directional gain of the antenna exceeds 6 dBi.

### 4.2 TEST PROCEDURE

For devices operating in the bands 5.15-5.25 GHz, 5.25-5.35 GHz, and 5.47-5.725 GHz, the above procedures make use of 1 MHz RBW to satisfy directly the 1 MHz reference bandwidth specified in § 15.407(a)(5). For devices operating in the band 5.725-5.85 GHz, the rules specify a measurement bandwidth of 500 kHz. Many spectrum analyzers do not have 500 kHz RBW, thus a narrower RBW may need to be used. The rules permit the use of a RBWs less than 1 MHz, or 500 kHz, "provided that the measured power is integrated over the full reference bandwidth" to show the total power over the specified measurement bandwidth (i.e., 1 MHz, or 500 kHz). If measurements are performed using a reduced resolution bandwidth (< 1 MHz, or < 500 kHz) and integrated over 1 MHz, or 500 KHz bandwidth, the following adjustments to the procedures apply:

- a) Set  $RBW \geq 1/T$ , where T is defined in section II.B.I.a).
- b) Set  $VBW \geq 3 RBW$ .
- c) If measurement bandwidth of Maximum PSD is specified in 500 kHz, add  $10\log(500\text{kHz}/RBW)$  to the measured result, whereas RBW (< 500 KHz) is the reduced resolution bandwidth of the spectrum analyzer set during measurement.
- d) If measurement bandwidth of Maximum PSD is specified in 1 MHz, add  $10\log(1\text{MHz}/RBW)$  to the measured result, whereas RBW (< 1 MHz) is the reduced resolution bandwidth of spectrum analyzer set during measurement.
- e) Care must be taken to ensure that the measurements are performed during a period of continuous transmission or are corrected upward for duty cycle.

Note: As a practical matter, it is recommended to use reduced RBW of 100 KHz for the sections 5.c) and 5.d) above, since RBW=100 KHZ is available on nearly all spectrum analyzers.

### 4.3 DEVIATION FROM STANDARD

No deviation.



#### 4.4 TEST SETUP



#### 4.5 EUT OPERATION CONDITIONS

The EUT tested system was configured as the statements of 2.1 Unless otherwise a special operating condition is specified in the follows during the testing.



4.6 TEST RESULTS

Temperature :	26 °C	Relative Humidity :	54%
Pressure :	101kPa	Test Voltage :	DC 12V
Test Mode :	TX Frequency U-NII-3 (5745-5825MHz)		

Note: A(B) Represent the value of antenna A and B, The worst data is Antenna A ,only shown Antenna A Plot.

Antenna A gain: 5dBi, Antenna B gain: 5dBi, Directional gain=[10log(GA+ G B)] dbi =8.01dbi  
limit=30-(8.01-6)=27.99

Mode	Frequency	Measured Power Density (dBm/500KHz)			Limit (dBm/500kHz)	Result
		ANT A	ANT B	Total		
802.11 a	5745 MHz	12.856	12.516	/	30	PASS
	5785 MHz	11.282	11.251	/	30	PASS
	5825 MHz	10.628	10.518	/	30	PASS
802.11 n20	5745 MHz	9.604	9.277	12.45	27.99	PASS
	5785 MHz	9.845	9.973	12.92	27.99	PASS
	5825 MHz	9.150	9.043	12.11	27.99	PASS
802.11 n40	5755 MHz	8.234	7.323	10.81	27.99	PASS
	5795 MHz	7.810	7.450	10.64	27.99	PASS
802.11 AC20	5745 MHz	10.806	10.148	13.50	27.99	PASS
	5785 MHz	10.147	9.466	12.83	27.99	PASS
	5825 MHz	10.596	9.678	13.17	27.99	PASS
802.11 AC40	5755 MHz	8.934	7.100	11.12	27.99	PASS
	5795 MHz	8.073	7.204	10.67	27.99	PASS
802.11 AC80	5775 MHz	7.407	6.381	9.93	27.99	PASS



(802.11a) PSD plot on channel 149



(802.11n20) PSD plot on channel 149

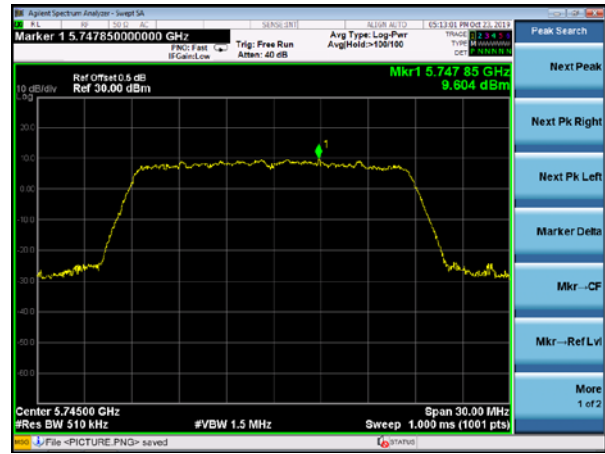

(802.11a) PSD plot on channel 157



(802.11n20) PSD plot on channel 157

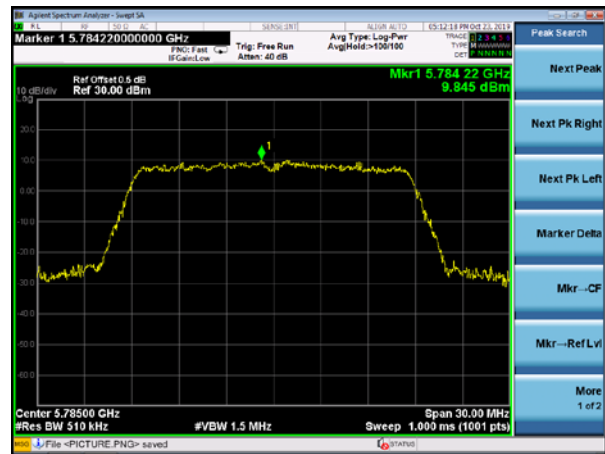

(802.11a) PSD plot on channel 165



(802.11n20) PSD plot on channel 165





(802.11n40) PSD plot on channel 151

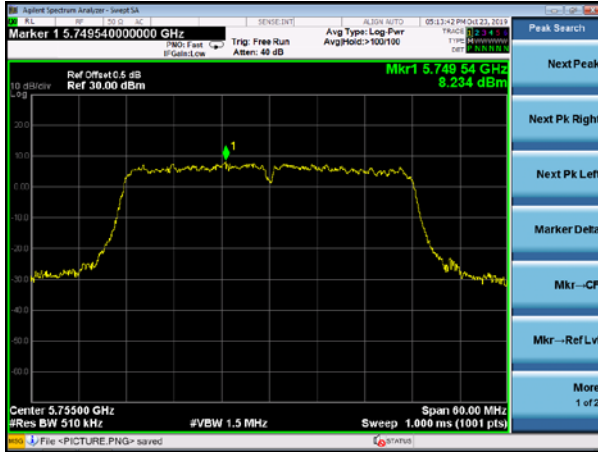

(802.11ac20) PSD plot on channel 149

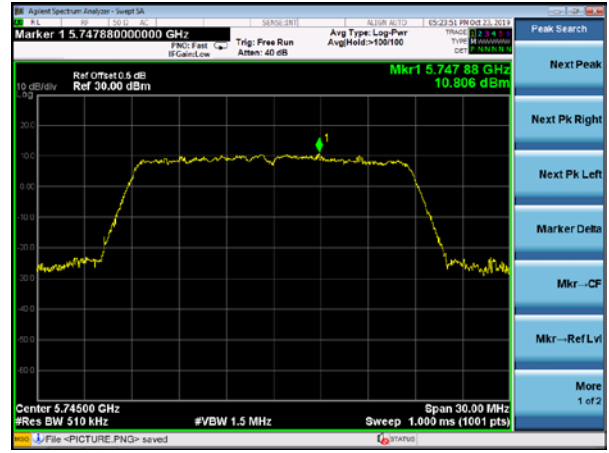

(802.11n40) PSD plot on channel 159

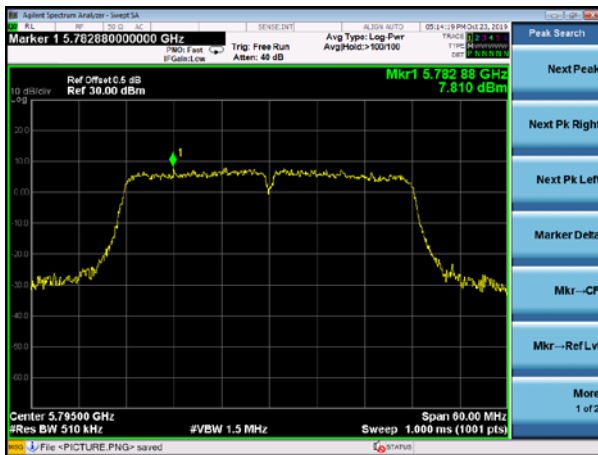

(802.11ac20) PSD plot on channel 157



(802.11ac20) PSD plot on channel 165

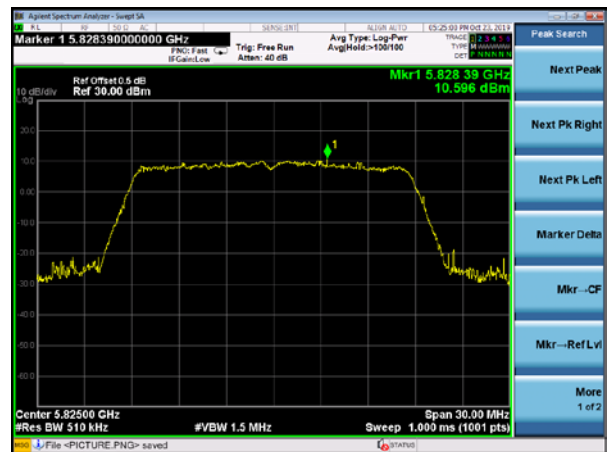



(802.11ac40) PSD plot on channel 151

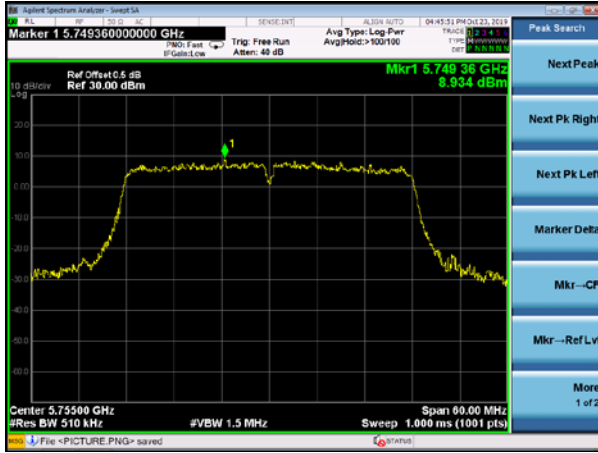

(802.11ac80) PSD plot on channel 155

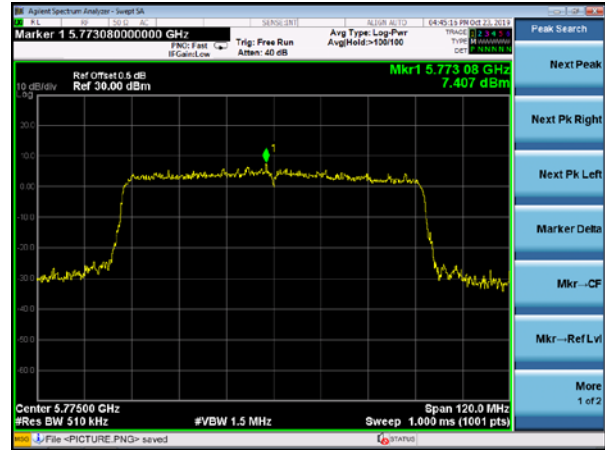

(802.11ac40) PSD plot on channel 159





## 5. 6DB & 99% EMISSION BANDWIDTH

### 5.1 APPLIED PROCEDURES / LIMIT

The maximum power spectral density is measured as a conducted emission by direct connection of a calibrated test instrument to the equipment under test. If the device cannot be connected directly, alternative techniques acceptable to the Commission may be used. Measurements in the 5.725-5.85 GHz band are made over a reference bandwidth of 500 kHz or the 26 dB emission bandwidth of the device, whichever is less. Measurements in the 5.15-5.25 GHz, 5.25-5.35 GHz, and the 5.47-5.725 GHz bands are made over a bandwidth of 1 MHz or the 26 dB emission bandwidth of the device, whichever is less. A narrower resolution bandwidth can be used, provided that the measured power is integrated over the full reference bandwidth.

### 5.2 TEST PROCEDURE

Section 15.407(e) specifies the minimum 6 dB emission bandwidth of at least 500 kHz for the band 5.725–5.85 GHz. The following procedure shall be used for measuring this bandwidth:

- a) Set RBW = 100 kHz.
- b) Set the video bandwidth (VBW)  $\geq 3$  RBW.
- c) Detector = Peak.
- d) Trace mode = max hold.
- e) Sweep = auto couple.
- f) Allow the trace to stabilize.
- g) Measure the maximum width of the emission that is constrained by the frequencies associated with the two outermost amplitude points (upper and lower frequencies) that are attenuated by 6 dB relative to the maximum level measured in the fundamental emission.

Note: The automatic bandwidth measurement capability of a spectrum analyzer or EMI receiver may be employed if it implements the functionality described in this section. For devices that use channel aggregation refer to III.A and III.C for determining emission bandwidth.



- a) Set RBW = approximately 1% of the emission bandwidth.
- b) Set the VBW > RBW.
- c) Detector = Peak.
- d) Trace mode = max hold.
- e) Measure the maximum width of the emission that is 26 dB down from the maximum of the emission. Compare this with the RBW setting of the analyzer. Readjust RBW and repeat measurement as needed until the RBW/EBW ratio is approximately 1%.

The following procedure shall be used for measuring (99 %) power bandwidth:

1. Set center frequency to the nominal EUT channel center frequency.
2. Set span = 1.5 times to 5.0 times the OBW.
3. Set RBW = 1 % to 5 % of the OBW
4. Set VBW  $\geq 3 \cdot$  RBW
5. Video averaging is not permitted. Where practical, a sample detection and single sweep mode shall be used. Otherwise, peak detection and max hold mode (until the trace stabilizes) shall be used.
6. Use the 99 % power bandwidth function of the instrument (if available).
7. If the instrument does not have a 99 % power bandwidth function, the trace data points are recovered and directly summed in power units. The recovered amplitude data points, beginning at the lowest frequency, are placed in a running sum until 0.5 % of the total is reached; that frequency is recorded as the lower frequency. The process is repeated until 99.5 % of the total is reached; that frequency is recorded as the upper frequency. The 99% occupied bandwidth is the difference between these two frequencies.

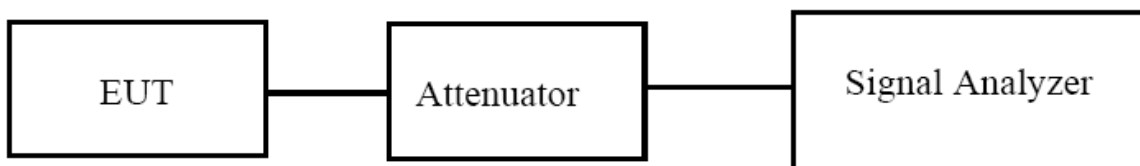

### 5.3 EUT OPERATION CONDITIONS

The EUT tested system was configured as the statements of 2.4 Unless otherwise a special operating condition is specified in the follows during the testing.





5.4 TEST RESULTS

Temperature :	26 °C	Relative Humidity :	54%
Pressure :	101kPa	Test Voltage :	DC 12V
Test Mode :	TX Frequency U-NII-3(5745-5850MHz)		

Note: A(B) Represent the value of antenna A and B, The worst data is Antenna A ,only shown Antenna A Plot.

Mode	Channel	Frequency (MHz)	99% bandwidth(MHz)	6dB bandwidth (MHz)	Limit MHz	Result
			ANT A	ANT A		
802.11a	CH149	5745	16.525	16.33	≥500	Pass
	CH157	5785	16.490	16.32	≥500	Pass
	CH165	5825	16.513	16.32	≥500	Pass
802.11 n20	CH149	5745	17.682	17.30	≥500	Pass
	CH157	5785	17.684	17.57	≥500	Pass
	CH165	5825	17.717	17.56	≥500	Pass
802.11 n40	CH151	5755	36.260	35.40	≥500	Pass
	CH159	5795	36.243	35.14	≥500	≥500
802.11 AC20	CH149	5745	17.724	16.92	≥500	≥500
	CH157	5785	17.685	17.26	≥500	≥500
	CH165	5825	17.696	17.55	≥500	≥500
802.11 AC40	CH151	5755	36.246	35.39	≥500	≥500
	CH159	5795	36.288	35.32	≥500	≥500
802.11 AC80	CH155	5775	75.226	75.10	≥500	≥500



Mode	Channel	Frequency (MHz)	99% bandwidth(MHz)	6dB bandwidth (MHz)	Limit MHz	Result
			ANT B	ANT B		
802.11a	CH149	5745	16.500	16.31	≥500	Pass
	CH157	5785	16.508	16.35	≥500	Pass
	CH165	5825	16.700	16.32	≥500	Pass
802.11 n20	CH149	5745	17.707	16.94	≥500	Pass
	CH157	5785	17.662	17.59	≥500	Pass
	CH165	5825	17.683	17.26	≥500	Pass
802.11 n40	CH151	5755	36.284	34.83	≥500	Pass
	CH159	5795	36.260	35.32	≥500	Pass
802.11 AC20	CH149	5745	17.702	17.58	≥500	Pass
	CH157	5785	17.696	16.94	≥500	Pass
	CH165	5825	17.729	16.86	≥500	Pass
802.11 AC40	CH151	5755	36.238	35.09	≥500	Pass
	CH159	5795	36.204	35.09	≥500	Pass
802.11 AC80	CH155	5775	75.248	75.06	≥500	Pass



Antenna A: 5725-5850MHz

**Test plot**

(802.11a)99%Bandwidth plot on channel 149

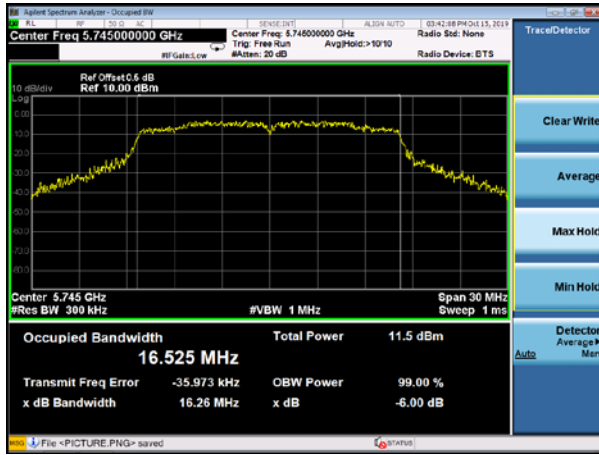

(802.11 n20) 99%Bandwidth plot on channel 149

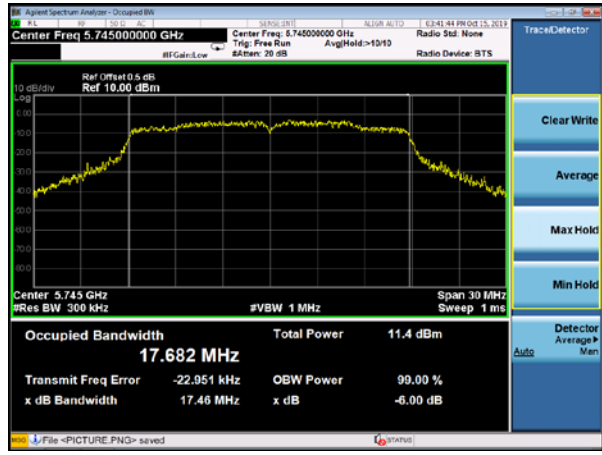

(802.11a)99%Bandwidth plot on channel 157



(802.11 n20) 99%Bandwidth plot on channel 157



(802.11a) 99%Bandwidth plot on channel 165

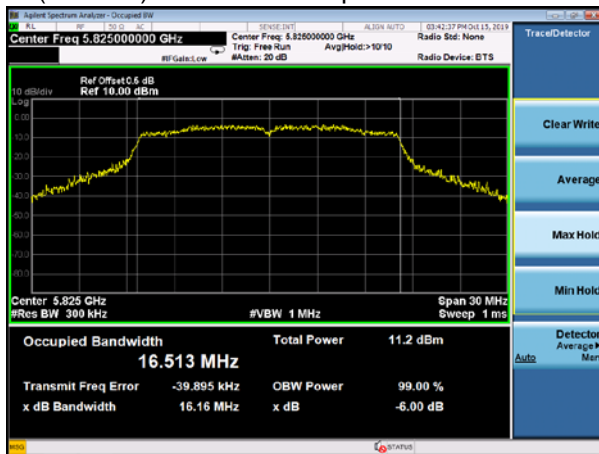

(802.11 n20) 99%Bandwidth plot on channel 165

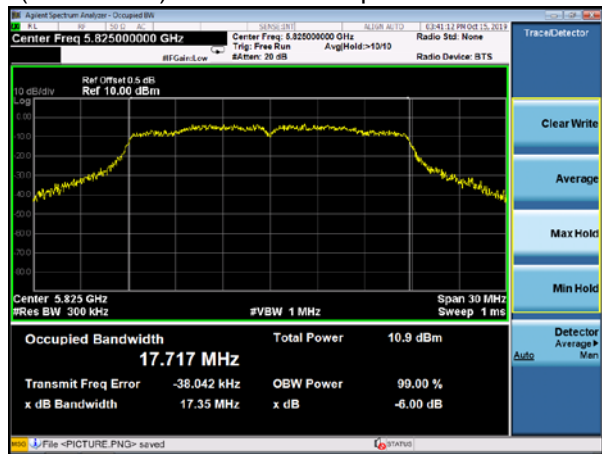



**Test plot**

(802.11 n40) 99%Bandwidth plot on channel 151

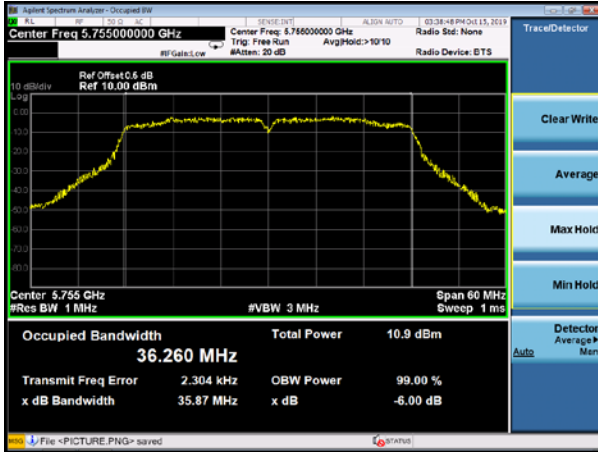

(802.11 AC20) 99%Bandwidth plot on channel 149

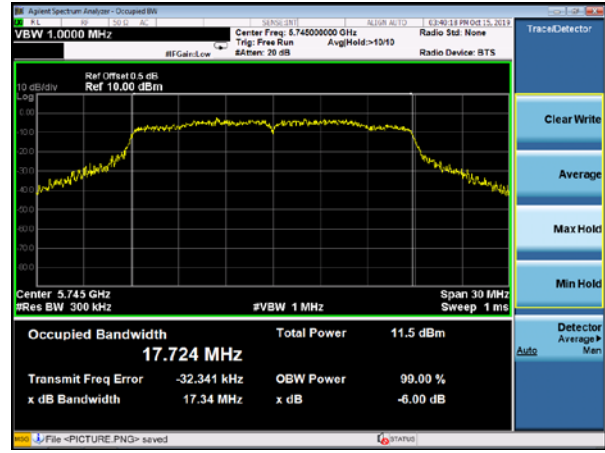

(802.11 n40) 99%Bandwidth plot on channel 159

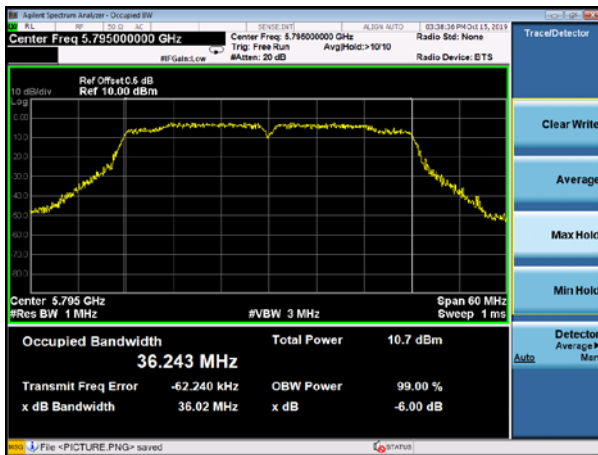

(802.11 AC20) 99%Bandwidth plot on channel 157



(802.11 AC20) 99%Bandwidth plot on channel 165

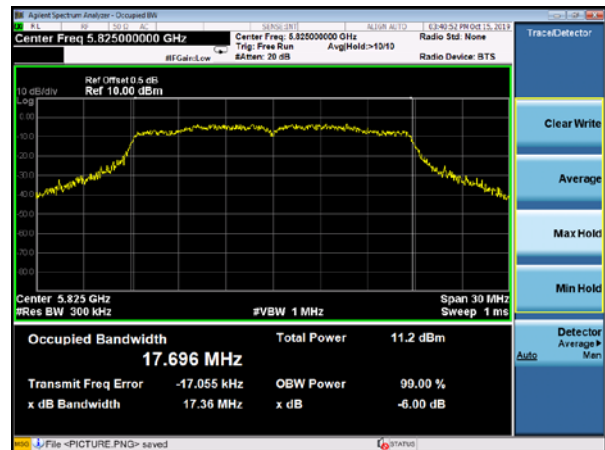



**Test plot**

(802.11 AC40)99%Bandwidth plot on channel 151

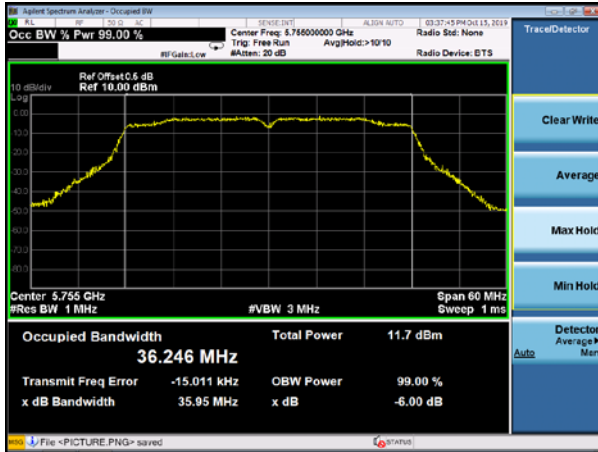

(802.11 AC80) 99%Bandwidth plot on channel 155

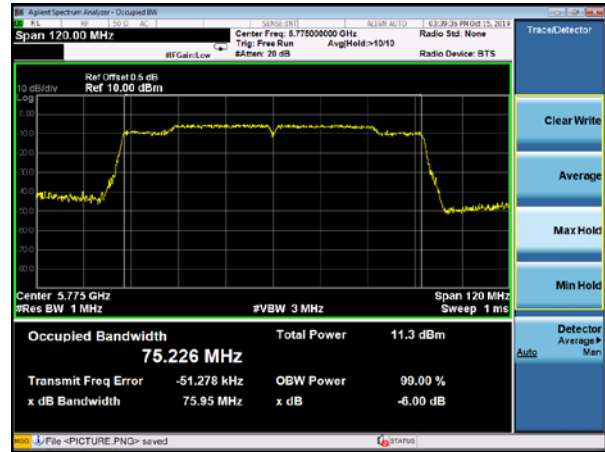

(802.11 AC40)99%Bandwidth plot on channel 159

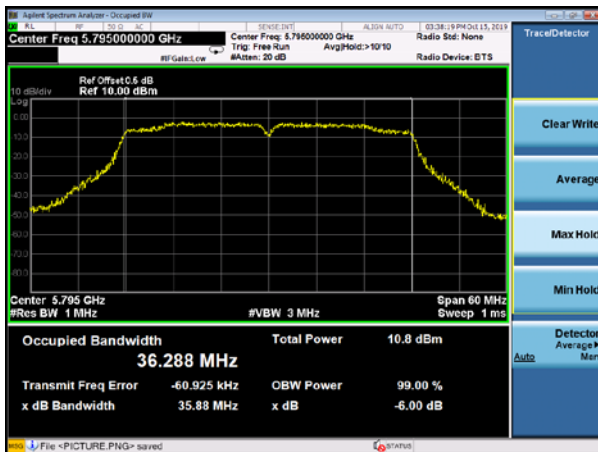



Antenna A: 5745-5825MHz

**Test plot**

(802.11a) 6dB Bandwidth plot on channel 149

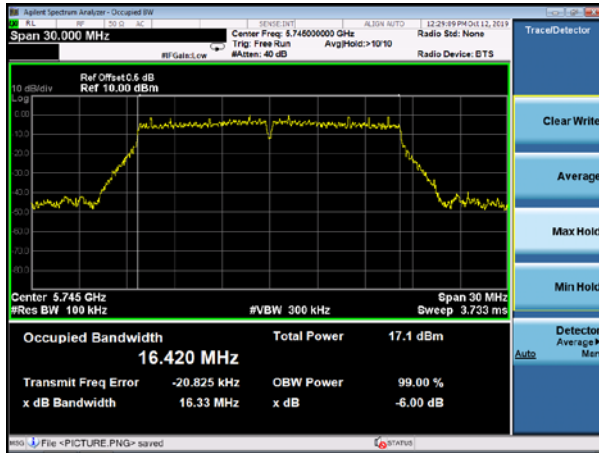

(802.11 n20) 6dB Bandwidth plot on channel 149

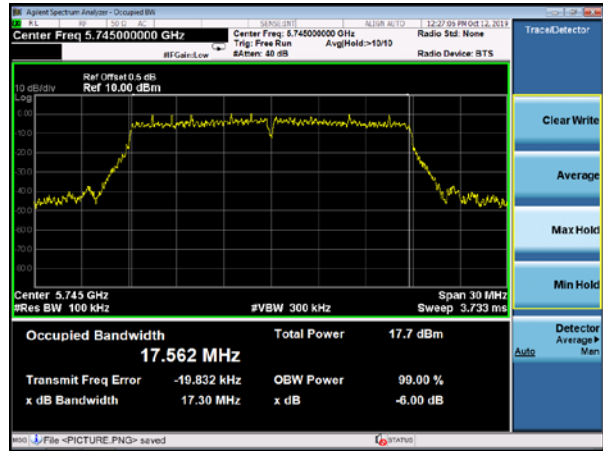

(802.11a) 6dB Bandwidth plot on channel 157

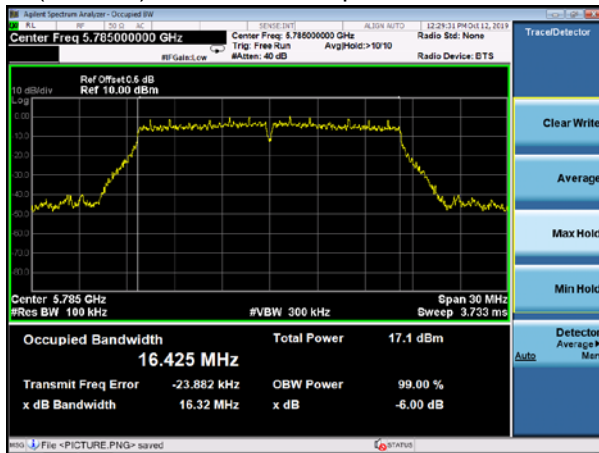

(802.11 n20) 6dB Bandwidth plot on channel 157

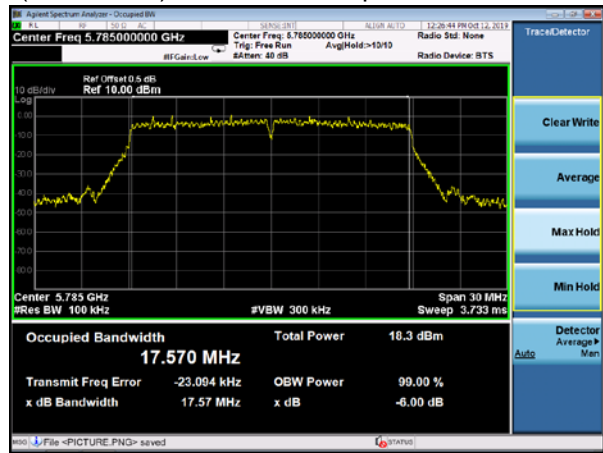

(802.11a) 6dB Bandwidth plot on channel 165

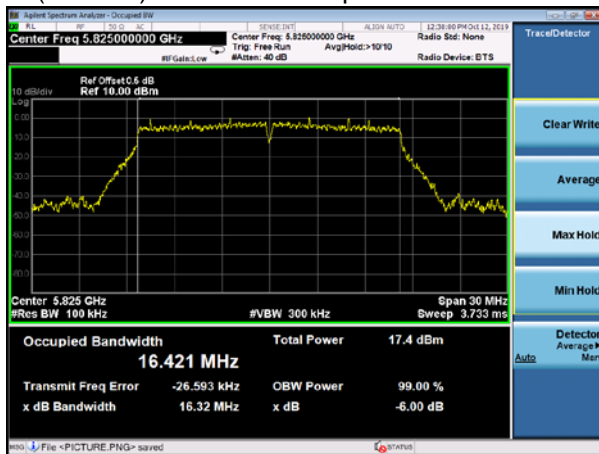

(802.11 n20) 6dB Bandwidth plot on channel 165

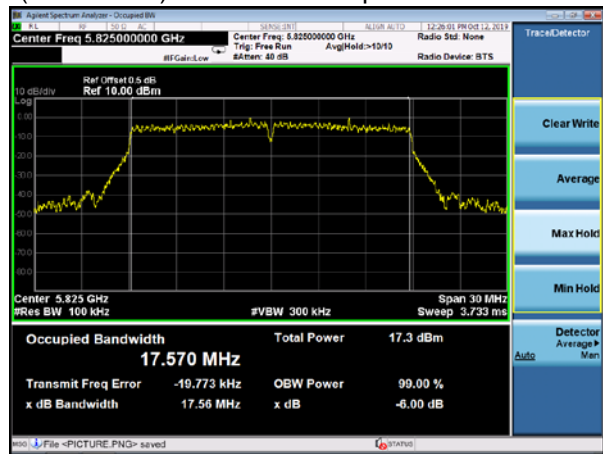



**Test plot**

(802.11 n40) 6dB Bandwidth plot on channel 151

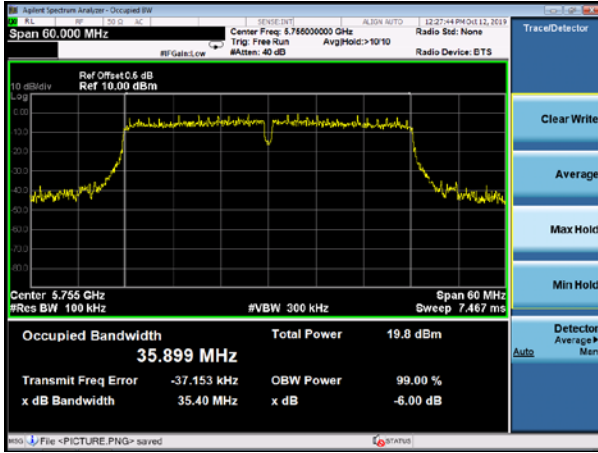

(802.11 AC20) 6dB Bandwidth plot on channel 149

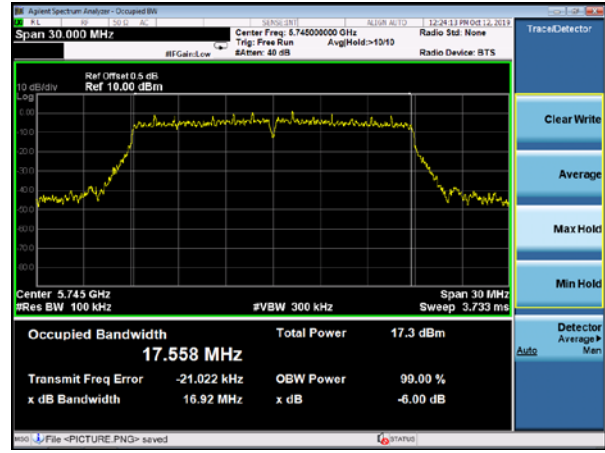

(802.11 n40) 6dB Bandwidth plot on channel 159

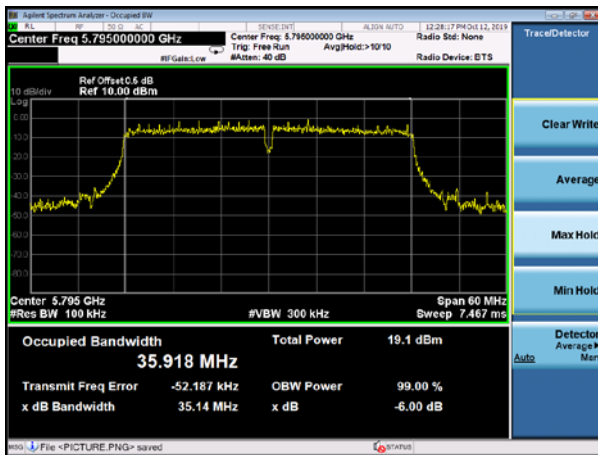

(802.11 AC20) 6dB Bandwidth plot on channel 157

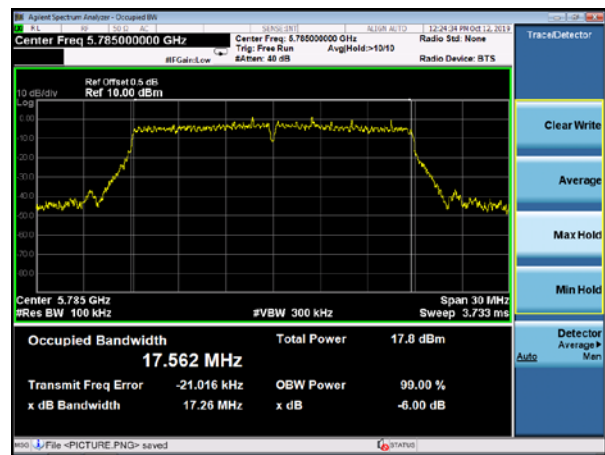

(802.11 AC20) 6dB Bandwidth plot on channel 165

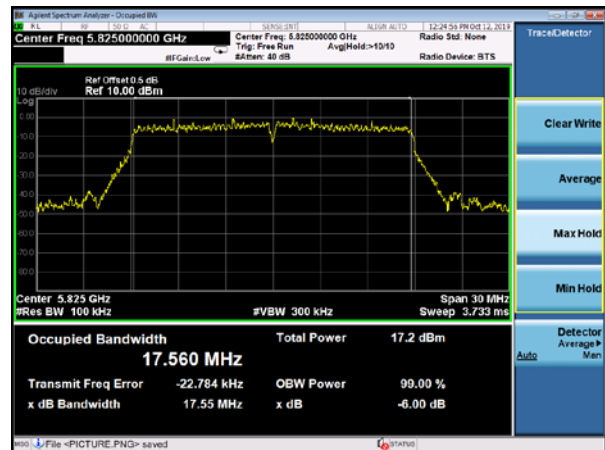



**Test plot**

(802.11 AC40) 6dB Bandwidth plot on channel 151

(802.11 AC80) 6dB Bandwidth plot on channel 155

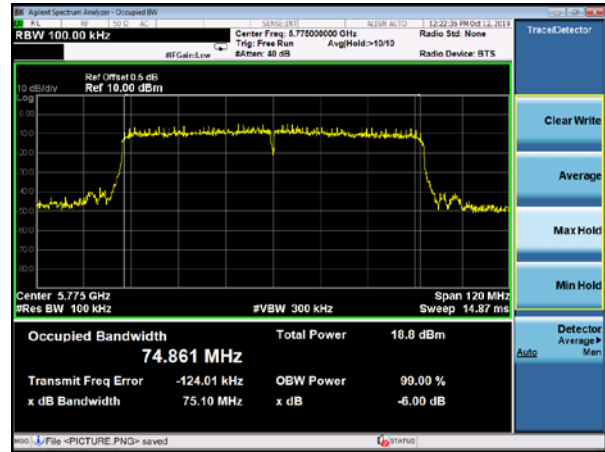
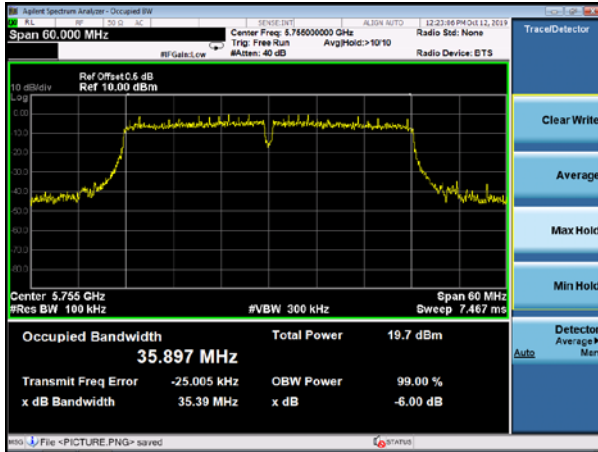

(802.11 AC40) 6dB Bandwidth plot on channel 159

