

ANTENNA PASSIVE TEST REPORT

Application No.	ZO/2021/C0005
Applicant	SKULLCANDY, INC.
Manufacturer	SKULLCANDY, INC.
Product Name	Crusher ANC 2
Model No.	S6CAW
Standards	ANSI/IEEE Std 149-2008
Date Initial Sample(s) Received	2021.12.03
Testing Start Date	2021.12.07
Testing Finish Date	2022.11.14
Report Issue Date	2022.12.14

* In the configuration tested, the EUT detailed in this report complied with the standards specified above.

Yuanyu Luo

Prepared by

Max. Huang

Reviewed By

Ervin Li

Approved by

Revision Version

Report No.	Version	Date	Memo
ZO/2021/C000501	00	2022.12.14	Initial creation of report



Unless otherwise agreed in writing, this document is issued by the Company subject to its General Conditions of Service printed overleaf, available on request or accessible at <http://www.sgs.com/en/Terms-and-Conditions.aspx> and, for electronic format documents, subject to Terms and Conditions for Electronic Documents at <http://www.sgs.com/en/Terms-and-Conditions/Terms-e-Documents.aspx>. Attention is drawn to the limitation of liability, indemnification and jurisdiction issues defined therein. Any holder of this document is advised that information contained hereon reflects the Company's findings at the time of its intervention only and within the limits of Client's instructions, if any. The Company's sole responsibility is to its Client and this document does not exonerate parties to a transaction from exercising all their rights and obligations under the transaction documents. This document cannot be reproduced except in full, without prior written approval of the Company. Any unauthorized alteration, forgery or falsification of the content or appearance of this document is unlawful and offenders may be prosecuted to the fullest extent of the law. Unless otherwise stated the results shown in this test report refer only to the sample(s) tested and such sample(s) are retained for 30 days only.

Attention: To check the authenticity of testing / inspection report & certificate, please contact us at telephone: (86-755) 8307 1443, or email: CN.Doccheck@sgs.com

TABLE OF CONTENTS

1	GENERAL INFORMATION	4
1.1	Testing Laboratory.....	4
1.2	Details of Applicant	4
1.3	Details of Manufacturer	4
1.4	General Description of EUT.....	5
1.5	Test Procedure	5
1.6	Test Specification	6
1.7	Laboratory Environment.....	6
2	OTA MEASUREMENTS SYSTEM CONFIGURATION	7
2.1	Test Configuration.....	7
3	TEST EQUIPMENT LIST	8
4	MEASUREMENT UNCERTAINTY	9
5	TEST RESULTS	10
6	PATTERN PLOTS	14
6.1	Return Loss.....	14
6.2	VSWR	16
6.3	Stimulus	18
7	2-D ANTENNA PATTERN(THETA=90°)	20
8	3-D ANTENNA PATTERN	22
9	THE EUT AND TEST CONFIGURATION	26



Unless otherwise agreed in writing, this document is issued by the Company subject to its General Conditions of Service printed overleaf, available on request or accessible at <http://www.sgs.com/en/Terms-and-Conditions.aspx> and, for electronic format documents, subject to Terms and Conditions for Electronic Documents at <http://www.sgs.com/en/Terms-and-Conditions/Terms-e-Documents.aspx>. Attention is drawn to the limitation of liability, indemnification and jurisdiction issues defined therein. Any holder of this document is advised that information contained hereon reflects the Company's findings at the time of its intervention only and within the limits of Client's instructions, if any. The Company's sole responsibility is to its Client and this document does not exonerate parties to a transaction from exercising all their rights and obligations under the transaction documents. This document cannot be reproduced except in full, without prior written approval of the Company. Any unauthorized alteration, forgery or falsification of the content or appearance of this document is unlawful and offenders may be prosecuted to the fullest extent of the law. Unless otherwise stated the results shown in this test report refer only to the sample(s) tested and such sample(s) are retained for 30 days only.

Attention: To check the authenticity of testing / inspection report & certificate, please contact us at telephone: (86-755) 8307 1443, or email: CN.Doccheck@sgs.com

1 General Information

1.1 Testing Laboratory

Test Lab	SGS-CSTC Standards Technical Services Co., Ltd. Shenzhen Branch
Address	No. 1 Workshop, M-10, Middle section, Science & Technology Park, Nanshan District, Shenzhen, Guangdong, China 518057
Contact	Simon Ling
Tel.	+86 (0) 755 2601 2053
Fax	+86 (0) 755 2671 0594
E-mail	Simon.Ling@sgs.com

1.2 Details of Applicant

Applicant's Name	SKULLCANDY, INC.
Applicant's Address	6301 N Landmark Dr Park City UT 84098, Utah United States of America
Contact	James Nance
Tel.	1(435) 729-2485
Fax	N/A
E-mail	James.Nance@skullcandy.com

1.3 Details of Manufacturer

Manufacturer's Name	SKULLCANDY, INC.
Manufacturer's Address	6301 N Landmark Dr Park City UT 84098, Utah United States of America
Contact	James Nance
Tel.	1(435) 729-2485
Fax	N/A
E-mail	James.Nance@skullcandy.com



1.4 General Description of EUT

Device Description:	Crusher ANC 2
Device Manufacturer:	SKULLCANDY, INC.
Device Model:	S6CAW
Hardware Version:	N/A
Software Version:	N/A

1.5 Test Procedure

Testing is performed according to the **ANSI/IEEE Std 149-2008**.



Unless otherwise agreed in writing, this document is issued by the Company subject to its General Conditions of Service printed overleaf, available on request or accessible at <http://www.sgs.com/en/Terms-and-Conditions.aspx> and, for electronic format documents, subject to Terms and Conditions for Electronic Documents at <http://www.sgs.com/en/Terms-and-Conditions/Terms-e-Documents.aspx>. Attention is drawn to the limitation of liability, indemnification and jurisdiction issues defined therein. Any holder of this document is advised that information contained hereon reflects the Company's findings at the time of its intervention only and within the limits of Client's instructions, if any. The Company's sole responsibility is to its Client and this document does not exonerate parties to a transaction from exercising all their rights and obligations under the transaction documents. This document cannot be reproduced except in full, without prior written approval of the Company. Any unauthorized alteration, forgery or falsification of the content or appearance of this document is unlawful and offenders may be prosecuted to the fullest extent of the law. Unless otherwise stated the results shown in this test report refer only to the sample(s) tested and such sample(s) are retained for 30 days only.

Attention: To check the authenticity of testing/inspection report & certificate, please contact us at telephone: (86-755) 8307 1443, or email: CN.Doccheck@sgs.com

1.6 Test Specification

Identity	Document Title
ANSI/IEEE Std 149-2008	IEEE Standard Test Procedures for Antennas

1.7 Laboratory Environment

Temperature	Min. =19°C · Max. = 25°C	
Relative humidity	Min. =40% · Max. =72%	
Shield effect	0.7-6GHz	> 100dB
Ground resistance	<0.5Ω	



2 OTA Measurements System Configuration

2.1 Test Configuration

Great-Circle-Cut method is used to measure the antenna 3D GAIN of EUT in OTA qualified anechoic chamber. Equipment Under Test (EUT) geometry centre vertical projection at the centre of platform, the distance from EUT to measurement antenna is 5m

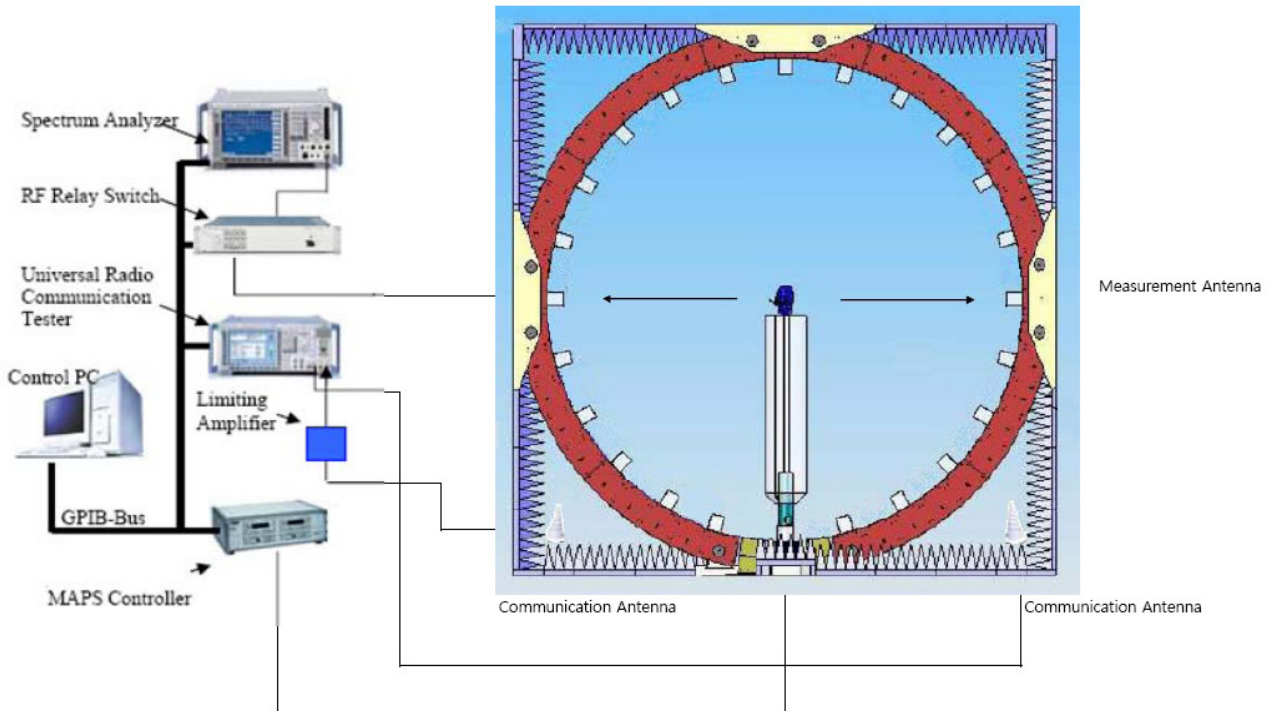

F-1. OTA Measurement System Configuration



Unless otherwise agreed in writing, this document is issued by the Company subject to its General Conditions of Service printed overleaf, available on request or accessible at <http://www.sgs.com/en/Terms-and-Conditions.aspx> and, for electronic format documents, subject to Terms and Conditions for Electronic Documents at <http://www.sgs.com/en/Terms-and-Conditions/Terms-e-Documents.aspx>. Attention is drawn to the limitation of liability, indemnification and jurisdiction issues defined therein. Any holder of this document is advised that information contained hereon reflects the Company's findings at the time of its intervention only and within the limits of Client's instructions, if any. The Company's sole responsibility is to its Client and this document does not exonerate parties to a transaction from exercising all their rights and obligations under the transaction documents. This document cannot be reproduced except in full, without prior written approval of the Company. Any unauthorized alteration, forgery or falsification of the content or appearance of this document is unlawful and offenders may be prosecuted to the fullest extent of the law. Unless otherwise stated the results shown in this test report refer only to the sample(s) tested and such sample(s) are retained for 30 days only.

Attention: To check the authenticity of testing/inspection report & certificate, please contact us at telephone: (86-755) 8307 1443, or email: CN.Doccheck@sgs.com
 No.1 Workshop, M-10, Middle Section, Science & Technology Park, Shenzhen, China 518057 t (86-755) 26012053 f (86-755) 26710594 www.sgsgroup.com.cn
 中国·深圳·科技园中区M-10栋一号厂房 邮编: 518057 t (86-755) 26012053 f (86-755) 26710594 sgs.china@sgs.com

3 Test Equipment List

Type of Equipment	Model Number	Manufacture	Calibration Date	Valid Period
Network Analyzer	E5071C S/N MY46523591	Keysight	2022/04/11	2023/04/10
Quad-Ridge Horn Antenna 700 MHz-10 GHz	EMCO 3164-08 S/N 161915	ETS-Lindgren L.P.	N/A	N/A
MAPS Controller	EMCENTER S/N 160485	ETS-Lindgren L.P.	N/A	N/A
SAM V4.5BS Head Phantom	Head Phantom S/N 3609	SPEAG	NCR	NCR



4 Measurement Uncertainty

Item	2400-2500 MHz (dB)
Gain	0.88
Efficiency	0.88
Measurement Uncertainty (95% CONFIDENCE INTERVAL) K=2	



Unless otherwise agreed in writing, this document is issued by the Company subject to its General Conditions of Service printed overleaf, available on request or accessible at <http://www.sgs.com/en/Terms-and-Conditions.aspx> and, for electronic format documents, subject to Terms and Conditions for Electronic Documents at <http://www.sgs.com/en/Terms-and-Conditions/Terms-e-Documents.aspx>. Attention is drawn to the limitation of liability, indemnification and jurisdiction issues defined therein. Any holder of this document is advised that information contained hereon reflects the Company's findings at the time of its intervention only and within the limits of Client's instructions, if any. The Company's sole responsibility is to its Client and this document does not exonerate parties to a transaction from exercising all their rights and obligations under the transaction documents. This document cannot be reproduced except in full, without prior written approval of the Company. Any unauthorized alteration, forgery or falsification of the content or appearance of this document is unlawful and offenders may be prosecuted to the fullest extent of the law. Unless otherwise stated the results shown in this test report refer only to the sample(s) tested and such sample(s) are retained for 30 days only.

Attention: To check the authenticity of testing/inspection report & certificate, please contact us at telephone: (86-755) 8307 1443, or email: CN.Doccheck@sgs.com

5 Test Results

Free Space #1			
Frequency (MHz)	Efficiency (dB)	Efficiency (%)	Gain (dBi)
2350	-2.68	53.92	3.21
2355	-2.61	54.78	3.16
2360	-2.41	57.45	3.45
2365	-2.45	56.90	3.32
2370	-2.49	56.35	3.31
2375	-2.58	55.16	3.19
2380	-2.55	55.55	3.24
2385	-2.56	55.52	3.30
2390	-2.49	56.41	3.29
2395	-2.35	58.15	3.53
2400	-2.38	57.75	3.43
2402	-2.36	58.10	3.52
2405	-2.33	58.45	3.54
2410	-2.37	57.96	3.47
2415	-2.39	57.66	3.43
2420	-2.49	56.42	3.20
2425	-2.49	56.39	3.18
2430	-2.53	55.88	3.10
2435	-2.51	56.08	3.10
2440	-2.46	56.70	3.16
2441	-2.47	56.60	3.16
2445	-2.48	56.47	3.14
2450	-2.52	55.98	3.06
2455	-2.59	55.05	2.99
2460	-2.67	54.06	2.88

Beside Head #1			
Frequency (MHz)	Efficiency (dB)	Efficiency (%)	Gain (dBi)
2350	-4.08	39.09	2.52
2355	-4.05	39.38	2.60
2360	-3.83	41.37	2.77
2365	-3.89	40.85	2.74
2370	-3.96	40.17	2.64
2375	-4.06	39.23	2.57
2380	-4.08	39.12	2.54
2385	-4.07	39.17	2.58
2390	-4.03	39.49	2.60
2395	-3.84	41.29	2.83
2400	-3.89	40.81	2.73
2402	-3.90	40.70	2.64
2405	-3.83	41.42	2.75
2410	-3.86	41.11	2.77
2415	-3.88	40.92	2.72
2420	-3.93	40.42	2.71
2425	-3.94	40.38	2.66
2430	-3.92	40.53	2.72
2435	-3.93	40.46	2.65
2440	-3.83	41.39	2.77
2441	-3.84	41.30	2.79
2445	-3.86	41.11	2.66
2450	-3.84	41.33	2.73
2455	-3.90	40.78	2.71
2460	-3.99	39.93	2.60



2465	-2.66	54.20	2.96
2470	-2.81	52.39	2.84
2475	-2.77	52.87	2.85
2480	-2.90	51.30	2.70
2482	-2.89	51.45	2.58
2485	-2.82	52.22	2.57
2490	-2.81	52.35	2.61
2495	-2.64	54.49	2.61
2500	-2.59	55.11	2.79
2505	-2.60	54.98	2.68
2510	-2.65	54.32	2.83
2515	-2.88	51.48	2.57
2520	-2.98	50.35	2.46
2525	-3.14	48.47	2.32
2530	-3.17	48.21	2.25
2535	-3.24	47.47	2.36
2540	-3.26	47.19	2.31
2545	-3.19	47.95	2.60
2550	-3.30	46.78	2.47
2555	-3.32	46.52	2.56
2560	-3.50	44.70	2.27
2565	-3.54	44.22	2.20
2570	-3.67	42.95	1.99
2575	-3.75	42.15	1.84
2580	-3.70	42.63	1.93

2465	-3.95	40.31	2.65
2470	-4.11	38.83	2.43
2475	-4.04	39.47	2.48
2480	-4.19	38.07	2.22
2482	-4.15	38.45	2.35
2485	-4.07	39.15	2.30
2490	-4.06	39.24	2.34
2495	-3.86	41.09	2.52
2500	-3.81	41.61	2.66
2505	-3.80	41.69	2.66
2510	-3.81	41.59	2.67
2515	-4.05	39.35	2.27
2520	-4.12	38.77	2.06
2525	-4.23	37.74	1.92
2530	-4.22	37.87	1.89
2535	-4.23	37.75	1.89
2540	-4.21	37.89	1.87
2545	-4.08	39.07	2.10
2550	-4.18	38.21	1.88
2555	-4.15	38.50	1.99
2560	-4.29	37.23	1.76
2565	-4.28	37.32	1.91
2570	-4.35	36.70	1.90
2575	-4.43	36.09	1.85
2580	-4.27	37.39	2.24



Unless otherwise agreed in writing, this document is issued by the Company subject to its General Conditions of Service printed overleaf, available on request or accessible at <http://www.sgs.com/en/Terms-and-Conditions.aspx> and, for electronic format documents, subject to Terms and Conditions for Electronic Documents at <http://www.sgs.com/en/Terms-and-Conditions/Terms-e-Documents.aspx>. Attention is drawn to the limitation of liability, indemnification and jurisdiction issues defined therein. Any holder of this document is advised that information contained hereon reflects the Company's findings at the time of its intervention only and within the limits of Client's instructions, if any. The Company's sole responsibility is to its Client and this document does not exonerate parties to a transaction from exercising all their rights and obligations under the transaction documents. This document cannot be reproduced except in full, without prior written approval of the Company. Any unauthorized alteration, forgery or falsification of the content or appearance of this document is unlawful and offenders may be prosecuted to the fullest extent of the law. Unless otherwise stated the results shown in this test report refer only to the sample(s) tested and such sample(s) are retained for 30 days only.

Attention: To check the authenticity of testing/inspection report & certificate, please contact us at telephone: (86-755) 8307 1443, or email: CN.Doccheck@sgs.com
 No.1 Workshop, M-10, Middle Section, Science & Technology Park, Shenzhen, China 518057 t (86-755) 26012053 f (86-755) 26710594 www.sgsgroup.com.cn
 中国·深圳·科技园中区M-10栋一号厂房 邮编: 518057 t (86-755) 26012053 f (86-755) 26710594 sgs.china@sgs.com

Beside Head #2			
Frequency (MHz)	Efficiency (dB)	Efficiency (%)	Gain (dBi)
2350	-3.43	45.44	3.73
2355	-3.38	45.89	3.86
2360	-3.18	48.11	4.10
2365	-3.21	47.79	4.12
2370	-3.24	47.40	4.01
2375	-3.33	46.40	3.95
2380	-3.34	46.33	3.86
2385	-3.37	46.02	3.84
2390	-3.30	46.83	3.88
2395	-3.15	48.45	4.04
2400	-3.17	48.21	3.95
2402	-3.13	48.62	3.93
2405	-3.10	48.95	3.97
2410	-3.12	48.71	3.88
2415	-3.11	48.88	3.88
2420	-3.16	48.33	3.76
2425	-3.11	48.87	3.81
2430	-3.12	48.71	3.78
2435	-3.07	49.36	3.98
2440	-2.97	50.45	4.07
2441	-2.98	50.39	4.04
2445	-2.93	50.94	4.28
2450	-2.89	51.36	4.29
2455	-2.89	51.44	4.33
2460	-2.90	51.24	4.15
2465	-2.85	51.82	4.13

Beside Head #3			
Frequency (MHz)	Efficiency (dB)	Efficiency (%)	Gain (dBi)
2350	-3.80	41.69	3.09
2355	-3.78	41.91	3.11
2360	-3.59	43.74	3.38
2365	-3.64	43.23	3.29
2370	-3.71	42.54	3.20
2375	-3.82	41.51	3.06
2380	-3.85	41.24	3.02
2385	-3.85	41.19	3.03
2390	-3.78	41.92	3.16
2395	-3.57	43.93	3.50
2400	-3.58	43.87	3.53
2402	-3.55	44.11	3.51
2405	-3.50	44.72	3.67
2410	-3.52	44.41	3.64
2415	-3.54	44.31	3.67
2420	-3.62	43.41	3.49
2425	-3.61	43.60	3.50
2430	-3.64	43.25	3.31
2435	-3.60	43.69	3.37
2440	-3.49	44.76	3.43
2441	-3.50	44.69	3.39
2445	-3.43	45.40	3.64
2450	-3.37	46.05	3.87
2455	-3.33	46.46	3.96
2460	-3.35	46.22	4.01
2465	-3.28	46.99	4.04



Unless otherwise agreed in writing, this document is issued by the Company subject to its General Conditions of Service printed overleaf, available on request or accessible at <http://www.sgs.com/en/Terms-and-Conditions.aspx> and, for electronic format documents, subject to Terms and Conditions for Electronic Documents at <http://www.sgs.com/en/Terms-and-Conditions/Terms-e-Documents.aspx>. Attention is drawn to the limitation of liability, indemnification and jurisdiction issues defined therein. Any holder of this document is advised that information contained hereon reflects the Company's findings at the time of its intervention only and within the limits of Client's instructions, if any. The Company's sole responsibility is to its Client and this document does not exonerate parties to a transaction from exercising all their rights and obligations under the transaction documents. This document cannot be reproduced except in full, without prior written approval of the Company. Any unauthorized alteration, forgery or falsification of the content or appearance of this document is unlawful and offenders may be prosecuted to the fullest extent of the law. Unless otherwise stated the results shown in this test report refer only to the sample(s) tested and such sample(s) are retained for 30 days only.

Attention: To check the authenticity of testing / inspection report & certificate, please contact us at telephone: (86-755) 8307 1443, or email: CN.Doccheck@sgs.com
 No.1 Workshop, M-10, Middle Section, Science & Technology Park, Shenzhen, China 518057 t (86-755) 26012053 f (86-755) 26710594 www.sgsgroup.com.cn
 中国·深圳·科技园中区M-10栋一号厂房 邮编: 518057 t (86-755) 26012053 f (86-755) 26710594 sgs.china@sgs.com

2470	-2.96	50.61	4.06
2475	-2.90	51.27	4.05
2480	-2.97	50.42	4.00
2482	-2.95	50.73	4.03
2485	-2.86	51.80	4.11
2490	-2.79	52.65	4.21
2495	-2.59	55.12	4.40
2500	-2.52	55.97	4.41
2505	-2.51	56.15	4.44
2510	-2.50	56.22	4.31
2515	-2.66	54.25	4.10
2520	-2.70	53.67	3.97
2525	-2.83	52.14	3.83
2530	-2.84	51.94	3.78
2535	-2.89	51.41	3.73
2540	-2.89	51.45	3.78
2545	-2.78	52.76	3.99
2550	-2.84	52.01	3.90
2555	-2.81	52.30	3.94
2560	-2.92	51.00	3.79
2565	-2.92	51.01	3.79
2570	-2.99	50.24	3.72
2575	-3.03	49.74	3.67
2580	-2.97	50.50	3.84

2470	-3.37	46.06	4.04
2475	-3.27	47.09	4.09
2480	-3.31	46.66	4.09
2482	-3.26	47.22	4.27
2485	-3.16	48.28	4.23
2490	-3.03	49.80	4.45
2495	-2.80	52.46	4.74
2500	-2.66	54.14	4.91
2505	-2.62	54.64	5.03
2510	-2.60	54.95	4.97
2515	-2.74	53.19	4.83
2520	-2.81	52.36	4.71
2525	-2.91	51.20	4.65
2530	-2.92	51.06	4.62
2535	-2.94	50.86	4.64
2540	-2.93	50.97	4.71
2545	-2.79	52.61	4.86
2550	-2.83	52.16	4.83
2555	-2.77	52.86	4.87
2560	-2.83	52.11	4.82
2565	-2.81	52.32	4.81
2570	-2.82	52.22	4.79
2575	-2.85	51.86	4.79
2580	-2.73	53.33	4.99



Unless otherwise agreed in writing, this document is issued by the Company subject to its General Conditions of Service printed overleaf, available on request or accessible at <http://www.sgs.com/en/Terms-and-Conditions.aspx> and, for electronic format documents, subject to Terms and Conditions for Electronic Documents at <http://www.sgs.com/en/Terms-and-Conditions/Terms-e-Documents.aspx>. Attention is drawn to the limitation of liability, indemnification and jurisdiction issues defined therein. Any holder of this document is advised that information contained hereon reflects the Company's findings at the time of its intervention only and within the limits of Client's instructions, if any. The Company's sole responsibility is to its Client and this document does not exonerate parties to a transaction from exercising all their rights and obligations under the transaction documents. This document cannot be reproduced except in full, without prior written approval of the Company. Any unauthorized alteration, forgery or falsification of the content or appearance of this document is unlawful and offenders may be prosecuted to the fullest extent of the law. Unless otherwise stated the results shown in this test report refer only to the sample(s) tested and such sample(s) are retained for 30 days only.

Attention: To check the authenticity of testing/inspection report & certificate, please contact us at telephone: (86-755) 8307 1443, or email: CN.Doccheck@sgs.com

6 Pattern Plots

6.1 Return Loss

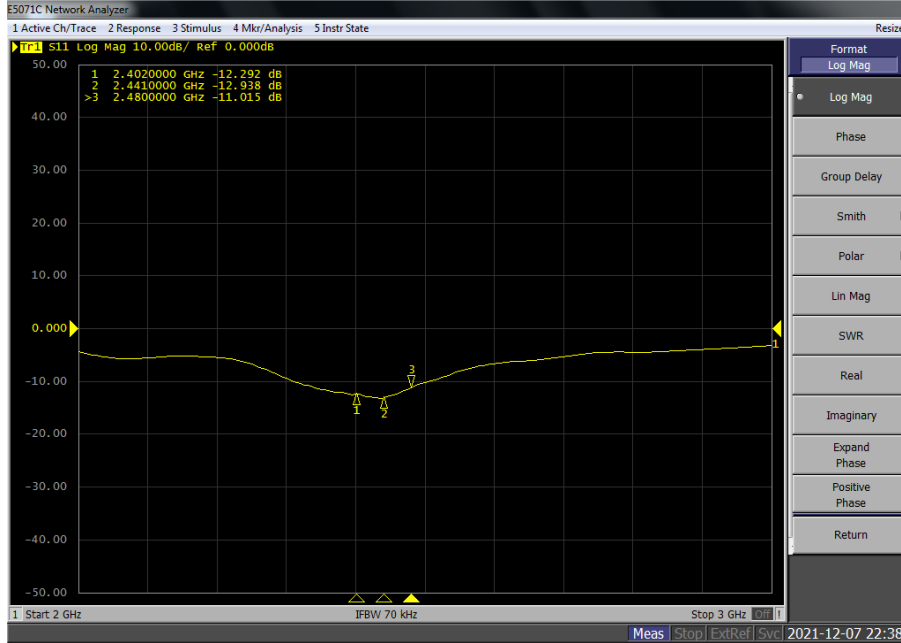

Free Space #1

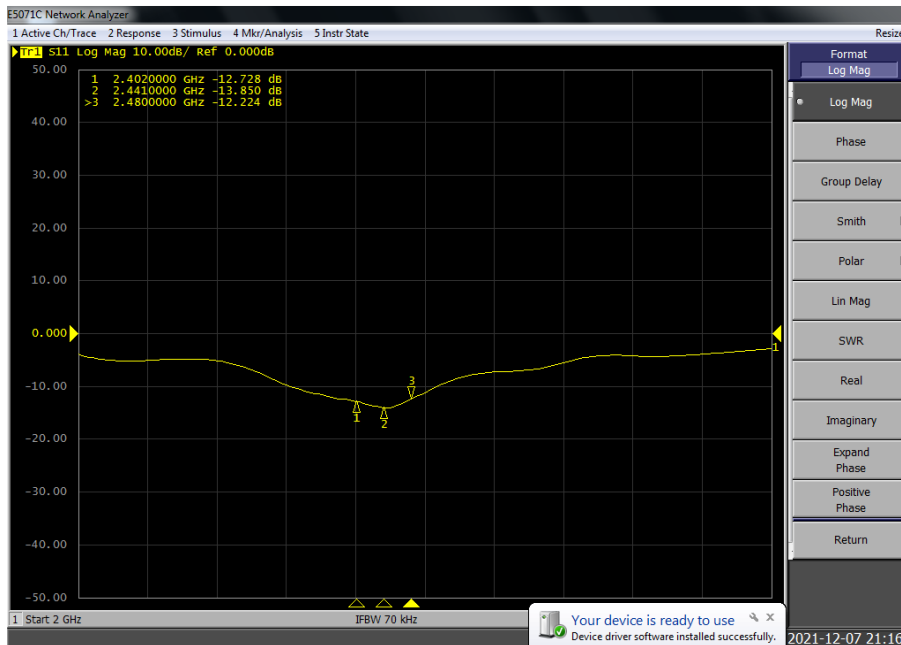

Beside Head #1



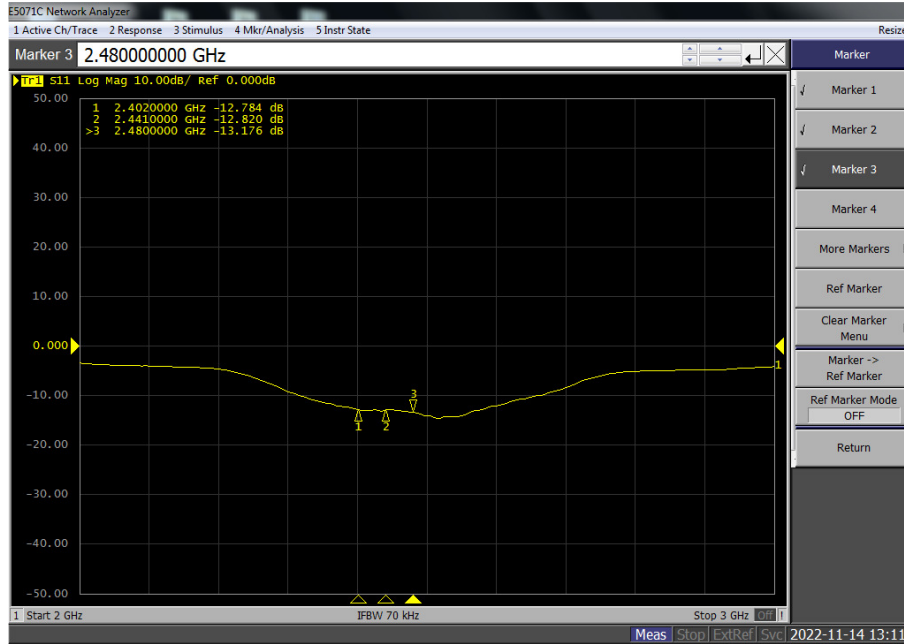

Beside Head #2

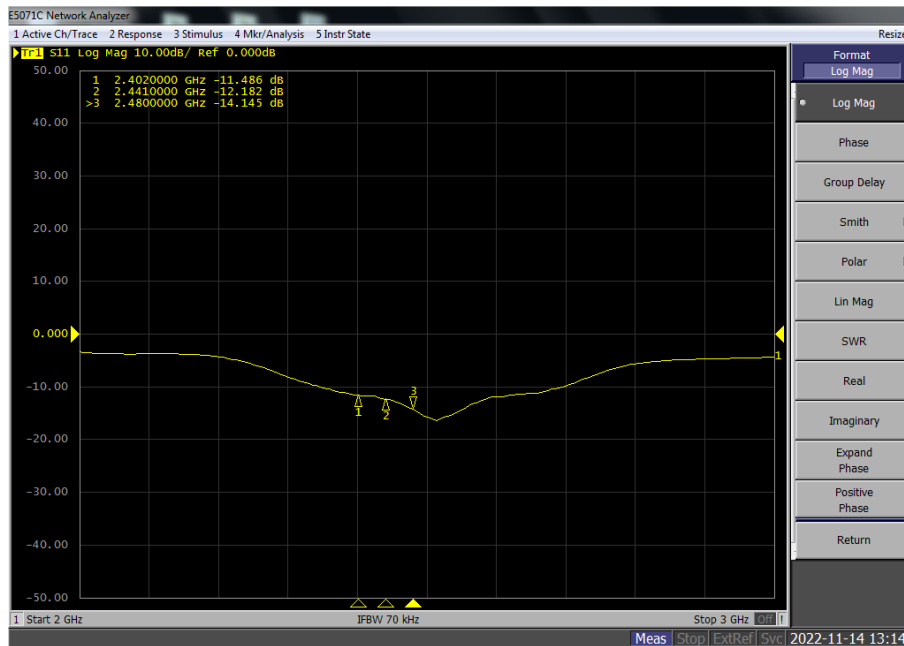

Beside Head #3



6.2 VSWR

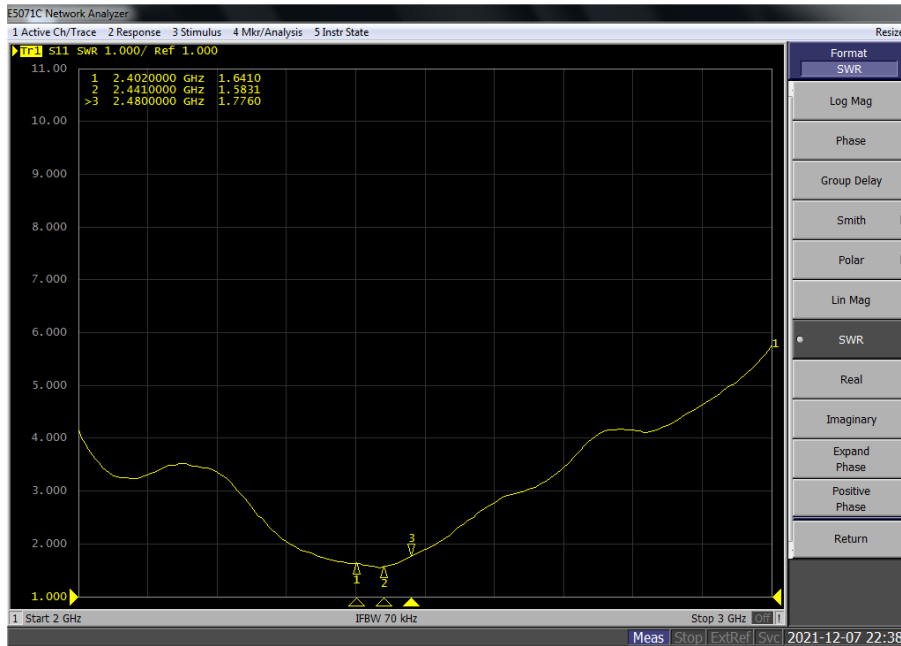

Free Space #1

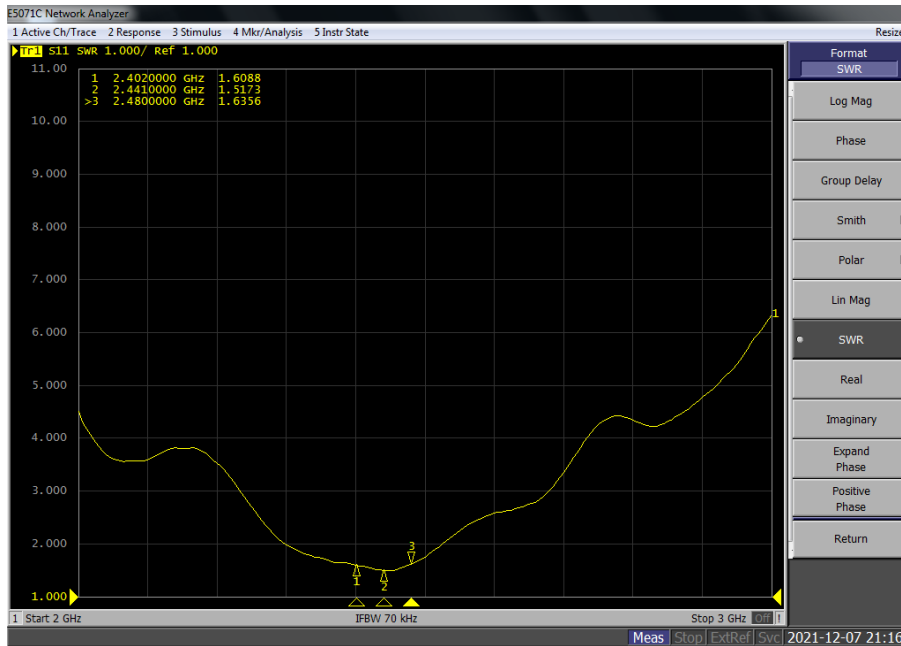

Beside Head #1



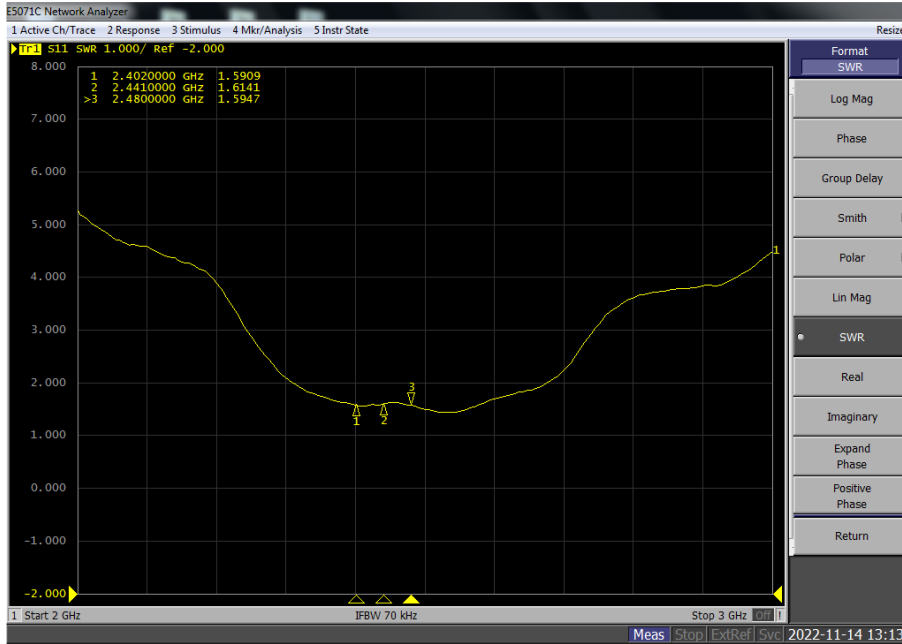

Beside Head #2

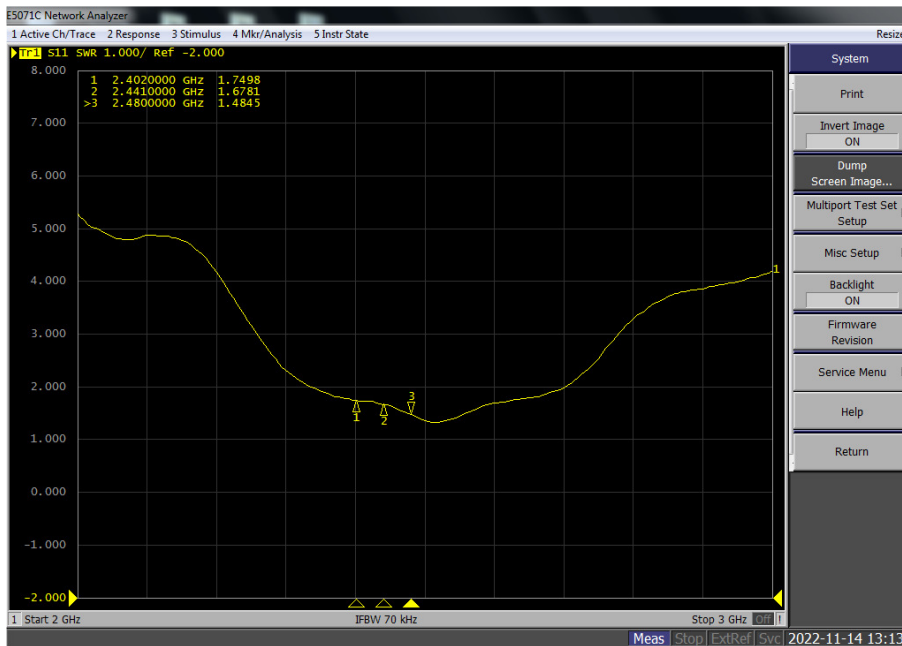

Beside Head #3



Unless otherwise agreed in writing, this document is issued by the Company subject to its General Conditions of Service printed overleaf, available on request or accessible at <http://www.sgs.com/en/Terms-and-Conditions.aspx> and, for electronic format documents, subject to Terms and Conditions for Electronic Documents at <http://www.sgs.com/en/Terms-and-Conditions/Terms-e-Documents.aspx>. Attention is drawn to the limitation of liability, indemnification and jurisdiction issues defined therein. Any holder of this document is advised that information contained hereon reflects the Company's findings at the time of its intervention only and within the limits of Client's instructions, if any. The Company's sole responsibility is to its Client and this document does not exonerate parties to a transaction from exercising all their rights and obligations under the transaction documents. This document cannot be reproduced except in full, without prior written approval of the Company. Any unauthorized alteration, forgery or falsification of the content or appearance of this document is unlawful and offenders may be prosecuted to the fullest extent of the law. Unless otherwise stated the results shown in this test report refer only to the sample(s) tested and such sample(s) are retained for 30 days only.

6.3 Stimulus

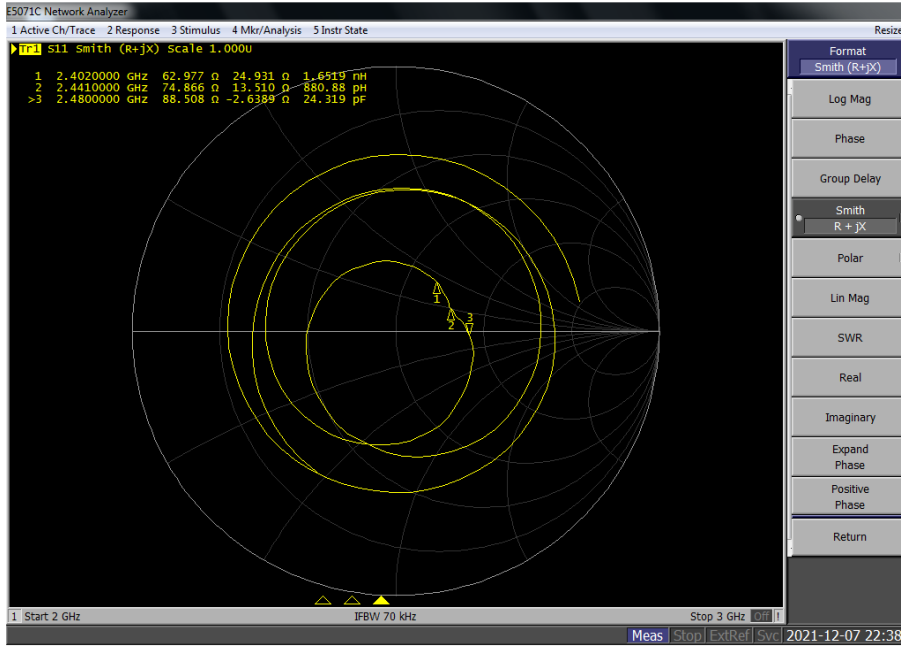

Free Space #1

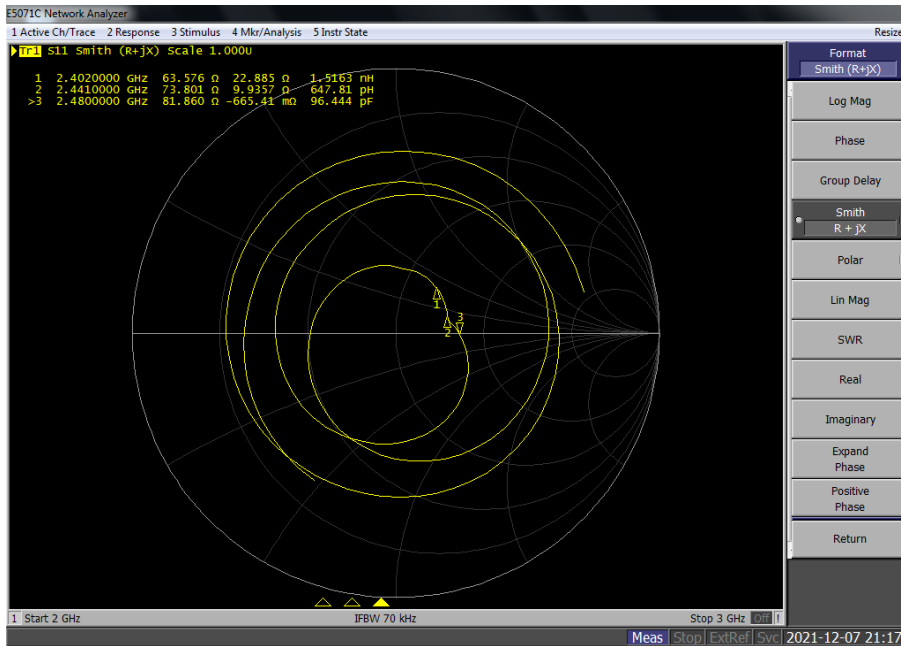

Beside Head #1



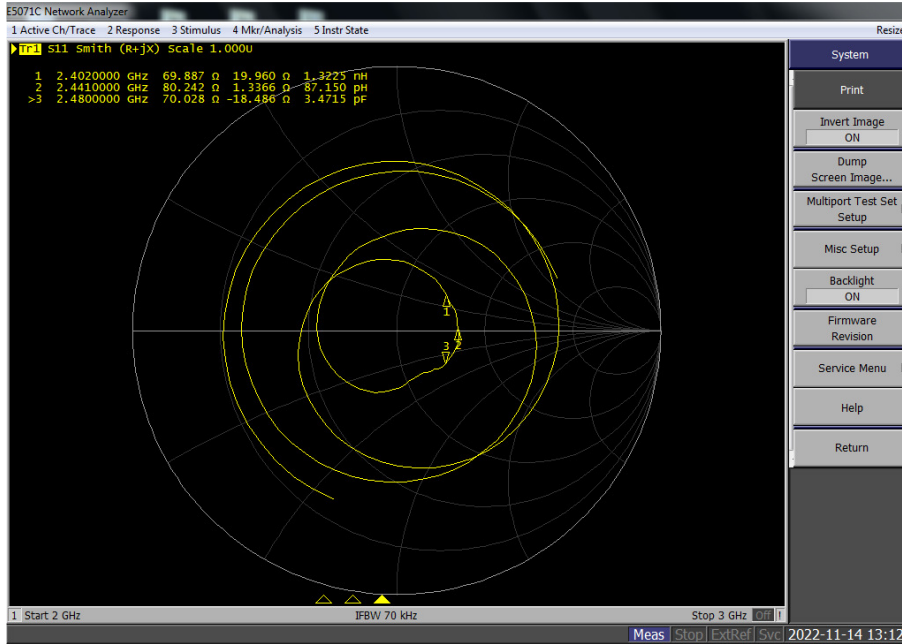

Beside Head #2

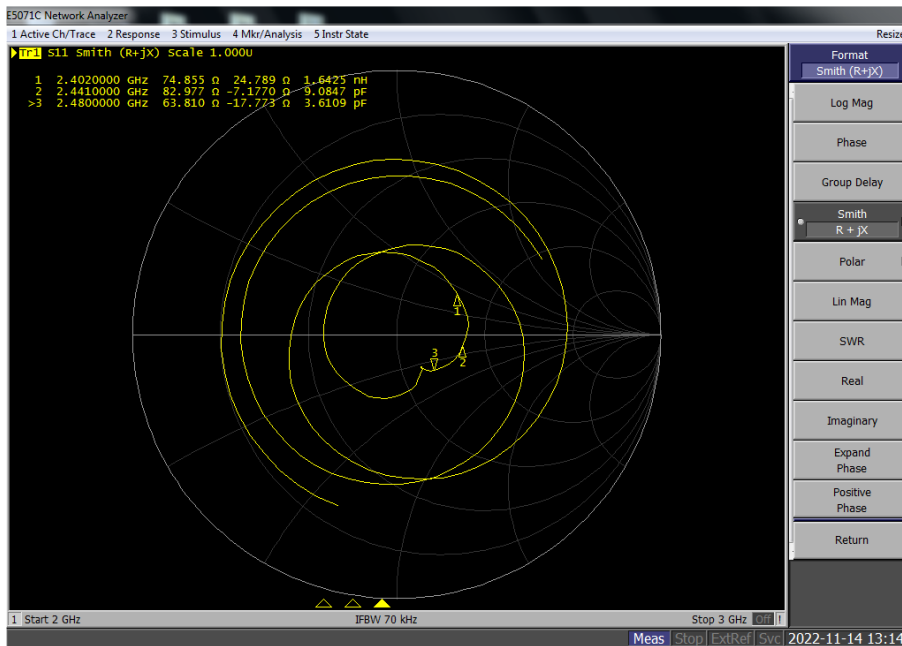

Beside Head #3



Unless otherwise agreed in writing, this document is issued by the Company subject to its General Conditions of Service printed overleaf, available on request or accessible at <http://www.sgs.com/en/Terms-and-Conditions.aspx> and, for electronic format documents, subject to Terms and Conditions for Electronic Documents at <http://www.sgs.com/en/Terms-and-Conditions/Terms-e-Documents.aspx>. Attention is drawn to the limitation of liability, indemnification and jurisdiction issues defined therein. Any holder of this document is advised that information contained hereon reflects the Company's findings at the time of its intervention only and within the limits of Client's instructions, if any. The Company's sole responsibility is to its Client and this document does not exonerate parties to a transaction from exercising all their rights and obligations under the transaction documents. This document cannot be reproduced except in full, without prior written approval of the Company. Any unauthorized alteration, forgery or falsification of the content or appearance of this document is unlawful and offenders may be prosecuted to the fullest extent of the law. Unless otherwise stated the results shown in this test report refer only to the sample(s) tested and such sample(s) are retained for 30 days only.

Attention: To check the authenticity of testing/inspection report & certificate, please contact us at telephone: (86-755) 8307 1443, or email: CN.Doccheck@sgs.com

7 2-D Antenna Pattern(Theta=90°)

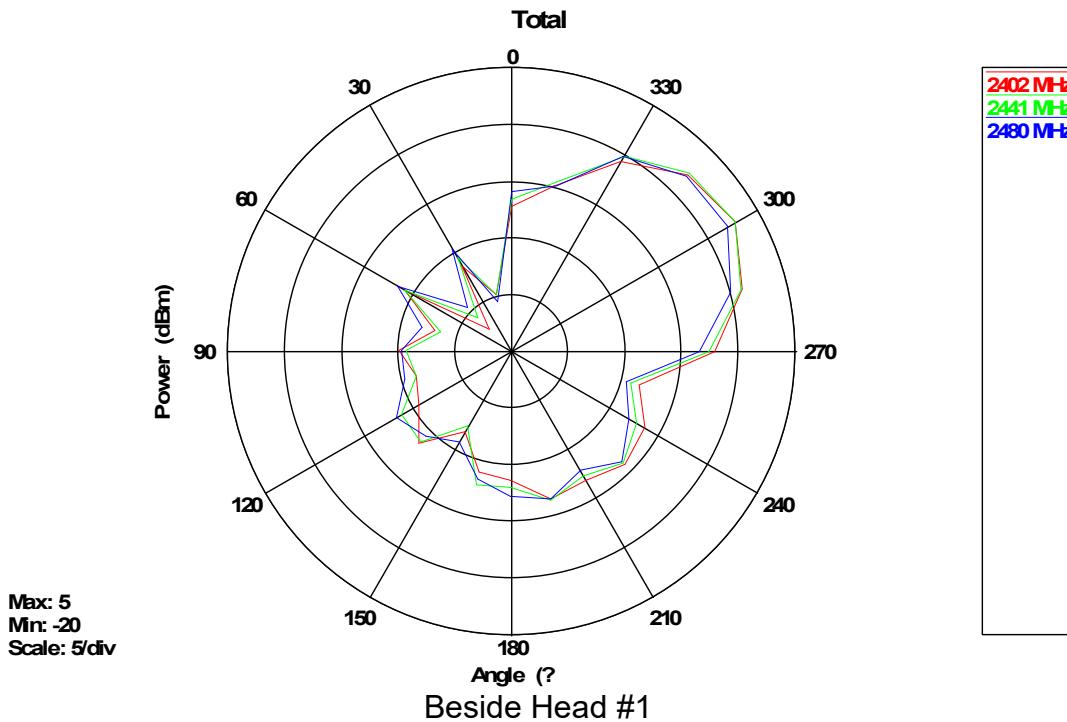
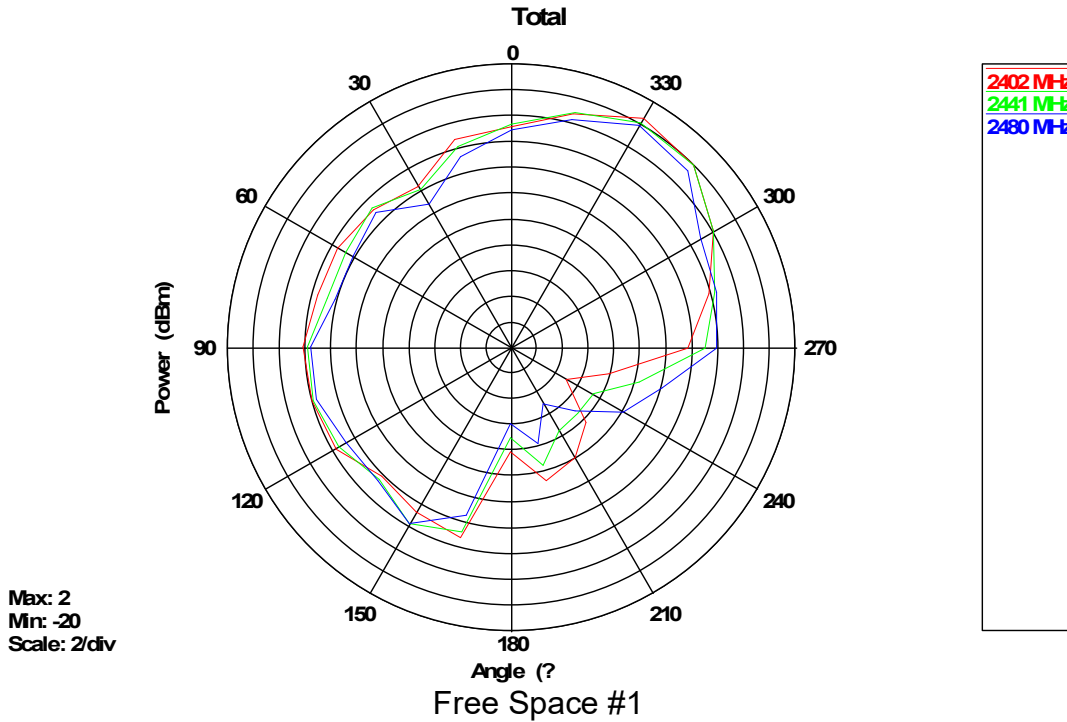

Unless otherwise agreed in writing, this document is issued by the Company subject to its General Conditions of Service printed overleaf, available on request or accessible at <http://www.sgs.com/en/Terms-and-Conditions.aspx> and, for electronic format documents, subject to Terms and Conditions for Electronic Documents at <http://www.sgs.com/en/Terms-and-Conditions/Terms-e-Documents.aspx>. Attention is drawn to the limitation of liability, indemnification and jurisdiction issues defined therein. Any holder of this document is advised that information contained hereon reflects the Company's findings at the time of its intervention only and within the limits of Client's instructions, if any. The Company's sole responsibility is to its Client and this document does not exonerate parties to a transaction from exercising all their rights and obligations under the transaction documents. This document cannot be reproduced except in full, without prior written approval of the Company. Any unauthorized alteration, forgery or falsification of the content or appearance of this document is unlawful and offenders may be prosecuted to the fullest extent of the law. Unless otherwise stated the results shown in this test report refer only to the sample(s) tested and such sample(s) are retained for 30 days only.

Attention: To check the authenticity of testing/inspection report & certificate, please contact us at telephone: (86-755) 8307 1443, or email: CN.Doccheck@sgs.com

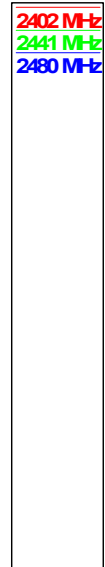
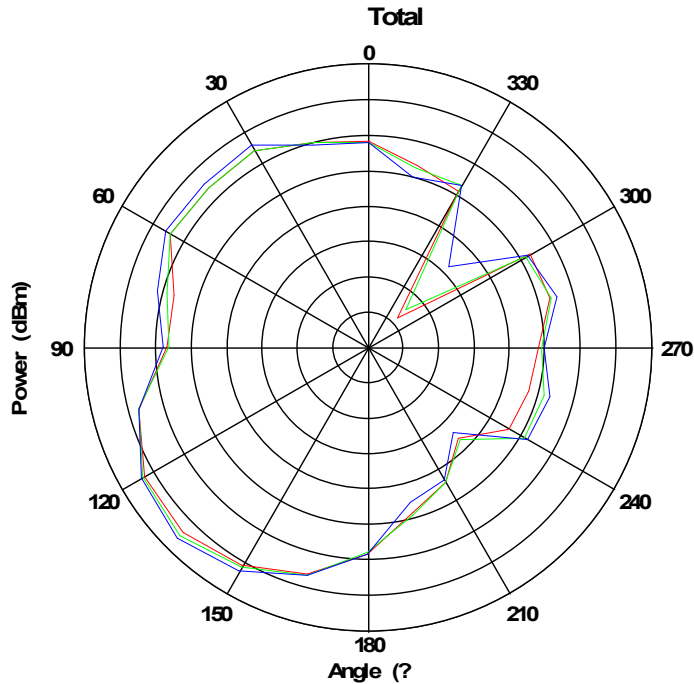
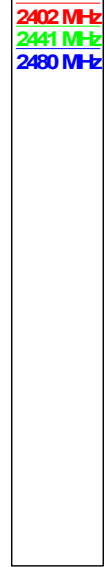
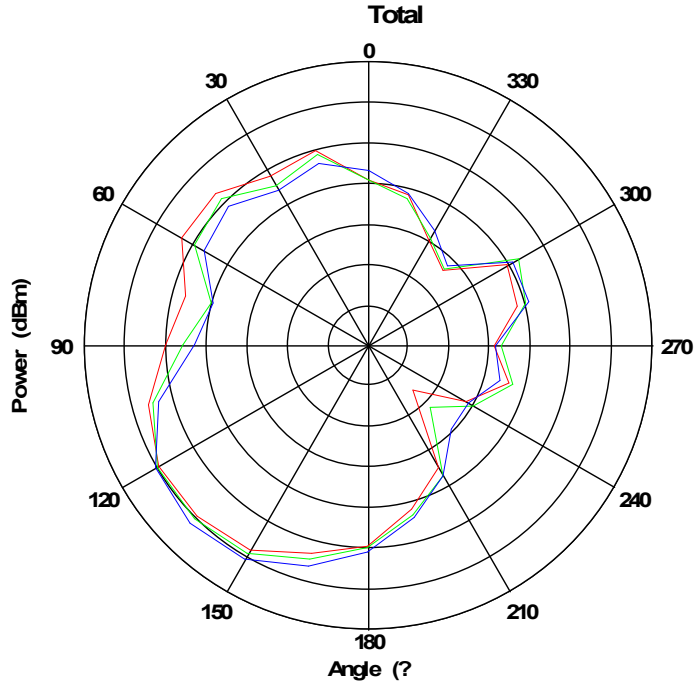

Unless otherwise agreed in writing, this document is issued by the Company subject to its General Conditions of Service printed overleaf, available on request or accessible at <http://www.sgs.com/en/Terms-and-Conditions.aspx> and, for electronic format documents, subject to Terms and Conditions for Electronic Documents at <http://www.sgs.com/en/Terms-and-Conditions/Terms-e-Documents.aspx>. Attention is drawn to the limitation of liability, indemnification and jurisdiction issues defined therein. Any holder of this document is advised that information contained hereon reflects the Company's findings at the time of its intervention only and within the limits of Client's instructions, if any. The Company's sole responsibility is to its Client and this document does not exonerate parties to a transaction from exercising all their rights and obligations under the transaction documents. This document cannot be reproduced except in full, without prior written approval of the Company. Any unauthorized alteration, forgery or falsification of the content or appearance of this document is unlawful and offenders may be prosecuted to the fullest extent of the law. Unless otherwise stated the results shown in this test report refer only to the sample(s) tested and such sample(s) are retained for 30 days only.

Attention: To check the authenticity of testing / inspection report & certificate, please contact us at telephone: (86-755) 8307 1443, or email: CN.Doccheck@sgs.com

8 3-D Antenna Pattern

Total

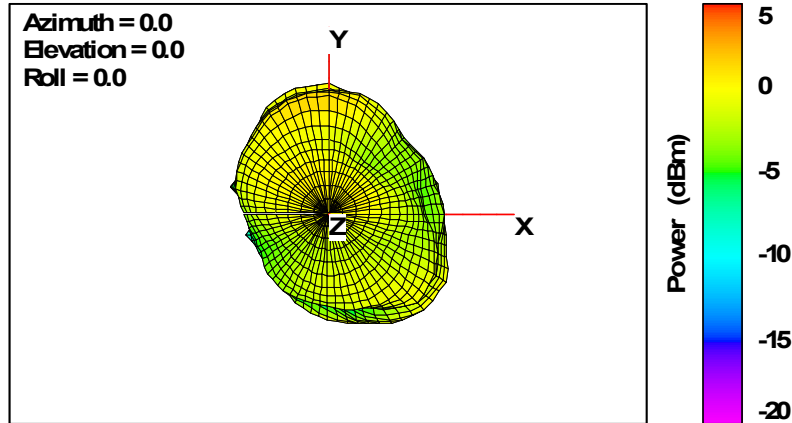

Total

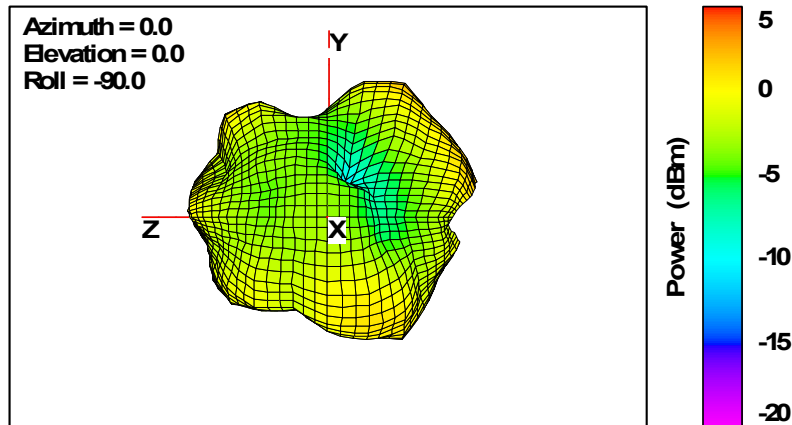

Total

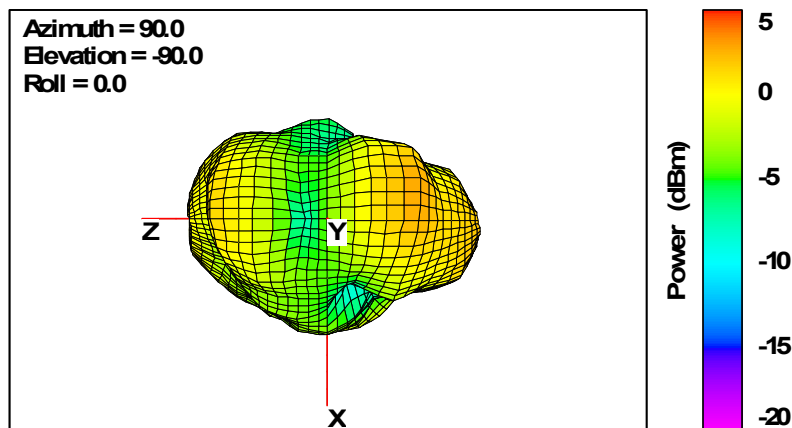

Free Space #1



Unless otherwise agreed in writing, this document is issued by the Company subject to its General Conditions of Service printed overleaf, available on request or accessible at <http://www.sgs.com/en/Terms-and-Conditions.aspx> and, for electronic format documents, subject to Terms and Conditions for Electronic Documents at <http://www.sgs.com/en/Terms-and-Conditions/Terms-e-Documents.aspx>. Attention is drawn to the limitation of liability, indemnification and jurisdiction issues defined therein. Any holder of this document is advised that information contained hereon reflects the Company's findings at the time of its intervention only and within the limits of Client's instructions, if any. The Company's sole responsibility is to its Client and this document does not exonerate parties to a transaction from exercising all their rights and obligations under the transaction documents. This document cannot be reproduced except in full, without prior written approval of the Company. Any unauthorized alteration, forgery or falsification of the content or appearance of this document is unlawful and offenders may be prosecuted to the fullest extent of the law. Unless otherwise stated the results shown in this test report refer only to the sample(s) tested and such sample(s) are retained for 30 days only.

Attention: To check the authenticity of testing/inspection report & certificate, please contact us at telephone: (86-755) 8307 1443, or email: CN.Doccheck@sgs.com

Total

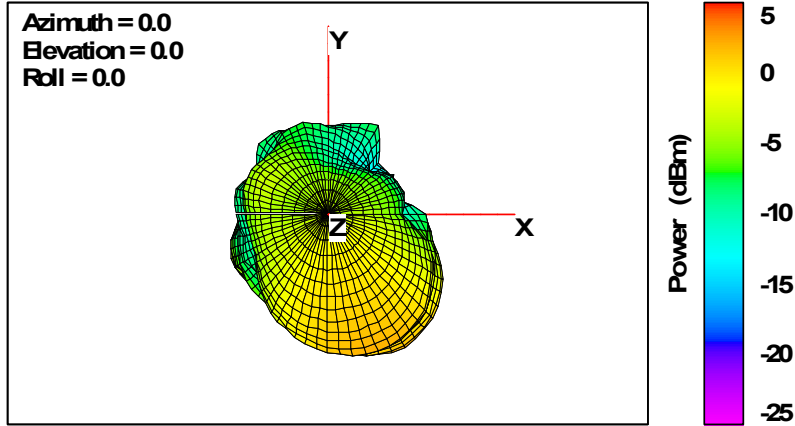

Total

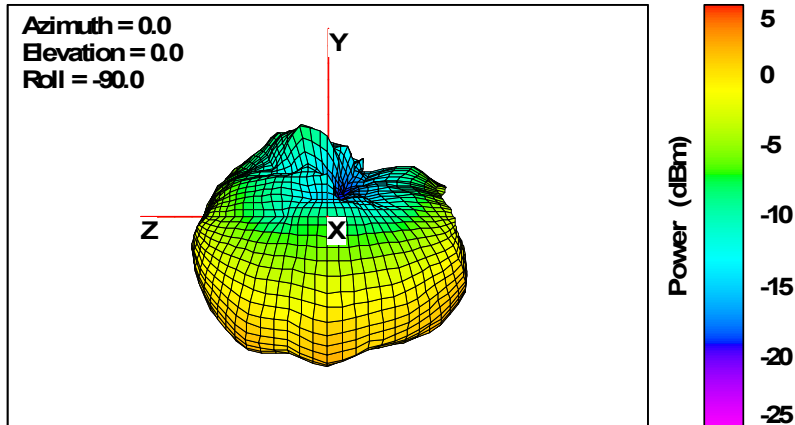

Total

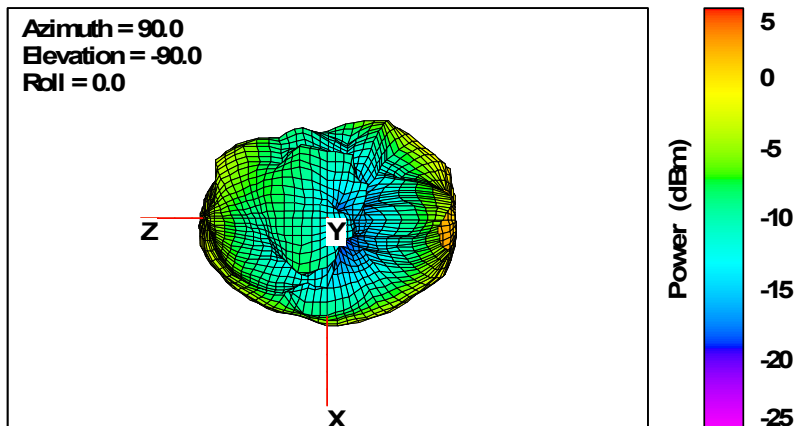

Beside Head #1



Unless otherwise agreed in writing, this document is issued by the Company subject to its General Conditions of Service printed overleaf, available on request or accessible at <http://www.sgs.com/en/Terms-and-Conditions.aspx> and, for electronic format documents, subject to Terms and Conditions for Electronic Documents at <http://www.sgs.com/en/Terms-and-Conditions/Terms-e-Documents.aspx>. Attention is drawn to the limitation of liability, indemnification and jurisdiction issues defined therein. Any holder of this document is advised that information contained hereon reflects the Company's findings at the time of its intervention only and within the limits of Client's instructions, if any. The Company's sole responsibility is to its Client and this document does not exonerate parties to a transaction from exercising all their rights and obligations under the transaction documents. This document cannot be reproduced except in full, without prior written approval of the Company. Any unauthorized alteration, forgery or falsification of the content or appearance of this document is unlawful and offenders may be prosecuted to the fullest extent of the law. Unless otherwise stated the results shown in this test report refer only to the sample(s) tested and such sample(s) are retained for 30 days only.

Attention: To check the authenticity of testing/inspection report & certificate, please contact us at telephone: (86-755) 8307 1443, or email: CN.Doccheck@sgs.com

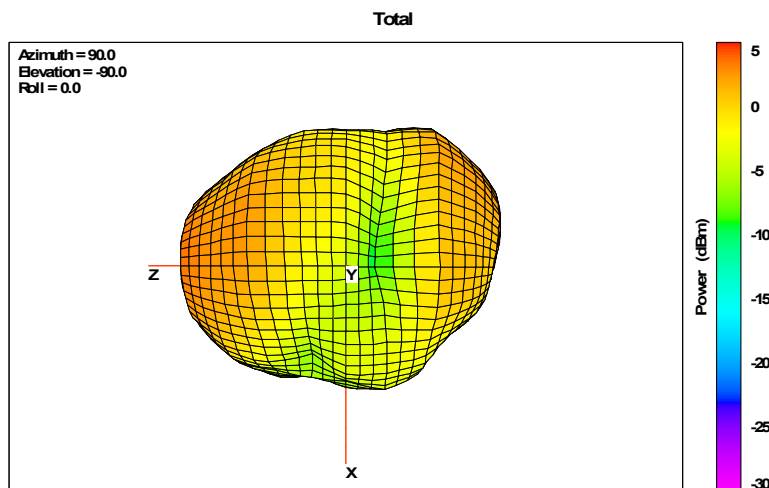
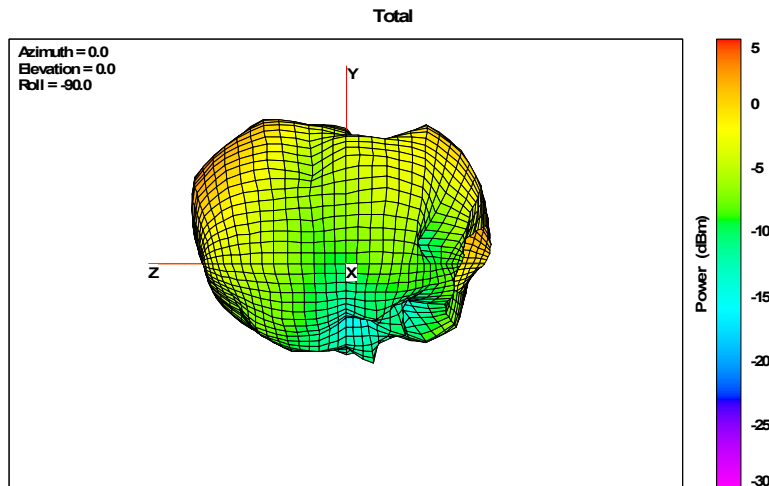
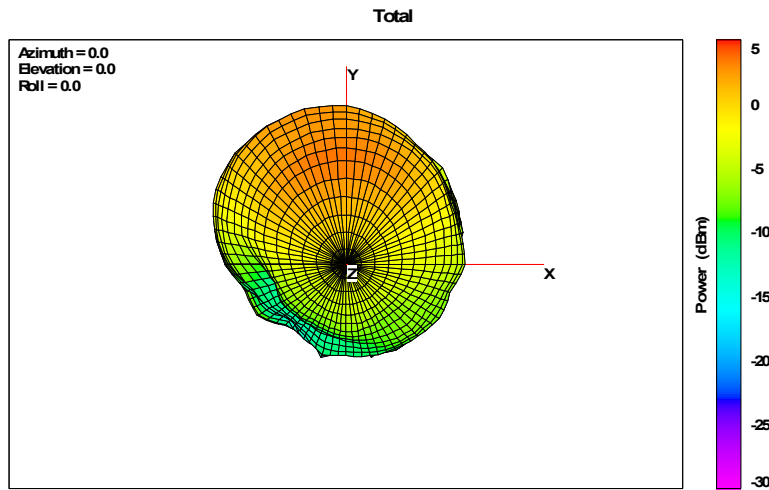

Beside Head #2



Unless otherwise agreed in writing, this document is issued by the Company subject to its General Conditions of Service printed overleaf, available on request or accessible at <http://www.sgs.com/en/Terms-and-Conditions.aspx> and, for electronic format documents, subject to Terms and Conditions for Electronic Documents at <http://www.sgs.com/en/Terms-and-Conditions/Terms-e-Documents.aspx>. Attention is drawn to the limitation of liability, indemnification and jurisdiction issues defined therein. Any holder of this document is advised that information contained hereon reflects the Company's findings at the time of its intervention only and within the limits of Client's instructions, if any. The Company's sole responsibility is to its Client and this document does not exonerate parties to a transaction from exercising all their rights and obligations under the transaction documents. This document cannot be reproduced except in full, without prior written approval of the Company. Any unauthorized alteration, forgery or falsification of the content or appearance of this document is unlawful and offenders may be prosecuted to the fullest extent of the law. Unless otherwise stated the results shown in this test report refer only to the sample(s) tested and such sample(s) are retained for 30 days only.

Attention: To check the authenticity of testing/inspection report & certificate, please contact us at telephone: (86-755) 8307 1443, or email: CN.Doccheck@sgs.com

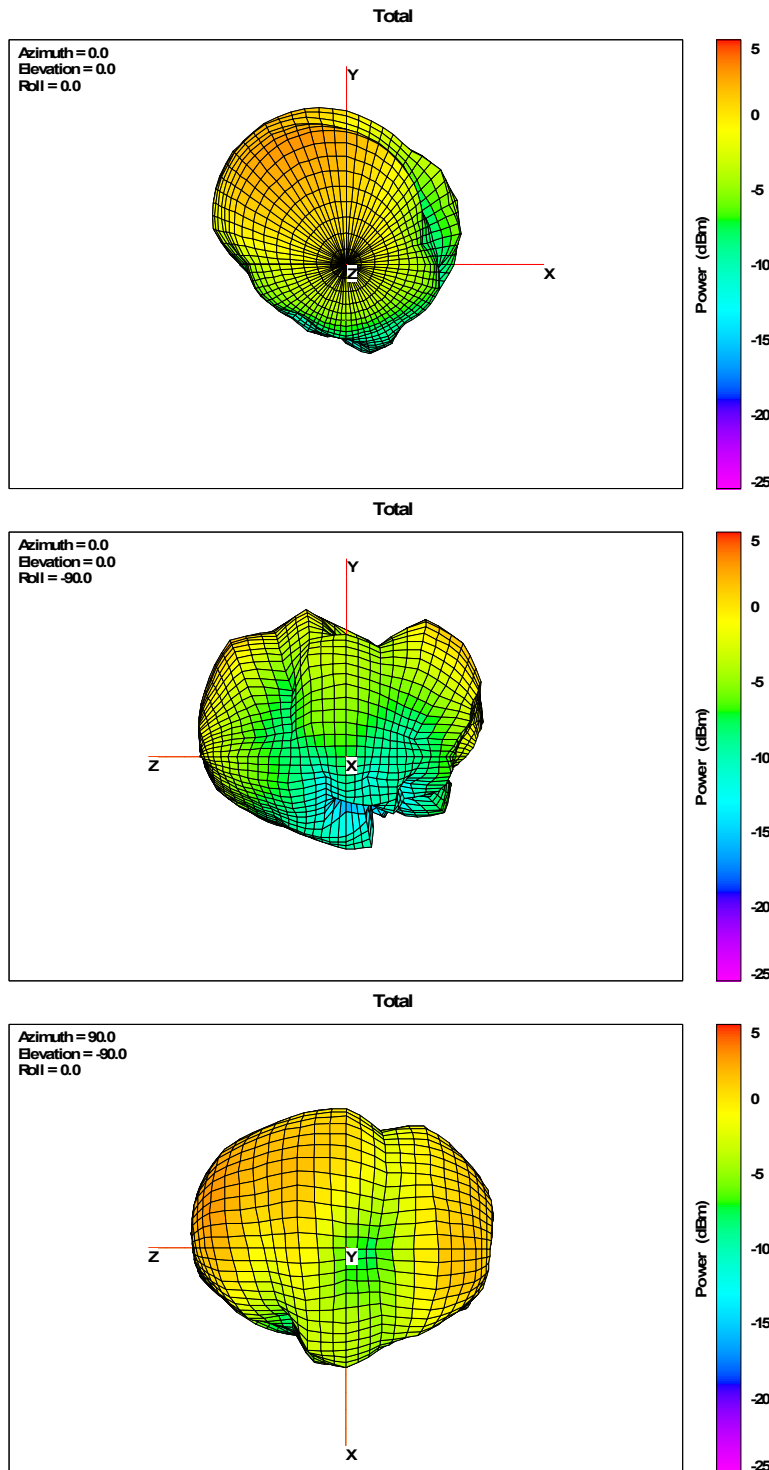

Beside Head #3



Unless otherwise agreed in writing, this document is issued by the Company subject to its General Conditions of Service printed overleaf, available on request or accessible at <http://www.sgs.com/en/Terms-and-Conditions.aspx> and, for electronic format documents, subject to Terms and Conditions for Electronic Documents at <http://www.sgs.com/en/Terms-and-Conditions/Terms-e-Documents.aspx>. Attention is drawn to the limitation of liability, indemnification and jurisdiction issues defined therein. Any holder of this document is advised that information contained hereon reflects the Company's findings at the time of its intervention only and within the limits of Client's instructions, if any. The Company's sole responsibility is to its Client and this document does not exonerate parties to a transaction from exercising all their rights and obligations under the transaction documents. This document cannot be reproduced except in full, without prior written approval of the Company. Any unauthorized alteration, forgery or falsification of the content or appearance of this document is unlawful and offenders may be prosecuted to the fullest extent of the law. Unless otherwise stated the results shown in this test report refer only to the sample(s) tested and such sample(s) are retained for 30 days only.

Attention: To check the authenticity of testing/inspection report & certificate, please contact us at telephone: (86-755) 8307 1443, or email: CN.Doccheck@sgs.com

9 The EUT and Test Configuration



Photo of EUT #1



Unless otherwise agreed in writing, this document is issued by the Company subject to its General Conditions of Service printed overleaf, available on request or accessible at <http://www.sgs.com/en/Terms-and-Conditions.aspx> and, for electronic format documents, subject to Terms and Conditions for Electronic Documents at <http://www.sgs.com/en/Terms-and-Conditions/Terms-e-Documents.aspx>. Attention is drawn to the limitation of liability, indemnification and jurisdiction issues defined therein. Any holder of this document is advised that information contained hereon reflects the Company's findings at the time of its intervention only and within the limits of Client's instructions, if any. The Company's sole responsibility is to its Client and this document does not exonerate parties to a transaction from exercising all their rights and obligations under the transaction documents. This document cannot be reproduced except in full, without prior written approval of the Company. Any unauthorized alteration, forgery or falsification of the content or appearance of this document is unlawful and offenders may be prosecuted to the fullest extent of the law. Unless otherwise stated the results shown in this test report refer only to the sample(s) tested and such sample(s) are retained for 30 days only.

Attention: To check the authenticity of testing / inspection report & certificate, please contact us at telephone: (86-755) 8307 1443, or email: CN.Doccheck@sgs.com

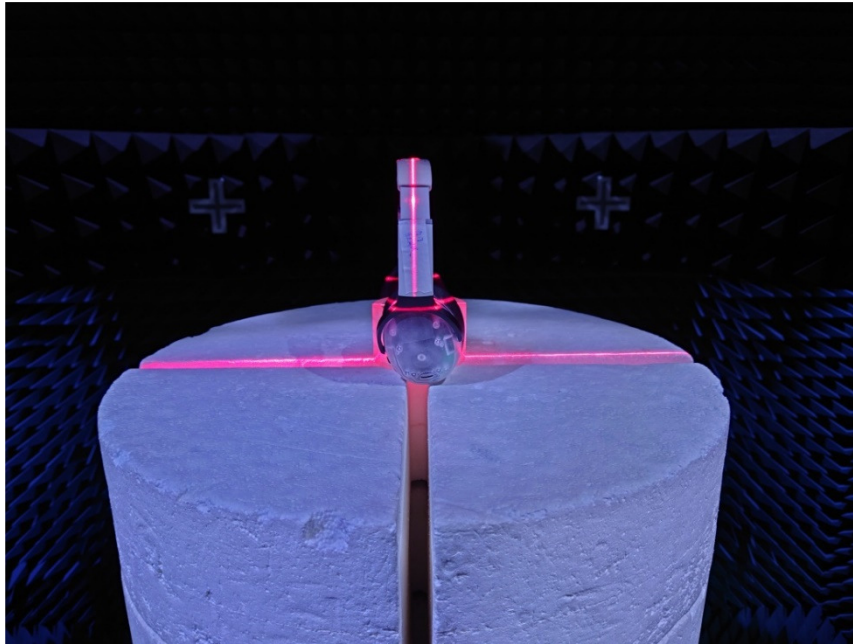

Photo of EUT #2

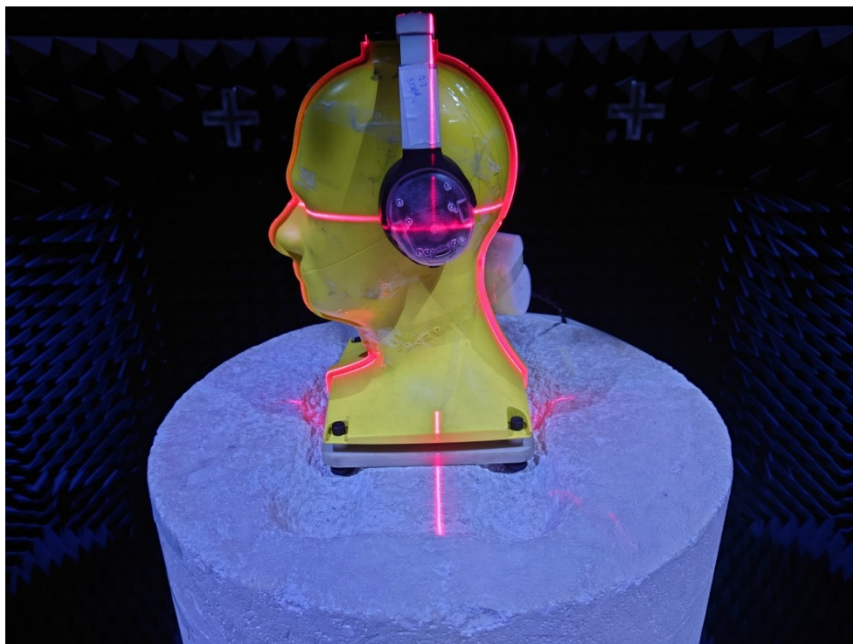

Photo of EUT #3





Free Space #1 View



Beside Head #1 View



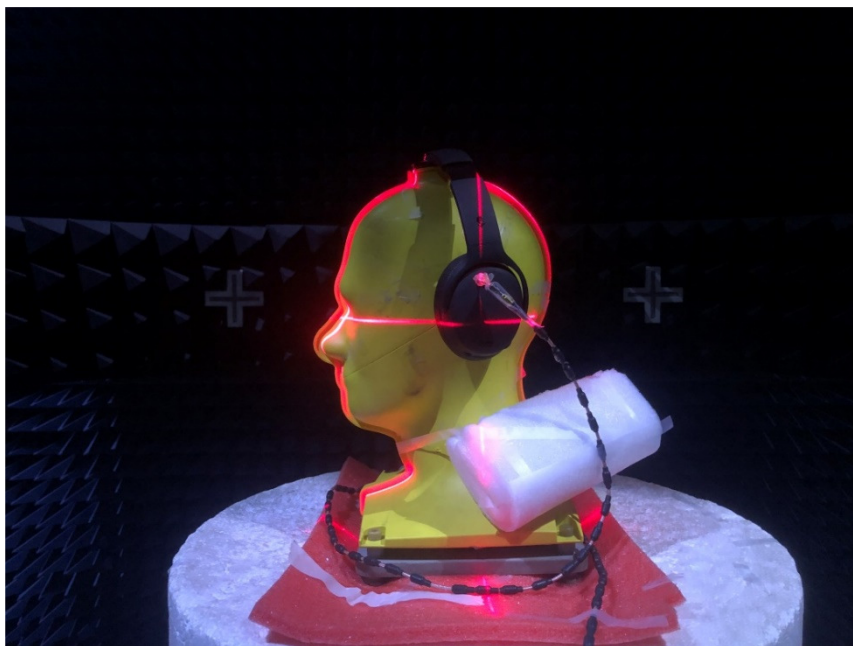

Beside Head #2 View

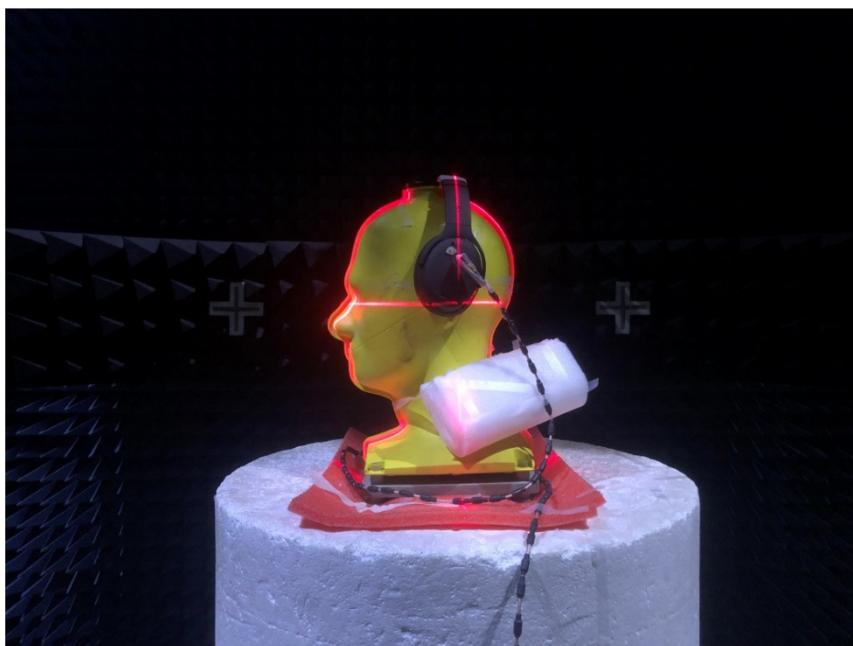

Beside Head #3 View



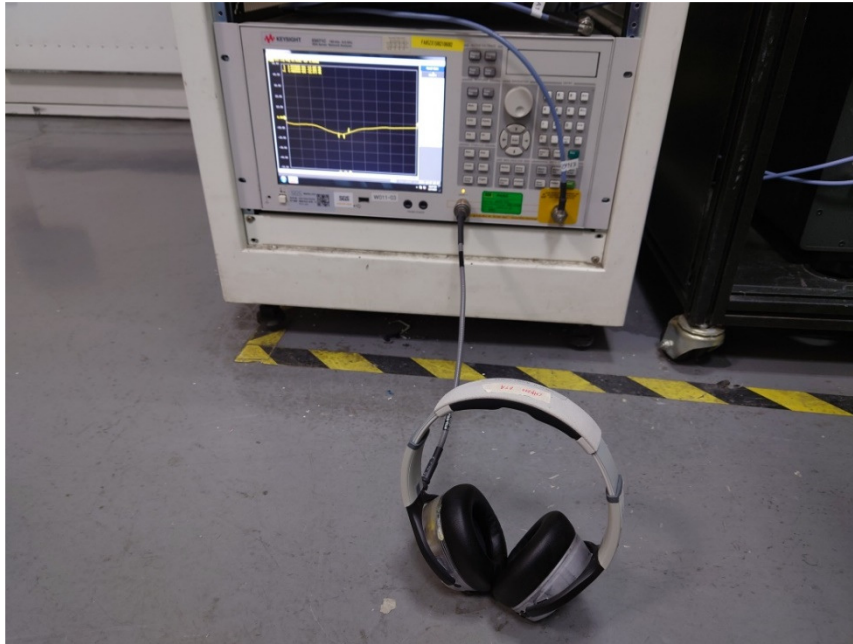

Free Space #1 Impedance Setup



Beside Head #1 Impedance Setup



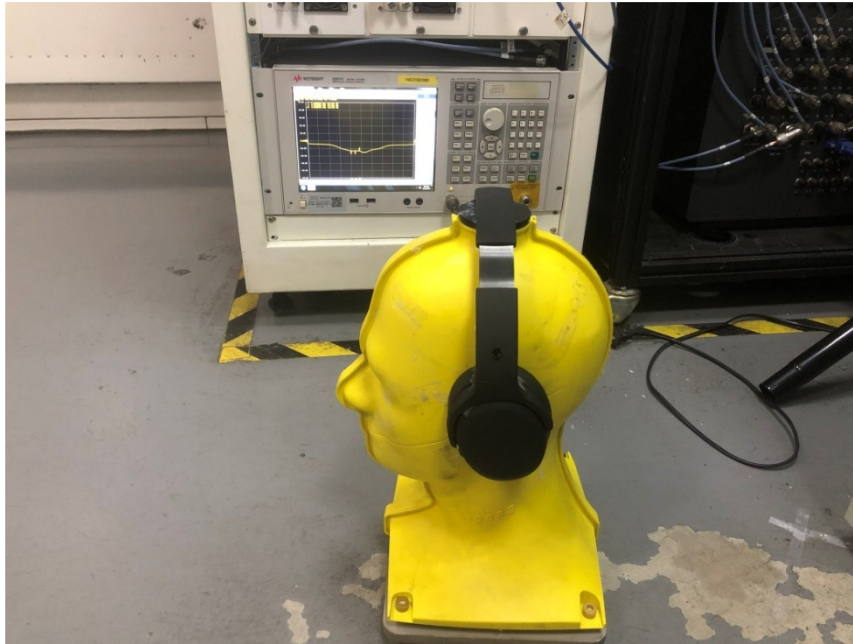

Beside Head #2 Impedance Setup

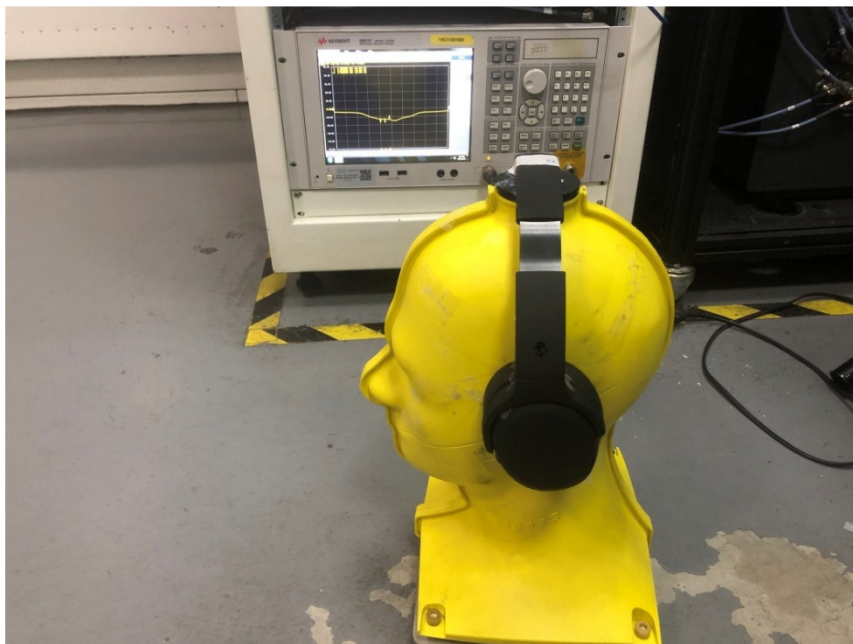

Beside Head #3 Impedance Setup

---END---

