

FCC TEST REPORT

Report No. : NTC-ER2205010
Applicant's name : ETI Solid State Lighting (Zhuhai) Ltd
Address : No.1, Zhongzhu Road South, Science & Technology
Innovation Coast, High Tech District, Zhuhai City,
Guangdong Prov., China

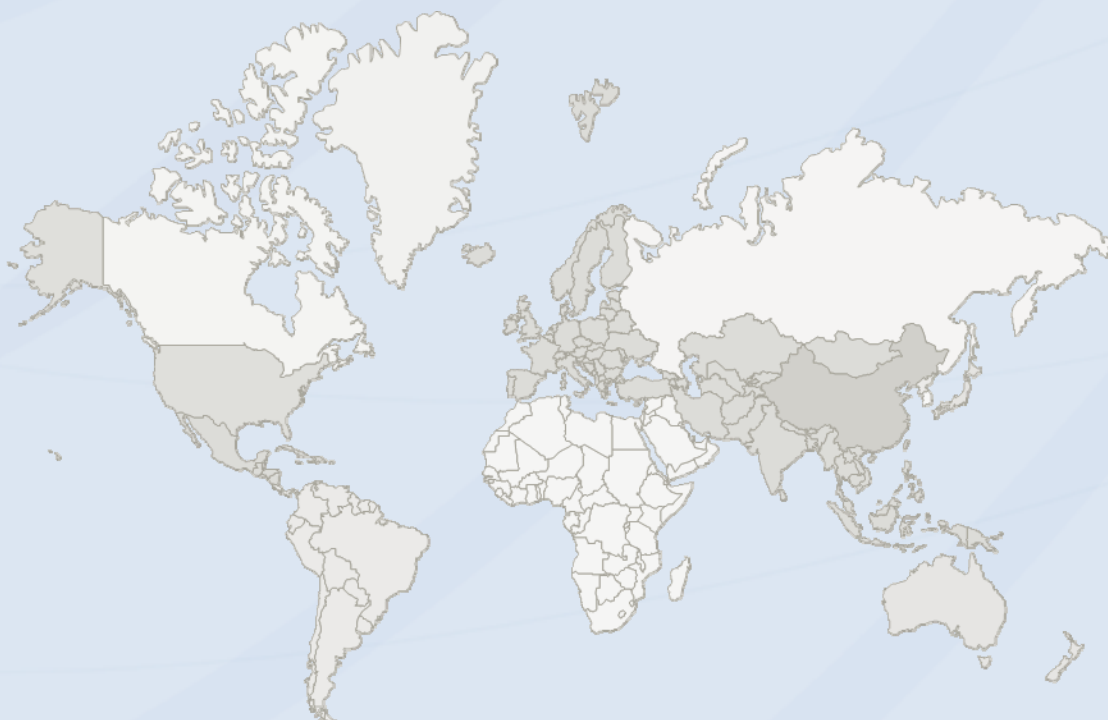

DONGGUAN NEW TESTING CENTRE CO., LTD

Address: 3F, No. 1 the 1st North Industry Road, Songshan Lake Science & Technology Park, Dongguan, Guangdong, China, 523808

Tel: +86-769-22212079

Web: <http://www.ntc-cert.com>

E-mail: dave@ntc-cert.com

TABLE OF CONTENTS

TEST REPORT DECLARE	3
1. Summary of test results	4
2. General test information.....	5
2.1. Detail models	7
2.2. Test Peripheral List.....	7
2.3. Block diagram EUT configuration for test.....	8
2.4. Test environment conditions	8
2.5. Measurement uncertainty	8
3. Power Line Conducted Emission Test.....	9
3.1. Test equipment.....	9
3.2. Block diagram of test setup	9
3.3. Power Line Conducted Emission Limits (Class B).....	9
3.4. Test Procedure	10
3.5. Test Result.....	10
4. Radiated emission test.....	13
4.1. Test equipment.....	13
4.2. Block diagram of test setup	14
4.3. Limit.....	16
4.4. Test Procedure	17
4.5. Test result.....	17
5. Output Power	26
5.1. Test equipment.....	26
5.2. Block diagram of test setup	26
5.3. Limit.....	26
5.4. Test Procedure	26
5.5. Test result.....	27
6. -6dB Bandwidth	33
6.1. Test equipment.....	33
6.2. Block diagram of test setup	33
6.3. Limit.....	33
6.4. Test Procedure	33
6.5. Test result.....	34
7. Band Edges Measurement	40
7.1. Test equipment.....	40
7.2. Block diagram of test setup	40
7.3. Limit.....	40

7.4.	Test Procedure	40
7.5.	Test result.....	41
8.	Conducted Spurious Emission.....	48
8.1.	Test equipment.....	48
8.2.	Block diagram of test setup	48
8.3.	Limit.....	48
8.4.	Test Procedure	48
8.5.	Test result.....	49
9.	Conducted Output Power Spectral Density	59
9.1.	Test equipment.....	59
9.2.	Block diagram of test setup	59
9.3.	Limit.....	59
9.4.	Test Procedure	59
9.5.	Test result.....	60
10.	Antenna Requirement.....	65
10.1.	Standard requirement.....	65
10.2.	EUT Antenna	65
11.	Test setup photograph	66
11.1.	Photos of power line conducted emission test	66
11.2.	Photos of radiated emission test.....	66
12.	Photos of the EUT.....	68

TEST REPORT DECLARE

FCC ID	:	XZH-CAHP-50XX02H
Applicant	:	ETI Solid State Lighting (Zhuhai) Ltd
Address	:	No.1, Zhongzhu Road South, Science & Technology Innovation Coast, High Tech District, Zhuhai City, Guangdong Prov., China
Equipment under Test	:	Air Purifier
Model No	:	CAHP-50WC02C, CAHP-50WG02C, CAHP-50GC02C, CAHP-50UG02C
Trade Mark	:	DH Lifelabs
Manufacturer	:	ETI Solid State Lighting (Zhuhai) Ltd
Address	:	No.1, Zhongzhu Road South, Science & Technology Innovation Coast, High Tech District, Zhuhai City, Guangdong Prov., China
Test Laboratory	:	Dongguan New Testing Centre Co., Ltd
Address	:	3F, No. 1 the 1st North Industry Road, Songshan Lake Science & Technology Park, Dongguan, Guangdong, China, 523808

Test Standard Used:

FCC Rules and Regulations Part 15 Subpart C: 15.247, ANSI C63.10:2020.

We Declare:

The equipment described above is tested by Dongguan New Testing Centre Co., Ltd and in the configuration tested the equipment complied with the standards specified above. The test results are contained in this test report and Dongguan New Testing Centre Co., Ltd is assumed of full responsibility for the accuracy and completeness of these tests.

After test and evaluation, our opinion is that the equipment provided for test compliance with the requirement of the above FCC standards.

Report No.:	NTC-ER2205010		
Date of Test:	May.10, 2022 to May.20, 2022	Date of Report:	May.23, 2022

Prepared By:

Jack Liu

Jack Liu/Engineer

Approved By:

Dave Gao

Dave Gao/LAB Manager

Note: This report applies to above tested sample only. This report shall not be reproduced in parts without written approval of Dongguan New Testing Centre Co., Ltd

1. Summary of test results

Description of Test Item	Standard	Results
Antenna Requirement	Section 15.247(c)	PASS
Conduction Emissions	Section 15.207(a)	PASS
Radiated Emissions	Section 15.247(d)	PASS
Carrier Frequencies Separated	Section 15.247(a)(1)	PASS
Hopping Channel Number	Section 15.247(a)(1) (iii)	PASS
Dwell Time	Section 15.247(a)(1) (iii)	PASS
Maximum Peak Output Power	Section 15.247(b)	PASS
Band edge	Section 15.247(d)	PASS
Conducted Spurious Emissions	Section 15.247(d)	PASS

2. General test information

Description of EUT

EUT* Name	:	Air Purifier
Test model	:	CAHP-50WC02C
EUT function description	:	Please reference user manual of this device
Power supply	:	AC 120V 50/60Hz
Operation frequency:	:	2412 MHz to 2462 MHz for 802.11b/g/n(HT20)
Number of Channels:	:	11 Channels for 802.11b/g/n(HT20)
Modulation Technology:	:	802.11b: CCK/QPSK/BPSK 802.11g/n: BPSK/QPSK/16QAM/64QAM
Transmit Data Rate:	:	802.11b :1/2/5.5/11 Mbps 802.11g :6/9/12/18/24/36/48/54 Mbps 802.11n(HT20): 7.2/14.4/21.7/28.9/43.3/57.8/65/72.2 Mbps
Channel Separation:	:	5 MHz
Antenna Type	:	PCB antenna
Gain:	:	maximum 1.98 dBi
H/W No.:	:	V1.0
S/W No.:	:	V1.0

Note: 1, EUT is the ab. of equipment under test.

Frequency list:

1. Test frequencies are lowest channel: 2412 MHz, middle channel: 2437 MHz and highest channel: 2462 MHz for 802.11b/g/n(HT20)

Channel	Frequency (MHz)	Channel	Frequency (MHz)
1	2412	7	2442
2	2417	8	2447
3	2422	9	2452
4	2427	10	2457
5	2432	11	2462
6	2437		

Description of test modes

No.	TEST Mode DESCRIPTION
1	Low channel TX
2	Middle channel TX
3	High channel TX
4	Keeping TX mode
Note: Transmit by 802.11b with Data rate (1/2/5.5/11) Transmit by 802.11g with Data rate (6/9/12/18/24/36/48/54) Transmit by 802.11n (20MHz) with Data rate (6.5/13/19.5/26/39/52/58.5/65)	

Note:

- 1.The EUT has been set to operate continuously on the lowest, middle and highest operation frequency Individually, and the EUT is operating at its maximum duty cycle>or equal 98%
2. All modes under which configure applicable have been tested and the worst mode test data recording in the test report, if no other mode data.
3. For Radiated Emission, 3 axis were chosen for testing for each applicable mode.

2.1. Detail models

Model	Rating	Note
CAHP-50WC02C	AC 120V 50/60Hz	N/A

Note: All the same except model name.

2.2. Test Peripheral List

No.	Equipment	Manufacturer	Model No.	Serial No.	Note
1	Notebook	Lenovo	ThinkPadE450	PF-0LRXDH	--

2.3. Block diagram EUT configuration for test

For EUT Tx mode:

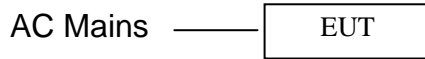

2.4. Test environment conditions

During the measurement the environmental conditions were within the listed ranges:

Temperature range:	21-24°C
Humidity range:	40-75%
Pressure range:	86-106kPa

2.5. Measurement uncertainty

Test Item	Uncertainty
Uncertainty for Conduction emission test	3.20 dB
Uncertainty for Radiation Emission test (30MHz – 1GHz)	4.60 dB (Polarize: V)
	4.60 dB (Polarize: H)
Uncertainty for Radiation Emission test (1GHz – 18GHz)	4.82 dB (Polarize: V)
	4.52 dB (Polarize: H)
Bandwidth	±1.2%
Stop Transmitting Time Test	±0.5%
Uncertainty for frequency error	5.8 x 10 ⁻⁸

Note: This uncertainty represents an expanded uncertainty expressed at approximately the 95% confidence level using a coverage factor of k=2.

3. Power Line Conducted Emission Test

3.1. Test equipment

Item	Equipment	Manufacturer	Model No.	Serial No.	Last Cal.	Cal. Interval
1	Test Receiver	R&S	ESPI	100146	2021-01-10	1 Year
2	LISN	R&S	ENV216	3650.6550.06	2021-05-21	1 Year
3	LISN	R&S	ENV4200	1107.2387.04	2021-05-21	1 Year
4	RF Cable	HUBER	SUCOFLEX100	30722/4E	2021-05-21	2 Year
5	MEASUREMENT SOFTWARE	FARAD	EZ-EMC(VER:1.1.4.2)	N/A	N/A	N/A

3.2. BLOCK DIAGRAM OF TEST SETUP

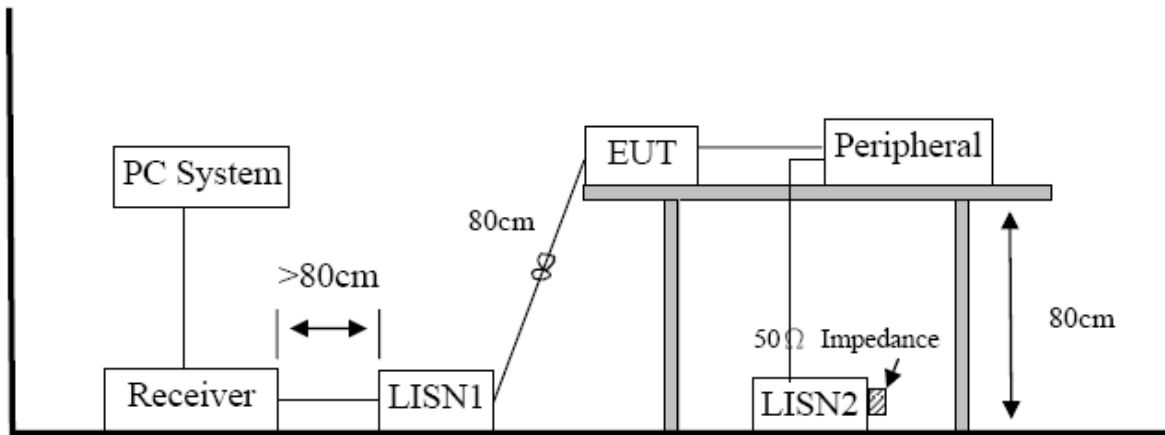

3.3. Power Line Conducted Emission Limits (Class B)

Frequency	Quasi-Peak Level dB(μV)	Average Level dB(μV)
150kHz ~ 500kHz	66 ~ 56*	56 ~ 46*
500kHz ~ 5MHz	56	46
5MHz ~ 30MHz	60	50

Note 1: * Decreasing linearly with logarithm of frequency.

Note 2: The lower limit shall apply at the transition frequencies.

3.4. Test Procedure

The EUT and Support equipment, if needed, were put placed on a non-metallic table, 80cm above the ground plane.

Configuration EUT to simulate typical usage as described in clause 2.3 and test equipment as described in clause 3.2 of this report.

All I/O cables were positioned to simulate typical actual usage as per ANSI C63.10.

All support equipment power received from a second LISN.

Emissions were measured on each current carrying line of the EUT using an EMI Test Receiver connected to the LISN powering the EUT.

The Receiver scanned from 150 kHz to 30MHz for emissions in each of the test modes.

During the above scans, the emissions were maximized by cable manipulation.

The test mode(s) described in clause 2.3 were scanned during the preliminary test.

After the preliminary scan, we found the test mode producing the highest emission level.

The EUT configuration and worse cable configuration of the above highest emission levels were recorded for reference of the final test.

EUT and support equipment were set up on the test bench as per the configuration with highest emission level in the preliminary test.

A scan was taken on both power lines, Neutral and Line, recording at least the six highest emissions. Emission frequency and amplitude were recorded into a computer in which correction factors were used to calculate the emission level and compare reading to the applicable limit.

The test data of the worst-case condition(s) was recorded.

The bandwidth of test receiver is set at 9 KHz.

3.5. Test Result

PASS. (See below detailed test result)

Note1: All emissions not reported below are too low against the prescribed limits.

Note2: “-----” means Peak detection; “-----” means Average detection

Note3: Measurement = Reading Level + Factor, Margin= Measurement-Limit

Conducted Emission Test Result

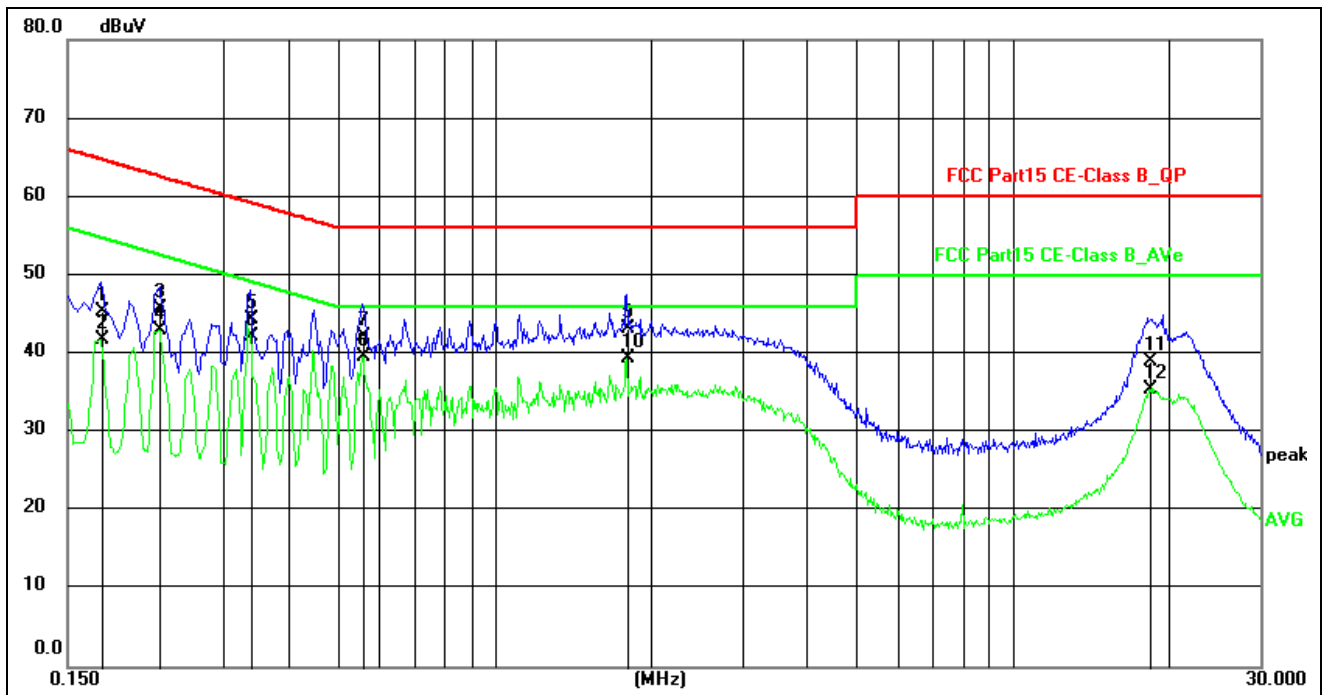

Site:	844LAB	Phase:L1	Temperature(C):24(C)
Limit:	FCC Part15 CE-Class B_QP		Humidity(%):63%
EUT:	Air Purifier	Test Time:	2022/5/23 10:09:21
M/N.:	CAHP-50WC02C	Power Rating:	AC120V/60Hz
Mode:	High gears with Tx mode	Test Engineer:	
Note:	(802.11 b 2412MHz-Worst case)		

No.	Frequency (MHz)	Reading Level(dBuV)	Factor (dB)	Measure-ment(dBuV)	Limit (dBuV)	Margin (dB)	Detector	Comment
1	0.1740	34.99	10.29	45.28	64.77	-19.49	QP	
2	0.1740	31.40	10.29	41.69	54.77	-13.08	AVG	
3	0.2260	35.39	10.32	45.71	62.60	-16.89	QP	
4	0.2260	32.70	10.32	43.02	52.60	-9.58	AVG	
5	0.3379	34.10	10.34	44.44	59.25	-14.81	QP	
6	0.3379	31.83	10.34	42.17	49.25	-7.08	AVG	
7	0.5580	31.82	10.38	42.20	56.00	-13.80	QP	
8 *	0.5580	29.27	10.38	39.65	46.00	-6.35	AVG	
9	1.8020	32.81	10.44	43.25	56.00	-12.75	QP	
10	1.8020	29.01	10.44	39.45	46.00	-6.55	AVG	
11	18.3660	28.57	10.47	39.04	60.00	-20.96	QP	
12	18.3660	24.97	10.47	35.44	50.00	-14.56	AVG	

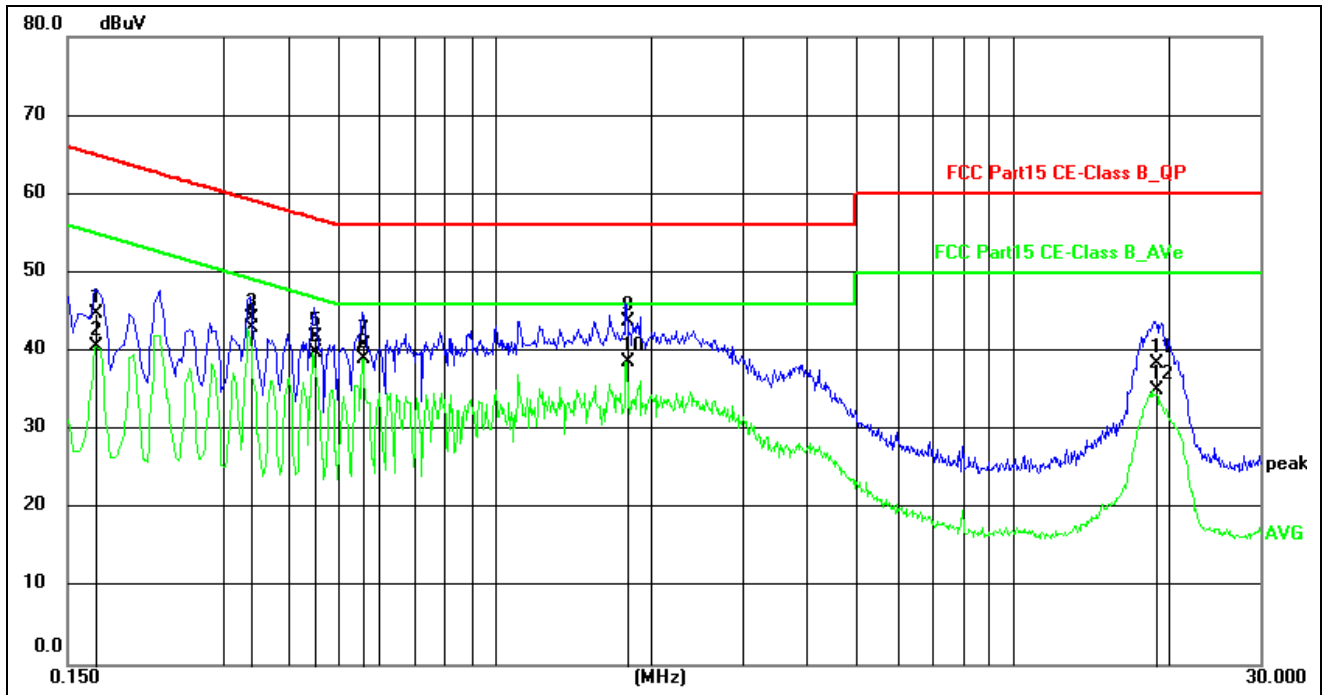

Site:	844LAB	Phase:N	Temperature(C):24(C)
Limit:	FCC Part15 CE-Class B_QP		Humidity(%):63%
EUT:	Air Purifier	Test Time:	2022/5/23 10:12:41
M/N.:	CAHP-50WC02C	Power Rating:	AC120V/60Hz
Mode:	High gears with Tx mode	Test Engineer:	
Note:	(802.11 b 2412MHz-Worst case)		

No.	Frequency (MHz)	Reading Level(dBuV)	Factor (dB)	Measure-ment(dBuV)	Limit (dBuV)	Margin (dB)	Detector	Comment
1	0.1700	35.24	9.62	44.86	64.96	-20.10	QP	
2	0.1700	31.00	9.62	40.62	54.96	-14.34	AVG	
3	0.3379	34.49	9.65	44.14	59.25	-15.11	QP	
4 *	0.3379	33.35	9.65	43.00	49.25	-6.25	AVG	
5	0.4500	32.12	9.65	41.77	56.88	-15.11	QP	
6	0.4500	30.11	9.65	39.76	46.88	-7.12	AVG	
7	0.5580	31.14	9.65	40.79	56.00	-15.21	QP	
8	0.5580	29.38	9.65	39.03	46.00	-6.97	AVG	
9	1.8020	34.14	9.71	43.85	56.00	-12.15	QP	
10	1.8020	28.91	9.71	38.62	46.00	-7.38	AVG	
11	18.9020	28.22	10.10	38.32	60.00	-21.68	QP	
12	18.9020	24.99	10.10	35.09	50.00	-14.91	AVG	

4. Radiated emission test

4.1. Test equipment

Item	Equipment	Manufacturer	Model No.	Serial No.	Last Cal.	Cal. Interval
1	EMI Test Receiver	R&S	ESR	7250-30406 7528	2021-05-26	1 Year
2	Trilog Broadband Antenna	Schwarzbeck	VULB9168	00969	2021-06-16	2 Year
3	Pre-amplifier	R&S	8447F	3113A04553	2021-05-26	1 Year
4	Active Loop antenna	Schwarzbeck	FMZB-1519	1519-038	2021-05-26	1 Year
5	Horn antenna	Schwarzbeck	BBHA9120D	453	2021-05-25	2 Year
6	Double Ridged Horn Antenna	A.H. System	SAS-574	584	2021-05-25	1 Year
7	Pre-amplifier	R&S	SCU18	105326	2021-05-26	1 Year
8	RF Cable	GORE	OSQ01Q010 78.7	SN1545847 3	2021-05-26	1 Year
9	RF Cable	GORE	OSQ01Q010 78.7	SN1545847 4	2021-05-26	1 Year
10	RF Cable	ESCO	ETS-LINGR EN	RFC-SMS-1 00-SMS-340 -IN	2021-05-26	1 Year
11	Measurement software	Farad	EZ-EMC(VE R:1.1.4.2)	N/A	N/A	N/A

4.2. Block diagram of test setup

In 3m Anechoic Chamber Test Setup Diagram for 9KHz to 30MHz:

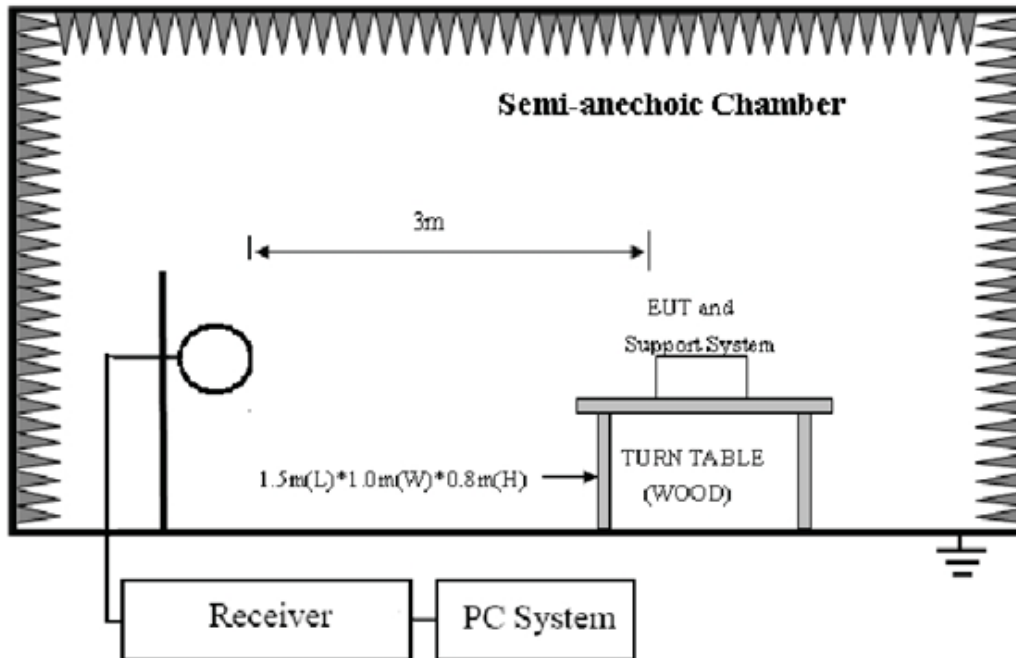

In 3m Anechoic Chamber Test Setup Diagram for 30MHz to 1GHz:

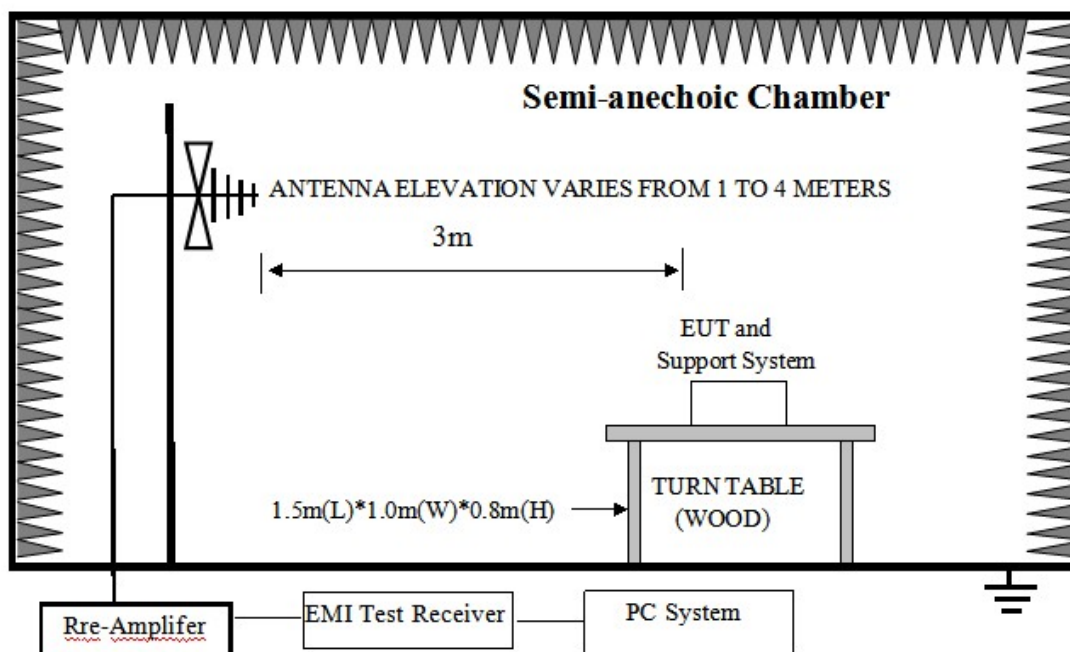

In 3m Anechoic Chamber Test Setup Diagram for frequency above 1GHz:

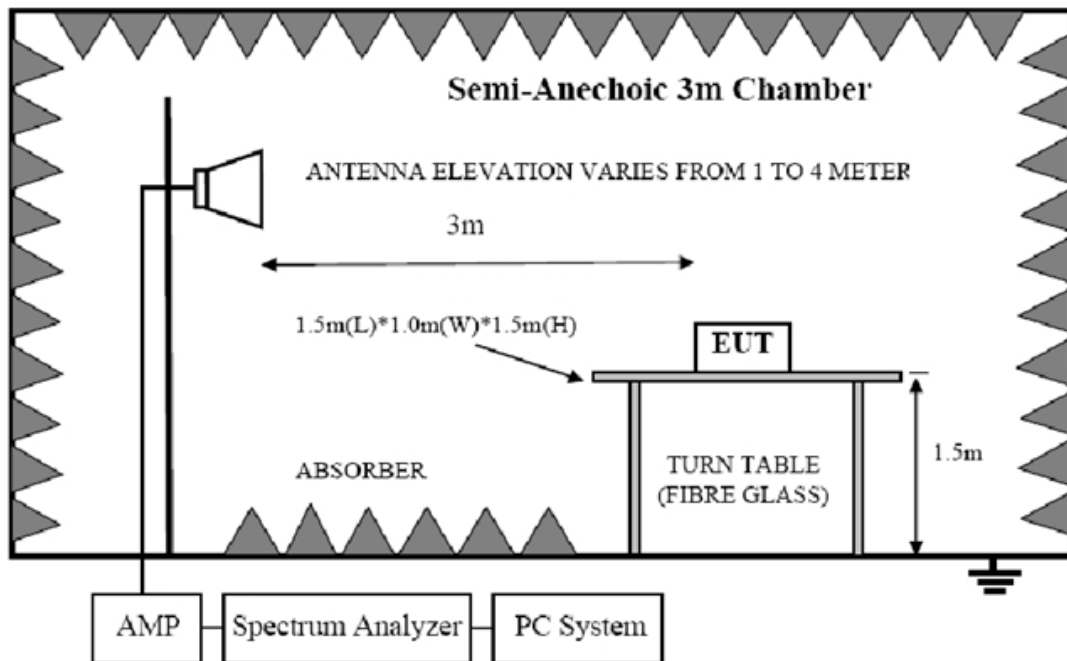

4.3. Limit

FCC 15.205 Restricted frequency band:

MHz	MHz	MHz	GHz
0.090 - 0.110	16.42 - 16.423	399.9 - 410	4.5 - 5.15
¹ 0.495 - 0.505	16.69475 - 16.69525	608 - 614	5.35 - 5.46
2.1735 - 2.1905	16.80425 - 16.80475	960 - 1240	7.25 - 7.75
4.125 - 4.128	25.5 - 25.67	1300 - 1427	8.025 - 8.5
4.17725 - 4.17775	37.5 - 38.25	1435 - 1626.5	9.0 - 9.2
4.20725 - 4.20775	73 - 74.6	1645.5 - 1646.5	9.3 - 9.5
6.215 - 6.218	74.8 - 75.2	1660 - 1710	10.6 - 12.7
6.26775 - 6.26825	108 - 121.94	1718.8 - 1722.2	13.25 - 13.4
6.31175 - 6.31225	123 - 138	2200 - 2300	14.47 - 14.5
8.291 - 8.294	149.9 - 150.05	2310 - 2390	15.35 - 16.2
8.362 - 8.366	156.52475 - 156.52525	2483.5 - 2500	17.7 - 21.4
8.37625 - 8.38675	156.7 - 156.9	2690 - 2900	22.01 - 23.12
8.41425 - 8.41475	162.0125 - 167.17	3260 - 3267	23.6 - 24.0
12.29 - 12.293	167.72 - 173.2	3332 - 3339	31.2 - 31.8
12.51975 - 12.52025	240 - 285	3345.8 - 3358	36.43 - 36.5
12.57675 - 12.57725	322 - 335.4	3600 - 4400	(²)

FCC 15.109 Limit

Frequency (MHz)	Distance (Meters)	Field Strengths Limits dB(μV)/m
30--88	3	40.0
88--216	3	43.5
216--960	3	46.0
960--1000	3	54.0
Above 1GHz	3	Peak: 74.0
	3	Average:54.0

Note: (1) The smaller limit shall apply at the cross point between two frequency bands.

(2)Distance is the distance in meters between the measuring instrument, antenna and the closest point of any part of the device or system.

(3)The emission limits shown in the above table are based on measurements employing a CISPR QP detector except for the frequency bands 9-90KHz, 110-490KHz and above 1000MHz.Radiated emissions limits in these three bands are based on measurements employing an average detector.

(4) At frequencies below 30MHz, measurement may be performed at a distance closer then that specified, and the limit at closer measurement distance can be extrapolated by below formula:

$$\text{Limit } 3\text{m}(\text{dB}\mu\text{V}/\text{m}) = \text{Limit } 30\text{m}(\text{dB}\mu\text{V}/\text{m}) + 40\text{Log}(30\text{m}/3\text{m})$$

(5)All the emissions appearing within 15.205 restricted frequency bands shall not exceed the limits shown in 15.109, all the other emissions shall be at least 20dB below the fundamental emissions, or comply with 15.109 limits.

4.4. Test Procedure

Procedure of Preliminary Test

Configuration EUT to simulate typical usage as described in clause 2.3 and test equipment as described in clause 4.2 of this report.

Mains cables, telephone lines or other connections to auxiliary equipment located outside the test are shall drape to the floor, be fitted with ferrite clamps or ferrite tubes placed on the floor at the point where the cable reaches the floor and then routed to the place where they leave the turntable. No extension cords shall be used to mains receptacle.

EUT height should be 0.8m for below 1GHz and 1.5m for above 1GHz at ground with absorbers.

The antenna was placed at 3 meter away from the EUT as stated in ANSI C63.10. The antenna connected to the Spectrum Analyzer via a cable and at times a pre-amplifier would be used.

The Analyzer / Receiver quickly scanned from 30MHz to 18GHz. The EUT test program was started. Emissions were scanned and measured rotating the EUT to 360 degrees and positioning the antenna 1 to 4 meters above the ground plane, in both the vertical and the horizontal polarization, to maximize the emission reading level.

The X, Y, Z three axial are tested and the report only the worst case.

The emissions from 9KHz to 1GHz, QP or average values were measured with EMI receiver with below RBW:

Frequency band	RBW
9KHz-150KHz	200Hz
150KHz-30MHz	9KHz
30MHz-1GHz	120KHz

For emissions above 1GHz, both Peak and Average level were measured with Spectrum Analyzer, and the RBW is set at 1MHz, VBW is set at 3MHz for Peak measure; RMS detector RBW 1MHz VBW 3MHz for Average measure.

4.5. Test result

PASS. (See below detailed test result)

Radiated Emissions Test Data Below 30MHz:

No emission found between lowest internal used/generated frequencies to 30MHz.

Radiated Emission Test Result

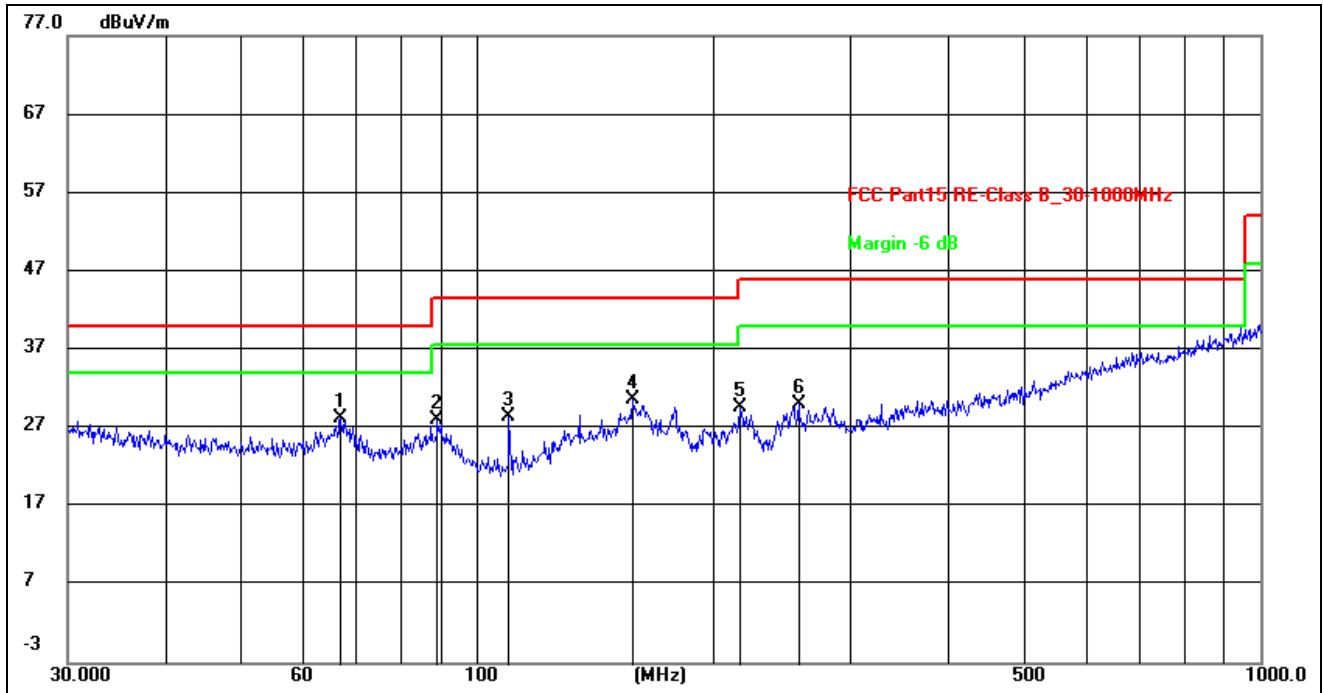

Site:	966LAB	Antenna::	Horizontal	Temperature(C):	24(C)
Limit:	FCC Part15 RE-Class B_30-1000MHz			Humidity(%):	60%
EUT:	Air Purifier	Test Time:	2022/5/20 8:49:48		
M/N.:	CAHP-50WC02C	Power Rating:	AC 120V/60Hz		
Mode:	High gears with Tx mode	Test Engineer:			
Note:	(802.11 b 2412MHz-Worst case)				

No.	Frequency (MHz)	Reading (dBuV)	Factor (dB/m)	Level (dBuV/m)	Limit (dBuV/m)	Margin (dB)	Det.	Height (cm)	Azimuth (deg)	Remark
1 *	66.9669	13.45	14.88	28.33	40.00	-11.67	peak	200	4	
2	88.9637	16.56	11.43	27.99	43.50	-15.51	peak	200	11	
3	109.7959	15.20	13.21	28.41	43.50	-15.09	peak	100	6	
4	158.1123	14.27	16.42	30.69	43.50	-12.81	peak	200	174	
5	216.7828	16.82	12.89	29.71	46.00	-16.29	peak	100	231	
6	257.4221	15.91	14.23	30.14	46.00	-15.86	peak	200	327	

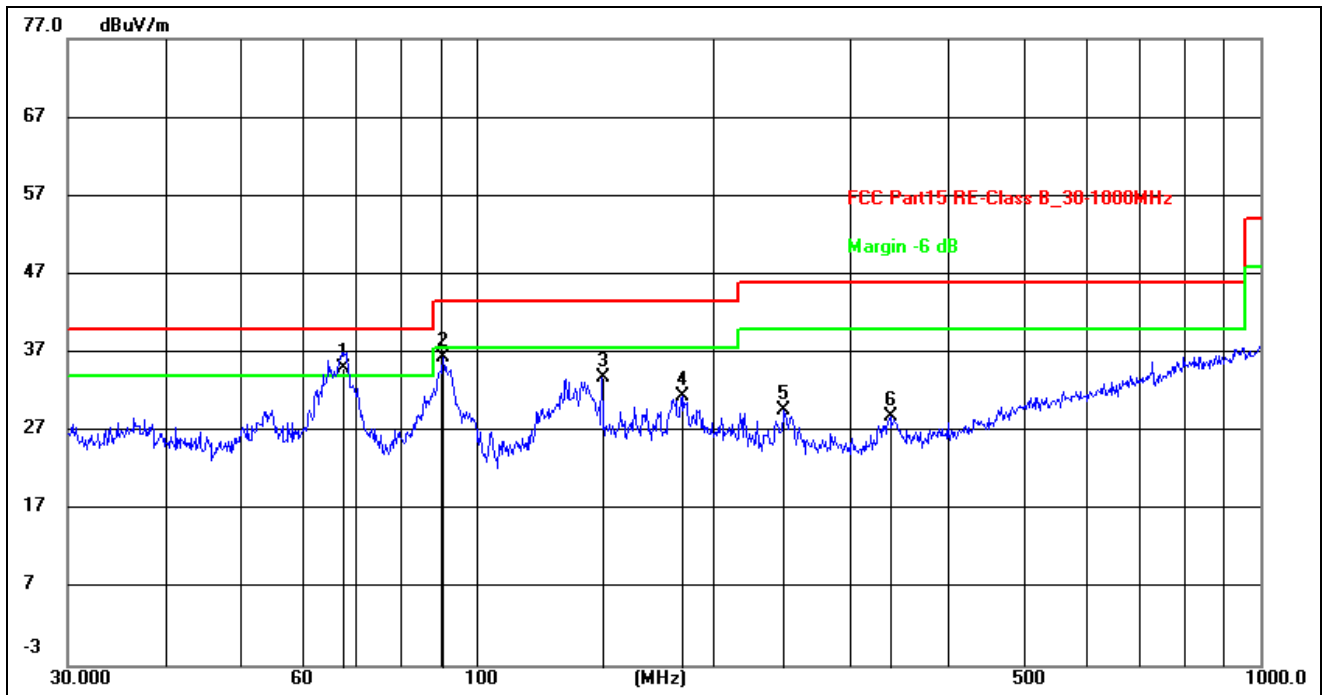

Site:	966LAB	Antenna::Vertical	Temperature(C):24(C)
Limit:	FCC Part15 RE-Class B_30-1000MHz		Humidity(%):60%
EUT:	Air Purifier	Test Time:	2022/5/20 8:52:21
M/N.:	CAHP-50WC02C	Power Rating:	AC 120V/60Hz
Mode:	High gears with Tx mode	Test Engineer:	
Note:	(802.11 b 2412MHz-Worst case)		

No.	Frequency (MHz)	Reading (dBuV)	Factor (dB/m)	Level (dBuV/m)	Limit (dBuV/m)	Margin (dB)	Det.	Height (cm)	Azimuth (deg)	Remark
1 *	67.2022	22.42	12.66	35.08	40.00	-4.92	QP	100	10	
2	90.5374	25.49	10.99	36.48	43.50	-7.02	peak	100	73	
3	144.3348	20.87	12.86	33.73	43.50	-9.77	peak	100	234	
4	183.2005	18.41	12.95	31.36	43.50	-12.14	peak	100	14	
5	246.8149	15.61	13.95	29.56	46.00	-16.44	peak	100	336	
6	337.2155	14.33	14.56	28.89	46.00	-17.11	peak	100	81	

Site:	966 LAB	Antenna::H / V	Temperature(C):24(C)
Limit:	FCC Part 15.247		Humidity(%):60%
EUT:	Air Purifier	Test Time:	2022/01/27
M/N.:	CAHP-50WC02C	Power Rating:	AC 120V/60Hz
Mode:	Tx mode (2412MHz)	Test Engineer:	
Note:	802.11 b 11M		

Frequency (MHz)	Reading (dBUV)	Factor (dB/m)	Pre-amp (dB)	Cable lost (dB)	Result (dBUV/m)	Limit (dBUV/m)	Margin (dB)	Detect	Antenna polarization
2390.00	59.17	26.33	40.23	8.46	53.73	74.00	-20.27	peak	H
2390.00	45.78	26.33	40.23	8.46	40.34	54.00	-13.66	AVG	H
2400.00	54.33	26.38	40.20	8.49	49.00	74.00	-25.00	peak	H
2400.00	45.31	26.38	40.20	8.49	39.98	54.00	-14.02	AVG	H
4824.00	64.91	26.41	40.21	8.51	59.62	74.00	-14.38	peak	H
4824.00	48.54	26.41	40.21	8.51	43.25	54.00	-10.75	AVG	H
7236.00	57.64	31.01	40.19	9.53	57.99	74.00	-16.01	peak	H
7236.00	44.05	31.01	40.19	9.53	44.40	54.00	-9.60	AVG	H
2390.00	57.89	26.33	40.23	8.46	52.45	74.00	-21.55	peak	V
2390.00	46.06	26.33	40.23	8.46	40.62	54.00	-13.38	AVG	V
2400.00	55.73	26.38	40.20	8.49	50.40	74.00	-23.60	peak	V
2400.00	46.17	26.38	40.20	8.49	40.84	54.00	-13.16	AVG	V
4824.00	63.26	26.41	40.21	8.51	57.97	74.00	-16.03	peak	V
4824.00	48.24	26.41	40.21	8.51	42.95	54.00	-11.05	AVG	V
7236.00	57.47	31.01	40.19	9.53	57.82	74.00	-16.18	peak	V
7236.00	45.50	31.01	40.19	9.53	45.85	54.00	-8.15	AVG	V

Note: 1. Result Level = Reading Level + Antenna Factor + Cable loss – Pre-amp Factor.

2. Antenna polarization: "H" means Horizontal, "V" means Vertical.

Site:	966 LAB	Antenna::H / V	Temperature(C):24(C)
Limit:	FCC Part 15.247		Humidity(%):60%
EUT:	Air Purifier	Test Time:	2022/01/27
M/N.:	CAHP-50WC02C	Power Rating:	AC 120V/60Hz
Mode:	Tx mode (2437MHz)	Test Engineer:	
Note:	802.11 b 11M		

Frequency (MHz)	Reading (dBuV)	Factor (dB/m)	Pre-amp (dB)	Cable lost (dB)	Result (dBuV/m)	Limit (dBuV/m)	Margin (dB)	Detect	Antenna polarization
4874.00	61.95	31.04	40.19	9.59	62.39	74.00	-11.61	peak	H
4874.00	38.88	31.04	40.19	9.59	39.32	54.00	-14.68	AVG	H
7311.00	55.44	35.25	40.47	12.22	62.44	74.00	-11.56	peak	H
7311.00	40.98	35.25	40.47	12.22	47.98	54.00	-6.02	AVG	H
4874.00	54.63	31.04	40.19	9.59	55.07	74.00	-18.93	peak	V
4874.00	36.19	31.04	40.19	9.59	36.63	54.00	-17.37	AVG	V
7311.00	51.04	35.25	40.47	12.22	62.04	74.00	-11.96	peak	V
7311.00	45.98	31.04	40.19	9.59	46.42	54.00	-7.58	AVG	V

Note: 1. Result Level = Reading Level + Antenna Factor + Cable loss – Pre-amp Factor.

2. Antenna polarization: “H” means Horizontal, “V” means Vertical.

Site:	966 LAB	Antenna::H / V	Temperature(C):24(C)
Limit:	FCC Part 15.247		Humidity(%):60%
EUT:	Air Purifier	Test Time:	2022/01/27
M/N.:	CAHP-50WC02C	Power Rating:	AC 120V/60Hz
Mode:	Tx mode (2462MHz)	Test Engineer:	
Note:	802.11 b 11M		

Frequency (MHz)	Reading (dBuV)	Factor (dB/m)	Pre-amp (dB)	Cable lost (dB)	Result (dBuV/m)	Limit (dBuV/m)	Margin (dB)	Detect	Antenna polarization
2483.50	42.77	26.56	40.29	8.65	37.69	74.00	-36.31	peak	H
2483.50	35.48	26.56	40.29	8.65	30.40	54.00	-23.60	AVG	H
4924.00	58.96	26.51	40.21	8.54	53.80	74.00	-20.20	peak	H
4924.00	48.74	26.51	40.21	8.54	43.58	54.00	-10.42	AVG	H
7386.00	51.21	31.04	40.19	9.62	51.68	74.00	-22.32	peak	H
7386.00	40.69	31.04	40.19	9.62	41.16	54.00	-12.84	AVG	H
2483.50	61.00	26.56	40.29	8.65	55.92	74.00	-18.08	peak	V
2483.50	46.72	26.56	40.29	8.65	41.64	54.00	-12.36	AVG	V
4924.00	53.44	26.56	40.29	8.65	48.36	74.00	-25.64	peak	V
4924.00	35.83	26.56	40.29	8.65	30.75	54.00	-23.25	AVG	V
7386.00	55.04	31.02	40.19	9.62	55.49	74.00	-18.51	peak	V
7386.00	44.18	31.02	40.19	9.62	44.63	54.00	-9.37	AVG	V

Note: 1. Result Level = Reading Level + Antenna Factor + Cable loss – Pre-amp Factor.

2. Antenna polarization: “H” means Horizontal, “V” means Vertical.

Site:	966 LAB	Antenna::H / V	Temperature(C):24(C)
Limit:	FCC Part 15.247		Humidity(%):60%
EUT:	Air Purifier	Test Time:	2022/01/27
M/N.:	CAHP-50WC02C	Power Rating:	AC 120V/60Hz
Mode:	Tx mode (2412MHz)	Test Engineer:	
Note:	802.11 g 54M		

Frequency (MHz)	Reading (dBuV)	Factor (dB/m)	Pre-amp (dB)	Cable lost (dB)	Result (dBuV/m)	Limit (dBuV/m)	Margin (dB)	Detect	Antenna polarization
2390.00	58.95	26.33	40.23	8.46	53.51	74.00	-20.49	peak	H
2390.00	46.39	26.33	40.23	8.46	40.95	54.00	-13.05	AVG	H
2400.00	55.38	26.38	40.20	8.49	50.05	74.00	-23.95	peak	H
2400.00	46.05	26.38	40.20	8.49	40.72	54.00	-13.28	AVG	H
4824.00	64.06	26.41	40.21	8.51	58.77	74.00	-15.23	peak	H
4824.00	48.77	26.41	40.21	8.51	43.48	54.00	-10.52	AVG	H
7236.00	57.71	31.01	40.19	9.53	58.06	74.00	-15.94	peak	H
7236.00	44.65	31.01	40.19	9.53	45.00	54.00	-9.00	AVG	H
2390.00	57.58	26.33	40.23	8.46	52.14	74.00	-21.86	peak	V
2390.00	45.07	26.33	40.23	8.46	39.63	54.00	-14.37	AVG	V
2400.00	55.75	26.38	40.20	8.49	50.42	74.00	-23.58	peak	V
2400.00	46.70	26.38	40.20	8.49	41.37	54.00	-12.63	AVG	V
4824.00	64.65	26.41	40.21	8.51	59.36	74.00	-14.64	peak	V
4824.00	47.83	26.41	40.21	8.51	42.54	54.00	-11.46	AVG	V
7236.00	57.03	31.01	40.19	9.53	57.38	74.00	-16.62	peak	V
7236.00	43.82	31.01	40.19	9.53	44.17	54.00	-9.83	AVG	V

Note: 1. Result Level = Reading Level + Antenna Factor + Cable loss – Pre-amp Factor.

2. Antenna polarization: “H” means Horizontal, “V” means Vertical.

Site:	966 LAB	Antenna::H / V	Temperature(C):24(C)
Limit:	FCC Part 15.247		Humidity(%):60%
EUT:	Air Purifier	Test Time:	2022/01/27
M/N.:	CAHP-50WC02C	Power Rating:	AC 120V/60Hz
Mode:	Tx mode (2437MHz)	Test Engineer:	
Note:	802.11 g 54M		

Frequency (MHz)	Reading (dBuV)	Factor (dB/m)	Pre-amp (dB)	Cable lost (dB)	Result (dBuV/m)	Limit (dBuV/m)	Margin (dB)	Detect	Antenna polarization
4874.00	62.41	31.04	40.19	9.59	62.85	74.00	-11.15	peak	H
4874.00	39.62	31.04	40.19	9.59	40.06	54.00	-13.94	AVG	H
7311.00	53.97	35.25	40.47	12.22	60.97	74.00	-13.03	peak	H
7311.00	41.19	35.25	40.47	12.22	48.19	54.00	-5.81	AVG	H
4874.00	54.59	31.04	40.19	9.59	55.03	74.00	-18.97	peak	V
4874.00	37.11	31.04	40.19	9.59	37.55	54.00	-16.45	AVG	V
7311.00	54.97	35.25	40.47	12.22	61.97	74.00	-12.03	peak	V
7311.00	41.95	35.25	40.47	12.22	48.95	54.00	-5.05	AVG	V

Note: 1. Result Level = Reading Level + Antenna Factor + Cable loss – Pre-amp Factor.

2. Antenna polarization: “H” means Horizontal, “V” means Vertical.

Site:	966 LAB	Antenna::H / V	Temperature(C):24(C)
Limit:	FCC Part 15.247		Humidity(%):60%
EUT:	Air Purifier	Test Time:	2022/01/27
M/N.:	CAHP-50WC02C	Power Rating:	AC 120V/60Hz
Mode:	Tx mode (2462MHz)	Test Engineer:	
Note:	802.11 g 54M		

Frequency (MHz)	Reading (dBuV)	Factor (dB/m)	Pre-amp (dB)	Cable lost (dB)	Result (dBuV/m)	Limit (dBuV/m)	Margin (dB)	Detect	Antenna polarization
2483.50	42.11	26.56	40.29	8.65	37.03	74.00	-36.97	peak	H
2483.50	34.76	26.56	40.29	8.65	29.68	54.00	-24.32	AVG	H
4924.00	59.58	26.51	40.21	8.54	54.42	74.00	-19.58	peak	H
4924.00	48.28	26.51	40.21	8.54	43.12	54.00	-10.88	AVG	H
7386.00	51.23	31.04	40.19	9.62	51.70	74.00	-22.30	peak	H
7386.00	40.15	31.04	40.19	9.62	40.62	54.00	-13.38	AVG	H
2483.50	59.46	26.56	40.29	8.65	54.38	74.00	-19.62	peak	V
2483.50	47.43	26.56	40.29	8.65	42.35	54.00	-11.65	AVG	V
4924.00	56.75	26.51	40.21	8.54	51.59	55.00	-3.41	peak	V
4924.00	46.33	26.51	40.21	8.54	41.17	56.00	-14.83	AVG	V
7386.00	53.30	31.04	40.19	9.62	53.77	74.00	-20.23	peak	V
7386.00	40.77	31.04	40.19	9.62	41.24	54.00	-12.76	AVG	V

Note: 1. Result Level = Reading Level + Antenna Factor + Cable loss – Pre-amp Factor.

2. Antenna polarization: "H" means Horizontal, "V" means Vertical.

Site:	966 LAB	Antenna::H / V	Temperature(C):24(C)
Limit:	FCC Part 15.247		Humidity(%):60%
EUT:	Air Purifier	Test Time:	2022/01/27
M/N.:	CAHP-50WC02C	Power Rating:	AC 120V/60Hz
Mode:	Tx mode (2412MHz)	Test Engineer:	
Note:	802.11 n20		

Frequency (MHz)	Reading (dBuV)	Factor (dB/m)	Pre-amp (dB)	Cable lost (dB)	Result (dBuV/m)	Limit (dBuV/m)	Margin (dB)	Detect	Antenna polarization
2390.00	57.76	26.33	40.23	8.46	52.32	74.00	-21.68	peak	H
2390.00	45.20	26.33	40.23	8.46	39.76	54.00	-14.24	AVG	H
2400.00	54.90	26.38	40.20	8.49	49.57	74.00	-24.43	peak	H
2400.00	45.29	26.38	40.20	8.49	39.96	54.00	-14.04	AVG	H
4824.00	64.39	26.41	40.21	8.51	59.10	74.00	-14.90	peak	H
4824.00	48.75	26.41	40.21	8.51	43.46	54.00	-10.54	AVG	H
7236.00	57.75	31.01	40.19	9.53	58.10	74.00	-15.90	peak	H
7236.00	45.10	31.01	40.19	9.53	45.45	54.00	-8.55	AVG	H
2390.00	57.74	26.33	40.23	8.46	52.30	74.00	-21.70	peak	V
2390.00	46.38	26.33	40.23	8.46	40.94	54.00	-13.06	AVG	V
2400.00	54.03	26.38	40.20	8.49	48.70	74.00	-25.30	peak	V
2400.00	45.06	26.38	40.20	8.49	39.73	54.00	-14.27	AVG	V
4824.00	64.52	26.41	40.21	8.51	59.23	74.00	-14.77	peak	V
4824.00	49.16	26.41	40.21	8.51	43.87	54.00	-10.13	AVG	V
7236.00	57.75	31.01	40.19	9.53	58.10	74.00	-15.90	peak	V
7236.00	44.78	31.01	40.19	9.53	45.13	54.00	-8.87	AVG	V

Note: 1. Result Level = Reading Level + Antenna Factor + Cable loss – Pre-amp Factor.

2. Antenna polarization: "H" means Horizontal, "V" means Vertical.

Site:	966 LAB	Antenna::H / V	Temperature(C):24(C)
Limit:	FCC Part 15.247		Humidity(%):60%
EUT:	Air Purifier	Test Time:	2022/01/27
M/N.:	CAHP-50WC02C	Power Rating:	AC 120V/60Hz
Mode:	Tx mode (2437MHz)	Test Engineer:	
Note:	802.11 n20		

Frequency (MHz)	Reading (dBuV)	Factor (dB/m)	Pre-amp (dB)	Cable lost (dB)	Result (dBuV/m)	Limit (dBuV/m)	Margin (dB)	Detect	Antenna polarization
4874.00	62.57	31.04	40.19	9.59	63.01	74.00	-10.99	peak	H
4874.00	39.48	31.04	40.19	9.59	39.92	54.00	-14.08	AVG	H
7311.00	55.49	35.25	40.47	12.22	62.49	74.00	-11.51	peak	H
7311.00	40.13	35.25	40.47	12.22	47.13	54.00	-6.87	AVG	H
4874.00	54.24	31.04	40.19	9.59	54.68	74.00	-19.32	peak	V
4874.00	36.65	31.04	40.19	9.59	37.09	54.00	-16.91	AVG	V
7311.00	52.90	35.25	40.47	12.22	59.90	74.00	-14.10	peak	V
7311.00	40.45	35.25	40.47	12.22	47.45	54.00	-6.55	AVG	V

Note: 1. Result Level = Reading Level + Antenna Factor + Cable loss – Pre-amp Factor.

2. Antenna polarization: “H” means Horizontal, “V” means Vertical.

Site:	966 LAB	Antenna::H / V	Temperature(C):24(C)
Limit:	FCC Part 15.247		Humidity(%):60%
EUT:	Air Purifier	Test Time:	2022/01/27
M/N.:	CAHP-50WC02C	Power Rating:	AC 120V/60Hz
Mode:	Tx mode (2462MHz)	Test Engineer:	
Note:	802.11 n20		

Frequency (MHz)	Reading (dBuV)	Factor (dB/m)	Pre-amp (dB)	Cable lost (dB)	Result (dBuV/m)	Limit (dBuV/m)	Margin (dB)	Detect	Antenna polarization
2483.50	41.95	26.56	40.29	8.65	36.87	74.00	-37.13	peak	H
2483.50	35.60	26.56	40.29	8.65	30.52	54.00	-23.48	AVG	H
4924.00	59.05	26.51	40.21	8.54	53.89	74.00	-20.11	peak	H
4924.00	49.37	26.51	40.21	8.54	44.21	54.00	-9.79	AVG	H
7386.00	52.61	31.04	40.19	9.62	53.08	74.00	-20.92	peak	H
7386.00	39.05	31.04	40.19	9.62	39.52	54.00	-14.48	AVG	H
2483.50	60.58	26.56	40.29	8.65	55.50	74.00	-18.50	peak	V
2483.50	46.29	26.56	40.29	8.65	41.21	54.00	-12.79	AVG	V
4924.00	55.41	26.56	40.29	8.65	50.33	74.00	-23.67	peak	V
4924.00	35.45	26.56	40.29	8.65	30.37	54.00	-23.63	AVG	V
7386.00	53.91	31.04	40.19	9.62	54.38	74.00	-19.62	peak	V
7386.00	38.85	31.04	40.19	9.62	39.32	54.00	-14.68	AVG	V

Note: 1. Result Level = Reading Level + Antenna Factor + Cable loss – Pre-amp Factor.

2. Antenna polarization: “H” means Horizontal, “V” means Vertical.

5. Output Power

5.1. Test equipment

Item	Equipment	Manufacturer	Model No.	Serial No.	Last Cal.	Cal. Interval
1	MXA Signal Analyzer	KEYSIGHT	N9020A	MY5451047 6	2020/05/25	1 Year

5.2. BLOCK DIAGRAM OF TEST SETUP

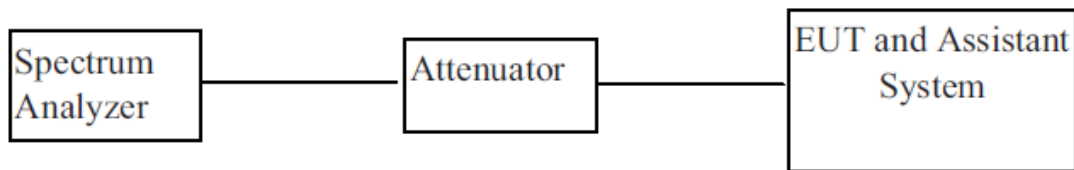

5.3. Limit

For systems using digital modulation in the 902-928 MHz, 2400-2483.5 MHz, and 5725-5850 MHz bands: 1 Watt (30dBm).

5.4. Test Procedure

For output power test:

1. Connect EUT RF output port to power sensor through an RF attenuator.
2. Connect the power sensor to the PC.
3. Set the EUT Work on the top, the middle and the bottom operation frequency individually.
4. Record the maximum power from the software.

Note : The EUT was tested according to KDB 558074v03r04 for compliance to FCC 47CFR 15.247 requirements.

5.5. Test result

Condition	Mode	Frequency (MHz)	Antenna	Conducted Power (dBm)	Duty Factor (dB)	Total Power (dBm)	Limit (dBm)	Verdict
NVNT	802.11b 1Mbps	2412	Ant 1	18.393	0	18.393	30	Pass
NVNT	802.11b 1Mbps	2437	Ant 1	18.171	0	18.171	30	Pass
NVNT	802.11b 1Mbps	2462	Ant 1	18.107	0	18.107	30	Pass

Power NVNT 802.11b 1Mbps 2412MHz Ant1

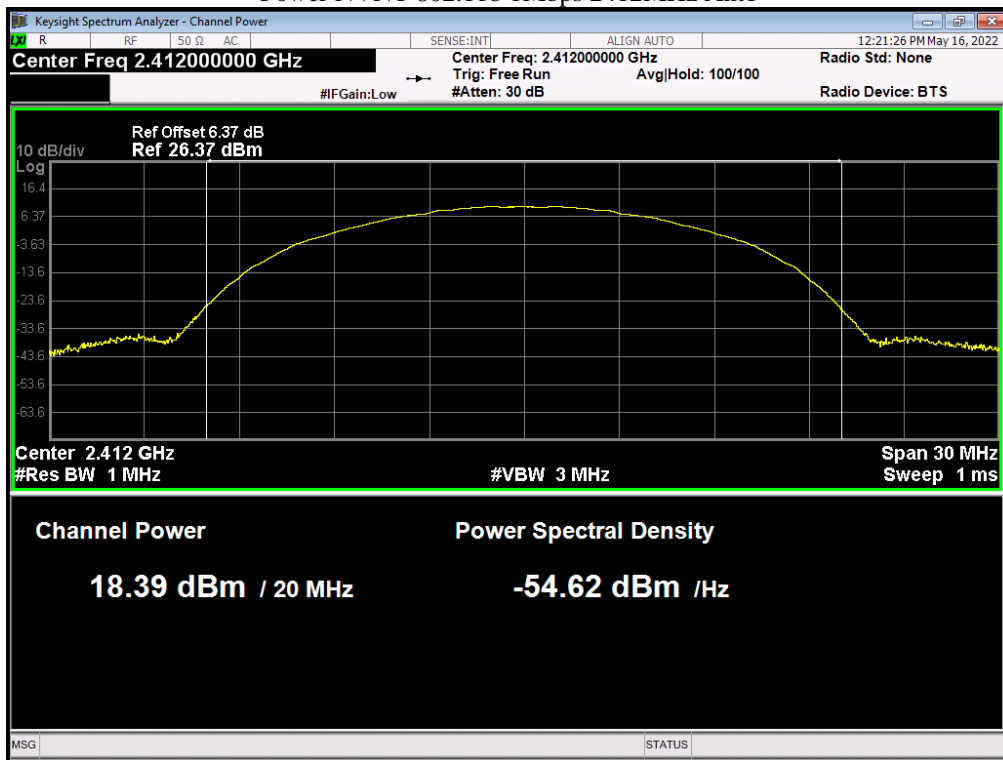

Power NVNT 802.11b 1Mbps 2437MHz Ant1

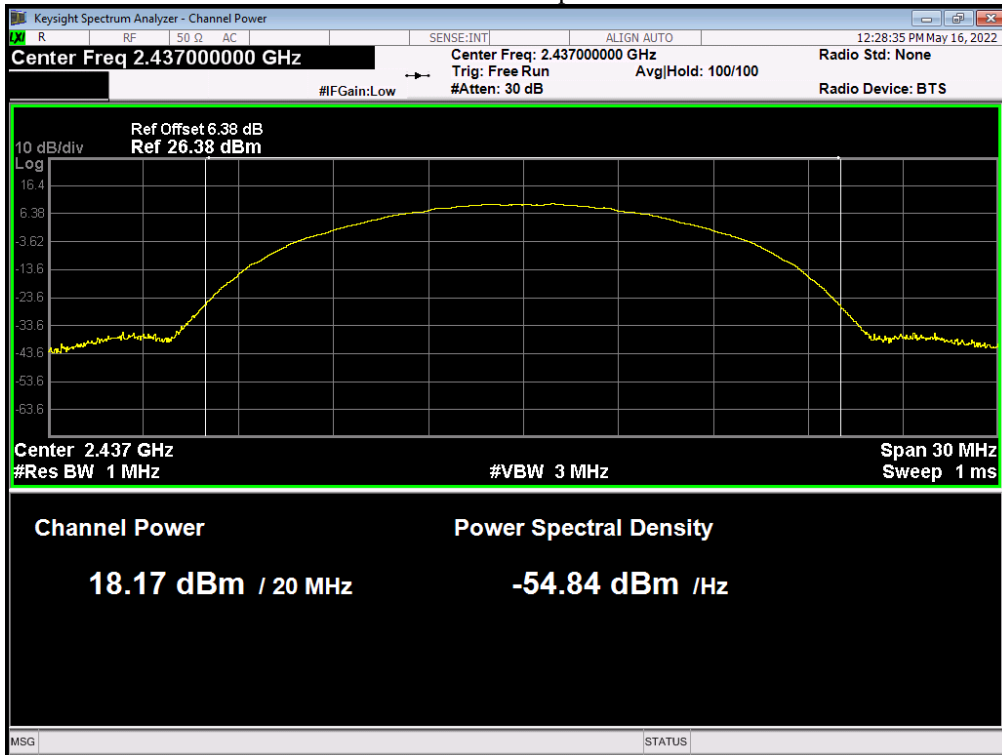

Power NVNT 802.11b 1Mbps 2462MHz Ant1

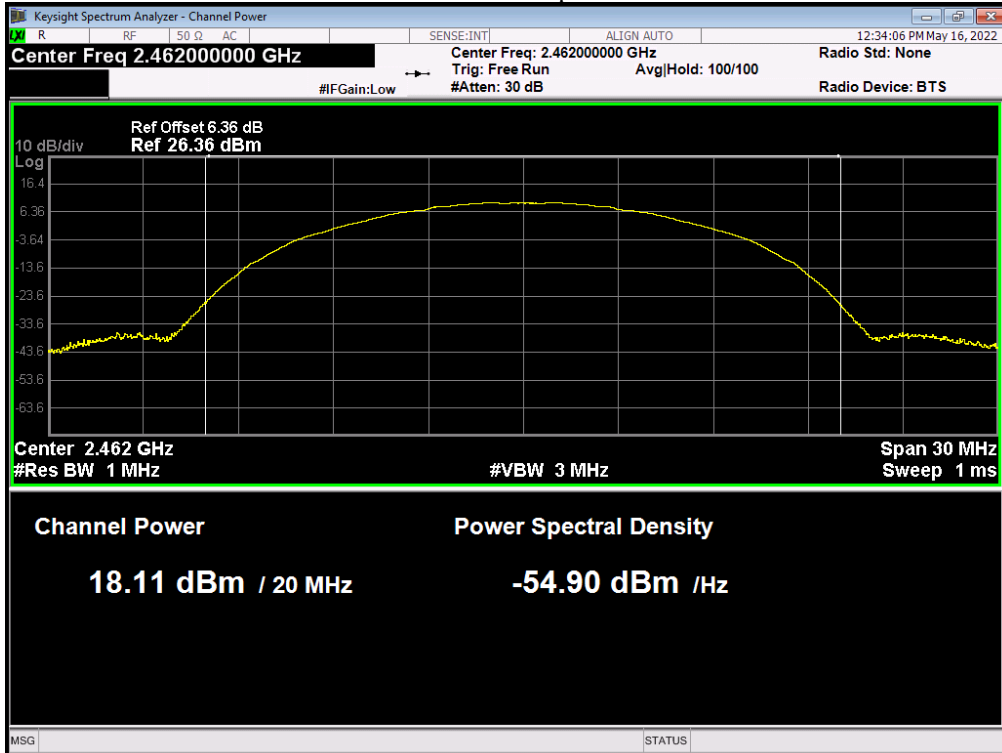

Condition	Mode	Frequency (MHz)	Antenna	Conducted Power (dBm)	Duty Factor (dB)	Total Power (dBm)	Limit (dBm)	Verdict
NVNT	802.11g 6Mbps	2412	Ant 1	17.842	0	17.842	30	Pass
NVNT	802.11g 6Mbps	2437	Ant 1	17.772	0	17.772	30	Pass
NVNT	802.11g 6Mbps	2462	Ant 1	17.767	0	17.767	30	Pass

Power NVNT 802.11g 6Mbps 2412MHz Ant1

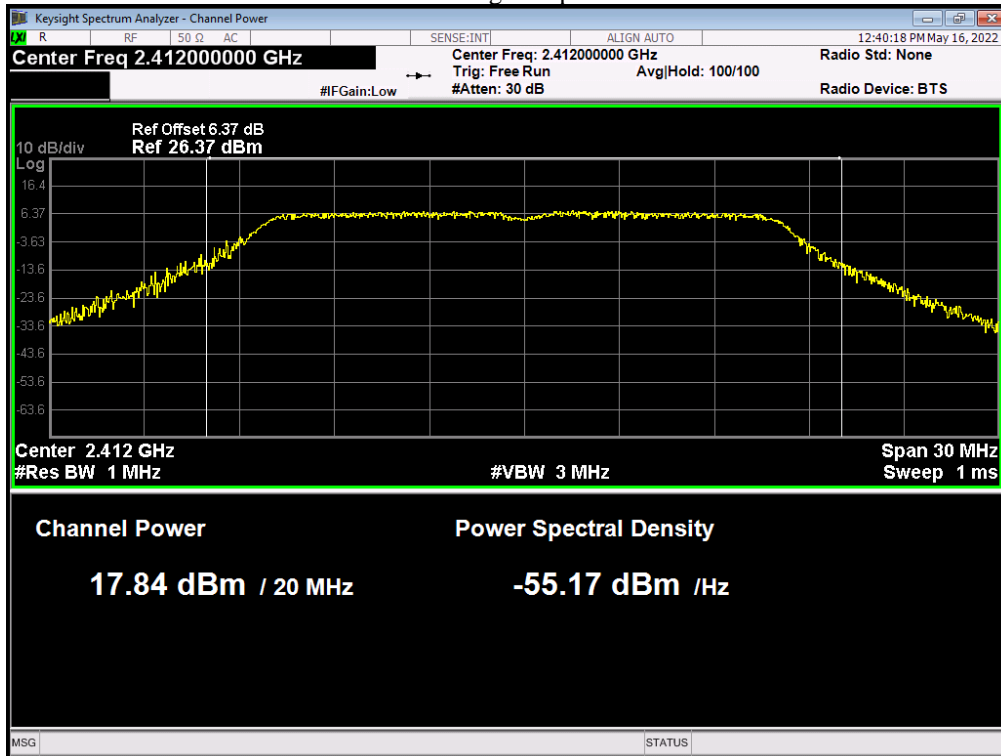

Power NVNT 802.11g 6Mbps 2437MHz Ant1

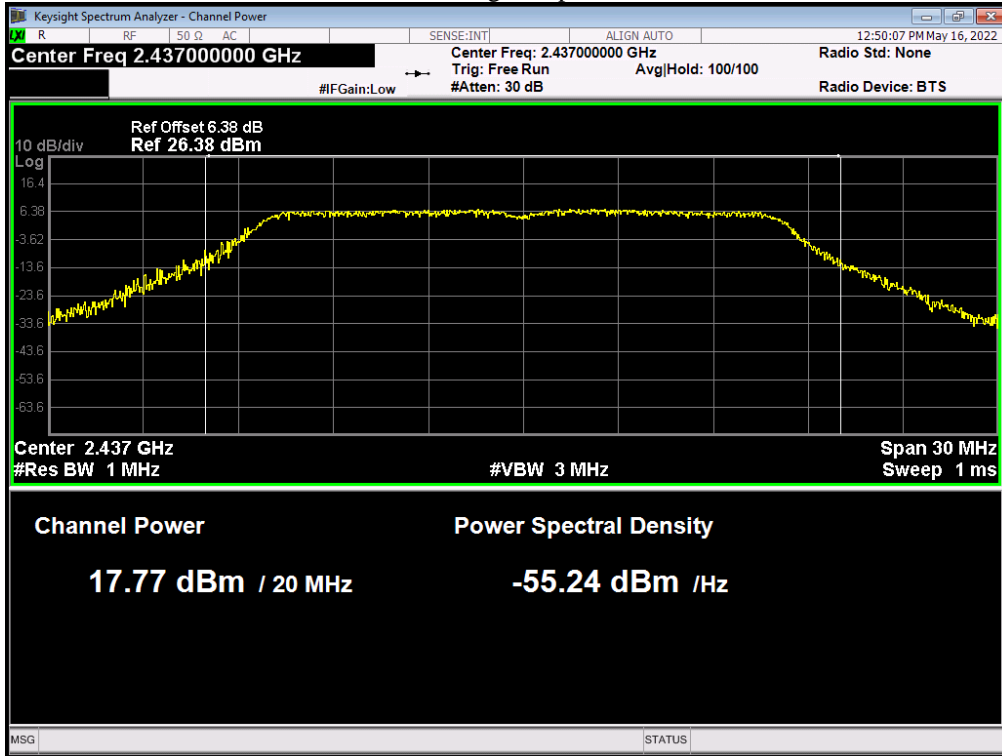

Power NVNT 802.11g 6Mbps 2462MHz Ant1

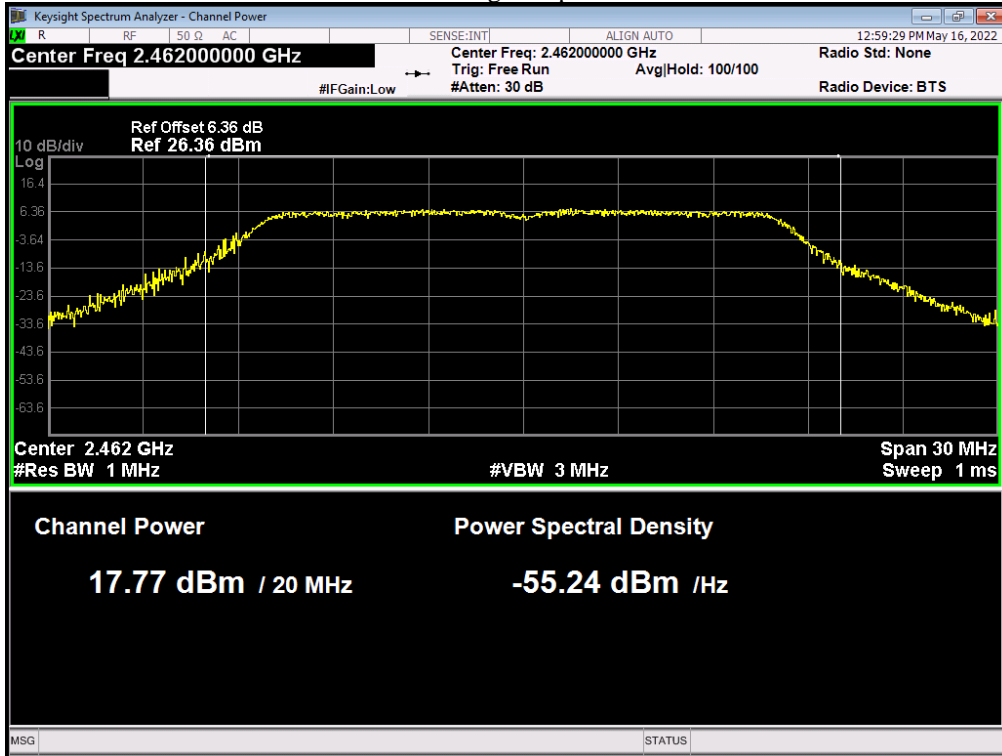

Condition	Mode	Frequency (MHz)	Antenna	Conducted Power (dBm)	Duty Factor (dB)	Total Power (dBm)	Limit (dBm)	Verdict
NVNT	802.11n(HT20)	2412	Ant 1	17.992	0	17.992	30	Pass
NVNT	802.11n(HT20)	2437	Ant 1	17.973	0	17.973	30	Pass
NVNT	802.11n(HT20)	2462	Ant 1	18.363	0	18.363	30	Pass

Power NVNT 802.11n(HT20) 2412MHz Ant1

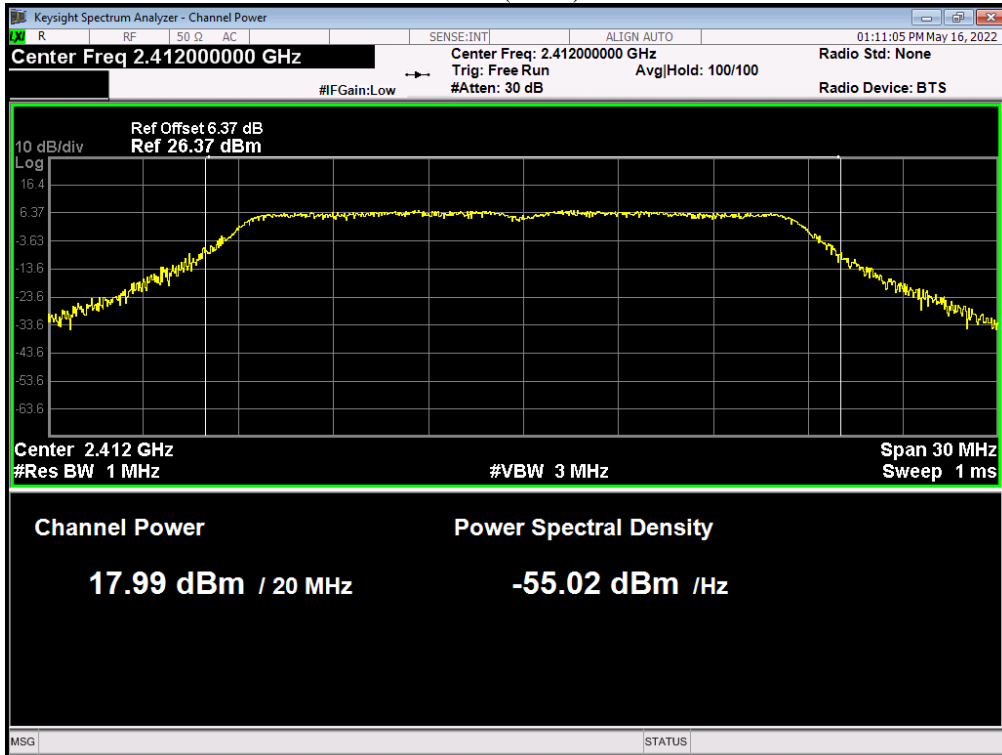

Power NVNT 802.11n(HT20) 2437MHz Ant1

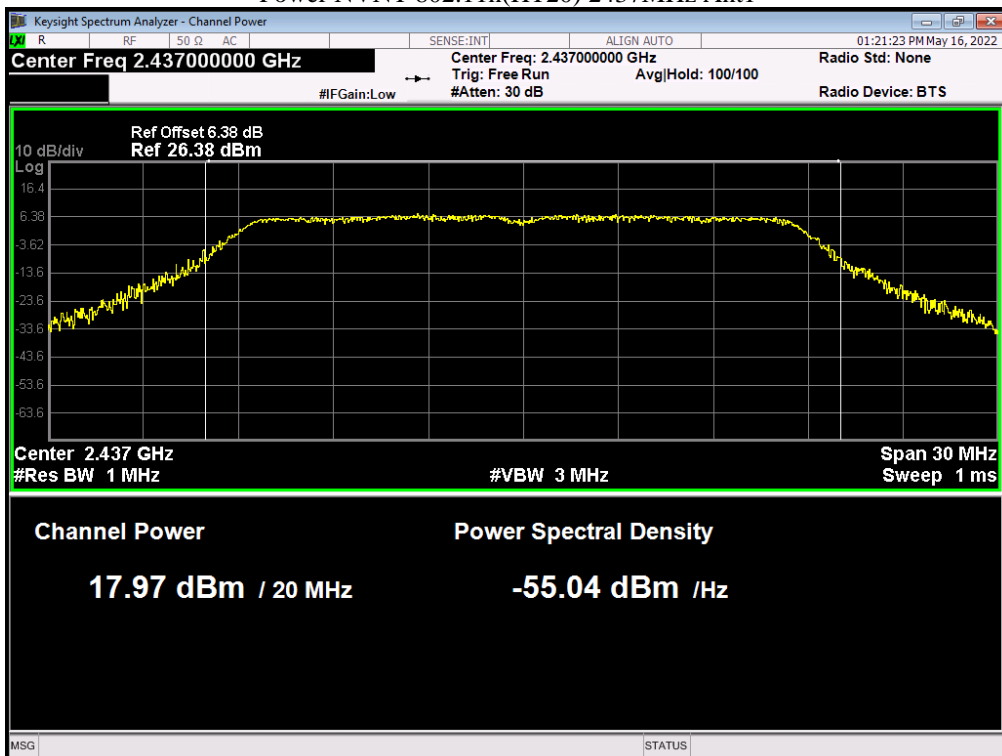

Power NVNT 802.11n(HT20) 2462MHz Ant1

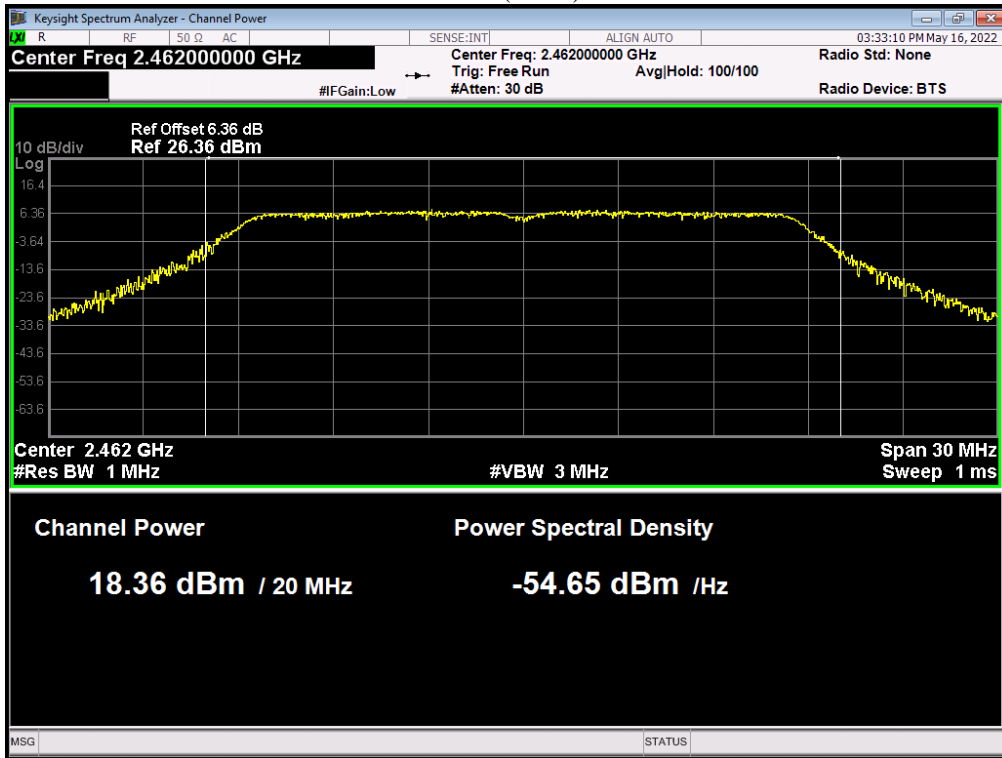

6. -6dB Bandwidth

6.1. Test equipment

Item	Equipment	Manufacturer	Model No.	Serial No.	Last Cal.	Cal. Interval
1	MXA Signal Analyzer	KEYSIGHT	N9020A	MY5451047 6	2020/05/25	1 Year

6.2. BLOCK DIAGRAM OF TEST SETUP

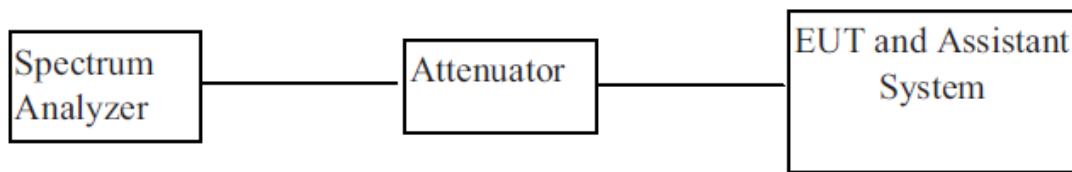

6.3. Limit

Systems using digital modulation techniques may operate in the 902 - 928 MHz, 2400 - 2483.5 MHz, and 5725 - 5850 MHz bands. The minimum 6 dB bandwidth shall be at least 500 kHz.

6.4. Test Procedure

1. Connect EUT RF output port to the Spectrum Analyzer through an RF attenuator
2. Set the EUT Work on the top, the middle and the bottom operation frequency individually.
3. Set SPA Centre Frequency = Operation Frequency, RBW= 100 KHz, VBW \geq 3 \times RBW.
4. Set SPA Trace 1 Max hold, then View.

Note: The EUT was tested according to KDB 558074 for compliance to FCC 47CFR 15.247 requirements.

6.5. Test result

Condition	Mode	Frequency (MHz)	Antenna	99% OBW (MHz)	-6 dB Bandwidth (MHz)	Limit -6 dB Bandwidth (MHz)	Verdict
NVNT	802.11b 1Mbps	2412	Ant 1	14.1065	8.5408	0.5	Pass
NVNT	802.11b 1Mbps	2437	Ant 1	14.0637	8.0806	0.5	Pass
NVNT	802.11b 1Mbps	2462	Ant 1	14.1285	8.5511	0.5	Pass

OBW NVNT 802.11b 1Mbps 2412MHz Ant1

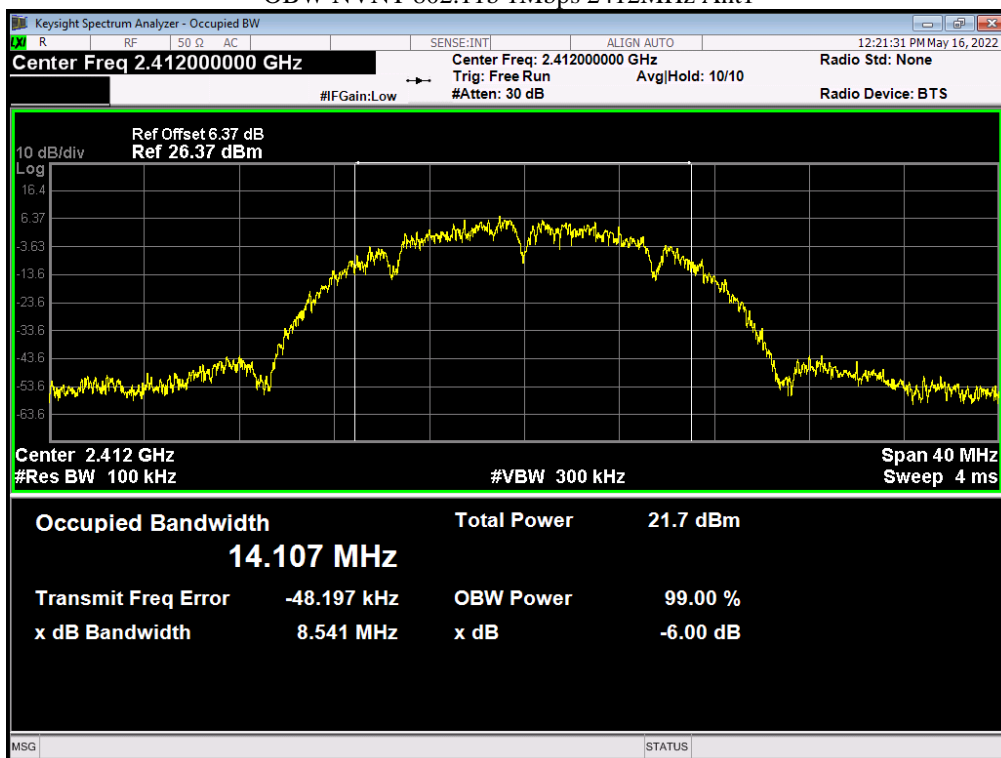

OBW NVNT 802.11b 1Mbps 2437MHz Ant1

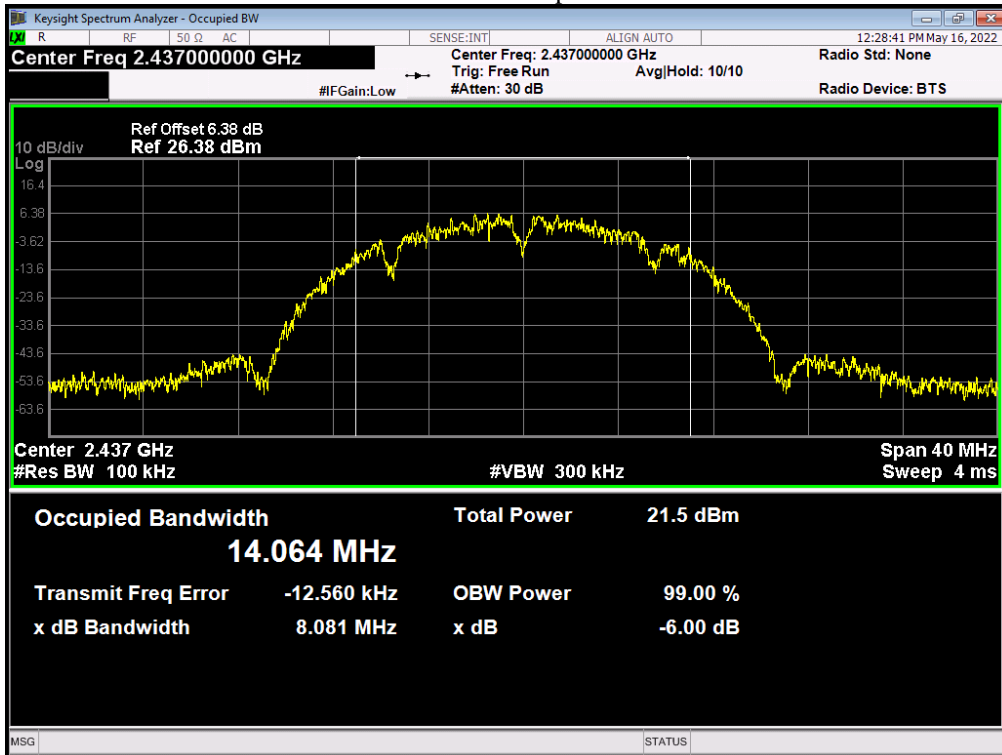

OBW NVNT 802.11b 1Mbps 2462MHz Ant1

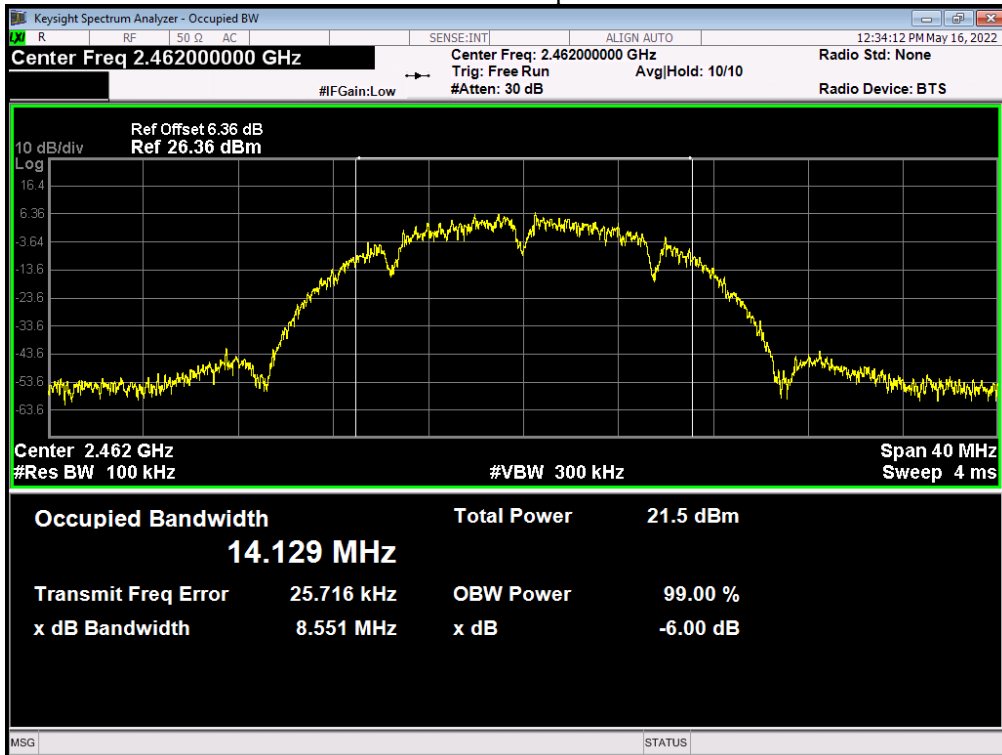

Condition	Mode	Frequency (MHz)	Antenna	99% OBW (MHz)	-6 dB Bandwidth (MHz)	Limit -6 dB Bandwidth (MHz)	Verdict
NVNT	802.11g 6Mbps	2412	Ant 1	16.461	16.5338	0.5	Pass
NVNT	802.11g 6Mbps	2437	Ant 1	16.4421	16.4787	0.5	Pass
NVNT	802.11g 6Mbps	2462	Ant 1	16.4412	16.5094	0.5	Pass

OBW NVNT 802.11g 6Mbps 2412MHz Ant1

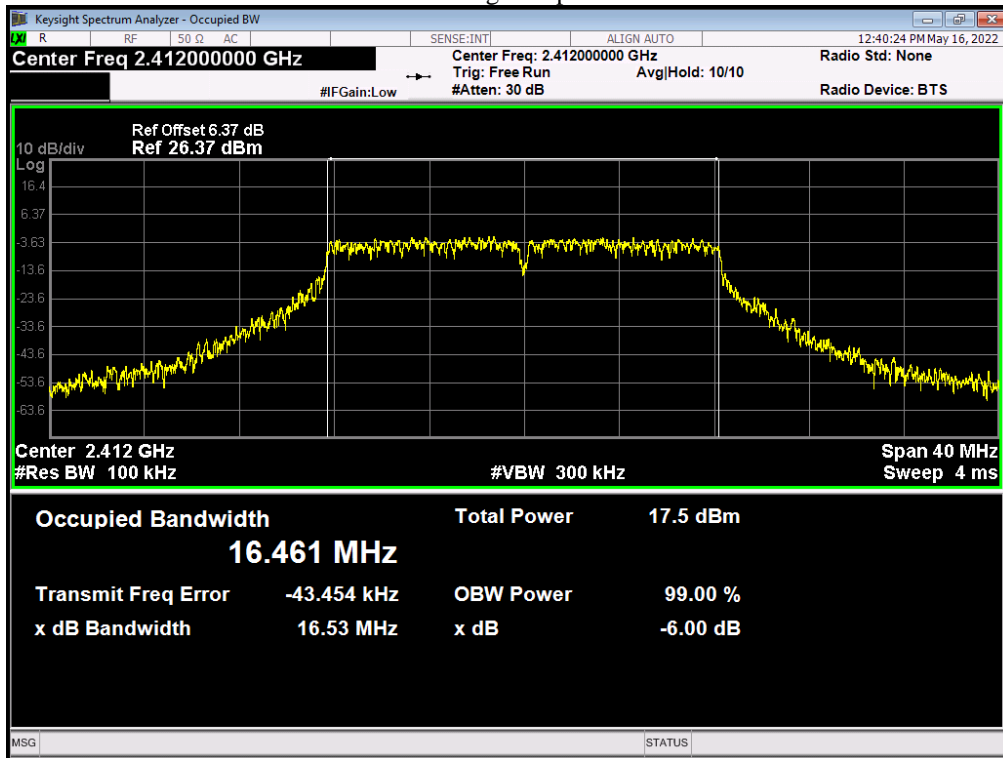

OBW NVNT 802.11g 6Mbps 2437MHz Ant1

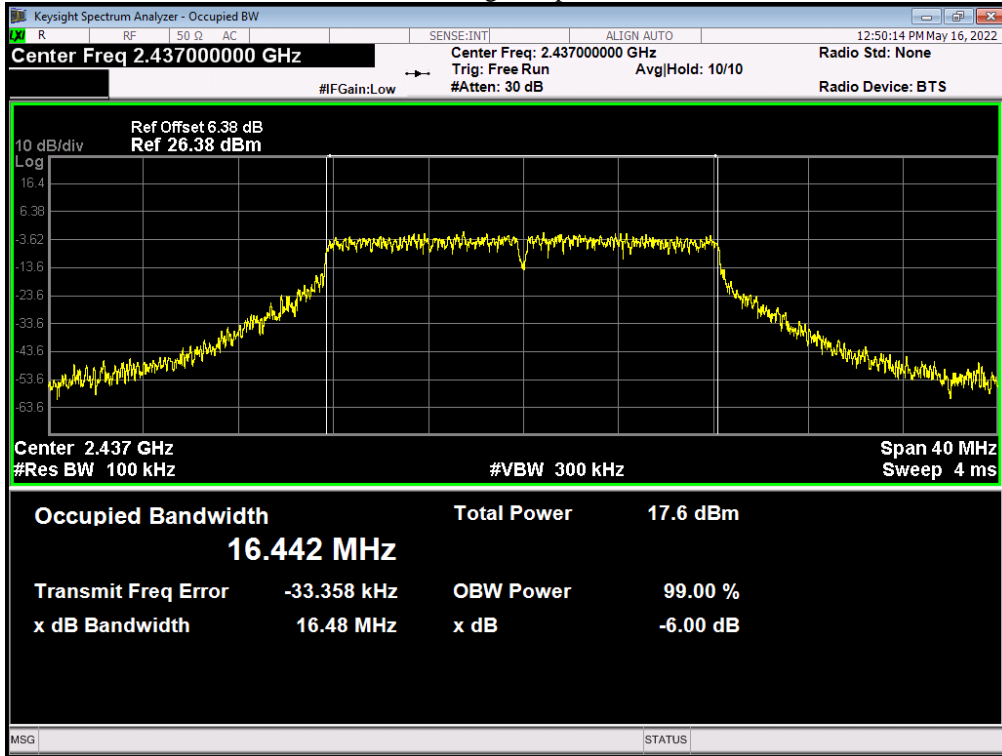

OBW NVNT 802.11g 6Mbps 2462MHz Ant1

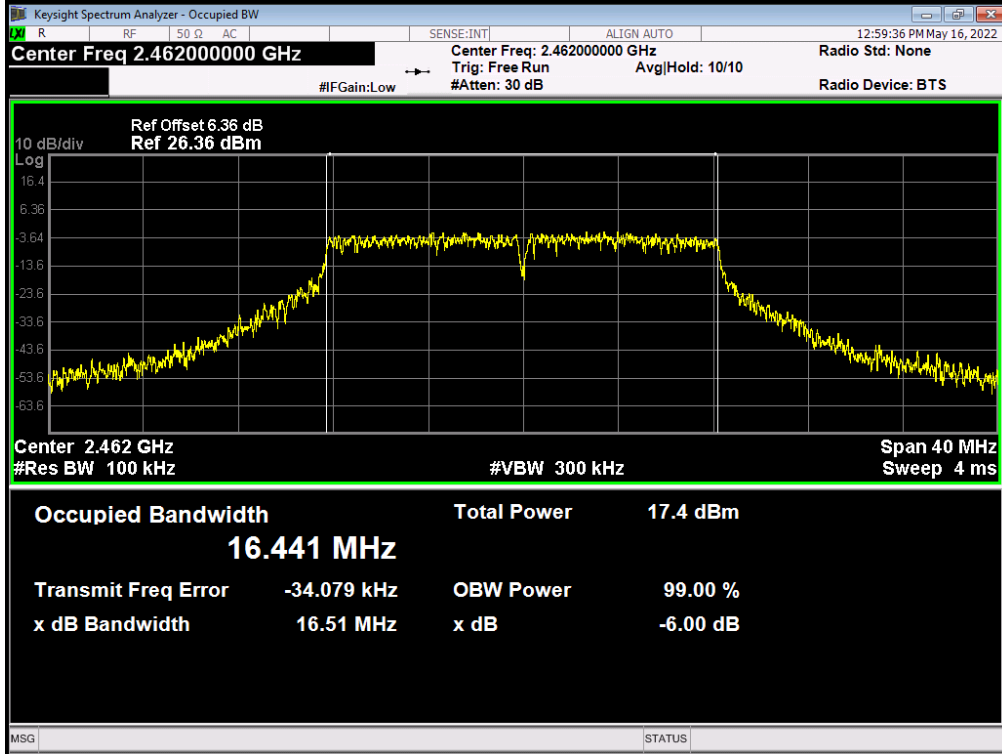

Condition	Mode	Frequency (MHz)	Antenna	99% OBW (MHz)	-6 dB Bandwidth (MHz)	Limit -6 dB Bandwidth (MHz)	Verdict
NVNT	802.11n(HT20)	2412	Ant 1	17.6637	17.7086	0.5	Pass
NVNT	802.11n(HT20)	2437	Ant 1	17.6473	17.7251	0.5	Pass
NVNT	802.11n(HT20)	2462	Ant 1	17.6655	17.7587	0.5	Pass

OBW NVNT 802.11n(HT20) 2412MHz Ant1

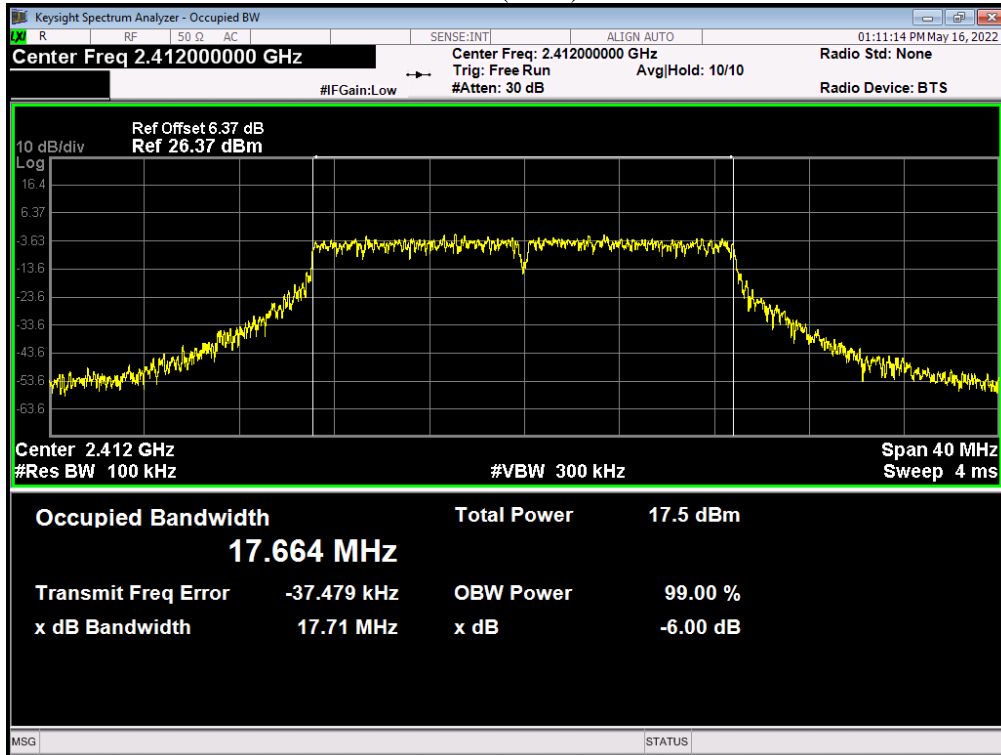

OBW NVNT 802.11n(HT20) 2437MHz Ant1

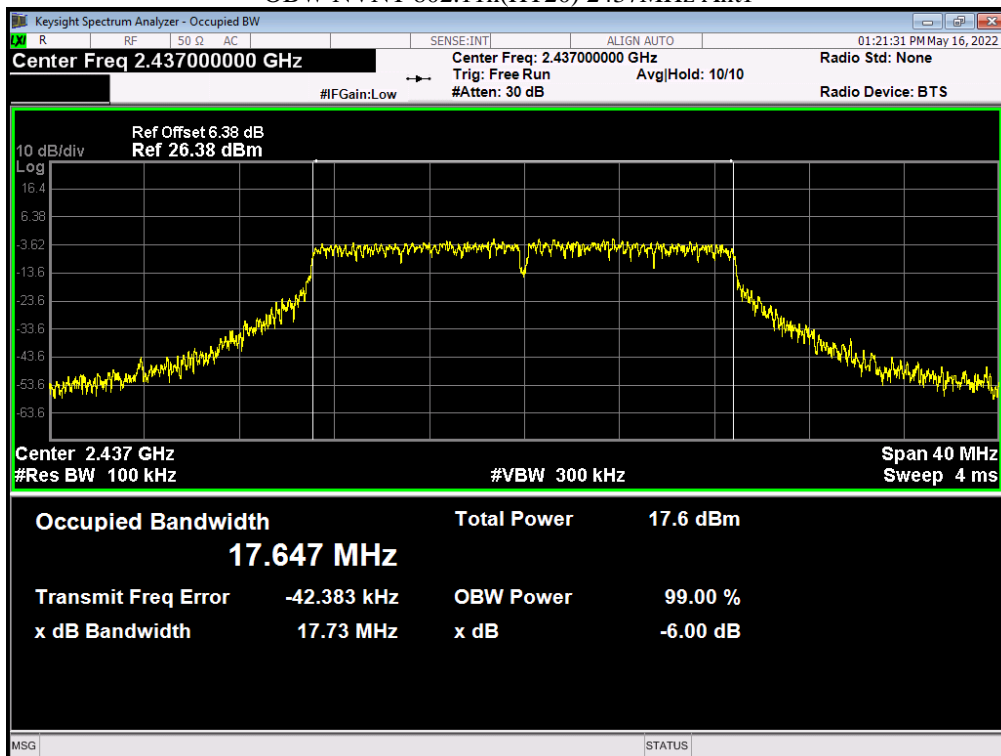

OBW NVNT 802.11n(HT20) 2462MHz Ant1

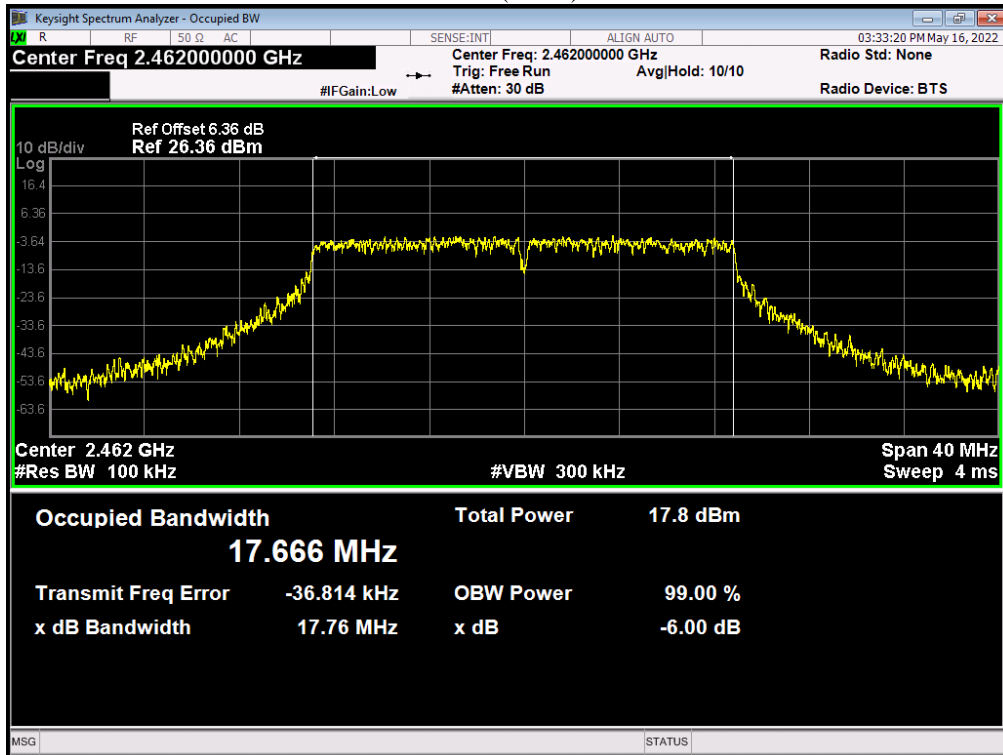

7. Band Edges Measurement

7.1. Test equipment

Item	Equipment	Manufacturer	Model No.	Serial No.	Last Cal.	Cal. Interval
1	MXA Signal Analyzer	KEYSIGHT	N9020A	MY5451047 6	2020/05/25	1 Year

7.2. BLOCK DIAGRAM OF TEST SETUP

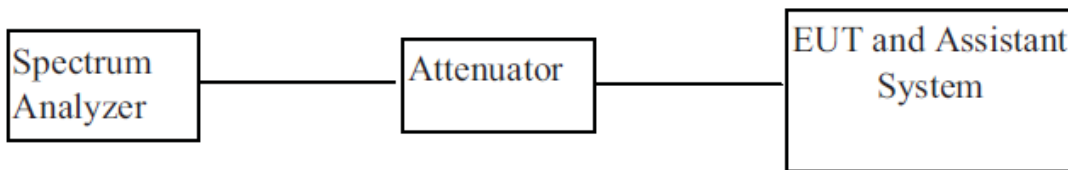

7.3. Limit

Below -30dB of the highest emission level of operating band (In 100 kHz Resolution Bandwidth)

7.4. Test Procedure

The transmitter output was connected to the spectrum analyzer via a low lose cable.

Set RBW of spectrum analyzer to 100 KHz and VBW of spectrum analyzer to 300 KHz with convenient frequency span including 100 KHz bandwidth from band edge.

Peak conducted output power measured within any 100 kHz outside the authorized frequency band shall be attenuated by at least 30dB relative to the maximum measured in-band peak PSD level.

The band edges was measured and recorded.

7.5. Test result

Condition	Mode	Frequency (MHz)	Antenna	Max Value (dBc)	Limit (dBc)	Verdict
NVNT	802.11b 1Mbps	2412	Ant 1	-60.697	-30	Pass
NVNT	802.11b 1Mbps	2462	Ant 1	-59.339	-30	Pass

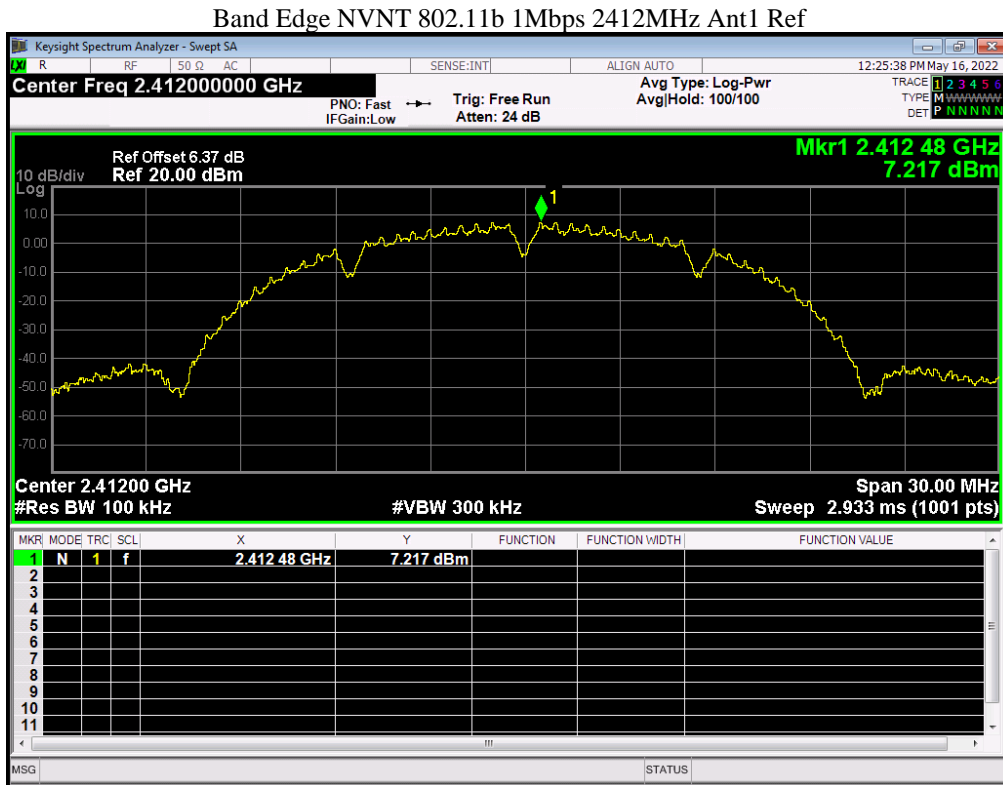

Band Edge NVNT 802.11b 1Mbps 2412MHz Ant1 Emission

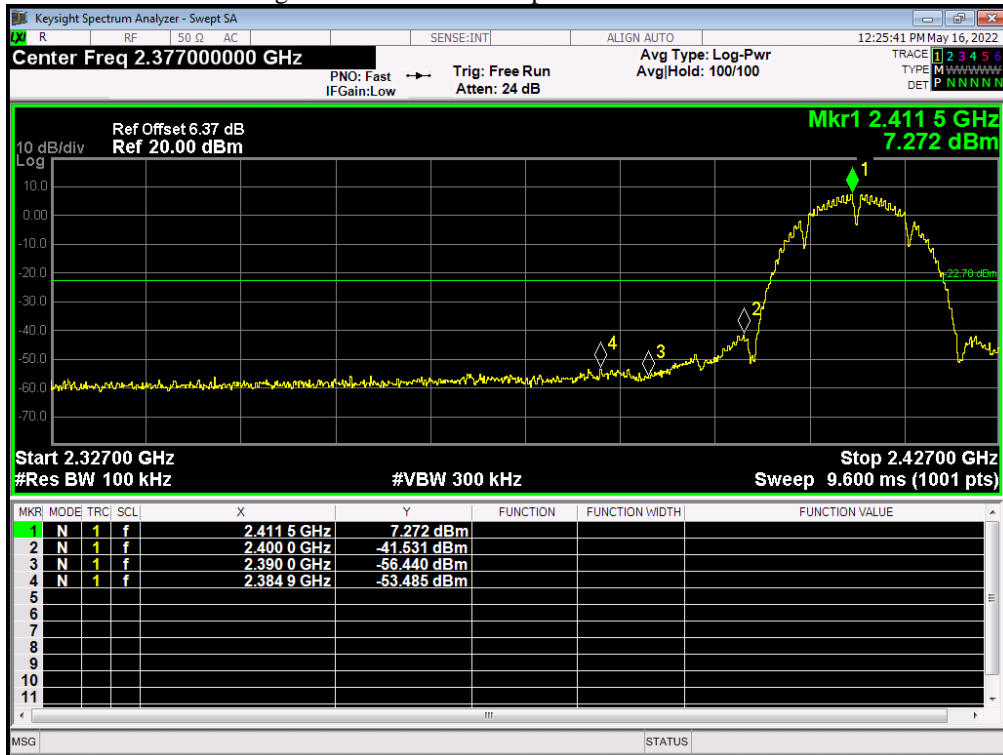

Band Edge NVNT 802.11b 1Mbps 2462MHz Ant1 Ref

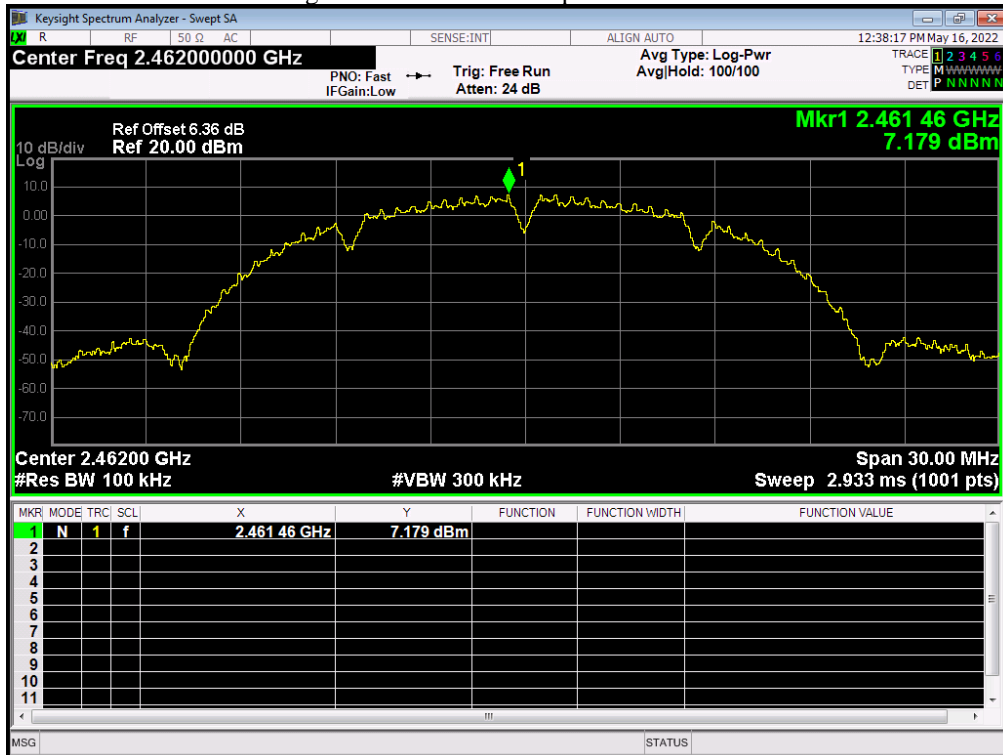

Band Edge NVNT 802.11b 1Mbps 2462MHz Ant1 Emission

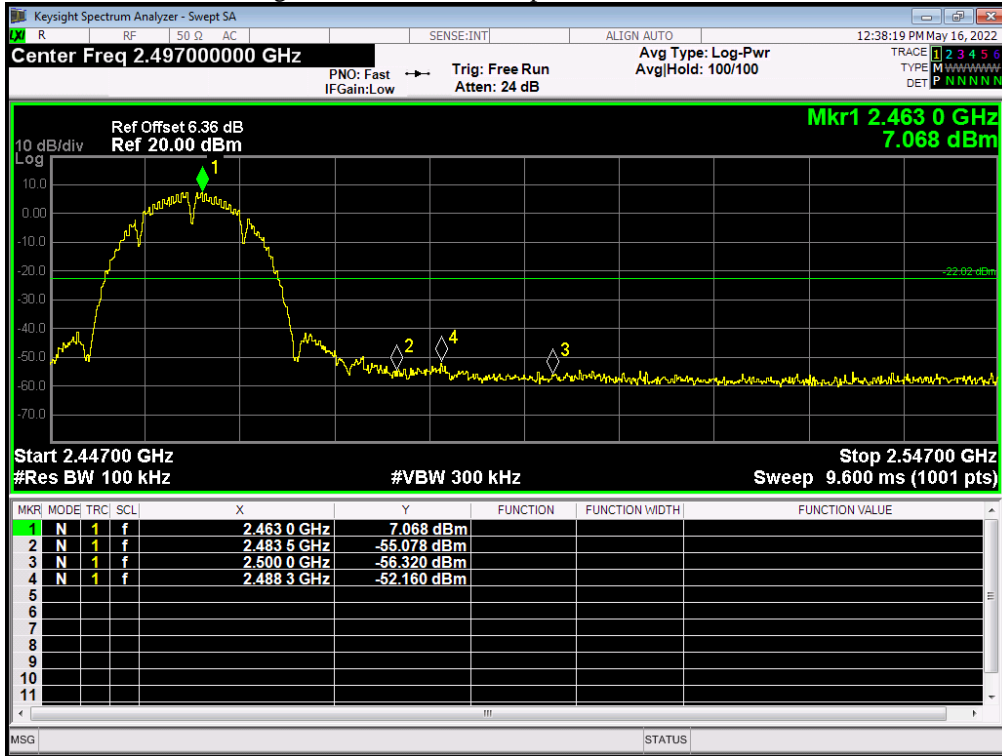

Condition	Mode	Frequency (MHz)	Antenna	Max Value (dBc)	Limit (dBc)	Verdict
NVNT	802.11g 6Mbps	2412	Ant 1	-52.094	-30	Pass
NVNT	802.11g 6Mbps	2462	Ant 1	-49.316	-30	Pass

Band Edge NVNT 802.11g 6Mbps 2412MHz Ant1 Ref

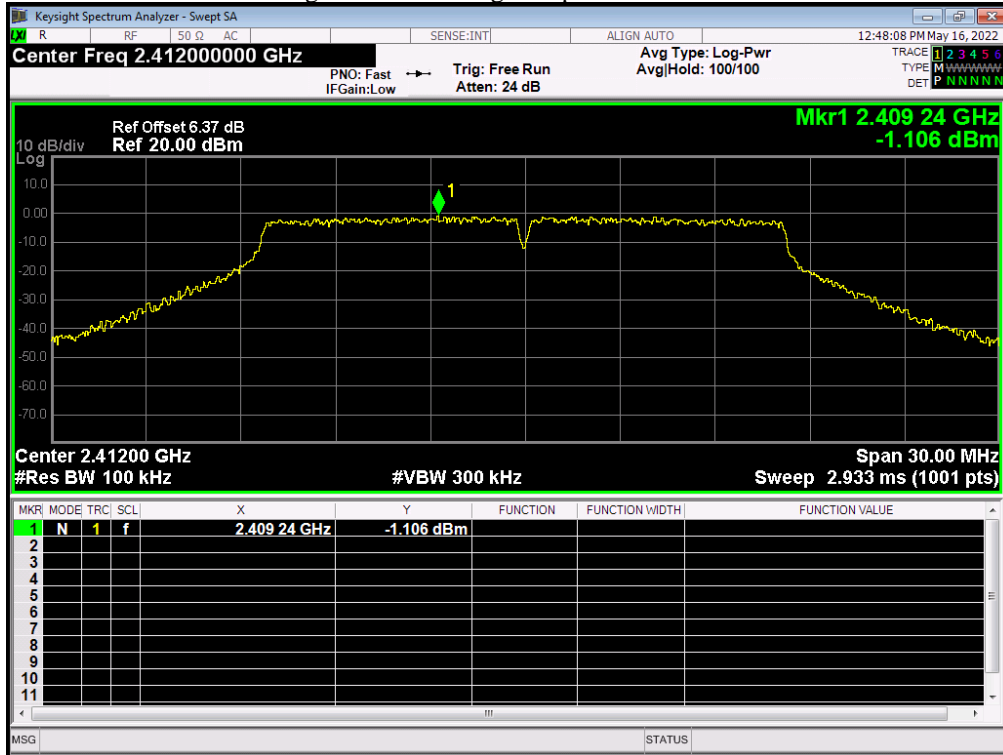

Band Edge NVNT 802.11g 6Mbps 2412MHz Ant1 Emission

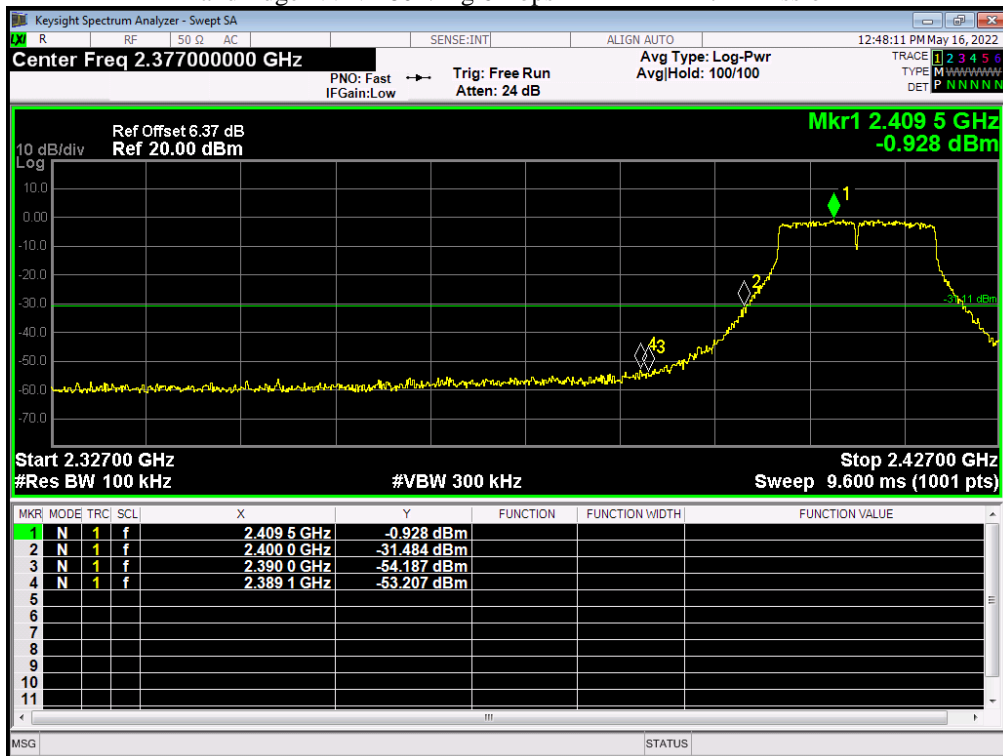

Band Edge NVNT 802.11g 6Mbps 2462MHz Ant1 Ref

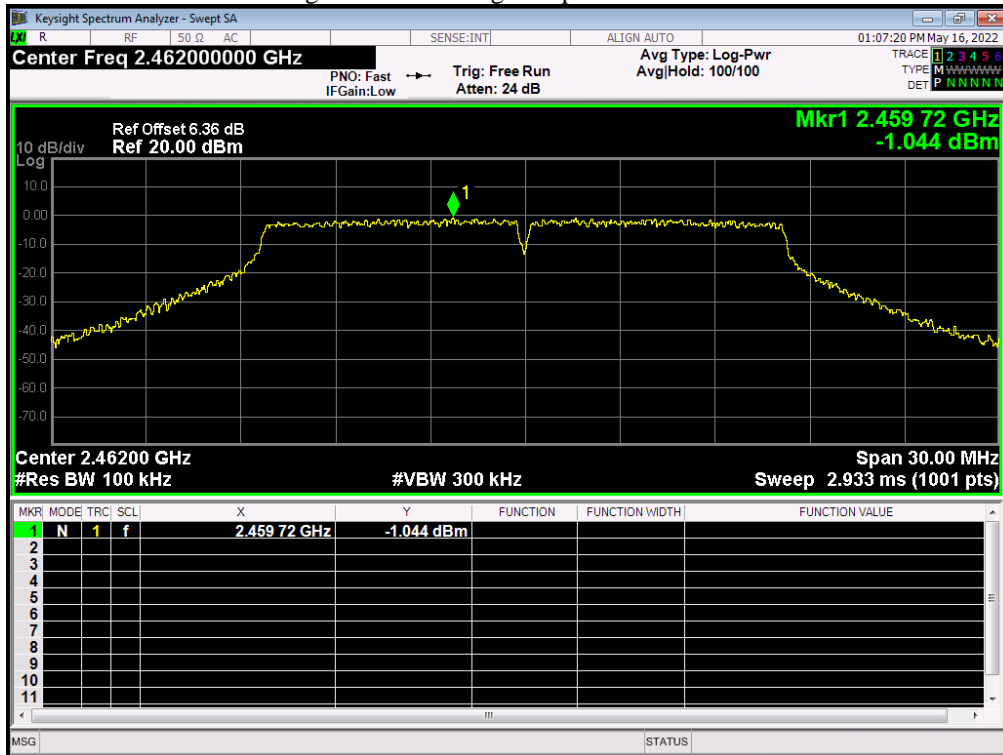

Band Edge NVNT 802.11g 6Mbps 2462MHz Ant1 Emission

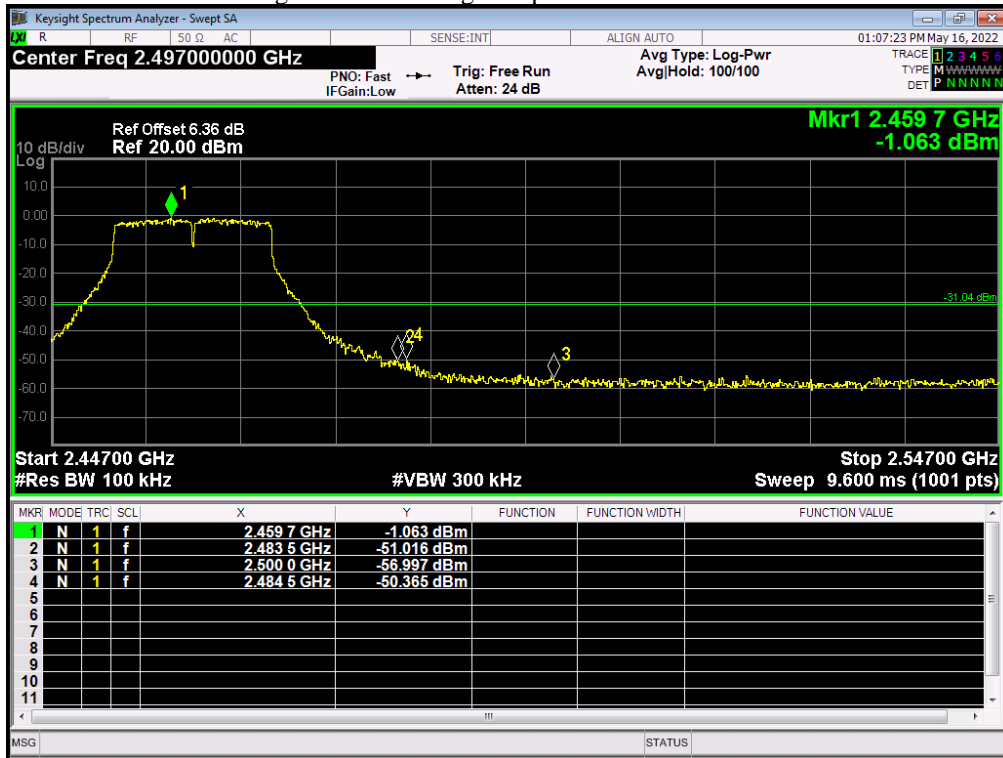

Condition	Mode	Frequency (MHz)	Antenna	Max Value (dBc)	Limit (dBc)	Verdict
NVNT	802.11n(HT20)	2412	Ant 1	-52.038	-30	Pass
NVNT	802.11n(HT20)	2462	Ant 1	-49.44	-30	Pass

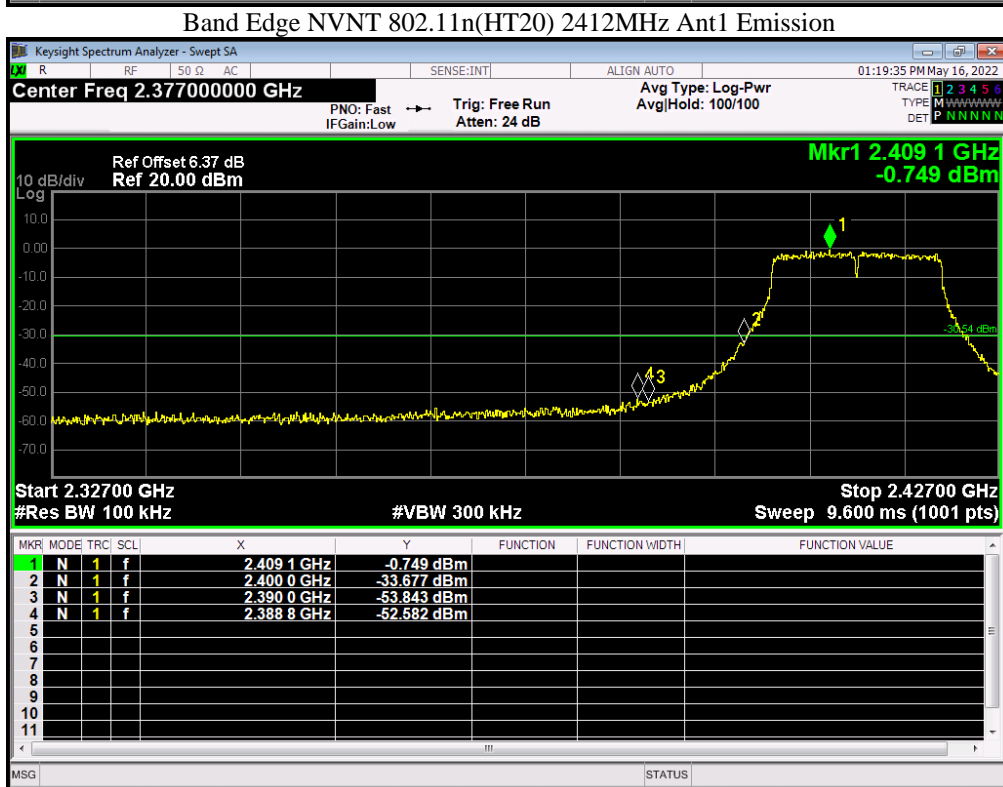
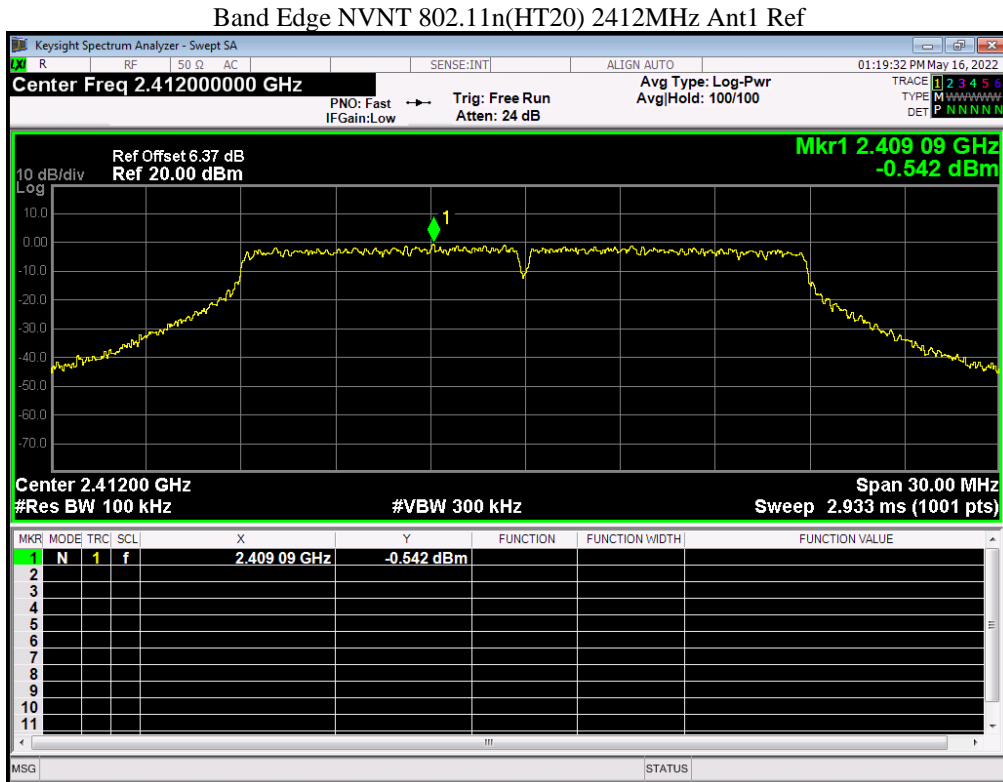

Band Edge NVNT 802.11n(HT20) 2462MHz Ant1 Ref

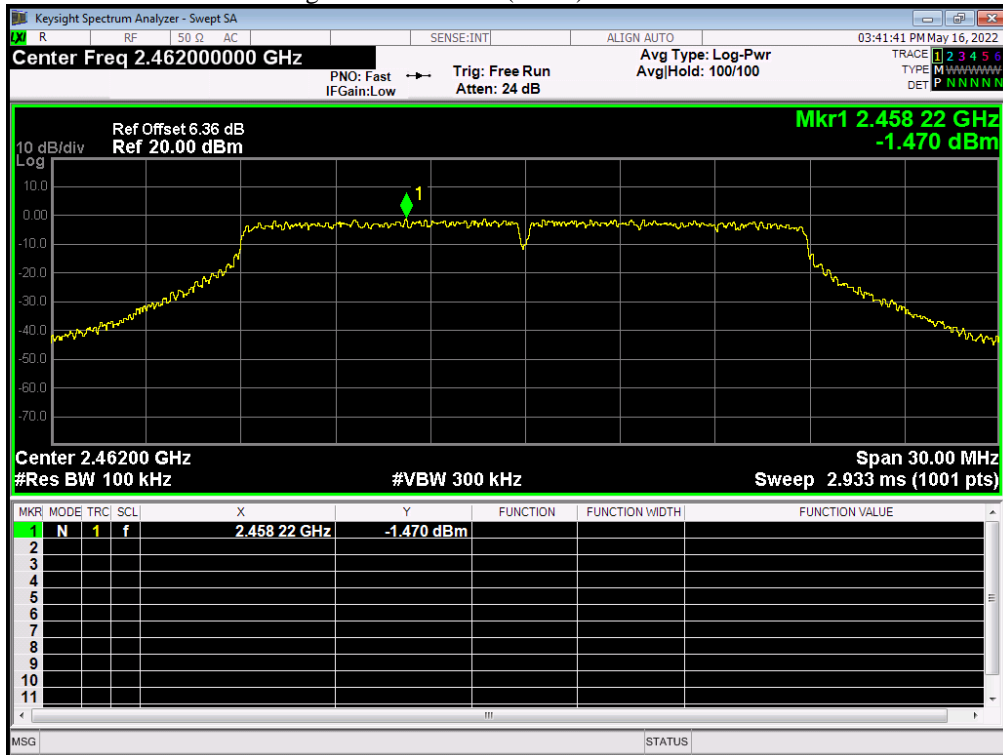

Band Edge NVNT 802.11n(HT20) 2462MHz Ant1 Emission

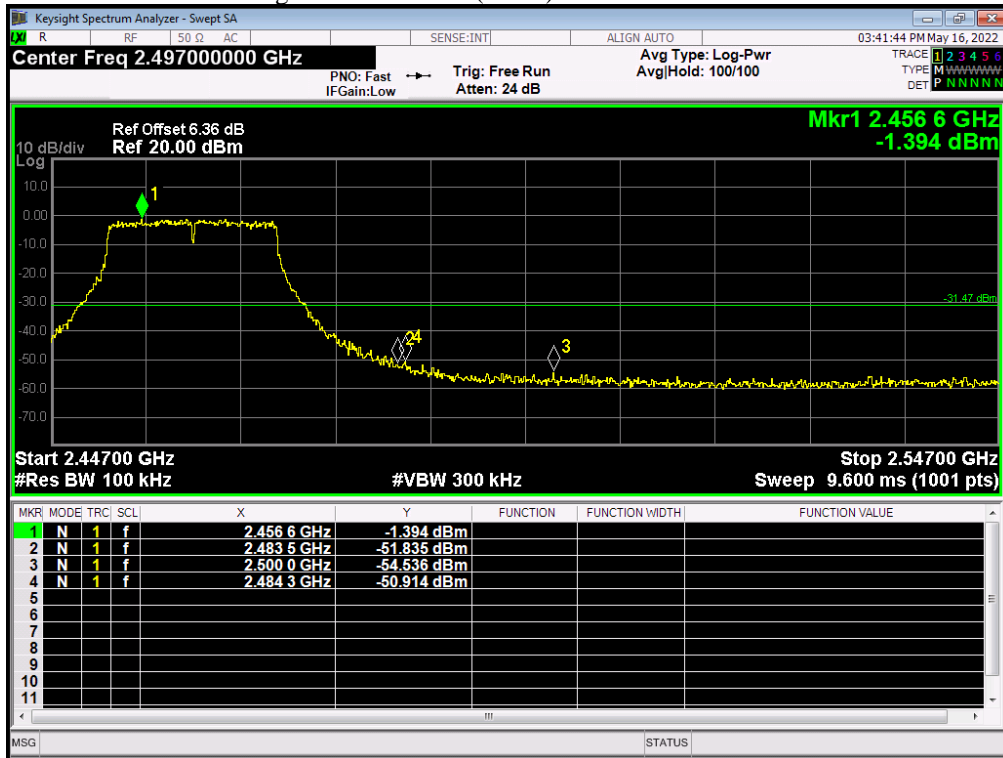

8. Conducted Spurious Emission

8.1. Test equipment

Item	Equipment	Manufacturer	Model No.	Serial No.	Last Cal.	Cal. Interval
1	MXA Signal Analyzer	KEYSIGHT	N9020A	MY5451047 6	2019/06/21	1 Year

8.2. BLOCK DIAGRAM OF TEST SETUP

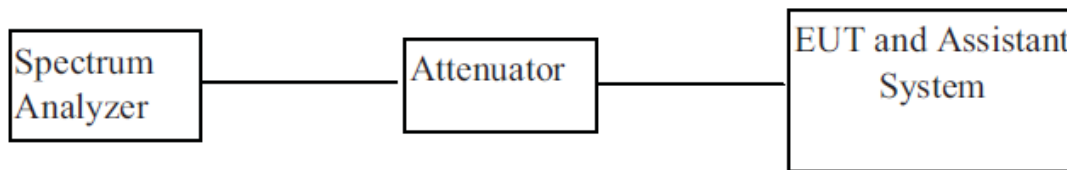

8.3. Limit

In any 100 KHz Bandwidth Outside the frequency band in which the spread spectrum intentional radiator is operating, the radio frequency power that is produce by the intentional radiator shall be at least 20 dB below that in 100KHz bandwidth within the band that contains the highest level of the desired power.

In addition, radiation emissions which fall in the restricted bands, as defined in §15.205(a), must also comply with the radiated emission limits specified in§15.209(a)

8.4. Test Procedure

1. Connect EUT RF output port to the Spectrum Analyzer through an RF attenuator
- 2, Set the EUT Work on the top, the middle and the bottom operation frequency individually.
3. Set SPA Trace 1 Max hold, then View.

Note: The EUT was tested according to KDB 558074 for compliance to FCC 47CFR 15.247 requirements. Owing to satisfy the requirements of the number of measurement points, we set the RBW=1MHz, VBW > RBW, scan up through 10th harmonic, and consider the tested results as the worst case, if the tested results conform to the requirement, we can deem that the real tested results(set the RBW=100KHz, VBW > RBW) are conform to the requirement.

8.5. Test result

Condition	Mode	Frequency (MHz)	Antenna	Max Value (dBc)	Limit (dBc)	Verdict
NVNT	802.11b 1Mbps	2412	Ant 1	-48.700	-20	Pass
NVNT	802.11b 1Mbps	2437	Ant 1	-48.980	-20	Pass
NVNT	802.11b 1Mbps	2462	Ant 1	-48.630	-20	Pass

Tx. Spurious NVNT 802.11b 1Mbps 2412MHz Ant1 Ref

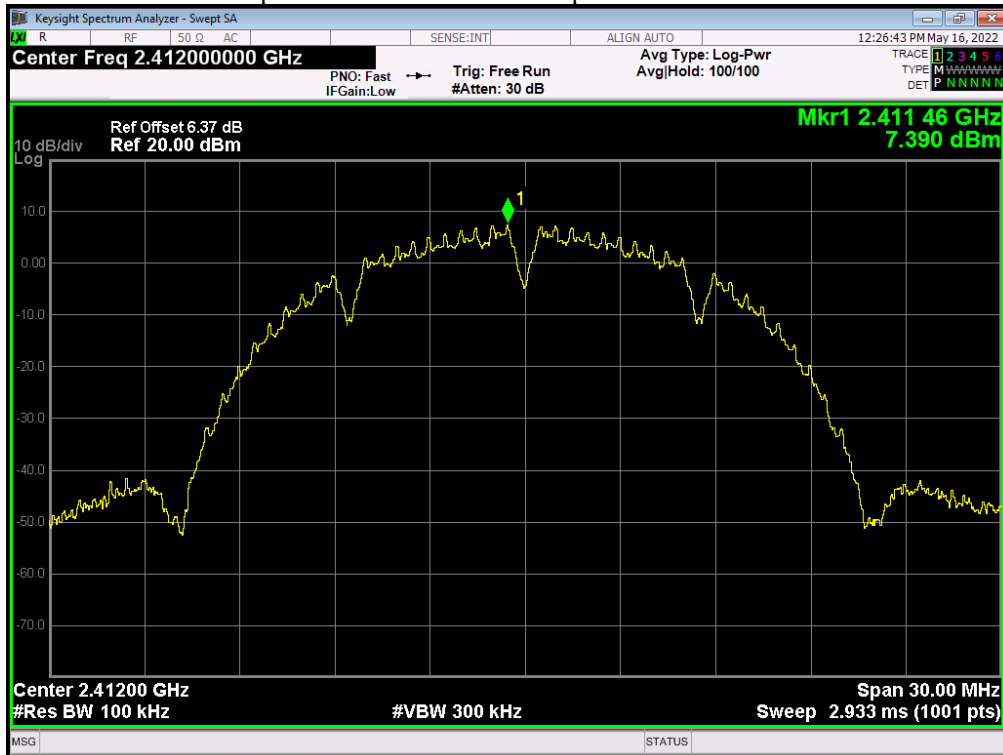

Tx. Spurious NVNT 802.11b 1Mbps 2412MHz Ant1 Emission

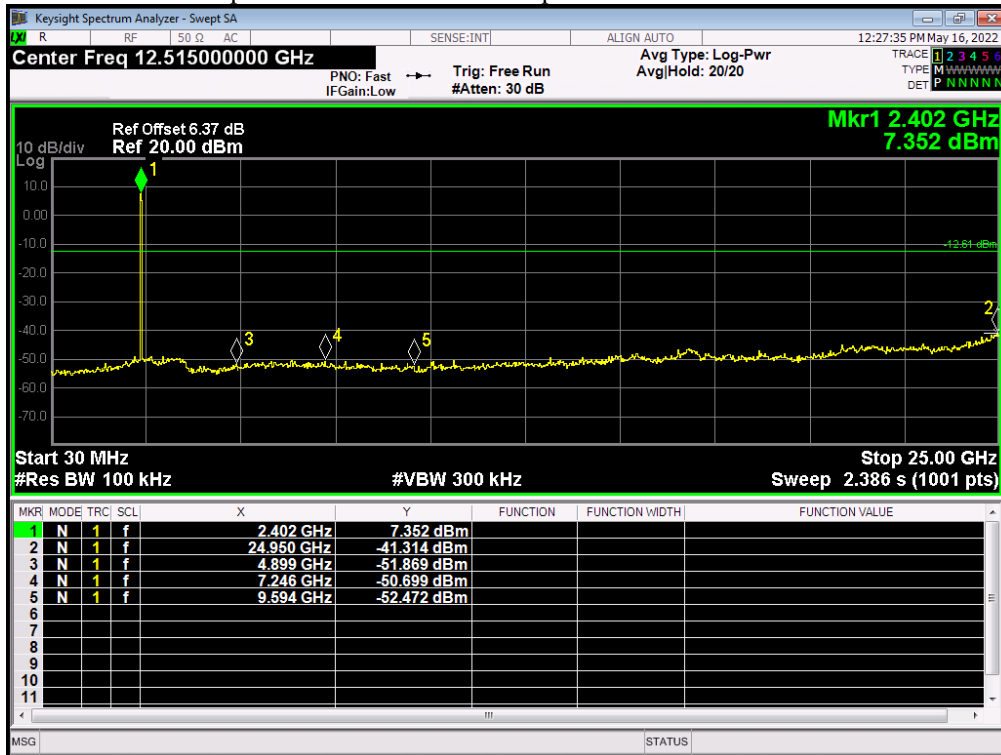

Tx. Spurious NVNT 802.11b 1Mbps 2437MHz Ant1 Ref

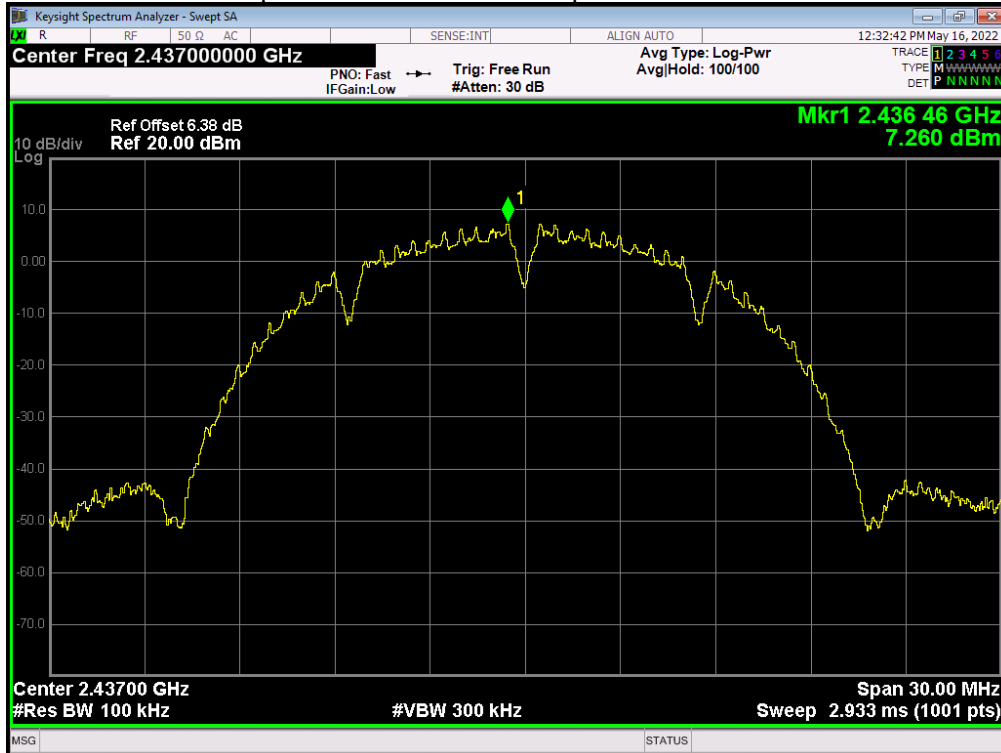

Tx. Spurious NVNT 802.11b 1Mbps 2437MHz Ant1 Emission

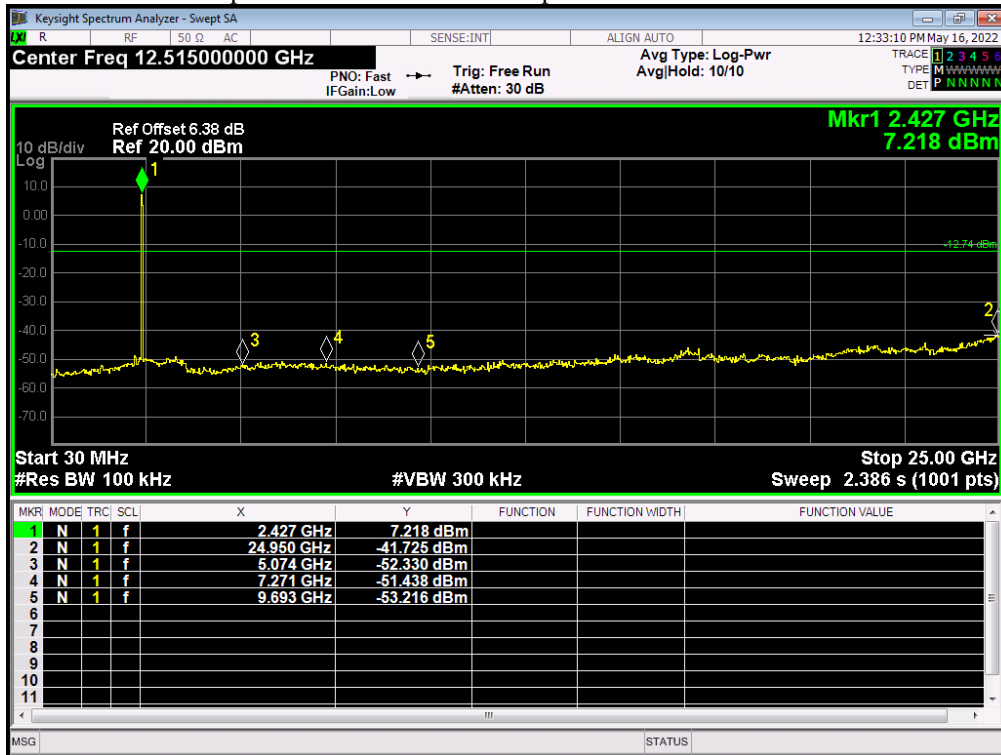

Tx. Spurious NVNT 802.11b 1Mbps 2462MHz Ant1 Ref

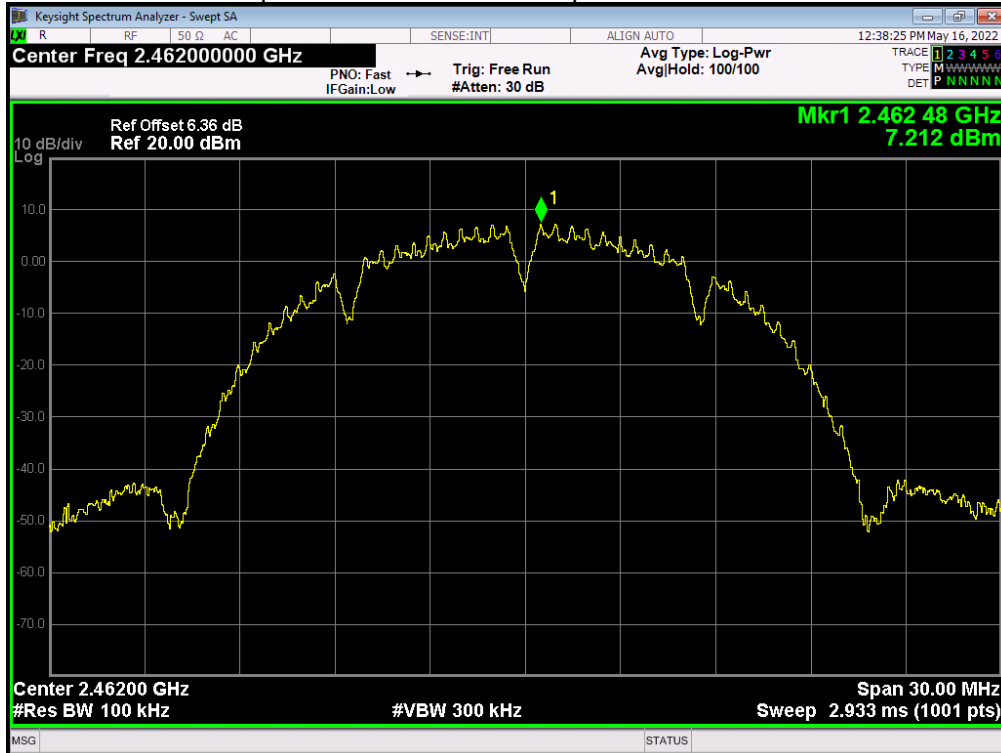

Tx. Spurious NVNT 802.11b 1Mbps 2462MHz Ant1 Emission

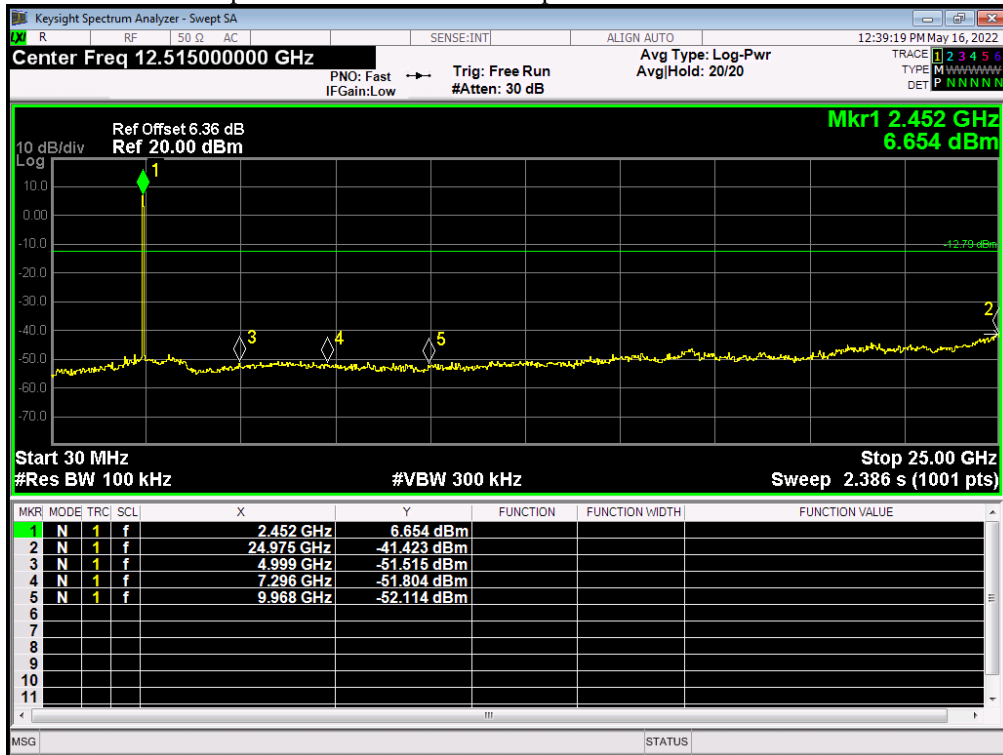

Condition	Mode	Frequency (MHz)	Antenna	Max Value (dBc)	Limit (dBc)	Verdict
NVNT	802.11g 6Mbps	2412	Ant 1	-40.382	-20	Pass
NVNT	802.11g 6Mbps	2437	Ant 1	-40.344	-20	Pass
NVNT	802.11g 6Mbps	2462	Ant 1	-40.569	-20	Pass

Tx. Spurious NVNT 802.11g 6Mbps 2412MHz Ant1 Ref

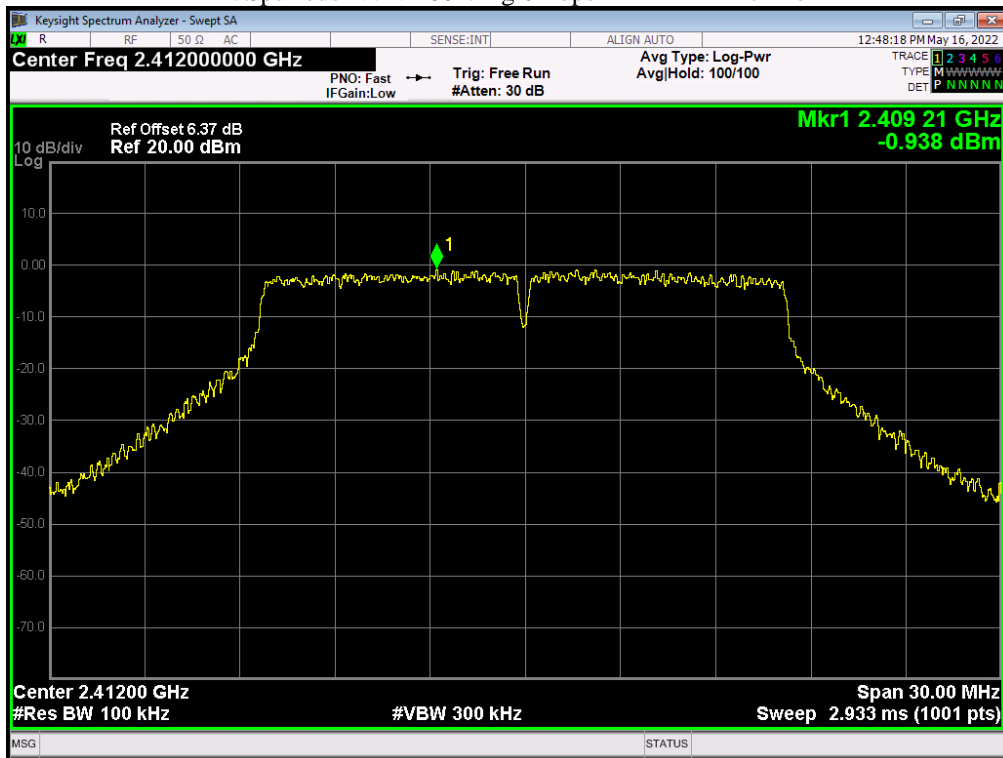

Tx. Spurious NVNT 802.11g 6Mbps 2412MHz Ant1 Emission

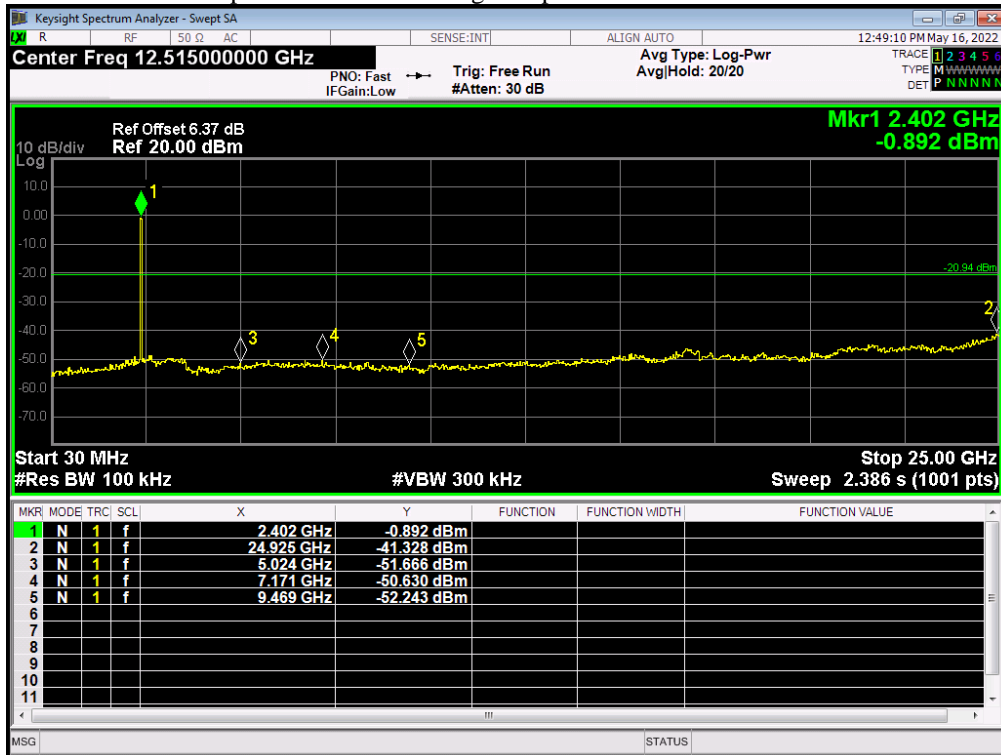

Tx. Spurious NVNT 802.11g 6Mbps 2437MHz Ant1 Ref

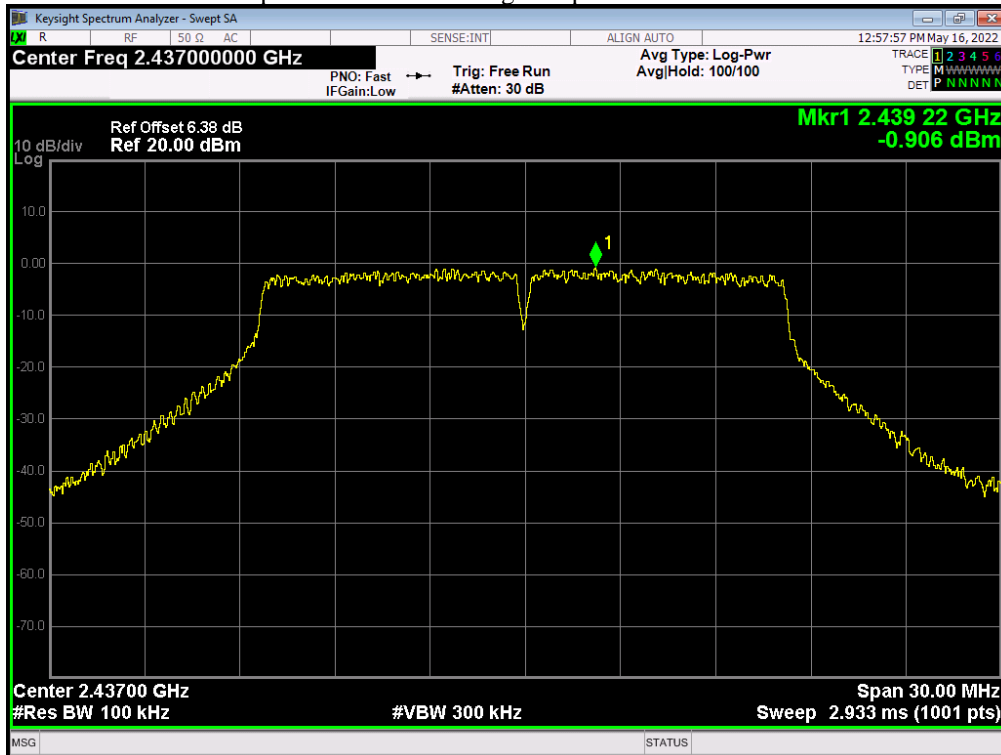

Tx. Spurious NVNT 802.11g 6Mbps 2437MHz Ant1 Emission

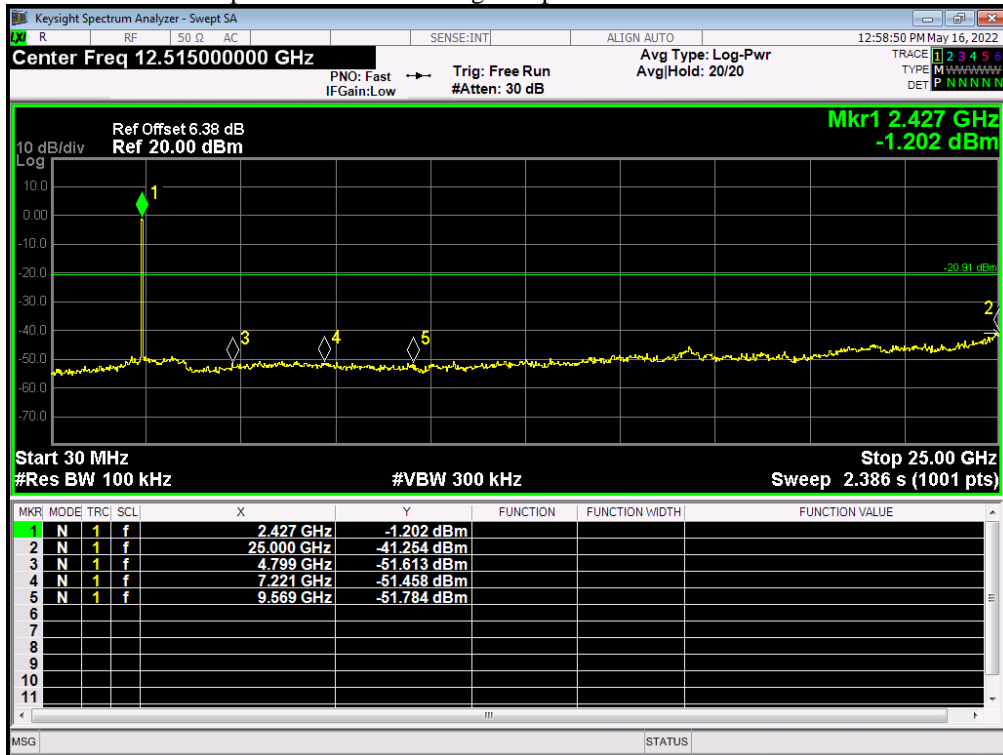

Tx. Spurious NVNT 802.11g 6Mbps 2462MHz Ant1 Ref

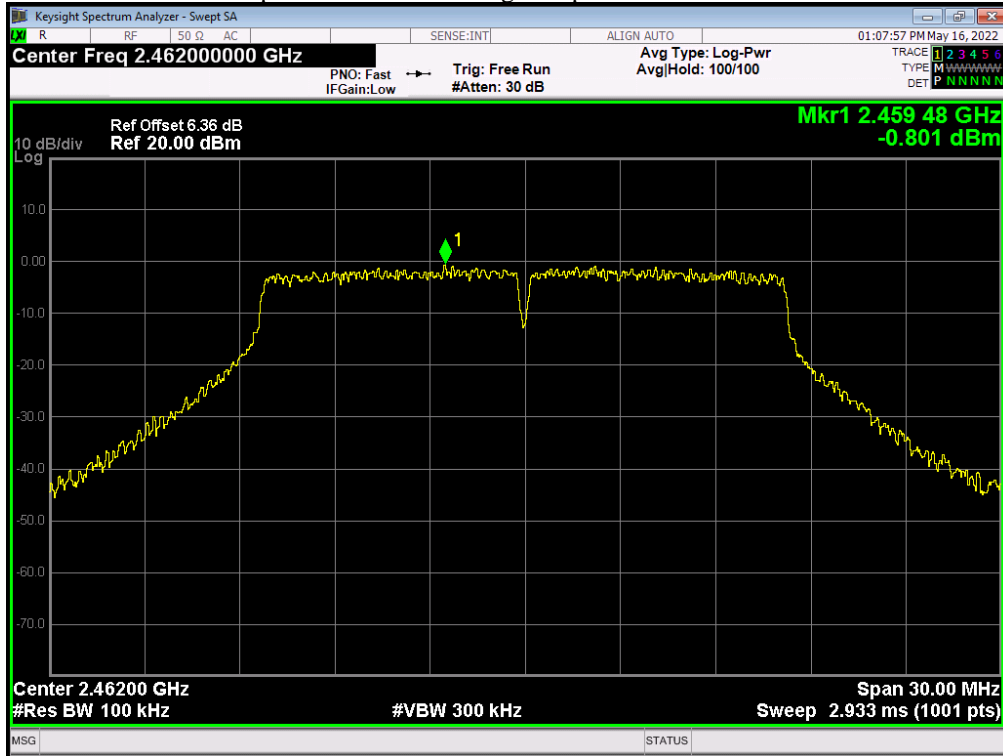

Tx. Spurious NVNT 802.11g 6Mbps 2462MHz Ant1 Emission

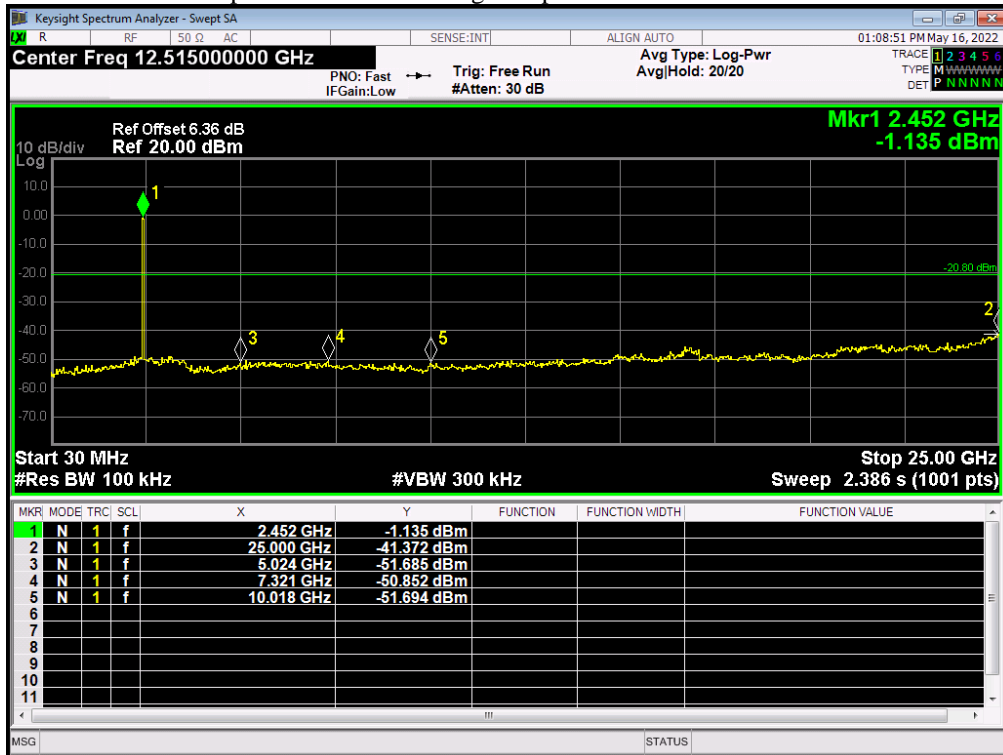

Condition	Mode	Frequency (MHz)	Antenna	Max Value (dBc)	Limit (dBc)	Verdict
NVNT	802.11n(HT20)	2412	Ant 1	-40.102	-20	Pass
NVNT	802.11n(HT20)	2437	Ant 1	-39.043	-20	Pass
NVNT	802.11n(HT20)	2462	Ant 1	-40.55	-20	Pass

Tx. Spurious NVNT 802.11n(HT20) 2412MHz Ant1 Ref

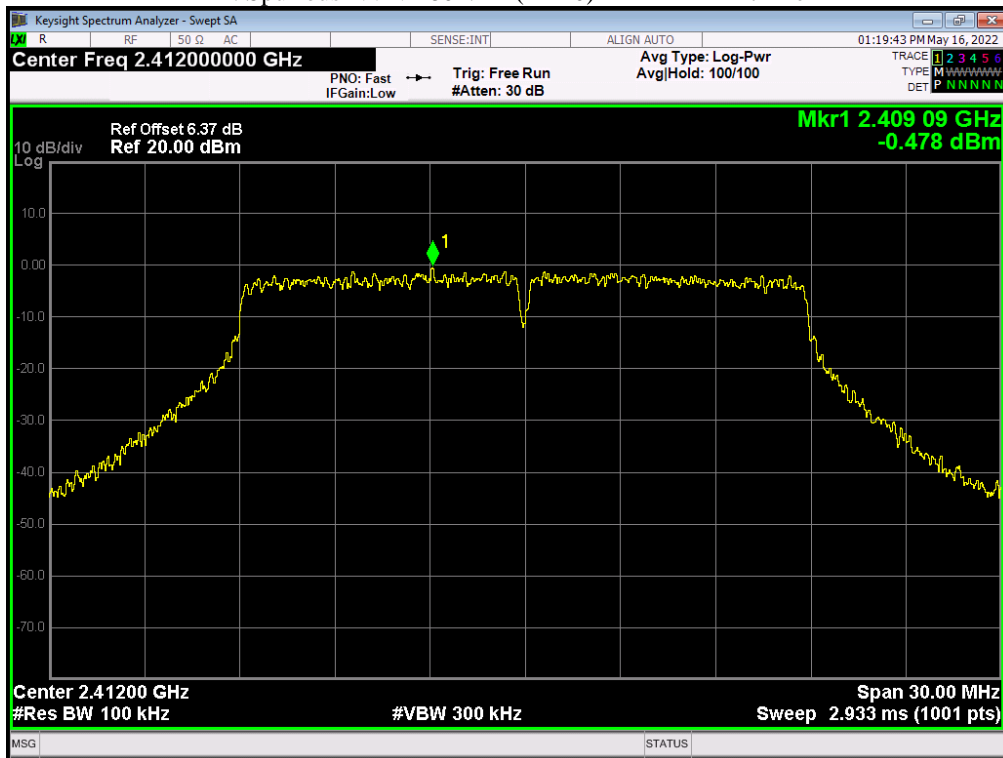

Tx. Spurious NVNT 802.11n(HT20) 2412MHz Ant1 Emission

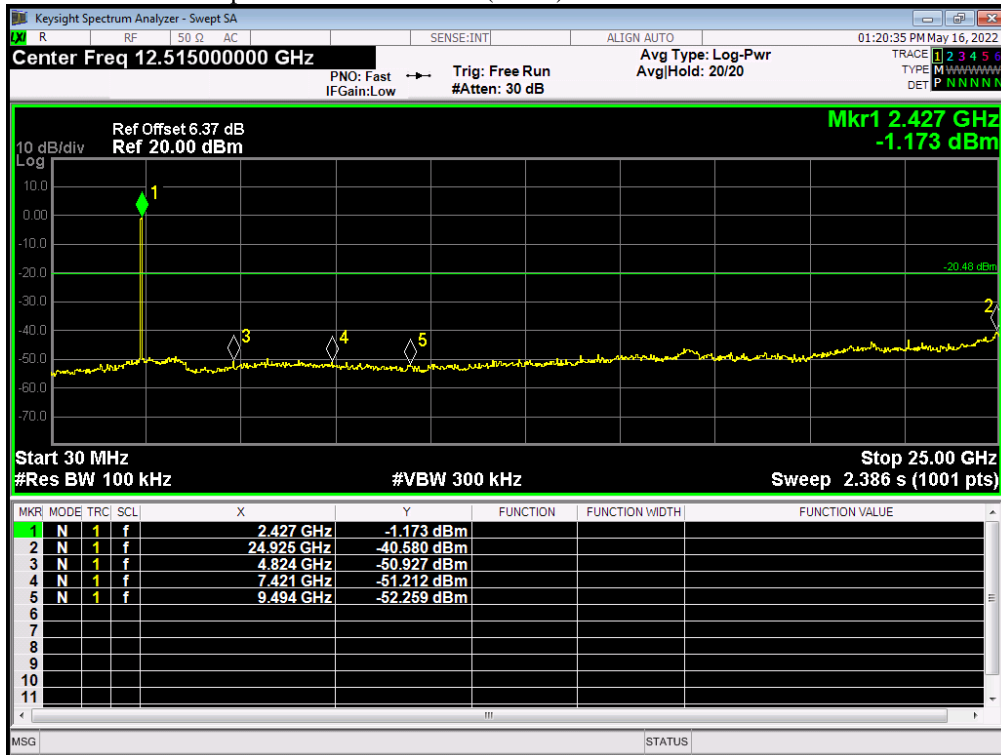

Tx. Spurious NVNT 802.11n(HT20) 2437MHz Ant1 Ref

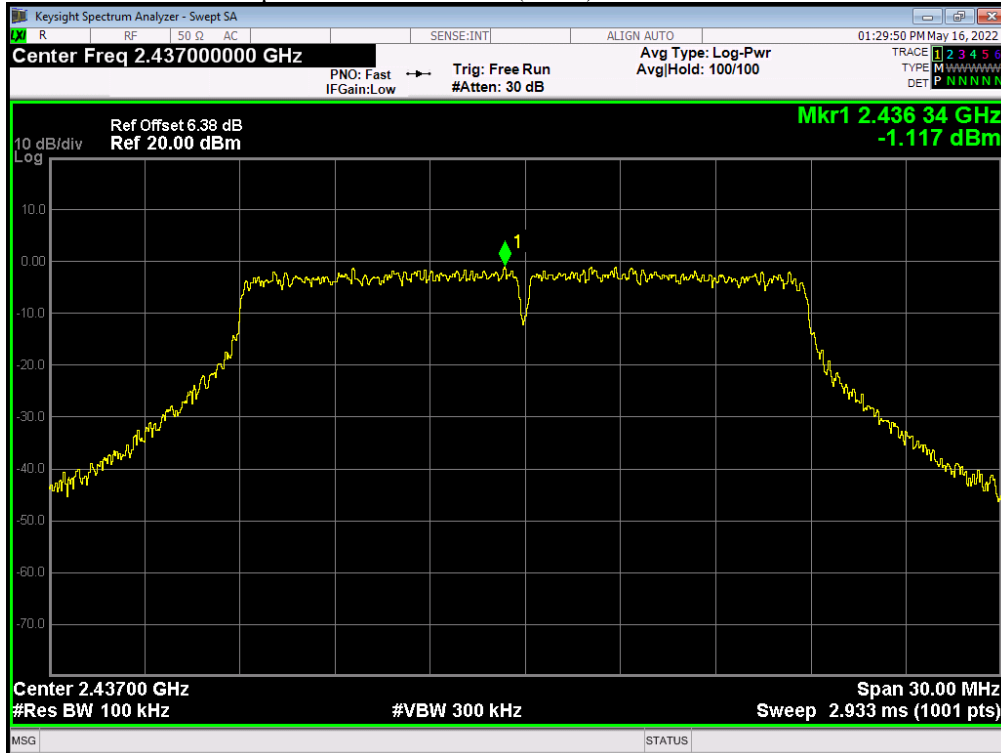

Tx. Spurious NVNT 802.11n(HT20) 2437MHz Ant1 Emission

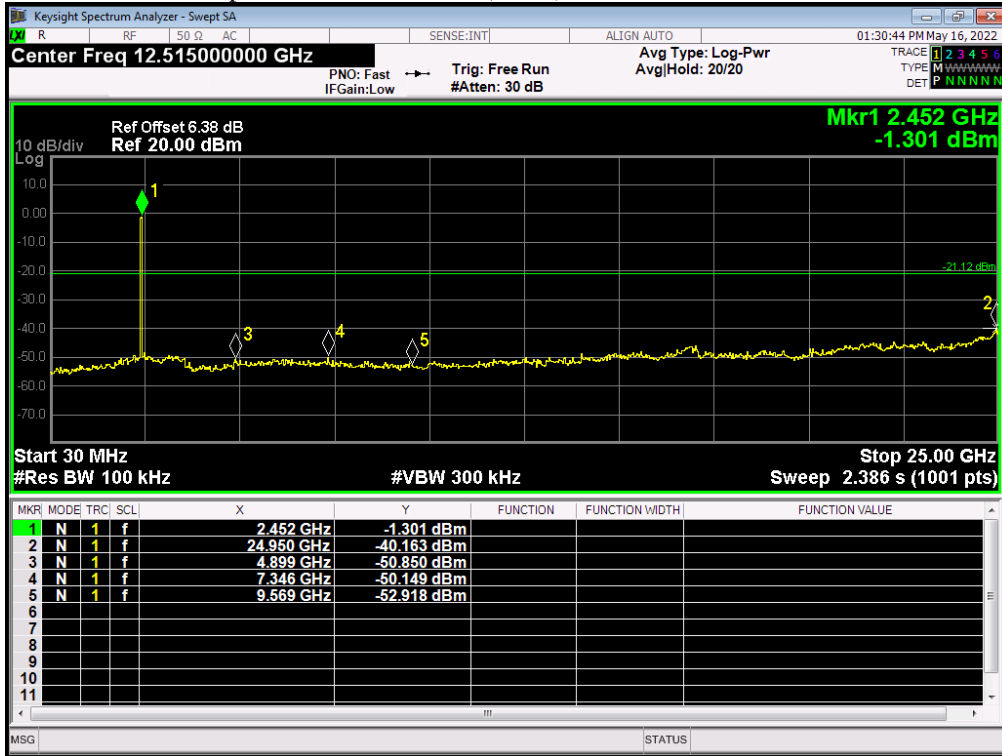

Tx. Spurious NVNT 802.11n(HT20) 2462MHz Ant1 Ref

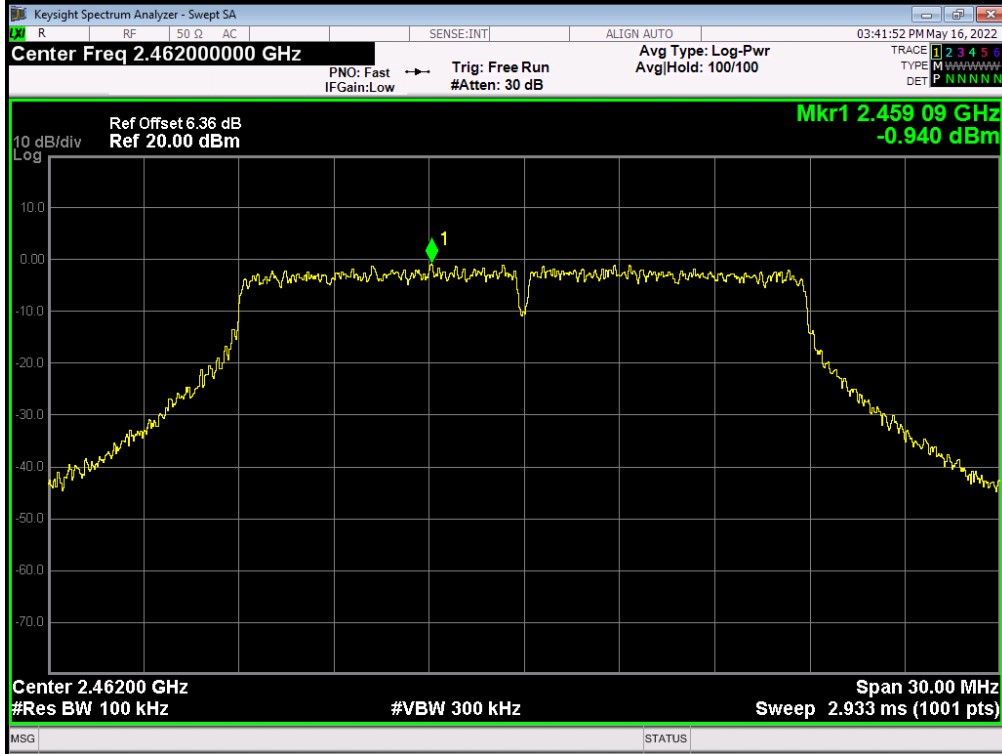

Tx. Spurious NVNT 802.11n(HT20) 2462MHz Ant1 Emission

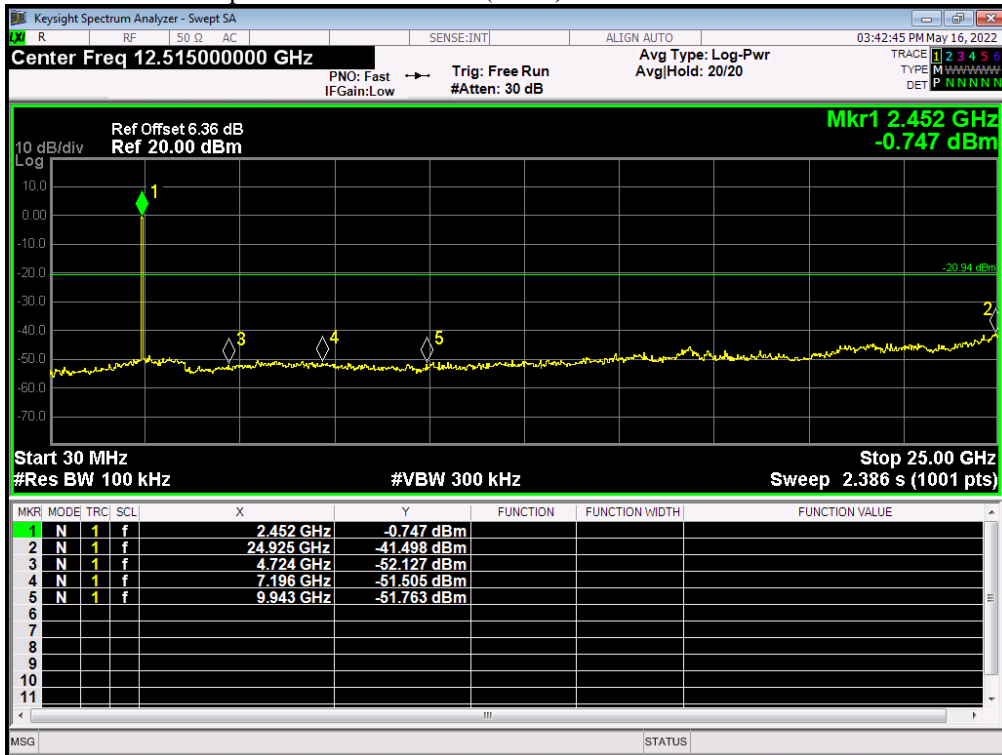

9. Conducted Output Power Spectral Density

9.1. Test equipment

Item	Equipment	Manufacturer	Model No.	Serial No.	Last Cal.	Cal. Interval
1	MXA Signal Analyzer	KEYSIGHT	N9020A	MY5451047 6	2020/05/25	1 Year

9.2. Block diagram of test setup

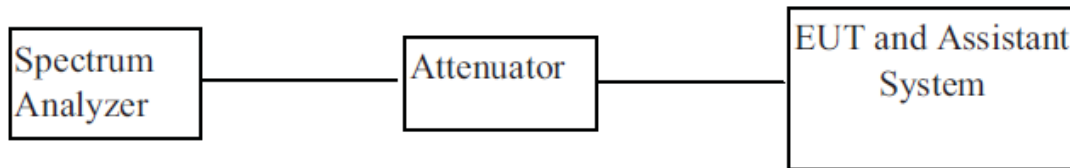

9.3. Limit

For digitally modulated systems, the power spectral density conducted from the intentional radiator to the antenna shall not be greater than 8 dBm in any 3 kHz band during any time interval of continuous transmission.

9.4. Test Procedure

- (1). Connect EUT RF output port to the Spectrum Analyzer through an RF attenuator
- (2). Set the EUT Work on the top, the middle and the bottom operation frequency individually.
- (3). Set SPA Trace 1 Max hold, then View.

9.5. Test result

Condition	Mode	Frequency (MHz)	Antenna	Max PSD (dBm/3kHz)	Limit (dBm/3kHz)	Verdict
NVNT	802.11b 1Mbps	2412	Ant 1	-14.222	8	Pass
NVNT	802.11b 1Mbps	2437	Ant 1	-14.314	8	Pass
NVNT	802.11b 1Mbps	2462	Ant 1	-14.445	8	Pass

PSD NVNT 802.11b 1Mbps 2412MHz Ant1

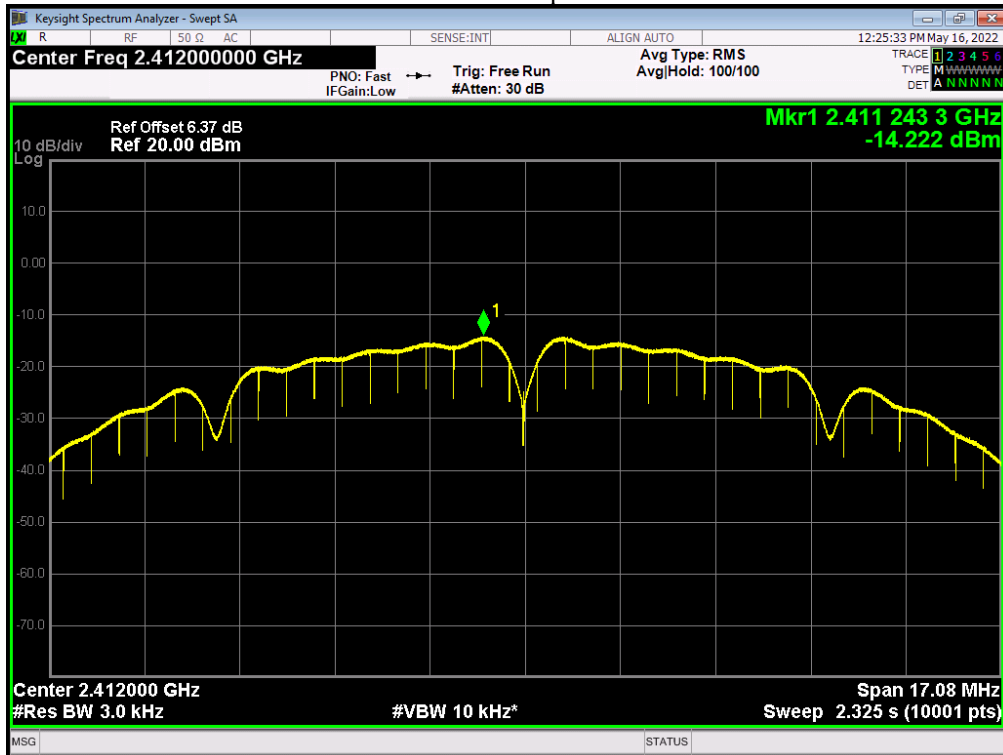

PSD NVNT 802.11b 1Mbps 2437MHz Ant1

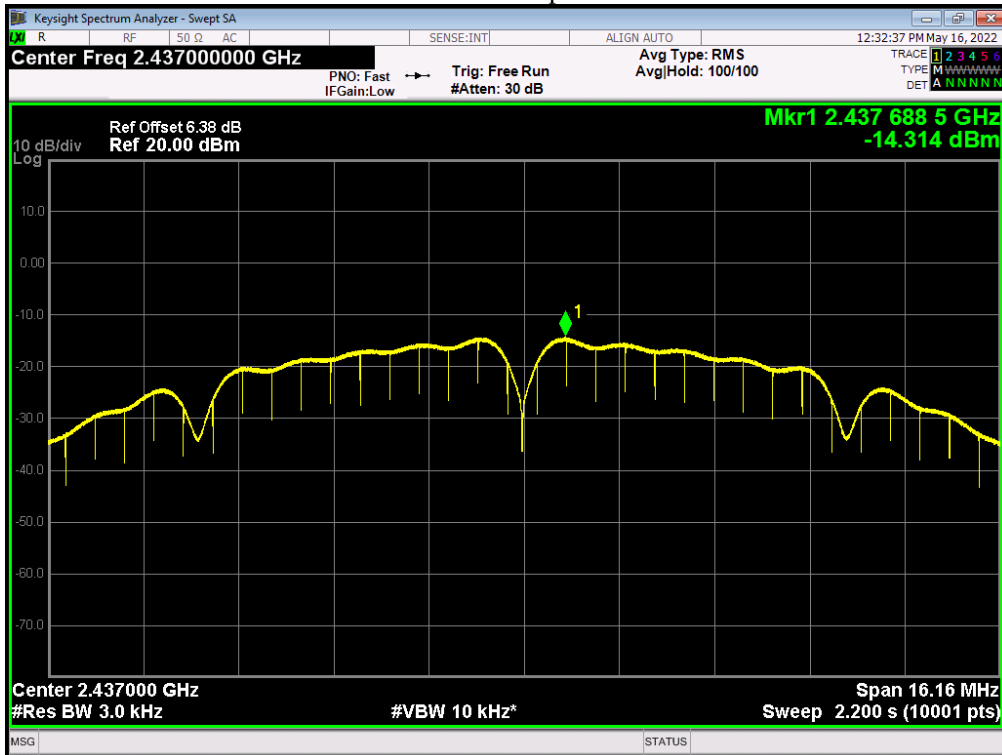

PSD NVNT 802.11b 1Mbps 2462MHz Ant1

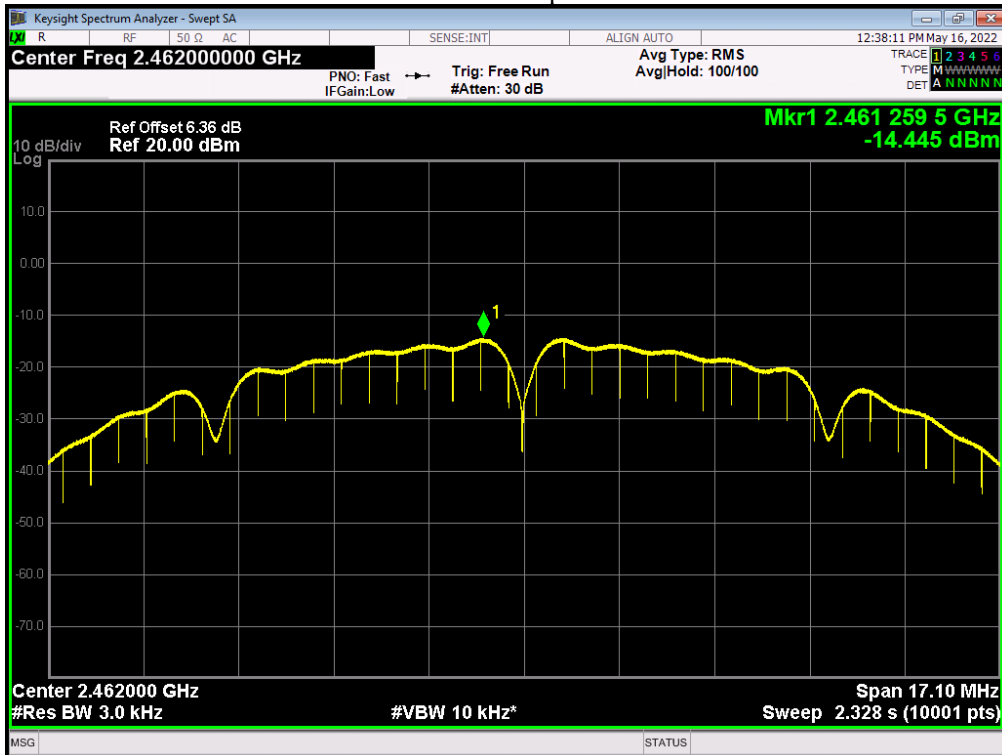

Condition	Mode	Frequency (MHz)	Antenna	Max PSD (dBm/3kHz)	Limit (dBm/3kHz)	Verdict
NVNT	802.11g 6Mbps	2412	Ant 1	-17.891	8	Pass
NVNT	802.11g 6Mbps	2437	Ant 1	-17.947	8	Pass
NVNT	802.11g 6Mbps	2462	Ant 1	-17.938	8	Pass

PSD NVNT 802.11g 6Mbps 2412MHz Ant1

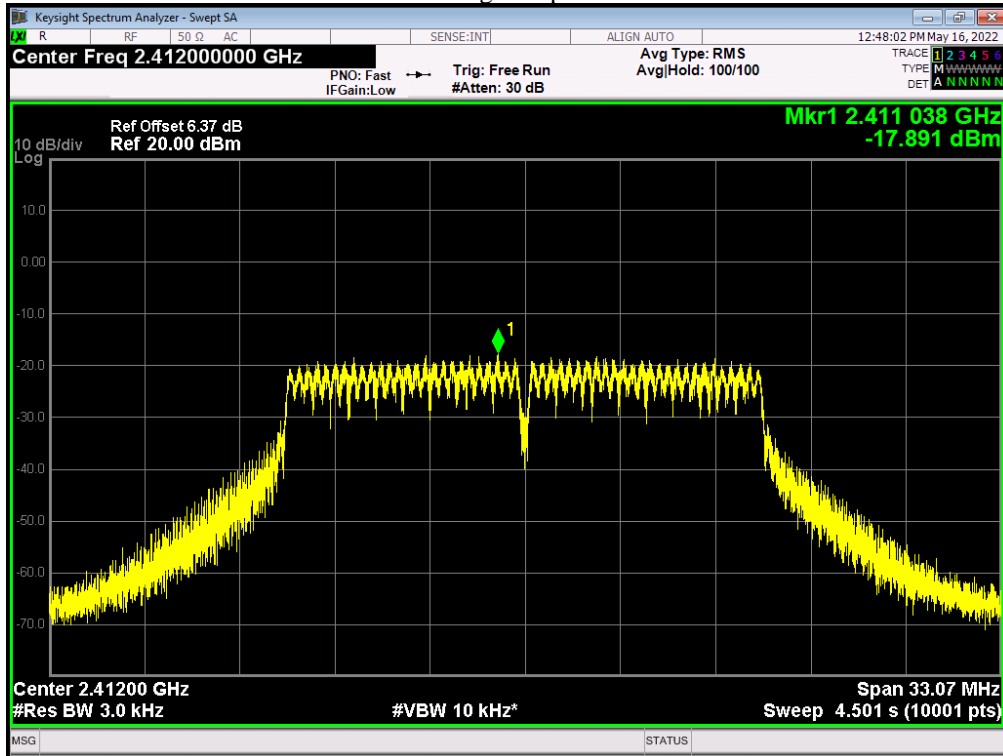

PSD NVNT 802.11g 6Mbps 2437MHz Ant1

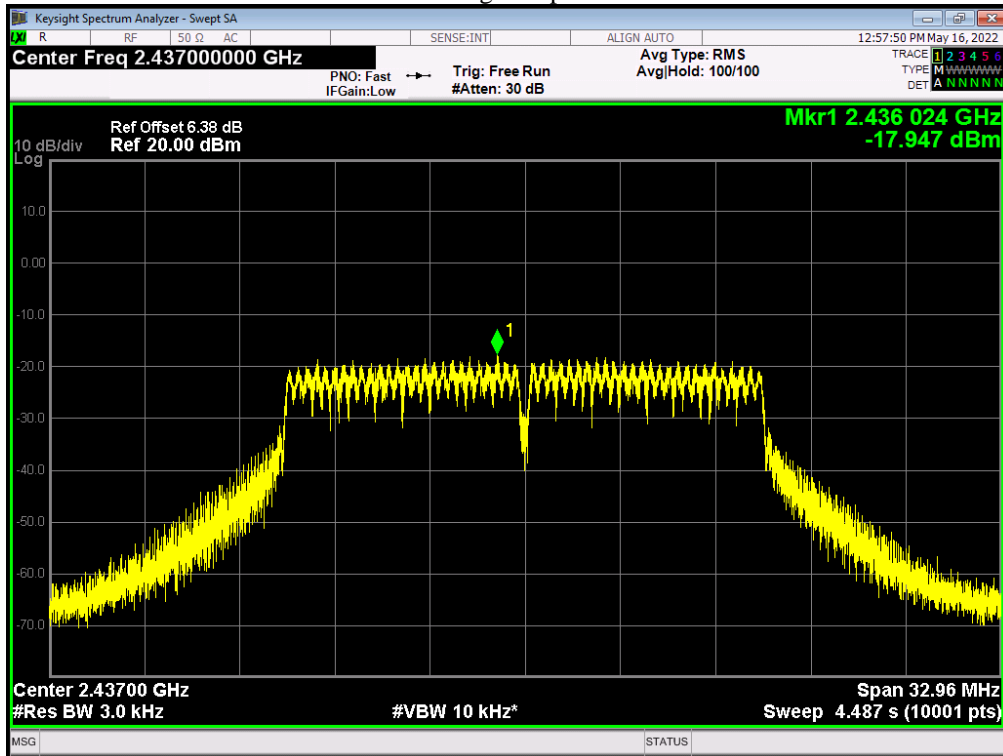

PSD NVNT 802.11g 6Mbps 2462MHz Ant1

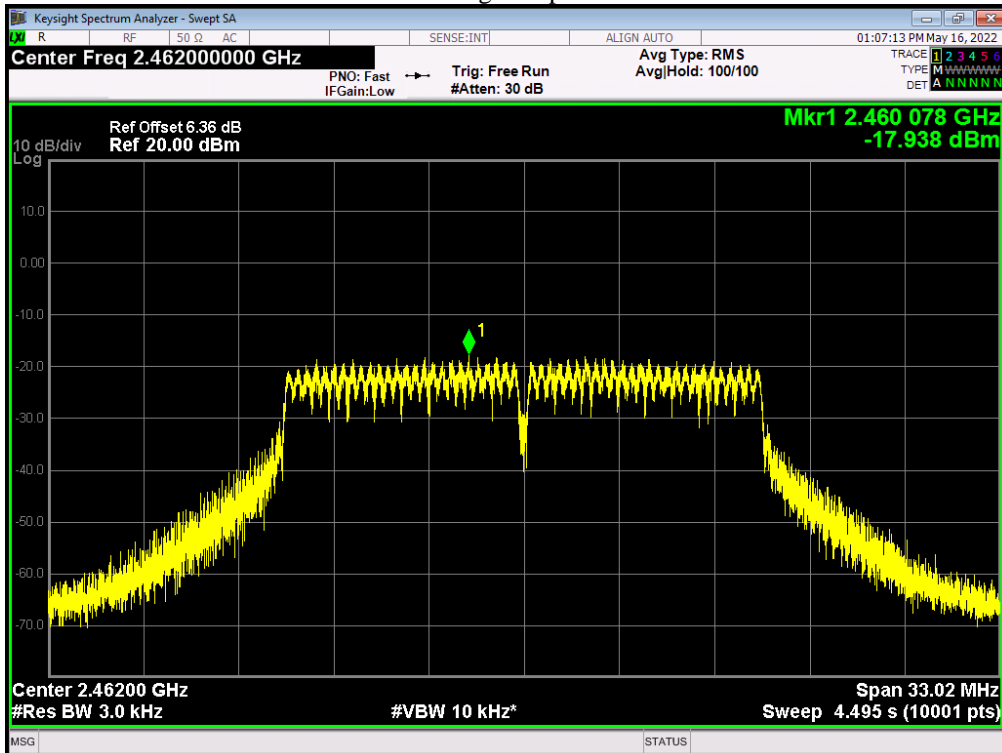

Condition	Mode	Frequency (MHz)	Antenna	Max PSD (dBm/3kHz)	Limit (dBm/3kHz)	Verdict
NVNT	802.11n(HT20)	2412	Ant 1	-16.748	8	Pass
NVNT	802.11n(HT20)	2437	Ant 1	-17.63	8	Pass
NVNT	802.11n(HT20)	2462	Ant 1	-16.78	8	Pass

PSD NVNT 802.11n(HT20) 2412MHz Ant1

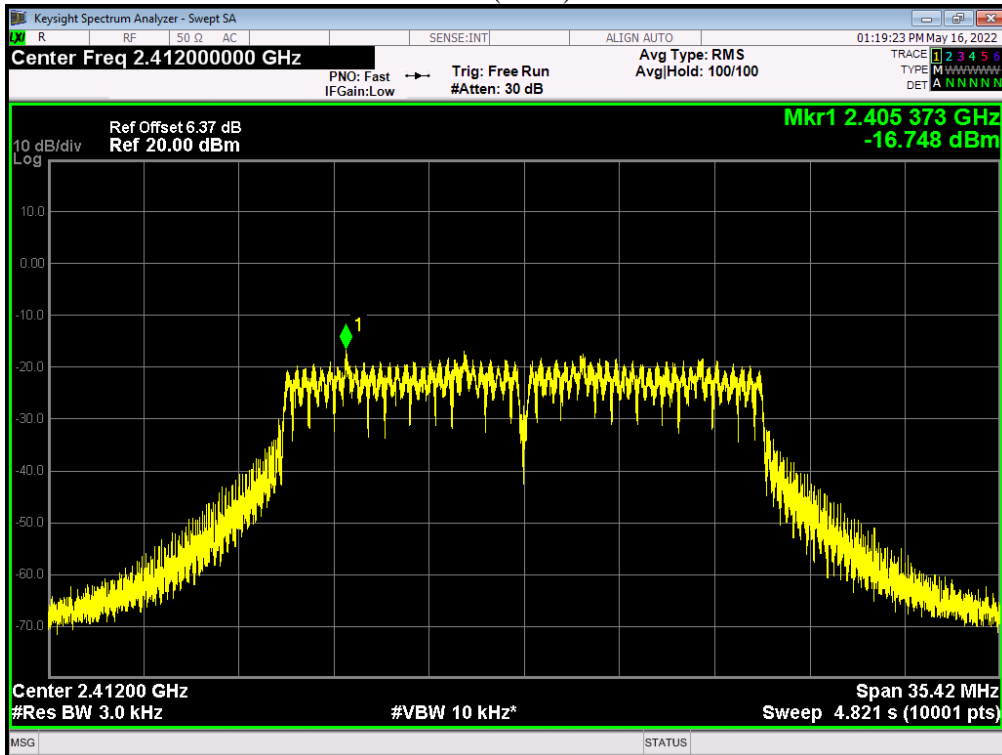

PSD NVNT 802.11n(HT20) 2437MHz Ant1

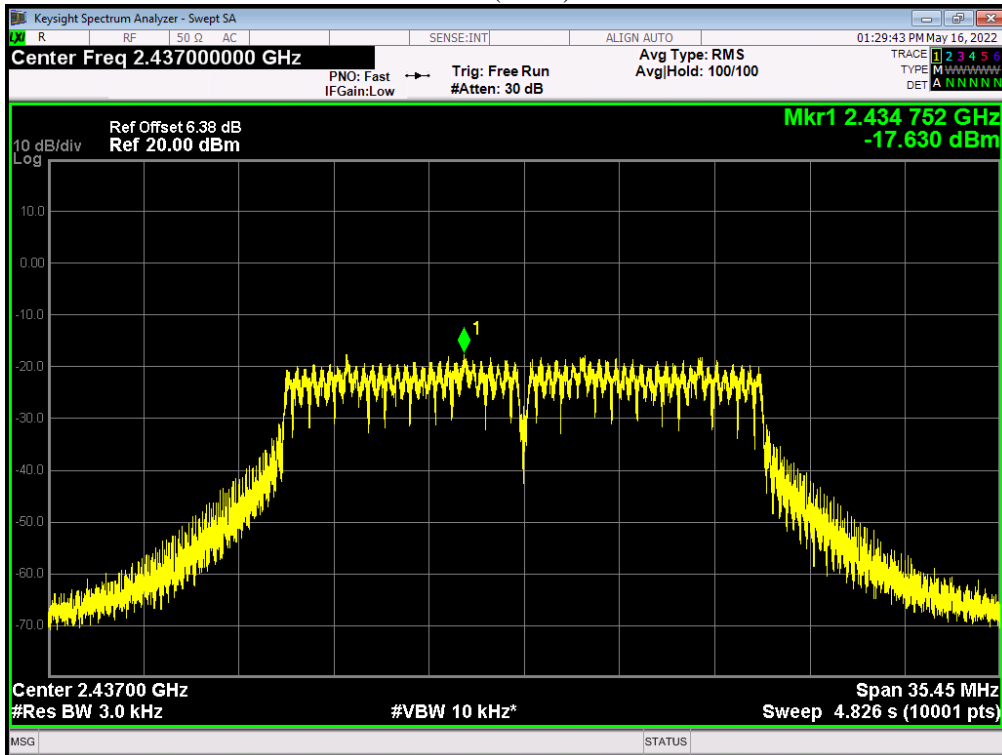

PSD NVNT 802.11n(HT20) 2462MHz Ant1

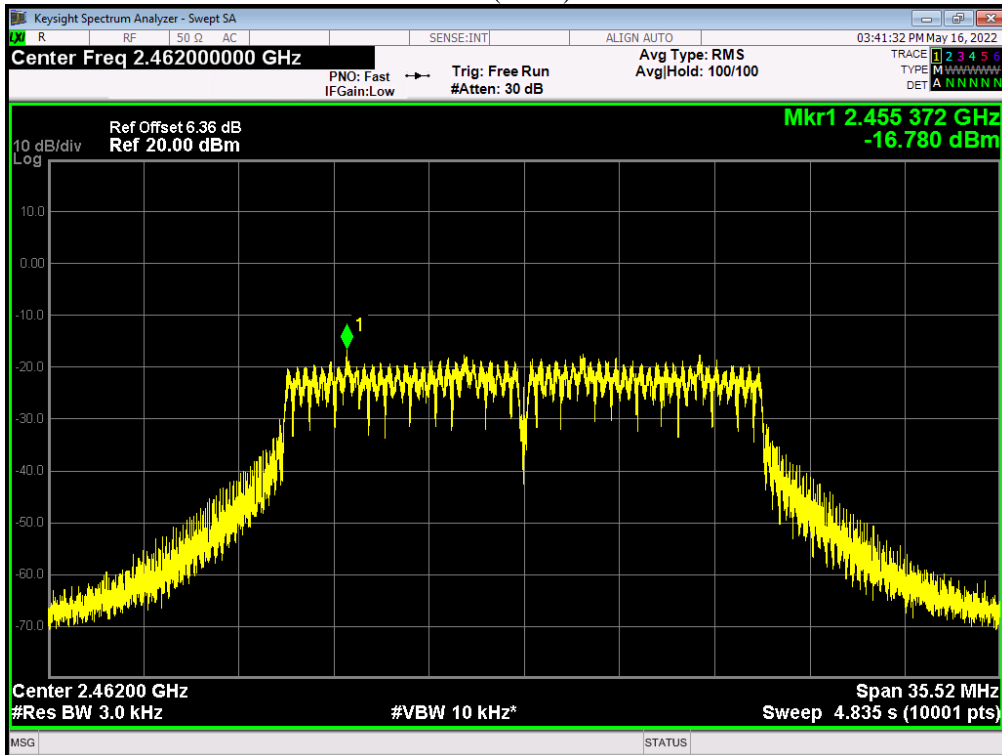

10. Antenna Requirement

10.1. Standard requirement

15.203 requirement: For intentional device, according to 15.203: an intentional radiator shall be designed to ensure that no antenna other than that furnished by the responsible party shall be used with the device.

15.247(c) (1)(i) requirement: (i) Systems operating in the 2400-2483.5 MHz band that is used exclusively for fixed. Point-to-point operations may employ transmitting antennas with directional gain greater than 6dBi provided the maximum conducted output power of the intentional radiator is reduced by 1 dB for every 3 dB that the directional gain of the antenna exceeds 6dBi.

10.2. EUT Antenna

The antenna is Integral Antenna and no consideration of replacement. Antenna gain is Maximum 1.98dBi from 2.4GHz to 2.5GHz.

11. Test setup photograph

11.1. Photos of power line conducted emission test



11.2. Photos of radiated emission test

30MHz – 1GHz



Above 1GHz



12. Photos of the EUT

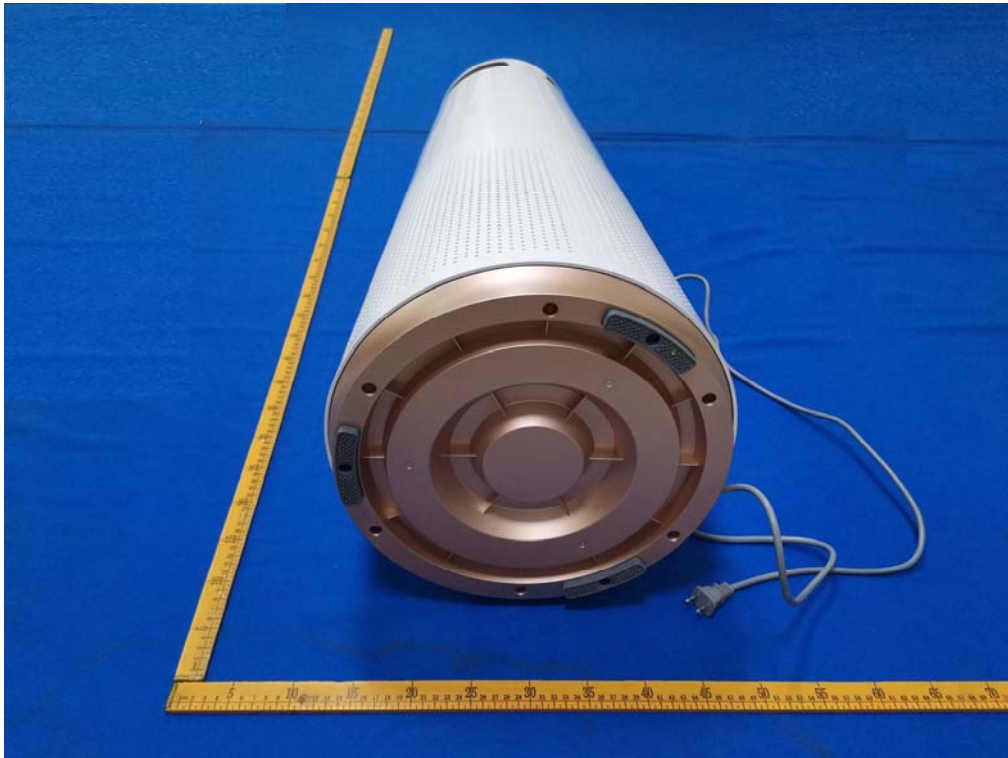



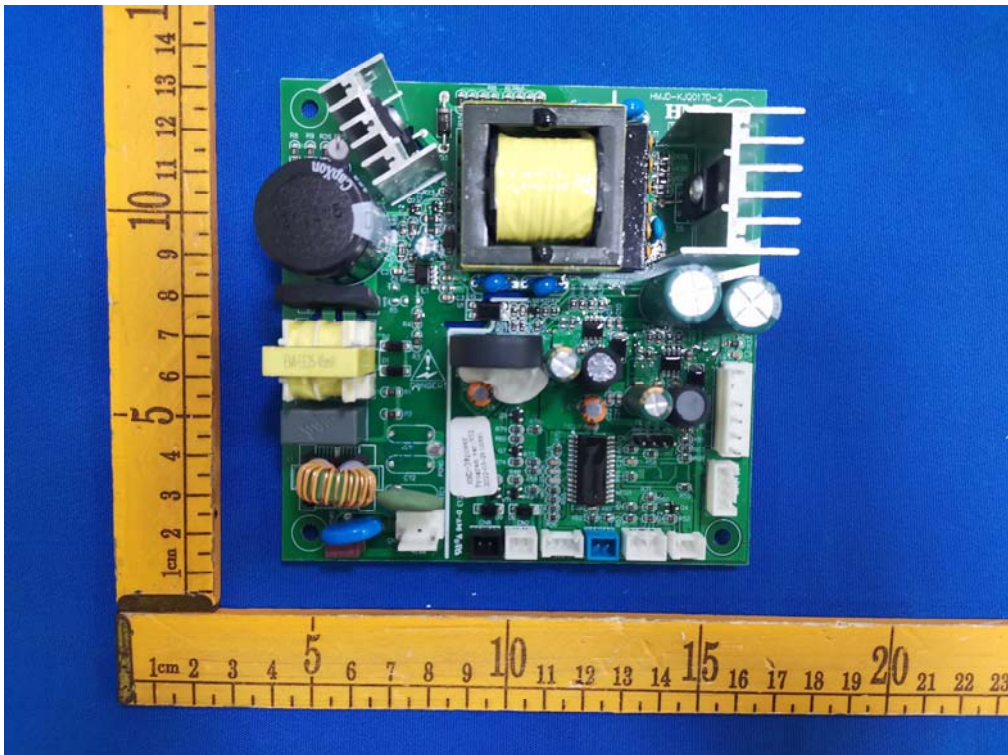
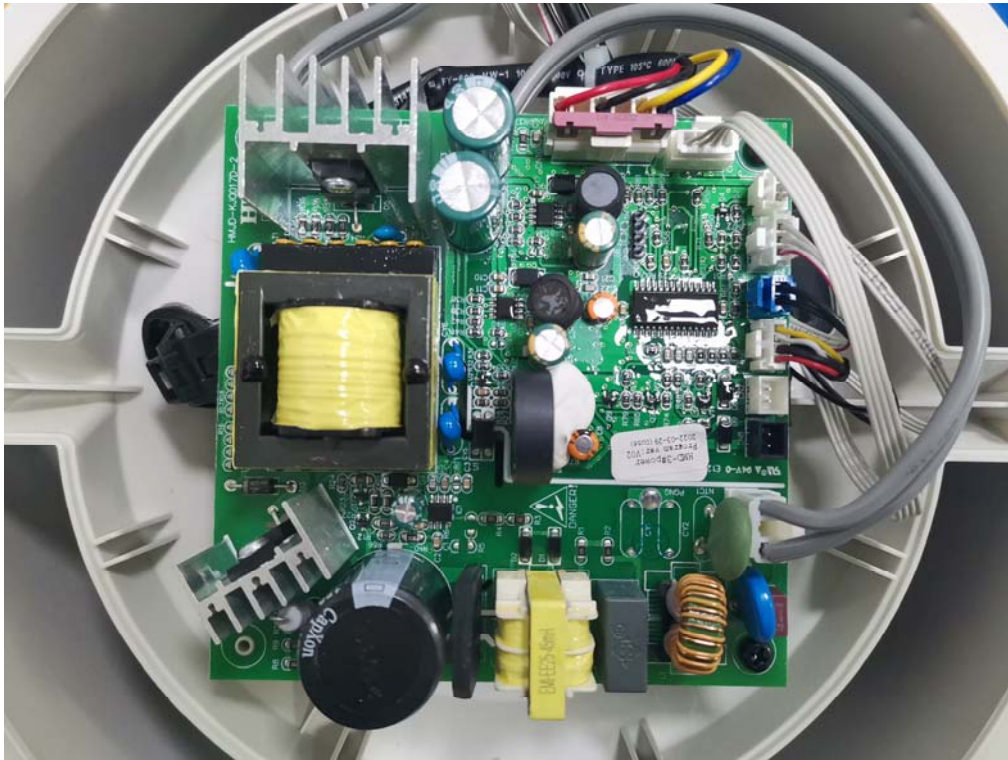

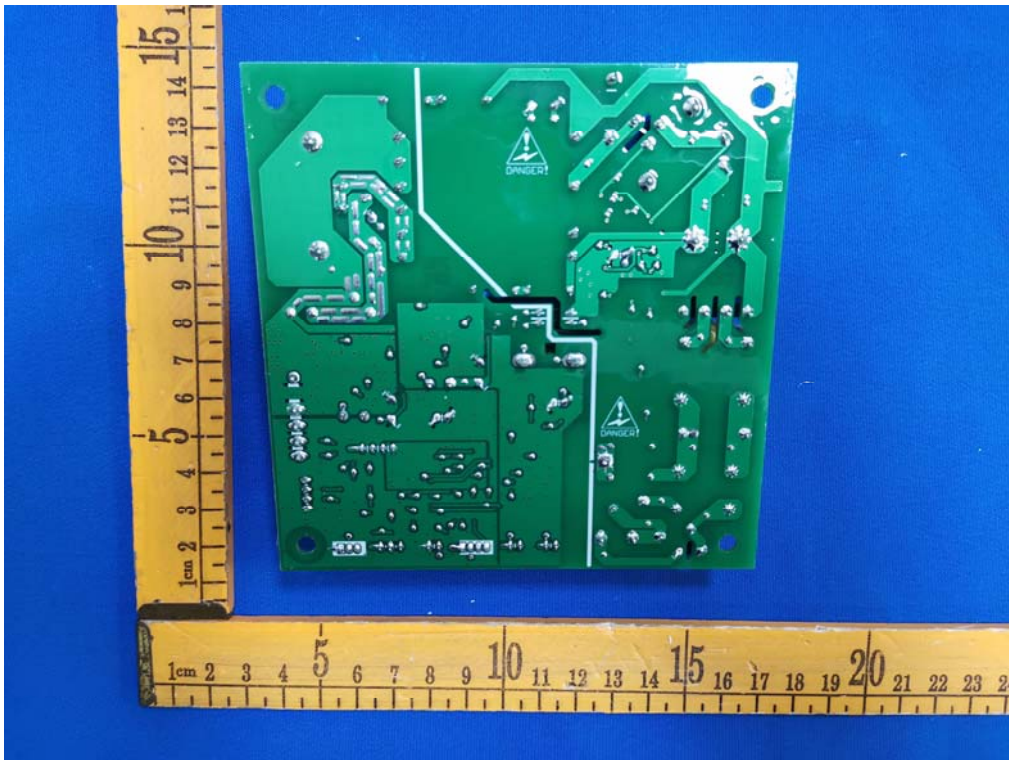

2.4GWIFI ANT

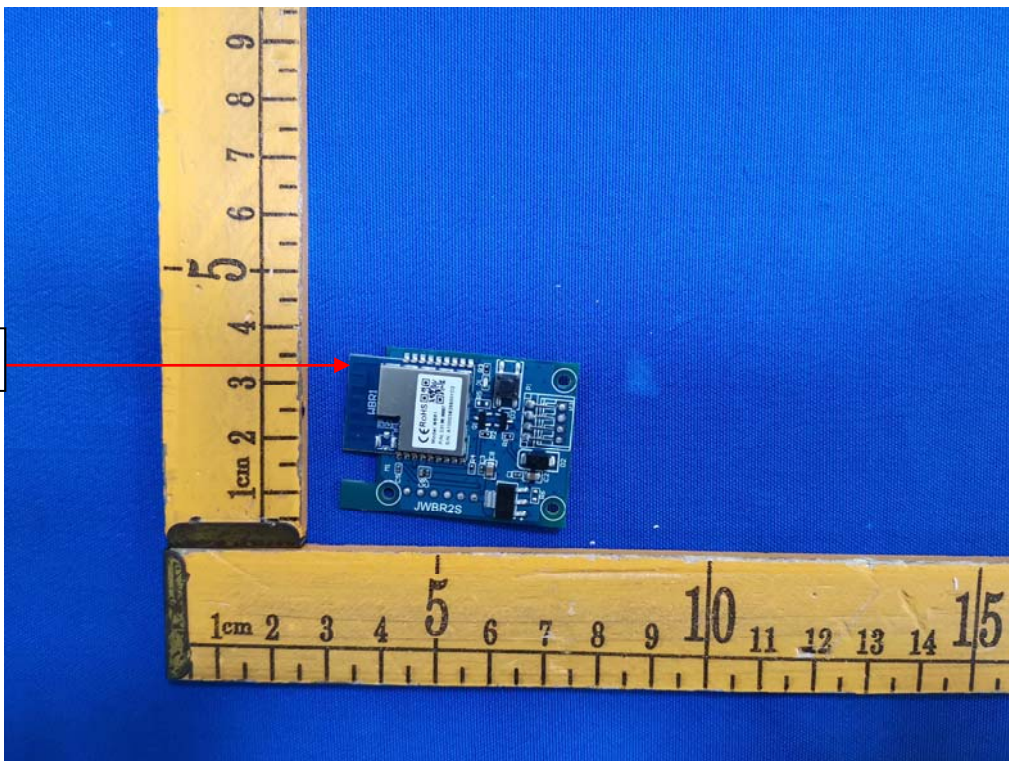

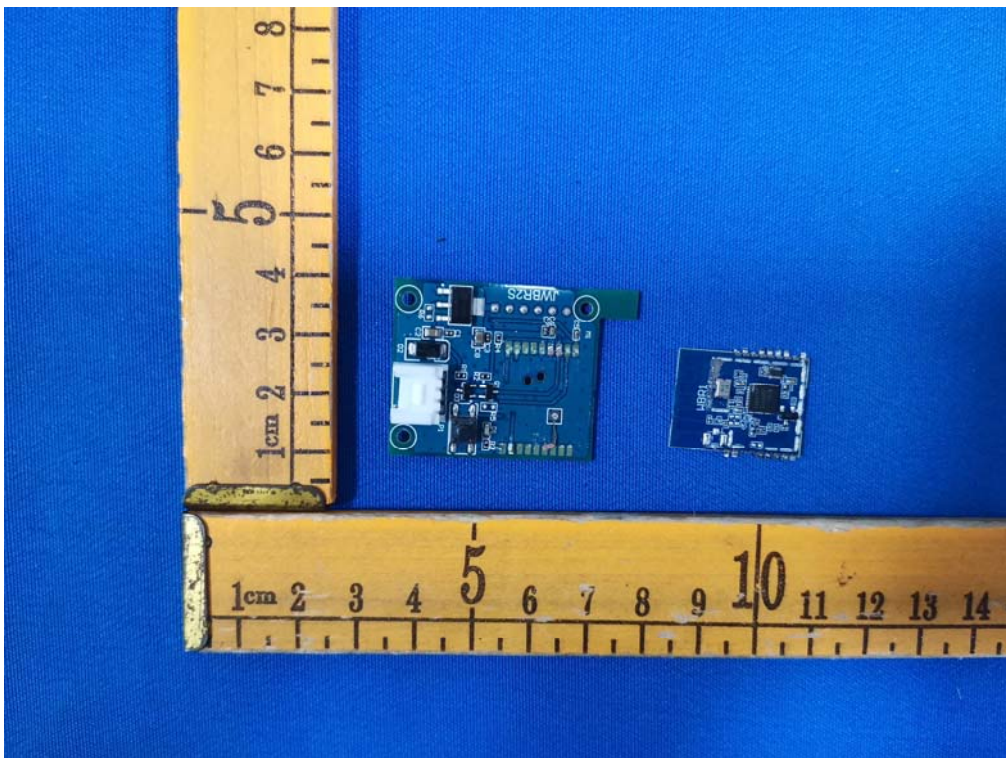
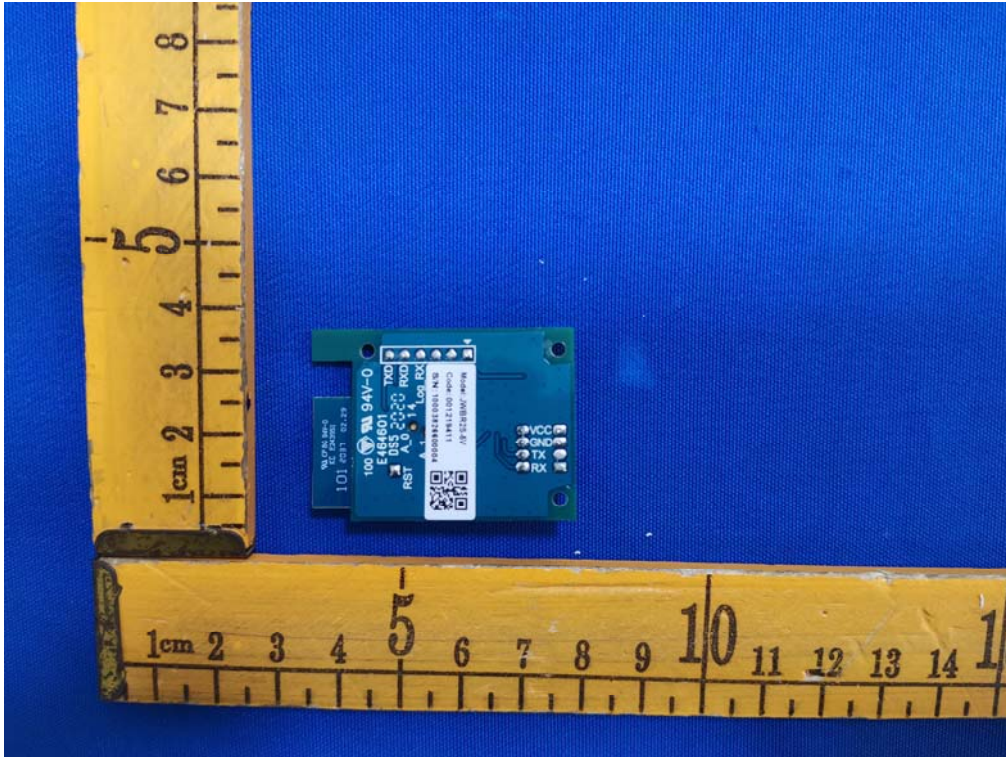

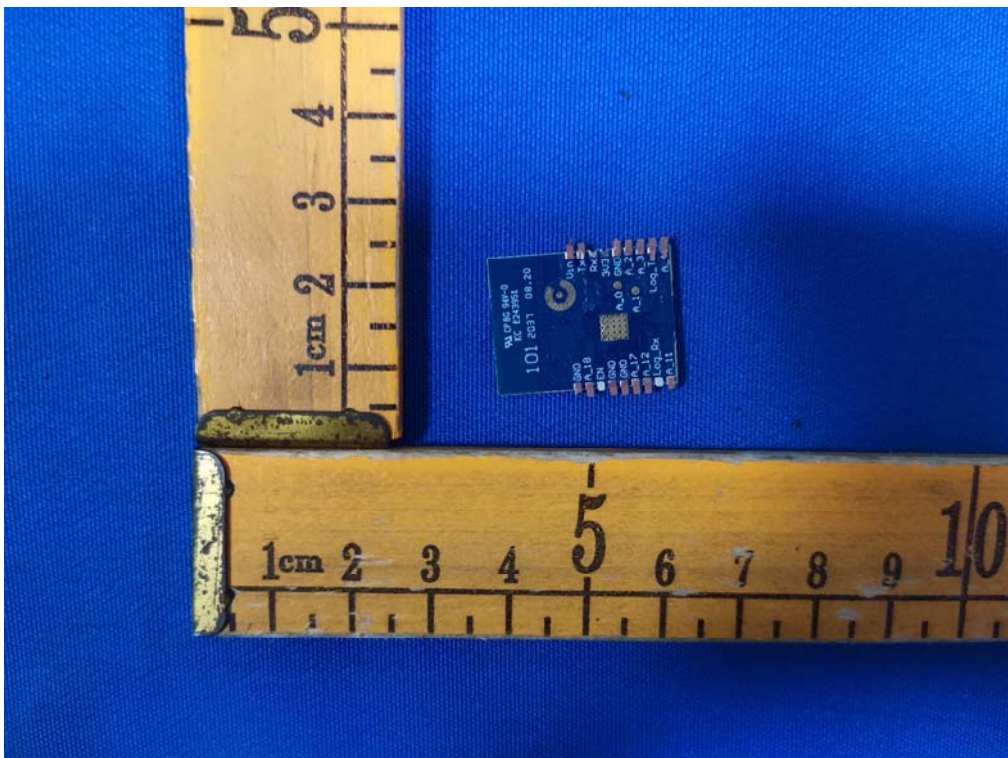
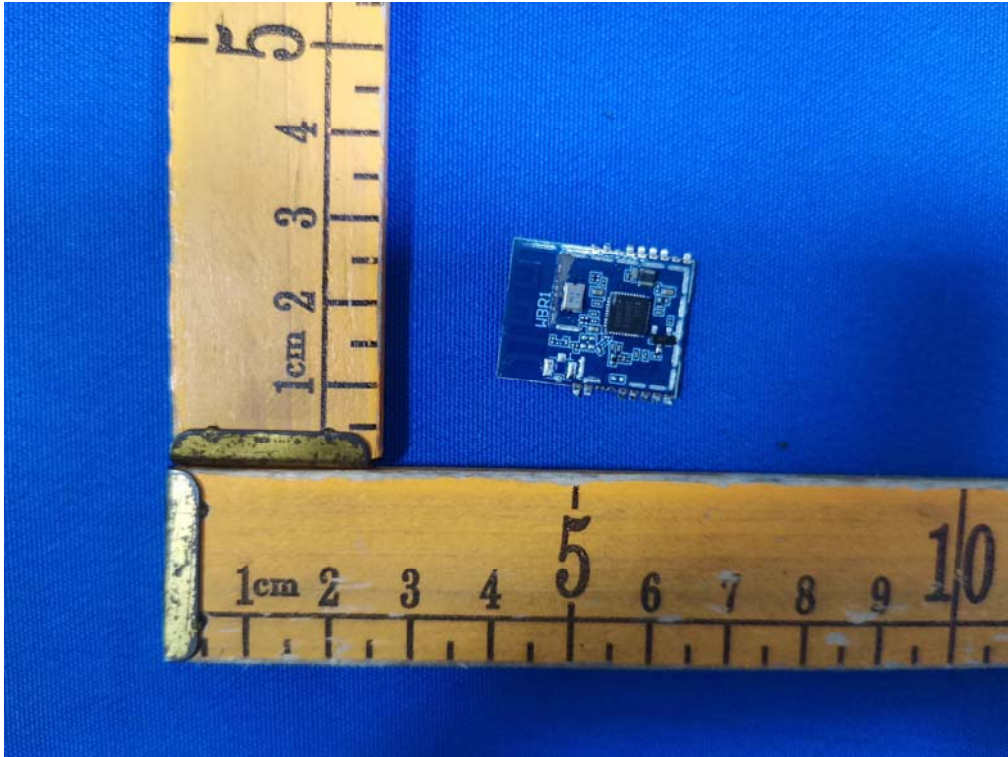

--END OF REPORT--