



SPORTON International Inc.

No. 52, Hwa Ya 1st Rd., Kwei-Shan Hsiang, TaoYuan Hsien, Taiwan, R.O.C.
Ph: 886-3-327-3456 / FAX: 886-3-327-0973 / www.sporton.com.tw

FCC RADIO TEST REPORT

Applicant's company	Arada System, Inc
Applicant Address	4633 Old Ironsides Drive, Suite 415 Santa Clara, CA 95054
FCC ID	XZB-MAXR954
Manufacturer's company	Arada System, Inc
Manufacturer Address	4633 Old Ironsides Drive, Suite 415 Santa Clara, CA 95054

Product Name	802.11a/b/g/n WLAN mini-PCI card
Brand Name	Arada
Model Name	MaxR-954
Test Rule Part(s)	47 CFR FCC Part 15 Subpart C § 15.247
Test Freq. Range	2400 ~ 2483.5MHz / 5725 ~ 5850MHz
Received Date	Feb. 17, 2011
Final Test Date	Jun. 23, 2011
Submission Type	Original Equipment

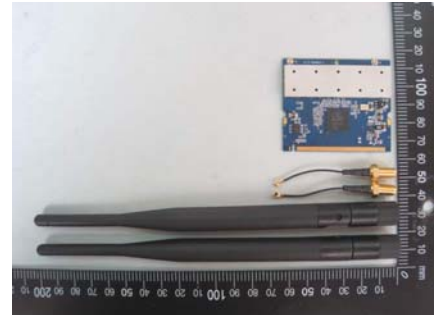

Statement

Test result included is only for the IEEE 802.11n, IEEE 802.11b/g part and IEEE 802.11a (5725 ~ 5850MHz) of the product.

The test result in this report refers exclusively to the presented test model / sample.

Without written approval of SPORTON International Inc., the test report shall not be reproduced except in full.

The measurements and test results shown in this test report were made in accordance with the procedures and found in compliance with the limit given in ANSI C63.10-2009 and 47 CFR FCC Part 15 Subpart C.

The test equipment used to perform the test is calibrated and traceable to NML/ROC.



Table of Contents

1. CERTIFICATE OF COMPLIANCE	1
2. SUMMARY OF THE TEST RESULT	2
3. GENERAL INFORMATION	3
3.1. Product Details.....	3
3.2. Accessories.....	5
3.3. Table for Filed Antenna.....	6
3.4. Table for Carrier Frequencies	7
3.5. Table for Test Modes	8
3.6. Table for Testing Locations.....	9
3.7. Table for Supporting Units	9
3.8. Table for Parameters of Test Software Setting	10
3.9. Test Configurations	12
4. TEST RESULT	14
4.1. AC Power Line Conducted Emissions Measurement	14
4.2. Peak Output Power Measurement	18
4.3. Average Output Power Measurement	26
4.4. Power Spectral Density Measurement	29
4.5. 6dB Spectrum Bandwidth Measurement	38
4.6. Radiated Emissions Measurement	44
4.7. Band Edge Emissions Measurement	70
4.8. Antenna Requirements	82
5. LIST OF MEASURING EQUIPMENTS	83
6. TEST LOCATION.....	85
7. TAF CERTIFICATE OF ACCREDITATION	86
APPENDIX A. PHOTOGRAPHS OF EUT.....	A1 ~ A9
APPENDIX B. TEST PHOTOS.....	B1 ~ B7
APPENDIX C. MAXIMUM PERMISSIBLE EXPOSURE.....	C1 ~C3



1. CERTIFICATE OF COMPLIANCE

Product Name : 802.11a/b/g/n WLAN mini-PCI card
Brand Name : Arada
Model Name : MaxR-954
Applicant : Arada System, Inc
Test Rule Part(s) : 47 CFR FCC Part 15 Subpart C § 15.247

Sporton International as requested by the applicant to evaluate the EMC performance of the product sample received on Feb. 17, 2011 would like to declare that the tested sample has been evaluated and found to be in compliance with the tested rule parts. The data recorded as well as the test configuration specified is true and accurate for showing the sample's EMC nature.

Jordan Hsiao 2011.7.5

Jordan Hsiao

SPORTON INTERNATIONAL INC.

2. SUMMARY OF THE TEST RESULT

Applied Standard: 47 CFR FCC Part 15 Subpart C				
Part	Rule Section	Description of Test	Result	Under Limit
4.1	15.207	AC Power Line Conducted Emissions	Complies	9.05 dB
4.2	15.247(b)(3)	Peak Output Power	Complies	1.15 dB
4.3	-	Average Output Power	-	-
4.4	15.247(e)	Power Spectral Density	Complies	6.61 dB
4.5	15.247(a)(2)	6dB Spectrum Bandwidth	Complies	-
4.6	15.247(d)	Radiated Emissions	Complies	4.36 dB
4.7	15.247(d)	Band Edge Emissions	Complies	0.26 dB
4.8	15.203	Antenna Requirements	Complies	-

Test Items	Uncertainty	Remark
AC Power Line Conducted Emissions	±2.3dB	Confidence levels of 95%
Maximum Conducted Output Power	±0.8dB	Confidence levels of 95%
Power Spectral Density	±0.5dB	Confidence levels of 95%
6dB Spectrum Bandwidth	±8.5×10 ⁻⁸	Confidence levels of 95%
Radiated Emissions (9kHz~30MHz)	±0.8dB	Confidence levels of 95%
Radiated Emissions (30MHz~1000MHz)	±1.9dB	Confidence levels of 95%
Radiated / Band Edge Emissions (1GHz~18GHz)	±1.9dB	Confidence levels of 95%
Radiated Emissions (18GHz~40GHz)	±1.9dB	Confidence levels of 95%
Temperature	±0.7°C	Confidence levels of 95%
Humidity	±3.2%	Confidence levels of 95%
DC / AC Power Source	±1.4%	Confidence levels of 95%

3. GENERAL INFORMATION

3.1. Product Details

IEEE 802.11n

Items	Description
Product Type	WLAN (2TX, 2RX)
Radio Type	Intentional Transceiver
Power Type	From Host System
Modulation	see the below table for IEEE 802.11n
Data Modulation	OFDM (BPSK / QPSK / 16QAM / 64QAM)
Data Rate (Mbps)	see the below table for IEEE 802.11n
Frequency Range	2400 ~ 2483.5MHz / 5725 ~ 5850MHz
Channel Number	For 2.4GHz Band: 11 for 20MHz bandwidth ; 7 for 40MHz bandwidth For 5GHz Band: 5 for 20MHz bandwidth ; 2 for 40MHz bandwidth
Channel Band Width (99%)	For 2.4GHz Band: MCS8 (20MHz): 17.68 MHz ; MCS8 (40MHz): 36.32 MHz For 5GHz Band: MCS8 (20MHz): 17.68 MHz ; MCS8 (40MHz): 36.32 MHz
Peak Output Power	For 2.4GHz Band: MCS8 (20MHz): 28.60 dBm ; MCS8 (40MHz): 27.87 dBm For 5GHz Band: MCS8 (20MHz): 26.80 dBm ; MCS8 (40MHz): 26.68 dBm
Carrier Frequencies	Please refer to section 3.4
Antenna	Please refer to section 3.3

802.11a/b/g

Items	Description
Product Type	WLAN (2TX, 2RX)
Radio Type	Intentional Transceiver
Power Type	From Host System
Modulation	DSSS for IEEE 802.11b ; OFDM for IEEE 802.11a/g
Data Modulation	DSSS (BPSK / QPSK / CCK) ; OFDM (BPSK / QPSK / 16QAM / 64QAM)
Data Rate (Mbps)	DSSS (1/ 2/ 5.5/11) ; OFDM (6/9/12/18/24/36/48/54)
Frequency Range	2400 ~ 2483.5MHz / 5725 ~ 5850MHz
Channel Number	11b/g: 11 ; 11a: 5
Channel Band Width (99%)	11b: 15.76 MHz ; 11g: 16.56 MHz ; 11a: 16.56 MHz
Peak Output Power	11b: 26.17 dBm ; 11g: 28.85 dBm ; 11a: 26.85 dBm
Carrier Frequencies	Please refer to section 3.4
Antenna	Please refer to section 3.3

Antenna & Band width

Antenna	Single (TX)		Two (TX)	
	20 MHz	40 MHz	20 MHz	40 MHz
Band width Mode				
IEEE 802.11a	X	X	V	X
IEEE 802.11b	X	X	V	X
IEEE 802.11g	X	X	V	X
IEEE 802.11n	X	X	V	V

IEEE 802.11n spec

MCS Index	Nss	Modulation	R	NBPS	NCBPS		NDBPS		Datarate(Mbps)			
					20MHz	40MHz	20MHz	40MHz	800nsGI		400nsGI	
									20MHz	40MHz	20MHz	40MHz
0	1	BPSK	1/2	1	52	108	26	54	6.5	13.5	7.200	15
1	1	QPSK	1/2	2	104	216	52	108	13.0	27.0	14.400	30
2	1	QPSK	3/4	2	104	216	78	162	19.5	40.5	21.700	45
3	1	16-QAM	1/2	4	208	432	104	216	26.0	54.0	28.900	60
4	1	16-QAM	3/4	4	208	432	156	324	39.0	81.0	43.300	90
5	1	64-QAM	2/3	6	312	648	208	432	52.0	108.0	57.800	120
6	1	64-QAM	3/4	6	312	648	234	486	58.5	121.5	65.000	135
7	1	64-QAM	5/6	6	312	648	260	540	65.0	135.0	72.200	150
8	2	BPSK	1/2	1	104	216	52	108	13.0	27.0	14.444	30
9	2	QPSK	1/2	2	208	432	104	216	26.0	54.0	28.889	60
10	2	QPSK	3/4	2	208	432	156	324	39.0	81.0	43.333	90
11	2	16-QAM	1/2	4	416	864	208	432	52.0	108.0	57.778	120
12	2	16-QAM	3/4	4	416	864	312	648	78.0	162.0	86.667	180
13	2	64-QAM	2/3	6	624	1296	416	864	104.0	216.0	115.556	240
14	2	64-QAM	3/4	6	624	1296	468	972	117.0	243.0	130.000	270
15	2	64-QAM	5/6	6	624	1296	520	1080	130.0	270.0	144.444	300

Symbol	Explanation
NSS	Number of spatial streams
R	Code rate
NBPS	Number of coded bits per single carrier
NCBPS	Number of coded bits per symbol
NDBPS	Number of data bits per symbol
GI	guard interval

3.2. Accessories

N/A

3.3. Table for Filed Antenna

Ant.	Brand	Model Name	Antenna Type	Connector	Gain (dBi)	
					2.4GHz	5GHz
1	ARISTOTLE	RFA-25-F7M3	Dipole Antenna	Reverse SMA PLUG	1.8	3.8
2	ARISTOTLE	RFA-25-F7M3	Dipole Antenna	Reverse SMA PLUG	1.8	3.8

Note: The EUT has two Antennas.

Both Ant. 1 and Ant. 2 can be used as transmitting/receiving antenna.

Ant. 1 and Ant. 2 will transmit/receive the same signal simultaneously.

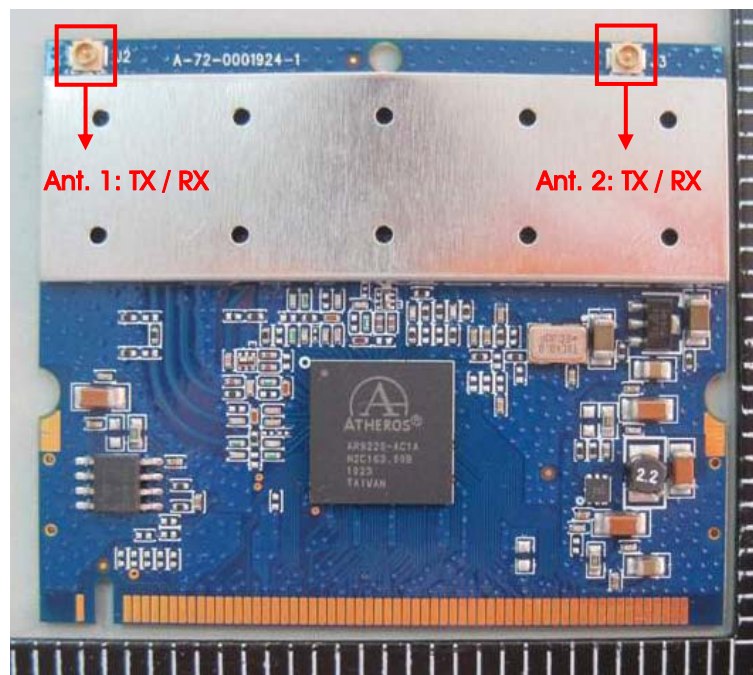

3.4. Table for Carrier Frequencies

For 2.4GHz Band

Frequency Allocation for IEEE 802.11b/g

For IEEE 802.11b/g, use Channel 1~Channel 11.

There are two bandwidth systems for IEEE 802.11n.

For both 20MHz bandwidth systems, use Channel 1~Channel 11.

For both 40MHz bandwidth systems, use Channel 3~Channel 9.

Frequency Band	Channel No.	Frequency	Channel No.	Frequency
2400~2483.5MHz	1	2412 MHz	7	2442 MHz
	2	2417 MHz	8	2447 MHz
	3	2422 MHz	9	2452 MHz
	4	2427 MHz	10	2457 MHz
	5	2432 MHz	11	2462 MHz
	6	2437 MHz	-	-

For 5GHz Band

Frequency Allocation for IEEE 802.11a

For IEEE 802.11a, use Channel 149, 153, 157, 161, 165.

There are two bandwidth systems for IEEE 802.11n.

For 20MHz bandwidth systems, use Channel 149, 153, 157, 161, 165.

For 40MHz bandwidth systems, use Channel 151, 159.

Frequency Band	Channel No.	Frequency	Channel No.	Frequency
5725~5850 MHz Band 4	149	5745 MHz	159	5795 MHz
	151	5755 MHz	161	5805 MHz
	153	5765 MHz	165	5825 MHz
	157	5785 MHz	-	-

3.5. Table for Test Modes

Preliminary tests were performed in different data rate to find the worst radiated emission. The data rate shown in the table below is the worst-case rate with respect to the specific test item. Investigation has been done on all the possible configurations for searching the worst cases. The following table is a list of the test modes shown in this test report.

For 2.4GHz Band

Test Items	Mode	Data Rate	Channel	Antenna
AC Power Line Conducted Emissions	Normal Link	Auto	-	-
Peak Output Power Average Output Power	MCS8/20MHz	13 Mbps	1/6/11	1/2/1+2
	MCS8/40MHz	27 Mbps	3/6/9	1/2/1+2
	11b/CCK	1 Mbps	1/6/11	1/2/1+2
	11g/BPSK	6 Mbps	1/6/11	1/2/1+2
Power Spectral Density 6dB Spectrum Bandwidth	MCS8/20MHz	13 Mbps	1/6/11	1+2
	MCS8/40MHz	27 Mbps	3/6/9	1+2
	11b/CCK	1 Mbps	1/6/11	1+2
	11g/BPSK	6 Mbps	1/6/11	1+2
Radiated Emissions Below 1GHz	Normal Link	Auto	-	-
Radiated Emissions Above 1GHz	MCS8/20MHz	13 Mbps	1/6/11	1+2
	MCS8/40MHz	27 Mbps	3/6/9	1+2
	11b/CCK	1 Mbps	1/6/11	1+2
	11g/BPSK	6 Mbps	1/6/11	1+2
Band Edge Emissions	MCS8/20MHz	13 Mbps	1/11	1+2
	MCS8/40MHz	27 Mbps	3/9	1+2
	11b/CCK	1 Mbps	1/11	1+2
	11g/BPSK	6 Mbps	1/11	1+2

For 5GHz Band

Test Items	Mode	Data Rate	Channel	Antenna
AC Power Line Conducted Emissions	Normal Link	Auto	-	-
Peak Output Power	MCS8/20MHz	13 Mbps	149/157/165	1/2/1+2
Average Output Power	MCS8/40MHz	27 Mbps	151/159	1/2/1+2
	11a/BPSK	6 Mbps	149/157/165	1/2/1+2
Power Spectral Density	MCS8/20MHz	13 Mbps	149/157/165	1+2
6dB Spectrum Bandwidth	MCS8/40MHz	27 Mbps	151/159	1+2
	11a/BPSK	6 Mbps	149/157/165	1+2
Radiated Emissions Below 1GHz	Normal Link	Auto	-	-
Radiated Emissions Above 1GHz	MCS8/20MHz	13 Mbps	149/157/165	1+2
	MCS8/40MHz	27 Mbps	151/159	1+2
	11a/BPSK	6 Mbps	149/157/165	1+2
Band Edge Emissions	MCS8/20MHz	13 Mbps	149/157/165	1+2
	MCS8/40MHz	27 Mbps	151/159	1+2
	11a/BPSK	6 Mbps	149/157/165	1+2

3.6. Table for Testing Locations

Test Site No.	Site Category	Location	FCC Reg. No.	IC File No.	VCCI Reg. No
03CH01-CB	SAC	Hsin Chu	187376	IC 4086D	-
CO01-CB	Conduction	Hsin Chu	187376	IC 4086D	-
TH01-CB	OVEN Room	Hsin Chu	-	-	-

Open Area Test Site (OATS); Semi Anechoic Chamber (SAC); Fully Anechoic Chamber (FAC).

Please refer section 6 for Test Site Address.

3.7. Table for Supporting Units

Support Unit	Brand	Model	FCC ID
Notebook	DELL	D400	E2K24GBRL

3.8. Table for Parameters of Test Software Setting

During testing, Channel & Power Controlling Software provided by the customer was used to control the operating channel as well as the output power level. The RF output power selection is for the setting of RF output power expected by the customer and is going to be fixed on the firmware of the final end product.

For 2.4GHz Band

Power Parameters of IEEE 802.11n MCS8 20MHz

Test Software Version	ART Revision 0.9 BULID #34 ART_11N		
Frequency	2412 MHz	2437 MHz	2462 MHz
MCS8 20MHz	15.5	21.5	16.5

Power Parameters of IEEE 802.11n MCS8 40MHz

Test Software Version	ART Revision 0.9 BULID #34 ART_11N		
Frequency	2422 MHz	2437 MHz	2452 MHz
MCS8 40MHz	11.5	17	12

Power Parameters of IEEE 802.11b/g

Test Software Version	ART Revision 0.9 BULID #34 ART_11N		
Frequency	2412 MHz	2437 MHz	2462 MHz
IEEE 802.11b	17.5	22.0	15.5
IEEE 802.11g	16.0	22.0	16.5

For 5GHz Band

Power Parameters of IEEE 802.11n MCS8 20MHz

Test Software Version	ART Revision 0.9 BULID #34 ART_11N		
Frequency	5745 MHz	5785 MHz	5825 MHz
MCS8 20MHz	19	18.5	17

Power Parameters of IEEE 802.11n MCS8 40MHz

Test Software Version	ART Revision 0.9 BULID #34 ART_11N	
Frequency	5755 MHz	5795 MHz
MCS8 40MHz	18.5	17.5

Power Parameters of IEEE 802.11a

Test Software Version	ART Revision 0.9 BULID #34 ART_11N		
Frequency	5745 MHz	5785 MHz	5825 MHz
IEEE 802.11a	19	18.5	17

During the test, "ART Revision 0.9 BULID #34 ART_11N" under WIN XP was executed to control the EUT continuously transmit RF signal.

3.9. Test Configurations

3.9.1. Radiation Emissions Test Configuration

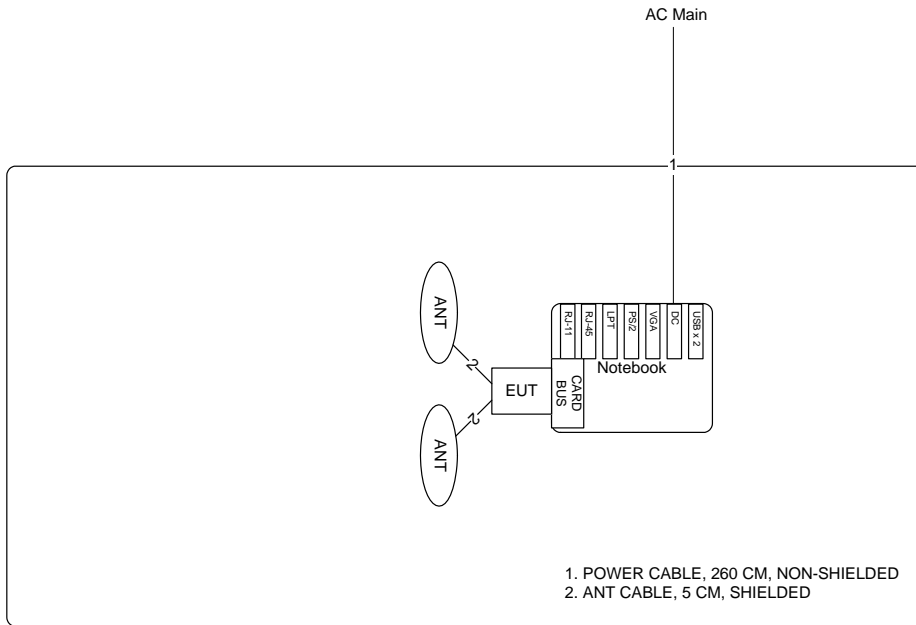

3.9.2. AC Power Line Conduction Emissions Test Configuration

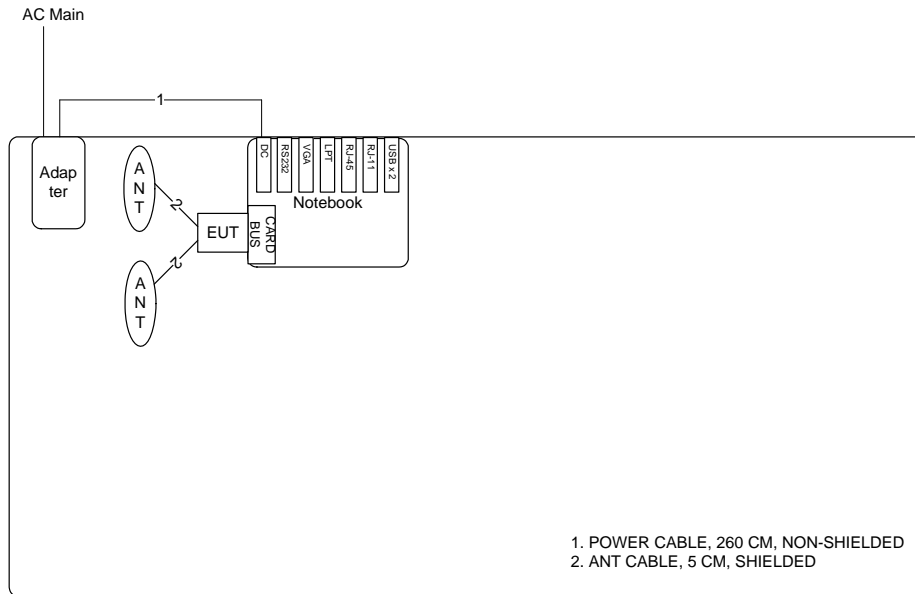

4. TEST RESULT

4.1. AC Power Line Conducted Emissions Measurement

4.1.1. Limit

For this product which is designed to be connected to the AC power line, the radio frequency voltage that is conducted back onto the AC power line on any frequency or frequencies within the band 150 kHz to 30 MHz shall not exceed below limits table.

Frequency (MHz)	QP Limit (dBuV)	AV Limit (dBuV)
0.15~0.5	66~56	56~46
0.5~5	56	46
5~30	60	50

4.1.2. Measuring Instruments and Setting

Please refer to section 5 of equipments list in this report. The following table is the setting of the receiver.

Receiver Parameters	Setting
Attenuation	10 dB
Start Frequency	0.15 MHz
Stop Frequency	30 MHz
IF Bandwidth	9 KHz

4.1.3. Test Procedures

1. Configure the EUT according to ANSI C63.10. The EUT or host of EUT has to be placed 0.4 meter far from the conducting wall of the shielding room and at least 80 centimeters from any other grounded conducting surface.
2. Connect EUT or host of EUT to the power mains through a line impedance stabilization network (LISN).
3. All the support units are connected to the other LISNs. The LISN should provide 50uH/50ohms coupling impedance.
4. The frequency range from 150 KHz to 30 MHz was searched.
5. Set the test-receiver system to Peak Detect Function and Specified Bandwidth with Maximum Hold Mode.
6. The measurement has to be done between each power line and ground at the power terminal.

4.1.4. Test Setup Layout

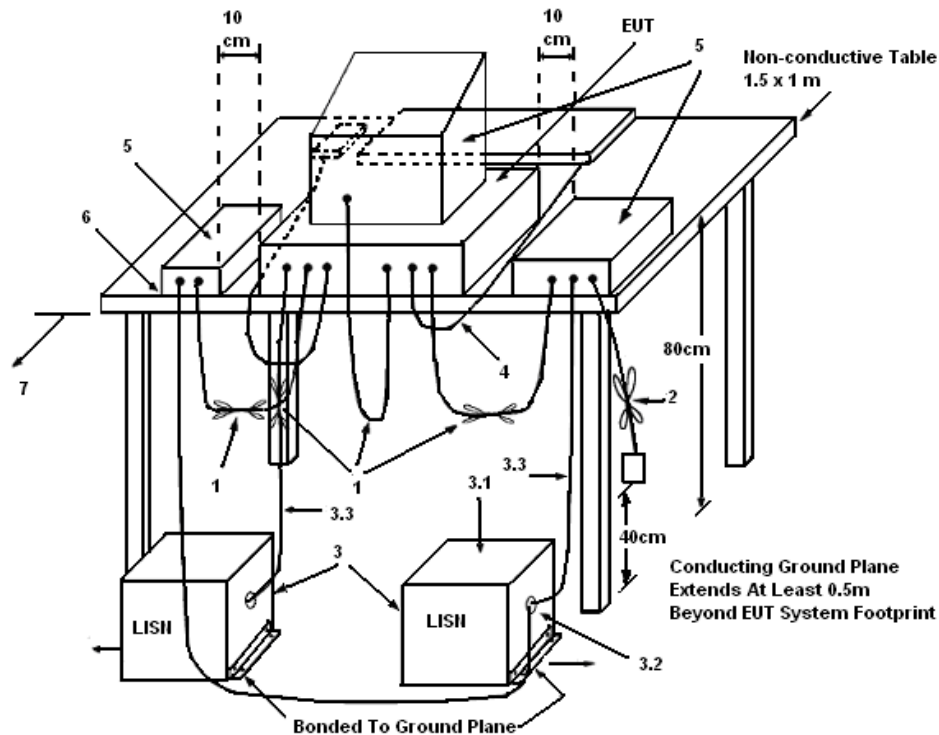

LEGEND:

- (1) Interconnecting cables that hang closer than 40 cm to the ground plane shall be folded back and forth in the center forming a bundle 30 to 40 cm long.
- (2) I/O cables that are not connected to a peripheral shall be bundled in the center. The end of the cable may be terminated, if required, using the correct terminating impedance. The overall length shall not exceed 1 m.
- (3) EUT connected to one LISN. Unused LISN measuring port connectors shall be terminated in 50 Ω . LISN can be placed on top of, or immediately beneath, reference ground plane.
 - (3.1) All other equipment powered from additional LISN(s).
 - (3.2) Multiple outlet strip can be used for multiple power cords of non-EUT equipment.
 - (3.3) LISN at least 80 cm from nearest part of EUT chassis.
- (4) Cables of hand-operated devices, such as keyboards, mice, etc., shall be placed as for normal use.
- (5) Non-EUT components of EUT system being tested.
- (6) Rear of EUT, including peripherals, shall all be aligned and flush with rear of tabletop.
- (7) Rear of tabletop shall be 40 cm removed from a vertical conducting plane that is bonded to the ground plane.

4.1.5. Test Deviation

There is no deviation with the original standard.

4.1.6. EUT Operation during Test

The EUT was placed on the test table and programmed in normal function.

4.1.7. Results of AC Power Line Conducted Emissions Measurement

Temperature	21°C	Humidity	61%
Test Engineer	Peter Wu	Phase	Line
Configuration	Normal Link		

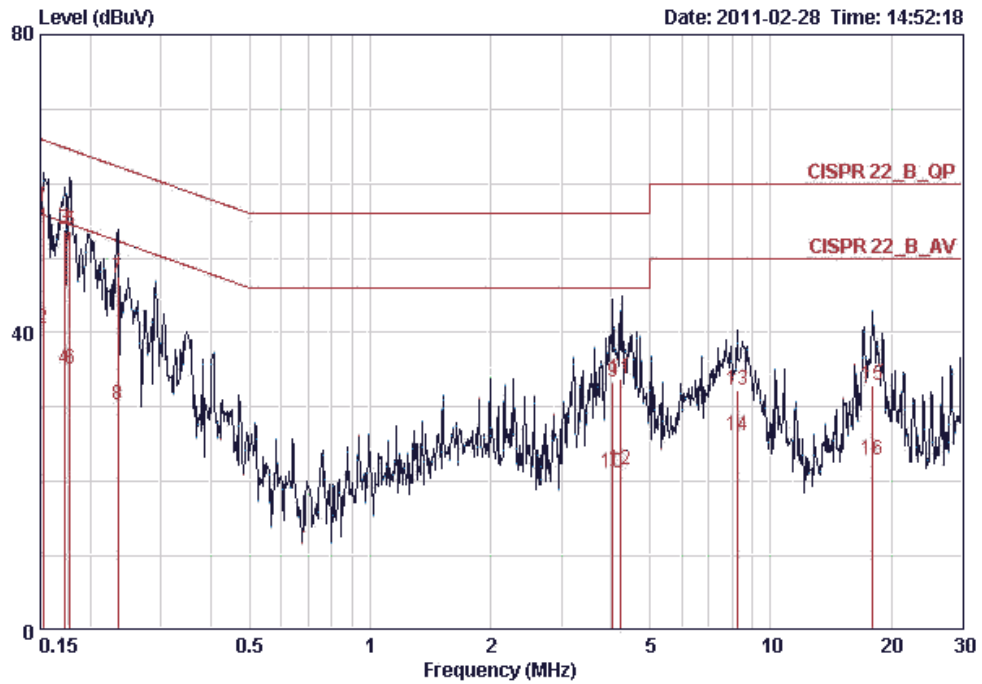

	Freq	Level	Over	Limit	Read	LISN	Cable	
	MHz	dBuV	Limit	Line	Level	Factor	Loss	Remark
			dB	dBuV	dBuV	dB	dB	
1	0.15240	56.81	-9.05	65.87	56.54	0.07	0.20	QP
2	0.15240	40.61	-15.25	55.87	40.34	0.07	0.20	AVERAGE
3	0.17215	53.91	-10.94	64.86	53.65	0.06	0.20	QP
4	0.17215	35.16	-19.69	54.86	34.90	0.06	0.20	AVERAGE
5	0.17772	53.52	-11.07	64.59	53.26	0.06	0.20	QP
6	0.17772	35.20	-19.39	54.59	34.94	0.06	0.20	AVERAGE
7	0.23409	47.34	-14.97	62.30	47.09	0.05	0.20	QP
8	0.23409	30.30	-22.01	52.30	30.05	0.05	0.20	AVERAGE
9	4.027	33.26	-22.74	56.00	32.86	0.10	0.30	QP
10	4.027	21.16	-24.84	46.00	20.76	0.10	0.30	AVERAGE
11	4.202	33.87	-22.13	56.00	33.46	0.11	0.30	QP
12	4.202	21.66	-24.34	46.00	21.25	0.11	0.30	AVERAGE
13	8.235	32.20	-27.80	60.00	31.55	0.30	0.35	QP
14	8.235	26.12	-23.88	50.00	25.47	0.30	0.35	AVERAGE
15	17.944	32.94	-27.06	60.00	31.72	0.72	0.50	QP
16	17.944	22.85	-27.15	50.00	21.63	0.72	0.50	AVERAGE

Temperature	21°C	Humidity	61%
Test Engineer	Peter Wu	Phase	Neutral
Configuration	Normal Link		

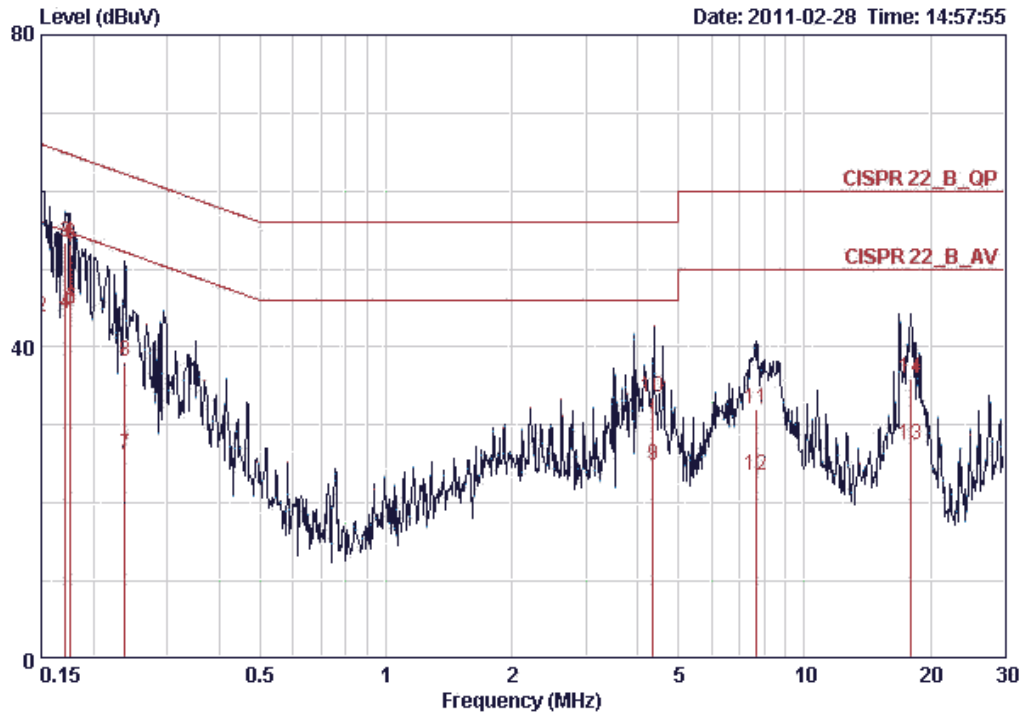

	Freq	Level	Over Limit	Limit Line	Read Level	LISN Factor	Cable Loss	Remark
	MHz	dBuV	dB	dBuV	dBuV	dB	dB	
1	0.15000	56.64	-9.36	66.00	56.33	0.11	0.20	QP
2	0.15000	43.82	-12.18	56.00	43.51	0.11	0.20	AVERAGE
3	0.17125	53.37	-11.53	64.90	53.08	0.09	0.20	QP
4	0.17125	44.14	-10.76	54.90	43.85	0.09	0.20	AVERAGE
5	0.17584	44.97	-9.71	54.68	44.68	0.09	0.20	AVERAGE
6	0.17584	53.23	-11.45	64.68	52.94	0.09	0.20	QP
7	0.23784	26.12	-26.05	52.17	25.84	0.08	0.20	AVERAGE
8	0.23784	38.21	-23.96	62.17	37.93	0.08	0.20	QP
9	4.353	24.84	-21.16	46.00	24.38	0.16	0.30	AVERAGE
10	4.353	33.55	-22.45	56.00	33.09	0.16	0.30	QP
11	7.646	32.01	-27.99	60.00	31.30	0.32	0.40	QP
12	7.646	23.47	-26.53	50.00	22.76	0.32	0.40	AVERAGE
13	17.924	27.51	-22.49	50.00	26.29	0.72	0.50	AVERAGE
14	17.924	35.97	-24.03	60.00	34.75	0.72	0.50	QP

Note: Level = Read Level + LISN Factor + Cable Loss.

4.2. Peak Output Power Measurement

4.2.1. Limit

For systems using digital modulation in the 2400-2483.5MHz, the limit for peak output power is 30dBm. The limited has to be reduced by the amount in dB that the gain of the antenna exceed 6dBi. In case of point-to-point operation, the limit has to be reduced by 1dB for every 3dB that the directional gain of the antenna exceeds 6dBi. Systems operating in the 5725-5850 MHz band that are used exclusively for fixed, point-to-point operations may employ transmitting antennas with directional gain greater than 6 dBi without any corresponding reduction in transmitter conducted output power.

4.2.2. Measuring Instruments and Setting

Please refer to section 5 of equipments list in this report. The following table is the setting of the peak power meter.

Power Meter Parameter	Setting
Bandwidth	50MHz bandwidth is greater than the EUT emission bandwidth
Detector	Peak

4.2.3. Test Procedures

Spectrum Parameter	Setting
RF Output Power Method	<input checked="" type="checkbox"/> ANSI C63.10 clause 6.10.2.1 (a) power meter method
RF Output Power Method	<input type="checkbox"/> ANSI C63.10 clause 6.10.2.1 (b) channel integration method
RF Output Power Method	<input type="checkbox"/> ANSI C63.10 clause 6.10.3.1 Method 1 - spectral trace averaging
RF Output Power Method	<input type="checkbox"/> ANSI C63.10 clause 6.10.3.2 Method 2 - zero-span mode with trace averaging

4.2.4. Test Setup Layout

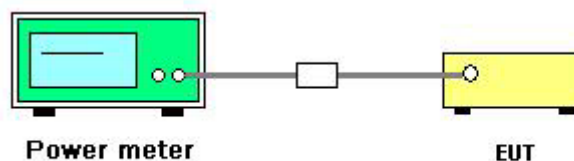

4.2.5. Test Deviation

There is no deviation with the original standard.

4.2.6. EUT Operation during Test

The EUT was programmed to be in continuously transmitting mode.

4.2.7. Test Result of Peak Output Power

Temperature	20°C	Humidity	61%
Test Engineer	Johnson Chang	Configurations	IEEE 802.11n
Test Date	Feb. 25, 2011		

For 2.4GHz Band

Configuration IEEE 802.11n MCS8 20MHz Ant. 1

Channel	Frequency	Conducted Power (dBm)	Max. Limit (dBm)	Result
1	2412 MHz	24.30	30.00	Complies
6	2437 MHz	25.92	30.00	Complies
11	2462 MHz	24.58	30.00	Complies

Configuration IEEE 802.11n MCS8 20MHz Ant. 2

Channel	Frequency	Conducted Power (dBm)	Max. Limit (dBm)	Result
1	2412 MHz	24.33	30.00	Complies
6	2437 MHz	25.24	30.00	Complies
11	2462 MHz	24.86	30.00	Complies

Configuration IEEE 802.11n MCS8 20MHz Ant. 1 + Ant. 2

Channel	Frequency	Conducted Power (dBm)	Max. Limit (dBm)	Result
1	2412 MHz	27.33	30.00	Complies
6	2437 MHz	28.60	30.00	Complies
11	2462 MHz	27.73	30.00	Complies

Configuration IEEE 802.11n MCS8 40MHz Ant. 1

Channel	Frequency	Conducted Power (dBm)	Max. Limit (dBm)	Result
3	2422 MHz	21.10	30.00	Complies
6	2437 MHz	25.00	30.00	Complies
9	2452 MHz	21.63	30.00	Complies

Configuration IEEE 802.11n MCS8 40MHz Ant. 2

Channel	Frequency	Conducted Power (dBm)	Max. Limit (dBm)	Result
3	2422 MHz	21.00	30.00	Complies
6	2437 MHz	24.72	30.00	Complies
9	2452 MHz	21.00	30.00	Complies

Configuration IEEE 802.11n MCS8 40MHz Ant. 1 + Ant. 2

Channel	Frequency	Conducted Power (dBm)	Max. Limit (dBm)	Result
3	2422 MHz	24.06	30.00	Complies
6	2437 MHz	27.87	30.00	Complies
9	2452 MHz	24.34	30.00	Complies

For 5GHz Band
Configuration IEEE 802.11n MCS8 20MHz Ant. 1

Channel	Frequency	Conducted Power (dBm)	Max. Limit (dBm)	Result
149	5745 MHz	24.07	30.00	Complies
157	5785 MHz	23.82	30.00	Complies
165	5825 MHz	23.60	30.00	Complies

Configuration IEEE 802.11n MCS8 20MHz Ant. 2

Channel	Frequency	Conducted Power (dBm)	Max. Limit (dBm)	Result
149	5745 MHz	23.49	30.00	Complies
157	5785 MHz	23.38	30.00	Complies
165	5825 MHz	23.08	30.00	Complies

Configuration IEEE 802.11n MCS8 20MHz Ant. 1 + Ant. 2

Channel	Frequency	Conducted Power (dBm)	Max. Limit (dBm)	Result
149	5745 MHz	26.80	30.00	Complies
157	5785 MHz	26.62	30.00	Complies
165	5825 MHz	26.36	30.00	Complies

Configuration IEEE 802.11n MCS8 40MHz Ant. 1

Channel	Frequency	Conducted Power (dBm)	Max. Limit (dBm)	Result
151	5755 MHz	23.96	30.00	Complies
159	5795 MHz	23.40	30.00	Complies

Configuration IEEE 802.11n MCS8 40MHz Ant. 2

Channel	Frequency	Conducted Power (dBm)	Max. Limit (dBm)	Result
151	5755 MHz	23.35	30.00	Complies
159	5795 MHz	22.90	30.00	Complies

Configuration IEEE 802.11n MCS8 40MHz Ant. 1 + Ant. 2

Channel	Frequency	Conducted Power (dBm)	Max. Limit (dBm)	Result
151	5755 MHz	26.68	30.00	Complies
159	5795 MHz	26.17	30.00	Complies

Temperature	20°C	Humidity	61%
Test Engineer	Johnson Chang	Configurations	IEEE 802.11a/b/g
Test Date	Feb. 25, 2011		

Configuration IEEE 802.11b Ant. 1

Channel	Frequency	Conducted Power (dBm)	Max. Limit (dBm)	Result
1	2412 MHz	18.73	30.00	Complies
6	2437 MHz	23.79	30.00	Complies
11	2462 MHz	17.45	30.00	Complies

Configuration IEEE 802.11b Ant. 2

Channel	Frequency	Conducted Power (dBm)	Max. Limit (dBm)	Result
1	2412 MHz	19.38	30.00	Complies
6	2437 MHz	22.42	30.00	Complies
11	2462 MHz	17.08	30.00	Complies

Configuration IEEE 802.11b Ant. 1 + Ant. 2

Channel	Frequency	Conducted Power (dBm)	Max. Limit (dBm)	Result
1	2412 MHz	22.08	30.00	Complies
6	2437 MHz	26.17	30.00	Complies
11	2462 MHz	20.28	30.00	Complies

Configuration IEEE 802.11g Ant. 1

Channel	Frequency	Conducted Power (dBm)	Max. Limit (dBm)	Result
1	2412 MHz	24.60	30.00	Complies
6	2437 MHz	25.85	30.00	Complies
11	2462 MHz	24.58	30.00	Complies

Configuration IEEE 802.11g Ant. 2

Channel	Frequency	Conducted Power (dBm)	Max. Limit (dBm)	Result
1	2412 MHz	24.62	30.00	Complies
6	2437 MHz	25.82	30.00	Complies
11	2462 MHz	24.78	30.00	Complies

Configuration IEEE 802.11g Ant. 1 + Ant. 2

Channel	Frequency	Conducted Power (dBm)	Max. Limit (dBm)	Result
1	2412 MHz	27.62	30.00	Complies
6	2437 MHz	28.85	30.00	Complies
11	2462 MHz	27.69	30.00	Complies

Configuration IEEE 802.11a Ant. 1

Channel	Frequency	Conducted Power (dBm)	Max. Limit (dBm)	Result
149	5745 MHz	24.13	30.00	Complies
157	5785 MHz	23.95	30.00	Complies
165	5825 MHz	23.50	30.00	Complies

Configuration IEEE 802.11a Ant. 2

Channel	Frequency	Conducted Power (dBm)	Max. Limit (dBm)	Result
149	5745 MHz	23.53	30.00	Complies
157	5785 MHz	23.46	30.00	Complies
165	5825 MHz	23.15	30.00	Complies

Configuration IEEE 802.11a Ant. 1 + Ant. 2

Channel	Frequency	Conducted Power (dBm)	Max. Limit (dBm)	Result
149	5745 MHz	26.85	29.19	Complies
157	5785 MHz	26.72	29.19	Complies
165	5825 MHz	26.34	29.19	Complies

4.3. Average Output Power Measurement

4.3.1. Measuring Instruments and Setting

Please refer to section 5 of equipments list in this report. The following table is the setting of the power meter.

Power Meter Parameter	Setting
Bandwidth	50MHz bandwidth is greater than the EUT emission bandwidth
Detector	Average

4.3.2. Test Procedures

Spectrum Parameter	Setting
RF Output Power Method	<input checked="" type="checkbox"/> ANSI C63.10 clause 6.10.2.1 (a) power meter method
RF Output Power Method	<input type="checkbox"/> ANSI C63.10 clause 6.10.2.1 (b) channel integration method
RF Output Power Method	<input type="checkbox"/> ANSI C63.10 clause 6.10.3.1 Method 1 - spectral trace averaging
RF Output Power Method	<input type="checkbox"/> ANSI C63.10 clause 6.10.3.2 Method 2 - zero-span mode with trace averaging

4.3.3. Test Setup Layout

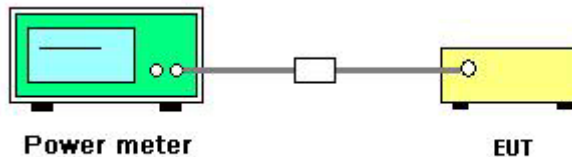

4.3.4. Test Deviation

There is no deviation with the original standard.

4.3.5. EUT Operation during Test

The EUT was programmed to be in continuously transmitting mode.

Note: Average output power is only for Maximum Permissible Exposure use.

4.3.6. Test Result of Average Output Power

Temperature	20°C	Humidity	61%
Test Engineer	Johnson Chang	Configurations	IEEE 802.11n
Test Date	Feb. 25, 2011		

For 2.4GHz Band

Configuration IEEE 802.11n MCS8 20MHz

Channel	Frequency	Average Conducted Power (dBm)		
		Ant. 1	Ant. 2	Total
1	2412 MHz	15.22	15.38	18.31
6	2437 MHz	20.78	20.43	23.62
11	2462 MHz	15.66	16.32	19.01

Configuration IEEE 802.11n MCS8 40MHz

Channel	Frequency	Average Conducted Power (dBm)		
		Ant. 1	Ant. 2	Total
3	2422 MHz	12.06	12.14	15.11
6	2437 MHz	16.38	16.30	19.35
9	2452 MHz	12.63	12.11	15.39

For 5GHz Band

Configuration IEEE 802.11n MCS8 20MHz

Channel	Frequency	Average Conducted Power (dBm)		
		Ant. 1	Ant. 2	Total
149	5745 MHz	19.24	18.85	22.06
157	5785 MHz	18.30	18.34	21.33
165	5825 MHz	17.10	17.00	20.06

Configuration IEEE 802.11n MCS8 40MHz

Channel	Frequency	Average Conducted Power (dBm)		
		Ant. 1	Ant. 2	Total
151	5755 MHz	19.19	18.90	22.06
159	5795 MHz	17.47	17.43	20.46

Temperature	20°C	Humidity	61%
Test Engineer	Johnson Chang	Configurations	IEEE 802.11a/b/g
Test Date	Feb. 25, 2011		

Configuration IEEE 802.11b

Channel	Frequency	Average Conducted Power (dBm)		
		Ant. 1	Ant. 2	Total
1	2412 MHz	16.33	16.92	19.65
6	2437 MHz	21.37	21.21	24.30
11	2462 MHz	15.04	14.74	17.90

Configuration IEEE 802.11g

Channel	Frequency	Average Conducted Power (dBm)		
		Ant. 1	Ant. 2	Total
1	2412 MHz	15.85	15.87	18.87
6	2437 MHz	21.28	21.05	24.18
11	2462 MHz	15.63	16.29	18.98

Configuration IEEE 802.11a

Channel	Frequency	Average Conducted Power (dBm)		
		Ant. 1	Ant. 2	Total
149	5745 MHz	19.19	18.82	22.02
157	5785 MHz	18.38	18.27	21.34
165	5825 MHz	16.72	16.93	19.84

4.4. Power Spectral Density Measurement

4.4.1. Limit

For digitally modulated systems, the power spectral density conducted from the intentional radiator to the antenna shall not be greater than 8dBm in any 3 kHz band during any time interval of continuous transmission.

4.4.2. Measuring Instruments and Setting

Please refer to section 5 of equipments list in this report. The following table is the setting of the spectrum analyzer.

Spectrum Parameter	Setting
Attenuation	Auto
Span Frequency	30 kHz
RB	3 kHz
VB	30 kHz
Detector	Peak
Trace	Max Hold
Sweep Time	10s

4.4.3. Test Procedures

1. The transmitter output (antenna port) was connected to the spectrum analyzer.
2. Set RBW of spectrum analyzer to 3kHz and VBW to 30kHz. Set Detector to Peak, Trace to Max Hold.
3. Mark the frequency with maximum peak power as the center of the display of the spectrum.
4. Set the span to 30kHz and the sweep time to 10s and record the maximum peak value.
5. Measuring multiple antennas, the connector is required to link with spectrum analyzer through a combiner.

4.4.4. Test Setup Layout

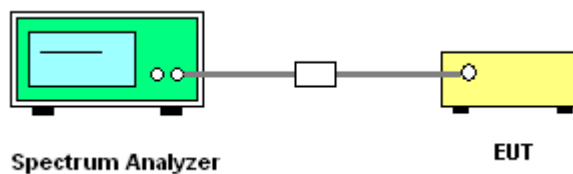

4.4.5. Test Deviation

There is no deviation with the original standard.

4.4.6. EUT Operation during Test

The EUT was programmed to be in continuously transmitting mode.

4.4.7. Test Result of Power Spectral Density

Temperature	20°C	Humidity	61%
Test Engineer	Johnson Chang	Configurations	IEEE 802.11n

For 2.4GHz Band

Configuration IEEE 802.11n MCS8 20MHz

Channel	Frequency	Power Density (dBm/3kHz)			Max. Limit (dBm/3kHz)	Result
		Ant. 1	Ant. 2	Total		
1	2412 MHz	-4.18	-1.94	0.09	8.00	Complies
6	2437 MHz	-4.51	-3.33	-0.87	8.00	Complies
11	2462 MHz	-3.35	-8.44	-2.18	8.00	Complies

Configuration IEEE 802.11n MCS8 40MHz

Channel	Frequency	Power Density (dBm/3kHz)			Max. Limit (dBm/3kHz)	Result
		Ant. 1	Ant. 2	Total		
3	2422 MHz	-15.70	-16.82	-13.21	8.00	Complies
6	2437 MHz	-11.19	-11.04	-8.10	8.00	Complies
9	2452 MHz	-20.11	-14.16	-13.18	8.00	Complies

For 5GHz Band

Configuration 11a IEEE 802.11n MCS8 20MHz

Channel	Frequency	Power Density (dBm/3kHz)			Max. Limit (dBm/3kHz)	Result
		Ant. 1	Ant. 2	Total		
149	5745 MHz	-4.96	-6.84	-2.79	8.00	Complies
157	5785 MHz	-7.19	-7.81	-4.48	8.00	Complies
165	5825 MHz	-4.16	-8.86	-2.89	8.00	Complies

Configuration 11a IEEE 802.11n MCS8 40MHz

Channel	Frequency	Power Density (dBm/3kHz)			Max. Limit (dBm/3kHz)	Result
		Ant. 1	Ant. 2	Total		
151	5755 MHz	-9.64	-9.00	-6.30	8.00	Complies
159	5795 MHz	-5.73	-9.07	-4.08	8.00	Complies

Temperature	20°C	Humidity	61%
Test Engineer	Johnson Chang	Configurations	IEEE 802.11a/b/g

Configuration IEEE 802.11b

Channel	Frequency	Power Density (dBm/3kHz)			Max. Limit (dBm/3kHz)	Result
		Ant. 1	Ant. 2	Total		
1	2412 MHz	-5.27	-6.11	-2.66	8.00	Complies
6	2437 MHz	-2.61	-0.82	1.39	8.00	Complies
11	2462 MHz	-8.52	-8.80	-5.65	8.00	Complies

Configuration IEEE 802.11g

Channel	Frequency	Power Density (dBm/3kHz)			Max. Limit (dBm/3kHz)	Result
		Ant. 1	Ant. 2	Total		
1	2412 MHz	-8.87	-3.19	-2.15	8.00	Complies
6	2437 MHz	-3.44	-3.90	-0.65	8.00	Complies
11	2462 MHz	-7.57	-3.93	-2.37	8.00	Complies

Configuration IEEE 802.11a

Channel	Frequency	Power Density (dBm/3kHz)			Max. Limit (dBm/3kHz)	Result
		Ant. 1	Ant. 2	Total		
149	5745 MHz	-1.82	-7.59	-0.80	7.19	Complies
157	5785 MHz	-5.49	-7.10	-3.21	7.19	Complies
165	5825 MHz	-6.63	-7.99	-4.25	7.19	Complies

Note: All the test values were listed in the report.

For plots, only the worse case of DSSS and OFDM modulation were listed in the report.

Power Density Plot on Configuration IEEE 802.11n MCS8 20MHz Ant. 1 / 2412 MHz

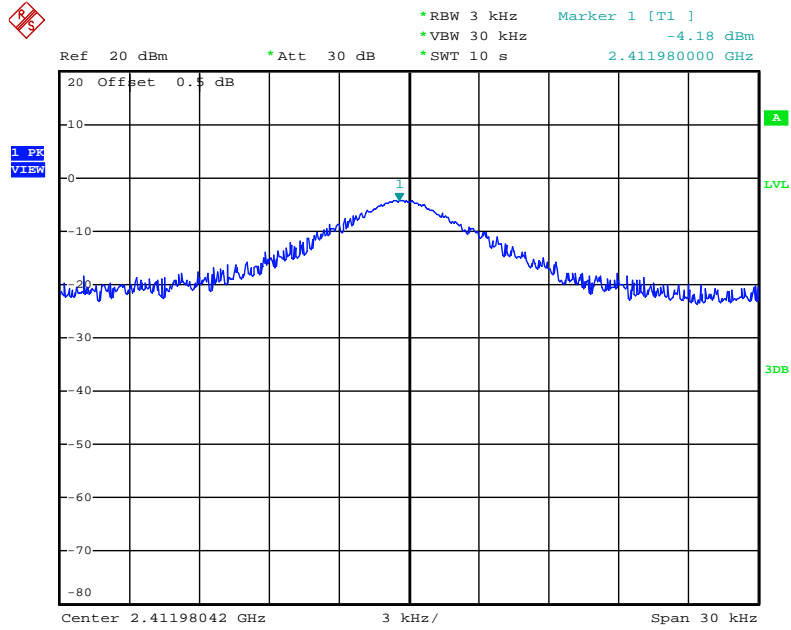

Date: 23.JUN.2011 04:24:54

Power Density Plot on Configuration IEEE 802.11n MCS8 20MHz Ant. 2 / 2412 MHz

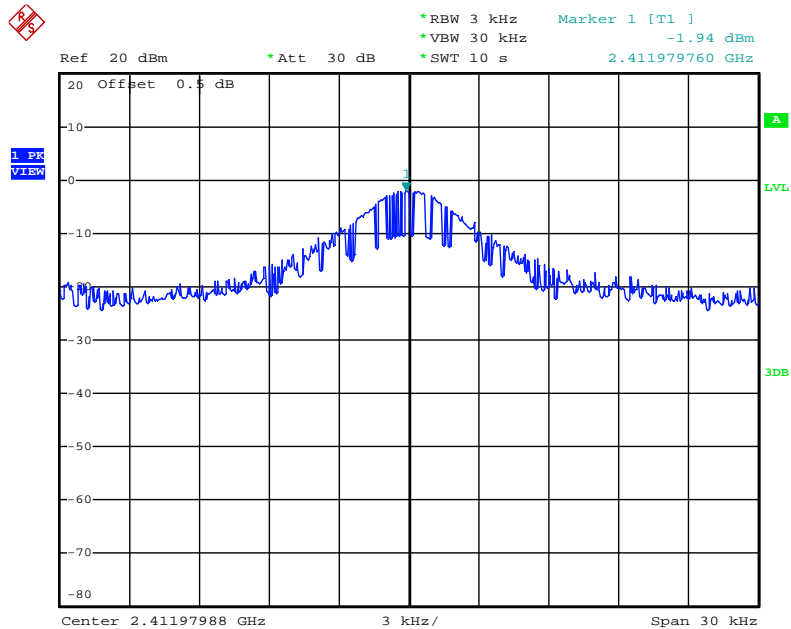

Date: 23.JUN.2011 04:26:54

Power Density Plot on Configuration IEEE 802.11n MCS8 20MHz Ant. 1 / 2437 MHz

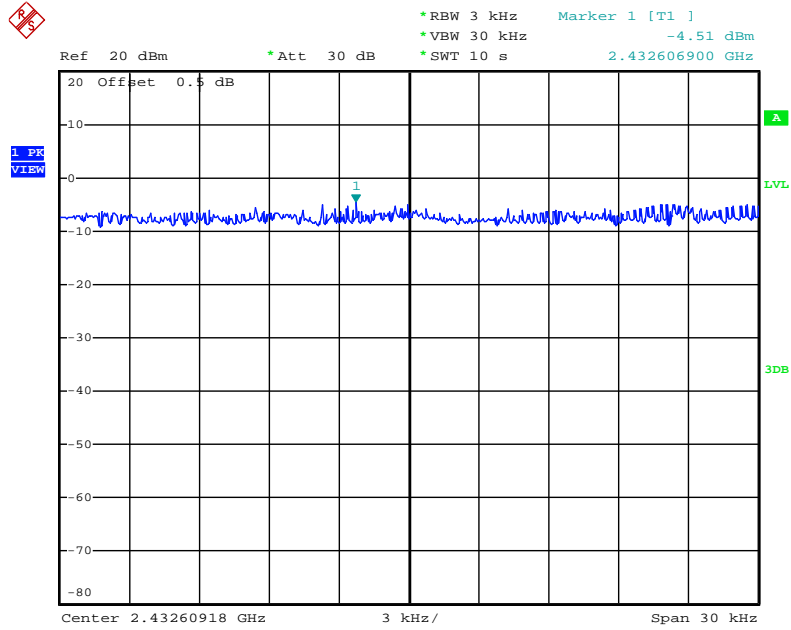

Date: 23.JUN.2011 04:31:22

Power Density Plot on Configuration IEEE 802.11n MCS8 20MHz Ant. 2 / 2437 MHz

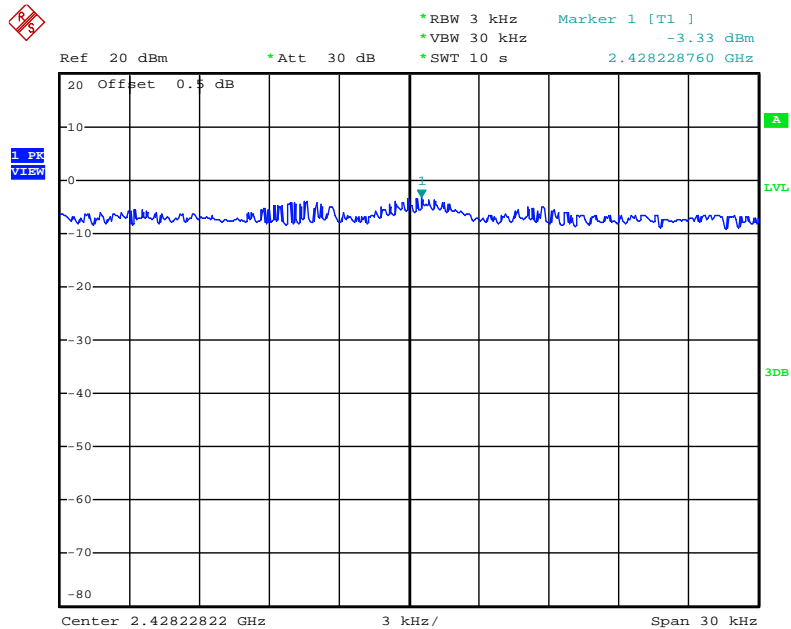

Date: 23.JUN.2011 04:29:21

Power Density Plot on Configuration IEEE 802.11n MCS8 20MHz Ant. 1 / 2462 MHz

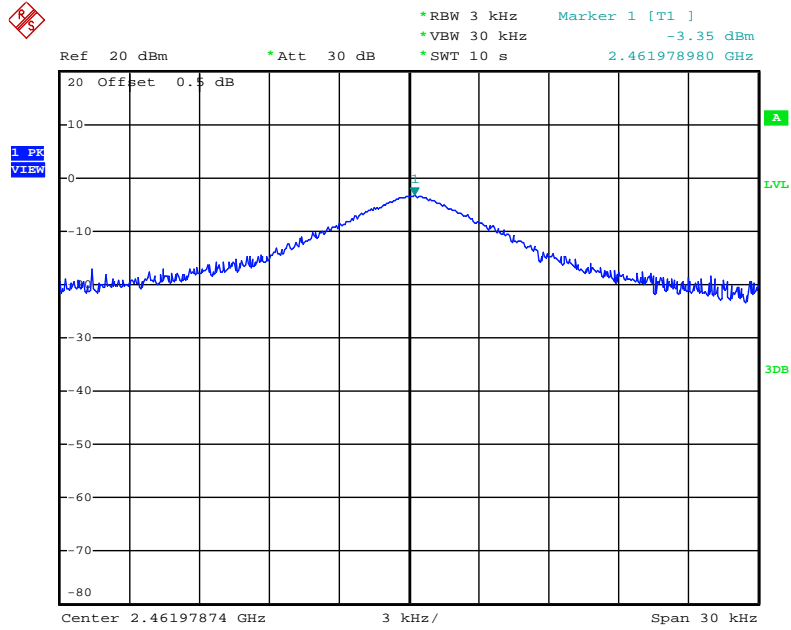

Date: 23.JUN.2011 04:34:18

Power Density Plot on Configuration IEEE 802.11n MCS8 20MHz Ant. 2 / 2462 MHz

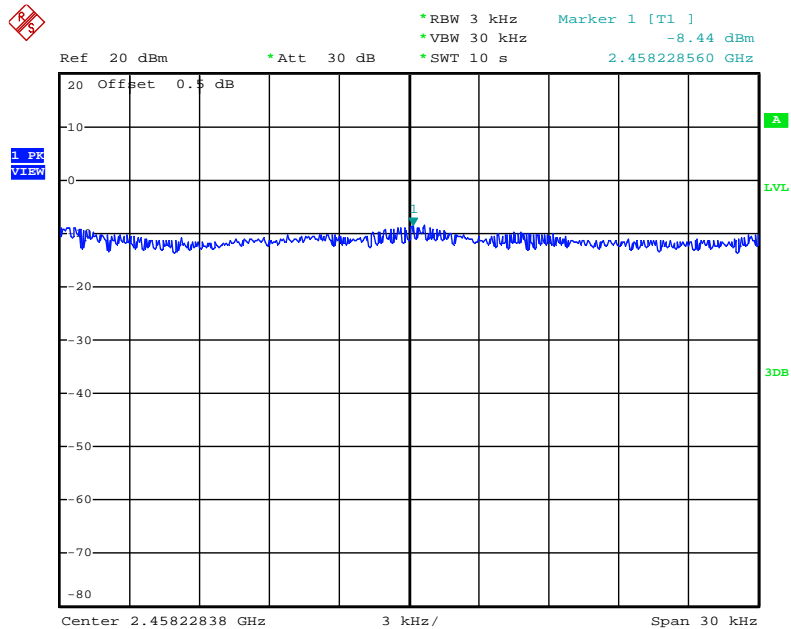

Date: 23.JUN.2011 04:36:14

Power Density Plot on Configuration IEEE 802.11b Ant. 1 / 2412 MHz

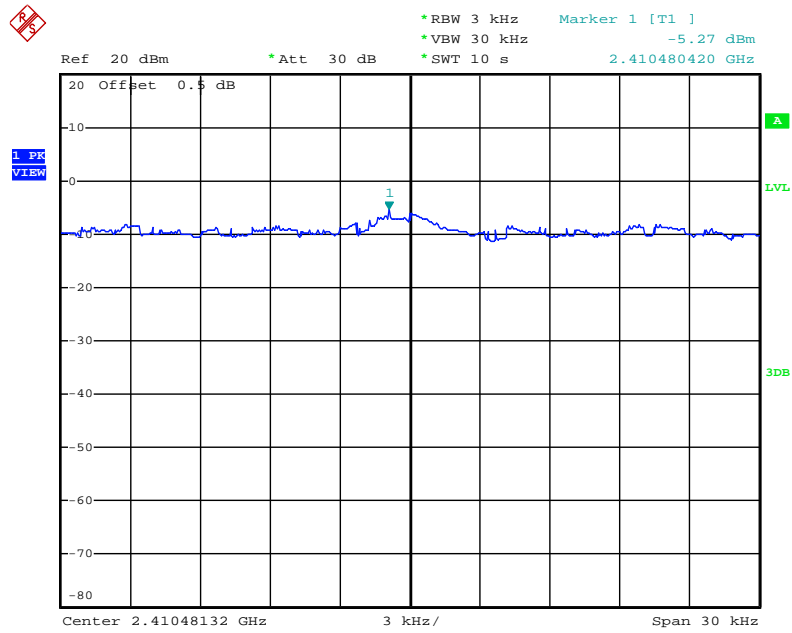

Date: 23.JUN.2011 03:45:06

Power Density Plot on Configuration IEEE 802.11b Ant. 2 / 2412 MHz

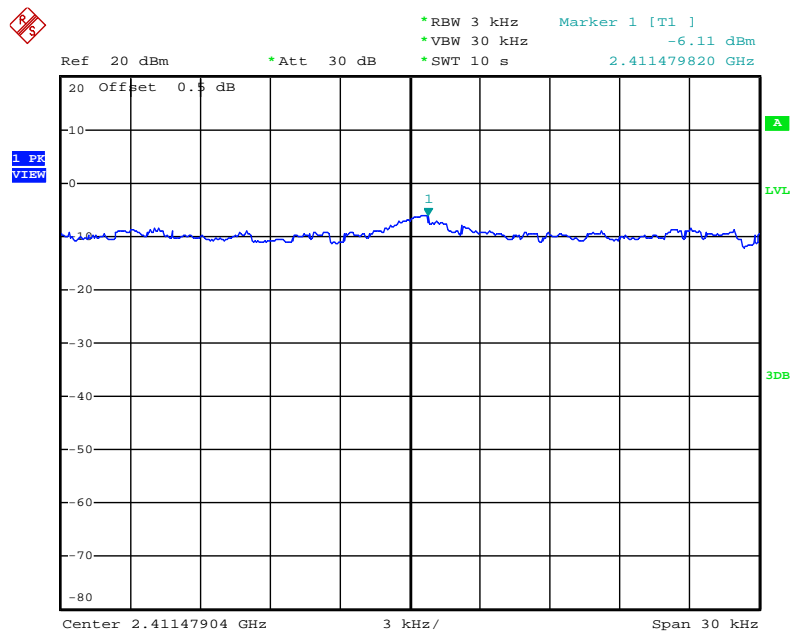

Date: 23.JUN.2011 03:47:35

Power Density Plot on Configuration IEEE 802.11b Ant. 1 / 2437 MHz

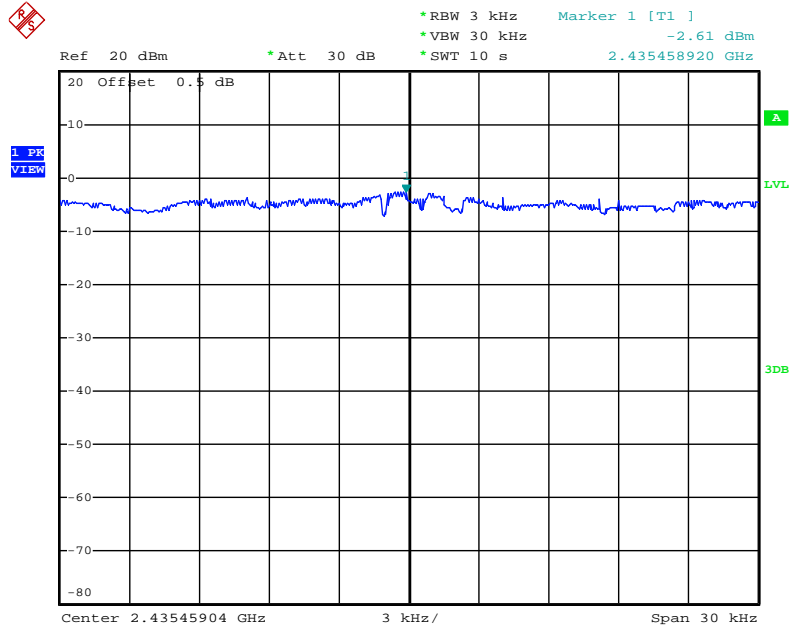

Date: 23.JUN.2011 03:53:51

Power Density Plot on Configuration IEEE 802.11b Ant. 2 / 2437 MHz

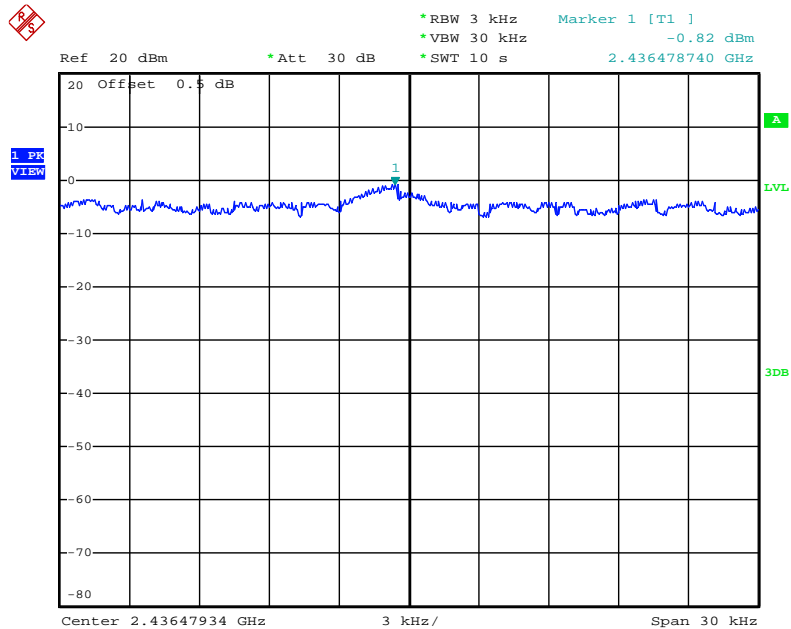

Date: 23.JUN.2011 03:51:49

Power Density Plot on Configuration IEEE 802.11b Ant. 1 / 2462 MHz

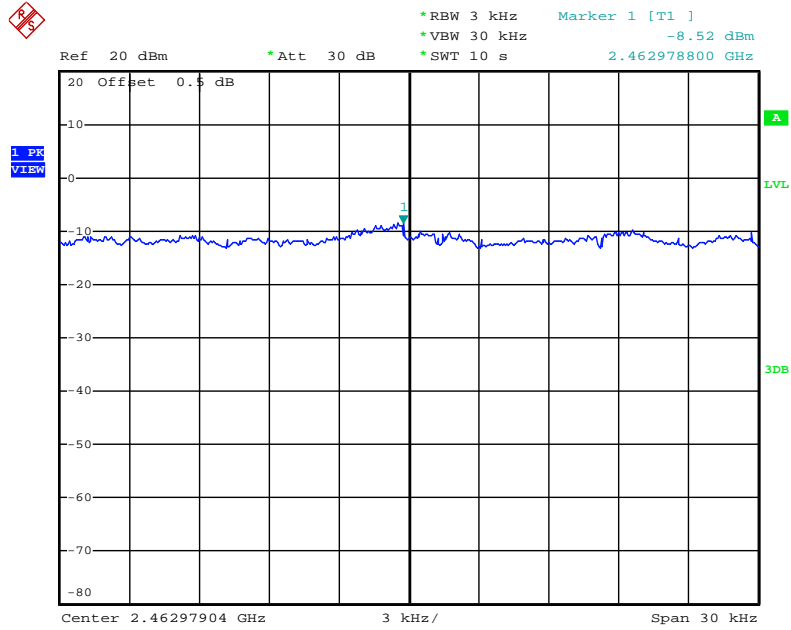

Date: 23.JUN.2011 03:56:35

Power Density Plot on Configuration IEEE 802.11b Ant. 2 / 2462 MHz

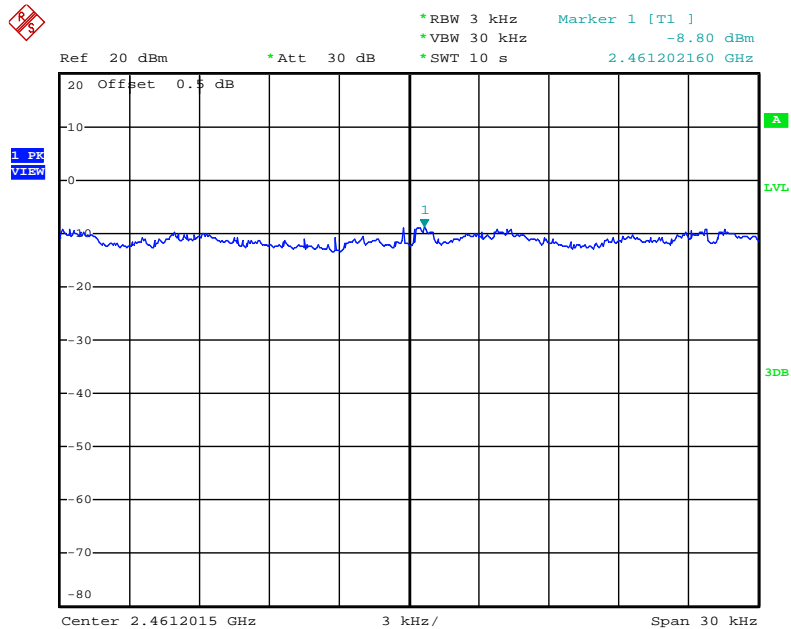

Date: 23.JUN.2011 03:58:21

4.5. 6dB Spectrum Bandwidth Measurement

4.5.1. Limit

For digital modulation systems, the minimum 6dB bandwidth shall be at least 500 kHz.

4.5.2. Measuring Instruments and Setting

Please refer to section 5 of equipments list in this report. The following table is the setting of the spectrum analyzer.

Spectrum Parameters	Setting
Attenuation	Auto
Span Frequency	> 6dB Bandwidth
RB	100 kHz
VB	100 kHz
Detector	Peak
Trace	Max Hold
Sweep Time	Auto

4.5.3. Test Procedures

1. The transmitter output (antenna port) was connected to the spectrum analyzer in peak hold mode.
2. The resolution bandwidth of 100 kHz and the video bandwidth of 100 kHz were used.
3. Measured the spectrum width with power higher than 6dB below carrier.
4. Measuring multiple antennas, the connector is required to link with spectrum analyzer through a combiner.

4.5.4. Test Setup Layout

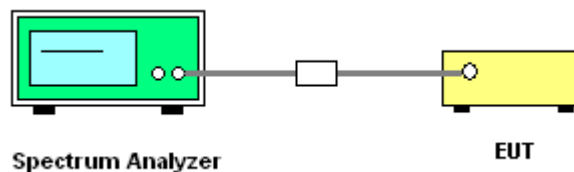

4.5.5. Test Deviation

There is no deviation with the original standard.

4.5.6. EUT Operation during Test

The EUT was programmed to be in continuously transmitting mode.

4.5.7. Test Result of 6dB Spectrum Bandwidth

Temperature	20°C	Humidity	61%
Test Engineer	Johnson Chang	Configurations	IEEE 802.11n

For 2.4GHz Band

Configuration IEEE 802.11n MCS8 20MHz Ant. 1 + Ant. 2

Channel	Frequency	6dB Bandwidth (MHz)	99% Occupied Bandwidth (MHz)	Min. Limit (kHz)	Test Result
1	2412 MHz	16.68	17.64	500	Complies
6	2437 MHz	16.68	17.68	500	Complies
11	2462 MHz	17.04	17.64	500	Complies

Configuration IEEE 802.11n MCS8 40MHz Ant. 1 + Ant. 2

Channel	Frequency	6dB Bandwidth (MHz)	99% Occupied Bandwidth (MHz)	Min. Limit (kHz)	Test Result
3	2422 MHz	35.12	36.32	500	Complies
6	2437 MHz	36.32	36.32	500	Complies
9	2452 MHz	36.32	36.32	500	Complies

For 5GHz Band

Configuration 11a IEEE 802.11n MCS8 20MHz Ant. 1 + Ant. 2

Channel	Frequency	6dB Bandwidth (MHz)	99% Occupied Bandwidth (MHz)	Min. Limit (kHz)	Test Result
149	5745 MHz	16.28	17.68	500	Complies
157	5785 MHz	16.24	17.64	500	Complies
165	5825 MHz	16.32	17.64	500	Complies

Configuration 11a IEEE 802.11n MCS8 40MHz Ant. 1 + Ant. 2

Channel	Frequency	6dB Bandwidth (MHz)	99% Occupied Bandwidth (MHz)	Min. Limit (kHz)	Test Result
151	5755 MHz	35.04	36.32	500	Complies
159	5795 MHz	35.20	36.32	500	Complies

Temperature	20°C	Humidity	61%
Test Engineer	Johnson Chang	Configurations	IEEE 802.11 a/b/g

Configuration IEEE 802.11b Ant. 1 + Ant. 2

Channel	Frequency	6dB Bandwidth (MHz)	99% Occupied Bandwidth (MHz)	Min. Limit (kHz)	Test Result
1	2412 MHz	13.00	15.64	500	Complies
6	2437 MHz	12.56	15.76	500	Complies
11	2462 MHz	12.60	15.68	500	Complies

Configuration IEEE 802.11g Ant. 1 + Ant. 2

Channel	Frequency	6dB Bandwidth (MHz)	99% Occupied Bandwidth (MHz)	Min. Limit (kHz)	Test Result
1	2412 MHz	16.32	16.48	500	Complies
6	2437 MHz	16.32	16.56	500	Complies
11	2462 MHz	16.36	16.44	500	Complies

Configuration IEEE 802.11a Ant. 1 + Ant. 2

Channel	Frequency	6dB Bandwidth (MHz)	99% Occupied Bandwidth (MHz)	Min. Limit (kHz)	Test Result
149	5745 MHz	16.36	16.56	500	Complies
157	5785 MHz	16.32	16.56	500	Complies
165	5825 MHz	16.32	16.52	500	Complies

Note: All the test values were listed in the report.

For plots, only the worse case of DSSS and OFDM modulation were listed in the report.

6 dB Bandwidth Plot on Configuration 11a IEEE 802.11n MCS8 20MHz Ant. 1 + Ant. 2 / 5745 MHz

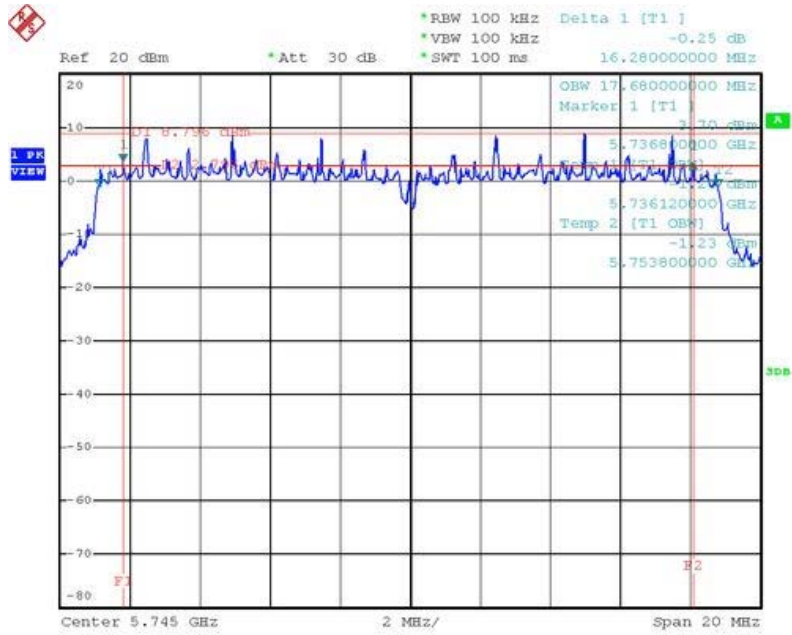

Date: 25.FEB.2011 13:15:06

6 dB Bandwidth Plot on Configuration 11a IEEE 802.11n MCS8 20MHz Ant. 1 + Ant. 2 / 5785MHz

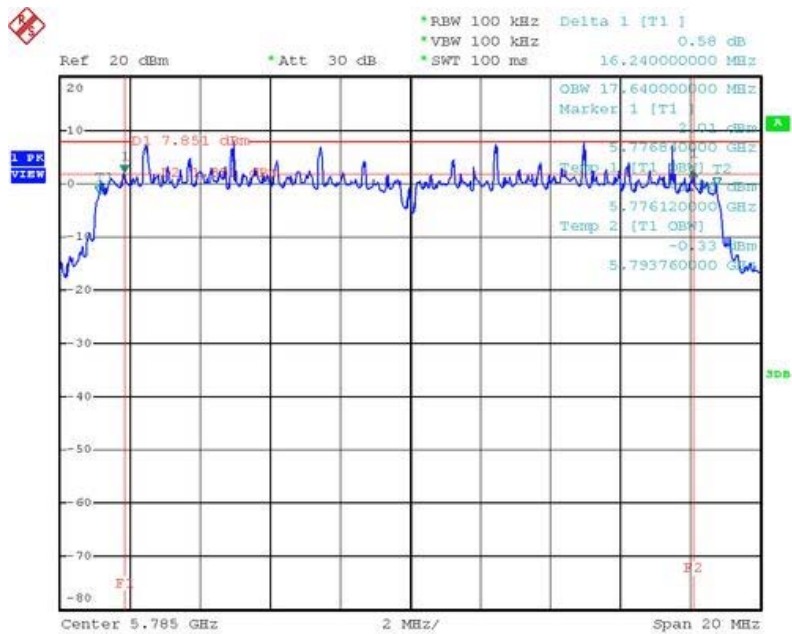

Date: 25.FEB.2011 13:13:00

6 dB Bandwidth Plot on Configuration 11a IEEE 802.11n MCS8 20MHz Ant. 1+ Ant. 2 / 5825 MHz

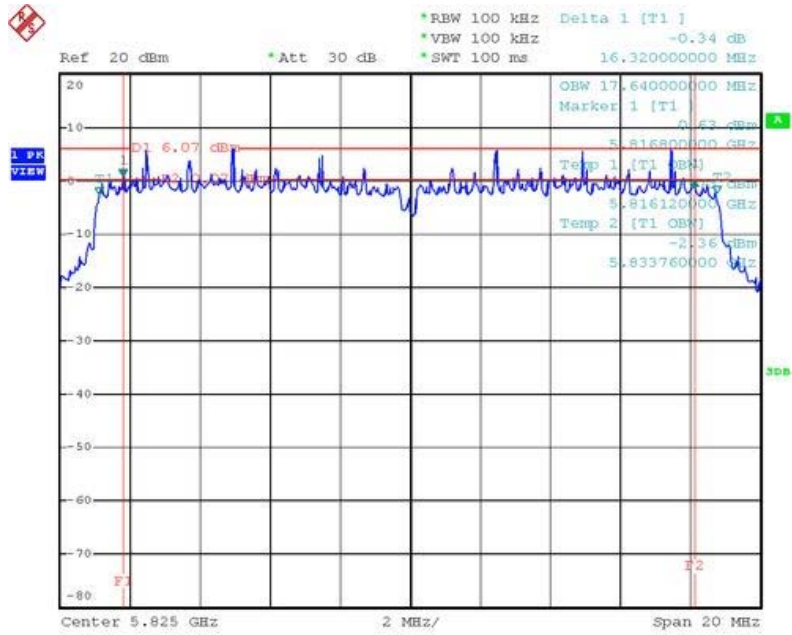

Date: 25.FEB.2011 13:10:54

6 dB Bandwidth Plot on Configuration IEEE 802.11b Ant. 1+ Ant. 2 / 2412 MHz

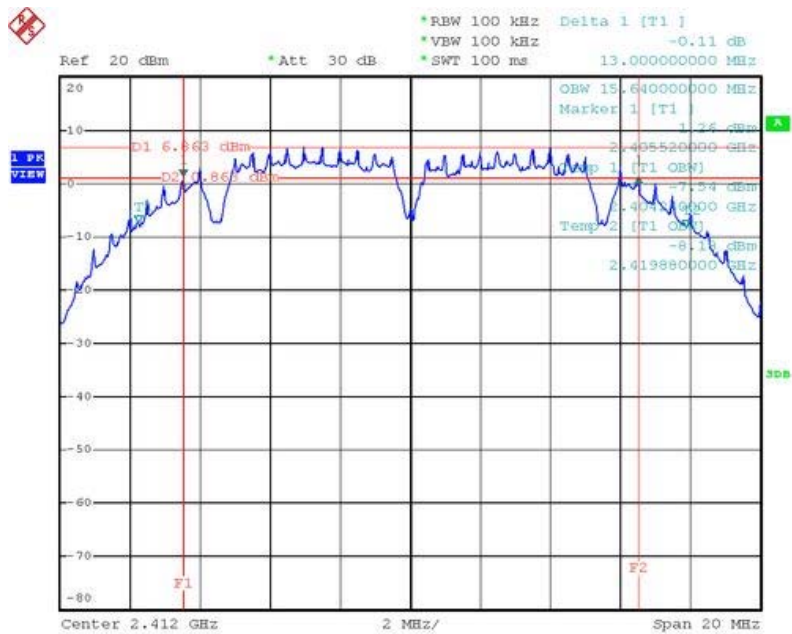

Date: 25.FEB.2011 12:18:54

6 dB Bandwidth Plot on Configuration IEEE 802.11b Ant. 1 + Ant. 2 / 2437 MHz

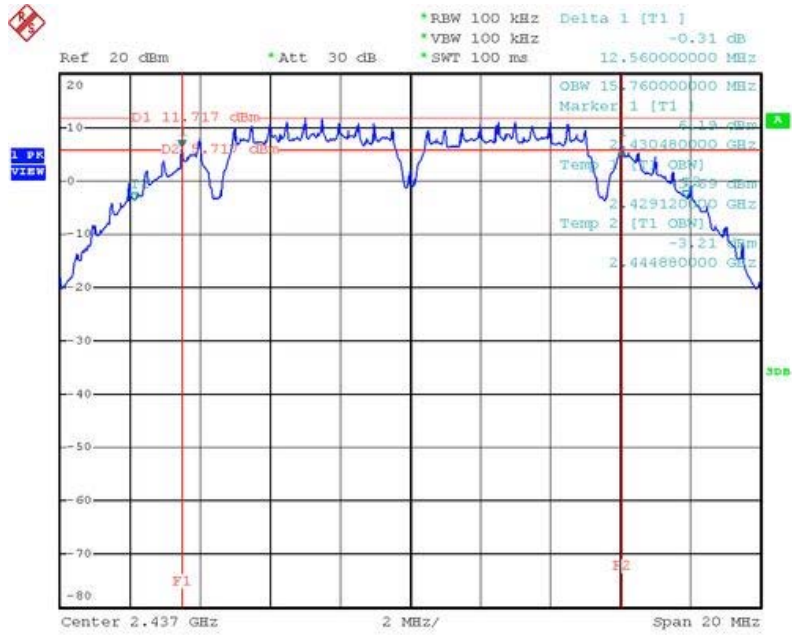

Date: 25.FEB.2011 12:22:01

6 dB Bandwidth Plot on Configuration IEEE 802.11b Ant. 1 + Ant. 2 / 2462 MHz

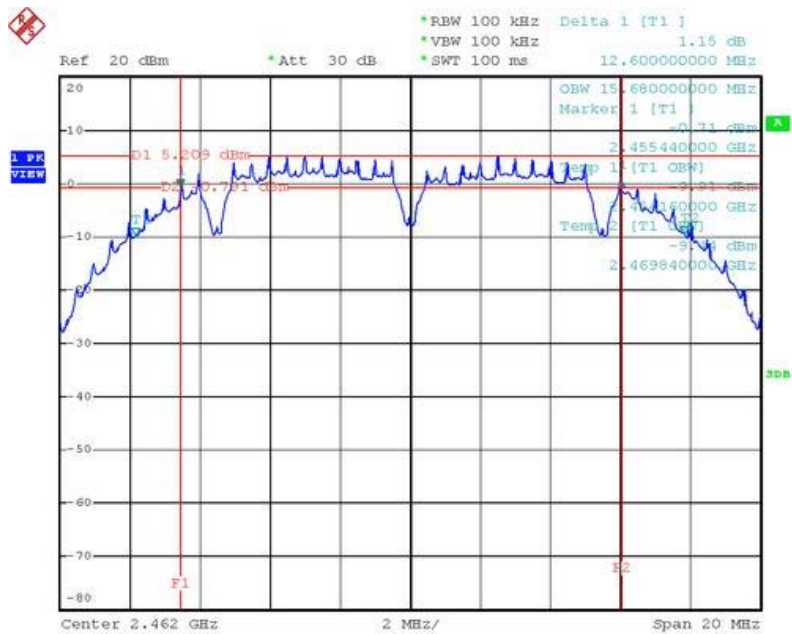

Date: 25.FEB.2011 12:28:10

4.6. Radiated Emissions Measurement

4.6.1. Limit

20dBc in any 100 kHz bandwidth outside the operating frequency band. In case the emission fall within the restricted band specified on 15.205(a), then the 15.209(a) limit in the table below has to be followed.

Frequencies (MHz)	Field Strength (micorvolts/meter)	Measurement Distance (meters)
0.009~0.490	2400/F(KHz)	300
0.490~1.705	24000/F(KHz)	30
1.705~30.0	30	30
30~88	100	3
88~216	150	3
216~960	200	3
Above 960	500	3

4.6.2. Measuring Instruments and Setting

Please refer to section 5 of equipments list in this report. The following table is the setting of spectrum analyzer and receiver.

Spectrum Parameter	Setting
Attenuation	Auto
Start Frequency	1000 MHz
Stop Frequency	10th carrier harmonic
RB / VB (Emission in restricted band)	1MHz / 1MHz for Peak, 1 MHz / 10Hz for Average
RB / VB (Emission in non-restricted band)	1MHz / 1MHz for peak

Receiver Parameter	Setting
Attenuation	Auto
Start ~ Stop Frequency	9kHz~150kHz / RB 200Hz for QP
Start ~ Stop Frequency	150kHz~30MHz / RB 9kHz for QP
Start ~ Stop Frequency	30MHz~1000MHz / RB 120kHz for QP

4.6.3. Test Procedures

1. Configure the EUT according to ANSI C63.10. The EUT was placed on the top of the turntable 0.8 meter above ground. The phase center of the receiving antenna mounted on the top of a height-variable antenna tower was placed 3 meters far away from the turntable.
2. Power on the EUT and all the supporting units. The turntable was rotated by 360 degrees to determine the position of the highest radiation.
3. The height of the broadband receiving antenna was varied between one meter and four meters above ground to find the maximum emissions field strength of both horizontal and vertical polarization.
4. For each suspected emissions, the antenna tower was scan (from 1 M to 4 M) and then the turntable was rotated (from 0 degree to 360 degrees) to find the maximum reading.
5. Set the test-receiver system to Peak or CISPR quasi-peak Detect Function with specified bandwidth under Maximum Hold Mode.
6. For emissions above 1GHz, use 1MHz VBW and RBW for peak reading. Then 1MHz RBW and 10Hz VBW for average reading in spectrum analyzer.
7. When the radiated emissions limits are expressed in terms of the average value of the emissions, and pulsed operation is employed, the measurement field strength shall be determined by averaging over one complete pulse train, including blanking intervals, as long as the pulse train does not exceed 0.1 seconds. As an alternative (provided the transmitter operates for longer than 0.1 seconds) or in cases where the pulse train exceeds 0.1 seconds, the measured field strength shall be determined from the average absolute voltage during a 0.1 second interval during which the field strength is at its maximum value.
8. If the emissions level of the EUT in peak mode was 3 dB lower than the average limit specified, then testing will be stopped and peak values of EUT will be reported, otherwise, the emissions which do not have 3 dB margin will be repeated one by one using the quasi-peak method for below 1GHz.
9. For testing above 1GHz, the emissions level of the EUT in peak mode was lower than average limit (that means the emissions level in peak mode also complies with the limit in average mode), then testing will be stopped and peak values of EUT will be reported, otherwise, the emissions will be measured in average mode again and reported.
10. In case the emission is lower than 30MHz, loop antenna has to be used for measurement and the recorded data should be QP measured by receiver. High – Low scan is not required in this case.

4.6.4. Test Setup Layout

For radiated emissions below 30MHz

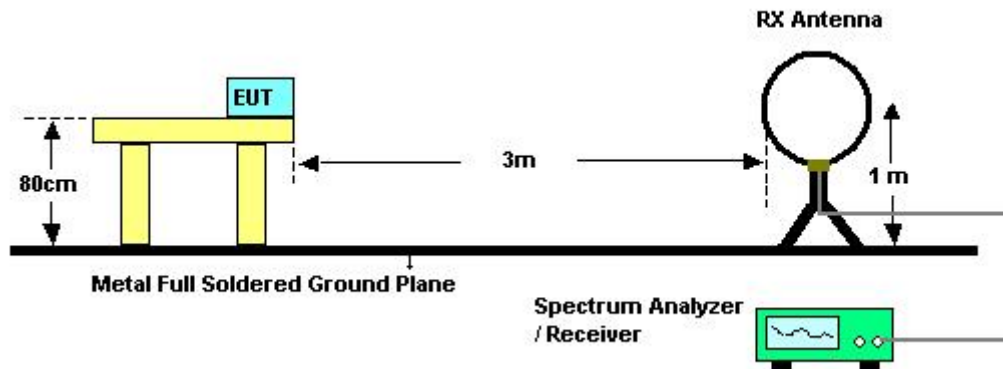

For radiated emissions above 30MHz

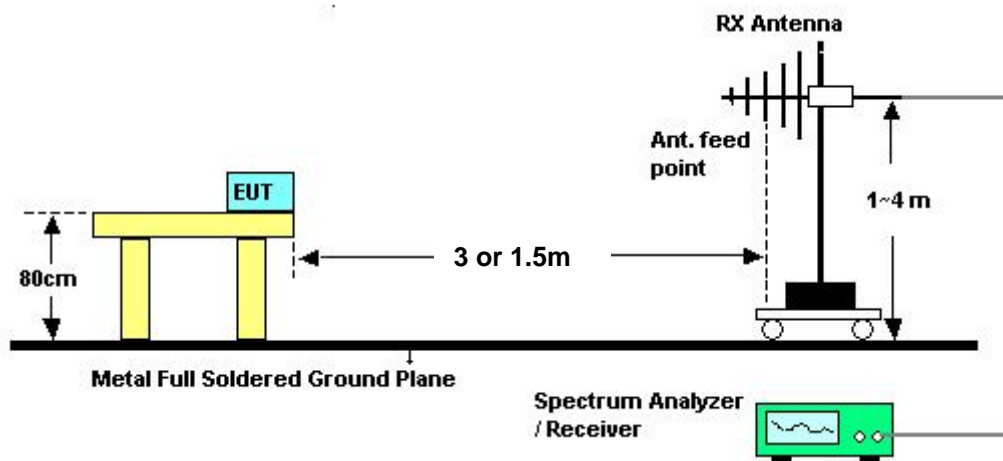

Above 10 GHz shall be extrapolated to the specified distance using an extrapolation factor of 20 dB/decade from 3m to 1.5m.

Distance extrapolation factor = $20 \log (\text{specific distance [3m]} / \text{test distance [1.5m]})$ (dB);

Limit line = specific limits (dBuV) + distance extrapolation factor [6 dB].

4.6.5. Test Deviation

There is no deviation with the original standard.

4.6.6. EUT Operation during Test

The EUT was programmed to be in continuously transmitting mode.

4.6.7. Results of Radiated Emissions (9kHz~30MHz)

Temperature	20°C	Humidity	62%
Test Engineer	Allen Liu	Test Date	Feb. 28, 2011

Freq. (MHz)	Level (dBuV)	Over Limit (dB)	Limit Line (dBuV)	Remark
-	-	-	-	See Note

Note:

The amplitude of spurious emissions that are attenuated by more than 20 dB below the permissible value has no need to be reported.

Distance extrapolation factor = $40 \log(\text{specific distance} / \text{test distance})$ (dB);

Limit line = specific limits (dBuV) + distance extrapolation factor.

4.6.8. Results of Radiated Emissions (30MHz~1GHz)

Temperature	20°C	Humidity	62%
Test Engineer	Allen Liu	Configurations	CTX

Horizontal

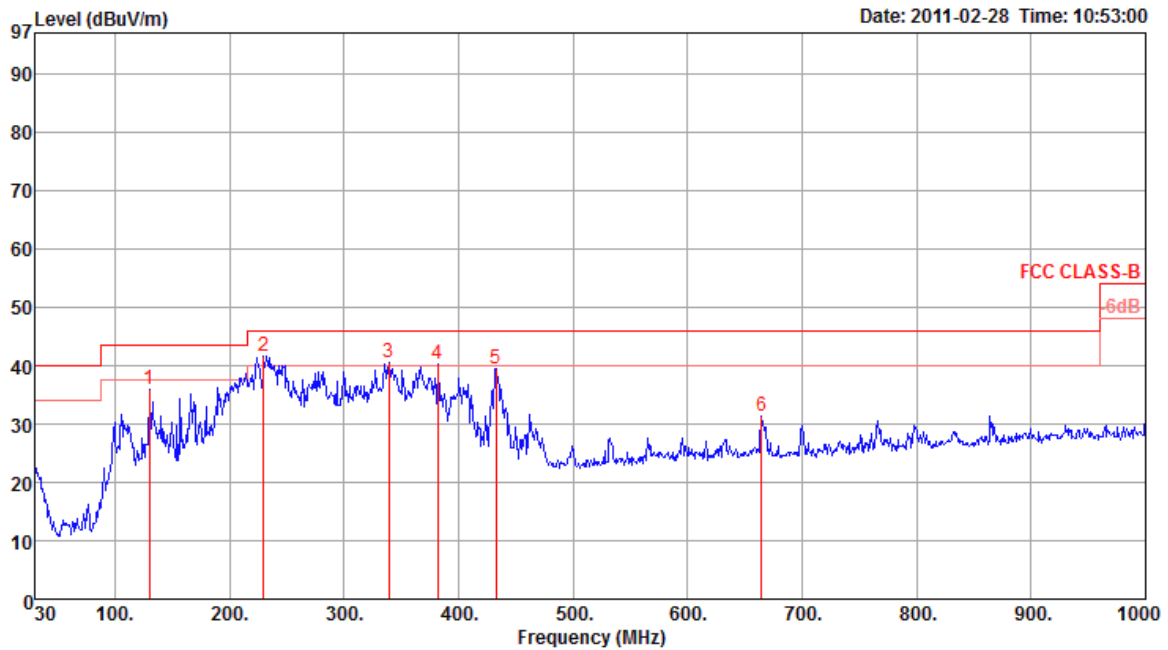

	Freq	Level	Limit Line	Over Limit	Read Level	Cable Loss	Preamp Factor	Antenna Factor	Aux Factor	T/Pos	A/Pos	Remark	Pol/Phase
	MHz	dBuV/m	dBuV/m	dB	dBuV	dB	dB	dB/m	dB	deg	cm		
1	129.91	36.01	43.50	-7.49	50.15	1.30	27.45	12.01	0.00	0	100	Peak	HORIZONTAL
2	229.82	41.64	46.00	-4.36	55.51	1.82	27.04	11.35	0.00	0	100	Peak	HORIZONTAL
3	339.43	40.58	46.00	-5.42	51.03	2.18	27.18	14.55	0.00	0	100	Peak	HORIZONTAL
4	382.11	40.38	46.00	-5.62	49.86	2.26	27.47	15.73	0.00	0	100	Peak	HORIZONTAL
5	432.55	39.54	46.00	-6.46	48.14	2.50	27.76	16.66	0.00	0	100	Peak	HORIZONTAL
6	664.38	31.42	46.00	-14.58	37.03	3.44	28.04	18.99	0.00	0	100	Peak	HORIZONTAL

Vertical

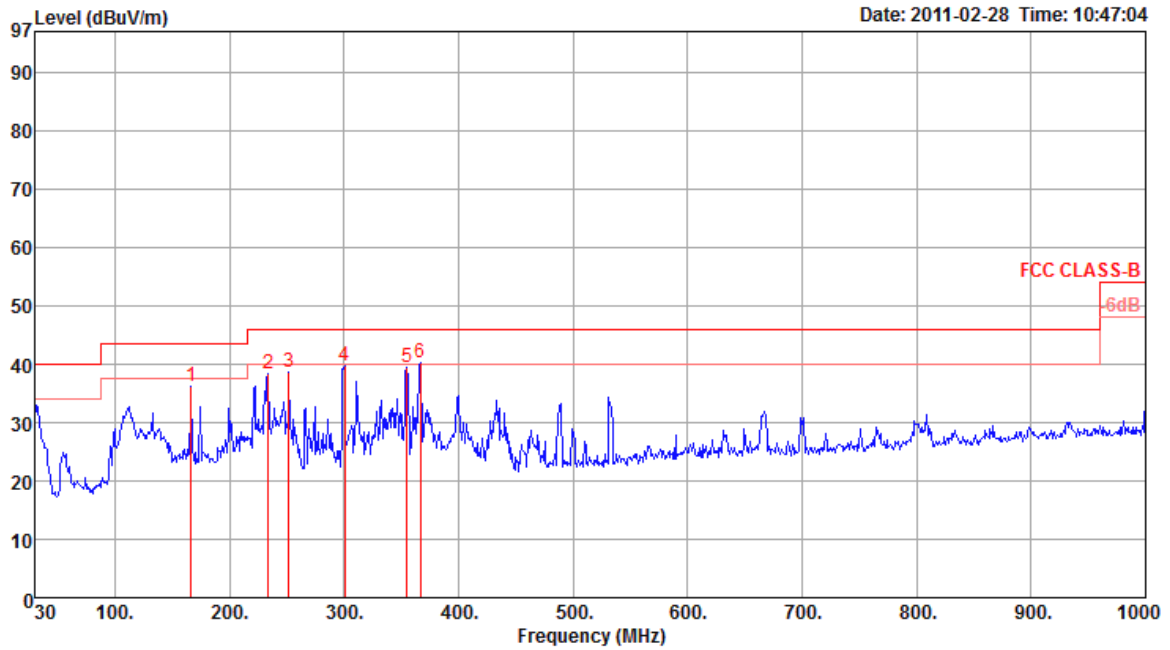

	Freq	Level	Limit	Over	Read	Cable	Preamp	Antenna	Aux	T/Pos	A/Pos	Remark	Pol/Phase
	MHz	dBuV/m	dBuV/m	dB	dBuV	dB	dB	dB/m	dB	deg	cm		
1	166.77	36.32	43.50	-7.18	52.48	1.53	27.27	9.58	0.00	0	400	Peak	VERTICAL
2	233.70	38.43	46.00	-7.57	52.03	1.83	27.03	11.60	0.00	0	400	Peak	VERTICAL
3	252.13	38.75	46.00	-7.25	51.14	1.91	27.00	12.70	0.00	0	400	Peak	VERTICAL
4	300.63	39.72	46.00	-6.28	51.03	2.10	26.90	13.49	0.00	0	400	Peak	VERTICAL
5	354.95	39.42	46.00	-6.58	49.52	2.21	27.29	14.98	0.00	0	400	Peak	VERTICAL
6 p	366.59	40.28	46.00	-5.72	50.12	2.23	27.37	15.30	0.00	112	100	Peak	VERTICAL

Note:

The amplitude of spurious emissions that are attenuated by more than 20dB below the permissible value has no need to be reported.

Emission level (dBuV/m) = 20 log Emission level (uV/m).

Corrected Reading: Antenna Factor + Cable Loss + Read Level - Preamp Factor = Level.

4.6.9. Results for Radiated Emissions (1GHz~10th Harmonic)

Temperature	20°C	Humidity	62%
Test Engineer	Allen Liu	Configurations	IEEE 802.11n MCS8 20MHz Ch 1 / Ant. 1 + Ant. 2
Test Date	Feb. 23, 2011		

Horizontal

	Freq	Level	Limit	Over	Read	Cable	Preamp	Antenna	Aux	T/Pos	A/Pos	Remark	Pol/Phase
	MHz	dBuV/m	dBuV/m	dB	dBuV	dB	dB	dB/m	dB	deg	cm		
1 p	4823.99	42.13	74.00	-31.87	41.93	3.00	35.26	32.46	0.00	207	100	Peak	HORIZONTAL
2 a	4824.03	28.35	54.00	-25.65	28.15	3.00	35.26	32.46	0.00	207	100	Average	HORIZONTAL

Vertical

	Freq	Level	Limit	Over	Read	Cable	Preamp	Antenna	Aux	T/Pos	A/Pos	Remark	Pol/Phase
	MHz	dBuV/m	dBuV/m	dB	dBuV	dB	dB	dB/m	dB	deg	cm		
1 a	4823.98	29.18	54.00	-24.82	28.98	3.00	35.26	32.46	0.00	6	100	Average	VERTICAL
2 p	4823.99	42.28	74.00	-31.72	42.08	3.00	35.26	32.46	0.00	6	100	Peak	VERTICAL

Temperature	20°C	Humidity	62%
Test Engineer	Allen Liu	Configurations	IEEE 802.11n MCS8 20MHz Ch 6 / Ant. 1 + Ant. 2
Test Date	Feb. 23, 2011		

Horizontal

	Freq	Level	Limit	Over	Read	Cable	Preamp	Antenna	Aux	T/Pos	A/Pos	Remark	Pol/Phase
	MHz	dBuV/m	dBuV/m	dB	dBuV	dB	dB	dB/m	dB	deg	cm		
1 a	4873.99	28.84	54.00	-25.16	28.42	3.01	35.15	32.56	0.00	148	100	Average	HORIZONTAL
2 p	4874.00	42.76	74.00	-31.24	42.34	3.01	35.15	32.56	0.00	148	100	Peak	HORIZONTAL

Vertical

	Freq	Level	Limit	Over	Read	Cable	Preamp	Antenna	Aux	T/Pos	A/Pos	Remark	Pol/Phase
	MHz	dBuV/m	dBuV/m	dB	dBuV	dB	dB	dB/m	dB	deg	cm		
1 p	4873.98	44.75	74.00	-29.25	44.33	3.01	35.15	32.56	0.00	216	100	Peak	VERTICAL
2 a	4874.03	32.26	54.00	-21.74	31.84	3.01	35.15	32.56	0.00	216	100	Average	VERTICAL

Temperature	20°C	Humidity	62%
Test Engineer	Allen Liu	Configurations	IEEE 802.11n MCS8 20MHz Ch11 / Ant. 1 + Ant. 2
Test Date	Feb. 23, 2011		

Horizontal

	Freq	Level	Limit	Over	Read	Cable	Preamp	Antenna	Aux	T/Pos	A/Pos	Remark	Pol/Phase
	MHz	dBuV/m	dBuV/m	dB	dBuV	dB	dB	dB/m	dB	deg	cm		
1 a	4923.98	29.09	54.00	-24.91	28.44	3.02	35.03	32.66	0.00	280	100	Average	HORIZONTAL
2 p	4924.00	44.08	74.00	-29.92	43.43	3.02	35.03	32.66	0.00	280	100	Peak	HORIZONTAL

Vertical

	Freq	Level	Limit	Over	Read	Cable	Preamp	Antenna	Aux	T/Pos	A/Pos	Remark	Pol/Phase
	MHz	dBuV/m	dBuV/m	dB	dBuV	dB	dB	dB/m	dB	deg	cm		
1 p	4924.00	42.64	74.00	-31.36	41.99	3.02	35.03	32.66	0.00	158	100	Peak	VERTICAL
2 a	4924.03	31.67	54.00	-22.33	31.02	3.02	35.03	32.66	0.00	158	100	Average	VERTICAL

Temperature	20°C	Humidity	62%
Test Engineer	Allen Liu	Configurations	IEEE 802.11n MCS8 40MHz Ch 3 / Ant. 1 + Ant. 2
Test Date	Feb. 23, 2011		

Horizontal

	Freq	Level	Limit	Over	Read	Cable	Preamp	Antenna	Aux	T/Pos	A/Pos	Remark	Pol/Phase
	MHz	dBuV/m	dBuV/m	dB	dBuV	dB	dB	dB/m	dB	deg	cm		
1 p	4843.99	41.76	74.00	-32.24	41.46	3.01	35.20	32.49	0.00	132	100	Peak	HORIZONTAL
2 a	4844.03	28.37	54.00	-25.63	28.07	3.01	35.20	32.49	0.00	132	100	Average	HORIZONTAL

Vertical

	Freq	Level	Limit	Over	Read	Cable	Preamp	Antenna	Aux	T/Pos	A/Pos	Remark	Pol/Phase
	MHz	dBuV/m	dBuV/m	dB	dBuV	dB	dB	dB/m	dB	deg	cm		
1 a	4843.98	28.62	54.00	-25.38	28.32	3.01	35.20	32.49	0.00	263	100	Average	VERTICAL
2 p	4844.01	42.22	74.00	-31.78	41.92	3.01	35.20	32.49	0.00	263	100	Peak	VERTICAL

Temperature	20°C	Humidity	62%
Test Engineer	Allen Liu	Configurations	IEEE 802.11n MCS8 40MHz Ch 6 / Ant. 1 + Ant. 2
Test Date	Feb. 23, 2011		

Horizontal

	Freq	Level	Limit	Over	Read	Cable	Preamp	Antenna	Aux	T/Pos	A/Pos	Remark	Pol/Phase
	MHz	dBuV/m	dBuV/m	dB	dBuV	dB	dB	dB/m	dB	deg	cm		
1 p	4873.98	42.52	74.00	-31.48	42.10	3.01	35.15	32.56	0.00	248	100	Peak	HORIZONTAL
2 a	4873.99	28.60	54.00	-25.40	28.18	3.01	35.15	32.56	0.00	248	100	Average	HORIZONTAL

Vertical

	Freq	Level	Limit	Over	Read	Cable	Preamp	Antenna	Aux	T/Pos	A/Pos	Remark	Pol/Phase
	MHz	dBuV/m	dBuV/m	dB	dBuV	dB	dB	dB/m	dB	deg	cm		
1 p	4874.00	42.68	74.00	-31.32	42.26	3.01	35.15	32.56	0.00	119	100	Peak	VERTICAL
2 a	4874.03	29.04	54.00	-24.96	28.62	3.01	35.15	32.56	0.00	119	100	Average	VERTICAL

Temperature	20°C	Humidity	62%
Test Engineer	Allen Liu	Configurations	IEEE 802.11n MCS8 40MHz Ch 9 / Ant. 1 + Ant. 2
Test Date	Feb. 23, 2011		

Horizontal

	Freq	Level	Limit	Over	Read	Cable	Preamp	Antenna	Aux	T/Pos	A/Pos	Remark	Pol/Phase
	MHz	dBuV/m	dBuV/m	dB	dBuV	dB	dB	dB/m	dB	deg	cm		
1 p	4903.98	42.25	74.00	-31.75	41.69	3.02	35.09	32.63	0.00	197	100	Peak	HORIZONTAL
2 a	4904.03	28.77	54.00	-25.23	28.21	3.02	35.09	32.63	0.00	197	100	Average	HORIZONTAL

Vertical

	Freq	Level	Limit	Over	Read	Cable	Preamp	Antenna	Aux	T/Pos	A/Pos	Remark	Pol/Phase
	MHz	dBuV/m	dBuV/m	dB	dBuV	dB	dB	dB/m	dB	deg	cm		
1 a	4903.98	29.06	54.00	-24.94	28.50	3.02	35.09	32.63	0.00	1	100	Average	VERTICAL
2 p	4904.00	42.44	74.00	-31.56	41.88	3.02	35.09	32.63	0.00	1	100	Peak	VERTICAL

Temperature	20°C	Humidity	62%
Test Engineer	Allen Liu	Configurations	11a IEEE 802.11n MCS8 20MHz CH 149 / Ant. 1 + Ant. 2
Test Date	Feb. 24, 2011		

Horizontal

	Freq	Level	Limit Line	Over Limit	Read Level	CableAntenna Loss	Antenna Factor	Preamp Factor	T/Pos	A/Pos	Remark	Pol/Phase
	MHz	dBuV/m	dBuV/m	dB	dBuV	dB	dB/m	dB	deg	cm		
1	11489.34	40.26	60.00	-19.74	31.65	5.11	38.78	35.28	221	117	Average	HORIZONTAL
2	11489.42	55.80	80.00	-24.20	47.19	5.11	38.78	35.28	221	117	Peak	HORIZONTAL

Vertical

	Freq	Level	Limit Line	Over Limit	Read Level	CableAntenna Loss	Antenna Factor	Preamp Factor	T/Pos	A/Pos	Remark	Pol/Phase
	MHz	dBuV/m	dBuV/m	dB	dBuV	dB	dB/m	dB	deg	cm		
1	11488.18	56.33	80.00	-23.67	47.72	5.11	38.78	35.28	59	100	Peak	VERTICAL
2	11488.41	41.26	60.00	-18.74	32.65	5.11	38.78	35.28	59	100	Average	VERTICAL

Temperature	20°C	Humidity	62%
Test Engineer	Allen Liu	Configurations	11a IEEE 802.11n MCS8 20MHz CH 157 / Ant. 1 + Ant. 2
Test Date	Feb. 24, 2011		

Horizontal

	Freq	Level	Limit	Over	Read	CableAntenna	Preamp	T/Pos	A/Pos	Remark	Pol/Phase
	MHz	dBuV/m	dBuV/m	dB	dBuV	dB	dB/m	dB	deg	cm	
1	11570.97	40.18	60.00	-19.82	31.51	5.14	38.83	35.30	224	118 Average	HORIZONTAL
2	11571.30	54.37	80.00	-25.63	45.70	5.14	38.83	35.30	224	118 Peak	HORIZONTAL

Vertical

	Freq	Level	Limit	Over	Read	CableAntenna	Preamp	T/Pos	A/Pos	Remark	Pol/Phase
	MHz	dBuV/m	dBuV/m	dB	dBuV	dB	dB/m	dB	deg	cm	
1	11569.70	55.21	80.00	-24.79	46.55	5.13	38.83	35.30	321	105 Peak	VERTICAL
2	11570.11	40.67	60.00	-19.33	32.00	5.14	38.83	35.30	321	105 Average	VERTICAL

Temperature	20°C	Humidity	62%
Test Engineer	Allen Liu	Configurations	11a IEEE 802.11n MCS8 20MHz CH 165 / Ant. 1 + Ant. 2
Test Date	Feb. 24, 2011		

Horizontal

	Freq	Level	Limit Line	Over Limit	Read Level	CableAntenna Loss	Antenna Factor	Preamp Factor	T/Pos	A/Pos	Remark	Pol/Phase
	MHz	dBuV/m	dBuV/m	dB	dBuV	dB	dB/m	dB	deg	cm		
1	11651.60	38.37	60.00	-21.63	29.65	5.16	38.86	35.30	144	126	Average	HORIZONTAL
2	11651.74	49.71	80.00	-30.29	40.99	5.16	38.86	35.30	144	126	Peak	HORIZONTAL

Vertical

	Freq	Level	Limit Line	Over Limit	Read Level	CableAntenna Loss	Antenna Factor	Preamp Factor	T/Pos	A/Pos	Remark	Pol/Phase
	MHz	dBuV/m	dBuV/m	dB	dBuV	dB	dB/m	dB	deg	cm		
1	11649.95	53.23	80.00	-26.77	44.51	5.16	38.86	35.30	324	100	Peak	VERTICAL
2	11649.96	38.66	60.00	-21.34	29.94	5.16	38.86	35.30	324	100	Average	VERTICAL

Temperature	20°C	Humidity	62%
Test Engineer	Allen Liu	Configurations	11a IEEE 802.11n MCS8 40MHz CH 151 / Ant. 1 + Ant. 2
Test Date	Feb. 23, 2011		

Horizontal

	Freq	Level	Limit	Over	Read	CableAntenna	Preamp	T/Pos	A/Pos	Remark	Pol/Phase	
	MHz	dBuV/m	dBuV/m	dB	dBuV	dB	dB/m	dB	deg	cm		
1	11509.71	36.43	60.00	-23.57	27.80	5.12	38.79	35.28	138	100	Average	HORIZONTAL
2	11510.40	47.18	80.00	-32.82	38.55	5.12	38.79	35.28	138	100	Peak	HORIZONTAL

Vertical

	Freq	Level	Limit	Over	Read	CableAntenna	Preamp	T/Pos	A/Pos	Remark	Pol/Phase	
	MHz	dBuV/m	dBuV/m	dB	dBuV	dB	dB/m	dB	deg	cm		
1	11509.54	39.29	60.00	-20.71	30.66	5.12	38.79	35.28	238	100	Average	VERTICAL
2	11510.26	54.46	80.00	-25.54	45.83	5.12	38.79	35.28	238	100	Peak	VERTICAL

Temperature	20°C	Humidity	62%
Test Engineer	Allen Liu	Configurations	11a IEEE 802.11n MCS8 40MHz CH 159 / Ant. 1 + Ant. 2
Test Date	Feb. 24, 2011		

Horizontal

	Freq	Level	Limit Line	Over Limit	Read Level	CableAntenna Loss	Antenna Factor	Preamp Factor	T/Pos	A/Pos	Remark	Pol/Phase
	MHz	dBuV/m	dBuV/m	dB	dBuV	dB	dB/m	dB	deg	cm		
1	11589.88	36.64	60.00	-23.36	27.97	5.14	38.83	35.30	123	100	Average	HORIZONTAL
2	11590.14	48.71	80.00	-31.29	40.04	5.14	38.83	35.30	123	100	Peak	HORIZONTAL

Vertical

	Freq	Level	Limit Line	Over Limit	Read Level	CableAntenna Loss	Antenna Factor	Preamp Factor	T/Pos	A/Pos	Remark	Pol/Phase
	MHz	dBuV/m	dBuV/m	dB	dBuV	dB	dB/m	dB	deg	cm		
1	11590.16	37.38	60.00	-22.62	28.71	5.14	38.83	35.30	220	100	Average	VERTICAL
2	11590.31	52.51	80.00	-27.49	43.84	5.14	38.83	35.30	220	100	Peak	VERTICAL

Temperature	20°C	Humidity	62%
Test Engineer	Allen Liu	Configurations	IEEE 802.11b CH 1 / Ant. 1 + Ant. 2
Test Date	Feb. 23, 2011		

Horizontal

	Freq	Level	Limit	Over	Read	Cable	Preamp	Antenna	Aux	T/Pos	A/Pos	Remark	Pol/Phase
	MHz	dBuV/m	dBuV/m	dB	dBuV	dB	dB	dB/m	dB	deg	cm		
1 a	4823.95	36.33	54.00	-17.67	36.13	3.00	35.26	32.46	0.00	31	103	Average	HORIZONTAL
2 p	4824.01	44.72	74.00	-29.28	44.52	3.00	35.26	32.46	0.00	31	103	Peak	HORIZONTAL

Vertical

	Freq	Level	Limit	Over	Read	Cable	Preamp	Antenna	Aux	T/Pos	A/Pos	Remark	Pol/Phase
	MHz	dBuV/m	dBuV/m	dB	dBuV	dB	dB	dB/m	dB	deg	cm		
1 p	4823.98	53.90	74.00	-20.10	53.70	3.00	35.26	32.46	0.00	130	136	Peak	VERTICAL
2 a	4823.99	46.25	54.00	-7.75	46.05	3.00	35.26	32.46	0.00	130	136	Average	VERTICAL

Temperature	20°C	Humidity	62%
Test Engineer	Allen Liu	Configurations	IEEE 802.11b CH 6 / Ant. 1 + Ant. 2
Test Date	Feb. 23, 2011		

Horizontal

	Freq	Level	Limit	Over	Read	Cable	Preamp	Antenna	Aux	T/Pos	A/Pos	Remark	Pol/Phase
	MHz	dBuV/m	dBuV/m	dB	dBuV	dB	dB	dB/m	dB	deg	cm		
1 p	4873.84	48.51	74.00	-25.49	48.09	3.01	35.15	32.56	0.00	31	104	Peak	HORIZONTAL
2 a	4873.95	44.78	54.00	-9.22	44.36	3.01	35.15	32.56	0.00	31	104	Average	HORIZONTAL

Vertical

	Freq	Level	Limit	Over	Read	Cable	Preamp	Antenna	Aux	T/Pos	A/Pos	Remark	Pol/Phase
	MHz	dBuV/m	dBuV/m	dB	dBuV	dB	dB	dB/m	dB	deg	cm		
1 a	4873.98	46.91	54.00	-7.09	46.49	3.01	35.15	32.56	0.00	34	101	Average	VERTICAL
2 p	4874.00	49.93	74.00	-24.07	49.51	3.01	35.15	32.56	0.00	34	101	Peak	VERTICAL

Temperature	20°C	Humidity	62%
Test Engineer	Allen Liu	Configurations	IEEE 802.11b CH 11 / Ant. 1 + Ant. 2
Test Date	Feb. 23, 2011		

Horizontal

	Freq	Level	Limit	Over	Read	Cable	Preamp	Antenna	Aux	T/Pos	A/Pos	Remark	Pol/Phase
	MHz	dBuV/m	dBuV/m	dB	dBuV	dB	dB	dB/m	dB	deg	cm		
1 p	4923.95	44.34	74.00	-29.66	43.69	3.02	35.03	32.66	0.00	106	100	Peak	HORIZONTAL
2 a	4924.05	34.73	54.00	-19.27	34.08	3.02	35.03	32.66	0.00	106	100	Average	HORIZONTAL

Vertical

	Freq	Level	Limit	Over	Read	Cable	Preamp	Antenna	Aux	T/Pos	A/Pos	Remark	Pol/Phase
	MHz	dBuV/m	dBuV/m	dB	dBuV	dB	dB	dB/m	dB	deg	cm		
1 a	4923.97	44.41	54.00	-9.59	43.76	3.02	35.03	32.66	0.00	195	118	Average	VERTICAL
2 p	4924.09	48.58	74.00	-25.42	47.93	3.02	35.03	32.66	0.00	195	118	Peak	VERTICAL

Temperature	20°C	Humidity	62%
Test Engineer	Allen Liu	Configurations	IEEE 802.11g CH 1 / Ant. 1 + Ant. 2
Test Date	Feb. 23, 2011		

Horizontal

	Freq	Level	Limit Line	Over Limit	Read Level	Cable Loss	Preamp Factor	Antenna Factor	Aux Factor	T/Pos	A/Pos	Remark	Pol/Phase
	MHz	dBuV/m	dBuV/m	dB	dBuV	dB	dB	dB/m	dB	deg	cm		
1 p	4824.01	42.00	74.00	-32.00	41.80	3.00	35.26	32.46	0.00	174	100	Peak	HORIZONTAL
2 a	4824.03	28.40	54.00	-25.60	28.20	3.00	35.26	32.46	0.00	174	100	Average	HORIZONTAL

Vertical

	Freq	Level	Limit Line	Over Limit	Read Level	Cable Loss	Preamp Factor	Antenna Factor	Aux Factor	T/Pos	A/Pos	Remark	Pol/Phase
	MHz	dBuV/m	dBuV/m	dB	dBuV	dB	dB	dB/m	dB	deg	cm		
1 p	4824.00	42.78	74.00	-31.22	42.58	3.00	35.26	32.46	0.00	71	100	Peak	VERTICAL
2 a	4824.03	29.75	54.00	-24.25	29.55	3.00	35.26	32.46	0.00	71	100	Average	VERTICAL

Temperature	20°C	Humidity	62%
Test Engineer	Allen Liu	Configurations	IEEE 802.11g CH 6 / Ant. 1 + Ant. 2
Test Date	Feb. 23, 2011		

Horizontal

	Freq	Level	Limit	Over	Read	Cable	Preamp	Antenna	Aux	T/Pos	A/Pos	Remark	Pol/Phase
	MHz	dBuV/m	dBuV/m	dB	dBuV	dB	dB	dB/m	dB	deg	cm		
1 p	4873.98	42.70	74.00	-31.30	42.28	3.01	35.15	32.56	0.00	276	100	Peak	HORIZONTAL
2 a	4874.03	28.91	54.00	-25.09	28.49	3.01	35.15	32.56	0.00	276	100	Average	HORIZONTAL

Vertical

	Freq	Level	Limit	Over	Read	Cable	Preamp	Antenna	Aux	T/Pos	A/Pos	Remark	Pol/Phase
	MHz	dBuV/m	dBuV/m	dB	dBuV	dB	dB	dB/m	dB	deg	cm		
1 p	4874.01	47.22	74.00	-26.78	46.80	3.01	35.15	32.56	0.00	66	100	Peak	VERTICAL
2 a	4874.03	34.34	54.00	-19.66	33.92	3.01	35.15	32.56	0.00	66	100	Average	VERTICAL

Temperature	20°C	Humidity	62%
Test Engineer	Allen Liu	Configurations	IEEE 802.11g CH 11 / Ant. 1 + Ant. 2
Test Date	Feb. 23, 2011		

Horizontal

	Freq	Level	Limit	Over	Read	Cable	Preamp	Antenna	Aux	T/Pos	A/Pos	Remark	Pol/Phase
	MHz	dBuV/m	dBuV/m	dB	dBuV	dB	dB	dB/m	dB	deg	cm		
1 p	4923.98	43.24	74.00	-30.76	42.59	3.02	35.03	32.66	0.00	356	100	Peak	HORIZONTAL
2 a	4924.03	29.07	54.00	-24.93	28.42	3.02	35.03	32.66	0.00	356	100	Average	HORIZONTAL

Vertical

	Freq	Level	Limit	Over	Read	Cable	Preamp	Antenna	Aux	T/Pos	A/Pos	Remark	Pol/Phase
	MHz	dBuV/m	dBuV/m	dB	dBuV	dB	dB	dB/m	dB	deg	cm		
1 p	4924.03	43.82	74.00	-30.18	43.17	3.02	35.03	32.66	0.00	170	100	Peak	VERTICAL
2 a	4924.03	30.92	54.00	-23.08	30.27	3.02	35.03	32.66	0.00	170	100	Average	VERTICAL

Temperature	20°C	Humidity	62%
Test Engineer	Allen Liu	Configurations	IEEE 802.11a CH 149 / Ant. 1 + Ant. 2
Test Date	Feb. 24, 2011		

Horizontal

	Freq	Level	Limit Line	Over Limit	Read Level	CableAntenna Loss	Antenna Factor	Preamp Factor	T/Pos	A/Pos	Remark	Pol/Phase
	MHz	dBuV/m	dBuV/m	dB	dBuV	dB	dB/m	dB	deg	cm		
1	11489.26	56.87	80.00	-23.13	48.26	5.11	38.78	35.28	223	115	Peak	HORIZONTAL
2	11489.47	41.54	60.00	-18.46	32.93	5.11	38.78	35.28	223	115	Average	HORIZONTAL

Vertical

	Freq	Level	Limit Line	Over Limit	Read Level	CableAntenna Loss	Antenna Factor	Preamp Factor	T/Pos	A/Pos	Remark	Pol/Phase
	MHz	dBuV/m	dBuV/m	dB	dBuV	dB	dB/m	dB	deg	cm		
1	11489.61	42.71	60.00	-17.29	34.10	5.11	38.78	35.28	57	100	Average	VERTICAL
2	11489.84	58.81	80.00	-21.19	50.20	5.11	38.78	35.28	57	100	Peak	VERTICAL

Temperature	20°C	Humidity	62%
Test Engineer	Allen Liu	Configurations	IEEE 802.11a CH 157 / Ant. 1 + Ant. 2
Test Date	Feb. 24, 2011		

Horizontal

	Freq	Level	Limit Line	Over Limit	Read Level	CableAntenna Loss	Antenna Factor	Preamp Factor	T/Pos	A/Pos	Remark	Pol/Phase
	MHz	dBuV/m	dBuV/m	dB	dBuV	dB	dB/m	dB	deg	cm		
1	11569.34	58.84	80.00	-21.16	50.18	5.13	38.83	35.30	222	117	Peak	HORIZONTAL
2	11569.61	42.31	60.00	-17.69	33.65	5.13	38.83	35.30	222	117	Average	HORIZONTAL

Vertical

	Freq	Level	Limit Line	Over Limit	Read Level	CableAntenna Loss	Antenna Factor	Preamp Factor	T/Pos	A/Pos	Remark	Pol/Phase
	MHz	dBuV/m	dBuV/m	dB	dBuV	dB	dB/m	dB	deg	cm		
1	11569.12	58.90	80.00	-21.10	50.24	5.13	38.83	35.30	241	108	Peak	VERTICAL
2	11569.19	42.40	60.00	-17.60	33.74	5.13	38.83	35.30	241	108	Average	VERTICAL

Temperature	20°C	Humidity	62%
Test Engineer	Allen Liu	Configurations	IEEE 802.11a CH 165 / Ant. 1 + Ant. 2
Test Date	Feb. 24, 2011		

Horizontal

	Freq	Level	Limit Line	Over Limit	Read Level	Cable Loss	Antenna Factor	Preamp Factor	T/Pos	A/Pos	Remark	Pol/Phase
	MHz	dBuV/m	dBuV/m	dB	dBuV	dB	dB/m	dB	deg	cm		
1	11649.16	41.21	60.00	-18.79	32.49	5.16	38.86	35.30	222	118	Average	HORIZONTAL
2	11649.29	59.01	80.00	-20.99	50.29	5.16	38.86	35.30	222	118	Peak	HORIZONTAL

Vertical

	Freq	Level	Limit Line	Over Limit	Read Level	Cable Loss	Antenna Factor	Preamp Factor	T/Pos	A/Pos	Remark	Pol/Phase
	MHz	dBuV/m	dBuV/m	dB	dBuV	dB	dB/m	dB	deg	cm		
1	11648.91	58.27	80.00	-21.73	49.55	5.16	38.86	35.30	319	100	Peak	VERTICAL
2	11649.23	40.57	60.00	-19.43	31.85	5.16	38.86	35.30	319	100	Average	VERTICAL

Note:

The amplitude of spurious emissions that are attenuated by more than 20dB below the permissible value has no need to be reported.

Emission level (dBuV/m) = 20 log Emission level (uV/m).

Corrected Reading: Antenna Factor + Cable Loss + Read Level - Preamp Factor = Level.

4.7. Band Edge Emissions Measurement

4.7.1. Limit

20dBc in any 100 kHz bandwidth outside the operating frequency band. In case the emission fall within the restricted band specified on 15.205(a), then the 15.209(a) limit in the table below has to be followed.

Frequencies (MHz)	Field Strength (micorvolts/meter)	Measurement Distance (meters)
0.009~0.490	2400/F(KHz)	300
0.490~1.705	24000/F(KHz)	30
1.705~30.0	30	30
30~88	100	3
88~216	150	3
216~960	200	3
Above 960	500	3

4.7.2. Measuring Instruments and Setting

Please refer to section 5 of equipments list in this report. The following table is the setting of the spectrum analyzer.

Spectrum Parameter	Setting
Attenuation	Auto
Span Frequency	100 MHz
RB / VB (Emission in restricted band)	1MHz / 1MHz for Peak, 1 MHz / 10Hz for Average
RB / VB (Emission in non-restricted band)	100 KHz /100 KHz for Peak

4.7.3. Test Procedures

1. The test procedure is the same as section 4.5.3, only the frequency range investigated is limited to 100MHz around bandedges.
2. In case the emission is fail due to the used RB/VB is too wide, marker-delta method of FCC Public Notice DA00-705 will be followed.

4.7.4. Test Setup Layout

This test setup layout is the same as that shown in section 4.5.4.

4.7.5. Test Deviation

There is no deviation with the original standard.

4.7.6. EUT Operation during Test

The EUT was programmed to be in continuously transmitting mode.

4.7.7. Test Result of Band Edge and Fundamental Emissions

Temperature	20°C	Humidity	62%
Test Engineer	Allen Liu	Configurations	IEEE 802.11n MCS8 20MHz Ch 1, 6, 11 / Ant. 1 + Ant. 2
Test date	Feb. 23, 2011		

Channel 1

	Freq	Level	Limit	Over	Read	Cable	Preamp	Antenna	Aux	T/Pos	A/Pos	Remark	Pol/Phase
	MHz	dBuV/m	dBuV/m	dB	dBuV	dB	dB	dB/m	dB	deg	cm		
1	2389.20	69.19	74.00	-4.81	39.28	2.04	0.00	27.87	0.00	267	100	Peak	VERTICAL
2	2390.00	53.10	54.00	-0.90	23.18	2.05	0.00	27.87	0.00	267	100	Average	VERTICAL
3 a	2408.40	98.52	54.00			2.05	0.00	27.84	0.00	267	100	Average	VERTICAL
4 p	2417.60	110.00	74.00			2.07	0.00	27.84	0.00	267	100	Peak	VERTICAL

Item 3, 4 are the fundamental frequency at 2412 MHz

Channel 6

	Freq	Level	Limit	Over	Read	Cable	Preamp	Antenna	Aux	T/Pos	A/Pos	Remark	Pol/Phase
	MHz	dBuV/m	dBuV/m	dB	dBuV	dB	dB	dB/m	dB	deg	cm		
1	2389.60	67.81	74.00	-6.19	37.90	2.04	0.00	27.87	0.00	89	119	Peak	VERTICAL
2	2390.00	52.24	54.00	-1.76	22.32	2.05	0.00	27.87	0.00	89	119	Average	VERTICAL
3 a	2429.40	105.34	54.00			2.07	0.00	27.81	0.00	89	119	Average	VERTICAL
4 p	2443.60	117.52	74.00			2.08	0.00	27.78	0.00	89	119	Peak	VERTICAL
5	2483.50	49.14	54.00	-4.86	19.31	2.10	0.00	27.73	0.00	89	119	Average	VERTICAL
6	2485.30	61.19	74.00	-12.81	31.36	2.10	0.00	27.73	0.00	89	119	Peak	VERTICAL

Item 3, 4 are the fundamental frequency at 2437MHz.

Channel 11

	Freq	Level	Limit	Over	Read	Cable	Preamp	Antenna	Aux	T/Pos	A/Pos	Remark	Pol/Phase
	MHz	dBuV/m	dBuV/m	dB	dBuV	dB	dB	dB/m	dB	deg	cm		
1 a	2455.00	97.90	54.00			2.08	0.00	27.76	0.00	84	139	Average	VERTICAL
2 p	2455.80	109.86	74.00			2.08	0.00	27.76	0.00	84	139	Peak	VERTICAL
3	2483.50	53.67	54.00	-0.33	23.84	2.10	0.00	27.73	0.00	84	139	Average	VERTICAL
4	2483.70	73.28	74.00	-0.72	43.45	2.10	0.00	27.73	0.00	84	139	Peak	VERTICAL

Item 1, 2 are the fundamental frequency at 2462 MHz.

Temperature	20°C	Humidity	62%
Test Engineer	Allen Liu	Configurations	IEEE 802.11n MCS8 40MHz Ch 3, 6, 9 / Ant. 1 + Ant. 2
Test date	Feb. 23, 2011		

Channel 3

	Freq	Level	Limit	Over	Read	Cable	Preamp	Antenna	Aux	T/Pos	A/Pos	Remark	Pol/Phase
	MHz	dBuV/m	dBuV/m	dB	dBuV	dB	dB	dB/m	dB	deg	cm		
1	2389.60	66.91	74.00	-7.09	37.00	2.04	0.00	27.87	0.00	266	100	Peak	VERTICAL
2	2390.00	53.74	54.00	-0.26	23.82	2.05	0.00	27.87	0.00	266	100	Average	VERTICAL
3 p	2407.60	104.11	74.00			2.05	0.00	27.84	0.00	266	100	Peak	VERTICAL
4 a	2425.60	91.39	54.00			2.07	0.00	27.81	0.00	266	100	Average	VERTICAL

Item 3, 4 are the fundamental frequency at 2422 MHz.

Channel 6

	Freq	Level	Limit	Over	Read	Cable	Preamp	Antenna	Aux	T/Pos	A/Pos	Remark	Pol/Phase
	MHz	dBuV/m	dBuV/m	dB	dBuV	dB	dB	dB/m	dB	deg	cm		
1	2384.00	70.68	74.00	-3.32	40.75	2.04	0.00	27.89	0.00	266	100	Peak	VERTICAL
2	2390.00	53.41	54.00	-0.59	23.49	2.05	0.00	27.87	0.00	266	100	Average	VERTICAL
3 p	2420.60	108.33	74.00			2.07	0.00	27.81	0.00	266	100	Peak	VERTICAL
4 a	2423.40	95.67	54.00			2.07	0.00	27.81	0.00	266	100	Average	VERTICAL
5	2483.50	48.00	54.00	-6.00	18.17	2.10	0.00	27.73	0.00	266	100	Average	VERTICAL
6	2484.30	62.54	74.00	-11.46	32.71	2.10	0.00	27.73	0.00	266	100	Peak	VERTICAL

Item 3, 4 are the fundamental frequency at 2437MHz.

Channel 9

	Freq	Level	Limit	Over	Read	Cable	Preamp	Antenna	Aux	T/Pos	A/Pos	Remark	Pol/Phase
	MHz	dBuV/m	dBuV/m	dB	dBuV	dB	dB	dB/m	dB	deg	cm		
1 a	2444.80	92.03	54.00			2.08	0.00	27.78	0.00	83	100	Average	VERTICAL
2 p	2458.80	103.62	74.00			2.08	0.00	27.76	0.00	83	100	Peak	VERTICAL
3	2483.50	67.21	74.00	-6.79	37.38	2.10	0.00	27.73	0.00	83	100	Peak	VERTICAL
4	2483.50	53.14	54.00	-0.86	23.31	2.10	0.00	27.73	0.00	83	100	Average	VERTICAL

Item 1, 2 are the fundamental frequency at 2452 MHz.

Temperature	20°C	Humidity	62%
Test Engineer	Allen Liu	Configurations	IEEE 802.11b CH 1, 6, 11
Test Date	Feb. 23, 2011		

Channel 1

	Freq	Level	Limit	Over	Read	Cable	Preamp	Antenna	Aux	T/Pos	A/Pos	Remark	Pol/Phase
	MHz	dBuV/m	dBuV/m	dB	dBuV	dB	dB	dB/m	dB	deg	cm		
1	2386.00	60.20	74.00	-13.80	30.29	2.04	0.00	27.87	0.00	266	100	Peak	VERTICAL
2	2386.60	52.89	54.00	-1.11	22.98	2.04	0.00	27.87	0.00	266	100	Average	VERTICAL
3	2410.80	107.57	54.00			2.05	0.00	27.84	0.00	266	100	Average	VERTICAL
4	2411.00	111.28	74.00			2.05	0.00	27.84	0.00	266	100	Peak	VERTICAL

Item 3, 4 are the fundamental frequency at 2412 MHz.

Channel 6

	Freq	Level	Limit	Over	Read	Cable	Preamp	Antenna	Aux	T/Pos	A/Pos	Remark	Pol/Phase
	MHz	dBuV/m	dBuV/m	dB	dBuV	dB	dB	dB/m	dB	deg	cm		
1	2389.40	57.89	74.00	-16.11	27.98	2.04	0.00	27.87	0.00	83	100	Peak	VERTICAL
2	2389.40	49.44	54.00	-4.56	19.53	2.04	0.00	27.87	0.00	83	100	Average	VERTICAL
3	2434.40	115.19	74.00			2.07	0.00	27.81	0.00	83	100	Peak	VERTICAL
4	2435.20	111.51	54.00			2.07	0.00	27.81	0.00	83	100	Average	VERTICAL
5	2484.50	59.96	74.00	-14.04	30.13	2.10	0.00	27.73	0.00	83	100	Peak	VERTICAL
6	2485.60	52.13	54.00	-1.87	22.30	2.10	0.00	27.73	0.00	83	100	Average	VERTICAL

Item 3, 4 are the fundamental frequency at 2437 MHz.

Channel 11

	Freq	Level	Limit	Over	Read	Cable	Preamp	Antenna	Aux	T/Pos	A/Pos	Remark	Pol/Phase
	MHz	dBuV/m	dBuV/m	dB	dBuV	dB	dB	dB/m	dB	deg	cm		
1	2464.20	102.03	54.00			2.08	0.00	27.76	0.00	111	100	Average	VERTICAL
2	2464.60	105.43	74.00			2.08	0.00	27.76	0.00	111	100	Peak	VERTICAL
3	2487.50	59.43	74.00	-14.57	29.63	2.10	0.00	27.70	0.00	111	100	Peak	VERTICAL
4	2487.70	53.00	54.00	-1.00	23.20	2.10	0.00	27.70	0.00	111	100	Average	VERTICAL

Item 1, 2 are the fundamental frequency at 2462 MHz.

Temperature	20°C	Humidity	62%
Test Engineer	Allen Liu	Configurations	IEEE 802.11g CH 1, 6, 11
Test Date	Feb. 23, 2011		

Channel 1

	Freq	Level	Limit	Over	Read	Cable	Preamp	Antenna	Aux	T/Pos	A/Pos	Remark	Pol/Phase
	MHz	dBuV/m	dBuV/m	dB	dBuV	dB	dB	dB/m	dB	deg	cm		
1	2389.80	68.52	74.00	-5.48	38.60	2.05	0.00	27.87	0.00	264	100	Peak	VERTICAL
2	2390.00	53.27	54.00	-0.73	23.35	2.05	0.00	27.87	0.00	264	100	Average	VERTICAL
3 p	2404.60	110.69	74.00			2.05	0.00	27.84	0.00	264	100	Peak	VERTICAL
4 a	2407.00	101.09	54.00			2.05	0.00	27.84	0.00	264	100	Average	VERTICAL

Item 3, 4 are the fundamental frequency at 2412 MHz.

Channel 6

	Freq	Level	Limit	Over	Read	Cable	Preamp	Antenna	Aux	T/Pos	A/Pos	Remark	Pol/Phase
	MHz	dBuV/m	dBuV/m	dB	dBuV	dB	dB	dB/m	dB	deg	cm		
1	2388.60	70.63	74.00	-3.37	40.72	2.04	0.00	27.87	0.00	84	112	Peak	VERTICAL
2	2389.80	52.93	54.00	-1.07	23.01	2.05	0.00	27.87	0.00	84	112	Average	VERTICAL
3 p	2432.80	117.90	74.00			2.07	0.00	27.81	0.00	84	112	Peak	VERTICAL
4 a	2433.60	107.82	54.00			2.07	0.00	27.81	0.00	84	112	Average	VERTICAL
5	2483.50	49.60	54.00	-4.40	19.77	2.10	0.00	27.73	0.00	84	112	Average	VERTICAL
6	2484.10	65.15	74.00	-8.85	35.32	2.10	0.00	27.73	0.00	84	112	Peak	VERTICAL

Item 3, 4 are the fundamental frequency at 2437 MHz.

Channel 11

	Freq	Level	Limit	Over	Read	Cable	Preamp	Antenna	Aux	T/Pos	A/Pos	Remark	Pol/Phase
	MHz	dBuV/m	dBuV/m	dB	dBuV	dB	dB	dB/m	dB	deg	cm		
1 p	2458.80	112.12	74.00			2.08	0.00	27.76	0.00	257	100	Peak	VERTICAL
2 a	2463.40	102.12	54.00			2.08	0.00	27.76	0.00	257	100	Average	VERTICAL
3	2483.50	53.39	54.00	-0.61	23.56	2.10	0.00	27.73	0.00	257	100	Average	VERTICAL
4	2483.70	70.00	74.00	-3.91	40.26	2.10	0.00	27.73	0.00	257	100	Peak	VERTICAL

Item 1, 2 are the fundamental frequency at 2462 MHz.

Note:

Emission level (dBuV/m) = 20 log Emission level (uV/m).

Corrected Reading: Antenna Factor + Cable Loss + Read Level - Preamp Factor = Level.

For Emission not in Restricted Band

Low Band Edge Plot on Configuration IEEE 802.11n MCS0 20MHz Ant. 1 + Ant. 2 / 2412 MHz

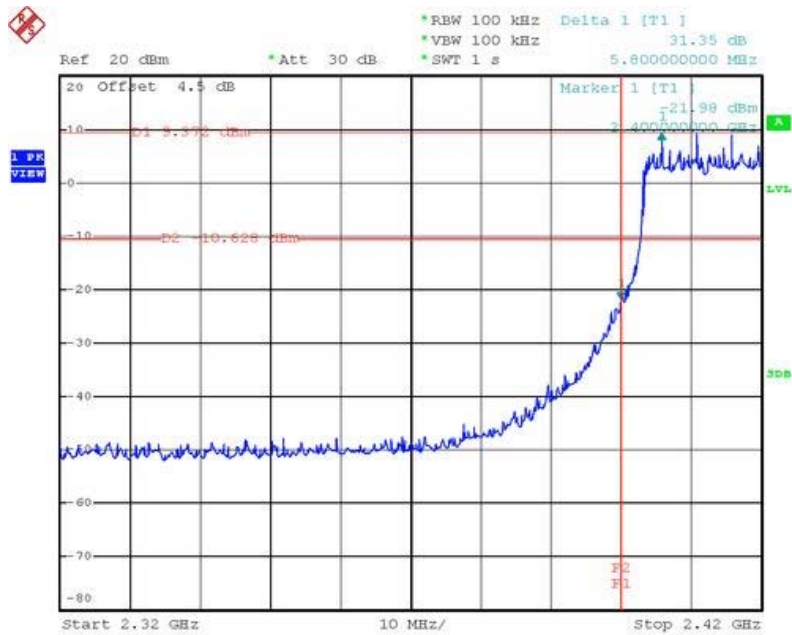

Date: 25.FEB.2011 12:48:37

High Band Edge Plot on Configuration IEEE 802.11n MCS0 20MHz Ant. 1 + Ant. 2 / 2462 MHz

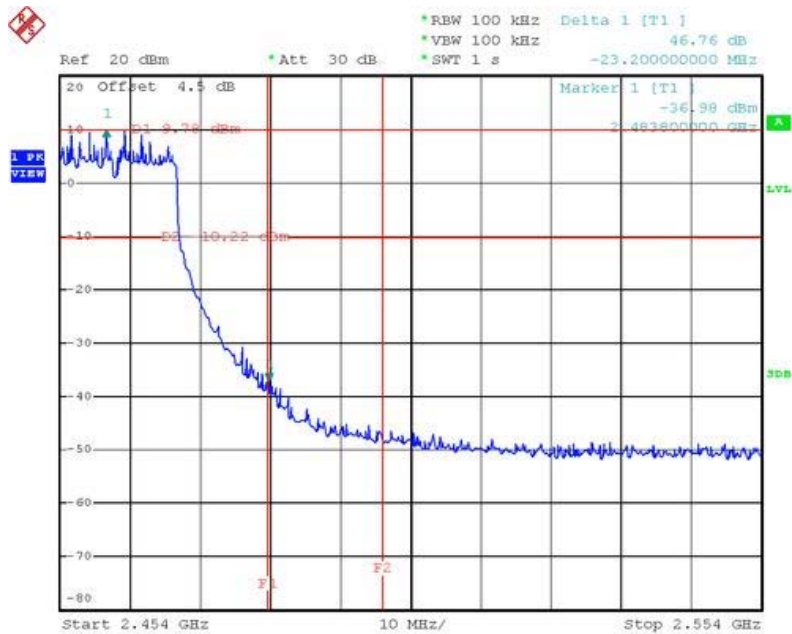

Date: 25.FEB.2011 12:46:31

Low Band Edge Plot on Configuration IEEE 802.11n MCS0 40MHz Ant. 1 + Ant. 2 / 2422 MHz

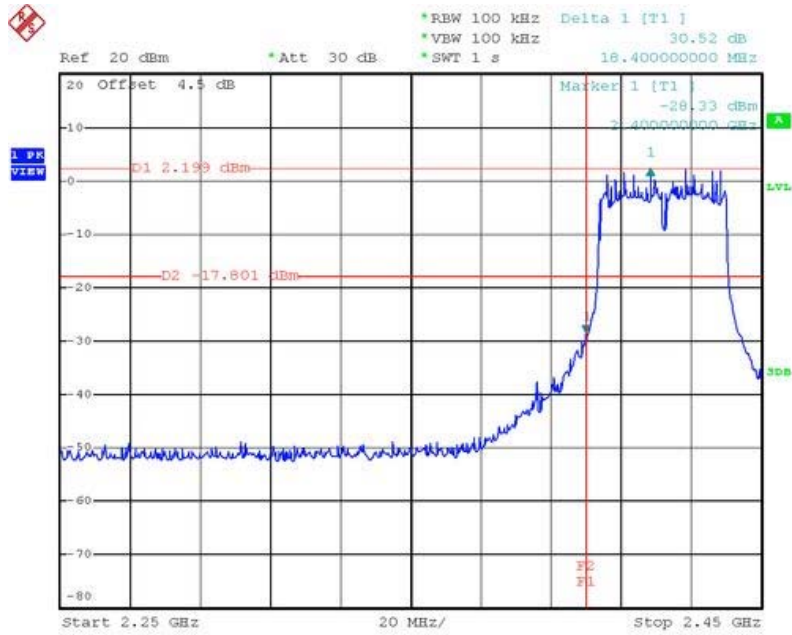

Date: 25.FEB.2011 12:51:05

High Band Edge Plot on Configuration IEEE 802.11n MCS0 40MHz Ant. 1 + Ant. 2 / 2452 MHz

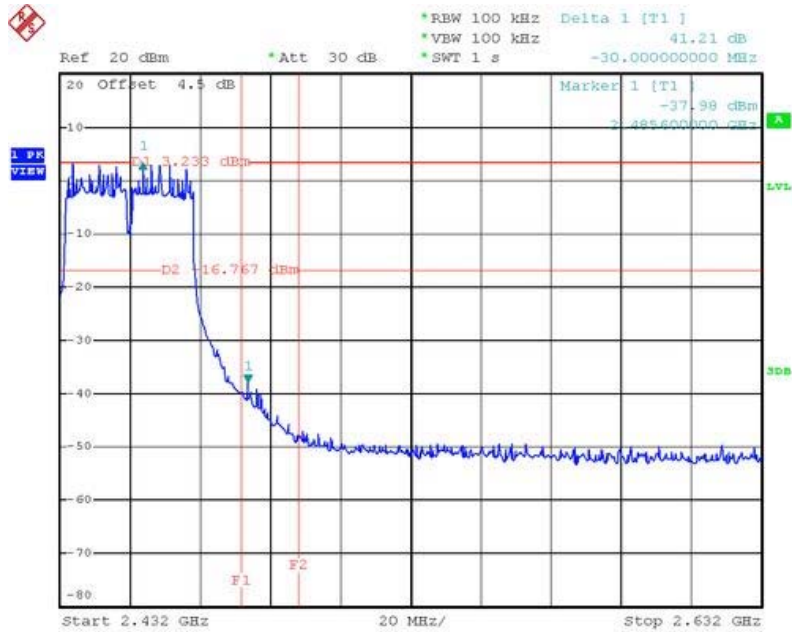

Date: 25.FEB.2011 12:59:35

Low Band Edge Plot on Configuration 11a IEEE 802.11n MCS0 20MHz Ant. 1 + Ant. 2 / 5745 MHz

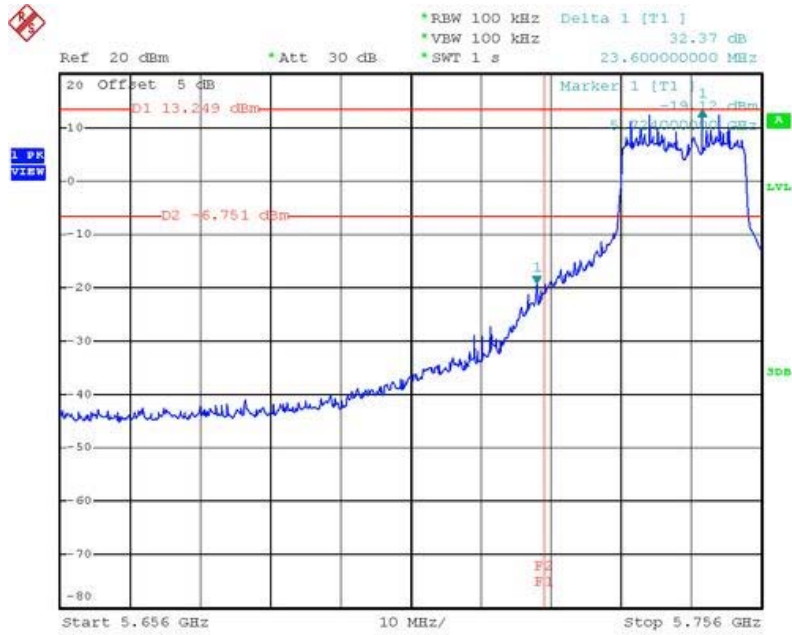

Date: 25.FEB.2011 13:16:46

High Band Edge Plot on Configuration 11a IEEE 802.11n MCS0 20MHz Ant. 1 + Ant. 2 / 5825 MHz

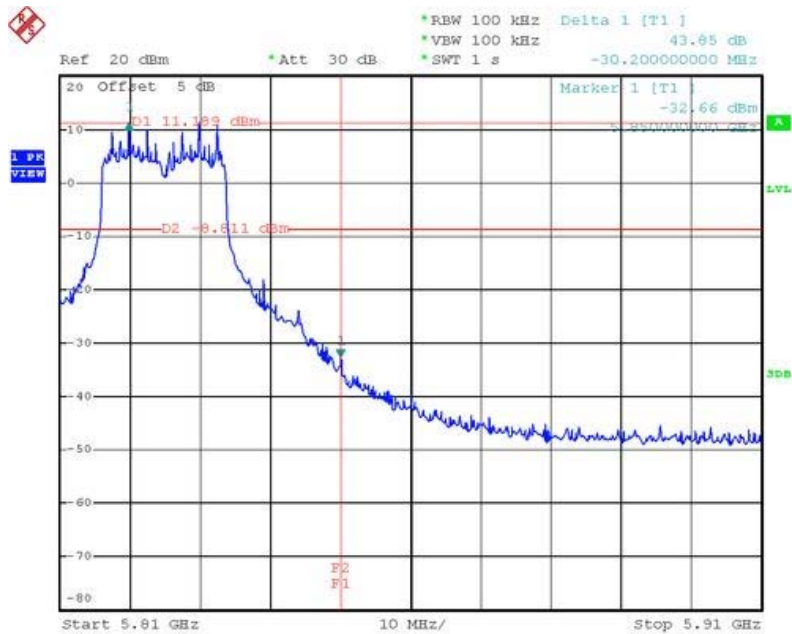

Date: 25.FEB.2011 13:12:34

Low Band Edge Plot on Configuration 11a IEEE 802.11n MCS0 40MHz Ant. 1 + Ant. 2 / 5755 MHz

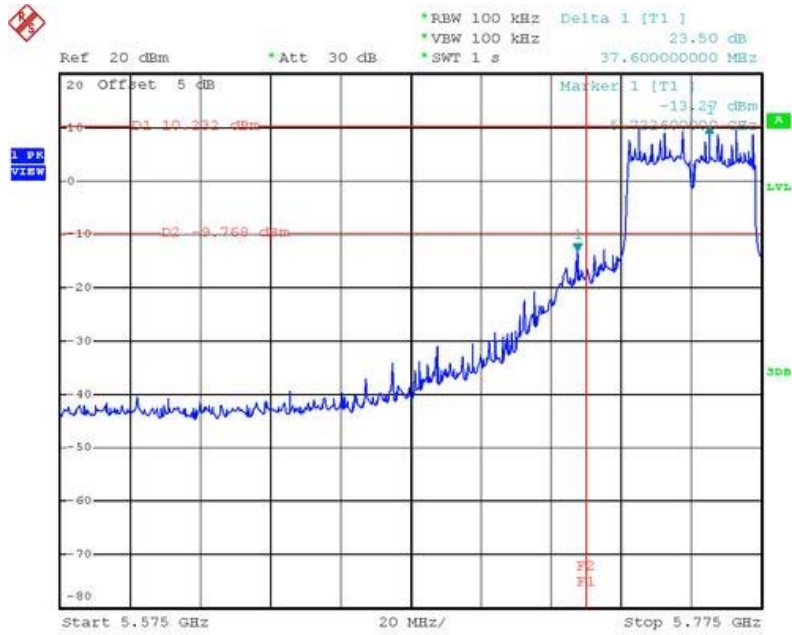

Date: 25.FEB.2011 13:23:48

High Band Edge Plot on Configuration 11a IEEE 802.11n MCS0 40MHz Ant. 1 + Ant. 2 / 5795 MHz

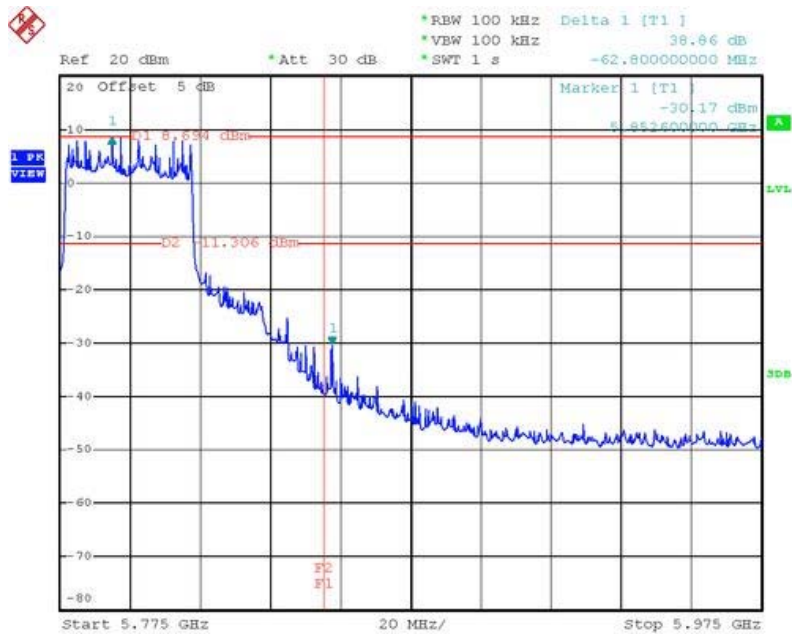

Date: 25.FEB.2011 13:21:42

Low Band Edge Plot on Configuration IEEE 802.11b Ant. 1 + Ant. 2 / 2412 MHz

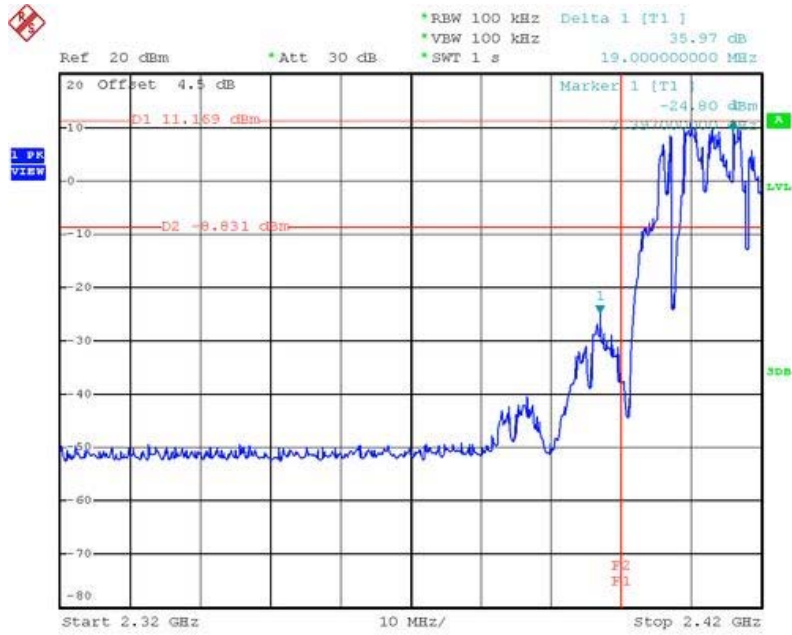

Date: 25.FEB.2011 12:20:39

High Band Edge Plot on Configuration IEEE 802.11b Ant. 1 + Ant. 2 / 2462 MHz

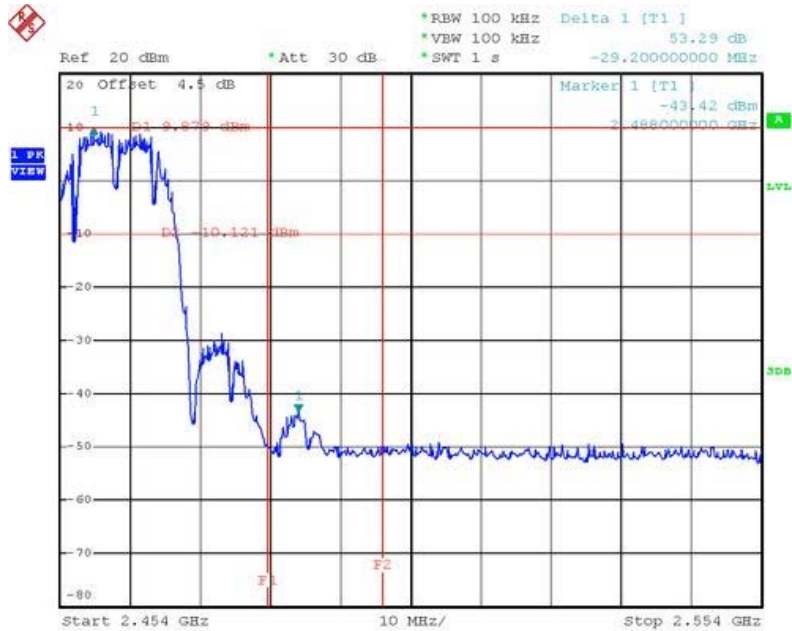

Date: 25.FEB.2011 12:29:51

Low Band Edge Plot on Configuration IEEE 802.11g Ant. 1 + Ant. 2 / 2412 MHz

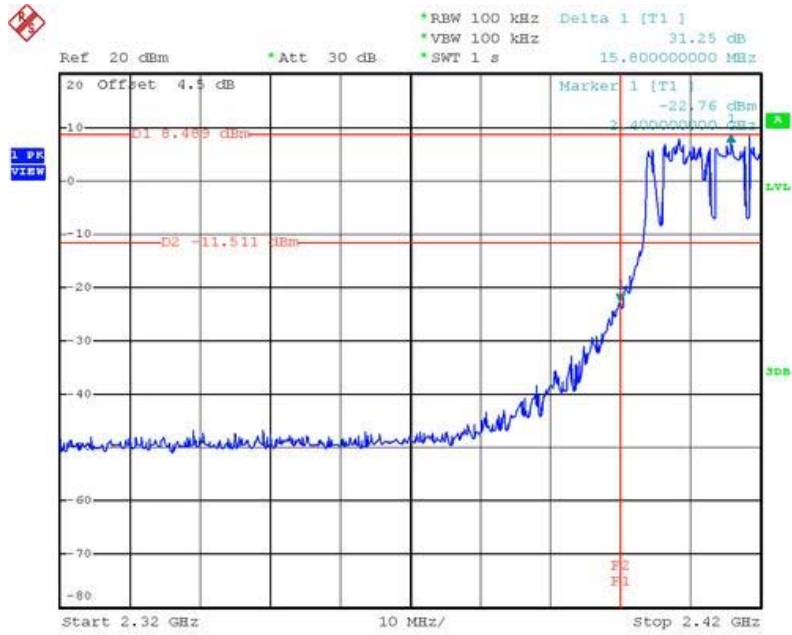

Date: 25.FEB.2011 12:37:37

High Band Edge Plot on Configuration IEEE 802.11g Ant. 1 + Ant. 2 / 2462 MHz

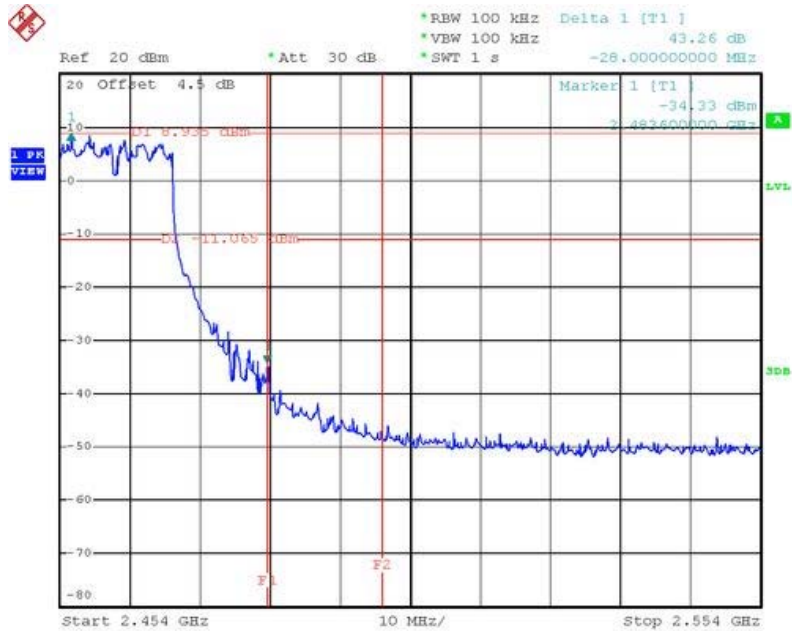

Date: 25.FEB.2011 12:32:46

Low Band Edge Plot on Configuration IEEE 802.11a Ant. 1 + Ant. 2 / 5745 MHz

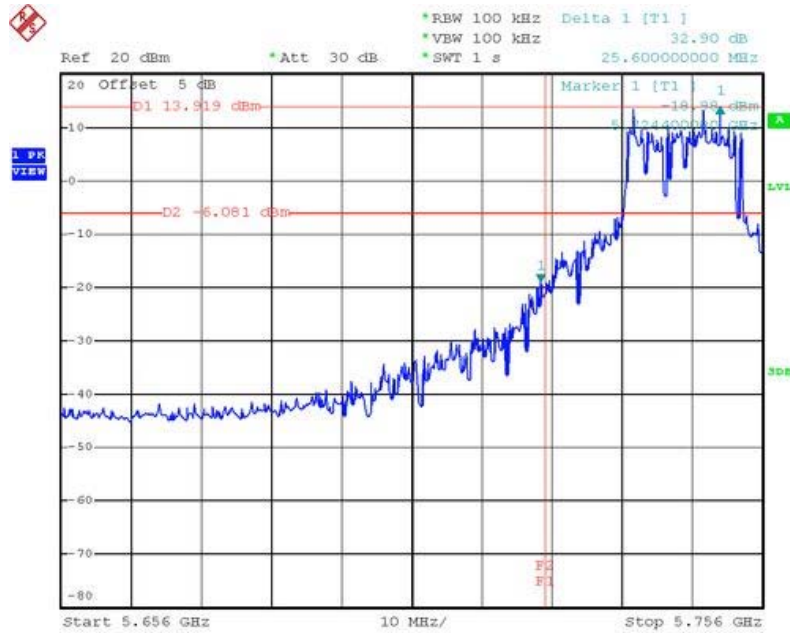

Date: 25.FEB.2011 13:02:55

High Band Edge Plot on Configuration IEEE 802.11a Ant. 1 + Ant. 2 / 5825 MHz

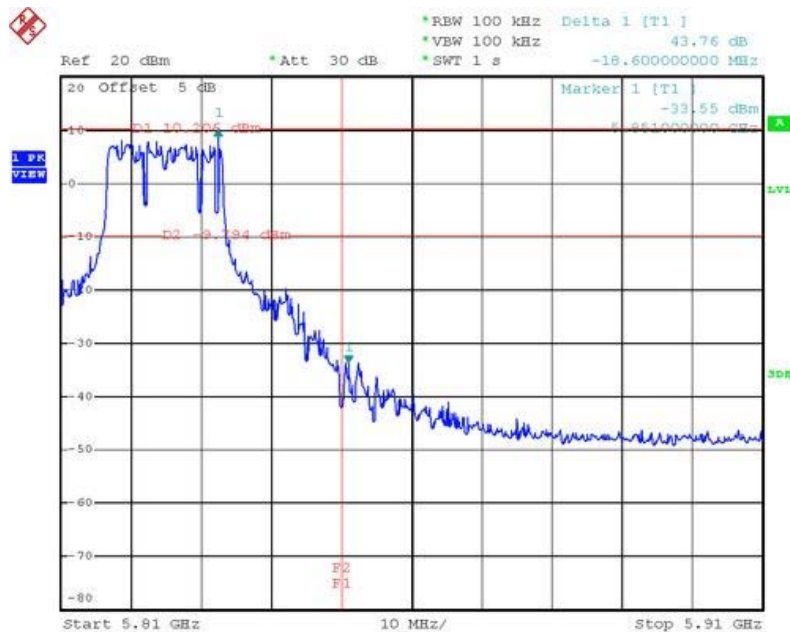

Date: 25.FEB.2011 13:07:31

4.8. Antenna Requirements

4.8.1. Limit

Except for special regulations, the Low-power Radio-frequency Devices must not be equipped with any jacket for installing an antenna with extension cable. An intentional radiator shall be designed to ensure that no antenna other than that furnished by the responsible party shall be used with the device. The use of a permanently attached antenna or of an antenna that uses a unique coupling to the intentional radiator shall be considered sufficient to comply with the provisions of this Section. The manufacturer may design the unit so that the user can replace a broken antenna, but the use of a standard antenna jack or electrical connector is prohibited. Further, this requirement does not apply to intentional radiators that must be professionally installed.

4.8.2. Antenna Connector Construction

Please refer to section 3.3 in this test report; antenna connector complied with the requirements.

5. LIST OF MEASURING EQUIPMENTS

Instrument	Manufacturer	Model No.	Serial No.	Characteristics	Calibration Date	Remark
EMI Test Receiver	R&S	ESCS 30	100377	9kHz ~ 2.75GHz	Sep. 01, 2010	Conduction (CO01-CB)
LISN	F.C.C.	FCC-LISN-50-16-2	04083	150kHz ~ 100MHz	Oct. 28, 2010	Conduction (CO01-CB)
V- LISN	Schwarzbeck	NSLK 8127	8127-478	9K ~ 30MHz	Nov. 16, 2010	Conduction (CO01-CB)
PULSE LIMITER	R&S	ESH3-Z2	100430	9K~30MHz	Jan. 04, 2011	Conduction (CO01-CB)
COND Cable	-	Cable	-	0.15MHz~30MHz	Dec. 04, 2010	Conduction (CO01-CB)
BILOG ANTENNA	Schaffner	CBL6112D	22021	20MHz ~ 2GHz	Oct. 17, 2010	Radiation (03CH01-CB)
Horn Antenna	EMCO	3115	00075790	750MHz~18GHz	Nov. 13, 2010	Radiation (03CH01-CB)
Horn Antenna	SCHWARZBEAK	BBHA 9170	BBHA9170252	15GHz ~ 40GHz	Oct. 08, 2010	Radiation (03CH01-CB)
Pre-Amplifier	Agilent	8447D	2944A10991	0.1MHz ~ 1.3GHz	Nov. 17, 2010	Radiation (03CH01-CB)
Pre-Amplifier	Agilent	8449B	3008A02310	1GHz ~ 26.5GHz	Nov. 06, 2010	Radiation (03CH01-CB)
Pre-Amplifier	WM	TF-130N-R1	923365	26.5GHz ~ 40GHz	Nov. 17, 2010	Radiation (03CH01-CB)
Spectrum analyzer	R&S	FSP	100304	9kHz ~ 40GHz	Nov. 06, 2010	Radiation (03CH01-CB)
EMI Test Receiver	R&S	ESCS 30	100355	9KHz ~ 2.75GHz	Mar. 06, 2010	Radiation (03CH01-CB)
Loop Antenna	R&S	HFH2-Z2	860004/001	9 kHz - 30 MHz	Sep. 09, 2010*	Radiation (03CH01-CB)
Turn Table	INN CO	CO 2000	N/A	0 ~ 360 degree	N/A	Radiation (03CH01-CB)
Antenna Mast	INN CO	CO2000	N/A	1 m - 4 m	N/A	Radiation (03CH01-CB)
RF Cable-low	Woken	Low Cable-1	-	30 MHz - 1 GHz	Nov. 17, 2010	Radiation (03CH01-CB)
RF Cable-high	Woken	High Cable-1	-	1 GHz – 26.5 GHz	Nov. 17, 2010	Radiation (03CH01-CB)
RF Cable-high	Woken	High Cable-2	-	1 GHz – 26.5 GHz	Nov. 17, 2010	Radiation (03CH01-CB)
RF Cable-high	Woken	High Cable-3	-	1 GHz - 40 GHz	Nov. 17, 2010	Radiation (03CH01-CB)
RF Cable-high	Woken	High Cable-4	-	1 GHz - 40 GHz	Nov. 17, 2010	Radiation (03CH01-CB)
Spectrum analyzer	R&S	FSV	100023	9KHz~30GHz	Mar. 05, 2010	Conducted (TH01-CB)
RF Power Divider	HP	11636A	00306	2GHz ~ 18GHz	N/A	Conducted (TH01-CB)
RF Power Splitter	Anaren	44100	1839	2GHz ~ 18GHz	N/A	Conducted (TH01-CB)
RF Cable-high	Woken	High Cable-7	-	1 GHz – 26.5 GHz	Nov. 17, 2010	Conducted (TH01-CB)
RF Cable-high	Woken	High Cable-8	-	1 GHz – 26.5 GHz	Nov. 17, 2010	Conducted (TH01-CB)



Instrument	Manufacturer	Model No.	Serial No.	Characteristics	Calibration Date	Remark
RF Cable-high	Woken	High Cable-9	-	1 GHz – 26.5 GHz	Nov. 17, 2010	Conducted (TH01-CB)
RF Cable-high	Woken	High Cable-10	-	1 GHz – 26.5 GHz	Nov. 17, 2010	Conducted (TH01-CB)
RF Cable-high	Woken	High Cable-11	-	1 GHz – 26.5 GHz	Nov. 17, 2010	Conducted (TH01-CB)
RF Cable-high	Woken	High Cable-12	-	1 GHz – 26.5 GHz	Nov. 17, 2010	Conducted (TH01-CB)
RF Cable-high	Woken	High Cable-13	-	1 GHz – 26.5 GHz	Nov. 17, 2010	Conducted (TH01-CB)
Power Sensor	Anritsu	MA2411B	0917223	300MHz~40GHz	Sep. 13, 2010	Conducted (TH01-CB)

Note: Calibration Interval of instruments listed above is one year.

Note: *Calibration Interval of instruments listed above is two year.

6. TEST LOCATION

SHIJR	ADD : 6Fl., No. 106, Sec. 1, Shintai 5th Rd., Shijr City, Taipei, Taiwan 221, R.O.C. TEL : 886-2-2696-2468 FAX : 886-2-2696-2255
HWA YA	ADD : No. 52, Hwa Ya 1st Rd., Kwei-Shan Hsiang, Tao Yuan Hsien, Taiwan, R.O.C. TEL : 886-3-327-3456 FAX : 886-3-318-0055
LINKOU	ADD : No. 30-2, Dingfu Tsuen, Linkou Shiang, Taipei, Taiwan 244, R.O.C TEL : 886-2-2601-1640 FAX : 886-2-2601-1695
DUNGHU	ADD : No. 3, Lane 238, Kangle St., Neihu Chiu, Taipei, Taiwan 114, R.O.C. TEL : 886-2-2631-4739 FAX : 886-2-2631-9740
JUNGHE	ADD : 7Fl., No. 758, Jungjeng Rd., Junghe City, Taipei, Taiwan 235, R.O.C. TEL : 886-2-8227-2020 FAX : 886-2-8227-2626
NEIHU	ADD : 4Fl., No. 339, Hsin Hu 2 nd Rd., Taipei 114, Taiwan, R.O.C. TEL : 886-2-2794-8886 FAX : 886-2-2794-9777
JHUBEI	ADD : No.8, Lane 724, Bo-ai St., Jhubei City, HsinChu County 302, Taiwan, R.O.C. TEL : 886-3-656-9065 FAX : 886-3-656-9085

7. TAF CERTIFICATE OF ACCREDITATION



Certificate No. : L1190-091230

財團法人全國認證基金會
Taiwan Accreditation Foundation

Certificate of Accreditation

This is to certify that

Sporton International Inc.
EMC & Wireless Communications Laboratory
No.52, Hwa Ya 1st Rd., Hwa Ya Technology Park, Kwei-Shan Hsiang, Tao Yuan Hsien,
Taiwan, R.O.C.

is accredited in respect of laboratory

Accreditation Criteria	: ISO/IEC 17025:2005
Accreditation Number	: 1190
Originally Accredited	: December 15, 2003
Effective Period	: January 10, 2010 to January 09, 2013
Accredited Scope	: Testing Field, see described in the Appendix
Specific Accreditation Program	: Accreditation Program for Designated Testing Laboratory for Commodities Inspection Accreditation Program for Telecommunication Equipment Testing Laboratory Accreditation Program for BSMI Mutual Recognition Arrangement with Foreign Authorities

Jay-san Chen

Jay-San Chen
President, Taiwan Accreditation Foundation
Date : December 30, 2009

Pl, total 22 pages

The Appendix forms an integral part of this Certificate, which shall be invalid when use without the Appendix