



SPORTON International Inc.

No. 52, Hwa Ya 1st Rd., Kwei-Shan Hsiang, TaoYuan Hsien, Taiwan, R.O.C.
Ph: 886-3-327-3456 / FAX: 886-3-327-0973 / www.sporton.com.tw

FCC RADIO TEST REPORT

Applicant's company	Arada Systems, Inc.
Applicant Address	4633 Old Ironsides Drive, Suites 415 Santa Clara, CA 95054
FCC ID	XZB-MAXR900-2
Manufacturer's company	Arada Systems, Inc.
Manufacturer Address	4633 Old Ironsides Drive, Suites 415 Santa Clara, CA 95054

Product Name	900MHz WLAN mini-PCI card
Brand Name	Arada
Model Name	MaxR-900
Test Rule	47 CFR FCC Part 15 Subpart C § 15.247
Test Freq. Range	907 ~ 922MHz
Received Date	Mar. 30, 2011
Final Test Date	Jul. 06, 2011
Submission Type	Original Equipment



Statement

Test result included is only for the 802.DSSS/g part of the product.

The test result in this report refers exclusively to the presented test model / sample.

Without written approval of SPORTON International Inc., the test report shall not be reproduced except in full.

The measurements and test results shown in this test report were made in accordance with the procedures and found in compliance with the limit given in **ANSI C63.4-2003** and **47 CFR FCC Part 15 Subpart C**.

The test equipment used to perform the test is calibrated and traceable to NML/ROC.



Table of Contents

1. CERTIFICATE OF COMPLIANCE	1
2. SUMMARY OF THE TEST RESULT	2
3. GENERAL INFORMATION	3
3.1. Product Details.....	3
3.2. Accessories.....	3
3.3. Table for Filed Antenna.....	3
3.4. Table for Carrier Frequencies	3
3.5. Table for Test Modes	4
Table for Testing Locations	5
3.6. Table for Supporting Units	5
3.7. Table for Parameters of Test Software Setting	5
3.8. Test Configurations	7
4. TEST RESULT	9
4.1. AC Power Line Conducted Emissions Measurement.....	9
4.2. Maximum Peak Output Power Measurement	15
4.3. Power Spectral Density Measurement	22
4.4. 6dB Spectrum Bandwidth Measurement	33
4.5. Radiated Emissions Measurement	44
4.6. Band Edge Emissions Measurement	92
4.7. Antenna Requirements	117
5. LIST OF MEASURING EQUIPMENTS	118
6. TEST LOCATION.....	120
7. TAF CERTIFICATE OF ACCREDITATION	121
APPENDIX A. TEST PHOTOS	A1 ~ A8
APPENDIX B. MAXIMUM PERMISSIBLE EXPOSURE	B1 ~ B5



History of This Test Report

REPORT NO.	VERSION	DESCRIPTION	ISSUED DATE
FROD2437-01	Rev. 01	Initial issue of report	Jul. 08, 2011



1. CERTIFICATE OF COMPLIANCE

Product Name : 900MHz WLAN mini-PCI card
Brand Name : Arada
Model Name : MaxR-900
Applicant : Arada Systems, Inc.
Test Rule Part(s) : 47 CFR FCC Part 15 Subpart C § 15.247

Sporton International as requested by the applicant to evaluate the EMC performance of the product sample received on Mar. 30, 2011 would like to declare that the tested sample has been evaluated and found to be in compliance with the tested rule parts. The data recorded as well as the test configuration specified is true and accurate for showing the sample's EMC nature.

Jordan Hsiao 2011.7.8

Reviewed By:

Jordan Hsiao

SPORTON INTERNATIONAL INC.

2. SUMMARY OF THE TEST RESULT

Applied Standard: 47 CFR FCC Part 15 Subpart C				
Part	Rule Section	Description of Test	Result	Under Limit
4.1	15.207	AC Power Line Conducted Emissions	Complies	14.02 dB
4.2	15.247(b)(3)	Maximum Peak Conducted Output Power	Complies	0.01 dB
4.3	15.247(e)	Power Spectral Density	Complies	0.02 dB
4.4	15.247(a)(2)	6dB Spectrum Bandwidth	Complies	-
4.5	15.247(d)	Radiated Emissions	Complies	0.14 dB
4.6	15.247(d)	Band Edge Emissions	Complies	-
4.7	15.203	Antenna Requirements	Complies	-

Test Items	Uncertainty	Remark
AC Power Line Conducted Emissions	±2.3dB	Confidence levels of 95%
Maximum Peak Conducted Output Power	±0.8dB	Confidence levels of 95%
Power Spectral Density	±0.5dB	Confidence levels of 95%
6dB Spectrum Bandwidth	±8.5×10 ⁻⁸	Confidence levels of 95%
Radiated Emissions (9kHz~30MHz)	±0.8dB	Confidence levels of 95%
Radiated Emissions (30MHz~1000MHz)	±1.9dB	Confidence levels of 95%
Radiated / Band Edge Emissions (1GHz~18GHz)	±1.9dB	Confidence levels of 95%
Radiated Emissions (18GHz~40GHz)	±1.9dB	Confidence levels of 95%
Temperature	±0.7°C	Confidence levels of 95%
Humidity	±3.2%	Confidence levels of 95%
DC / AC Power Source	±1.4%	Confidence levels of 95%

3. GENERAL INFORMATION

3.1. Product Details

EUT is a WLAN mini-PCI card. The radio detail is shown in the table below. For more detailed features description, please refer to the manufacturer's specifications or user's manual.

Items	Description
Power Type	From Host
Modulation	DSSS ; OFDM
Data Modulation	DSSS (BPSK / QPSK / CCK) ; OFDM (BPSK / QPSK / 16QAM / 64QAM)
Data Rate (Mbps)	DSSS (1/ 2/ 5.5/11) ; OFDM (6/9/12/18/24/36/48/54)
Frequency Range	907 ~ 922MHz
Channel Number	DSSS: 2 ; OFDM: 4
Channel Band Width (99%)	DSSS: 15.48 MHz ; OFDM: 16.52 MHz
Conducted Output Power	DSSS: 27.96 dBm ; OFDM: 27.98 dBm
Carrier Frequencies	Please refer to section 3.4
Antenna	Please refer to section 3.3

3.2. Accessories

N/A

3.3. Table for Filed Antenna

Ant.	Brand	Model Name	Antenna Type	Connector	Gain (dBi)
1	MARS	MA-WO91-8X	OMNI DIRECTIONAL Antenna	N type female	8
2	L-COM	HG914Y	Yagi Antenna	N type female	14

3.4. Table for Carrier Frequencies

Frequency Band	Channel No.	Frequency	Channel No.	Frequency
907 ~ 922MHz (OFDM)	1	907 MHz	3	917 MHz
	2	912 MHz	4	922 MHz
907 ~ 922MHz (DSSS)	2	912 MHz	3	917 MHz

3.5. Table for Test Modes

Preliminary tests were performed in different data rate to find the worst radiated emission. The data rate shown in the table below is the worst-case rate with respect to the specific test item. Investigation has been done on all the possible configurations for searching the worst cases. The following table is a list of the test modes shown in this test report.

Test Items	Mode		Data Rate	Channel	Antenna
AC Power Line Conducted Emissions	Normal Link		-	1/2/3/4	1/2
Maximum Peak Conducted Output Power Power Spectral Density 6dB Spectrum Bandwidth	5M	DSSS	2.75 Mbps	1/2/3/4	1/2
		OFDM	1.5 Mbps	1/2/3/4	1/2
	10M	DSSS	5.5 Mbps	1/2/3/4	1/2
		OFDM	3 Mbps	1/2/3/4	1/2
	20M	DSSS	11 Mbps	2/3	1/2
		OFDM	6 Mbps	2/3	1/2
Radiated Emissions 9kHz~1GHz	5M	OFDM	1.5 Mbps	1/2/3/4	1/2
	10M	OFDM	3 Mbps	1/2/3/4	1/2
	20M	OFDM	6 Mbps	2/3	1/2
Radiated Emissions 1GHz~10 th Harmonic	5M	DSSS	2.75 Mbps	1/2/3/4	1/2
		OFDM	1.5 Mbps	1/2/3/4	1/2
	10M	DSSS	5.5 Mbps	1/2/3/4	1/2
		OFDM	3 Mbps	1/2/3/4	1/2
	20M	DSSS	11 Mbps	2/3	1/2
		OFDM	6 Mbps	2/3	1/2
Band Edge Emissions	5M	DSSS	2.75 Mbps	1/2/3/4	1/2
		OFDM	1.5 Mbps	1/2/3/4	1/2
	10M	DSSS	5.5 Mbps	1/2/3/4	1/2
		OFDM	3 Mbps	1/2/3/4	1/2
	20M	DSSS	11 Mbps	2/3	1/2
		OFDM	6 Mbps	2/3	1/2

The following test modes were performed for all tests:

Mode 1: EUT with Ant. 1.

Mode 2: EUT with Ant. 2.

Both the two modes were recorded in the report.

Table for Testing Locations

Test Site No.	Site Category	Location	FCC Reg. No.	IC File No.	VCCI Reg. No
03CH01-CB	SAC	Hsin Chu	187376	IC 4086D	-
CO01-CB	Conduction	Hsin Chu	187376	IC 4086D	-
TH01-CB	OVEN Room	Hsin Chu	-	-	-

Open Area Test Site (OATS); Semi Anechoic Chamber (SAC); Fully Anechoic Chamber (FAC).

Please refer section 6 for Test Site Address.

3.6. Table for Supporting Units

Support Unit	Brand	Model	FCC ID
Notebook	DELL	D400	QDS-BRCM1005-D

3.7. Table for Parameters of Test Software Setting

During testing, Channel & Power Controlling Software provided by the customer was used to control the operating channel as well as the output power level. The RF output power selection is for the setting of RF output power expected by the customer and is going to be fixed on the firmware of the final end product.

Power Parameters

<Mode 1 >

5MHz

Test Software Version	ART			
Frequency	907 MHz	912 MHz	917MHz	922MHz
DSSS Mode	16	16	16	16
Frequency	907 MHz	912 MHz	917MHz	922MHz
OFDM Mode	11	11.5	11.5	11.5

10MHz

Test Software Version	ART			
Frequency	907 MHz	912 MHz	917MHz	922MHz
DSSS Mode	16.5	17	16.5	16.5
Frequency	907 MHz	912 MHz	917MHz	922MHz
OFDM Mode	10.5	10.5	11	11

20MHz

Test Software Version	ART	
Frequency	907 MHz	912 MHz
DSSS Mode	17.5	17
Frequency	907 MHz	912 MHz
OFDM Mode	10.5	11

<Mode 2>
5MHz

Test Software Version	ART			
Frequency	907 MHz	912 MHz	917MHz	922MHz
DSSS Mode	10	10	10.5	10.5
Frequency	907 MHz	912 MHz	917MHz	922MHz
OFDM Mode	4.5	5	6.5	6.5

10MHz

Test Software Version	ART			
Frequency	907 MHz	912 MHz	917MHz	922MHz
DSSS Mode	11	10.5	11	11.5
Frequency	907 MHz	912 MHz	917MHz	922MHz
OFDM Mode	4.5	4.5	6.5	6.5

20MHz

Test Software Version	ART	
Frequency	907 MHz	912 MHz
DSSS Mode	11	11.5
Frequency	907 MHz	912 MHz
OFDM Mode	5	6.5

3.8. Test Configurations

3.8.1. Radiation Emissions Test Configuration

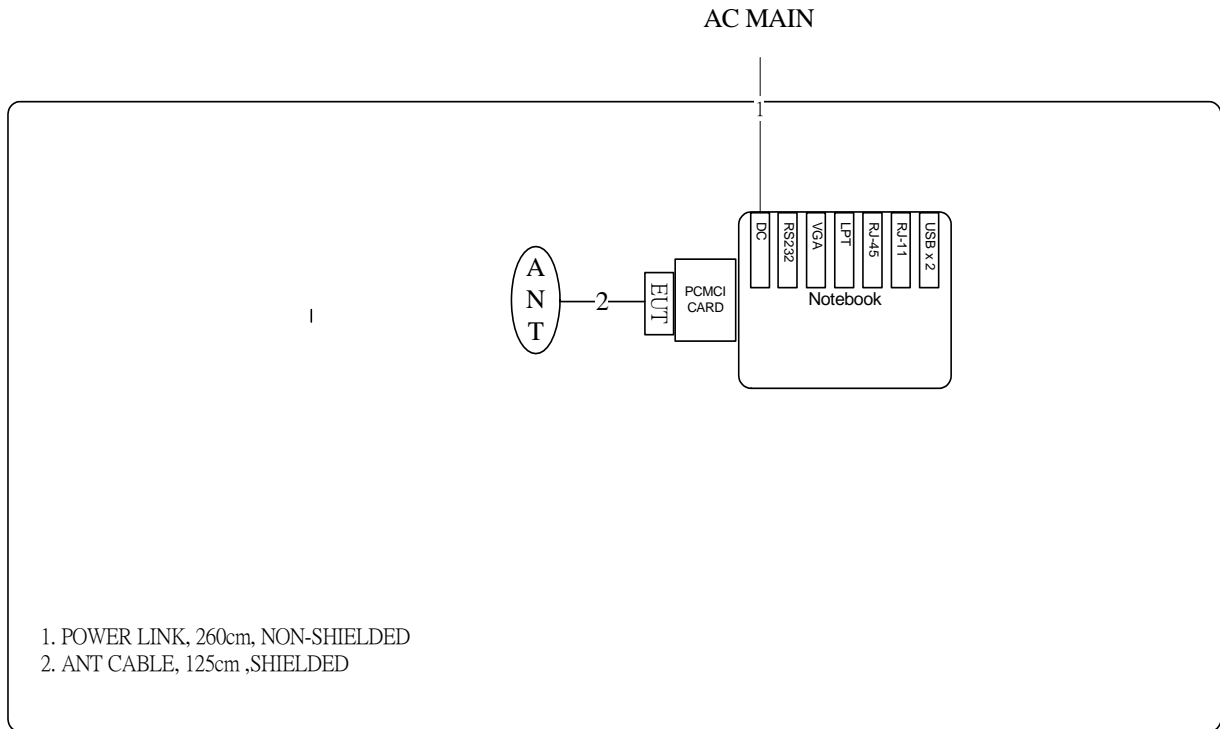

AC Power Line Conduction Emissions Test Configuration

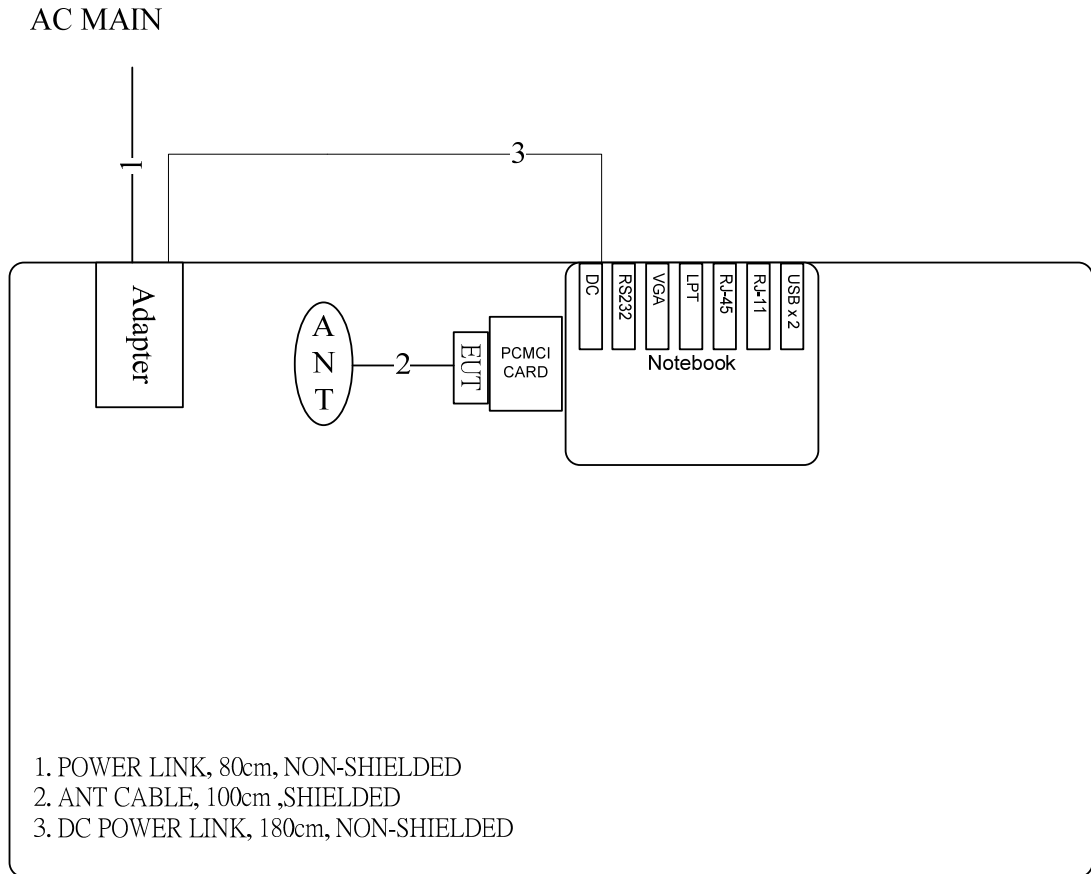

4. TEST RESULT

4.1. AC Power Line Conducted Emissions Measurement

4.1.1. Limit

For this product which is designed to be connected to the AC power line, the radio frequency voltage that is conducted back onto the AC power line on any frequency or frequencies within the band 150 kHz to 30 MHz shall not exceed below limits table.

Frequency (MHz)	QP Limit (dBuV)	AV Limit (dBuV)
0.15~0.5	66~56	56~46
0.5~5	56	46
5~30	60	50

4.1.2. Measuring Instruments and Setting

Please refer to section 5 of equipments list in this report. The following table is the setting of the receiver.

Receiver Parameters	Setting
Attenuation	10 dB
Start Frequency	0.15 MHz
Stop Frequency	30 MHz
IF Bandwidth	9 KHz

4.1.3. Test Procedures

1. Configure the EUT according to ANSI C63.4. The EUT or host of EUT has to be placed 0.4 meter far from the conducting wall of the shielding room and at least 80 centimeters from any other grounded conducting surface.
2. Connect EUT or host of EUT to the power mains through a line impedance stabilization network (LISN).
3. All the support units are connected to the other LISNs. The LISN should provide 50uH/50ohms coupling impedance.
4. The frequency range from 150 KHz to 30 MHz was searched.
5. Set the test-receiver system to Peak Detect Function and Specified Bandwidth with Maximum Hold Mode.
6. The measurement has to be done between each power line and ground at the power terminal.

4.1.4. Test Setup Layout

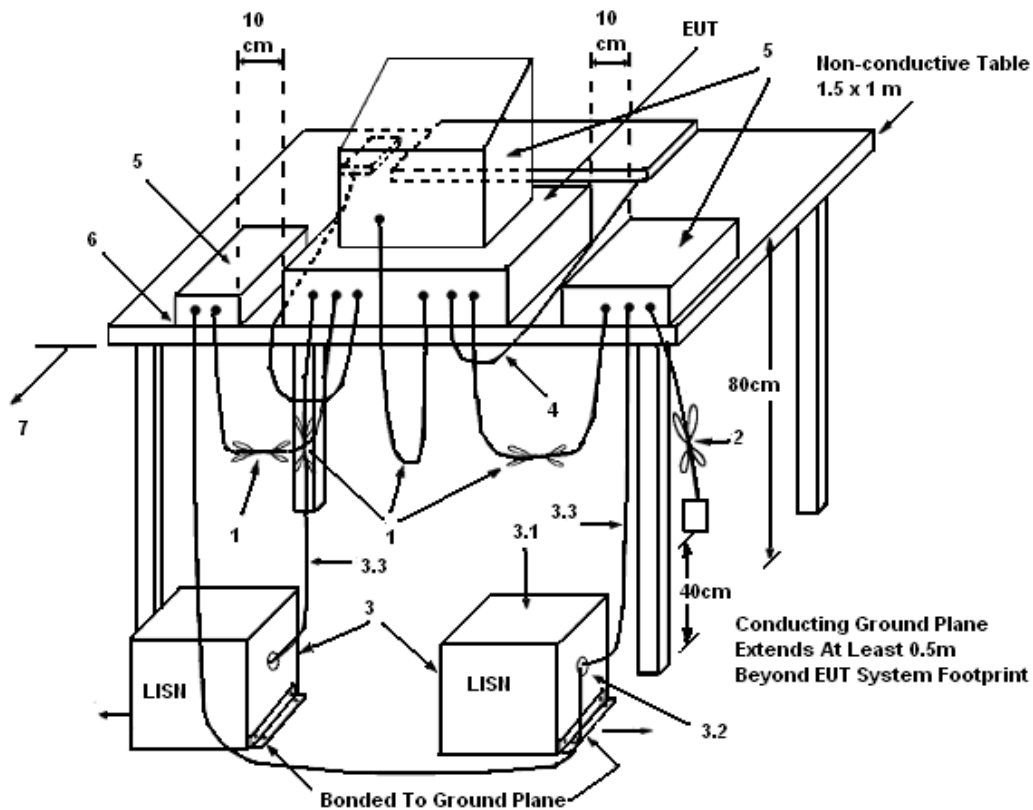

LEGEND:

- (1) Interconnecting cables that hang closer than 40 cm to the ground plane shall be folded back and forth in the center forming a bundle 30 to 40 cm long.
- (2) I/O cables that are not connected to a peripheral shall be bundled in the center. The end of the cable may be terminated, if required, using the correct terminating impedance. The overall length shall not exceed 1 m.
- (3) EUT connected to one LISN. Unused LISN measuring port connectors shall be terminated in 50 Ω . LISN can be placed on top of, or immediately beneath, reference ground plane.
 - (3.1) All other equipment powered from additional LISN(s).
 - (3.2) Multiple outlet strip can be used for multiple power cords of non-EUT equipment.
 - (3.3) LISN at least 80 cm from nearest part of EUT chassis.
- (4) Cables of hand-operated devices, such as keyboards, mice, etc., shall be placed as for normal use.
- (5) Non-EUT components of EUT system being tested.
- (6) Rear of EUT, including peripherals, shall all be aligned and flush with rear of tabletop.
- (7) Rear of tabletop shall be 40 cm removed from a vertical conducting plane that is bonded to the ground plane.

4.1.5. Test Deviation

There is no deviation with the original standard.

4.1.6. EUT Operation during Test

The EUT was placed on the test table and programmed in normal function.

4.1.7. Results of AC Power Line Conducted Emissions Measurement

Temperature	24°C	Humidity	66%
Test Engineer	Roy Gu	Phase	Line
Configuration	Normal Link OFDM /Mode 1		

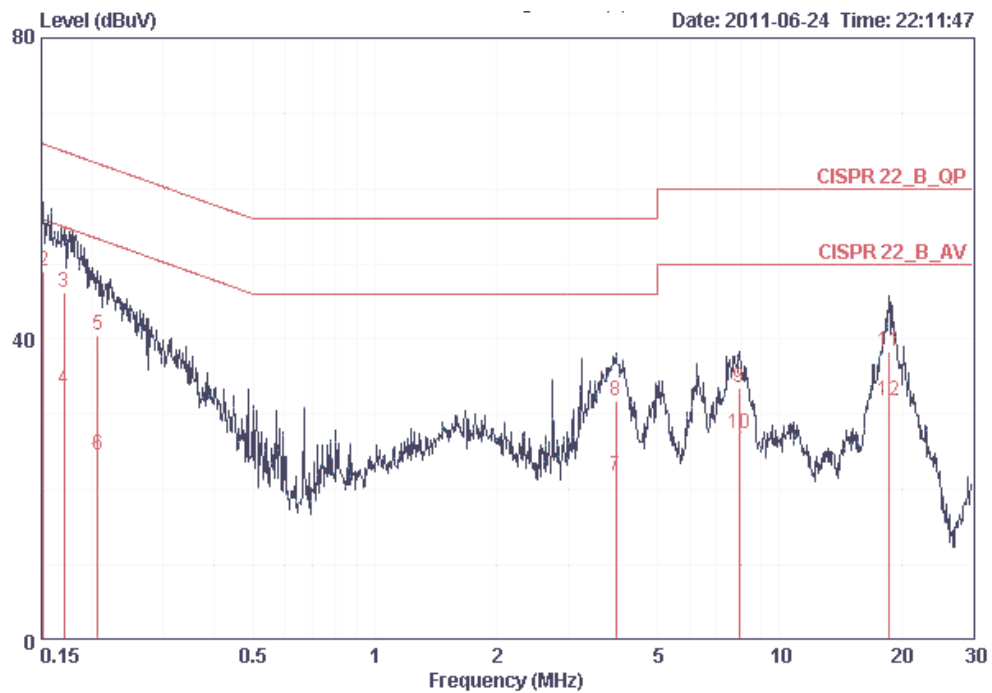

	Freq	Level	Over Limit	Limit Line	Read Level	LISN Factor	Cable Loss	Remark
	MHz	dBuV	dB	dBuV	dBuV	dB	dB	
1	0.15160	32.61	-23.30	55.91	32.34	0.07	0.20	AVERAGE
2	0.15160	48.95	-16.96	65.91	48.68	0.07	0.20	QP
3	0.17034	46.22	-18.72	64.94	45.96	0.06	0.20	QP
4	0.17034	33.40	-21.54	54.94	33.14	0.06	0.20	AVERAGE
5	0.20614	40.63	-22.73	63.36	40.38	0.05	0.20	QP
6	0.20614	24.67	-28.69	53.36	24.42	0.05	0.20	AVERAGE
7	3.943	21.85	-24.15	46.00	21.45	0.10	0.30	AVERAGE
8	3.943	31.87	-24.13	56.00	31.47	0.10	0.30	QP
9	7.935	33.53	-26.47	60.00	32.84	0.29	0.40	QP
10	7.935	27.40	-22.60	50.00	26.71	0.29	0.40	AVERAGE
11	18.622	38.37	-21.63	60.00	37.12	0.75	0.50	QP
12	18.622	31.74	-18.26	50.00	30.49	0.75	0.50	AVERAGE

Temperature	24°C	Humidity	66%
Test Engineer	Sky Wu	Phase	Neutral
Configuration	Normal Link OFDM /Mode 1		

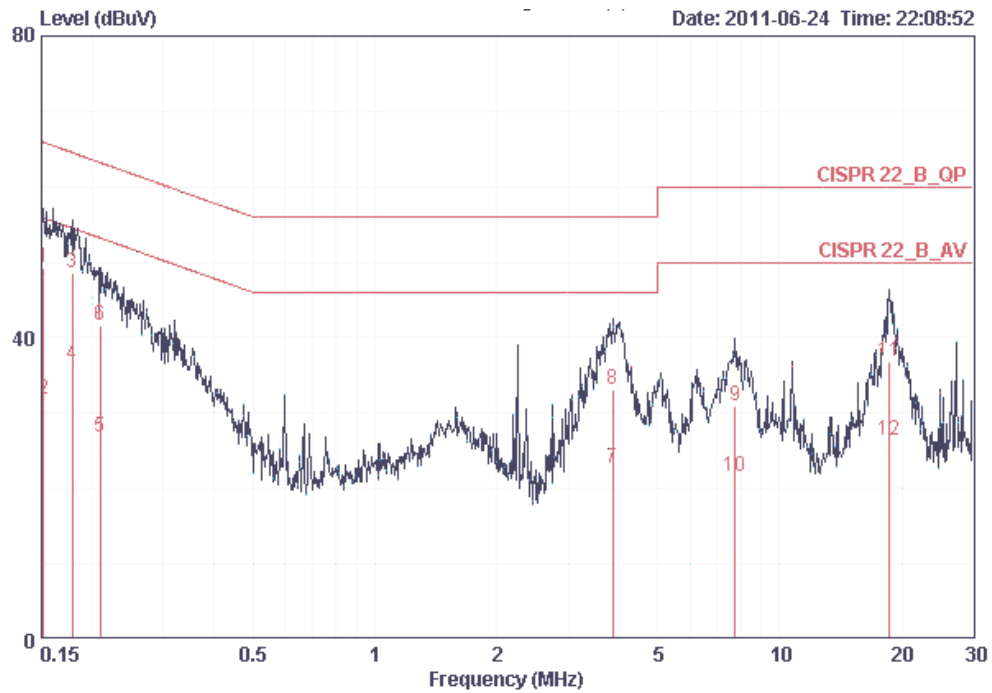

	Freq	Level	Over	Limit	Read	LISN	Cable	Remark
	MHz	dBuV	Limit	Line	Level	Factor	Loss	
			dB	dBuV	dBuV	dB	dB	
1	0.15160	49.24	-16.67	65.91	48.94	0.10	0.20	QP
2	0.15160	31.75	-24.16	55.91	31.45	0.10	0.20	AVERAGE
3	0.17866	48.51	-16.04	64.55	48.22	0.09	0.20	QP
4	0.17866	36.38	-18.17	54.55	36.09	0.09	0.20	AVERAGE
5	0.20944	26.89	-26.34	53.23	26.61	0.08	0.20	AVERAGE
6	0.20944	41.59	-21.64	63.23	41.31	0.08	0.20	QP
7	3.860	22.58	-23.42	46.00	22.14	0.14	0.30	AVERAGE
8	3.860	33.11	-22.89	56.00	32.67	0.14	0.30	QP
9	7.769	30.92	-29.08	60.00	30.20	0.32	0.40	QP
10	7.769	21.67	-28.33	50.00	20.95	0.32	0.40	AVERAGE
11	18.622	36.94	-23.06	60.00	35.70	0.74	0.50	QP
12	18.622	26.41	-23.59	50.00	25.17	0.74	0.50	AVERAGE

Note:

Level = Read Level + LISN Factor + Cable Loss.

Temperature	24°C	Humidity	66%
Test Engineer	Roy Gu	Phase	Line
Configuration	Normal Link OFDM / Mode 2		

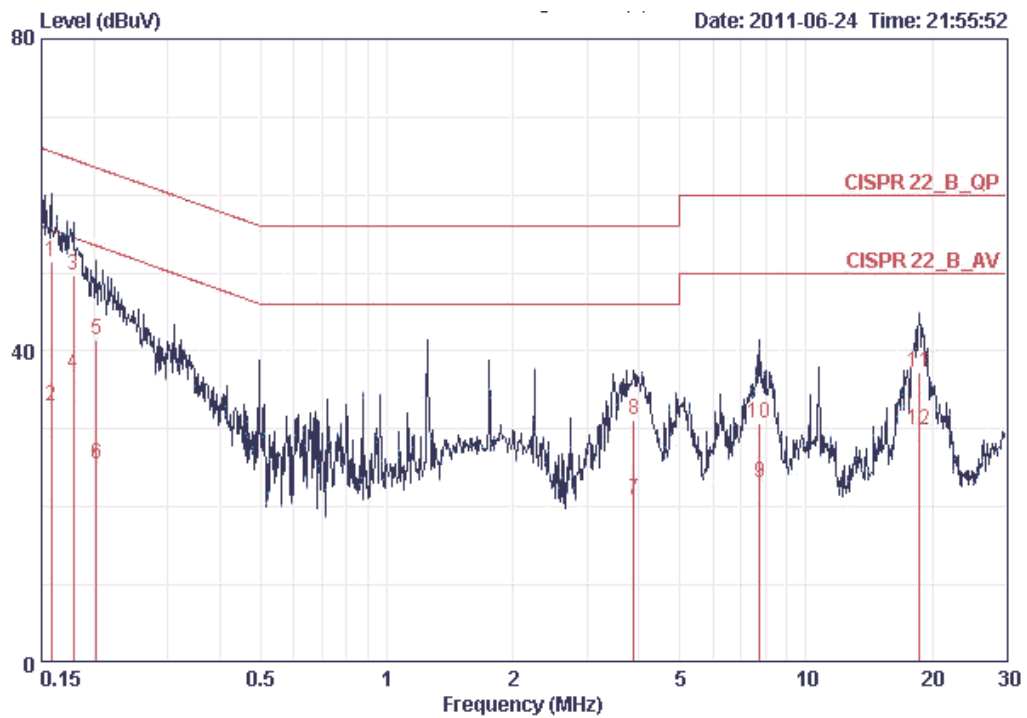

	Freq	Level	Over Limit	Limit Line	Read Level	LISN Factor	Cable Loss	Remark
	MHz	dBuV	dB	dBuV	dBuV	dB	dB	
1	0.15816	51.54	-14.02	65.56	51.27	0.07	0.20	QP
2	0.15816	32.88	-22.68	55.56	32.61	0.07	0.20	AVERAGE
3	0.17866	49.61	-14.94	64.55	49.35	0.06	0.20	QP
4	0.17866	37.13	-17.42	54.55	36.87	0.06	0.20	AVERAGE
5	0.20289	41.46	-22.03	63.49	41.21	0.05	0.20	QP
6	0.20289	25.61	-27.88	53.49	25.36	0.05	0.20	AVERAGE
7	3.881	21.03	-24.97	46.00	20.63	0.10	0.30	AVERAGE
8	3.881	31.26	-24.74	56.00	30.86	0.10	0.30	QP
9	7.769	23.08	-26.92	50.00	22.40	0.28	0.40	AVERAGE
10	7.769	30.74	-29.26	60.00	30.06	0.28	0.40	QP
11	18.622	37.31	-22.69	60.00	36.06	0.75	0.50	QP
12	18.622	29.94	-20.06	50.00	28.69	0.75	0.50	AVERAGE

Temperature	24°C	Humidity	66%
Test Engineer	Sky Wu	Phase	Neutral
Configuration	Normal Link OFDM / Mode 2		

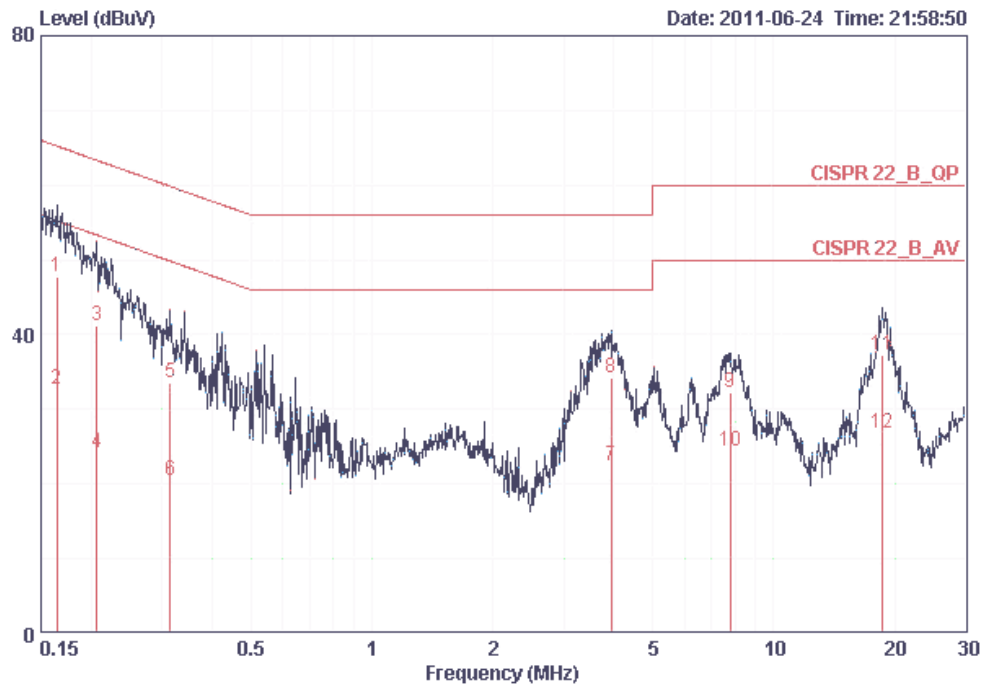

	Freq	Level	Over Limit	Limit Line	Read Level	LISN Factor	Cable Loss	Remark
	MHz	dBuV	dB	dBuV	dBuV	dB	dB	
1	0.16414	47.83	-17.42	65.25	47.53	0.10	0.20	QP
2	0.16414	32.63	-22.62	55.25	32.33	0.10	0.20	AVERAGE
3	0.20614	41.19	-22.17	63.36	40.91	0.08	0.20	QP
4	0.20614	24.11	-29.25	53.36	23.83	0.08	0.20	AVERAGE
5	0.31495	33.58	-26.26	59.84	33.31	0.07	0.20	QP
6	0.31495	20.51	-29.33	49.84	20.24	0.07	0.20	AVERAGE
7	3.943	22.52	-23.48	46.00	22.08	0.14	0.30	AVERAGE
8	3.943	34.15	-21.85	56.00	33.71	0.14	0.30	QP
9	7.810	32.27	-27.73	60.00	31.55	0.32	0.40	QP
10	7.810	24.40	-25.60	50.00	23.68	0.32	0.40	AVERAGE
11	18.622	37.38	-22.62	60.00	36.14	0.74	0.50	QP
12	18.622	26.85	-23.15	50.00	25.61	0.74	0.50	AVERAGE

Note:

Level = Read Level + LISN Factor + Cable Loss.

4.2. Maximum Peak Output Power Measurement

4.2.1. Limit

For systems using digital modulation in the 902-928MHz, the limit for peak output power is 30dBm. The limited has to be reduced by the amount in dB that the gain of the antenna exceed 6dBi. In case of point-to-point operation, the limit has to be reduced by 1dB for every 3dB that the directional gain of the antenna exceeds 6dBi.

4.2.2. Measuring Instruments and Setting

Please refer to section 5 of equipments list in this report. The following table is the setting of the power meter.

Power Meter Parameter	Setting
Filter No.	Auto
Measurement time	0.135 s ~ 26 s
Used Peak Sensor	MA2411B

4.2.3. Test Procedures

1. The transmitter output (antenna port) was connected to the power meter.
2. Turn on the EUT and power meter and then record the peak power value.
3. Repeat above procedures on all channels needed to be tested.

4.2.4. Test Setup Layout

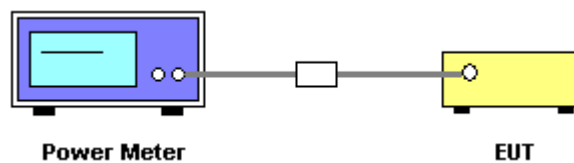

4.2.5. Test Deviation

There is no deviation with the original standard.

4.2.6. EUT Operation during Test

The EUT was programmed to be in continuously transmitting mode.

4.2.7. Test Result of Maximum Peak Output Power

Temperature	24°C	Humidity	66%
Test Engineer	Sam Chen	Configurations	5M/10M/20M
Test Date	Jun. 23, 2011	Test Mode	Mode 1

Configuration DSSS-5M

Channel	Frequency	Conducted Power (dBm)	Max. Limit (dBm)	Result
1	907 MHz	27.23	28.00	Complies
2	912 MHz	27.11	28.00	Complies
3	917 MHz	27.25	28.00	Complies
4	922 MHz	27.29	28.00	Complies

Channel	Frequency	AV Power (dBm)
1	907 MHz	25.07
2	912 MHz	25.01
3	917 MHz	25.10
4	922 MHz	25.15

Note: The AV power is only for MPE Calculation.

Configuration OFDM-5M

Channel	Frequency	Conducted Power (dBm)	Max. Limit (dBm)	Result
1	907 MHz	27.63	28.00	Complies
2	912 MHz	27.98	28.00	Complies
3	917 MHz	27.73	28.00	Complies
4	922 MHz	27.80	28.00	Complies

Channel	Frequency	AV Power (dBm)
1	907 MHz	19.84
2	912 MHz	20.51
3	917 MHz	20.12
4	922 MHz	20.13

Note: The AV power is only for MPE Calculation.

Configuration DSSS-10M

Channel	Frequency	Conducted Power (dBm)	Max. Limit (dBm)	Result
1	907 MHz	27.30	28.00	Complies
2	912 MHz	27.88	28.00	Complies
3	917 MHz	27.77	28.00	Complies
4	922 MHz	27.79	28.00	Complies

Channel	Frequency	AV Power (dBm)
1	907 MHz	25.12
2	912 MHz	25.68
3	917 MHz	25.59
4	922 MHz	25.87

Note: The AV power is only for MPE Calculation.

Configuration OFDM-10M

Channel	Frequency	Conducted Power (dBm)	Max. Limit (dBm)	Result
1	907 MHz	27.83	28.00	Complies
2	912 MHz	27.76	28.00	Complies
3	917 MHz	27.89	28.00	Complies
4	922 MHz	27.95	28.00	Complies

Channel	Frequency	AV Power (dBm)
1	907 MHz	19.50
2	912 MHz	19.61
3	917 MHz	19.73
4	922 MHz	19.72

Note: The AV power is only for MPE Calculation.

Configuration DSSS-20M

Channel	Frequency	Conducted Power (dBm)	Max. Limit (dBm)	Result
2	912 MHz	27.96	28.00	Complies
3	917 MHz	27.59	28.00	Complies

Channel	Frequency	AV Power (dBm)
2	912 MHz	25.78
3	917 MHz	25.25

Note: The AV power is only for MPE Calculation.

Configuration OFDM-20M

Channel	Frequency	Conducted Power (dBm)	Max. Limit (dBm)	Result
2	912 MHz	27.70	28.00	Complies
3	917 MHz	27.88	28.00	Complies

Channel	Frequency	AV Power (dBm)
2	912 MHz	19.59
3	917 MHz	19.87

Note: The AV power is only for MPE Calculation.

Temperature	24°C	Humidity	66%
Test Engineer	Sam Chen	Configurations	5M/10M/20M
Test Date	Jun. 23, 2011	Test Mode	Mode 2

Configuration DSSS-5M

Channel	Frequency	Conducted Power (dBm)	Max. Limit (dBm)	Result
1	907 MHz	21.31	22.00	Complies
2	912 MHz	21.48	22.00	Complies
3	917 MHz	21.35	22.00	Complies
4	922 MHz	21.30	22.00	Complies

Channel	Frequency	AV Power (dBm)
1	907 MHz	18.68
2	912 MHz	18.75
3	917 MHz	18.82
4	922 MHz	18.88

Note: The AV power is only for MPE Calculation.

Configuration OFDM-5M

Channel	Frequency	Conducted Power (dBm)	Max. Limit (dBm)	Result
1	907 MHz	21.87	22.00	Complies
2	912 MHz	21.98	22.00	Complies
3	917 MHz	21.89	22.00	Complies
4	922 MHz	21.99	22.00	Complies

Channel	Frequency	AV Power (dBm)
1	907 MHz	13.33
2	912 MHz	13.63
3	917 MHz	13.48
4	922 MHz	13.64

Note: The AV power is only for MPE Calculation.

Configuration DSSS-10M

Channel	Frequency	Conducted Power (dBm)	Max. Limit (dBm)	Result
1	907 MHz	21.78	22.00	Complies
2	912 MHz	21.78	22.00	Complies
3	917 MHz	21.77	22.00	Complies
4	922 MHz	21.88	22.00	Complies

Channel	Frequency	AV Power (dBm)
1	907 MHz	19.49
2	912 MHz	19.18
3	917 MHz	19.24
4	922 MHz	19.71

Note: The AV power is only for MPE Calculation.

Configuration OFDM-10M

Channel	Frequency	Conducted Power (dBm)	Max. Limit (dBm)	Result
1	907 MHz	21.93	22.00	Complies
2	912 MHz	21.89	22.00	Complies
3	917 MHz	21.95	22.00	Complies
4	922 MHz	21.99	22.00	Complies

Channel	Frequency	AV Power (dBm)
1	907 MHz	13.29
2	912 MHz	13.27
3	917 MHz	13.48
4	922 MHz	13.51

Note: The AV power is only for MPE Calculation.

Configuration DSSS-20M

Channel	Frequency	Conducted Power (dBm)	Max. Limit (dBm)	Result
2	912 MHz	21.76	22.00	Complies
3	917 MHz	21.97	22.00	Complies

Channel	Frequency	AV Power (dBm)
2	912 MHz	19.06
3	917 MHz	19.52

Note: The AV power is only for MPE Calculation.

Configuration OFDM-20M

Channel	Frequency	Conducted Power (dBm)	Max. Limit (dBm)	Result
2	912 MHz	21.99	22.00	Complies
3	917 MHz	21.92	22.00	Complies

Channel	Frequency	AV Power (dBm)
2	912 MHz	13.45
3	917 MHz	13.48

Note: The AV power is only for MPE Calculation.

4.3. Power Spectral Density Measurement

4.3.1. Limit

For digitally modulated systems, the power spectral density conducted from the intentional radiator to the antenna shall not be greater than 8 dBm in any 3 kHz band during any time interval of continuous transmission.

4.3.2. Measuring Instruments and Setting

Please refer to section 5 of equipments list in this report. The following table is the setting of the spectrum analyzer.

Spectrum Parameter	Setting
Attenuation	Auto
Span Frequency	30KHz
RB	3 kHz
VB	30 kHz
Detector	Peak
Trace	Max Hold
Sweep Time	10s

4.3.3. Test Procedures

1. The transmitter output (antenna port) was connected to the spectrum analyser.
2. Set RBW of spectrum analyzer to 3kHz and VBW to 30kHz. Set Detector to Peak, Trace to Max Hold.
3. Mark the frequency with maximum peak power as the center of the display of the spectrum.
4. Set the span to 30KHz and the sweep time to 10s and record the maximum peak value.

4.3.4. Test Setup Layout

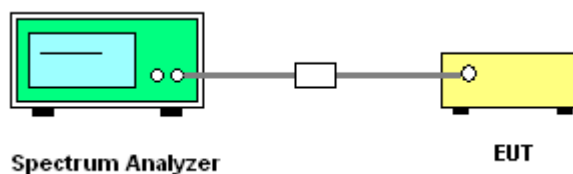

4.3.5. Test Deviation

There is no deviation with the original standard.

4.3.6. EUT Operation during Test

The EUT was programmed to be in continuously transmitting mode.

4.3.7. Test Result of Power Spectral Density

Temperature	24°C	Humidity	66%
Test Engineer	Sam Chen	Configurations	5M/10M/20M
Test Date	Jul. 06, 2011/ Jun. 23, 2011	Test Mode	Mode 1

Configuration DSSS-5M

Channel	Frequency	Power Density (dBm)	Max. Limit (dBm)	Result
1	907 MHz	5.69	6.00	Complies
2	912 MHz	5.11	6.00	Complies
3	917 MHz	5.93	6.00	Complies
4	922 MHz	5.41	6.00	Complies

Configuration OFDM-5M

Channel	Frequency	Power Density (dBm)	Max. Limit (dBm)	Result
1	907 MHz	1.51	6.00	Complies
2	912 MHz	2.91	6.00	Complies
3	917 MHz	1.84	6.00	Complies
4	922 MHz	1.91	6.00	Complies

Configuration DSSS-10M

Channel	Frequency	Power Density (dBm)	Max. Limit (dBm)	Result
1	907 MHz	5.17	6.00	Complies
2	912 MHz	5.76	6.00	Complies
3	917 MHz	4.73	6.00	Complies
4	922 MHz	4.39	6.00	Complies

Configuration OFDM-10M

Channel	Frequency	Power Density (dBm)	Max. Limit (dBm)	Result
1	907 MHz	-1.67	6.00	Complies
2	912 MHz	-0.53	6.00	Complies
3	917 MHz	-1.02	6.00	Complies
4	922 MHz	-0.44	6.00	Complies

Configuration DSSS-20M

Channel	Frequency	Power Density (dBm)	Max. Limit (dBm)	Result
2	912 MHz	4.02	6.00	Complies
3	917 MHz	2.49	6.00	Complies

Configuration OFDM-20M

Channel	Frequency	Power Density (dBm)	Max. Limit (dBm)	Result
2	912 MHz	-3.36	6.00	Complies
3	917 MHz	-5.47	6.00	Complies

Temperature	24°C	Humidity	66%
Test Engineer	Sam Chen	Configurations	5M/10M/20M
Test Date	Jun. 23, 2011	Test Mode	Mode 2

Configuration DSSS-5M

Channel	Frequency	Power Density (dBm)	Max. Limit (dBm)	Result
1	907 MHz	-0.94	0.00	Complies
2	912 MHz	-0.59	0.00	Complies
3	917 MHz	-0.91	0.00	Complies
4	922 MHz	-0.02	0.00	Complies

Configuration OFDM-5M

Channel	Frequency	Power Density (dBm)	Max. Limit (dBm)	Result
1	907 MHz	-4.57	0.00	Complies
2	912 MHz	-3.90	0.00	Complies
3	917 MHz	-5.47	0.00	Complies
4	922 MHz	-4.60	0.00	Complies

Configuration DSSS-10M

Channel	Frequency	Power Density (dBm)	Max. Limit (dBm)	Result
1	907 MHz	-1.76	0.00	Complies
2	912 MHz	-2.14	0.00	Complies
3	917 MHz	-1.23	0.00	Complies
4	922 MHz	-0.72	0.00	Complies

Configuration OFDM-10M

Channel	Frequency	Power Density (dBm)	Max. Limit (dBm)	Result
1	907 MHz	-7.34	0.00	Complies
2	912 MHz	-8.24	0.00	Complies
3	917 MHz	-8.63	0.00	Complies
4	922 MHz	-8.04	0.00	Complies

Configuration DSSS-20M

Channel	Frequency	Power Density (dBm)	Max. Limit (dBm)	Result
2	912 MHz	-1.36	0.00	Complies
3	917 MHz	-1.85	0.00	Complies

Configuration OFDM-20M

Channel	Frequency	Power Density (dBm)	Max. Limit (dBm)	Result
2	912 MHz	-10.07	0.00	Complies
3	917 MHz	-10.63	0.00	Complies

Power Density Plot on Configuration DSSS / 907 MHz/5M/ Mode 1

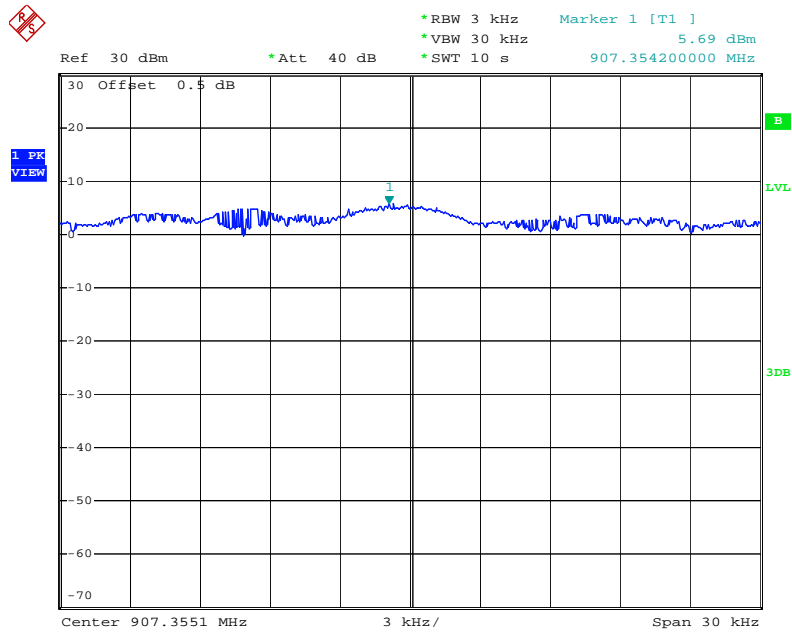

Date: 6.JUL.2011 11:45:02

Power Density Plot on Configuration DSSS / 917 MHz/5M / Mode 2

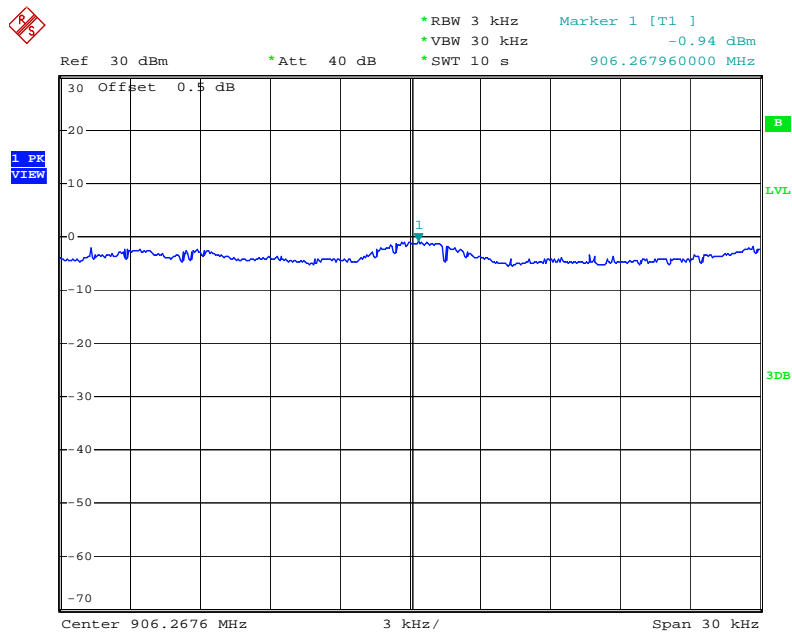

Date: 6.JUL.2011 11:56:20

Power Density Plot on Configuration DSSS / 907 MHz/ 10M / Mode 1

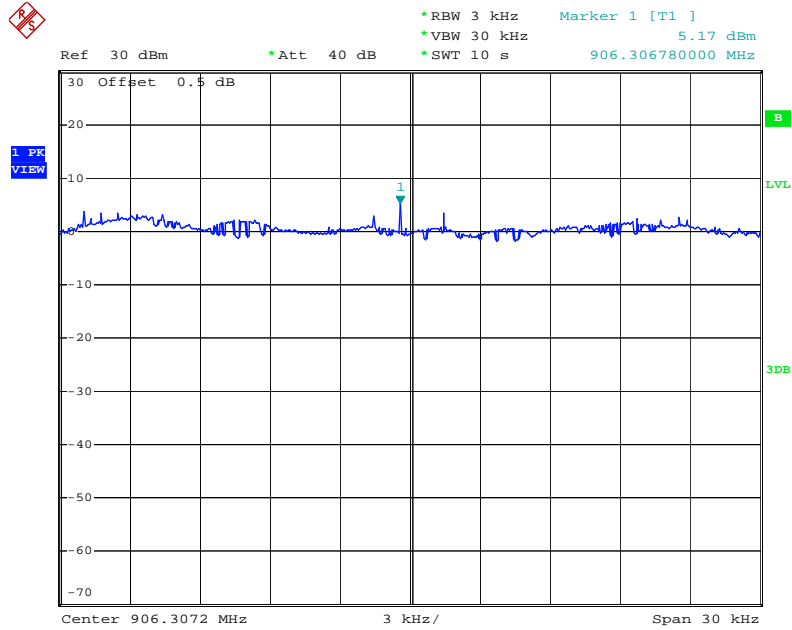

Date: 6.JUL.2011 11:58:43

Power Density Plot on Configuration DSSS / 922 MHz/ 10M/ Mode 2

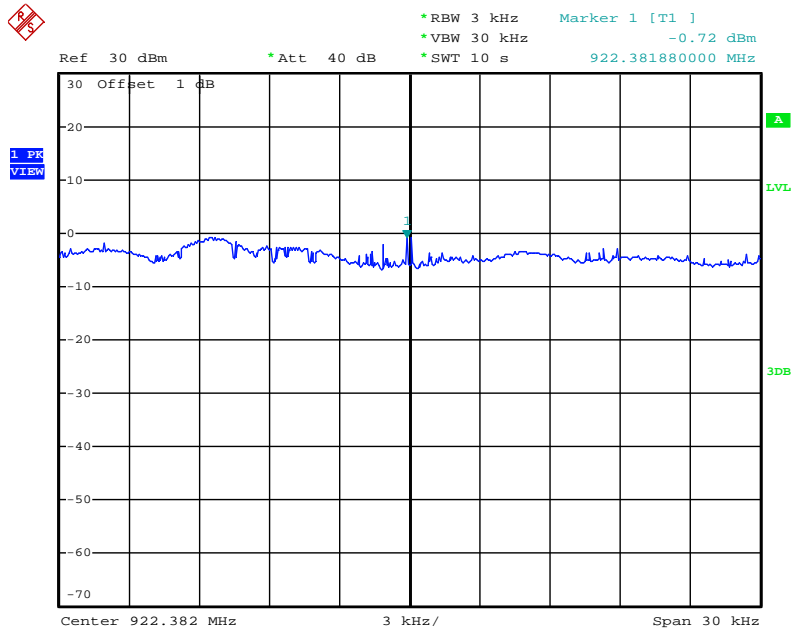

Date: 23.JUN.2011 20:28:11

Power Density Plot on Configuration DSSS / 912 MHz/ 20M/ Mode 1

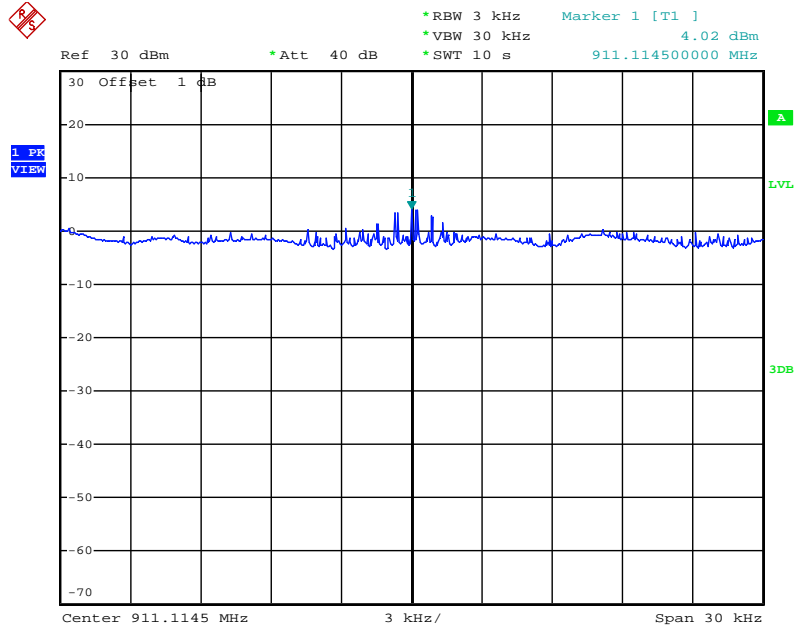

Date: 23.JUN.2011 20:36:59

Power Density Plot on Configuration DSSS / 912 MHz/ 20M/ Mode 2

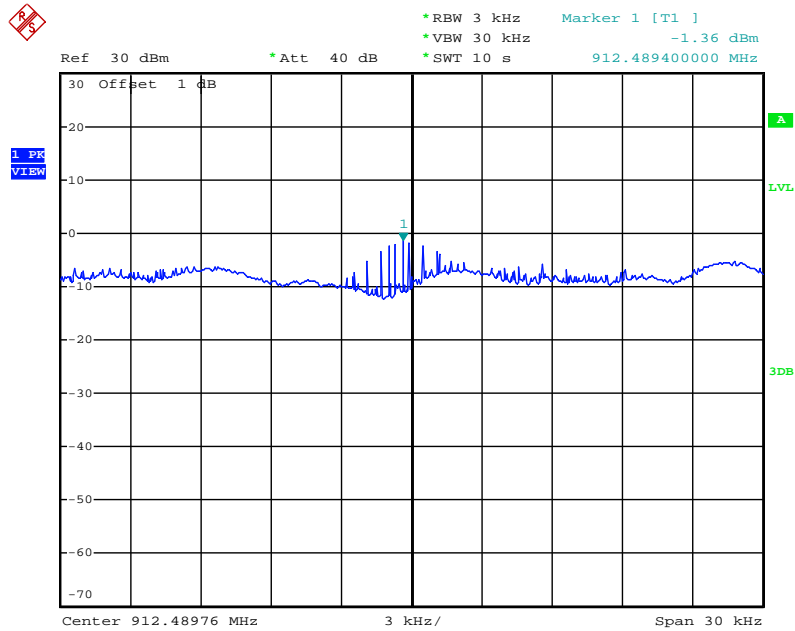

Date: 23.JUN.2011 20:43:36

Power Density Plot on Configuration OFDM / 912 MHz / 5M / Mode 1

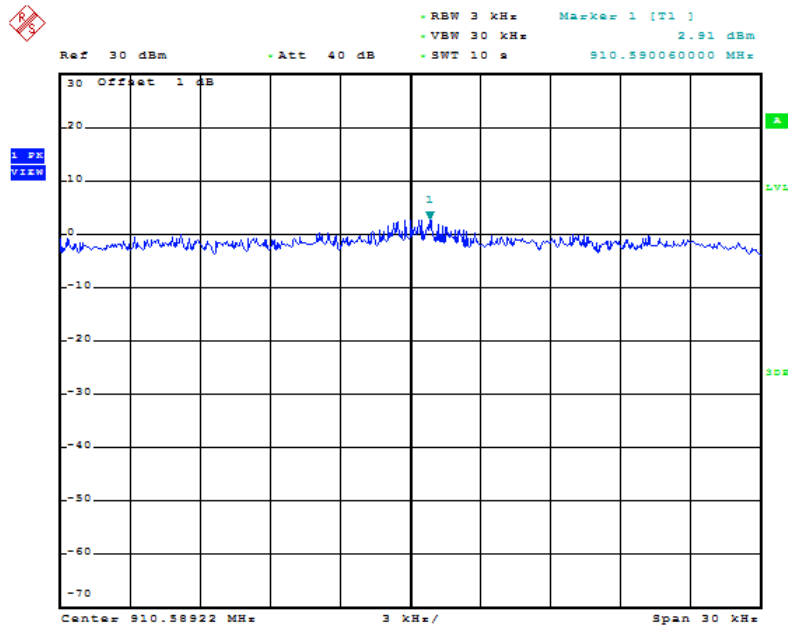

Date: 23.JUN.2011 18:25:50

Power Density Plot on Configuration OFDM / 912 MHz / 5M / Mode 2

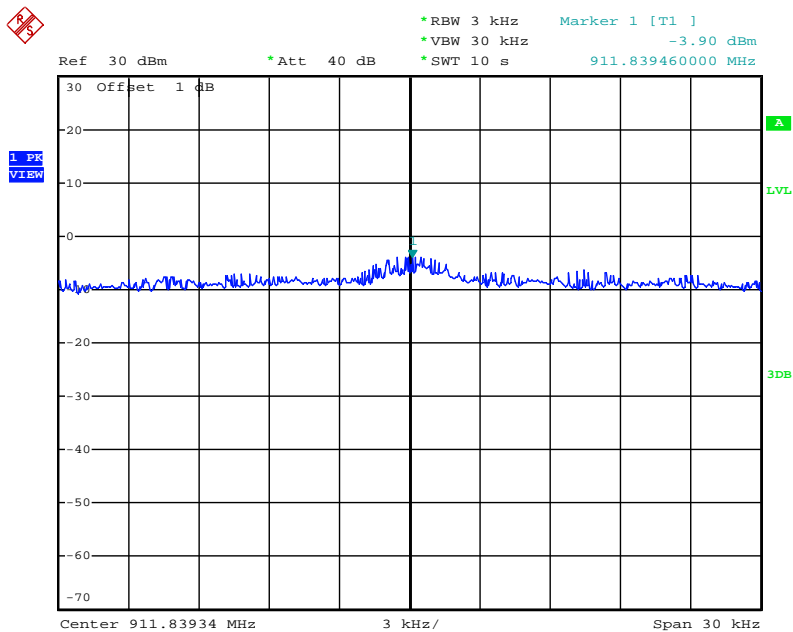

Date: 23.JUN.2011 17:58:49

Power Density Plot on Configuration OFDM / 922 MHz / 10M / Mode 1

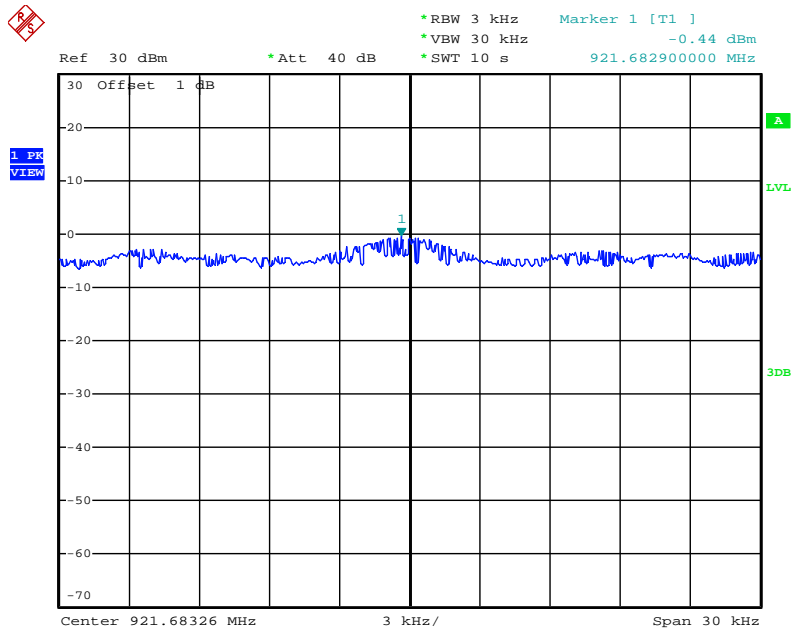

Date: 23.JUN.2011 19:35:03

Power Density Plot on Configuration OFDM / 907 MHz / 10M / Mode 2

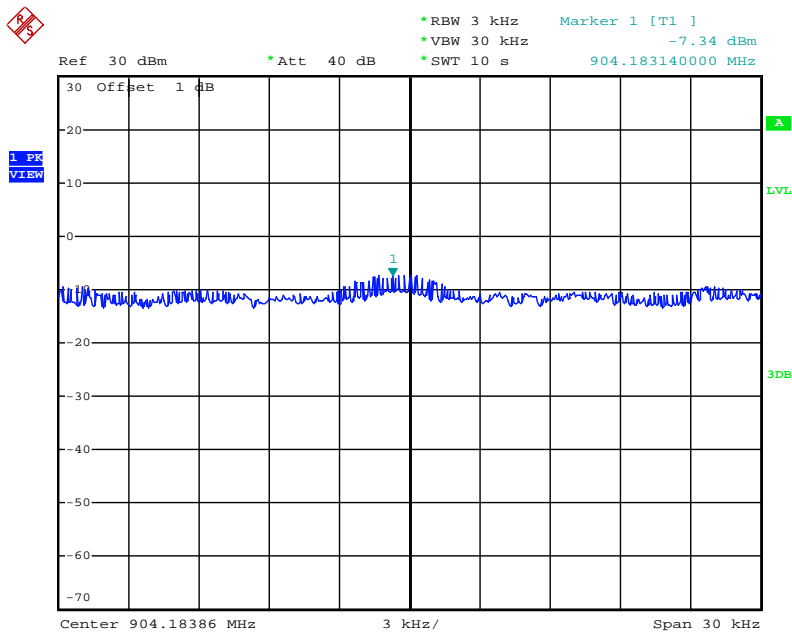

Date: 23.JUN.2011 18:46:20

Power Density Plot on Configuration OFDM / 912 MHz / 20M / Mode 1

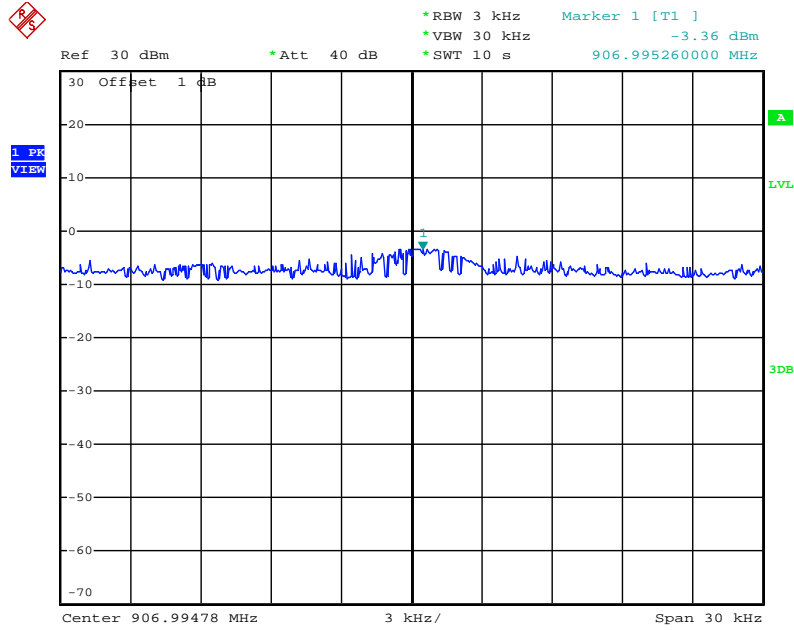

Date: 23.JUN.2011 20:57:06

Power Density Plot on Configuration OFDM / 912 MHz / 20M / Mode 2

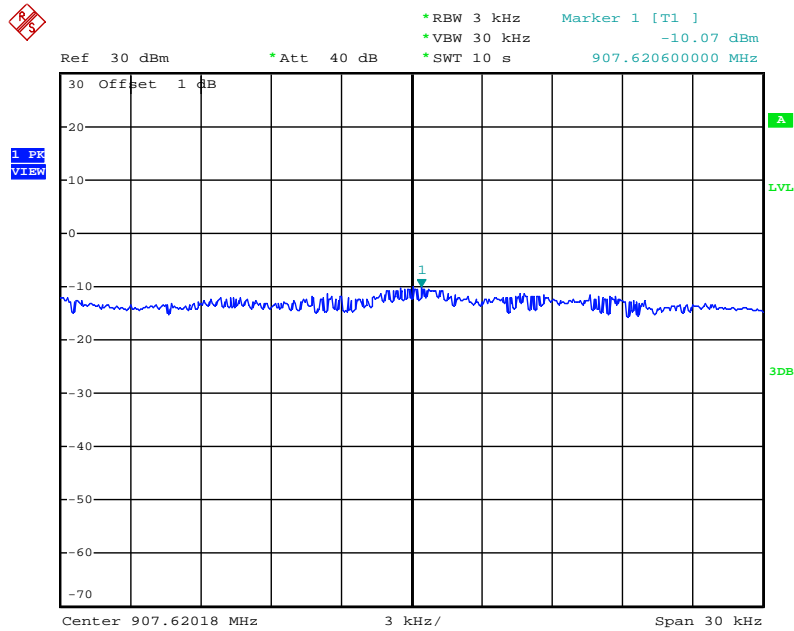

Date: 23.JUN.2011 20:49:42

4.4. 6dB Spectrum Bandwidth Measurement

4.4.1. Limit

For digital modulation systems, the minimum 6dB bandwidth shall be at least 500 kHz.

4.4.2. Measuring Instruments and Setting

Please refer to section 5 of equipments list in this report. The following table is the setting of the spectrum analyzer.

Spectrum Parameters	Setting
Attenuation	Auto
Span Frequency	> 6dB Bandwidth
RB	100 kHz
VB	100 kHz
Detector	Peak
Trace	Max Hold
Sweep Time	Auto

4.4.3. Test Procedures

1. The transmitter output (antenna port) was connected to the spectrum analyser in peak hold mode.
2. The resolution bandwidth of 100 kHz and the video bandwidth of 100 kHz were used.
3. Measured the spectrum width with power higher than 6dB below carrier.

4.4.4. Test Setup Layout

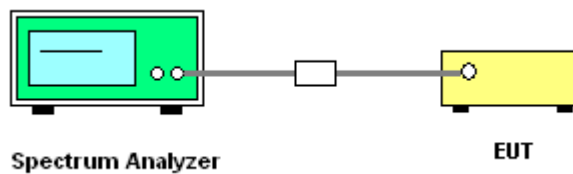

4.4.5. Test Deviation

There is no deviation with the original standard.

4.4.6. EUT Operation during Test

The EUT was programmed to be in continuously transmitting mode.

4.4.7. Test Result of 6dB Spectrum Bandwidth

Temperature	24°C	Humidity	66%
Test Engineer	Sam Chen	Configurations	5M/10M/20M
Test Date	Jun. 23, 2011	Test Mode	Mode 1

Configuration DSSS-5M

Channel	Frequency	6dB Bandwidth (MHz)	99% Occupied Bandwidth (MHz)	Min. Limit (kHz)	Test Result
1	907 MHz	3.00	3.88	500	Complies
2	912 MHz	3.06	3.90	500	Complies
3	917 MHz	3.00	3.89	500	Complies
4	922 MHz	2.85	3.86	500	Complies

Configuration OFDM-5M

Channel	Frequency	6dB Bandwidth (MHz)	99% Occupied Bandwidth (MHz)	Min. Limit (kHz)	Test Result
1	907 MHz	4.13	4.18	500	Complies
2	912 MHz	4.15	4.18	500	Complies
3	917 MHz	4.12	4.17	500	Complies
4	922 MHz	4.11	4.17	500	Complies

Configuration DSSS-10M

Channel	Frequency	6dB Bandwidth (MHz)	99% Occupied Bandwidth (MHz)	Min. Limit (kHz)	Test Result
1	907 MHz	5.34	7.66	500	Complies
2	912 MHz	6.24	7.80	500	Complies
3	917 MHz	6.02	7.82	500	Complies
4	922 MHz	5.86	7.68	500	Complies

Configuration OFDM-10M

Channel	Frequency	6dB Bandwidth (MHz)	99% Occupied Bandwidth (MHz)	Min. Limit (kHz)	Test Result
1	907 MHz	8.20	8.24	500	Complies
2	912 MHz	8.22	8.26	500	Complies
3	917 MHz	8.24	8.26	500	Complies
4	922 MHz	8.22	8.24	500	Complies

Configuration DSSS-20M

Channel	Frequency	6dB Bandwidth (MHz)	99% Occupied Bandwidth (MHz)	Min. Limit (kHz)	Test Result
2	912 MHz	12.00	15.32	500	Complies
3	917 MHz	12.20	15.44	500	Complies

Configuration OFDM-20M

Channel	Frequency	6dB Bandwidth (MHz)	99% Occupied Bandwidth (MHz)	Min. Limit (kHz)	Test Result
2	912 MHz	16.36	16.52	500	Complies
3	917 MHz	16.40	16.48	500	Complies

Temperature	24°C	Humidity	66%
Test Engineer	Sam Chen	Configurations	5M/10M/20M
Test Date	Jun. 23, 2011	Test Mode	Mode 2

Configuration DSSS-5M

Channel	Frequency	6dB Bandwidth (MHz)	99% Occupied Bandwidth (MHz)	Min. Limit (kHz)	Test Result
1	907 MHz	3.05	3.88	500	Complies
2	912 MHz	3.04	3.92	500	Complies
3	917 MHz	3.08	3.88	500	Complies
4	922 MHz	3.03	3.86	500	Complies

Configuration OFDM-5M

Channel	Frequency	6dB Bandwidth (MHz)	99% Occupied Bandwidth (MHz)	Min. Limit (kHz)	Test Result
1	907 MHz	4.14	4.17	500	Complies
2	912 MHz	4.14	4.17	500	Complies
3	917 MHz	4.12	4.17	500	Complies
4	922 MHz	4.14	4.17	500	Complies

Configuration DSSS-10M

Channel	Frequency	6dB Bandwidth (MHz)	99% Occupied Bandwidth (MHz)	Min. Limit (kHz)	Test Result
1	907 MHz	5.82	7.66	500	Complies
2	912 MHz	6.48	7.84	500	Complies
3	917 MHz	6.04	7.80	500	Complies
4	922 MHz	6.04	7.66	500	Complies

Configuration OFDM-10M

Channel	Frequency	6dB Bandwidth (MHz)	99% Occupied Bandwidth (MHz)	Min. Limit (kHz)	Test Result
1	907 MHz	8.22	8.24	500	Complies
2	912 MHz	8.20	8.26	500	Complies
3	917 MHz	8.22	8.26	500	Complies
4	922 MHz	8.22	8.24	500	Complies

Configuration DSSS-20M

Channel	Frequency	6dB Bandwidth (MHz)	99% Occupied Bandwidth (MHz)	Min. Limit (kHz)	Test Result
2	912 MHz	12.40	15.48	500	Complies
3	917 MHz	12.56	15.40	500	Complies

Configuration OFDM-20M

Channel	Frequency	6dB Bandwidth (MHz)	99% Occupied Bandwidth (MHz)	Min. Limit (kHz)	Test Result
2	912 MHz	16.40	16.52	500	Complies
3	917 MHz	16.44	16.48	500	Complies

6 dB Bandwidth Plot on Configuration DSSS / 922 MHz / 5M / Mode 1

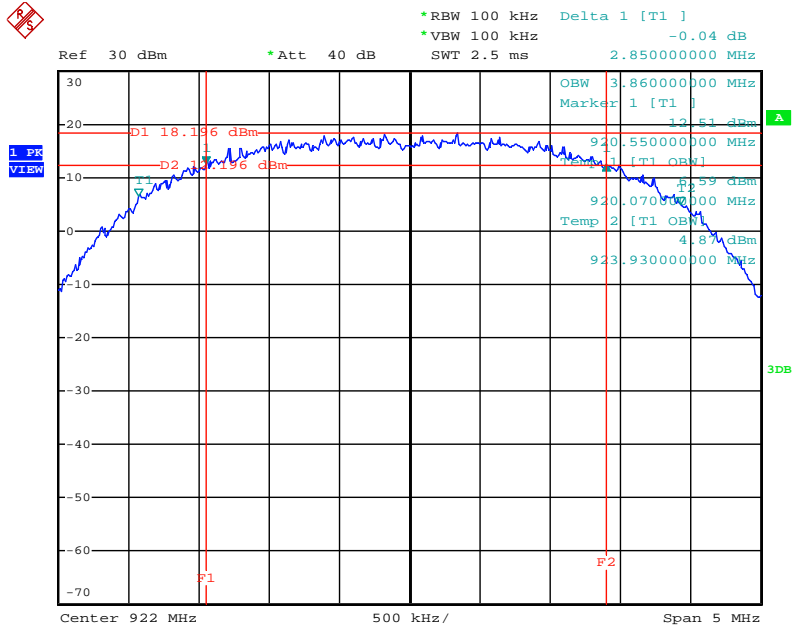

Date: 23.JUN.2011 17:42:46

6 dB Bandwidth Plot on Configuration DSSS / 922 MHz / 5M / Mode 2

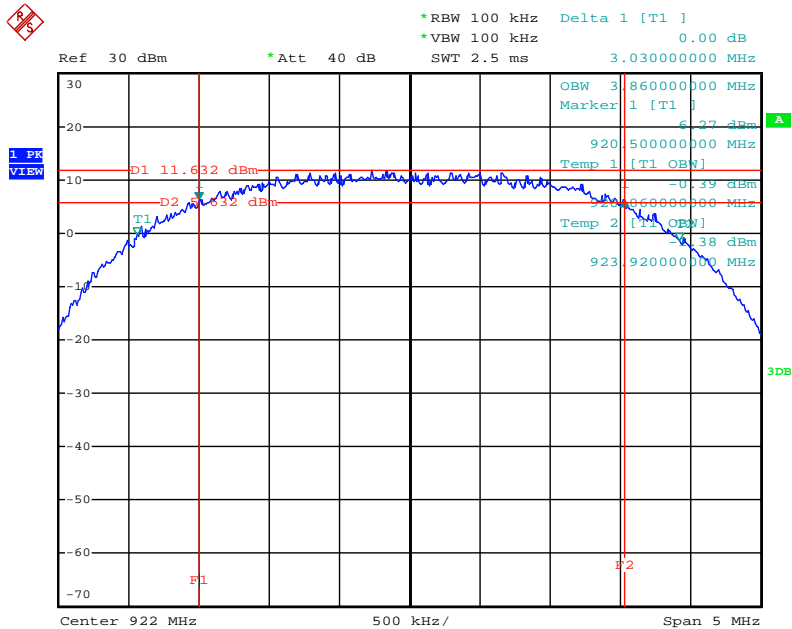

Date: 23.JUN.2011 17:28:24

6 dB Bandwidth Plot on Configuration DSSS / 907 MHz / 10M / Mode 1

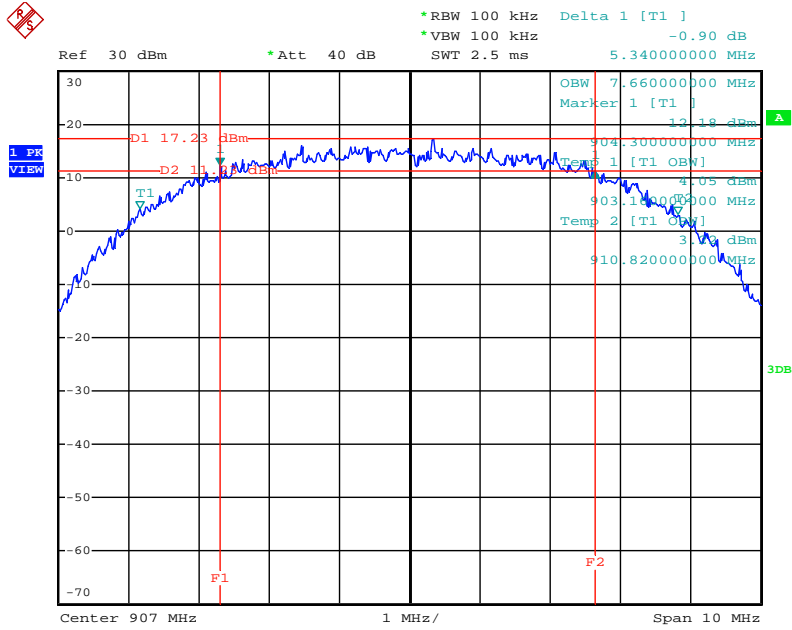

Date: 23.JUN.2011 20:02:12

6 dB Bandwidth Plot on Configuration DSSS / 907 MHz / 10M / Mode 2

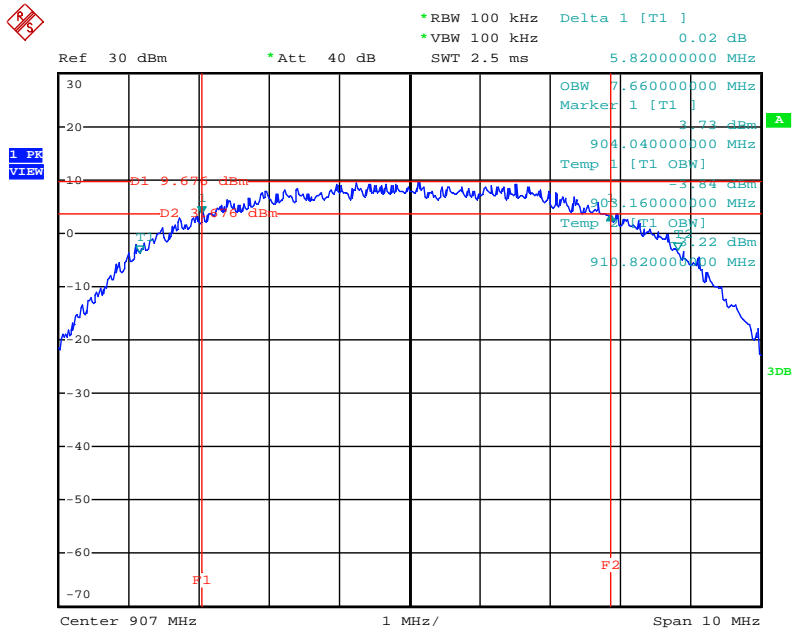

Date: 23.JUN.2011 20:32:56

6 dB Bandwidth Plot on Configuration DSSS / 912 MHz / 20M / Mode 1

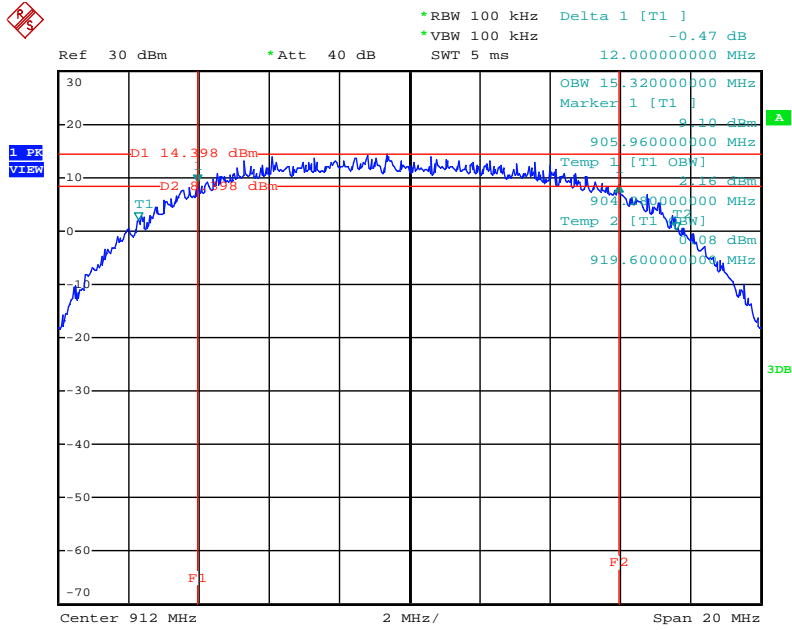

Date: 23.JUN.2011 20:35:32

6 dB Bandwidth Plot on Configuration DSSS / 912 MHz / 20M / Mode 2

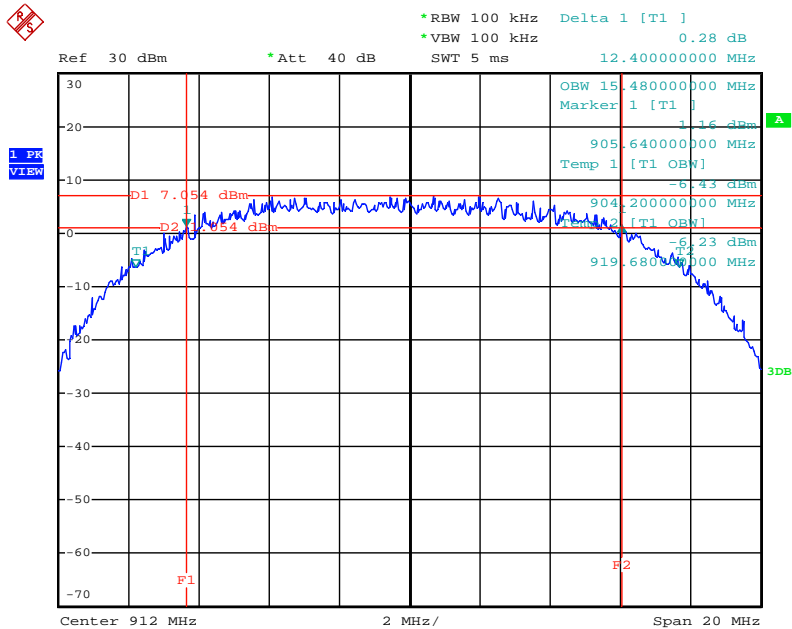

Date: 23.JUN.2011 20:42:08

6 dB Bandwidth Plot on Configuration IEEE 802.OFDM / 922 MHz /5M/ Mode 1

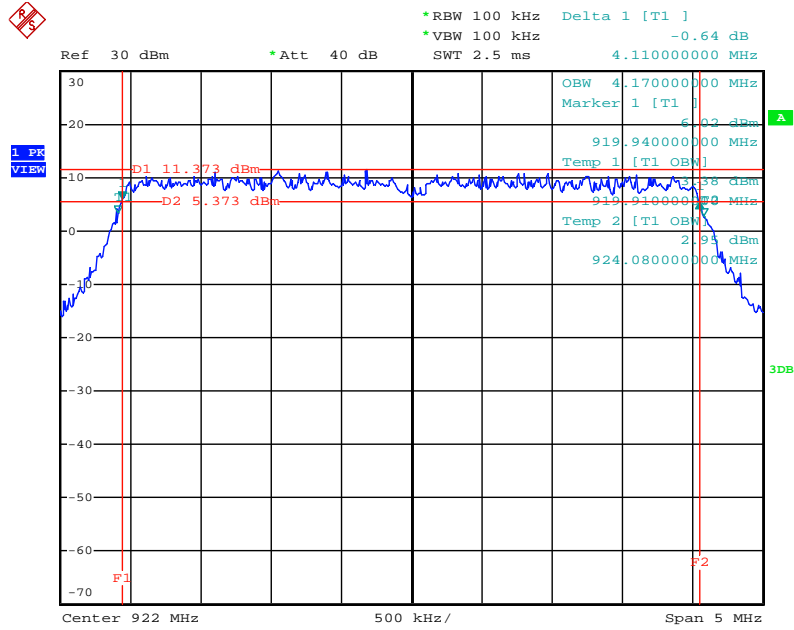

Date: 23.JUN.2011 18:20:31

6 dB Bandwidth Plot on Configuration IEEE 802.OFDM / 917 MHz /5M/ Mode 2

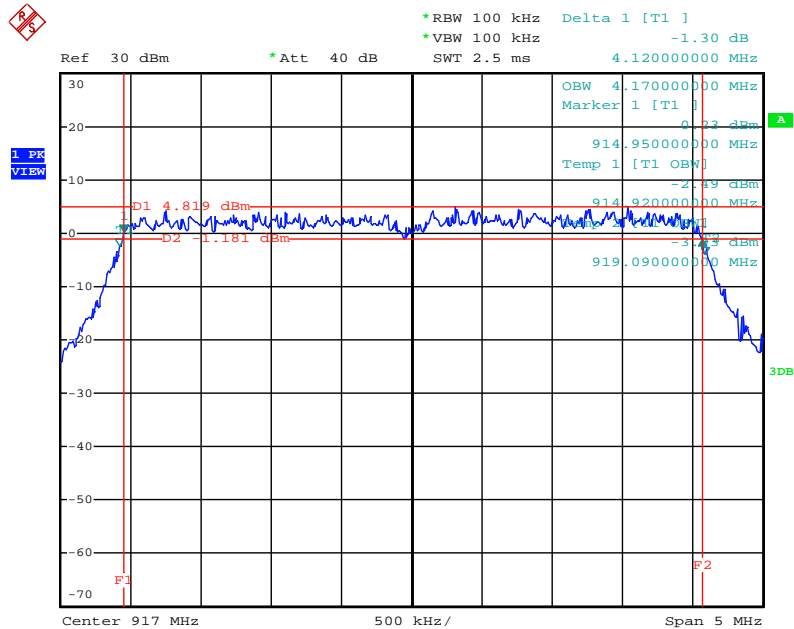

Date: 23.JUN.2011 17:59:09

6 dB Bandwidth Plot on Configuration IEEE 802.OFDM / 912 MHz /10M/ Mode 1

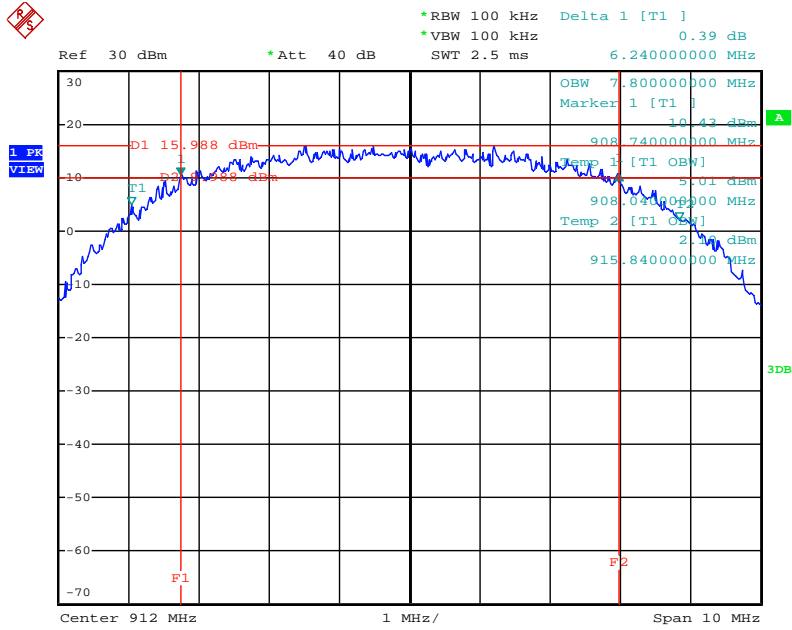

Date: 23.JUN.2011 20:04:17

6 dB Bandwidth Plot on Configuration IEEE 802.OFDM / 912 MHz /10M/ Mode 1

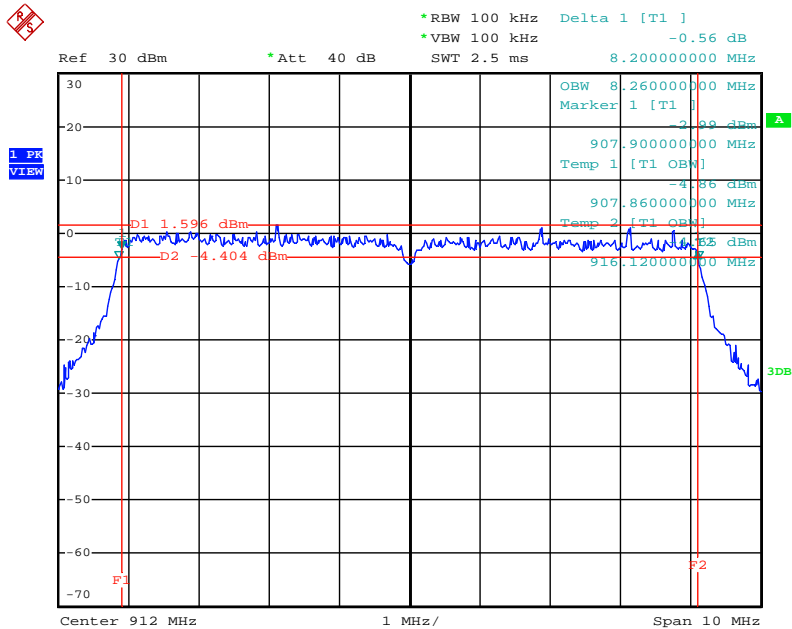

Date: 23.JUN.2011 18:47:14

6 dB Bandwidth Plot on Configuration IEEE 802.OFDM / 912 MHz /20M/ Mode 1

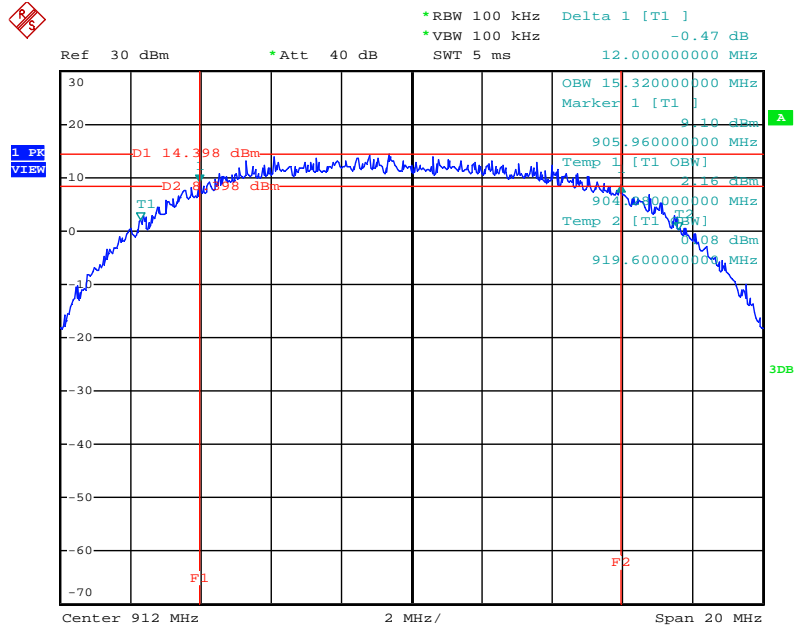

Date: 23.JUN.2011 20:35:32

6 dB Bandwidth Plot on Configuration IEEE 802.OFDM / 912 MHz /20M/ Mode 2

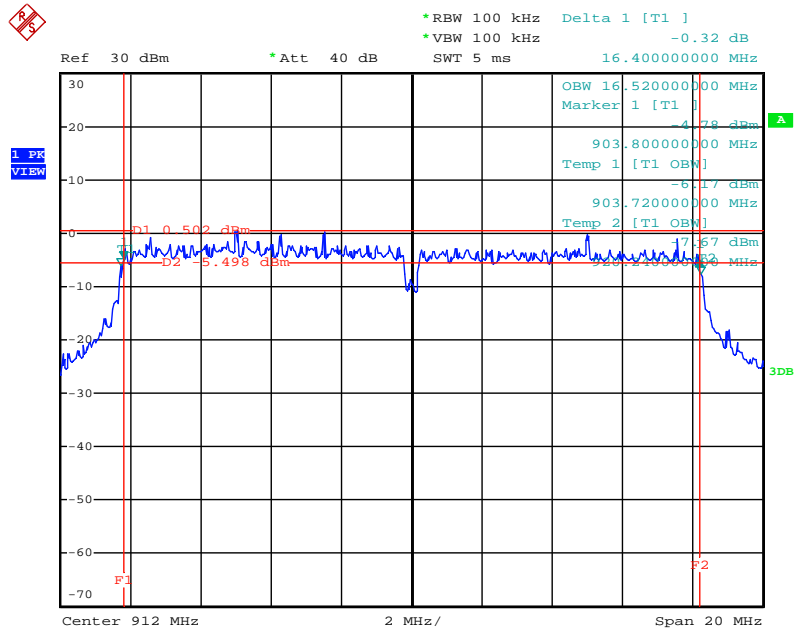

Date: 23.JUN.2011 20:48:14

4.5. Radiated Emissions Measurement

4.5.1. Limit

20dBc in any 100 kHz bandwidth outside the operating frequency band. In case the emission fall within the restricted band specified on 15.205(a), then the 15.209(a) limit in the table below has to be followed.

Frequencies (MHz)	Field Strength (micorvolts/meter)	Measurement Distance (meters)
0.009~0.490	2400/F(KHz)	300
0.490~1.705	24000/F(KHz)	30
1.705~30.0	30	30
30~88	100	3
88~216	150	3
216~960	200	3
Above 960	500	3

4.5.2. Measuring Instruments and Setting

Please refer to section 5 of equipments list in this report. The following table is the setting of spectrum analyzer and receiver.

Spectrum Parameter	Setting
Attenuation	Auto
Start Frequency	1000 MHz
Stop Frequency	10th carrier harmonic
RB / VB (Emission in restricted band)	1MHz / 1MHz for Peak, 1 MHz / 10Hz for Average
RB / VB (Emission in non-restricted band)	100KHz / 100KHz for peak

Receiver Parameter	Setting
Attenuation	Auto
Start ~ Stop Frequency	9kHz~150kHz / RB 200Hz for QP
Start ~ Stop Frequency	150kHz~30MHz / RB 9kHz for QP
Start ~ Stop Frequency	30MHz~1000MHz / RB 120kHz for QP

4.5.3. Test Procedures

1. Configure the EUT according to ANSI C63.4. The EUT was placed on the top of the turntable 0.8 meter above ground. The phase center of the receiving antenna mounted on the top of a height-variable antenna tower was placed 3 meters far away from the turntable.
2. Power on the EUT and all the supporting units. The turntable was rotated by 360 degrees to determine the position of the highest radiation.
3. The height of the broadband receiving antenna was varied between one meter and four meters above ground to find the maximum emissions field strength of both horizontal and vertical polarization.
4. For each suspected emissions, the antenna tower was scan (from 1 M to 4 M) and then the turntable was rotated (from 0 degree to 360 degrees) to find the maximum reading.
5. Set the test-receiver system to Peak or CISPR quasi-peak Detect Function with specified bandwidth under Maximum Hold Mode.
6. For emissions above 1GHz, use 1MHz VBW and RBW for peak reading. Then 1MHz RBW and 10Hz VBW for average reading in spectrum analyzer.
7. When the radiated emissions limits are expressed in terms of the average value of the emissions, and pulsed operation is employed, the measurement field strength shall be determined by averaging over one complete pulse train, including blanking intervals, as long as the pulse train does not exceed 0.1 seconds. As an alternative (provided the transmitter operates for longer than 0.1 seconds) or in cases where the pulse train exceeds 0.1 seconds, the measured field strength shall be determined from the average absolute voltage during a 0.1 second interval during which the field strength is at its maximum value.
8. If the emissions level of the EUT in peak mode was 3 dB lower than the average limit specified, then testing will be stopped and peak values of EUT will be reported, otherwise, the emissions which do not have 3 dB margin will be repeated one by one using the quasi-peak method for below 1GHz.
9. For testing above 1GHz, the emissions level of the EUT in peak mode was lower than average limit (that means the emissions level in peak mode also complies with the limit in average mode), then testing will be stopped and peak values of EUT will be reported, otherwise, the emissions will be measured in average mode again and reported.
10. In case the emission is lower than 30MHz, loop antenna has to be used for measurement and the recorded data should be QP measured by receiver. High – Low scan is not required in this case.

4.5.4. Test Setup Layout

For radiated emissions below 30MHz

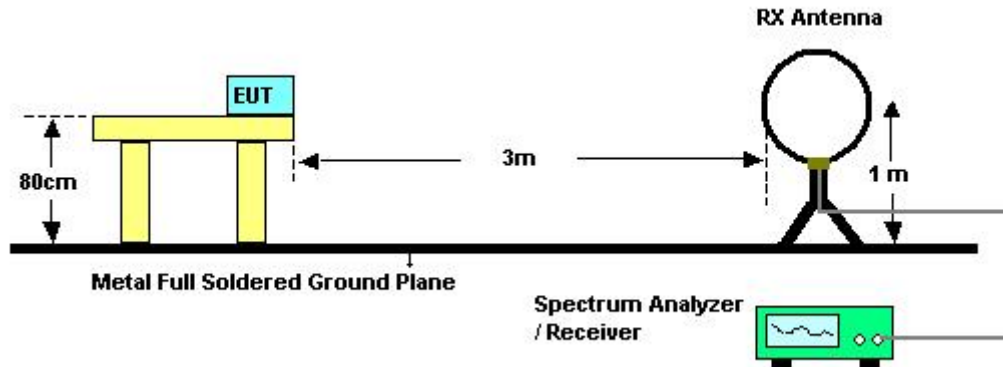

For radiated emissions above 30MHz

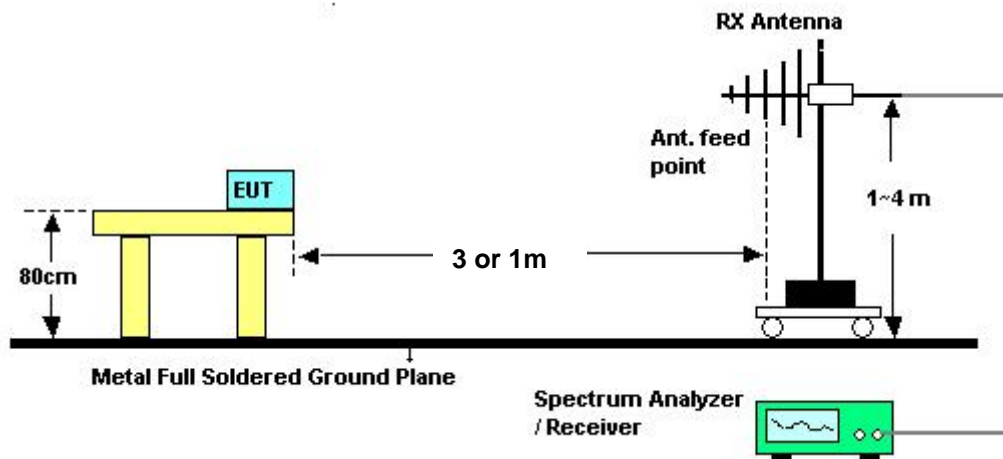

4.5.5. Test Deviation

There is no deviation with the original standard.

4.5.6. EUT Operation during Test

The EUT was programmed to be in continuously transmitting mode.

4.5.7. Results of Radiated Emissions (9kHz~30MHz)

Temperature	23°C	Humidity	65%
Test Engineer	Serway Lee	Test date	Jun. 20, 2011

Freq. (MHz)	Level (dBuV)	Over Limit (dB)	Limit Line (dBuV)	Remark
-	-	-	-	See Note

Note:

The amplitude of spurious emissions that are attenuated by more than 20 dB below the permissible value has no need to be reported.

Distance extrapolation factor = $40 \log(\text{specific distance} / \text{test distance})$ (dB);

Limit line = specific limits (dBuV) + distance extrapolation factor.

4.5.8. Results of Radiated Emissions (30MHz~1GHz)

Temperature	23°C	Humidity	65%
Test Engineer	Sam Chen	Configurations	Mode 1

Horizontal

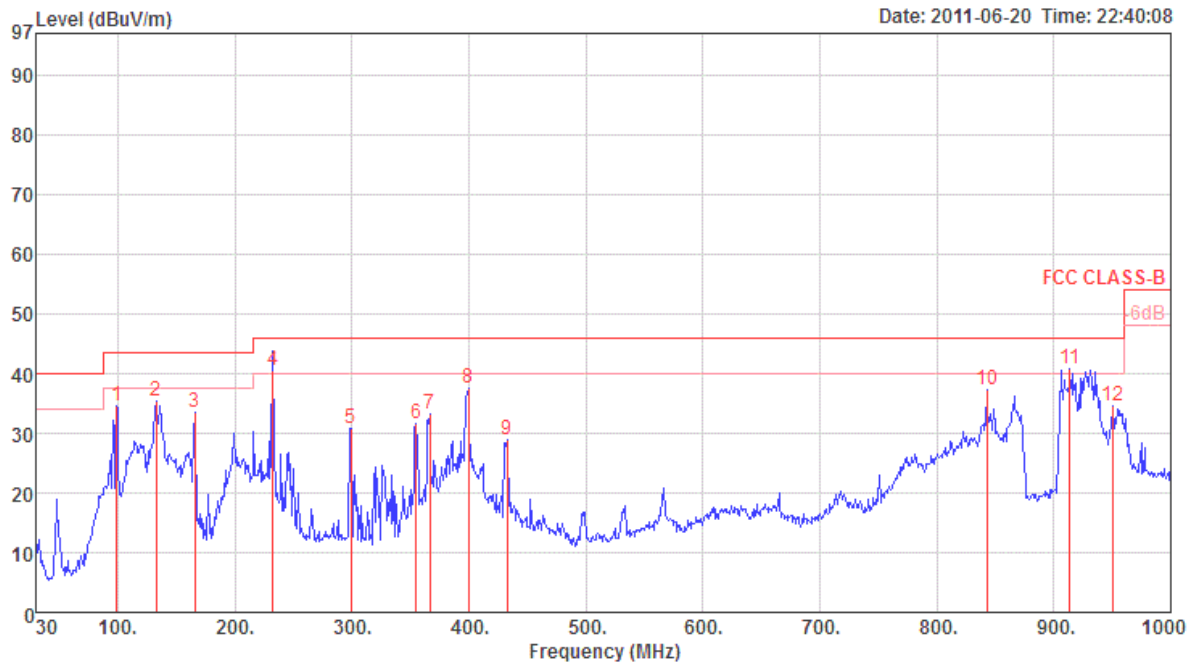

	Freq	Level	Limit	Over	Read	Cable	Preamp	Antenna	T/Pos	A/Pos	Remark	Pol/Phase	Aux
	MHz	dBuV/m	dBuV/m	dB	dBuV	dB	dB	dB/m	deg	cm			dB
1	98.87	34.55	43.50	-8.95	57.93	1.18	27.61	10.61	0	100	Peak	HORIZONTAL	-0.00
2	132.82	35.38	43.50	-8.12	53.79	1.33	27.43	11.82	0	100	Peak	HORIZONTAL	-0.00
3	165.80	33.54	43.50	-9.96	55.51	1.53	27.27	9.63	0	100	Peak	HORIZONTAL	-0.00
4	232.73	40.63	46.00	-5.37	57.10	1.83	27.03	11.54	0	100	QP	HORIZONTAL	-0.00
5	299.66	30.88	46.00	-15.12	48.92	2.10	26.90	13.46	0	100	Peak	HORIZONTAL	-0.00
6	354.95	31.58	46.00	-14.42	49.68	2.21	27.29	14.98	0	100	Peak	HORIZONTAL	-0.00
7	366.59	33.20	46.00	-12.80	51.04	2.23	27.37	15.30	0	100	Peak	HORIZONTAL	-0.00
8	399.57	37.60	46.00	-8.40	54.98	2.30	27.60	16.21	0	100	Peak	HORIZONTAL	-0.00
9	432.55	28.78	46.00	-17.22	46.65	2.50	27.76	16.66	0	100	Peak	HORIZONTAL	-0.00
10	842.86	37.32	46.00	-8.68	47.64	3.39	27.52	20.66	0	100	Peak	HORIZONTAL	-0.00
11	913.67	40.74	46.00	-5.26	51.06	3.60	27.34	21.24	0	100	Peak	HORIZONTAL	-0.00
12	950.53	34.48	46.00	-11.52	42.86	3.60	27.20	21.41	0	100	Peak	HORIZONTAL	-0.00

Vertical

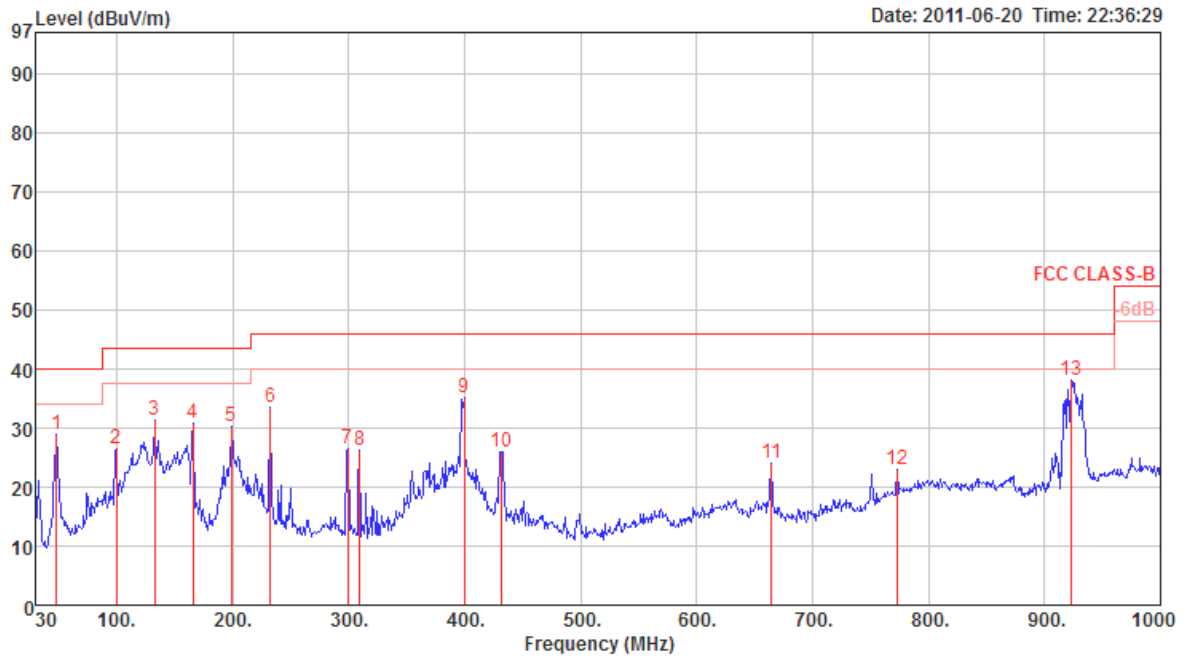

	Freq	Level	Limit Line	Over Limit	Read Level	Cable Loss	Preamp Factor	Antenna Factor	T/Pos	A/Pos	Remark	Pol/Phase	Aux Factor
	MHz	dBuV/m	dBuV/m	dB	dBuV	dB	dB	dB/m	deg	cm			dB
1	48.43	29.01	40.00	-10.99	47.95	0.70	27.80	8.16	0	200	Peak	VERTICAL	0.00
2	99.84	26.43	43.50	-17.07	42.04	1.20	27.60	10.79	0	200	Peak	VERTICAL	0.00
3	132.82	31.35	43.50	-12.15	45.63	1.33	27.43	11.82	0	200	Peak	VERTICAL	0.00
4	165.80	30.88	43.50	-12.62	46.99	1.53	27.27	9.63	0	200	Peak	VERTICAL	0.00
5	198.78	30.20	43.50	-13.30	46.23	1.69	27.11	9.39	0	200	Peak	VERTICAL	0.00
6	232.73	33.63	46.00	-12.37	47.29	1.83	27.03	11.54	0	200	Peak	VERTICAL	0.00
7	299.66	26.47	46.00	-19.53	37.81	2.10	26.90	13.46	0	200	Peak	VERTICAL	0.00
8	309.36	26.30	46.00	-19.70	37.41	2.12	26.96	13.73	0	200	Peak	VERTICAL	0.00
9	399.57	35.04	46.00	-10.96	44.13	2.30	27.60	16.21	0	200	Peak	VERTICAL	0.00
10	431.58	26.07	46.00	-19.93	34.70	2.49	27.76	16.64	0	200	Peak	VERTICAL	0.00
11	664.38	24.08	46.00	-21.92	29.69	3.44	28.04	18.99	0	200	Peak	VERTICAL	0.00
12	773.02	23.00	46.00	-23.00	27.35	3.41	27.71	19.95	0	200	Peak	VERTICAL	0.00
13 p	922.40	38.12	46.00	-7.88	40.55	3.60	27.31	21.28	0	200	Peak	VERTICAL	0.00

Temperature	23°C	Humidity	65%
Test Engineer	Denis	Configurations	Mode 2

Horizontal

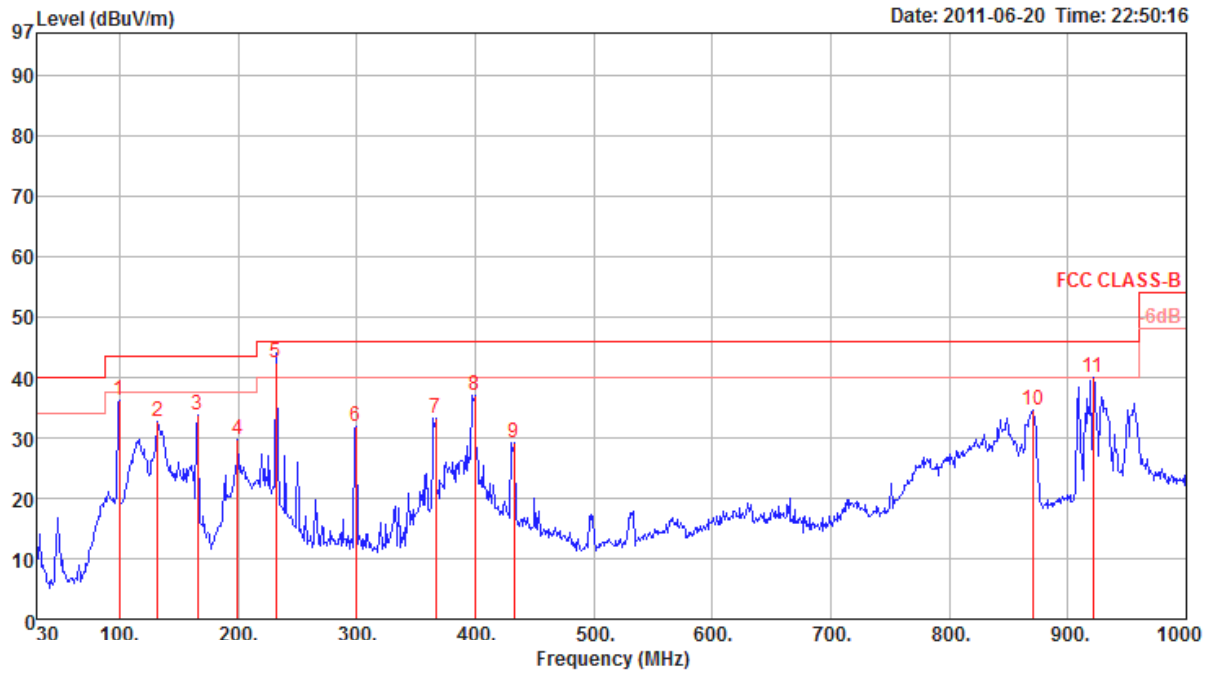

	Freq	Level	Limit	Over	Read	Cable	Preamp	Antenna	T/Pos	A/Pos	Remark	Pol/Phase	Aux
	MHz	dBuV/m	dBuV/m	dB	dBuV	dB	dB	dB/m	deg	cm			dB
1	99.84	36.31	43.50	-7.19	51.92	1.20	27.60	10.79	0	100	Peak	HORIZONTAL	0.00
2	131.85	32.81	43.50	-10.69	47.04	1.32	27.44	11.89	0	100	Peak	HORIZONTAL	0.00
3	165.80	33.86	43.50	-9.64	49.97	1.53	27.27	9.63	0	100	Peak	HORIZONTAL	0.00
4	199.75	29.75	43.50	-13.75	45.75	1.70	27.10	9.40	0	100	Peak	HORIZONTAL	0.00
5	231.76	42.37	46.00	-3.63	56.10	1.83	27.04	11.48	265	150	QP	HORIZONTAL	0.00
6	299.66	31.91	46.00	-14.09	43.25	2.10	26.90	13.46	0	100	Peak	HORIZONTAL	0.00
7	366.59	33.32	46.00	-12.68	43.16	2.23	27.37	15.30	0	100	Peak	HORIZONTAL	0.00
8	399.57	37.15	46.00	-8.85	46.24	2.30	27.60	16.21	0	100	Peak	HORIZONTAL	0.00
9	432.55	29.26	46.00	-16.74	37.86	2.50	27.76	16.66	0	100	Peak	HORIZONTAL	0.00
10	870.02	34.69	46.00	-11.31	37.76	3.48	27.46	20.91	0	100	Peak	HORIZONTAL	0.00
11	921.43	40.01	46.00	-5.99	42.44	3.60	27.31	21.28	0	100	Peak	HORIZONTAL	0.00

Vertical

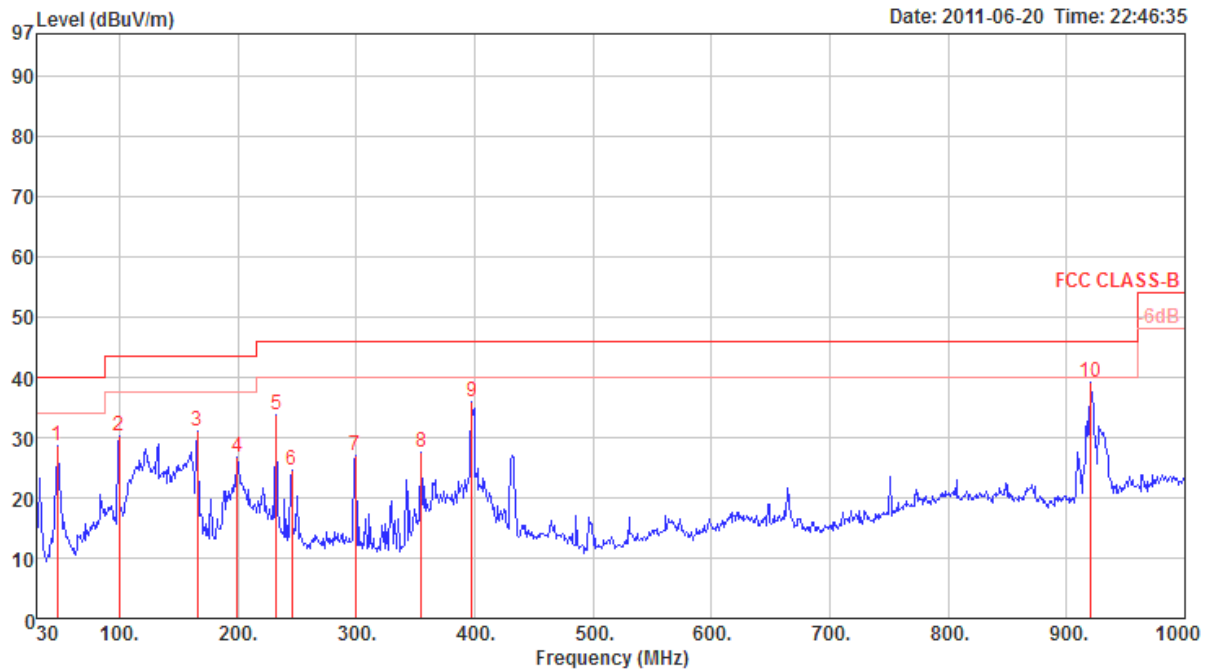

	Freq	Level	Limit	Over	Read	Cable	Preamp	Antenna	T/Pos	A/Pos	Remark	Pol/Phase	Aux
	MHz	dBuV/m	dBuV/m	dB	dBuV	dB	dB	dB/m	deg	cm			dB
1	47.46	28.65	40.00	-11.35	47.25	0.70	27.80	8.50	0	200	Peak	VERTICAL	0.00
2	99.84	30.31	43.50	-13.19	45.92	1.20	27.60	10.79	0	200	Peak	VERTICAL	0.00
3	165.80	31.16	43.50	-12.34	47.27	1.53	27.27	9.63	0	200	Peak	VERTICAL	0.00
4	199.75	26.73	43.50	-16.77	42.73	1.70	27.10	9.40	0	200	Peak	VERTICAL	0.00
5	232.73	33.87	46.00	-12.13	47.53	1.83	27.03	11.54	0	200	Peak	VERTICAL	0.00
6	245.34	24.66	46.00	-21.34	37.43	1.88	27.01	12.36	0	200	Peak	VERTICAL	0.00
7	299.66	26.92	46.00	-19.08	38.26	2.10	26.90	13.46	0	200	Peak	VERTICAL	0.00
8	354.95	27.57	46.00	-18.43	37.67	2.21	27.29	14.98	0	200	Peak	VERTICAL	0.00
9	397.63	35.88	46.00	-10.12	45.00	2.30	27.58	16.16	0	200	Peak	VERTICAL	0.00
10 p	920.46	39.19	46.00	-6.81	41.64	3.60	27.32	21.27	0	200	Peak	VERTICAL	0.00

Note:

The amplitude of spurious emissions that are attenuated by more than 20dB below the permissible value has no need to be reported.

Emission level (dBuV/m) = 20 log Emission level (uV/m).

Corrected Reading: Antenna Factor + Cable Loss + Read Level - Preamp Factor = Level.

4.5.9. Results for Radiated Emissions (1GHz~10th Harmonic)

Temperature	23°C	Humidity	65%
Test Engineer	Allen Liu	Configurations	DSSS - 907MHz/CH 1/ 5M/ Mode 1
Test Date	Apr. 23, 2011		

Horizontal

	Freq	Level	Limit Line	Over Limit	Read Level	Cable Loss	Preamp Factor	Antenna Factor	T/Pos	A/Pos	Remark	Pol/Phase
	MHz	dBuV/m	dBuV/m	dB	dBuV	dB	dB	dB/m	deg	cm		
1 p	2717.21	67.41	74.00	-6.59	71.58	2.23	34.75	28.35	149	100	Peak	HORIZONTAL
2 a	2719.88	46.75	54.00	-7.25	50.92	2.23	34.75	28.35	149	100	Average	HORIZONTAL

Vertical

	Freq	Level	Limit Line	Over Limit	Read Level	Cable Loss	Preamp Factor	Antenna Factor	T/Pos	A/Pos	Remark	Pol/Phase
	MHz	dBuV/m	dBuV/m	dB	dBuV	dB	dB	dB/m	deg	cm		
1 p	2718.28	71.37	74.00	-2.63	75.54	2.23	34.75	28.35	117	159	Peak	VERTICAL
2 a	2720.00	52.49	54.00	-1.51	56.66	2.23	34.75	28.35	117	159	Average	VERTICAL



Temperature	23°C	Humidity	65%
Test Engineer	Allen Liu	Configurations	DSSS - 912MHz/CH 2/ 5M/ Mode 1
Test Date	Apr. 23, 2011		

Horizontal

	Freq	Level	Limit Line	Over Limit	Read Level	Cable Loss	Preamp Factor	Antenna Factor	T/Pos	A/Pos	Remark	Pol/Phase
	MHz	dBuV/m	dBuV/m	dB	dBuV	dB	dB	dB/m	deg	cm		
1 p	2735.67	61.14	74.00	-12.86	65.24	2.24	34.74	28.40	175	100	Peak	HORIZONTAL
2 a	2736.00	46.42	54.00	-7.58	50.52	2.24	34.74	28.40	175	100	Average	HORIZONTAL

Vertical

	Freq	Level	Limit Line	Over Limit	Read Level	Cable Loss	Preamp Factor	Antenna Factor	T/Pos	A/Pos	Remark	Pol/Phase
	MHz	dBuV/m	dBuV/m	dB	dBuV	dB	dB	dB/m	deg	cm		
1 p	2732.20	68.98	74.00	-5.02	73.08	2.24	34.74	28.40	127	100	Peak	VERTICAL
2 a	2735.82	53.36	54.00	-0.64	57.46	2.24	34.74	28.40	127	100	Average	VERTICAL

Temperature	23°C	Humidity	65%
Test Engineer	Allen Liu	Configurations	DSSS - 917MHz/CH 3/ 5M/ Mode 1
Test Date	Apr. 23, 2011		

Horizontal

	Freq	Level	Limit	Over	Read	Cable	Preamp	Antenna	T/Pos	A/Pos	Remark	Pol/Phase
	MHz	dBuV/m	dBuV/m	dB	dBuV	dB	dB	dB/m	deg	cm		
1 a	2751.35	49.06	54.00	-4.94	53.09	2.26	34.74	28.45	172	100	Average	HORIZONTAL
2 p	2752.72	61.72	74.00	-12.28	65.75	2.26	34.74	28.45	172	100	Peak	HORIZONTAL

Vertical

	Freq	Level	Limit	Over	Read	Cable	Preamp	Antenna	T/Pos	A/Pos	Remark	Pol/Phase
	MHz	dBuV/m	dBuV/m	dB	dBuV	dB	dB	dB/m	deg	cm		
1 a	2751.26	50.90	54.00	-3.10	54.93	2.26	34.74	28.45	126	100	Average	VERTICAL
2 p	2751.86	65.55	74.00	-8.45	69.58	2.26	34.74	28.45	126	100	Peak	VERTICAL

Temperature	23°C	Humidity	65%
Test Engineer	Allen Liu	Configurations	DSSS – 922 MHz/CH 4/ 5M / Mode 1
Test Date	Apr. 23, 2011		

Horizontal

	Freq	Level	Limit Line	Over Limit	Read Level	Cable Loss	Preamp Factor	Antenna Factor	T/Pos	A/Pos	Remark	Pol/Phase
	MHz	dBuV/m	dBuV/m	dB	dBuV	dB	dB	dB/m	deg	cm		
1 a	2766.26	44.53	54.00	-9.47	48.51	2.26	34.74	28.50	306	100	Average	HORIZONTAL
2 p	2767.65	58.75	74.00	-15.25	62.73	2.26	34.74	28.50	306	100	Peak	HORIZONTAL

Vertical

	Freq	Level	Limit Line	Over Limit	Read Level	Cable Loss	Preamp Factor	Antenna Factor	T/Pos	A/Pos	Remark	Pol/Phase
	MHz	dBuV/m	dBuV/m	dB	dBuV	dB	dB	dB/m	deg	cm		
1 a	2766.21	52.70	54.00	-1.30	56.68	2.26	34.74	28.50	158	173	Average	VERTICAL
2 p	2767.80	68.46	74.00	-5.54	72.44	2.26	34.74	28.50	158	173	Peak	VERTICAL

Temperature	23°C	Humidity	65%
Test Engineer	Allen Liu	Configurations	DSSS – 907 MHz/CH 1/ 10M / Mode 1
Test Date	Apr. 23, 2011		

Horizontal

	Freq	Level	Limit Line	Over Limit	Read Level	Cable Loss	Preamp Factor	Antenna Factor	T/Pos	A/Pos	Remark	Pol/Phase
	MHz	dBuV/m	dBuV/m	dB	dBuV	dB	dB	dB/m	deg	cm		
1 p	2714.48	67.28	74.00	-6.72	71.45	2.23	34.75	28.35	153	100	Peak	HORIZONTAL
2 a	2717.94	49.15	54.00	-4.85	53.32	2.23	34.75	28.35	153	100	Average	HORIZONTAL

Vertical

	Freq	Level	Limit Line	Over Limit	Read Level	Cable Loss	Preamp Factor	Antenna Factor	T/Pos	A/Pos	Remark	Pol/Phase
	MHz	dBuV/m	dBuV/m	dB	dBuV	dB	dB	dB/m	deg	cm		
1 p	2711.52	71.59	74.00	-2.41	75.76	2.23	34.75	28.35	117	130	Peak	VERTICAL
2 a	2719.18	53.51	54.00	-0.49	57.68	2.23	34.75	28.35	117	130	Average	VERTICAL

Temperature	23°C	Humidity	65%
Test Engineer	Allen Liu	Configurations	DSSS – 912 MHz/CH 2/ 10M / Mode 1
Test Date	Apr. 23, 2011		

Horizontal

	Freq	Level	Limit Line	Over Limit	Read Level	Cable Loss	Preamp Factor	Antenna Factor	T/Pos	A/Pos	Remark	Pol/Phase
	MHz	dBuV/m	dBuV/m	dB	dBuV	dB	dB	dB/m	deg	cm		
1 a	2734.98	45.17	54.00	-8.83	49.27	2.24	34.74	28.40	216	127	Average	HORIZONTAL
2 p	2739.92	59.53	74.00	-14.47	63.63	2.24	34.74	28.40	216	127	Peak	HORIZONTAL

Vertical

	Freq	Level	Limit Line	Over Limit	Read Level	Cable Loss	Preamp Factor	Antenna Factor	T/Pos	A/Pos	Remark	Pol/Phase
	MHz	dBuV/m	dBuV/m	dB	dBuV	dB	dB	dB/m	deg	cm		
1 p	2732.46	65.73	74.00	-8.27	69.83	2.24	34.74	28.40	128	100	Peak	VERTICAL
2 a	2734.32	50.00	54.00	-4.00	54.10	2.24	34.74	28.40	128	100	Average	VERTICAL

Temperature	23°C	Humidity	65%
Test Engineer	Allen Liu	Configurations	DSSS – 917 MHz/CH 3/ 10M / Mode 1
Test Date	Apr. 23, 2011		

Horizontal

	Freq	Level	Limit Line	Over Limit	Read Level	Cable Loss	Preamp Factor	Antenna Factor	T/Pos	A/Pos	Remark	Pol/Phase
	MHz	dBuV/m	dBuV/m	dB	dBuV	dB	dB	dB/m	deg	cm		
1 a	2752.28	45.78	54.00	-8.22	49.81	2.26	34.74	28.45	173	100	Average	HORIZONTAL
2 p	2753.04	59.67	74.00	-14.33	63.70	2.26	34.74	28.45	173	100	Peak	HORIZONTAL

Vertical

	Freq	Level	Limit Line	Over Limit	Read Level	Cable Loss	Preamp Factor	Antenna Factor	T/Pos	A/Pos	Remark	Pol/Phase
	MHz	dBuV/m	dBuV/m	dB	dBuV	dB	dB	dB/m	deg	cm		
1 p	2752.34	62.84	74.00	-11.16	66.87	2.26	34.74	28.45	127	130	Peak	VERTICAL
2 a	2752.84	49.06	54.00	-4.94	53.09	2.26	34.74	28.45	127	130	Average	VERTICAL

Temperature	23°C	Humidity	65%
Test Engineer	Allen Liu	Configurations	DSSS – 922 MHz/CH 4 / 10M / Mode 1
Test Date	Apr. 23, 2011		

Horizontal

	Freq	Level	Limit	Over	Read	Cable	Preamp	Antenna	T/Pos	A/Pos	Remark	Pol/Phase
	MHz	dBuV/m	dBuV/m	dB	dBuV	dB	dB	dB/m	deg	cm		
1 p	2767.06	57.17	74.00	-16.83	61.15	2.26	34.74	28.50	307	100	Peak	HORIZONTAL
2 a	2767.38	43.46	54.00	-10.54	47.44	2.26	34.74	28.50	307	100	Average	HORIZONTAL

Vertical

	Freq	Level	Limit	Over	Read	Cable	Preamp	Antenna	T/Pos	A/Pos	Remark	Pol/Phase
	MHz	dBuV/m	dBuV/m	dB	dBuV	dB	dB	dB/m	deg	cm		
1 p	2762.12	66.81	74.00	-7.19	70.79	2.26	34.74	28.50	159	170	Peak	VERTICAL
2 a	2767.12	52.54	54.00	-1.46	56.52	2.26	34.74	28.50	159	170	Average	VERTICAL

Temperature	23°C	Humidity	65%
Test Engineer	Allen Liu	Configurations	DSSS – 912 MHz/CH 2 / 20M / Mode 1
Test Date	Apr. 23, 2011		

Horizontal

	Freq	Level	Limit	Over	Read	Cable	Preamp	Antenna	T/Pos	A/Pos	Remark	Pol/Phase
	MHz	dBuV/m	dBuV/m	dB	dBuV	dB	dB	dB/m	deg	cm		
1 p	2723.35	57.88	74.00	-16.12	62.03	2.24	34.74	28.35	217	100	Peak	HORIZONTAL
2 a	2725.85	42.50	54.00	-11.50	46.60	2.24	34.74	28.40	217	100	Average	HORIZONTAL

Vertical

	Freq	Level	Limit	Over	Read	Cable	Preamp	Antenna	T/Pos	A/Pos	Remark	Pol/Phase
	MHz	dBuV/m	dBuV/m	dB	dBuV	dB	dB	dB/m	deg	cm		
1 p	2716.95	63.89	74.00	-10.11	68.06	2.23	34.75	28.35	127	100	Peak	VERTICAL
2 a	2729.60	48.47	54.00	-5.53	52.57	2.24	34.74	28.40	127	100	Average	VERTICAL

Temperature	23°C	Humidity	65%
Test Engineer	Allen Liu	Configurations	DSSS – 917 MHz/CH 3 / 20M / Mode 1
Test Date	Apr. 23, 2011		

Horizontal

	Freq	Level	Limit Line	Over Limit	Read Level	Cable Loss	Preamp Factor	Antenna Factor	T/Pos	A/Pos	Remark	Pol/Phase
	MHz	dBuV/m	dBuV/m	dB	dBuV	dB	dB	dB/m	deg	cm		
1 p	2752.00	56.04	74.00	-17.96	60.07	2.26	34.74	28.45	172	100	Peak	HORIZONTAL
2 a	2753.20	42.89	54.00	-11.11	46.92	2.26	34.74	28.45	172	100	Average	HORIZONTAL

Vertical

	Freq	Level	Limit Line	Over Limit	Read Level	Cable Loss	Preamp Factor	Antenna Factor	T/Pos	A/Pos	Remark	Pol/Phase
	MHz	dBuV/m	dBuV/m	dB	dBuV	dB	dB	dB/m	deg	cm		
1 p	2750.80	63.28	74.00	-10.72	67.31	2.26	34.74	28.45	243	160	Peak	VERTICAL
2 a	2755.00	49.80	54.00	-4.20	53.83	2.26	34.74	28.45	243	160	Average	VERTICAL

Temperature	23°C	Humidity	65%
Test Engineer	Allen Liu	Configurations	OFDM – 907 MHz/CH 1 / 5M / Mode 1
Test Date	Apr. 23, 2011		

Horizontal

	Freq	Level	Limit Line	Over Limit	Read Level	Cable Loss	Preamp Factor	Antenna Factor	T/Pos	A/Pos	Remark	Pol/Phase
	MHz	dBuV/m	dBuV/m	dB	dBuV	dB	dB	dB/m	deg	cm		
1 p	2720.01	62.94	74.00	-11.06	67.11	2.23	34.75	28.35	151	100	Peak	HORIZONTAL
2 a	2720.33	49.86	54.00	-4.14	54.03	2.23	34.75	28.35	151	100	Average	HORIZONTAL

Vertical

	Freq	Level	Limit Line	Over Limit	Read Level	Cable Loss	Preamp Factor	Antenna Factor	T/Pos	A/Pos	Remark	Pol/Phase
	MHz	dBuV/m	dBuV/m	dB	dBuV	dB	dB	dB/m	deg	cm		
1 a	2720.32	53.79	54.00	-0.21	57.96	2.23	34.75	28.35	326	100	Average	VERTICAL
2 p	2720.34	58.39	74.00	-15.61	62.56	2.23	34.75	28.35	326	100	Peak	VERTICAL

Temperature	23°C	Humidity	65%
Test Engineer	Allen Liu	Configurations	OFDM - 912MHz/CH 2/ 5M/ Mode 1
Test Date	Apr. 23, 2011		

Horizontal

	Freq	Level	Limit	Over	Read	Cable	Preamp	Antenna	T/Pos	A/Pos	Remark	Pol/Phase
	MHz	dBuV/m	dBuV/m	dB	dBuV	dB	dB	dB/m	deg	cm		
1 a	2735.33	50.63	54.00	-3.37	54.73	2.24	34.74	28.40	217	138	Average	HORIZONTAL
2 p	2735.88	55.90	74.00	-18.10	60.00	2.24	34.74	28.40	217	138	Peak	HORIZONTAL

Vertical

	Freq	Level	Limit	Over	Read	Cable	Preamp	Antenna	T/Pos	A/Pos	Remark	Pol/Phase
	MHz	dBuV/m	dBuV/m	dB	dBuV	dB	dB	dB/m	deg	cm		
1 a	2736.69	53.34	54.00	-0.66	57.44	2.24	34.74	28.40	47	166	Average	VERTICAL
2 p	2737.44	60.90	74.00	-13.10	65.00	2.24	34.74	28.40	47	166	Peak	VERTICAL

Temperature	23°C	Humidity	65%
Test Engineer	Allen Liu	Configurations	OFDM - 917MHz/CH 3/ 5M/ Mode 1
Test Date	Apr. 23, 2011		

Horizontal

	Freq	Level	Limit Line	Over Limit	Read Level	Cable Loss	Preamp Factor	Antenna Factor	T/Pos	A/Pos	Remark	Pol/Phase
	MHz	dBuV/m	dBuV/m	dB	dBuV	dB	dB	dB/m	deg	cm		
1 a	2751.69	50.67	54.00	-3.33	54.70	2.26	34.74	28.45	172	100	Average	HORIZONTAL
2 p	2752.12	55.64	74.00	-18.36	59.67	2.26	34.74	28.45	172	100	Peak	HORIZONTAL

Vertical

	Freq	Level	Limit Line	Over Limit	Read Level	Cable Loss	Preamp Factor	Antenna Factor	T/Pos	A/Pos	Remark	Pol/Phase
	MHz	dBuV/m	dBuV/m	dB	dBuV	dB	dB	dB/m	deg	cm		
1 a	2751.69	51.71	54.00	-2.29	55.74	2.26	34.74	28.45	95	131	Average	VERTICAL
2 p	2751.71	57.76	74.00	-16.24	61.79	2.26	34.74	28.45	95	131	Peak	VERTICAL

Temperature	23°C	Humidity	65%
Test Engineer	Allen Liu	Configurations	OFDM – 922 MHz/CH 4/ 5M / Mode 1
Test Date	Apr. 23, 2011		

Horizontal

	Freq	Level	Limit Line	Over Limit	Read Level	Cable Loss	Preamp Factor	Antenna Factor	T/Pos	A/Pos	Remark	Pol/Phase
	MHz	dBuV/m	dBuV/m	dB	dBuV	dB	dB	dB/m	deg	cm		
1 p	2766.16	53.81	74.00	-20.19	57.79	2.26	34.74	28.50	305	100	Peak	HORIZONTAL
2 a	2766.68	47.69	54.00	-6.31	51.67	2.26	34.74	28.50	305	100	Average	HORIZONTAL

Vertical

	Freq	Level	Limit Line	Over Limit	Read Level	Cable Loss	Preamp Factor	Antenna Factor	T/Pos	A/Pos	Remark	Pol/Phase
	MHz	dBuV/m	dBuV/m	dB	dBuV	dB	dB	dB/m	deg	cm		
1 p	2765.98	57.99	74.00	-16.01	61.97	2.26	34.74	28.50	222	130	Peak	VERTICAL
2 a	2766.69	53.37	54.00	-0.63	57.35	2.26	34.74	28.50	222	130	Average	VERTICAL

Temperature	23°C	Humidity	65%
Test Engineer	Allen Liu	Configurations	OFDM – 907 MHz/CH 1/ 10M / Mode 1
Test Date	Apr. 23, 2011		

Horizontal

	Freq	Level	Limit	Over	Read	Cable	Preamp	Antenna	T/Pos	A/Pos	Remark	Pol/Phase
	MHz	dBuV/m	dBuV/m	dB	dBuV	dB	dB	dB/m	deg	cm		
1 a	2718.64	45.54	54.00	-8.46	49.71	2.23	34.75	28.35	152	100	Average	HORIZONTAL
2 p	2718.67	58.13	74.00	-15.87	62.30	2.23	34.75	28.35	152	100	Peak	HORIZONTAL

Vertical

	Freq	Level	Limit	Over	Read	Cable	Preamp	Antenna	T/Pos	A/Pos	Remark	Pol/Phase
	MHz	dBuV/m	dBuV/m	dB	dBuV	dB	dB	dB/m	deg	cm		
1 p	2719.02	57.03	74.00	-16.97	61.20	2.23	34.75	28.35	324	148	Peak	VERTICAL
2 a	2719.68	52.05	54.00	-1.95	56.22	2.23	34.75	28.35	324	148	Average	VERTICAL

Temperature	23°C	Humidity	65%
Test Engineer	Allen Liu	Configurations	OFDM – 912 MHz/CH 2/ 10M / Mode 1
Test Date	Apr. 23, 2011		

Horizontal

	Freq	Level	Limit	Over	Read	Cable	Preamp	Antenna	T/Pos	A/Pos	Remark	Pol/Phase
	MHz	dBuV/m	dBuV/m	dB	dBuV	dB	dB	dB/m	deg	cm		
1 a	2734.67	48.42	54.00	-5.58	52.52	2.24	34.74	28.40	173	100	Average	HORIZONTAL
2 p	2736.77	55.58	74.00	-18.42	59.68	2.24	34.74	28.40	173	100	Peak	HORIZONTAL

Vertical

	Freq	Level	Limit	Over	Read	Cable	Preamp	Antenna	T/Pos	A/Pos	Remark	Pol/Phase
	MHz	dBuV/m	dBuV/m	dB	dBuV	dB	dB	dB/m	deg	cm		
1 a	2734.66	52.49	54.00	-1.51	56.59	2.24	34.74	28.40	128	100	Average	VERTICAL
2 p	2737.77	61.59	74.00	-12.41	65.69	2.24	34.74	28.40	128	100	Peak	VERTICAL

Temperature	23°C	Humidity	65%
Test Engineer	Allen Liu	Configurations	OFDM – 917 MHz/CH 3/ 10M / Mode 1
Test Date	Apr. 23, 2011		

Horizontal

	Freq	Level	Limit Line	Over Limit	Read Level	Cable Loss	Preamp Factor	Antenna Factor	T/Pos	A/Pos	Remark	Pol/Phase
	MHz	dBuV/m	dBuV/m	dB	dBuV	dB	dB	dB/m	deg	cm		
1 p	2751.49	54.63	74.00	-19.37	58.66	2.26	34.74	28.45	174	100	Peak	HORIZONTAL
2 a	2752.34	49.74	54.00	-4.26	53.77	2.26	34.74	28.45	174	100	Average	HORIZONTAL

Vertical

	Freq	Level	Limit Line	Over Limit	Read Level	Cable Loss	Preamp Factor	Antenna Factor	T/Pos	A/Pos	Remark	Pol/Phase
	MHz	dBuV/m	dBuV/m	dB	dBuV	dB	dB	dB/m	deg	cm		
1 p	2751.69	60.60	74.00	-13.40	64.63	2.26	34.74	28.45	242	160	Peak	VERTICAL
2 a	2752.34	53.86	54.00	-0.14	57.89	2.26	34.74	28.45	242	160	Average	VERTICAL

Temperature	23°C	Humidity	65%
Test Engineer	Allen Liu	Configurations	OFDM – 922 MHz/CH 4 / 10M / Mode 1
Test Date	Apr. 23, 2011		

Horizontal

	Freq	Level	Limit	Over	Read	Cable	Preamp	Antenna	T/Pos	A/Pos	Remark	Pol/Phase
	MHz	dBuV/m	dBuV/m	dB	dBuV	dB	dB	dB/m	deg	cm		
1 p	2766.55	52.40	74.00	-21.60	56.38	2.26	34.74	28.50	307	100	Peak	HORIZONTAL
2 a	2767.35	46.59	54.00	-7.41	50.57	2.26	34.74	28.50	307	100	Average	HORIZONTAL

Vertical

	Freq	Level	Limit	Over	Read	Cable	Preamp	Antenna	T/Pos	A/Pos	Remark	Pol/Phase
	MHz	dBuV/m	dBuV/m	dB	dBuV	dB	dB	dB/m	deg	cm		
1 p	2765.67	59.17	74.00	-14.83	63.15	2.26	34.74	28.50	180	167	Peak	VERTICAL
2 a	2767.33	52.79	54.00	-1.21	56.77	2.26	34.74	28.50	180	167	Average	VERTICAL



Temperature	23°C	Humidity	65%
Test Engineer	Allen Liu	Configurations	OFDM – 912 MHz/CH 2 / 20M / Mode 1
Test Date	Apr. 23, 2011		

Horizontal

	Freq	Level	Limit Line	Over Limit	Read Level	Cable Loss	Preamp Factor	Antenna Factor	T/Pos	A/Pos	Remark	Pol/Phase
	MHz	dBuV/m	dBuV/m	dB	dBuV	dB	dB	dB/m	deg	cm		
1 p	2731.30	56.21	74.00	-17.79	60.31	2.24	34.74	28.40	215	157	Peak	HORIZONTAL
2 a	2732.28	48.18	54.00	-5.82	52.28	2.24	34.74	28.40	215	157	Average	HORIZONTAL

Vertical

	Freq	Level	Limit Line	Over Limit	Read Level	Cable Loss	Preamp Factor	Antenna Factor	T/Pos	A/Pos	Remark	Pol/Phase
	MHz	dBuV/m	dBuV/m	dB	dBuV	dB	dB	dB/m	deg	cm		
1 p	2731.92	60.43	74.00	-13.57	64.53	2.24	34.74	28.40	127	100	Peak	VERTICAL
2 a	2732.28	52.02	54.00	-1.98	56.12	2.24	34.74	28.40	127	100	Average	VERTICAL

Temperature	23°C	Humidity	65%
Test Engineer	Allen Liu	Configurations	OFDM- 917 MHz/CH 3 / 20M / Mode 1
Test Date	Apr. 23, 2011		

Horizontal

	Freq	Level	Limit	Over	Read	Cable	Preamp	Antenna	T/Pos	A/Pos	Remark	Pol/Phase
	MHz	dBuV/m	dBuV/m	dB	dBuV	dB	dB	dB/m	deg	cm		
1 a	2752.77	48.81	54.00	-5.19	52.84	2.26	34.74	28.45	173	100	Average	HORIZONTAL
2 p	2753.52	53.32	74.00	-20.68	57.35	2.26	34.74	28.45	173	100	Peak	HORIZONTAL

Vertical

	Freq	Level	Limit	Over	Read	Cable	Preamp	Antenna	T/Pos	A/Pos	Remark	Pol/Phase
	MHz	dBuV/m	dBuV/m	dB	dBuV	dB	dB	dB/m	deg	cm		
1 p	2753.57	58.47	74.00	-15.53	62.50	2.26	34.74	28.45	206	120	Peak	VERTICAL
2 a	2753.78	53.08	54.00	-0.92	57.11	2.26	34.74	28.45	206	120	Average	VERTICAL

Note:

The amplitude of spurious emissions that are attenuated by more than 20dB below the permissible value has no need to be reported.

Emission level (dBuV/m) = 20 log Emission level (uV/m).

Corrected Reading: Antenna Factor + Cable Loss + Read Level - Preamp Factor = Level.

Temperature	23°C	Humidity	65%
Test Engineer	Allen Liu	Configurations	DSSS - 907MHz/CH 1/ 5M/ Mode 2
Test Date	Apr. 23, 2011		

Horizontal

	Freq	Level	Limit Line	Over Limit	Read Level	Cable Loss	Preamp Factor	Antenna Factor	T/Pos	A/Pos	Remark	Pol/Phase
	MHz	dBuV/m	dBuV/m	dB	dBuV	dB	dB	dB/m	deg	cm		
1 a	2721.73	52.94	54.00	-1.06	57.09	2.24	34.74	28.35	325	100	Average	HORIZONTAL
2 p	2722.13	72.38	74.00	-1.62	76.53	2.24	34.74	28.35	325	100	Peak	HORIZONTAL

Vertical

	Freq	Level	Limit Line	Over Limit	Read Level	Cable Loss	Preamp Factor	Antenna Factor	T/Pos	A/Pos	Remark	Pol/Phase
	MHz	dBuV/m	dBuV/m	dB	dBuV	dB	dB	dB/m	deg	cm		
1 p	2720.07	63.48	74.00	-10.52	67.65	2.23	34.75	28.35	272	105	Peak	VERTICAL
2 a	2721.49	46.70	54.00	-7.30	50.85	2.24	34.74	28.35	272	105	Average	VERTICAL



Temperature	23°C	Humidity	65%
Test Engineer	Allen Liu	Configurations	DSSS - 912MHz/CH 2/ 5M/ Mode 2
Test Date	Apr. 23, 2011		

Horizontal

	Freq	Level	Limit Line	Over Limit	Read Level	Cable Loss	Preamp Factor	Antenna Factor	T/Pos	A/Pos	Remark	Pol/Phase
	MHz	dBuV/m	dBuV/m	dB	dBuV	dB	dB	dB/m	deg	cm		
1 p	2733.12	72.70	74.00	-1.30	76.80	2.24	34.74	28.40	307	116	Peak	HORIZONTAL
2 a	2735.84	53.36	54.00	-0.64	57.46	2.24	34.74	28.40	307	116	Average	HORIZONTAL

Vertical

	Freq	Level	Limit Line	Over Limit	Read Level	Cable Loss	Preamp Factor	Antenna Factor	T/Pos	A/Pos	Remark	Pol/Phase
	MHz	dBuV/m	dBuV/m	dB	dBuV	dB	dB	dB/m	deg	cm		
1 a	2736.09	45.89	54.00	-8.11	49.99	2.24	34.74	28.40	272	105	Average	VERTICAL
2 p	2736.23	63.39	74.00	-10.61	67.49	2.24	34.74	28.40	272	105	Peak	VERTICAL

Temperature	23°C	Humidity	65%
Test Engineer	Allen Liu	Configurations	DSSS - 917MHz/CH 3/ 5M/ Mode 2
Test Date	Apr. 23, 2011		

Horizontal

	Freq	Level	Limit Line	Over Limit	Read Level	Cable Loss	Preamp Factor	Antenna Factor	T/Pos	A/Pos	Remark	Pol/Phase
	MHz	dBuV/m	dBuV/m	dB	dBuV	dB	dB	dB/m	deg	cm		
1 a	2750.45	52.71	54.00	-1.29	56.74	2.26	34.74	28.45	325	100	Average	HORIZONTAL
2 p	2754.61	71.36	74.00	-2.64	75.39	2.26	34.74	28.45	325	100	Peak	HORIZONTAL

Vertical

	Freq	Level	Limit Line	Over Limit	Read Level	Cable Loss	Preamp Factor	Antenna Factor	T/Pos	A/Pos	Remark	Pol/Phase
	MHz	dBuV/m	dBuV/m	dB	dBuV	dB	dB	dB/m	deg	cm		
1 p	2748.00	64.12	74.00	-9.88	68.15	2.26	34.74	28.45	271	101	Peak	VERTICAL
2 a	2750.70	47.09	54.00	-6.91	51.12	2.26	34.74	28.45	271	101	Average	VERTICAL

Temperature	23°C	Humidity	65%
Test Engineer	Allen Liu	Configurations	DSSS – 922 MHz/CH 4/ 5M / Mode 2
Test Date	Apr. 23, 2011		

Horizontal

	Freq	Level	Limit Line	Over Limit	Read Level	Cable Loss	Preamp Factor	Antenna Factor	T/Pos	A/Pos	Remark	Pol/Phase
	MHz	dBuV/m	dBuV/m	dB	dBuV	dB	dB	dB/m	deg	cm		
1 p	2764.81	72.05	74.00	-1.95	76.03	2.26	34.74	28.50	323	100	Peak	HORIZONTAL
2 a	2765.79	53.12	54.00	-0.88	57.10	2.26	34.74	28.50	323	100	Average	HORIZONTAL

Vertical

	Freq	Level	Limit Line	Over Limit	Read Level	Cable Loss	Preamp Factor	Antenna Factor	T/Pos	A/Pos	Remark	Pol/Phase
	MHz	dBuV/m	dBuV/m	dB	dBuV	dB	dB	dB/m	deg	cm		
1 a	2765.84	48.20	54.00	-5.80	52.18	2.26	34.74	28.50	271	100	Average	VERTICAL
2 p	2768.55	63.60	74.00	-10.40	67.58	2.26	34.74	28.50	271	100	Peak	VERTICAL

Temperature	23°C	Humidity	65%
Test Engineer	Allen Liu	Configurations	DSSS – 907 MHz/CH 1/ 10M / Mode 2
Test Date	Apr. 23, 2011		

Horizontal

	Freq	Level	Limit Line	Over Limit	Read Level	Cable Loss	Preamp Factor	Antenna Factor	T/Pos	A/Pos	Remark	Pol/Phase
	MHz	dBuV/m	dBuV/m	dB	dBuV	dB	dB	dB/m	deg	cm		
1 a	2723.02	53.85	54.00	-0.15	58.00	2.24	34.74	28.35	321	100	Average	HORIZONTAL
2 p	2726.60	71.21	74.00	-2.79	75.31	2.24	34.74	28.40	321	100	Peak	HORIZONTAL

Vertical

	Freq	Level	Limit Line	Over Limit	Read Level	Cable Loss	Preamp Factor	Antenna Factor	T/Pos	A/Pos	Remark	Pol/Phase
	MHz	dBuV/m	dBuV/m	dB	dBuV	dB	dB	dB/m	deg	cm		
1 a	2722.92	44.77	54.00	-9.23	48.92	2.24	34.74	28.35	58	100	Average	VERTICAL
2 p	2728.08	57.43	74.00	-16.57	61.53	2.24	34.74	28.40	58	100	Peak	VERTICAL

Temperature	23°C	Humidity	65%
Test Engineer	Allen Liu	Configurations	DSSS – 912 MHz/CH 2/ 10M / Mode 2
Test Date	Apr. 23, 2011		

Horizontal

	Freq	Level	Limit Line	Over Limit	Read Level	Cable Loss	Preamp Factor	Antenna Factor	T/Pos	A/Pos	Remark	Pol/Phase
	MHz	dBuV/m	dBuV/m	dB	dBuV	dB	dB	dB/m	deg	cm		
1 a	2735.38	53.05	54.00	-0.95	57.15	2.24	34.74	28.40	323	100	Average	HORIZONTAL
2 p	2736.98	69.30	74.00	-4.70	73.40	2.24	34.74	28.40	323	100	Peak	HORIZONTAL

Vertical

	Freq	Level	Limit Line	Over Limit	Read Level	Cable Loss	Preamp Factor	Antenna Factor	T/Pos	A/Pos	Remark	Pol/Phase
	MHz	dBuV/m	dBuV/m	dB	dBuV	dB	dB	dB/m	deg	cm		
1 a	2737.70	44.36	54.00	-9.64	48.46	2.24	34.74	28.40	13	100	Average	VERTICAL
2 p	2739.94	63.13	74.00	-10.87	67.23	2.24	34.74	28.40	13	100	Peak	VERTICAL

Temperature	23°C	Humidity	65%
Test Engineer	Allen Liu	Configurations	DSSS – 917 MHz/CH 3/ 10M / Mode 2
Test Date	Apr. 23, 2011		

Horizontal

	Freq	Level	Limit Line	Over Limit	Read Level	Cable Loss	Preamp Factor	Antenna Factor	T/Pos	A/Pos	Remark	Pol/Phase
	MHz	dBuV/m	dBuV/m	dB	dBuV	dB	dB	dB/m	deg	cm		
1 p	2743.18	70.58	74.00	-3.42	74.63	2.24	34.74	28.45	321	100	Peak	HORIZONTAL
2 a	2749.10	53.30	54.00	-0.70	57.33	2.26	34.74	28.45	321	100	Average	HORIZONTAL

Vertical

	Freq	Level	Limit Line	Over Limit	Read Level	Cable Loss	Preamp Factor	Antenna Factor	T/Pos	A/Pos	Remark	Pol/Phase
	MHz	dBuV/m	dBuV/m	dB	dBuV	dB	dB	dB/m	deg	cm		
1 p	2752.06	64.56	74.00	-9.44	68.59	2.26	34.74	28.45	321	100	Peak	VERTICAL
2 a	2752.14	44.41	54.00	-9.59	48.44	2.26	34.74	28.45	321	100	Average	VERTICAL

Temperature	23°C	Humidity	65%
Test Engineer	Allen Liu	Configurations	DSSS – 922 MHz/CH 4 / 10M / Mode 2
Test Date	Apr. 23, 2011		

Horizontal

	Freq	Level	Limit Line	Over Limit	Read Level	Cable Loss	Preamp Factor	Antenna Factor	T/Pos	A/Pos	Remark	Pol/Phase
	MHz	dBuV/m	dBuV/m	dB	dBuV	dB	dB	dB/m	deg	cm		
1 a	2765.16	53.42	54.00	-0.58	57.40	2.26	34.74	28.50	320	100	Average	HORIZONTAL
2 p	2765.26	70.48	74.00	-3.52	74.46	2.26	34.74	28.50	320	100	Peak	HORIZONTAL

Vertical

	Freq	Level	Limit Line	Over Limit	Read Level	Cable Loss	Preamp Factor	Antenna Factor	T/Pos	A/Pos	Remark	Pol/Phase
	MHz	dBuV/m	dBuV/m	dB	dBuV	dB	dB	dB/m	deg	cm		
1 a	2766.00	49.07	54.00	-4.93	53.05	2.26	34.74	28.50	236	100	Average	VERTICAL
2 p	2767.84	65.81	74.00	-8.19	69.79	2.26	34.74	28.50	236	100	Peak	VERTICAL

Temperature	23°C	Humidity	65%
Test Engineer	Allen Liu	Configurations	DSSS – 912 MHz/CH 2 / 20M / Mode 2
Test Date	Apr. 23, 2011		

Horizontal

	Freq	Level	Limit	Over	Read	Cable	Preamp	Antenna	T/Pos	A/Pos	Remark	Pol/Phase
	MHz	dBuV/m	dBuV/m	dB	dBuV	dB	dB	dB/m	deg	cm		
1 a	2735.35	53.59	54.00	-0.41	57.69	2.24	34.74	28.40	33	100	Average	HORIZONTAL
2 p	2737.05	68.18	74.00	-5.82	72.28	2.24	34.74	28.40	33	100	Peak	HORIZONTAL

Vertical

	Freq	Level	Limit	Over	Read	Cable	Preamp	Antenna	T/Pos	A/Pos	Remark	Pol/Phase
	MHz	dBuV/m	dBuV/m	dB	dBuV	dB	dB	dB/m	deg	cm		
1 a	2737.75	48.40	54.00	-5.60	52.50	2.24	34.74	28.40	236	100	Average	VERTICAL
2 p	2739.55	61.56	74.00	-12.44	65.66	2.24	34.74	28.40	236	100	Peak	VERTICAL

Temperature	23°C	Humidity	65%
Test Engineer	Allen Liu	Configurations	DSSS – 917 MHz/CH 3 / 20M / Mode 2
Test Date	Apr. 23, 2011		

Horizontal

	Freq	Level	Limit	Over	Read	Cable	Preamp	Antenna	T/Pos	A/Pos	Remark	Pol/Phase
	MHz	dBuV/m	dBuV/m	dB	dBuV	dB	dB	dB/m	deg	cm		
1 a	2735.35	53.59	54.00	-0.41	57.69	2.24	34.74	28.40	33	100	Average	HORIZONTAL
2 p	2737.05	68.18	74.00	-5.82	72.28	2.24	34.74	28.40	33	100	Peak	HORIZONTAL

Vertical

	Freq	Level	Limit	Over	Read	Cable	Preamp	Antenna	T/Pos	A/Pos	Remark	Pol/Phase
	MHz	dBuV/m	dBuV/m	dB	dBuV	dB	dB	dB/m	deg	cm		
1 a	2737.75	48.40	54.00	-5.60	52.50	2.24	34.74	28.40	236	100	Average	VERTICAL
2 p	2739.55	61.56	74.00	-12.44	65.66	2.24	34.74	28.40	236	100	Peak	VERTICAL

Note:

The amplitude of spurious emissions that are attenuated by more than 20dB below the permissible value has no need to be reported.

Emission level (dBuV/m) = 20 log Emission level (uV/m).

Corrected Reading: Antenna Factor + Cable Loss + Read Level - Preamp Factor = Level.

Temperature	23°C	Humidity	65%
Test Engineer	Allen Liu	Configurations	OFDM – 907 MHz/CH 1 / 5M / Mode 2
Test Date	Apr. 23, 2011		

Horizontal

	Freq	Level	Limit Line	Over Limit	Read Level	Cable Loss	Preamp Factor	Antenna Factor	T/Pos	A/Pos	Remark	Pol/Phase
	MHz	dBuV/m	dBuV/m	dB	dBuV	dB	dB	dB/m	deg	cm		
1 a	2721.50	53.96	54.00	-0.04	58.11	2.24	34.74	28.35	325	100	Average	HORIZONTAL
2 p	2722.31	64.04	74.00	-9.96	68.19	2.24	34.74	28.35	325	100	Peak	HORIZONTAL

Vertical

	Freq	Level	Limit Line	Over Limit	Read Level	Cable Loss	Preamp Factor	Antenna Factor	T/Pos	A/Pos	Remark	Pol/Phase
	MHz	dBuV/m	dBuV/m	dB	dBuV	dB	dB	dB/m	deg	cm		
1 p	2720.86	57.90	74.00	-16.10	62.07	2.23	34.75	28.35	270	100	Peak	VERTICAL
2 a	2721.54	46.67	54.00	-7.33	50.82	2.24	34.74	28.35	270	100	Average	VERTICAL

Temperature	23°C	Humidity	65%
Test Engineer	Allen Liu	Configurations	OFDM - 912MHz/CH 2/ 5M/ Mode 2
Test Date	Apr. 23, 2011		

Horizontal

	Freq	Level	Limit Line	Over Limit	Read Level	Cable Loss	Preamp Factor	Antenna Factor	T/Pos	A/Pos	Remark	Pol/Phase
	MHz	dBuV/m	dBuV/m	dB	dBuV	dB	dB	dB/m	deg	cm		
1 a	2735.43	52.15	54.00	-1.85	56.25	2.24	34.74	28.40	322	100	Average	HORIZONTAL
2 p	2736.00	62.66	74.00	-11.34	66.76	2.24	34.74	28.40	322	100	Peak	HORIZONTAL

Vertical

	Freq	Level	Limit Line	Over Limit	Read Level	Cable Loss	Preamp Factor	Antenna Factor	T/Pos	A/Pos	Remark	Pol/Phase
	MHz	dBuV/m	dBuV/m	dB	dBuV	dB	dB	dB/m	deg	cm		
1 p	2720.86	57.90	74.00	-16.10	62.07	2.23	34.75	28.35	270	100	Peak	VERTICAL
2 a	2721.54	46.67	54.00	-7.33	50.82	2.24	34.74	28.35	270	100	Average	VERTICAL



Temperature	23°C	Humidity	65%
Test Engineer	Allen Liu	Configurations	OFDM - 917MHz/CH 3/ 5M/ Mode 2
Test Date	Apr. 23, 2011		

Horizontal

	Freq	Level	Limit Line	Over Limit	Read Level	Cable Loss	Preamp Factor	Antenna Factor	T/Pos	A/Pos	Remark	Pol/Phase
	MHz	dBuV/m	dBuV/m	dB	dBuV	dB	dB	dB/m	deg	cm		
1 a	2735.43	52.15	54.00	-1.85	56.25	2.24	34.74	28.40	322	100	Average	HORIZONTAL
2 p	2736.00	62.66	74.00	-11.34	66.76	2.24	34.74	28.40	322	100	Peak	HORIZONTAL

Vertical

	Freq	Level	Limit Line	Over Limit	Read Level	Cable Loss	Preamp Factor	Antenna Factor	T/Pos	A/Pos	Remark	Pol/Phase
	MHz	dBuV/m	dBuV/m	dB	dBuV	dB	dB	dB/m	deg	cm		
1 p	2736.05	55.88	74.00	-18.12	59.98	2.24	34.74	28.40	272	100	Peak	VERTICAL
2 a	2736.56	46.04	54.00	-7.96	50.14	2.24	34.74	28.40	272	100	Average	VERTICAL

Temperature	23°C	Humidity	65%
Test Engineer	Allen Liu	Configurations	OFDM – 922 MHz/CH 4/ 5M / Mode 2
Test Date	Apr. 23, 2011		

Horizontal

	Freq	Level	Limit	Over	Read	Cable	Preamp	Antenna	T/Pos	A/Pos	Remark	Pol/Phase
	MHz	dBuV/m	dBuV/m	dB	dBuV	dB	dB	dB/m	deg	cm		
1 a	2750.44	52.51	54.00	-1.49	56.54	2.26	34.74	28.45	320	100	Average	HORIZONTAL
2 p	2750.78	62.64	74.00	-11.36	66.67	2.26	34.74	28.45	320	100	Peak	HORIZONTAL

Vertical

	Freq	Level	Limit	Over	Read	Cable	Preamp	Antenna	T/Pos	A/Pos	Remark	Pol/Phase
	MHz	dBuV/m	dBuV/m	dB	dBuV	dB	dB	dB/m	deg	cm		
1 a	2750.47	47.82	54.00	-6.18	51.85	2.26	34.74	28.45	272	100	Average	VERTICAL
2 p	2750.97	57.15	74.00	-16.85	61.18	2.26	34.74	28.45	272	100	Peak	VERTICAL

Temperature	23°C	Humidity	65%
Test Engineer	Allen Liu	Configurations	OFDM – 907 MHz/CH 1/ 10M / Mode 2
Test Date	Apr. 23, 2011		

Horizontal

	Freq	Level	Limit Line	Over Limit	Read Level	Cable Loss	Preamp Factor	Antenna Factor	T/Pos	A/Pos	Remark	Pol/Phase
	MHz	dBuV/m	dBuV/m	dB	dBuV	dB	dB	dB/m	deg	cm		
1 a	2722.00	53.05	54.00	-0.95	57.20	2.24	34.74	28.35	326	100	Average	HORIZONTAL
2 p	2722.14	64.19	74.00	-9.81	68.34	2.24	34.74	28.35	326	100	Peak	HORIZONTAL

Vertical

	Freq	Level	Limit Line	Over Limit	Read Level	Cable Loss	Preamp Factor	Antenna Factor	T/Pos	A/Pos	Remark	Pol/Phase
	MHz	dBuV/m	dBuV/m	dB	dBuV	dB	dB	dB/m	deg	cm		
1 a	2722.16	43.86	54.00	-10.14	48.01	2.24	34.74	28.35	262	104	Average	VERTICAL
2 p	2722.18	53.12	74.00	-20.88	57.27	2.24	34.74	28.35	262	104	Peak	VERTICAL

Temperature	23°C	Humidity	65%
Test Engineer	Allen Liu	Configurations	OFDM – 912 MHz/CH 2/ 10M / Mode 2
Test Date	Apr. 23, 2011		

Horizontal

	Freq	Level	Limit Line	Over Limit	Read Level	Cable Loss	Preamp Factor	Antenna Factor	T/Pos	A/Pos	Remark	Pol/Phase
	MHz	dBuV/m	dBuV/m	dB	dBuV	dB	dB	dB/m	deg	cm		
1 a	2734.42	52.66	54.00	-1.34	56.76	2.24	34.74	28.40	27	100	Average	HORIZONTAL
2 p	2735.06	63.71	74.00	-10.29	67.81	2.24	34.74	28.40	27	100	Peak	HORIZONTAL

Vertical

	Freq	Level	Limit Line	Over Limit	Read Level	Cable Loss	Preamp Factor	Antenna Factor	T/Pos	A/Pos	Remark	Pol/Phase
	MHz	dBuV/m	dBuV/m	dB	dBuV	dB	dB	dB/m	deg	cm		
1 p	2735.80	55.15	74.00	-18.85	59.25	2.24	34.74	28.40	270	100	Peak	VERTICAL
2 a	2737.00	44.95	54.00	-9.05	49.05	2.24	34.74	28.40	270	100	Average	VERTICAL

Temperature	23°C	Humidity	65%
Test Engineer	Allen Liu	Configurations	OFDM – 917 MHz/CH 3/ 10M / Mode 2
Test Date	Apr. 23, 2011		

Horizontal

	Freq	Level	Limit	Over	Read	Cable	Preamp	Antenna	T/Pos	A/Pos	Remark	Pol/Phase
	MHz	dBuV/m	dBuV/m	dB	dBuV	dB	dB	dB/m	deg	cm		
1 p	2749.00	64.16	74.00	-9.84	68.19	2.26	34.74	28.45	49	100	Peak	HORIZONTAL
2 a	2749.90	53.28	54.00	-0.72	57.31	2.26	34.74	28.45	49	100	Average	HORIZONTAL

Vertical

	Freq	Level	Limit	Over	Read	Cable	Preamp	Antenna	T/Pos	A/Pos	Remark	Pol/Phase
	MHz	dBuV/m	dBuV/m	dB	dBuV	dB	dB	dB/m	deg	cm		
1 a	2749.88	48.46	54.00	-5.54	52.49	2.26	34.74	28.45	272	100	Average	VERTICAL
2 p	2750.10	57.26	74.00	-16.74	61.29	2.26	34.74	28.45	272	100	Peak	VERTICAL

Temperature	23°C	Humidity	65%
Test Engineer	Allen Liu	Configurations	OFDM – 922 MHz/CH 4 / 10M / Mode 2
Test Date	Apr. 23, 2011		

Horizontal

	Freq	Level	Limit	Over	Read	Cable	Preamp	Antenna	T/Pos	A/Pos	Remark	Pol/Phase
	MHz	dBuV/m	dBuV/m	dB	dBuV	dB	dB	dB/m	deg	cm		
1 p	2764.02	63.43	74.00	-10.57	67.41	2.26	34.74	28.50	31	116	Peak	HORIZONTAL
2 a	2765.58	52.80	54.00	-1.20	56.78	2.26	34.74	28.50	31	116	Average	HORIZONTAL

Vertical

	Freq	Level	Limit	Over	Read	Cable	Preamp	Antenna	T/Pos	A/Pos	Remark	Pol/Phase
	MHz	dBuV/m	dBuV/m	dB	dBuV	dB	dB	dB/m	deg	cm		
1 a	2765.74	49.26	54.00	-4.74	53.24	2.26	34.74	28.50	271	100	Average	VERTICAL
2 p	2765.94	58.74	74.00	-15.26	62.72	2.26	34.74	28.50	271	100	Peak	VERTICAL

Temperature	23°C	Humidity	65%
Test Engineer	Allen Liu	Configurations	OFDM – 912 MHz/CH 2 / 20M / Mode 2
Test Date	Apr. 23, 2011		

Horizontal

	Freq	Level	Limit	Over	Read	Cable	Preamp	Antenna	T/Pos	A/Pos	Remark	Pol/Phase
	MHz	dBuV/m	dBuV/m	dB	dBuV	dB	dB	dB/m	deg	cm		
1 p	2735.25	63.19	74.00	-10.81	67.29	2.24	34.74	28.40	325	100	Peak	HORIZONTAL
2 a	2735.45	53.41	54.00	-0.59	57.51	2.24	34.74	28.40	325	100	Average	HORIZONTAL

Vertical

	Freq	Level	Limit	Over	Read	Cable	Preamp	Antenna	T/Pos	A/Pos	Remark	Pol/Phase
	MHz	dBuV/m	dBuV/m	dB	dBuV	dB	dB	dB/m	deg	cm		
1 p	2730.10	55.19	74.00	-18.81	59.29	2.24	34.74	28.40	245	100	Peak	VERTICAL
2 a	2737.45	45.44	54.00	-8.56	49.54	2.24	34.74	28.40	245	100	Average	VERTICAL

Temperature	23°C	Humidity	65%
Test Engineer	Allen Liu	Configurations	OFDM- 917 MHz/CH 3 / 20M / Mode 2
Test Date	Apr. 23, 2011		

Horizontal

	Freq	Level	Limit	Over	Read	Cable	Preamp	Antenna	T/Pos	A/Pos	Remark	Pol/Phase
	MHz	dBuV/m	dBuV/m	dB	dBuV	dB	dB	dB/m	deg	cm		
1 a	2747.32	53.97	54.00	-0.03	58.00	2.26	34.74	28.45	36	100	Average	HORIZONTAL
2 p	2748.84	65.41	74.00	-8.59	69.44	2.26	34.74	28.45	36	100	Peak	HORIZONTAL

Vertical

	Freq	Level	Limit	Over	Read	Cable	Preamp	Antenna	T/Pos	A/Pos	Remark	Pol/Phase
	MHz	dBuV/m	dBuV/m	dB	dBuV	dB	dB	dB/m	deg	cm		
1 p	2741.34	60.16	74.00	-13.84	64.26	2.24	34.74	28.40	166	100	Peak	VERTICAL
2 a	2749.32	49.16	54.00	-4.84	53.19	2.26	34.74	28.45	166	100	Average	VERTICAL

Note:

The amplitude of spurious emissions that are attenuated by more than 20dB below the permissible value has no need to be reported.

Emission level (dBuV/m) = 20 log Emission level (uV/m).

Corrected Reading: Antenna Factor + Cable Loss + Read Level - Preamp Factor = Level.

4.6. Band Edge Emissions Measurement

4.6.1. Limit

20dBc in any 100 kHz bandwidth outside the operating frequency band. In case the emission fall within the restricted band specified on 15.205(a), then the 15.209(a) limit in the table below has to be followed.

Frequencies (MHz)	Field Strength (micovolts/meter)	Measurement Distance (meters)
0.009~0.490	2400/F(KHz)	300
0.490~1.705	24000/F(KHz)	30
1.705~30.0	30	30
30~88	100	3
88~216	150	3
216~960	200	3
Above 960	500	3

4.6.2. Measuring Instruments and Setting

Please refer to section 5 of equipments list in this report. The following table is the setting of the spectrum analyzer.

Spectrum Parameter	Setting
Attenuation	Auto
Span Frequency	100 MHz
RB / VB (Emission in restricted band)	1 MHz / 1MHz for Peak, 1 MHz / 10Hz for Average
RB / VB (Emission in non-restricted band)	100 KHz /100 KHz for Peak

4.6.3. Test Procedures

1. The test procedure is the same as section 4.5.3, only the frequency range investigated is limited to 100MHz around bandedges.
2. In case the emission is fail due to the used RB/VB is too wide, marker-delta method of FCC Public Notice DA00-705 will be followed.

4.6.4. Test Setup Layout

This test setup layout is the same as that shown in section 4.5.4.

4.6.5. Test Deviation

There is no deviation with the original standard.

4.6.6. EUT Operation during Test

The EUT was programmed to be in continuously transmitting mode.

4.6.7. Test Result of Band Edge and Fundamental Emissions

Temperature	23°C	Humidity	65%
Test Engineer	Allen Liu	Configurations	DSSS – 5MHz CH 1, 2, 3, 4 / Mode 1
Test Date	Apr. 23, 2011		

Channel 1

	Freq	Level	Limit Line	Over Limit	Read Level	Cable Loss	Preamp Factor	Antenna Factor	T/Pos	A/Pos	Remark	Pol/Phase
	MHz	dBuV/m	dBuV/m	dB	dBuV	dB	dB	dB/m	deg	cm		
1 *	902.00	91.50			94.10	3.60	27.39	21.19	177	100	Peak	VERTICAL
2 p	905.20	109.45			112.03	3.60	27.38	21.20	177	100	Peak	VERTICAL

Item 1, 2 are the fundamental frequency at 907 MHz.

Channel 2

	Freq	Level	Limit Line	Over Limit	Read Level	Cable Loss	Preamp Factor	Antenna Factor	T/Pos	A/Pos	Remark	Pol/Phase
	MHz	dBuV/m	dBuV/m	dB	dBuV	dB	dB	dB/m	deg	cm		
1 p	918.80	109.92			112.38	3.60	27.32	21.26	194	100	Peak	VERTICAL
2 *	928.00	76.59			78.97	3.60	27.29	21.31	194	100	Peak	VERTICAL

Item 1, 2 are the fundamental frequency at 912 MHz.

Channel 3

	Freq	Level	Limit Line	Over Limit	Read Level	Cable Loss	Preamp Factor	Antenna Factor	T/Pos	A/Pos	Remark	Pol/Phase
	MHz	dBuV/m	dBuV/m	dB	dBuV	dB	dB	dB/m	deg	cm		
1 p	921.80	108.87			111.30	3.60	27.31	21.28	289	100	Peak	VERTICAL
2 *	928.00	84.54			86.92	3.60	27.29	21.31	289	100	Peak	VERTICAL

Item 1, 2 are the fundamental frequency at 917 MHz.

Channel 4

	Freq	Level	Limit Line	Over Limit	Read Level	Cable Loss	Preamp Factor	Antenna Factor	T/Pos	A/Pos	Remark	Pol/Phase
	MHz	dBuV/m	dBuV/m	dB	dBuV	dB	dB	dB/m	deg	cm		
1 p	921.80	108.87			111.30	3.60	27.31	21.28	289	100	Peak	VERTICAL
2 *	928.00	84.54			86.92	3.60	27.29	21.31	289	100	Peak	VERTICAL

Item 1, 2 are the fundamental frequency at 922 MHz.

Temperature	23°C	Humidity	65%
Test Engineer	Allen Liu	Configurations	DSSS – 10MHz CH 1, 2, 3, 4 / Mode 1
Test Date	Apr. 23, 2011		

Channel 1

	Freq	Level	Limit Line	Over Limit	Read Level	Cable Loss	Preamp Factor	Antenna Factor	T/Pos	A/Pos	Remark	Pol/Phase
	MHz	dBuV/m	dBuV/m	dB	dBuV	dB	dB	dB/m	deg	cm		
1 *	902.00	95.97			98.57	3.60	27.39	21.19	261	100	Peak	VERTICAL
2 p	904.60	106.14			108.72	3.60	27.38	21.20	261	100	Peak	VERTICAL

Item 1, 2 are the fundamental frequency at 907 MHz.

Channel 2

	Freq	Level	Limit Line	Over Limit	Read Level	Cable Loss	Preamp Factor	Antenna Factor	T/Pos	A/Pos	Remark	Pol/Phase
	MHz	dBuV/m	dBuV/m	dB	dBuV	dB	dB	dB/m	deg	cm		
1 *	902.00	88.17			90.77	3.60	27.39	21.19	197	100	Peak	VERTICAL
2 p	909.00	105.69			108.23	3.60	27.36	21.22	197	100	Peak	VERTICAL

Item 1, 2 are the fundamental frequency at 912 MHz.

Channel 3

	Freq	Level	Limit Line	Over Limit	Read Level	Cable Loss	Preamp Factor	Antenna Factor	T/Pos	A/Pos	Remark	Pol/Phase
	MHz	dBuV/m	dBuV/m	dB	dBuV	dB	dB	dB/m	deg	cm		
1 p	914.60	106.79			109.28	3.60	27.34	21.25	110	100	Peak	VERTICAL
2 *	928.00	86.40			88.78	3.60	27.29	21.31	110	100	Peak	VERTICAL

Item 1, 2 are the fundamental frequency at 917 MHz.

Channel 4

	Freq	Level	Limit Line	Over Limit	Read Level	Cable Loss	Preamp Factor	Antenna Factor	T/Pos	A/Pos	Remark	Pol/Phase
	MHz	dBuV/m	dBuV/m	dB	dBuV	dB	dB	dB/m	deg	cm		
1 p	921.40	105.03			107.46	3.60	27.31	21.28	109	109	Peak	VERTICAL
2 *	928.00	89.37			91.75	3.60	27.29	21.31	109	100	Peak	VERTICAL

Item 1, 2 are the fundamental frequency at 922 MHz.



Temperature	23°C	Humidity	65%
Test Engineer	Allen Liu	Configurations	DSSS – 20MHz CH 2, 3 / Mode 1
Test Date	Apr. 23, 2011		

Channel 2

	Freq	Level	Limit Line	Over Limit	Read Level	Cable Loss	Preamp Factor	Antenna Factor	T/Pos	A/Pos	Remark	Pol/Phase
	MHz	dBuV/m	dBuV/m	dB	dBuV	dB	dB	dB/m	deg	cm		
1 *	902.00	95.84			98.44	3.60	27.39	21.19	351	100	Peak	VERTICAL
2 p	905.20	105.93			108.51	3.60	27.38	21.20	351	100	Peak	VERTICAL

Item 1, 2 are the fundamental frequency at 912 MHz.

Channel 3

	Freq	Level	Limit Line	Over Limit	Read Level	Cable Loss	Preamp Factor	Antenna Factor	T/Pos	A/Pos	Remark	Pol/Phase
	MHz	dBuV/m	dBuV/m	dB	dBuV	dB	dB	dB/m	deg	cm		
1 p	922.00	106.11			108.54	3.60	27.31	21.28	360	100	Peak	VERTICAL
2 *	928.00	91.12			93.50	3.60	27.29	21.31	360	100	Peak	VERTICAL

Item 1, 2 are the fundamental frequency at 917 MHz.

Note:

Emission level (dBuV/m) = 20 log Emission level (uV/m).

Corrected Reading: Antenna Factor + Cable Loss + Read Level - Preamp Factor = Level.

Temperature	23°C	Humidity	65%
Test Engineer	Allen Liu	Configurations	OFDM – 5MHz CH 1, 2, 3, 4 / Mode 1
Test Date	Apr. 23, 2011		

Channel 1

	Freq	Level	Limit Line	Over Limit	Read Level	Cable Loss	Preamp Factor	Antenna Factor	T/Pos	A/Pos	Remark	Pol/Phase
	MHz	dBuV/m	dBuV/m	dB	dBuV	dB	dB	dB/m	deg	cm		
1 *	902.00	82.51			85.11	3.60	27.39	21.19	296	100	Peak	VERTICAL
2 p	906.80	107.57			110.13	3.60	27.37	21.21	296	100	Peak	VERTICAL

Item 1, 2 are the fundamental frequency at 907 MHz.

Channel 2

	Freq	Level	Limit Line	Over Limit	Read Level	Cable Loss	Preamp Factor	Antenna Factor	T/Pos	A/Pos	Remark	Pol/Phase
	MHz	dBuV/m	dBuV/m	dB	dBuV	dB	dB	dB/m	deg	cm		
1 *	902.00	66.56			69.16	3.60	27.39	21.19	291	100	Peak	VERTICAL
2 p	911.80	107.31			109.83	3.60	27.35	21.23	291	100	Peak	VERTICAL

Item 1, 2 are the fundamental frequency at 912 MHz.

Channel 3

	Freq	Level	Limit Line	Over Limit	Read Level	Cable Loss	Preamp Factor	Antenna Factor	T/Pos	A/Pos	Remark	Pol/Phase
	MHz	dBuV/m	dBuV/m	dB	dBuV	dB	dB	dB/m	deg	cm		
1 p	917.40	107.09			109.56	3.60	27.33	21.26	219	100	Peak	VERTICAL
2 *	928.00	62.77			65.15	3.60	27.29	21.31	219	100	Peak	VERTICAL

Item 1, 2 are the fundamental frequency at 917 MHz.

Channel 4

	Freq	Level	Limit Line	Over Limit	Read Level	Cable Loss	Preamp Factor	Antenna Factor	T/Pos	A/Pos	Remark	Pol/Phase
	MHz	dBuV/m	dBuV/m	dB	dBuV	dB	dB	dB/m	deg	cm		
1 p	922.00	107.07			109.50	3.60	27.31	21.28	220	100	Peak	VERTICAL
2 *	928.00	73.78			76.16	3.60	27.29	21.31	220	100	Peak	VERTICAL

Item 1, 2 are the fundamental frequency at 922 MHz.

Temperature	23°C	Humidity	65%
Test Engineer	Allen Liu	Configurations	OFDM – 10MHz CH 1, 2, 3, 4 / Mode 1
Test Date	Apr. 23, 2011		

Channel 1

	Freq	Level	Limit Line	Over Limit	Read Level	Cable Loss	Preamp Factor	Antenna Factor	T/Pos	A/Pos	Remark	Pol/Phase
	MHz	dBuV/m	dBuV/m	dB	dBuV	dB	dB	dB/m	deg	cm		
1 *	902.00	88.96			91.56	3.60	27.39	21.19	143	100	Peak	VERTICAL
2 p	906.00	107.54			110.10	3.60	27.37	21.21	143	100	Peak	VERTICAL

Item 1, 2 are the fundamental frequency at 907 MHz.

Channel 2

	Freq	Level	Limit Line	Over Limit	Read Level	Cable Loss	Preamp Factor	Antenna Factor	T/Pos	A/Pos	Remark	Pol/Phase
	MHz	dBuV/m	dBuV/m	dB	dBuV	dB	dB	dB/m	deg	cm		
1 *	902.00	81.98			84.58	3.60	27.39	21.19	229	100	Peak	VERTICAL
2 p	911.00	107.15			109.67	3.60	27.35	21.23	229	100	Peak	VERTICAL

Item 1, 2 are the fundamental frequency at 912 MHz.

Channel 3

	Freq	Level	Limit Line	Over Limit	Read Level	Cable Loss	Preamp Factor	Antenna Factor	T/Pos	A/Pos	Remark	Pol/Phase
	MHz	dBuV/m	dBuV/m	dB	dBuV	dB	dB	dB/m	deg	cm		
1 p	918.00	106.69			109.16	3.60	27.33	21.26	134	100	Peak	VERTICAL
2 *	928.00	64.91			67.29	3.60	27.29	21.31	134	100	Peak	VERTICAL

Item 1, 2 are the fundamental frequency at 917 MHz.

Channel 4

	Freq	Level	Limit Line	Over Limit	Read Level	Cable Loss	Preamp Factor	Antenna Factor	T/Pos	A/Pos	Remark	Pol/Phase
	MHz	dBuV/m	dBuV/m	dB	dBuV	dB	dB	dB/m	deg	cm		
1 p	921.80	106.65			109.08	3.60	27.31	21.28	140	100	Peak	VERTICAL
2 *	928.00	77.18			79.56	3.60	27.29	21.31	140	100	Peak	VERTICAL

Item 1, 2 are the fundamental frequency at 922 MHz.



Temperature	23°C	Humidity	65%
Test Engineer	Allen Liu	Configurations	OFDM – 20MHz CH 2, 3 / Mode 1
Test Date	Apr. 23, 2011		

Channel 2

	Freq	Level	Limit Line	Over Limit	Read Level	Cable Loss	Preamp Factor	Antenna Factor	T/Pos	A/Pos	Remark	Pol/Phase
	MHz	dBuV/m	dBuV/m	dB	dBuV	dB	dB	dB/m	deg	cm		
1 *	902.00	88.14			90.74	3.60	27.39	21.19	359	100	Peak	VERTICAL
2 p	910.00	106.95			109.49	3.60	27.36	21.22	359	100	Peak	VERTICAL

Item 1, 2 are the fundamental frequency at 912 MHz.

Channel 3

	Freq	Level	Limit Line	Over Limit	Read Level	Cable Loss	Preamp Factor	Antenna Factor	T/Pos	A/Pos	Remark	Pol/Phase
	MHz	dBuV/m	dBuV/m	dB	dBuV	dB	dB	dB/m	deg	cm		
1 p	919.60	106.44			108.89	3.60	27.32	21.27	222	100	Peak	VERTICAL
2 *	928.00	76.73			79.11	3.60	27.29	21.31	222	100	Peak	VERTICAL

Item 1, 2 are the fundamental frequency at 917 MHz.

Note:

Emission level (dBuV/m) = 20 log Emission level (uV/m).

Corrected Reading: Antenna Factor + Cable Loss + Read Level - Preamp Factor = Level.

Temperature	23°C	Humidity	65%
Test Engineer	Allen Liu	Configurations	DSSS – 5MHz CH 1, 2, 3, 4 / Mode 2
Test Date	Apr. 23, 2011		

Channel 1

	Freq	Level	Limit Line	Over Limit	Read Level	Cable Loss	Preamp Factor	Antenna Factor	T/Pos	A/Pos	Remark	Pol/Phase
	MHz	dBuV/m	dBuV/m	dB	dBuV	dB	dB	dB/m	deg	cm		
1 *	902.00	80.15			82.75	3.60	27.39	21.19	248	100	Peak	VERTICAL
2 p	906.90	99.62			102.18	3.60	27.37	21.21	248	100	Peak	VERTICAL

tem 1, 2 are the fundamental frequency at 907 MHz.

Channel 2

	Freq	Level	Limit Line	Over Limit	Read Level	Cable Loss	Preamp Factor	Antenna Factor	T/Pos	A/Pos	Remark	Pol/Phase
	MHz	dBuV/m	dBuV/m	dB	dBuV	dB	dB	dB/m	deg	cm		
1 *	902.00	64.81			67.41	3.60	27.39	21.19	213	100	Peak	VERTICAL
2 p	910.80	97.20			99.72	3.60	27.35	21.23	213	100	Peak	VERTICAL

Item 1, 2 are the fundamental frequency at 912 MHz.

Channel 3

	Freq	Level	Limit Line	Over Limit	Read Level	Cable Loss	Preamp Factor	Antenna Factor	T/Pos	A/Pos	Remark	Pol/Phase
	MHz	dBuV/m	dBuV/m	dB	dBuV	dB	dB	dB/m	deg	cm		
1 p	915.10	97.02			99.51	3.60	27.34	21.25	214	100	Peak	VERTICAL
2 *	928.00	59.79			62.17	3.60	27.29	21.31	214	100	Peak	VERTICAL

Item 1, 2 are the fundamental frequency at 917 MHz.

Channel 4

	Freq	Level	Limit Line	Over Limit	Read Level	Cable Loss	Preamp Factor	Antenna Factor	T/Pos	A/Pos	Remark	Pol/Phase
	MHz	dBuV/m	dBuV/m	dB	dBuV	dB	dB	dB/m	deg	cm		
1 p	923.20	100.51			102.93	3.60	27.31	21.29	113	108	Peak	VERTICAL
2 *	928.00	77.25			79.63	3.60	27.29	21.31	113	108	Peak	VERTICAL

Item 1, 2 are the fundamental frequency at 922 MHz.

Temperature	23°C	Humidity	65%
Test Engineer	Allen Liu	Configurations	DSSS – 10MHz CH 1, 2, 3, 4 / Mode 2
Test Date	Apr. 23, 2011		

Channel 1

	Freq	Level	Limit Line	Over Limit	Read Level	Cable Loss	Preamp Factor	Antenna Factor	T/Pos	A/Pos	Remark	Pol/Phase
	MHz	dBuV/m	dBuV/m	dB	dBuV	dB	dB	dB/m	deg	cm		
1 *	902.00	84.07			86.67	3.60	27.39	21.19	210	100	Peak	VERTICAL
2 p	905.00	96.70			99.28	3.60	27.38	21.20	210	100	Peak	VERTICAL

Item 1, 2 are the fundamental frequency at 907 MHz.

Channel 2

	Freq	Level	Limit Line	Over Limit	Read Level	Cable Loss	Preamp Factor	Antenna Factor	T/Pos	A/Pos	Remark	Pol/Phase
	MHz	dBuV/m	dBuV/m	dB	dBuV	dB	dB	dB/m	deg	cm		
1 *	902.00	76.52			79.12	3.60	27.39	21.19	212	100	Peak	VERTICAL
2 p	908.20	94.71			97.25	3.60	27.36	21.22	212	100	Peak	VERTICAL

Item 1, 2 are the fundamental frequency at 912 MHz.

Channel 3

	Freq	Level	Limit Line	Over Limit	Read Level	Cable Loss	Preamp Factor	Antenna Factor	T/Pos	A/Pos	Remark	Pol/Phase
	MHz	dBuV/m	dBuV/m	dB	dBuV	dB	dB	dB/m	deg	cm		
1 p	920.50	95.58			98.03	3.60	27.32	21.27	118	100	Peak	VERTICAL
2 *	928.00	73.21			75.59	3.60	27.29	21.31	118	100	Peak	VERTICAL

Item 1, 2 are the fundamental frequency at 917 MHz.

Channel 4

	Freq	Level	Limit Line	Over Limit	Read Level	Cable Loss	Preamp Factor	Antenna Factor	T/Pos	A/Pos	Remark	Pol/Phase
	MHz	dBuV/m	dBuV/m	dB	dBuV	dB	dB	dB/m	deg	cm		
1 p	921.40	96.81			99.24	3.60	27.31	21.28	114	100	Peak	VERTICAL
2 *	928.00	81.85			84.23	3.60	27.29	21.31	114	100	Peak	VERTICAL

Item 1, 2 are the fundamental frequency at 922 MHz.

Temperature	23°C	Humidity	65%
Test Engineer	Allen Liu	Configurations	DSSS – 20MHz CH 2, 3 / Mode 2
Test Date	Apr. 23, 2011		

Channel 2

	Freq	Level	Limit Line	Over Limit	Read Level	Cable Loss	Preamp Factor	Antenna Factor	T/Pos	A/Pos	Remark	Pol/Phase
	MHz	dBuV/m	dBuV/m	dB	dBuV	dB	dB	dB/m	deg	cm		
1 *	902.00	80.95			83.55	3.60	27.39	21.19	211	100	Peak	VERTICAL
2 p	907.00	97.03			99.59	3.60	27.37	21.21	211	100	Peak	VERTICAL

Item 1, 2 are the fundamental frequency at 912 MHz.

Channel 3

	Freq	Level	Limit Line	Over Limit	Read Level	Cable Loss	Preamp Factor	Antenna Factor	T/Pos	A/Pos	Remark	Pol/Phase
	MHz	dBuV/m	dBuV/m	dB	dBuV	dB	dB	dB/m	deg	cm		
1 p	922.00	96.56			98.99	3.60	27.31	21.28	112	100	Peak	VERTICAL
2 *	928.00	81.36			83.74	3.60	27.29	21.31	112	100	Peak	VERTICAL

Item 1, 2 are the fundamental frequency at 917 MHz.

Note:

Emission level (dBuV/m) = 20 log Emission level (uV/m).

Corrected Reading: Antenna Factor + Cable Loss + Read Level - Preamp Factor = Level.

Temperature	23°C	Humidity	65%
Test Engineer	Allen Liu	Configurations	OFDM – 5MHz CH 1, 2, 3, 4 / Mode 2
Test Date	Apr. 23, 2011		

Channel 1

	Freq	Level	Limit Line	Over Limit	Read Level	Cable Loss	Preamp Factor	Antenna Factor	T/Pos	A/Pos	Remark	Pol/Phase
	MHz	dBuV/m	dBuV/m	dB	dBuV	dB	dB	dB/m	deg	cm		
1 *	902.00	75.60			78.20	3.60	27.39	21.19	248	100	Peak	VERTICAL
2 p	906.80	98.05			100.61	3.60	27.37	21.21	248	100	Peak	VERTICAL

Item 1, 2 are the fundamental frequency at 907 MHz.

Channel 2

	Freq	Level	Limit Line	Over Limit	Read Level	Cable Loss	Preamp Factor	Antenna Factor	T/Pos	A/Pos	Remark	Pol/Phase
	MHz	dBuV/m	dBuV/m	dB	dBuV	dB	dB	dB/m	deg	cm		
1 *	902.00	59.96			62.56	3.60	27.39	21.19	269	119	Peak	VERTICAL
2 p	911.90	95.58			98.10	3.60	27.35	21.23	269	119	Peak	VERTICAL

Item 1, 2 are the fundamental frequency at 912 MHz.

Channel 3

	Freq	Level	Limit Line	Over Limit	Read Level	Cable Loss	Preamp Factor	Antenna Factor	T/Pos	A/Pos	Remark	Pol/Phase
	MHz	dBuV/m	dBuV/m	dB	dBuV	dB	dB	dB/m	deg	cm		
1 p	916.80	97.28			99.75	3.60	27.33	21.26	62	145	Peak	VERTICAL
2 *	928.00	56.96			59.34	3.60	27.29	21.31	62	145	Peak	VERTICAL

Item 1, 2 are the fundamental frequency at 917 MHz.

Channel 4

	Freq	Level	Limit Line	Over Limit	Read Level	Cable Loss	Preamp Factor	Antenna Factor	T/Pos	A/Pos	Remark	Pol/Phase
	MHz	dBuV/m	dBuV/m	dB	dBuV	dB	dB	dB/m	deg	cm		
1 p	921.60	98.50			100.93	3.60	27.31	21.28	111	100	Peak	VERTICAL
2 *	928.00	72.75			75.13	3.60	27.29	21.31	111	100	Peak	VERTICAL

Item 1, 2 are the fundamental frequency at 922 MHz.

Temperature	23°C	Humidity	65%
Test Engineer	Allen Liu	Configurations	OFDM – 10MHz CH 1, 2, 3, 4 / Mode 2
Test Date	Apr. 23, 2011		

Channel 1

	Freq	Level	Limit	Over	Read	Cable	Preamp	Antenna	T/Pos	A/Pos	Remark	Pol/Phase
	MHz	dBuV/m	dBuV/m	dB	dBuV	dB	dB	dB/m	deg	cm		
1 *	902.00	74.39			76.99	3.60	27.39	21.19	246	100	Peak	VERTICAL
2 p	906.20	97.81			100.37	3.60	27.37	21.21	246	100	Peak	VERTICAL

Item 1, 2 are the fundamental frequency at 907 MHz.

Channel 2

	Freq	Level	Limit	Over	Read	Cable	Preamp	Antenna	T/Pos	A/Pos	Remark	Pol/Phase
	MHz	dBuV/m	dBuV/m	dB	dBuV	dB	dB	dB/m	deg	cm		
1 *	902.00	65.94			68.54	3.60	27.39	21.19	213	100	Peak	VERTICAL
2 p	911.20	95.10			97.62	3.60	27.35	21.23	213	100	Peak	VERTICAL

Item 1, 2 are the fundamental frequency at 912 MHz.

Channel 3

	Freq	Level	Limit	Over	Read	Cable	Preamp	Antenna	T/Pos	A/Pos	Remark	Pol/Phase
	MHz	dBuV/m	dBuV/m	dB	dBuV	dB	dB	dB/m	deg	cm		
1 p	916.20	95.09			97.56	3.60	27.33	21.26	212	100	Peak	VERTICAL
2 *	928.00	47.47			49.85	3.60	27.29	21.31	212	100	Peak	VERTICAL

Item 1, 2 are the fundamental frequency at 917 MHz.

Channel 4

	Freq	Level	Limit	Over	Read	Cable	Preamp	Antenna	T/Pos	A/Pos	Remark	Pol/Phase
	MHz	dBuV/m	dBuV/m	dB	dBuV	dB	dB	dB/m	deg	cm		
1 p	921.20	98.04			100.47	3.60	27.31	21.28	112	106	Peak	VERTICAL
2 *	928.00	70.27			72.65	3.60	27.29	21.31	112	106	Peak	VERTICAL

Item 1, 2 are the fundamental frequency at 922 MHz.

Temperature	23°C	Humidity	65%
Test Engineer	Allen Liu	Configurations	OFDM – 20MHz CH 2, 3 / Mode 2
Test Date	Apr. 23, 2011		

Channel 2

	Freq	Level	Limit Line	Over Limit	Read Level	Cable Loss	Preamp Factor	Antenna Factor	T/Pos	A/Pos	Remark	Pol/Phase
	MHz	dBuV/m	dBuV/m	dB	dBuV	dB	dB	dB/m	deg	cm		
1 *	902.00	66.27			68.87	3.60	27.39	21.19	212	100	Peak	VERTICAL
2 p	909.50	92.08			94.62	3.60	27.36	21.22	212	100	Peak	VERTICAL

Item 1, 2 are the fundamental frequency at 912 MHz.

Channel 3

	Freq	Level	Limit Line	Over Limit	Read Level	Cable Loss	Preamp Factor	Antenna Factor	T/Pos	A/Pos	Remark	Pol/Phase
	MHz	dBuV/m	dBuV/m	dB	dBuV	dB	dB	dB/m	deg	cm		
1 p	919.50	92.66			95.11	3.60	27.32	21.27	118	100	Peak	VERTICAL
2 *	928.00	53.84			56.22	3.60	27.29	21.31	118	100	Peak	VERTICAL

Item 1, 2 are the fundamental frequency at 917 MHz.

Note:

Emission level (dBuV/m) = 20 log Emission level (uV/m).

Corrected Reading: Antenna Factor + Cable Loss + Read Level - Preamp Factor = Level.

For Emission not in Restricted Band

Low Band Edge Plot on Configuration DSSS / 907MHz/5M/ Mode 1

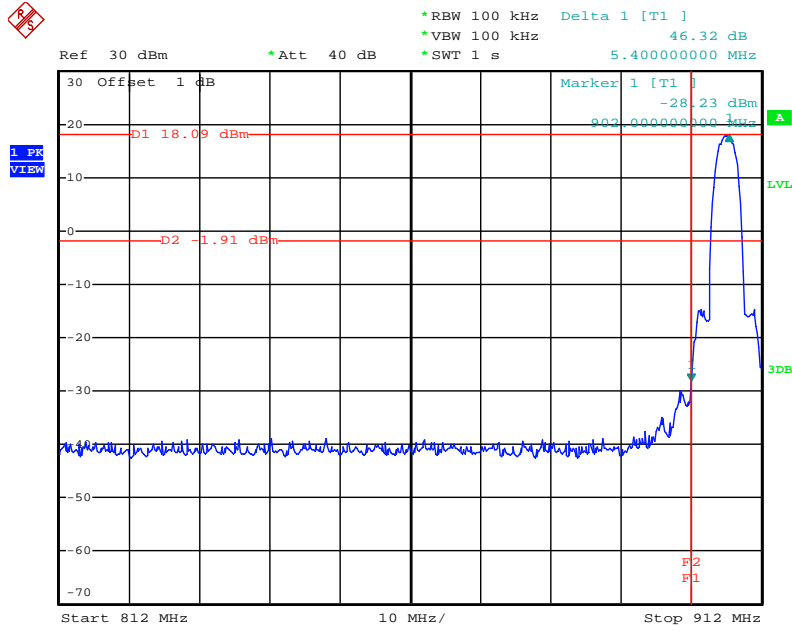

Date: 23.JUN.2011 17:38:56

High Band Edge Plot on Configuration DSSS / 922 MHz/5M/ Mode 1

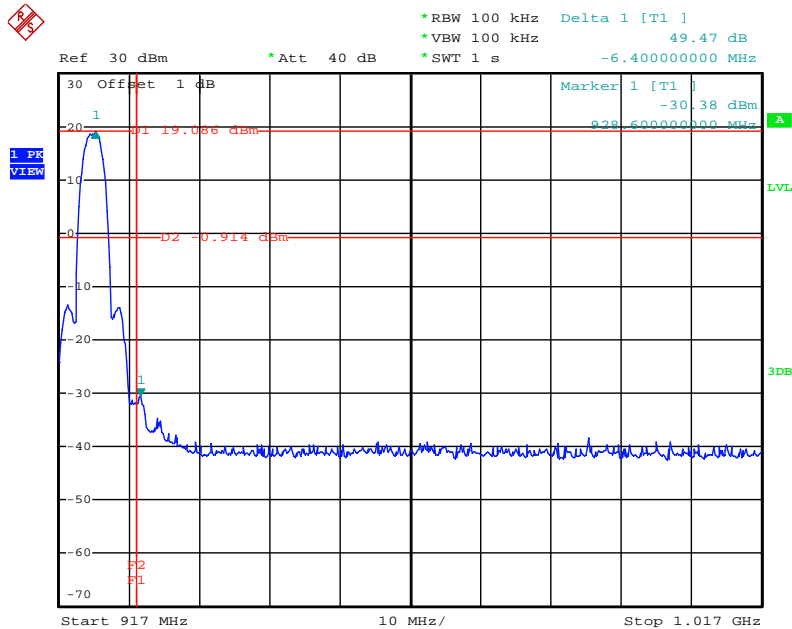

Date: 23.JUN.2011 17:44:22

Low Band Edge Plot on Configuration DSSS / 907MHz/10M/ Mode 1

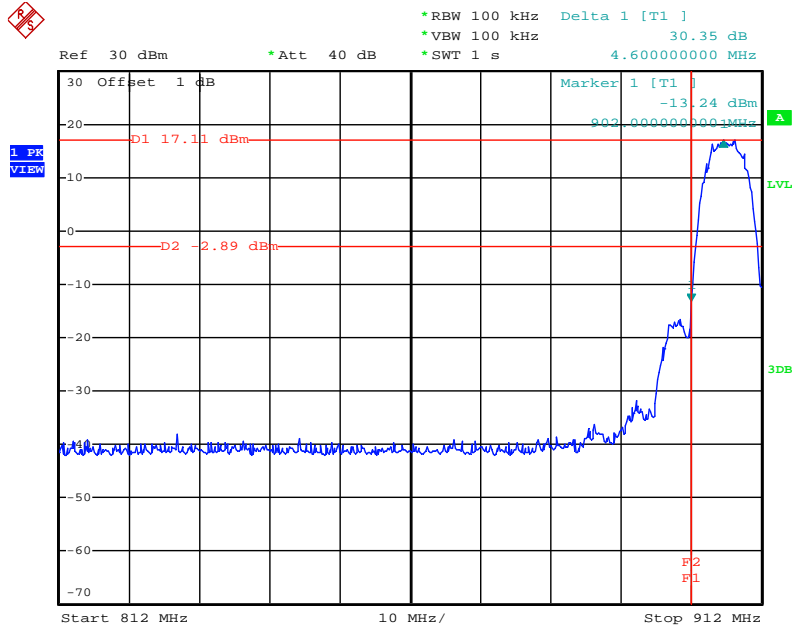

Date: 23.JUN.2011 20:03:47

High Band Edge Plot on Configuration DSSS / 922 MHz/10M/ Mode 1

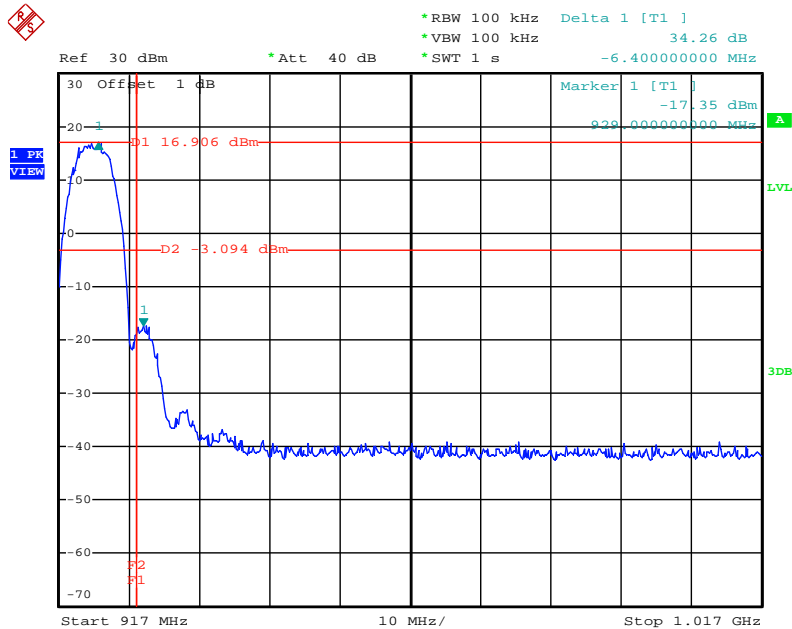

Date: 23.JUN.2011 20:26:05

Low Band Edge Plot on Configuration DSSS / 912MHz/20M/ Mode 1

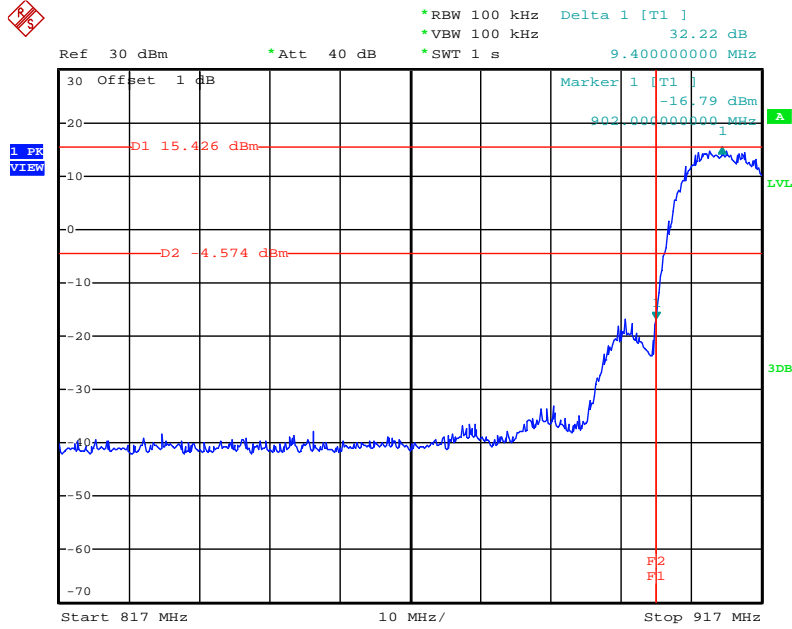

Date: 23.JUN.2011 20:37:07

High Band Edge Plot on Configuration DSSS / 917 MHz/20M/ Mode 1

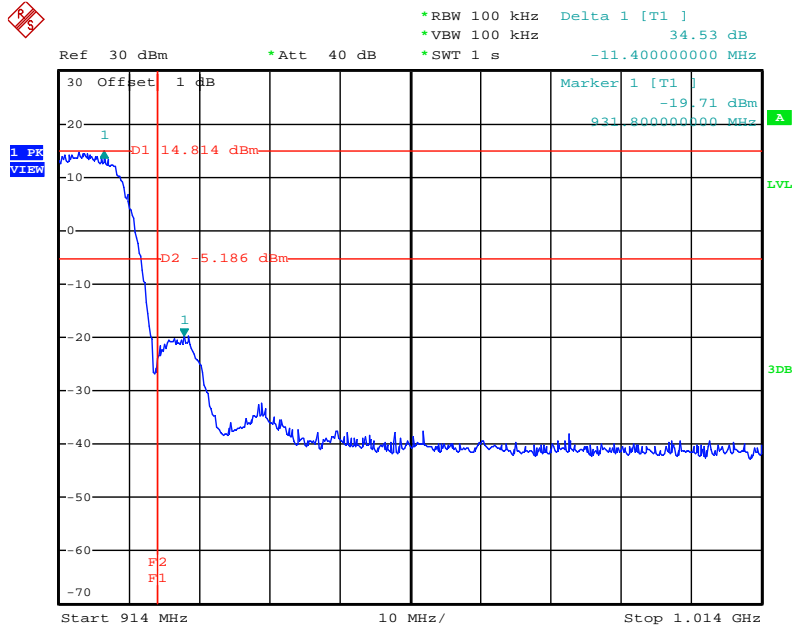

Date: 23.JUN.2011 20:39:12

Low Band Edge Plot on Configuration OFDM / 907 MHz/5M/ Mode 1

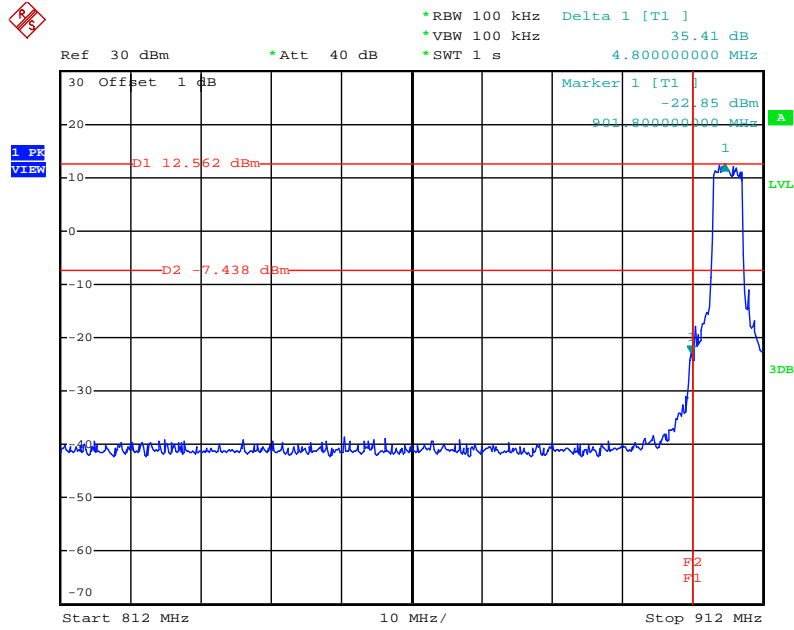

Date: 23.JUN.2011 18:28:04

High Band Edge Plot on Configuration OFDM / 922 MHz/5M/ Mode 1

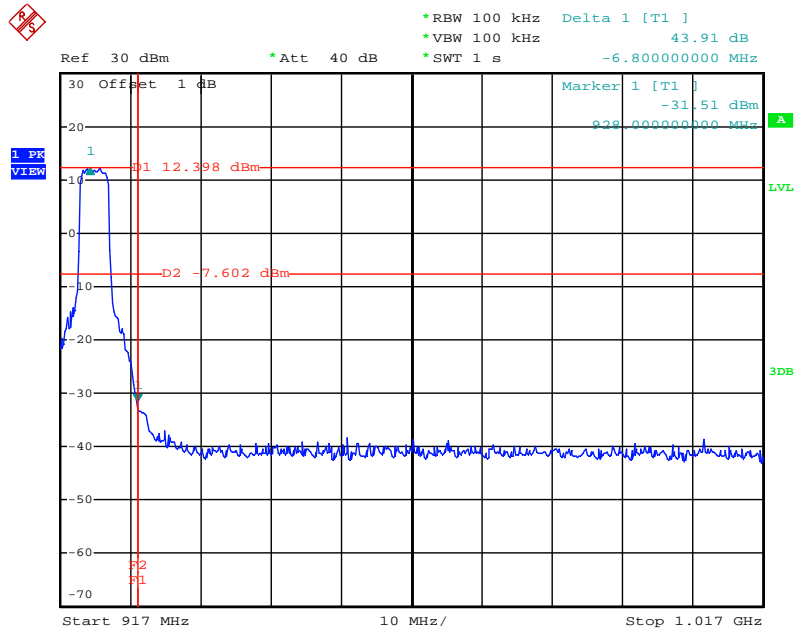

Date: 23.JUN.2011 18:22:07

Low Band Edge Plot on Configuration OFDM / 907 MHz/10M/ Mode 1

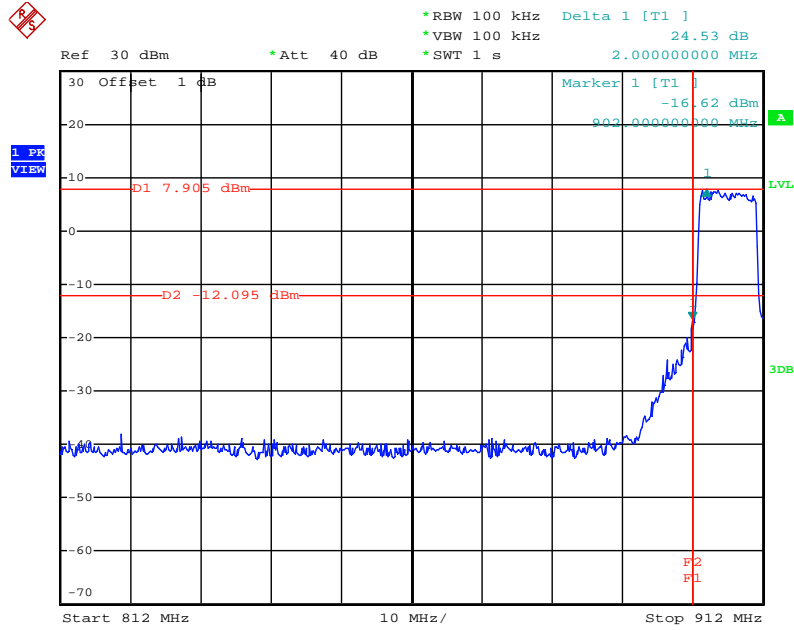

Date: 23.JUN.2011 20:01:27

High Band Edge Plot on Configuration OFDM / 922 MHz/10M/ Mode 1

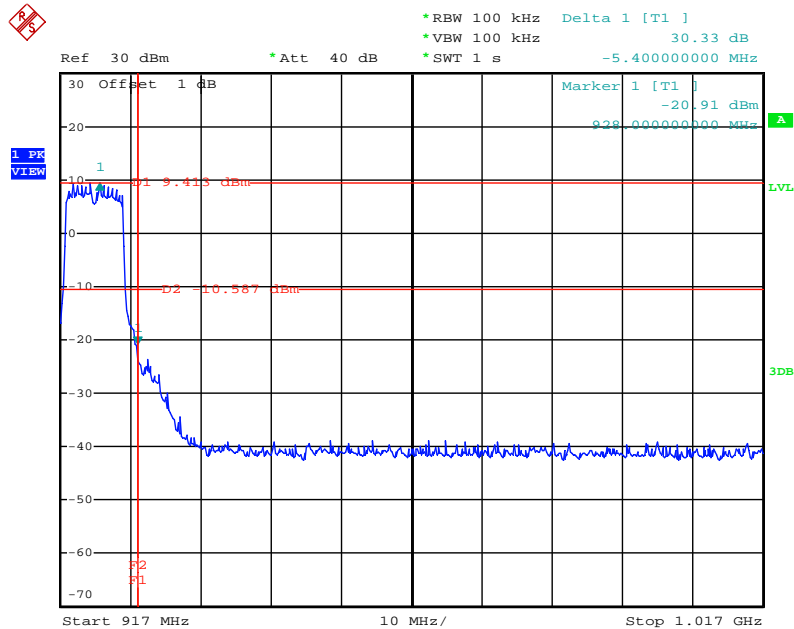

Date: 23.JUN.2011 19:35:11

Low Band Edge Plot on Configuration OFDM / 912 MHz/20M/ Mode 1

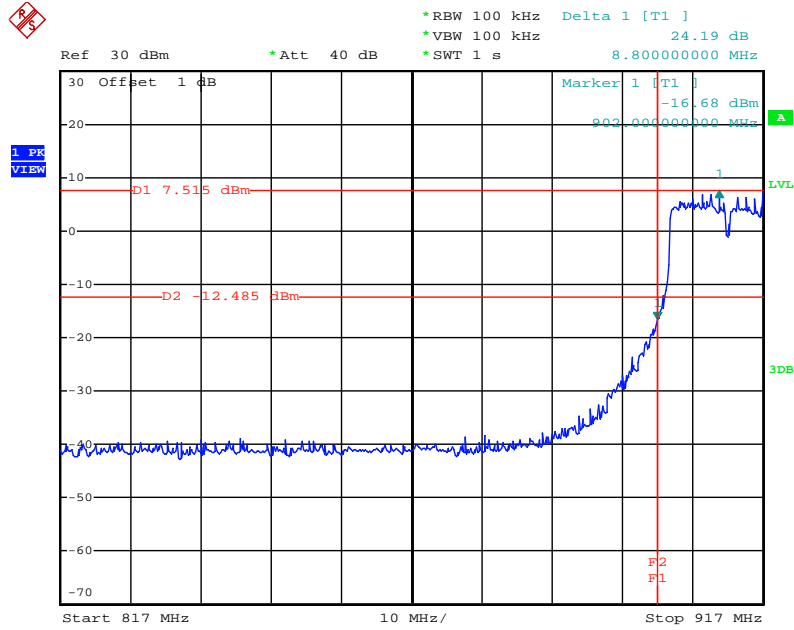

Date: 23.JUN.2011 20:57:14

High Band Edge Plot on Configuration OFDM / 917 MHz/20M/ Mode 1

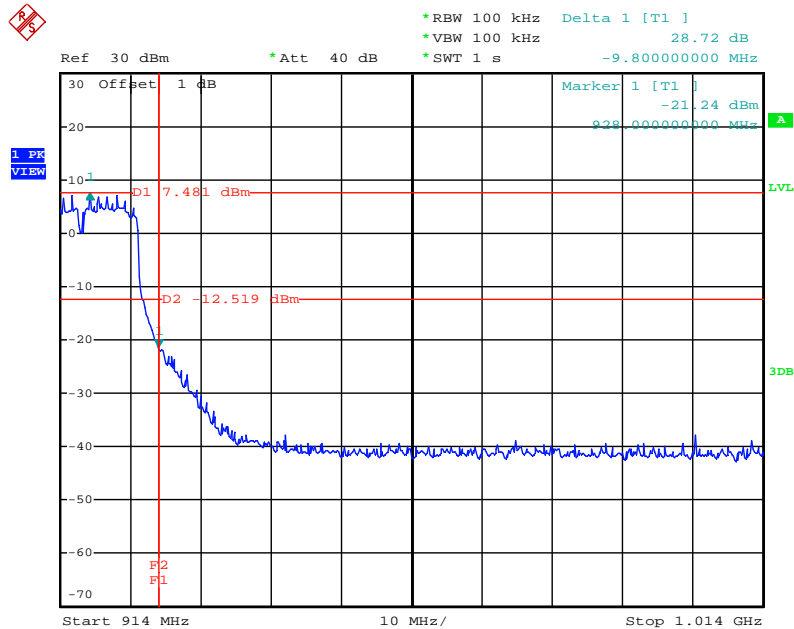

Date: 23.JUN.2011 20:55:17

Low Band Edge Plot on Configuration DSSS / 907MHz/5M/ Mode 2

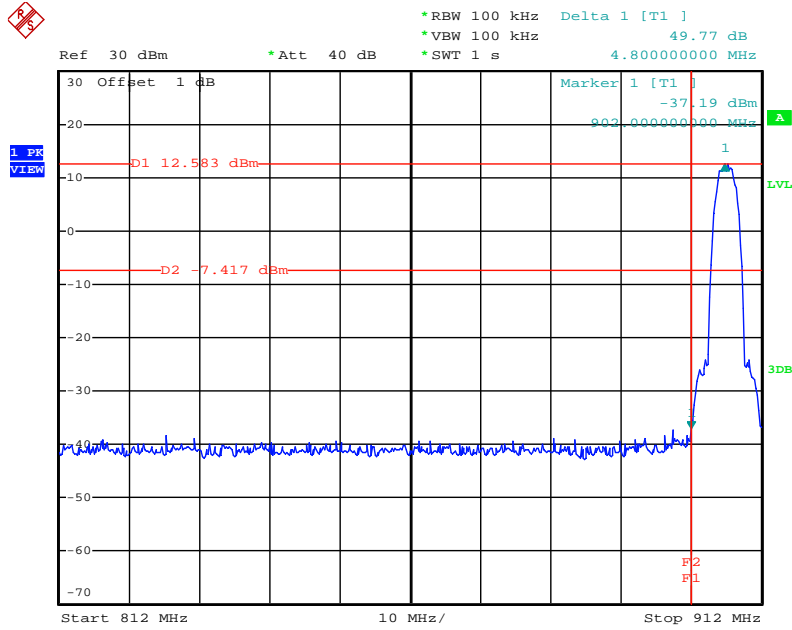

Date: 23.JUN.2011 17:36:12

High Band Edge Plot on Configuration DSSS / 922 MHz/5M/ Mode 2

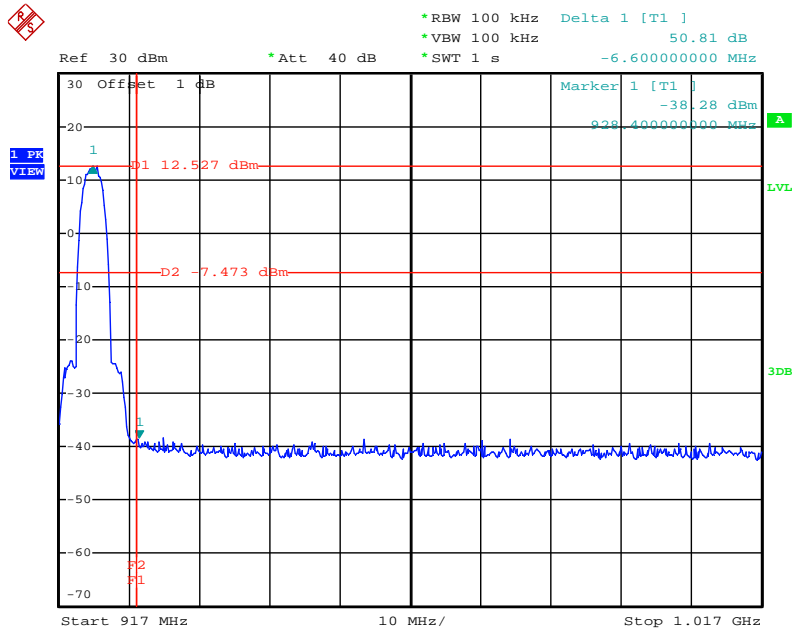

Date: 23.JUN.2011 17:29:59

Low Band Edge Plot on Configuration DSSS / 907MHz/10M/ Mode 1

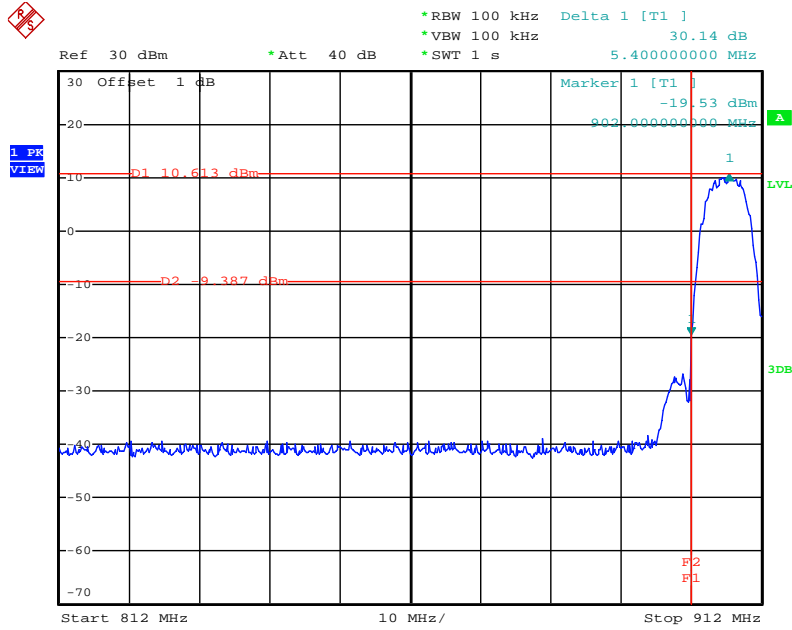

Date: 23.JUN.2011 20:34:32

High Band Edge Plot on Configuration DSSS / 922 MHz/10M/ Mode 1

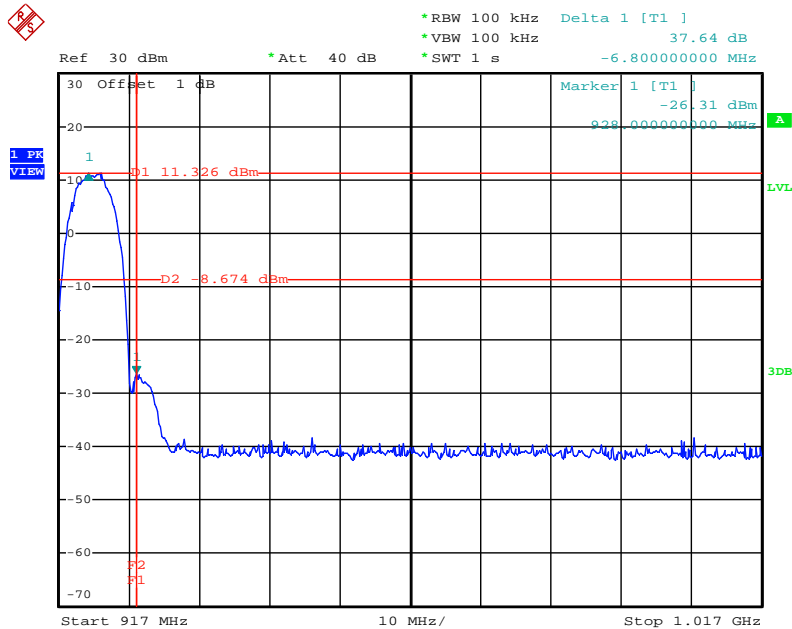

Date: 23.JUN.2011 20:28:20

Low Band Edge Plot on Configuration DSSS / 912MHz/20M/ Mode 2

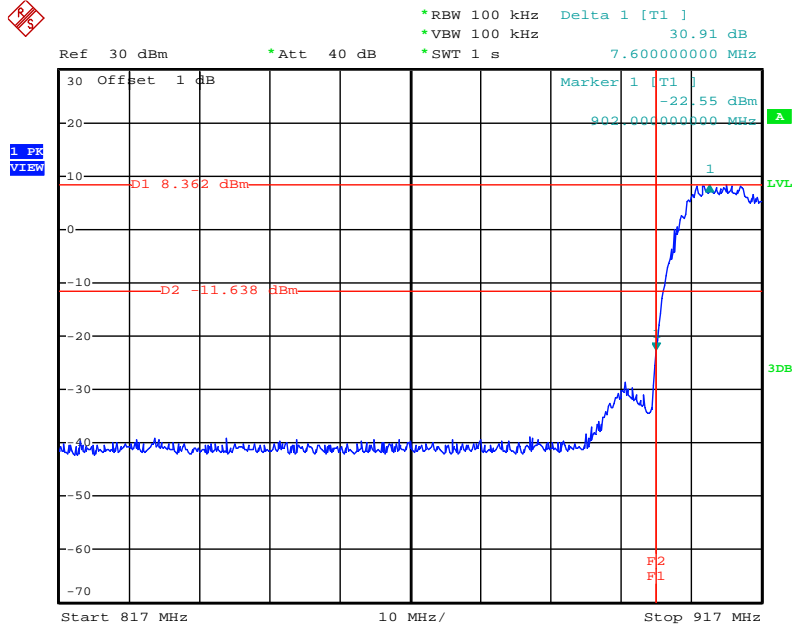

Date: 23.JUN.2011 20:43:44

High Band Edge Plot on Configuration DSSS / 917 MHz/20M/ Mode 2

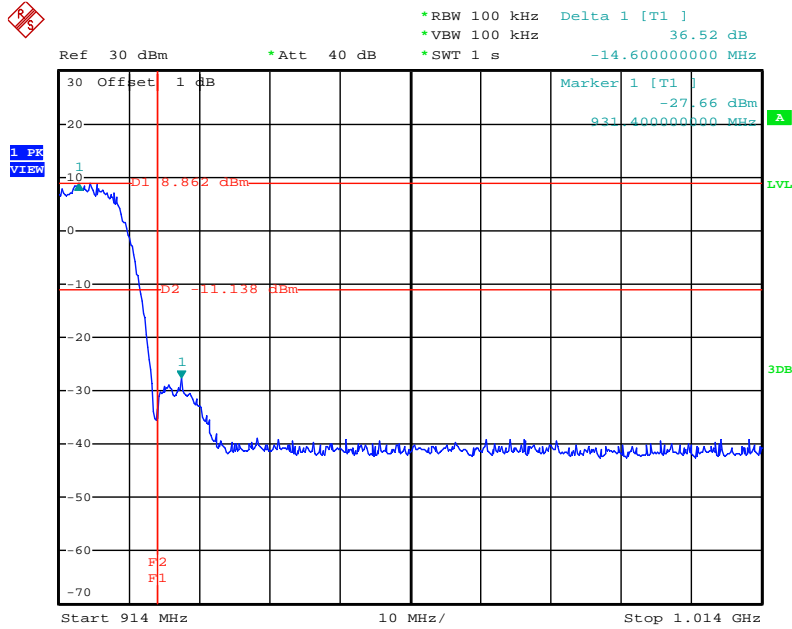

Date: 23.JUN.2011 20:41:48

Low Band Edge Plot on Configuration OFDM / 907 MHz/5M/ Mode 2

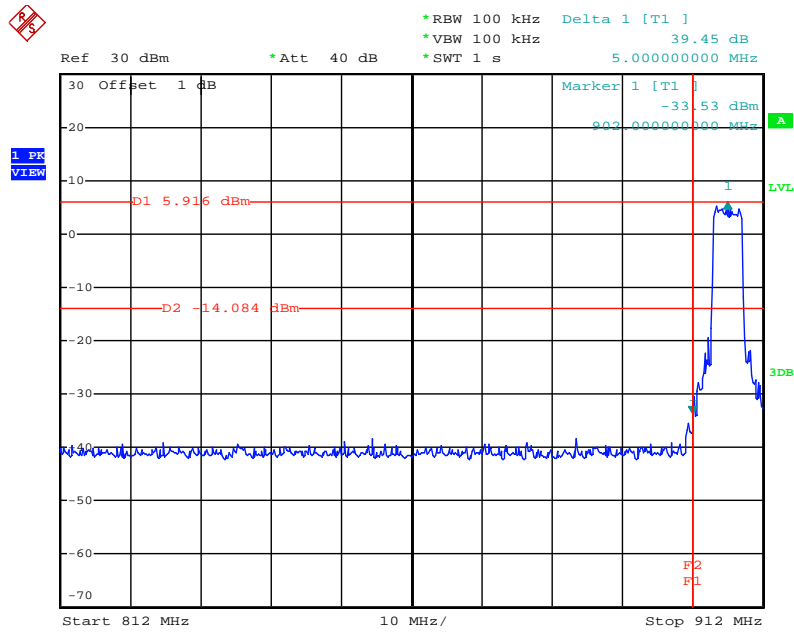

Date: 23.JUN.2011 17:56:37

High Band Edge Plot on Configuration OFDM / 922 MHz/5M/ Mode 2

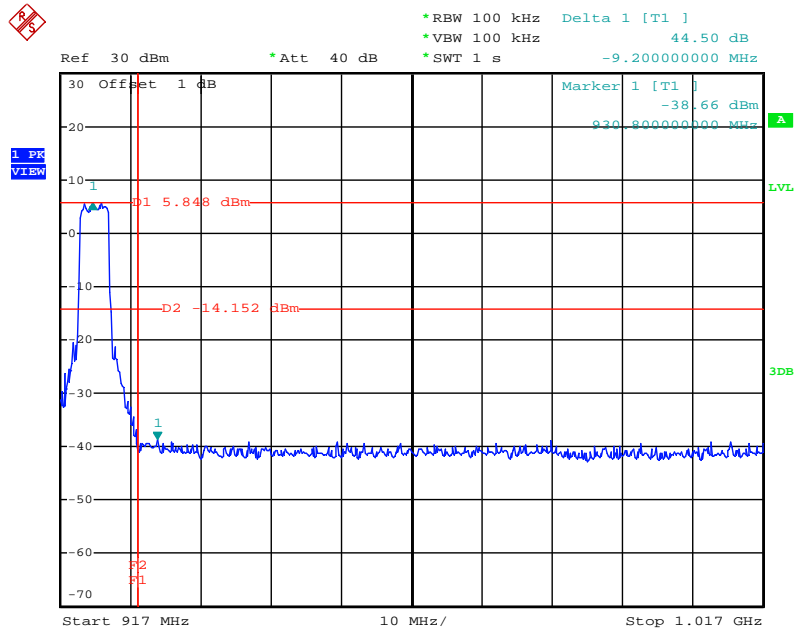

Date: 23.JUN.2011 18:19:54

Low Band Edge Plot on Configuration OFDM / 907 MHz/10M/ Mode 2

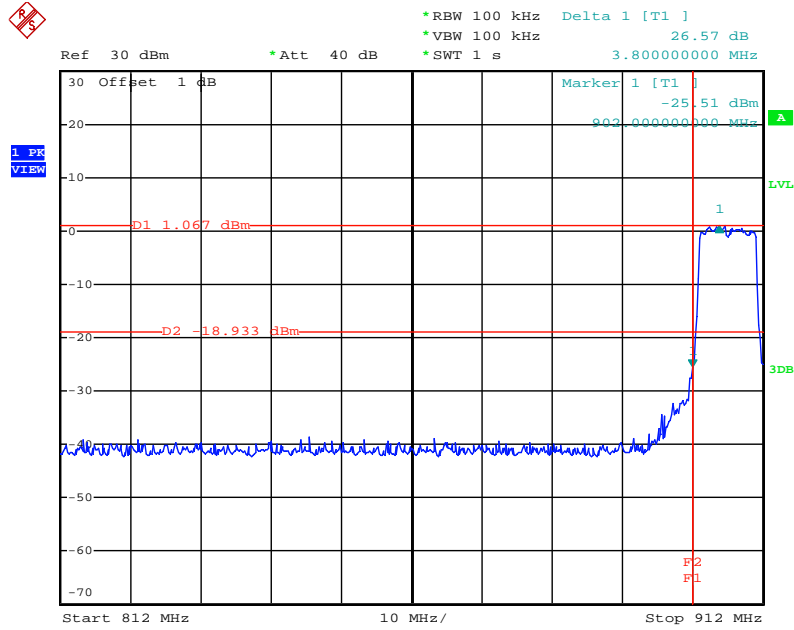

Date: 23.JUN.2011 18:46:28

High Band Edge Plot on Configuration OFDM / 922 MHz/10M/ Mode 2

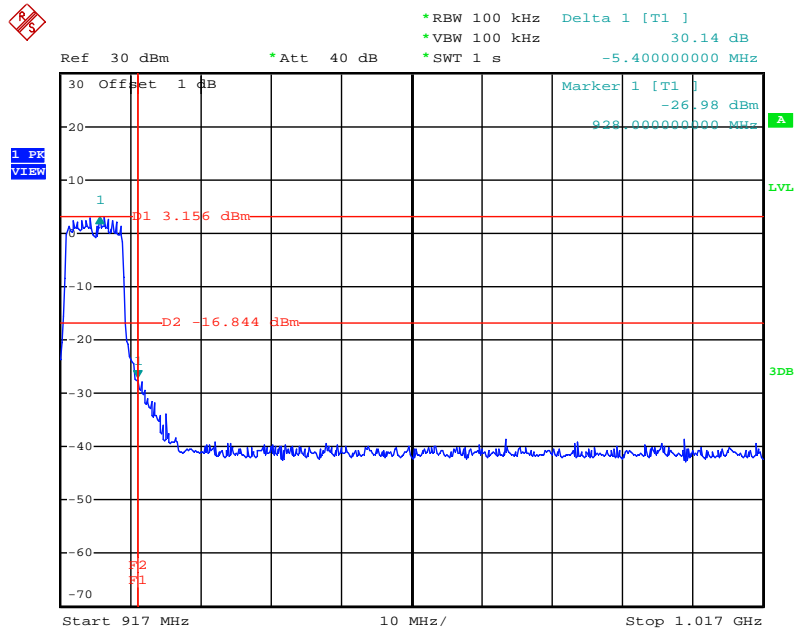

Date: 23.JUN.2011 19:31:25

Low Band Edge Plot on Configuration OFDM / 912 MHz/20M/ Mode 2

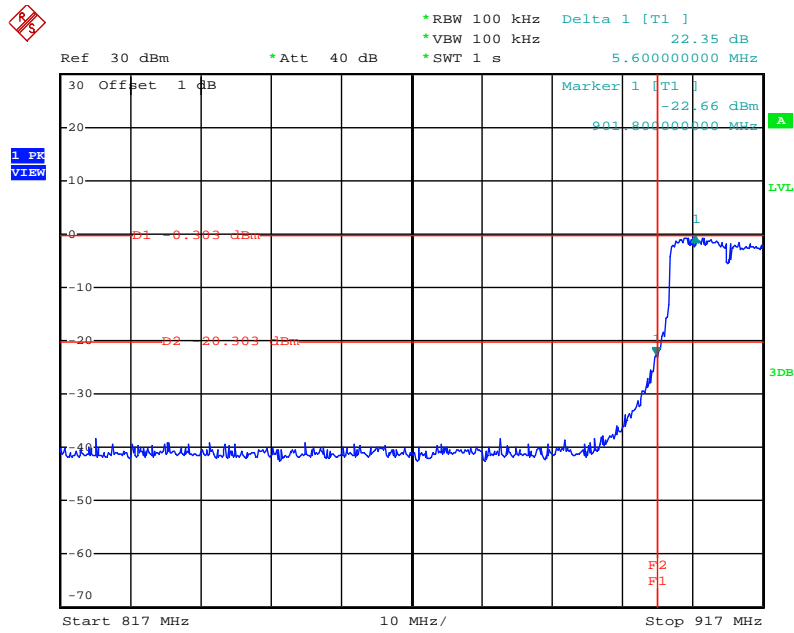

Date: 23.JUN.2011 20:49:50

High Band Edge Plot on Configuration OFDM / 917 MHz/20M/ Mode 2

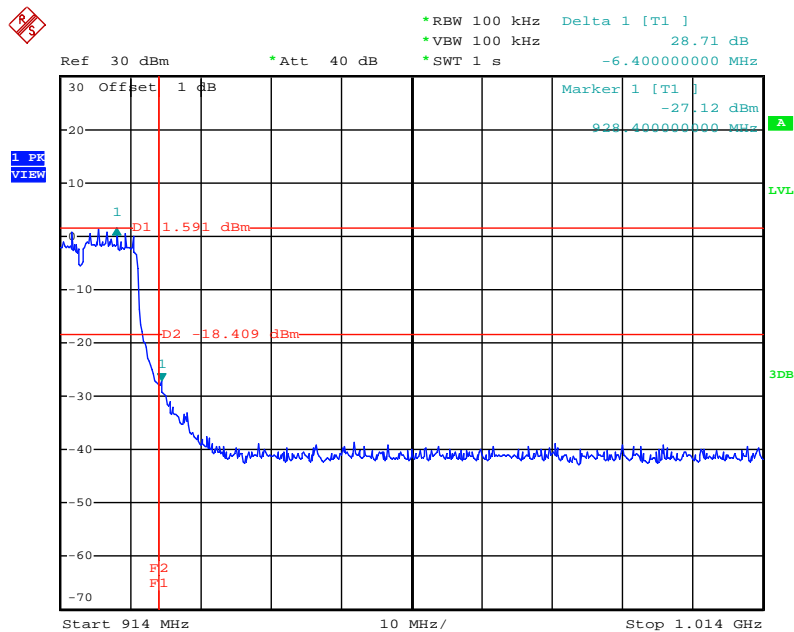

Date: 23.JUN.2011 20:53:01

4.7. Antenna Requirements

4.7.1. Limit

Except for special regulations, the Low-power Radio-frequency Devices must not be equipped with any jacket for installing an antenna with extension cable. An intentional radiator shall be designed to ensure that no antenna other than that furnished by the responsible party shall be used with the device. The use of a permanently attached antenna or of an antenna that uses a unique coupling to the intentional radiator shall be considered sufficient to comply with the provisions of this Section. The manufacturer may design the unit so that the user can replace a broken antenna, but the use of a standard antenna jack or electrical connector is prohibited. Further, this requirement does not apply to intentional radiators that must be professionally installed.

4.7.2. Antenna Connector Construction

Please refer to section 3.3 in this test report; antenna connector complied with the requirements.

5. LIST OF MEASURING EQUIPMENTS

Instrument	Manufacturer	Model No.	Serial No.	Characteristics	Calibration Date	Remark
EMI Test Receiver	R&S	ESCS 30	100377	9kHz ~ 2.75GHz	Sep. 01,2010	Conduction (CO01-CB)
LISN	F.C.C.	FCC-LISN-50-16-2	04083	150kHz ~ 100MHz	Oct. 28,2010	Conduction (CO01-CB)
V- LISN	Schwarzbeck	NSLK 8127	8127-478	9K ~ 30MHz	Nov. 16, 2010	Conduction (CO01-CB)
Capacitive Voltage Probe	SCHAFFNER	CVP2200A	18697	150K ~ 30MHz	Sep. 28, 2010	Conduction (CO01-CB)
RF Current Probe	SOLAR.	ESH2-Z1	041039	9K ~ 30MHz	Sep. 28,2010	Conduction (CO01-CB)
PULSE LIMITER	R&S	ESH3-Z2	100430	9K~30MHz	Jan. 04, 2011	Conduction (CO01-CB)
COND Cable		Cable		0.15MHz~30MHz	Dec.4, 2010	Conduction (CO01-CB)
BILOG ANTENNA	Schaffner	CBL6112D	22021	20MHz ~ 2GHz	Oct. 17, 2010	Radiation (03CH01-CB)
Horn Antenna	EMCO	3115	00075790	750MHz~18GHz	Nov. 22, 2010	Radiation (03CH01-CB)
Horn Antenna	SCHWARZBEAK	BBHA 9170	BBHA9170252	15GHz ~ 40GHz	Oct. 08, 2010	Radiation (03CH01-CB)
Pre-Amplifier	Agilent	8447D	2944A10991	0.1MHz ~ 1.3GHz	Nov. 17, 2010	Radiation (03CH01-CB)
Pre-Amplifier	Agilent	8449B	3008A02310	1GHz ~ 26.5GHz	Nov. 23, 2010	Radiation (03CH01-CB)
Pre-Amplifier	WM	TF-130N-R1	923365	26.5GHz ~ 40GHz	Nov. 17, 2010	Radiation (03CH01-CB)
Spectrum analyzer	R&S	FSP	100304	9kHz ~ 40GHz	Nov. 22, 2010	Radiation (03CH01-CB)
EMI Test Receiver	R&S	ESCS 30	100355	9KHz ~ 2.75GHz	Mar. 22, 2011	Radiation (03CH01-CB)
Loop Antenna	Teseq	HLA 6120	24155	9 kHz - 30 MHz	Sep. 09, 2010*	Radiation (03CH01-CB)
Turn Table	INN CO	CO 2000	N/A	0 ~ 360 degree	N/A	Radiation (03CH01-CB)
Antenna Mast	INN CO	CO2000	N/A	1 m - 4 m	N/A	Radiation (03CH01-CB)
RF Cable-low	Woken	Low Cable-1	N/A	30 MHz - 1 GHz	Nov. 17, 2010	Radiation (03CH01-CB)
RF Cable-high	Woken	High Cable-1	N/A	1 GHz – 26.5 GHz	Nov. 17, 2010	Radiation (03CH01-CB)
RF Cable-high	Woken	High Cable-2	N/A	1 GHz – 26.5 GHz	Nov. 17, 2010	Radiation (03CH01-CB)
RF Cable-high	Woken	High Cable-3	N/A	1 GHz - 40 GHz	Nov. 17, 2010	Radiation (03CH01-CB)
RF Cable-high	Woken	High Cable-4	N/A	1 GHz - 40 GHz	Nov. 17, 2010	Radiation (03CH01-CB)
Spectrum analyzer	R&S	FSV30	101026	9KHz~30GHz	July. 23,2010	Conducted (TH01-CB)

Instrument	Manufacturer	Model No.	Serial No.	Characteristics	Calibration Date	Remark
Thermo-Hygro Meter	N/A	HC 520	#1	15~70 degree	Nov. 02, 2010	Conducted (TH01-CB)
RF Power Divider	HP	11636A	00306	2GHz ~ 18GHz	N/A	Conducted (TH01-CB)
RF Power Splitter	Anaren	44100	1839	2GHz ~ 18GHz	N/A	Conducted (TH01-CB)
RF Power Splitter	Anaren	42100	17930	2GHz ~ 18GHz	N/A	Conducted (TH01-CB)
Power Sensor	Anritsu	MA2411B	0917223	300MHz~40GHz	Sep. 13, 2010	Conducted (TH01-CB)
Power Meter	Anritsu	ML2495A	1035008	300MHz~40GHz	Sep. 08, 2010	Conducted (TH01-CB)

Note: Calibration Interval of instruments listed above is one year.

Note: Calibration Interval of instruments listed above is two year.

6. TEST LOCATION

SHIJR	ADD : 6Fl., No. 106, Sec. 1, Shintai 5th Rd., Shijr City, Taipei, Taiwan 221, R.O.C. TEL : 886-2-2696-2468 FAX : 886-2-2696-2255
HWA YA	ADD : No. 52, Hwa Ya 1st Rd., Kwei-Shan Hsiang, Tao Yuan Hsien, Taiwan, R.O.C. TEL : 886-3-327-3456 FAX : 886-3-318-0055
LINKOU	ADD : No. 30-2, Dingfu Tsuen, Linkou Shiang, Taipei, Taiwan 244, R.O.C TEL : 886-2-2601-1640 FAX : 886-2-2601-1695
DUNGHU	ADD : No. 3, Lane 238, Kangle St., Neihu Chiu, Taipei, Taiwan 114, R.O.C. TEL : 886-2-2631-4739 FAX : 886-2-2631-9740
JUNGHE	ADD : 7Fl., No. 758, Jungjeng Rd., Junghe City, Taipei, Taiwan 235, R.O.C. TEL : 886-2-8227-2020 FAX : 886-2-8227-2626
NEIHU	ADD : 4Fl., No. 339, Hsin Hu 2 nd Rd., Taipei 114, Taiwan, R.O.C. TEL : 886-2-2794-8886 FAX : 886-2-2794-9777
JHUBEI	ADD : No.8, Lane 724, Bo-ai St., Jhubei City, HsinChu County 302, Taiwan, R.O.C. TEL : 886-3-656-9065 FAX : 886-3-656-9085

7. TAF CERTIFICATE OF ACCREDITATION



Certificate No. : L1190-091230

財團法人全國認證基金會
Taiwan Accreditation Foundation

Certificate of Accreditation

This is to certify that

Sporton International Inc.
EMC & Wireless Communications Laboratory
No.52, Hwa Ya 1st Rd., Hwa Ya Technology Park, Kwei-Shan Hsiang, Tao Yuan Hsien,
Taiwan, R.O.C.

is accredited in respect of laboratory

Accreditation Criteria	: ISO/IEC 17025:2005
Accreditation Number	: 1190
Originally Accredited	: December 15, 2003
Effective Period	: January 10, 2010 to January 09, 2013
Accredited Scope	: Testing Field, see described in the Appendix
Specific Accreditation Program	: Accreditation Program for Designated Testing Laboratory for Commodities Inspection Accreditation Program for Telecommunication Equipment Testing Laboratory Accreditation Program for BSMI Mutual Recognition Arrangement with Foreign Authorities

Jay-san Chen

Jay-San Chen
President, Taiwan Accreditation Foundation
Date : December 30, 2009

Pl, total 22 pages

The Appendix forms an integral part of this Certificate, which shall be invalid when use without the Appendix