

What's Included:

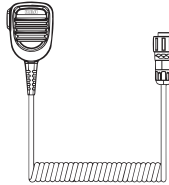

RDR6350U
Mobile Radio



RDR6350U
Mobile Mic

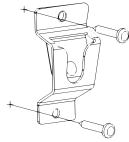

RDR6350U
Mic Hanger

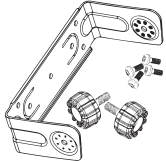

RDR6350U
DC Power Cable

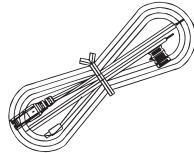

RDR6350U
DC Power Cable

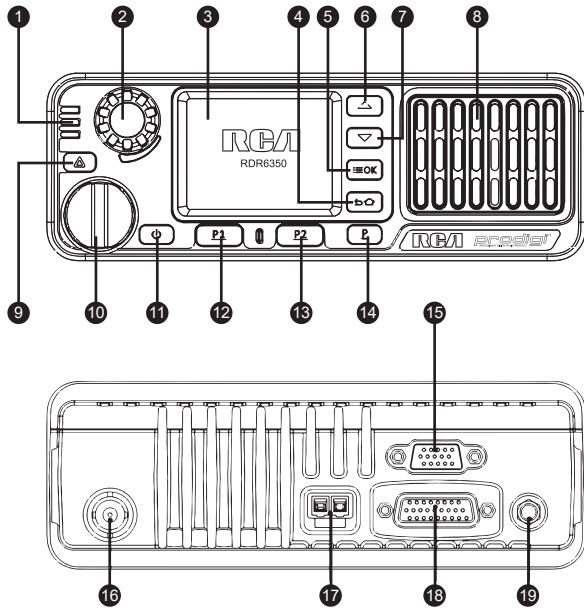

Product Overview:

- | | |
|---|--|
| 1 LED Indicator | 2 Volume Control / Channel Selector Knob |
| 3 LCD Display | 4 Option / Back / Home Button |
| 5 Menu / Enter Button | 6 Up Button |
| 7 Down Button | 8 Speaker |
| 9 Emergency Call Button | 10 Handheld Microphone Interface |
| 11 Power On / Off / On-Hook Button | 12 Enter / P1 Key |
| 13 Cancel / P2 Button | 14 Power Level / Lock / Unlock Button |
| 15 Accessories Interface | 16 RF Antenna Base |
| 17 Power Interface | 18 Accessories Interface |
| 19 Positioning Module Antenna Interface | |

Installation:

Read the following precautions before installing the mobile terminal:

- The radio operates with cathode-grounded power supply of 13.6V ± 15% only. Please check polarity and voltage of the power supply on the vehicle before you install the radio.
- Please check how long the screws will extend from the bottom surface of the radio, before you install the radio. Drill the mounting hole cautiously to avoid damage to the vehicle wiring and other parts.
- Please connect RCA supplied antenna and power cord to the radio, before you install it in the bracket. And make sure the antenna and power cord is dedicated for RCA digital radios to prevent injuries to passengers.
- Set the mobile terminal in a location convenient on the front panel for easy operation.
- Please make sure there's sufficient space at back of the radio for wiring.
- When the fuse for DC power cord needs replacement, it must be replaced by a fuse with the same specification.

Installation Tools:

Electric Drill, Philips Head Screwdriver, and Hex Socket Sleeve

Installation Diagram:

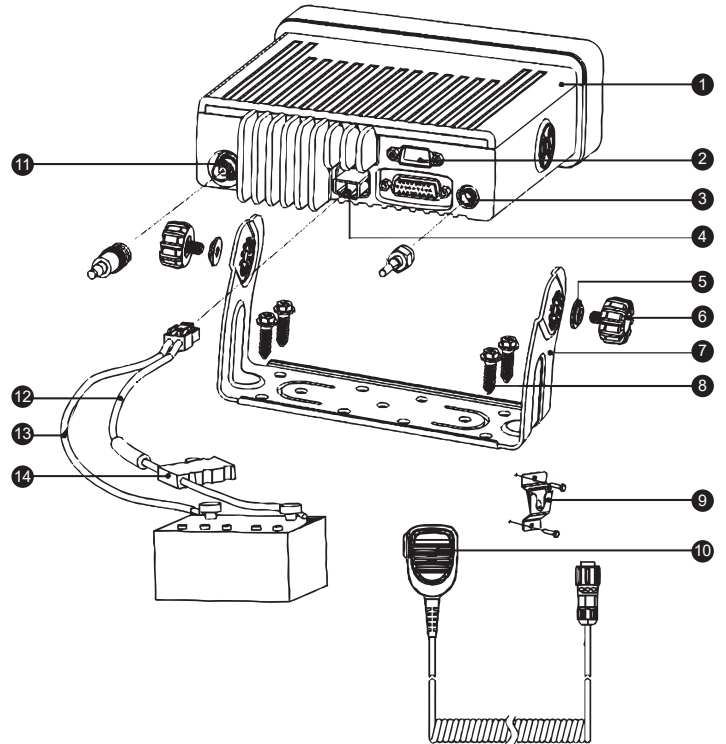

- Install the bracket 7 with cross screw 8 in a proper position.
- Connect the accessories such as the radio antenna and power cord to the mobile 1.
- Slide the mobile radio 1 into the mounting bracket 7 and fix it with cross screw 6.
- Install the microphone hanger 9 in a location where it's easy to reach the microphone.
- Plug the handheld microphone 10 into the microphone jack on the front panel of mobile radio 1 and place it on the hanger when not in use.

- | | |
|--|-------------------------------|
| 1 Mobile Radio | 2 Accessory Interface |
| 3 Positioning Module Antenna Interface | 4 Power Supply Socket |
| 5 Hardware Bracket Knob Underlay | 6 Hardware Bracket Knob |
| 7 U-Shaped Bracket | 8 M6 Self-tapping Cross Screw |
| 9 Handheld Microphone Hanger | 10 Handheld Microphone |
| 11 RF Antenna Base | 12 Red Power Line |
| 13 Black Power Line | 14 Fuse |

Basic Operations

Turning on/off radio

Short press [Power On / Off / On-hook] button to turn on the radio, LCD displays power-up LOGO, and then enter the standby screen, and then long press [Power On / Off / On-hook] button to shutdown.

Note: If a fault occurs and the radio does not turn off, you can press and hold the [Power On / Off / On-hook] button for more than 10 seconds with the forced shutdown and restart it.

Knob Switch Mode

Short press the knob, to switch the two modes between volume and channel/group.

Radio Mode

The mobile terminal supports conventional and trunking mode, switching as below:

1. Press [Option/ Back/ Home] button to bring up the option menu;
2. Press [Up]/ [Down] button to select 'Radio mode' and press [Menu / Enter] button to enter the list of radio mode;
3. Press [Up]/ [Down] button to select 'Conventional' or 'Trunking' mode, press [Menu / Enter] button to switch modes.

Note: In conventional mode the radio can communicate directly or via repeater inter-communicate; in trunking mode, the mobile terminal is connected by the base station, to realize the function of real-time dispatchment.

Adjust the volume

When the Volume Control / Channel Selector knob operates in volume adjustment mode, rotate the knob clockwise to increase the call volume, or counterclockwise to decrease volume.

Adjusting the Power Level

Press [Power Level / Lock / Unlock] button to change the transmitting power level to 'High/ Mid/ low', and also the icon of the power level will be changed in the main menu.

Lock and Unlock

Long press [Power Level / Lock / Unlock] button can activate the keylock function, in case of wrong operation. Deactivate the keylock by long.

Switching Channel / Group

When in the channel/ group switching mode, turn the knob to select channel/ group.

In addition you can also switch the channel/group in the menu:

1. Press [Option/ Back/ Home] button to go to the 'Option' menu.
2. Press [Up / Down] button to select 'Channel Management / Group Management', press [Enter] to enter the channel / group folder list.
3. Press [Up]/ [Down] button to select the channel / group folder, press [Enter] to enter the channel / group list.
4. Press [Up]/ [Down] button to select the channel/ group, press [Enter] button to switch channel / group.

Note:

- 'Channel Management' and 'Group Management' are folders set up for classified management of channels and groups in conventional mode and trunking mode.
- This mobile terminal supports up to 64 channels / group folders, each folder contains up to 100 channels / groups, and please set it up via the dealer.

Call

Individual Call

Initiate the Individual Call

1. Input an individual call number you would like to call using the microphone with a keypad, or enter 'Phonebook' / 'Call Log' / 'Messages', to select the Contact/ Messages;
2. Hold down the [PTT] button on the handheld microphone to transmit an individual call to the selected contact or message contact.

Receive and Call Back

1. When the [PTT] button is idle, without any actions of buttons, the mobile radio could receive call.
2. You can hold down [PTT] button to call back after the calling party finishes talking.

Group Call

The groups are preset by the dealer, operating method in conventional and trunking modes is the same.

Initiate Group Call

1. At standby screen, short press [Volume Control / Channel Selector] button, then rotate to select channel / group that you want to call.
2. Press [Enter] button to confirm the selected channel / group, or wait for it to confirm automatically.
3. Hold down [PTT] button on handheld microphone to initiate group call.

Receive and Call Back

1. When [PTT] button is idle, without any actions of buttons, the mobile radio could receive call.
2. You can hold down [PTT] button to call back after the calling party finishes talking.

Care and Cleaning

To guarantee optimal performance as well as a long service life of your radio, please follow the tips below.

Radio Care

Keep the radio far away from substances that can corrode the electronic circuit.

Radio Cleaning

Clean up the dust and fine particles on the radio surface with a clean and dry lint-free cloth or a brush regularly.

Use neutral cleanser and a non-woven fabric to clean the keys, control knobs and microphone after long-time use. Do not use chemical preparations such as stain removers, alcohol, sprays or oil preparations, so as to avoid surface case damage. Make sure that the radio is completely dry before use.





















NOTE: Turn off the radio before cleaning.

LED indicator

LED Indication	Radio Status
LED Glows Red	Transmitting
LED Glows Green	Receiving
LED Glows Green & Flashing Slowly	Standby

STATUS INDICATION IN RADIO

LCD Icon

Icon Name	Icon	Radio Status
RSSI		No Signal
		More bars indicate better signal strength
Message Icons		New message/unread message
		Inbox is full
Working Mode Icons		Indicates in trunking mode
		Indicates in conventional mode
Power Level Icons		Indicates Low-Power transmission
		Indicates Mid-Power transmission
		Indicates High-Power transmission
Profiles Icon		Indicates the silent mode is enabled
		Indicates the standard mode is enabled
		Indicates the custom mode is enabled
Accessory Icon		Accessory is plugged in
Handheld Mic Icon		Handheld Mic is plugged in
Call Status Icon		Indicates currently talking
		Indicates missed calls
Channel / Group Selection Icon		Indicates in-channel selection mode
Encryption Icon		Encryption ON
Positioning Icon		Positioning feature is active and valid positioning data is received
		Positioning feature is active but no valid positioning data is received

Warning !

Any Changes or modifications not expressly approved by the party responsible for compliance could void the user's authority to operate the equipment.

This device complies with part 15 of the FCC Rules. Operation is subject to the following two conditions: (1) This device may not cause harmful interference, and (2) this device must accept any interference received, including interference that may cause undesired operation.

Note: This equipment has been tested and found to comply with the limits for a Class B digital device, pursuant to part 15 of the FCC Rules. These limits are designed to provide reasonable protection against harmful interference in a residential installation. This equipment generates, uses and can radiate radio frequency energy and, if not installed and used in accordance with the instructions, may cause harmful interference to radio communications. However, there is no guarantee that interference will not occur in a particular installation. If this equipment does cause harmful interference to radio or television reception, which can be determined by turning the equipment off and on, the user is encouraged to try to correct the interference by one or more of the following measures:

- Reorient or relocate the receiving antenna.
- Increase the separation between the equipment and receiver.
- Connect the equipment into an outlet on a circuit different from that to which the receiver is connected.
- Consult the dealer or an experienced radio/TV technician for help.

This equipment complies with FCC ~~EMC~~ radiation exposure limits set forth for an controlled environment .This equipment ~~(Class C)~~ should be installed and operated , ~~at a~~ minimum distance of 80 cm between the antenna & body.

RF exposure statement

To control your exposure and ensure compliance with the occupational/controlled environment exposure limits always adhere to the following procedures.

Guidelines:

Do not remove the RF Exposure Label from the device.

User awareness instructions should accompany device when transferred to other users.

Do not use this device if the operational requirements described herein are not met.

Operating Instructions:

Transmit no more than the rated duty factor of 50% of the time. To transmit(talk), push the Push-To-Talk(PTT)button. To receive calls, release the PTT button. Transmitting 50% of the time, or less, is important because this radio generates measurable RF energy exposure only when transmitting(in terms of measuring for standards compliance).

Use only manufacturer's name approved supplied or replacement antennas, and accessories.

Use of non-manufacturer-name approved antennas, and accessories may exceed the RF exposure guidelines. The max antenna gain allowed is 5.5 dBi.

ISED Compliance statement

This device complies with Industry Canada licence-exempt RSS standard(s).
Operation is subject to the following two conditions:

- (1) this device may not cause interference, and
- (2) this device must accept any interference, including interference that may cause undesired operation of the device.

Le présent appareil est conforme aux CNR d'Industrie Canada applicables aux appareils radio exempts de licence. L'exploitation est autorisée aux deux conditions suivantes : (1) l'appareil ne doit pas produire de brouillage, et (2) l'utilisateur de l'appareil doit accepter tout brouillage radioélectrique subi, même si le brouillage est susceptible d'en

Cet équipement est conforme aux limites d'exposition de rayonnement ISED établies pour un environnement contrôlé. Cet équipement doit être installé et utilisé avec une distance minimale de 80cm entre le radiateur et votre corps.