

**Congratulations on selecting the RDR5200 from
RCA Communications Systems
- The most trusted name in radios!**

The RDR5200 digital professional communications products are based on DMR technology and establish a benchmark in premium digital two-way radio equipment. These radios are made to perform flawlessly under the most demanding commercial conditions and feature cutting edge design, high-end professional grade materials and components, simple operation and superior assembly quality. RDR5200 mobiles and base stations are covered by a three-year “Warranty Protection Program,” one of the most comprehensive warranties in the communications industry.

To ensure you achieve maximum performance from your RDR5200 radio, please be sure to carefully read this manual.

MODELS COVERED IN THIS MANUAL:

- RDR5200V - VHF Two-Way Radio
- RDR5200U - UHF Two-Way Radio



CONTENTS:

Product Inspection2

RCA RDR5200 Mobile Overview2

What's Included2

Transceiver Installation3

 Tools Needed3

 Installing Mounting Bracket3

 DC Power Cable Connection3

 Mobile Operation3

 Fixed Station Operation4

 Replacing Fuses4

 Antenna Connection4

 Accessory Connections4

 External Speaker4

 Microphone Jack5

 Microphone Hanger5

Transceiver Features5

 Operational Status Indicators5

 Display Icons5

 Call Icons6

 Sent Item Icons6

 Audio Tones6

Making and Receiving Calls6

 Receiving a Call6

 Transmitting a Call6

 Select A Channel6

 Setting the Squelch Level (Analog)6

Switching Between Analog/Digital Mode6

Programmable Buttons6

 Accessing Programmed Function/Menu7

 Keypad Mic (Optional MM301HDK)*7

Using Menu/Programmed Functions7

 Selecting a Zone7

 Selecting Radio Channel/Subscriber/Group ID...7

 Receiving/Responding to a Radio Call7

 Receiving/Responding to a Group Call7

 Receiving/Responding to a Private Call8

 Receiving an All Call8

 Monitoring a Channel (Analog)8

CONTENTS: (continued)

Making a Radio Call8

Making a Call With Channel Selector Buttons ..8

Making a Private Call8

Making an All Call8

Making Group/Private Call W/1 Touch Button ..8

Emergency Operation8

Initiating/Responding to Emergency Alarm9

Exiting Emergency Mode9

Advanced Features9

 Public Address9

 Radio Check9

 Sending a Radio Check9

 Remote Monitor9

 Initiating Remote Monitor9

 Contacts Settings9

 Group Call from Contacts9

 Private Call from Contacts9

 Call Indicator Settings/Call Tones10

 Call Tones for Text Messages10

 Assigning Alert Tones10

 Accessing the Call Log.....10

 Storing Alias or ID from Missed Call List.....10

 Deleting a Call from the Call List.....10

 Receiving & Responding to Call Alert.....10

 Making Call Alert from Contact List.....10

Text Message Features11

 Navigate to Message.....11

 Receiving/Reading a Text Message11

 Managing Received Text Messages11

 Viewing Inbox Text Messages11

 Writing/Sending Text Message11

 Sending a Quick Text Message.....11

 Managing Fail-to-Send Text Messages.....11

 Resend a Text Message.....11

 Forwarding a Text Message.....11

 Managing Sent Text Message11

 Viewing Sent Text Messages.....12

 Deleting All Sent Messages from Sent Items12

 Replying to an Inbox Text Message12

 Deleting a Text Message from Inbox12

Privacy12

Dual Tone Multi Frequency (DTMF) Analog12

Security13

 Radio Disable13

 Radio Enable13

Scan Lists13

 Viewing an Entry in the Scan List13

 Scan Instructions and Methods.....13

 Starting and Stopping Scan13

 Responding to a Scan.....13

Deleting/Restoring A Nuisance Channel.....13

Utilities13

 Keypad Locked/Unlocked*13

 Keypad Tones*14

 Setting the Power Level.....14

 Voice Operating Transmission (VOX) On/Off14

Controlling the Display Backlight14

 Talkaround.....14

Turning Radio Tones/Alerts On or Off14

Turning the LED Indicator On or Off14

Turning the Introduction Screen On or Off14

Accessing General Radio Information/Checking Radio ID15

Care and Cleaning15

Customer Support Contact Info.....15

Troubleshooting15

PRODUCT INSPECTION

Prior to unpacking your RDR5200 radio, please inspect the packaging for signs of damage and report any damage or missing components immediately to your RCA Communications Systems Sales and Service Center. Every RDR5200 mobile radio comes with the following items:

Item	PCS
Radio Unit (RDR5200)	1
Palm Microphone (MM300HD)	1
Microphone Hanger/Screws (3)	1
Radio Mounting Bracket	1
Self-Tapping Screws	4
SEMS Screws (screw/washer)	4
Spring Washers / Flat Washers	4 / 4
Fuse	1
DC Power Cord (w/2 fuses)	1

What's Included:

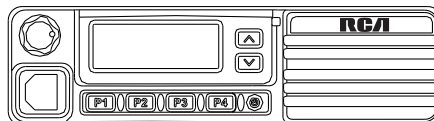

RDR5200
Mobile Radio

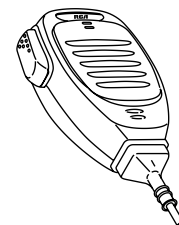

MM301HD
Standard Mobile Mic

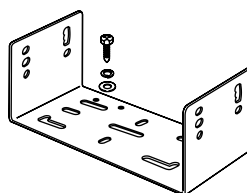

RMK300
Mobile Mounting
Bracket

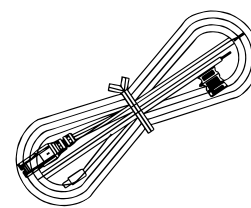

PC300
Mobile Power
Supply Cable

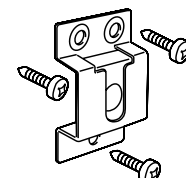

HGRMM300
Mic Hanger

RCA RDR5200 Mobile Overview

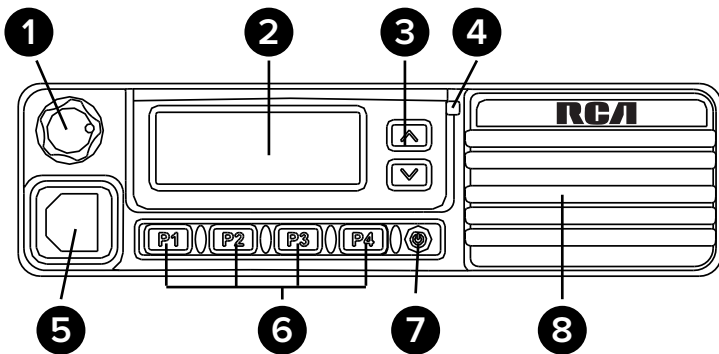

RDR5200 Front

- 1 Volume Control Knob / Programmable Button
- 2 LCD Display
- 3 Select A Channel / Programmable Buttons
- 4 LED Indicator
- 5 Microphone Jack
- 6 Programmable Buttons P1-P4
- 7 On / Off Button
- 8 Internal Speaker

Transceiver Installation:

Tools Needed:

- Electric Drill with 6mm bit or above
- Philips Head Screwdriver
- Hex Socket Sleeve (used for mounting 5mm X 16mm self-tapping screw)

When installing your transceiver, be sure to select a safe, convenient location. If you're installing inside your vehicle, choose a location that minimizes danger to your passengers and yourself while the vehicle is in motion. Consider installing the unit so that knees or legs will not strike the unit during vehicle operation. Try to pick a well ventilated location that is shielded from direct sunlight for your installation location.

Install the mounting bracket in the vehicle using the supplied self-tapping screws (4), flat washers (4), and spring washers (4). Position the bracket so that the 3 long screw hole positions on the side of the mounting bracket are towards the rear of the bracket. (Figure 1)

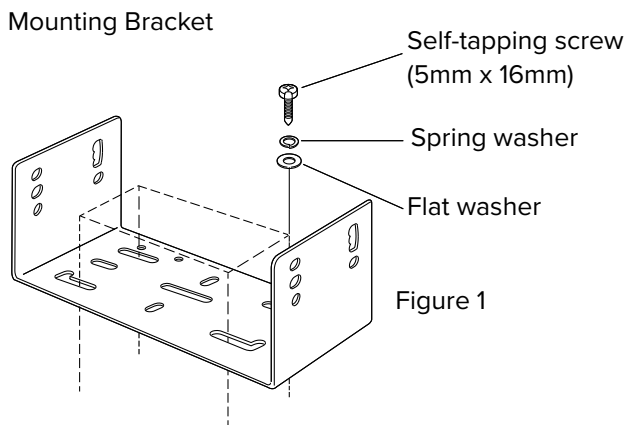

Figure 1

Use the 3 screw positions on the side of the mounting bracket to determine the appropriate angle of the transceiver. (Figure 2)

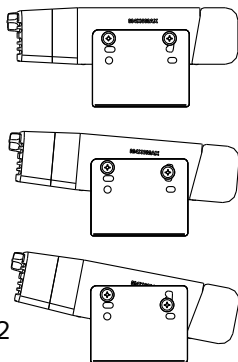

Figure 2

Position the transceiver, then insert and tighten the supplied hexagon SEMS screws (4) and flat washers (4). (Figure 3) Double check that all hardware is securely fastened to ensure that vehicle vibration will not loosen the bracket or transceiver.

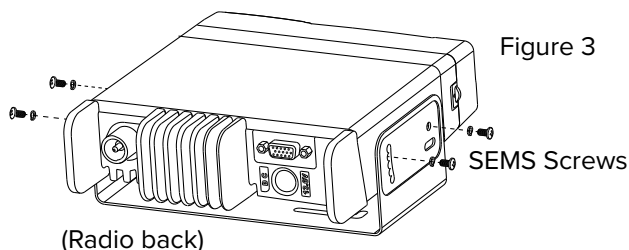

Figure 3

DC Power Cable Connection

Mobile Operation

Your vehicle battery must have a nominal rating of 12V. Never connect the transceiver to a 24V battery. Be sure to use a 12V vehicle battery that has sufficient current capacity. If the current to the transceiver is insufficient, the display may darken during transmission, or transmit output power may drop excessively.

1. Route the DC power cable supplied with the transceiver directly to the vehicle's battery terminals using the shortest path from the transceiver. If using a noise filter, it should be installed with an insulator to prevent it from touching metal on the vehicle. We recommend you do not use the power outlet/cigarette lighter socket as some power outlets have an unacceptable voltage drop. The entire length of the cable must be dressed so it is isolated from heat, moisture and the engine secondary (high voltage) ignition system/cables.
2. After the cable is in place, wrap heat-resistant tape around all fuse holders to protect it from moisture and tie down the full run of cable.
3. To prevent the risk of short circuiting, disconnect other wiring from the negative (-) battery terminal before connecting the transceiver.
4. Confirm the correct polarity of the connections, then attach the power cable to the battery terminals; red connects to the positive (+) terminal and black connects to the negative (-) terminal. Use the full length of the supplied cable without cutting off excess even if the cable is longer than required. In particular, never remove the fuse holders from the cable. (Figure 4)

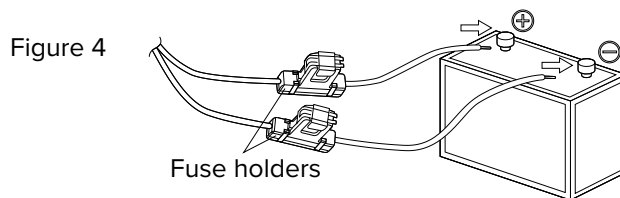

Figure 4

5. Reconnect any wiring removed from the negative terminal.
6. Connect the DC power cable to the transceiver's power supply connector. Press the connectors firmly together until the locking tab connectors firmly together until the locking tab clicks. (Figure 5)

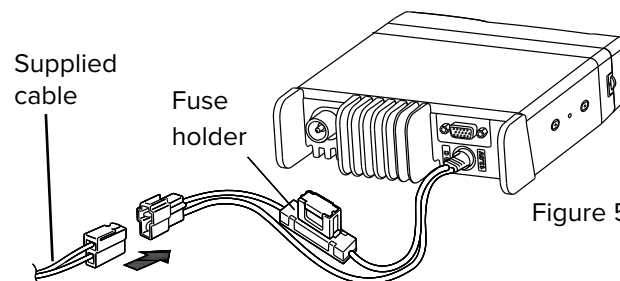
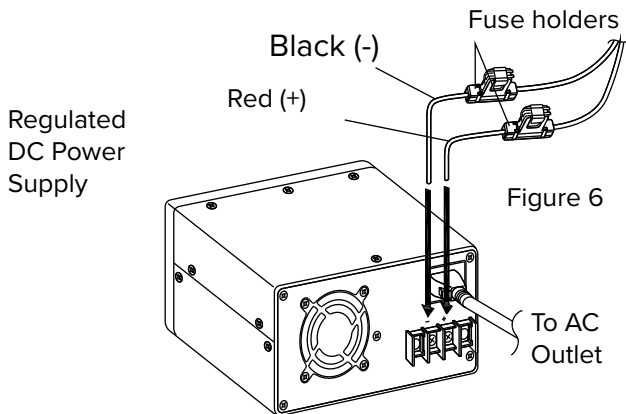

Figure 5

Fixed Station Operation

In order to use this transceiver in a fixed station operation, you will need a separate 13.8V DC power supply (not included). The recommended current capacity of your power supply is 14A or more.

1. Connect the DC power cable to the regulated DC power supply and ensure that the polarities are correct (Red: positive, Black: negative).
 - Do not directly connect the transceiver to an AC outlet.
 - Use the supplied DC power cable to connect the transceiver to a regulated power supply. Do not substitute a cable with smaller gauge wires. (Figure 6)



2. Connect the transceiver's DC power connector to the connector on the DC power cable. Press the connectors firmly together until the locking tab clicks. (See Figure 5)

NOTE:

- For your transceiver to perform properly, we recommend using a power supply with an output of more than 23A/25% duty cycle.
- Before connecting the DC power supply to the transceiver, be sure to switch the transceiver and the DC power supply OFF.
- Do not plug the DC power supply into an AC outlet until you make all connections.

Replacing Fuses

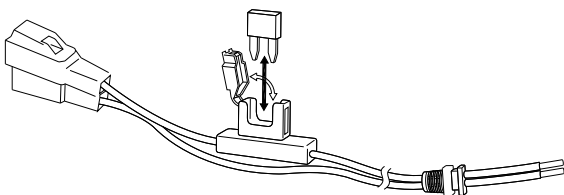

If a fuse blows, most times it indicates a problem. Check the power source and the power cables to determine the cause and then correct the problem. Once the problem is resolved, replace the fuse. (See Figure 7.) If newly installed fuses continue to blow, disconnect the power cable and contact your authorized RCA Dealer for assistance.

Fuse Location	Fuse Current Rating
Transceiver	15A
Supplied Accessory DC Power Cable	15A

CAUTION

Only use fuses of the specified type and rating; otherwise the transceiver can be damaged.

Note:

If you use the transceiver for a long period when the vehicle battery is not fully charged or when the engine is OFF, the battery may become discharged and may not have sufficient reserves to start the vehicle. Avoid using the transceiver under these conditions.

Antenna Connection

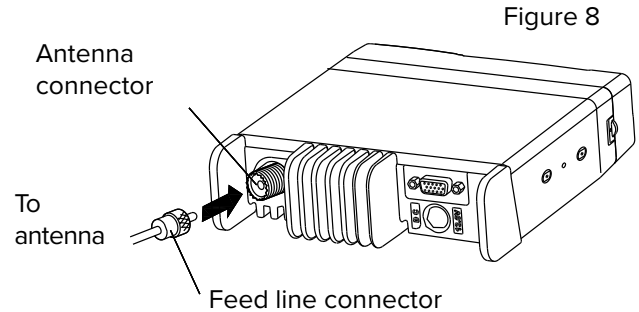

Before operating the radio, install an efficient, well-tuned antenna. The success of your radio installation will depend largely on the type and installation of your antenna. The transceiver will provide excellent results if the antenna system and radio installation are handled properly. (Figure 8)

Use a 50 Ω impedance antenna and low-loss coaxial feed line that has a characteristic impedance of 50 Ω to match the transceiver input impedance. Coupling the antenna to the transceiver via feed lines having an impedance other than 50 Ω reduces the efficiency of the antenna system and can cause interference to nearby broadcast television and radio receivers, and other electronic equipment.

CAUTION

- **Transmitting without first connecting an antenna or other matched load may damage the transceiver. Always connect the antenna to the transceiver before transmitting.**
- **All fixed stations should be equipped with a lightning arrester to reduce the risk of fire, electric shock, and transceiver damage.**

Accessory Connections

External Speaker

If you plan to use an external speaker, choose a speaker with an impedance of 8 Ω. The external speaker jack accepts a 1/8" (3.5 mm) mono (2-conductor) plug. (Figure 9)

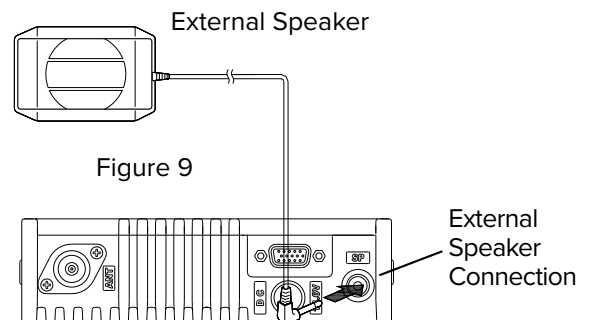

Microphone Jack

For voice communications, connect a 600 Ω microphone equipped with an 8-pin modular plug into the modular socket on the front of the main unit. Press firmly on the plug until the locking tab clicks. (Figure 10)

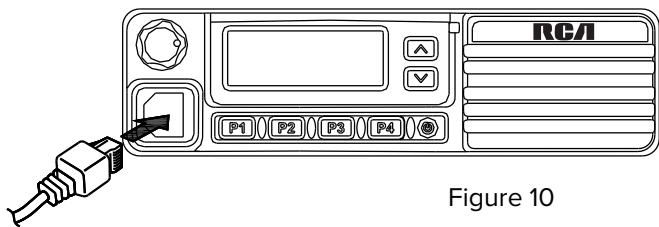

Figure 10

Microphone Hanger

Attach the supplied microphone hanger using included screws in an easy to access location that will not interfere with vehicle operation. (Figure 11)

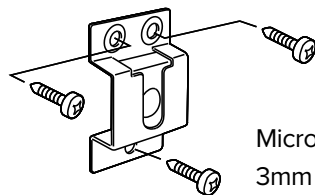
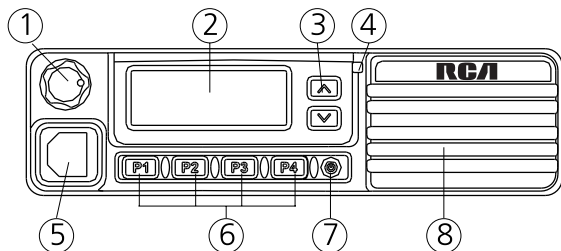

Figure 11

Microphone hanger screws -
3mm x 10mm

TRANSCEIVER FEATURES



1. Volume Control Knob/Programmable Button

Turn the Volume Control clockwise to increase radio volume and counterclockwise to reduce radio volume. For Programmable Button information, please see below.

Note: If the radio is programmed with CTCSS/CDCSS or 2-Tone, MDC1200, Signaling squelch, nothing will be heard from speaker even if you turn the Volume Control Knob clockwise to maximum volume.

2. LCD Display

See “Status Indicators” for display details.

3. Select a Channel/Programmable Buttons

For Programmable Button information, please see below.

4. LED Indicator - LED Indicator identifies radio status.

- **Blinking Orange** - Radio is scanning, receiving an emergency transmission or has failed a self-test.
- **Solid Red** - Radio is transmitting.
- **Solid Green** - Radio is receiving or carrier is present/busy channel.
- **Rapidly Blinking Green** - Radio is receiving a privacy-enabled call or data.

Note: When the LED is solid green, it indicates the radio detects activity over the air. Due to the nature of the digital protocol, this activity may or may not affect the radio’s programmed channel.

5. Microphone Jack

For voice communications, connect a 600 Ω microphone equipped with an 8-pin modular plug into the modular socket on the front of the main unit. Press firmly on the plug until the locking tab clicks. (Figure 10)

6. Programmable Buttons P1 - P4

For Programmable Button information, please see below.

7. On/Off Button

Press the On/Off Button to turn on the radio. Press and hold down the On/Off Button for about 1 second to turn off the radio.

8. Internal Speaker











Operational Status Indicators

Your radio indicates its operational status through the following:

- Display Icons
- Call Icons
- Sent Item Icons
- LED Indicator
- Audio Tones

Display Icons

The LCD display shows radio status, text entries, and menu entries. The following icons will appear on the radio’s display.

-  **Received Signal Strength Indicator (RSSI)** - The number of bars displayed represents the radio signal strength and is only displayed while the radio is in receiving mode.
-  **Monitor** - Selected channel is being monitored.
-  **Power Level** - Radio is set at Low power. Radio is set at High power.
-  **Tones Disable** - Tones are turned off.
-  **Scan** - Scan feature is enabled.
-  **Priority Scan** - Radio detects activity on channel/group designated as Priority 1 (if “•” is blinking) or Priority 2 (if “•” is steady)
-  **Unread Message** - The radio has unread message(s) in the Inbox.
-  **Inbox Full** - The radio’s Inbox is full.
-  **Emergency** - Radio is in Emergency mode.
-  **Privacy** - The Privacy feature is enabled.
-  **Talkaround** - The radio is currently configured for direct radio to radio communication.

Call Icons

The following icons appear on the radio's display during a call and in the Contacts list to indicate ID type.

 **Private Call** - Indicates a Private Call in progress. In the Contacts list, it indicates a subscriber alias (name) or ID (number).

 **Group Call/All Call** - Indicates a Group Call or All Call in progress. In the Contacts list, it indicates a group alias (name) or ID (number).

Sent Item Icons

The following icons appear at the top right corner of the radio's display in the Sent Items folder.

 **Sent Successfully** - The text message is sent successfully.

 **Send Failed** - The text message cannot be sent.

 **In-Progress** - The text message to a group alias or ID is pending transmission.

Audio Tones

Alert tones provide you with audible indications of the radio's status or the radio's response to data received.

Continuous Tone - A monotone sound.

Sounds continuously until termination.

Periodic Tone - Sounds periodically depending on the duration set by the radio.

Repetitive Tone - A single tone that repeats itself until it is terminated by the user.

Momentary Tone - Sounds only once for a short period of time defined by the radio.

Making and Receiving Calls

Receiving a Call

If CTCSS/CDCSS, 2-Tone, MDC1200 is set on the current channel by your RCA dealer, you can only receive calls with matched signaling. If CTCSS/CDCSS, 2-Tone, MDC1200 is not set, you can hear all users on the channel selected.

Transmitting a Call

To transmit a call:

1. Hold the microphone about 2" from your mouth when speaking and press the [PTT] (push to talk) button. (Figure 12) The red LED lights during call.
2. Release [PTT] to return to the receive/listen (RX) mode.

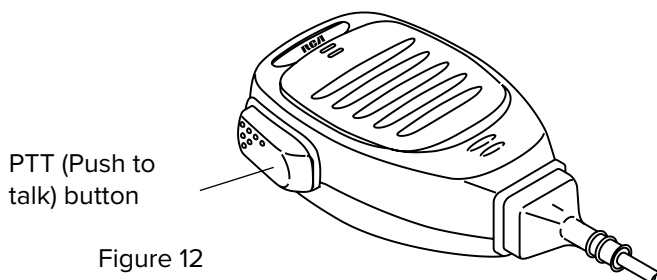

Figure 12

Note on PTT: If the Talk Permit Tone is enabled, wait until the short alert tone ends before talking.

During a call, if the Channel Free Indication feature is enabled on your radio (programmed by your RCA Communications Systems Dealer), you will hear a short alert tone the moment the target radio (the radio that is receiving your call) releases the PTT button, indicating the channel is free for you to respond. You will also hear the Channel Free Indication tone if your call is interrupted, for example, when the radio receives an Emergency Call.

Select A Channel

Press [▲] or [▼] to switch between channels.

Channels can be configured as analog or digital channel. Your radio has features that are available in both analog and digital mode. The minor differences in the way each feature works does not affect the performance of your radio.

Setting the Squelch Level (Analog)

You can adjust your radio's squelch level to filter out unwanted calls with low signal strength or channels that have a higher than normal background noise.

Settings: Normal is the default level. Tight may help to filter out (unwanted) calls and / or background noise. However, calls from radio within your system that are in very remote locations may also be filtered out.

Press the pre-programmed Squelch button to toggle squelch level between normal and tight. OR - follow the procedure below to adjust the Squelch Level through the Menu.

1. Press [Volume Knob (VK)] to access the menu.
2. Press [▲] or [▼] to navigate to Utilities and press [VK] to select.
3. Press [▲] or [▼] to navigate to Radio Settings and press [VK] to select.
4. Press [▲] or [▼] to navigate to Squelch and press [VK] to select.
5. Choose either Tight or Normal and press [VK] button, screen returns to the previous menu.

Switching Between Analog/Digital Mode

Each channel in your radio can be programmed as an analog channel or a digital channel. Use the Channel Selector Knob to switch between an analog or a digital channel.

Note: When switching from digital to analog, some features of the radio become unavailable.

PROGRAMMABLE BUTTONS

Your RCA Communications Systems Dealer can program the P1, P2, P3, P4, ▲, ▼ and the volume knob button as shortcuts to radio functions or preset channels/groups. Several buttons can be set up with 2 different programmable functions depending on the duration of a button press:

- Short Press - Press and release quickly.
- Long press - Press and hold for the programmed duration (between 1 seconds and 3.75 seconds).

Programmable Functions:

- **All Alert Tones On/Off** - Toggles all tones and alerts on or off.
- **Channel Up/Down** - Switches between programmed channels.
- **Emergency On/Off** - Initiates/cancels an emergency alarm or call.
- **High/Low Transmit Power** - Toggles transmit power level between high and low.

- **Lone Worker On/Off** - Toggles Lone Worker feature On or Off, on per channel basis.
- **Manual Dial For Private** - Enables user to manually enter a radio ID for a private call.
- **Monitor On/Off** - Monitors a selected channel for activity.
- **Nuisance Delete** - Temporarily removes an unwanted channel, except the Selected Channel, from the scan list. The Selected Channel refers to the user's selected zone/channel combination from which scan is initiated.
- **One Touch Access** - Directly initiates a predefined Private or Group Call, a Call Alert or a Quick Text message.
- **Privacy On/Off** - Toggles emergency alarm or call on or off.
- **Public Address** - Turns public address system on or off.
- **Repeater/Talkaround** - Circumvents a repeater to talk directly to another radio.
- **RF Power Switch** - Toggles between low and hi power.
- **Scan On/Off** - Toggles scan on or off.
- **Squelch Level** - Toggles between tight, normal and open.
- **Squelch Switch** - Toggles squelch on or off.
- **Surveillance/Covert Mode** - Disables screen, buttons, and LED so the radio remains dark when operational.
- **Tight/Normal Squelch** - Toggles between tight and normal squelch levels.
- **Volume Up/Down** - Raises and lowers the volume.
- **VOX On/Off** - Toggles Voice Activated Function (VOX) on or off.
- **Zone Up/Down** - Switches between zones.

Accessing the Programmed Functions and Radio Menu

There are 2 ways to access various radio functions: Use a short/long press on a programmable button OR use the menu options.

To access the menu -

- Press the Volume Knob [VK] - Accesses the menu and confirms menu selection
- Up/Down [▲]/[▼] Buttons - Toggles through the menu options
- P4 Button [P4] - To go back one menu level, or return to the previous screen

Note: Your radio will exit the menu after a period of inactivity and returns to Main Menu.

Keypad/Mic (Optional MM301HDK)

The optional keypad microphone also enables you to access radio features. You can also use the keypad to enter subscriber numbers or IDs, and text messages.

Note: Some characters require that you press a button multiple times. The table shows the number of times a button needs to be pressed to generate the required character.

Number of Times Button is Pressed

Key	1	2	3	4	5	6	7	8	9	10	11	12	13
1.?	1	.	,	?	!	@	&	'	%	-	:	*	#
2.abc	A	B	C	2									
3.def	D	E	F	3									
4.ghi	G	H	I	4									
5.jkl	J	K	L	5									
6.mno	M	N	O	6									
7.pqrs	P	Q	R	S	7								
8.tuv	T	U	V	8									
9.wxyz	W	X	Y	Z	9								
0.CAPS	0 NOTE: Press to enter "0" and long press to activate the CAPS lock. Another long press to turn off the CAPS lock.												
*DEL	* or Del NOTE: Press during text entry to delete a character.												
#	# or Space NOTE: Press during text entry to insert a space.												

USING MENU/PROGRAMMED FUNCTIONS

Selecting a Zone

A zone is a group of channels. Your radio has up to 250 zones with a maximum of 16 channels per zone.

Press the pre-programmed zone button and proceed to step 2 OR follow the procedure below.

1. Press [VK] to enter menu, and press ▲/▼ to find a Zone and press [VK] to select.
2. The current zone is displayed and indicated by a ✓
3. Press ▲/▼ to find the zone you want and press [VK] to select.
4. The display will show the Zone selected for a moment.

Selecting a Radio Channel, Subscriber ID, or Group ID Procedure:

If you have multiple zones in your radio, once the required zone is displayed, press ▲/▼ to select the channel, subscriber alias or ID, or group alias or ID.

Receiving and Responding to a Radio Call

Once the channel, subscriber ID or group ID is displayed, you can proceed to receive and respond to calls. To unscramble a privacy-enabled call, your radio must have the same Privacy Key, OR ID (programmed by your RCA dealer), as the transmitting radio (the radio you are receiving the call from).

Receiving and Responding to a Group Call

To receive a call from a group of users, your radio must be configured to be part of the group. When you receive a Group Call:

1. The LED blinks green.
2. The first line of the display shows the caller alias, and the RSSI icon. The second line displays the group alias and the Group Call icon.
3. Press the [PTT] button to respond to the call and the LED indicator lights up red. **Note:** If Talk Permit Function is enabled, wait for the Talk Permit Tone to finish and then speak clearly into the microphone.
4. Release the [PTT] button to listen.
5. If there is no voice activity for a set period of time, the call ends.

Receiving and Responding to a Private Call

A Private Call is a call from one individual radio to another individual radio.

There are two types of Private Calls. The first type is when a radio presence check is performed prior to setting up the call. The second sets up the call immediately. When you receive a Private Call:

1. The LED blinks green.
2. The first line of the display shows the subscriber alias or ID, and the RSSI icon. The second line displays Private Call and the Private Call icon.
3. Press the [PTT] to respond to the call; the LED indicator lights up red.
Note: If Talk Permit Function is enabled, wait for the Talk Permit Tone to finish and then speak clearly into the microphone.
4. Release the [PTT] button to listen.
5. If there is no voice activity for a predetermined period of time, the call ends.

Receiving an All Call

An All Call is a call from an individual radio to every radio on the channel. It is used to make important announcements requiring the attention of all radio users. When you receive an All Call:

1. The LED blinks green.
2. The first line of the display shows the subscriber alias or ID, and the RSSI icon. The second line displays All Call and the All Call icon. .
3. Once the All Call ends, the radio returns to the previous screen before receiving the call.

Note: You cannot respond to an All Call. The radio stops receiving the All Call if you switch to a different channel while receiving the call.

Monitoring A Channel (Analog)

Use the Monitor feature to make sure a channel is clear before transmitting by listening for activity on the channel.

1. Press the pre-programmed Monitor button and listen for activity. The monitor icon appears on the display.
2. If you hear activity on the channel the channel is busy. If you hear "white noise" on the channel the channel is free.

Making a Radio Call

You can select a channel, subscriber ID, or group by using:

- The programmable buttons
- The contacts list
- Manual Dial (using contacts list) - This method is for Private Calls only and is dialed using the keypad.

Note: Your radio must have the Privacy feature enabled on the channel to send a privacy-enabled transmission. Only target radios with the same Privacy Key OR the same Key Value and Key ID as your radio will be able to unscramble the transmission.

Making A Call With Channel Selector Buttons

Making a Group Call

To make a Group Call, your radio must be configured to be part of the group.

1. Push the Channel Selector Buttons to select the channel with the active group alias or ID.
2. Press the [PTT] button to make the call. When the target radio responds, the LED lights up green.
3. The display shows the Group icon, group alias or ID, and transmitting radio alias or ID. **Note:** If Talk Permit Function is enabled, wait for the Talk Permit Tone to finish, then speak clearly into the microphone.
4. Release the [PTT] button to listen.
5. If there is no voice activity for a predetermined period of time, the call ends. The radio returns to the screen you were on prior to initiating the call.

Making a Private Call

1. Use the Channel Selector Buttons to select the channel with the active subscriber alias or ID.
2. Press the [PTT] button to make the call. The LED lights up solid red. **Note:** If Talk Permit Function is enabled, wait for the Talk Permit Tone to finish and then speak clearly into the microphone.
3. The first line displays the subscriber alias or ID. The second line displays Private Call and the Private Call icon. Release the [PTT] button to listen. When the target radio responds, the LED lights up solid green.
4. If there is no voice activity for a predetermined period of time, the call ends.
5. The radio returns to the screen last viewed prior to initiating the call.

Making an All Call

This feature allows you to transmit to all users on a channel. Your radio must be programmed to allow you to use this feature.

1. Push the Channel Selector Buttons to select the channel with the active All Call group alias or ID.
2. Press the [PTT] button to make the call. The LED lights up solid red and
3. The Display shows the All Call group alias or ID, and the All Call icon.

Note: Users on the channel cannot respond to an All Call.

Making a Group or Private Call with the One Touch Call Button

The One Touch Call feature allows you to make a Group or Private Call to a predefined alias or ID easily. This feature can be assigned to a short or long programmable button press. You can only have one alias or ID assigned to a One Touch Call button. Your radio can have multiple One Touch Call buttons programmed.

1. Press the programmed One Touch Call button to make a Group or Private Call to the predefined alias or ID.
2. Press the [PTT] button to make a call. **Note:** If Talk Permit Function is enabled, wait for the Talk Permit Tone to finish, then speak clearly into the microphone.
3. The display shows the group/subscriber alias or ID, and the Group/Private Call icon.
4. Release the [PTT] button to listen. When the target radio responds, the LED blinks green.
5. If there is no voice activity for a predetermined period of time, the calls end.
6. Radio returns to the screen you were on prior to initiating the call.

Emergency Operation

An Emergency Alarm is used to indicate a critical situation. You can initiate an Emergency at any time on any screen regardless of any activity on the current channel.

Your radio supports 3 Emergency Alarms:

- Emergency Alarm
- Emergency Alarm with Call
- Emergency Alarm with Voice to Follow

Each alarm has the following types:

- **Regular:** Radio transmits an alarm signal and shows audio and/or visual indicators.
- **Silent:** Radio transmits an alarm signal without any audio or visual indicators. There will be no response (call) from the target radio until you press the PTT button to initiate the call.
- **Silent with Voice:** Radio transmits an alarm signal and is able to receive an incoming call, without any audio or visual indicators, until you press the [PTT] button to initiate, or respond to the call.

Initiating & Responding to Emergency Alarm

1. To initiate an Emergency Alarm, press the programmed Emergency button. The LED lights up solid red.
2. The display shows Sending Alarm, which alternates with your radio ID. Emergency icon appears on the Home screen display. When an Emergency Alarm acknowledgment is received, an alert tone sounds and the display shows **Emergency Alarm Successful**.
3. Depending on the setting selected, you can press the [PTT] button. OR your radio's microphone is automatically activated, allowing you to communicate with the other radio without pressing the [PTT] button.
4. To Respond to an Emergency Alarm, press any button to stop all Emergency Alarm received indications. Press [PTT] button to initiate a call with the emergency initiating radio.

Exiting Emergency Mode

Your radio exits Emergency mode automatically when any of the following occurs:

- Emergency Alarm acknowledgment is received (for Emergency Alarm only)
- All retries to send the alarm have been exhausted
- The Emergency Off button is pressed
- The [PTT] button is pressed
- Your radio is powered off

ADVANCED FEATURES

Public Address

Public Address (PA) is a pre-programmed option that amplifies audio which is then broadcast through an external speaker.

1. Press the programmed PA button to activate the PA feature. The LCD shows PA.
2. Speak into the microphone while holding down the [PTT] to initiate the broadcast. The LCD will display PA ON. You can adjust the PA volume via the volume control knob.
3. Release the [PTT] key to end the PA broadcast. The radio will return to the PA mode and the LCD will display PA. Press PA to disable the PA feature, and the radio will return to normal mode.

Note: In PA mode, the radio is unable to transmit or receive. Optional PA accessories and external speaker must be installed by your RCA dealer.

Radio Check

If enabled, this feature allows you to determine if another radio is active in a system without disturbing the user of that radio. No audible or visual notification is shown on the target radio.

Note: This feature is only applicable for subscriber aliases or IDs in digital mode.

Sending a Radio Check

Using the programmed Radio Check button.

1. Press [VK] to access the menu.
2. Press [▲] or [▼] button to navigate to Contacts and press the [VK] to select.
3. Press [▲] or [▼] to access the required subscriber alias or ID and press [VK] to select. Or press [▲] or [▼] button to Manual Dial, then press [VK], input subscriber ID.
4. Press [▲] or [▼] to Radio Check, then press [VK] to select. Wait for acknowledgment.
5. The display shows Radio Check: <Subscriber Alias or ID>, indicating that Radio Check is in progress. The LED lights up red.
6. If the target radio is active in the system, a tone sounds and the display briefly shows **Target Radio Available**. OR - if the target radio is not active in the system, a tone sounds to indicate target radio not available.
7. Pressing the [P4] button while the radio is waiting for acknowledgment and the radio terminates all retries and exits Radio Check.

Remote Monitor

Use the Remote Monitor feature to turn on the microphone of a target radio (subscriber alias or IDs only). No audible or visual indication is given to the target radio. You can use this feature to monitor, remotely, any audible activity surrounding the target radio.

Note: Your radio must be programmed by your RCA Communications Systems dealer to allow you to use the Remote Monitor feature.

Initiating Remote Monitor

Use the programmed Remote Monitor button.

1. Press [VK] to access the main menu.
2. Press [▲] or [▼] to navigate to Contacts and press [VK] to select.
3. Press [▲] or [▼] button to get the required subscriber alias or ID and press [VK] button to select. OR - press [▲] or [▼] button to Manual Dial, then press [VK]. Input subscriber alias or ID and then press [VK].
4. Press [▲] or [▼] to Remote Monitor and press [VK] button. Wait for acknowledgment.
5. The screen will display Remote Monitor: <Subscriber alias or ID>, indicating that Remote Monitor is in progress. The LED blinks red.
6. The display shows Remote Monitor Successful OR - Shows Remote Monitor Failed.
7. If successful, the radio will start receiving audio from the monitored radio for a programmed duration. Once the timer expires, the radio sounds an alert tone and the display shows Remote Monitor Ended. OR - If unsuccessful, the radio repeats the attempt until the programmed number of tries expires.

Contacts Settings

Contacts provide “address-book” capabilities on your radio. Each entry corresponds to an alias or ID that you can use to initiate a call. Additionally each entry, depending on context, associates with one of five types of calls: Group Call, Private Call, All Call, PC Call or Dispatch Call. Each entry within Contacts displays the following information:

- Call Type
- Call Alias
- Call ID

Note: You can add, delete, or edit contacts from the Digital Contacts list.

Group Call from Contacts

1. Press [VK] to access the menu.
2. Press [▲] or [▼] button to navigate to Contacts and press [VK] to select. All entries are alphabetically sorted.
3. Press [▲] or [▼] button to select the required group alias or ID.
4. Press [PTT] button to make the call. The LED lights up solid red. The display shows Group Call icon, the group alias or ID, and the Group Call icon.
5. Release the [PTT] button to listen, when any user in the group responds, the LED blinks green. You see Group Call icon, the group ID, and that user's ID on your display.
6. If there is no voice activity for a programmed period of time, the call ends.

Note: If Talk Permit function is enabled, wait for the Talk Permit Tone to finish and then speak clearly into the microphone.

Private Call from Contacts

1. Press [VK] to access the menu.
2. Press [▲] or [▼] to navigate to Contacts and press [VK] to select.
3. Press [▲] or [▼] button to navigate to desired subscriber alias or ID. OR - Press [▲] or [▼] to Manual Dial and press [VK]. Use the keypad to input the subscriber ID.
4. Press the [PTT] to make the call. The first line displays the subscriber alias or ID and the second line displays Private Call and the Private Call icon.

1. Release the [PTT] to listen. When the target radio responds, the LED blinks green and the display shows the transmitting user's ID.
2. If there is no voice activity for the programmed period of time then the call ends.

Note: If Talk Permit function is enabled, wait for the Talk Permit Tone to finish and then speak clearly into the microphone.

Call Indicator Settings - Activating And Deactivating Call Alert Tones for Private Calls

Turn on or off the call alert tones for a received Private Call.

1. Press [VK] to access the main menu.
2. Press [▲] or [▼] to Utilities and press to select.
3. Press [▲] or [▼] to Radio Settings and press [VK] to select.
4. Press [▲] or [▼] to Tone/Alerts and press [VK] to select.
5. Press [▲] or [▼] to Call Alert and press [VK] to select.
6. Press [▲] or [▼] to Private Call and press [VK] to select.
7. The display shows Turn On. Press [VK] to enable Call Alert Tones for Private Calls. The display shows Private Call Tone On. OR - The display shows Turn Off. Press [VK] to disable Call Alert Tones for Private Calls. The display shows Private Call Tone Off.

Activating and Deactivating Call Alert Tones for Text Messages

Turn on or off the call alert tones for a received Text Message.

1. Press [VK] to access the main menu.
2. Press [▲] or [▼] to Utilities and press [VK] to select.
3. Press [▲] or [▼] to Radio Settings and press [VK] to select.
4. Press [▲] or [▼] to Tone/Alerts and press [VK] to select.
5. Press [▲] or [▼] to Call Alert Tones and press [VK] to select.
6. Press [▲] or [▼] to Text Message and press [VK] to select.
7. The current tone is indicated by a √.
8. Press [▲] or [▼] to the preferred tone and press [VK] to select. The display shows Tone <Number> Selected and a √ appears left of the selected tone. OR - Press [▲] or [▼] to Turn Off and press [VK] to select. The display shows Text Alert Tones Off and a √ appears left of Turn Off.

Assigning Alert Tones

You can program your radio to sound one of the predefined ring tones when receiving a Call Alert or a Text Message from a particular contact.

1. Press [VK] to access the main menu.
2. Press [▲] or [▼] to Contacts and press [VK] to select. The entries are alphabetically sorted.
3. Press [▲] or [▼] to the required alias or ID and press [VK] to select.
4. Press [▲] or [▼] to Ring Style and press [VK] to select.
5. A √ indicates the current selected tone.
6. Press [▲] or [▼] to the required tone and press [VK] to select.
7. The display shows Tone <Number> Selected and a √ appears left of the selected tone. OR - Press [▲] or [▼] to Turn Off and press to select. The display shows Text Message Tone Off and a √ appears left of Turn Off.

Call Log Features

Your radio keeps track of all recent outgoing, answered, and missed Private Calls. Use the call log feature to view and manage recent calls. You can Store an ID from the Call Log to Contacts or Delete it. The Call Log lists are Missed, Answered, and Outgoing.

Note: When you select a Call List and it contains no entries, the display shows List Empty.

Accessing the Call Log

Use the programmed Remote Monitor button.

1. Press [VK] to access the menu.
2. Press [▲] or [▼] to navigate to Call Log and press the [VK] to select.
3. Press [▲] or [▼] to navigate to the desired list and press [VK] to select. The most recent entry is displayed first.
4. Use the [▲] or [▼] buttons to scroll through the list.
5. After locating the desired contact, press [PTT] to initiate a call.

Storing an Alias or ID from the Missed Call List

1. While viewing an entry from the Call Log list press [VK] to select.
2. Press [▲] or [▼] button to navigate to [Store].
3. Press [VK].
4. Use the keypad to input a name.
5. Press [VK] to confirm.
6. The display shows Contact Saved.

Note: You can store an ID without an Alias.

Deleting a Call from a Call List

1. While viewing an entry from the Call Log list press [VK] to select.
2. Press [▲] or [▼] to navigate to [Delete].
3. Press [VK].
4. Press [VK] again to confirm.
5. The display shows Entry Deleted.
6. Press [VK] again to return to main menu.

Call Alert Operation

Call Alert paging enables you to alert a specific radio user to call you back when they are able to do so. This feature is applicable for subscriber aliases or IDs only and is accessible through the menu via Contacts or Manual Dial.

Receiving and Responding to a Call Alert

When you receive a Call Alert page, on the display you see Call Alert that alternates with the alias or ID of the calling radio.

1. You hear a repetitive tone.
2. Press and release [PTT] button to confirm the prompt. Or - press [VK] to select "Ignore?" and to exit Call Alert.

Making a Call Alert from the Contact List

1. Press [VK] to access the menu.
2. Press [▲] or [▼] to navigate to Contacts and press [VK] to select.
3. Press [▲] or [▼] to find the desired subscriber alias or ID and press [VK] to select. OR - Press [▲] or [▼] to the Manual Dial option and press [VK].
4. Use the keypad to input the subscriber ID and press [VK].
5. Use [▲] or [▼] to find Call Alert and press [VK].
6. The display shows Call Alert: <Subscriber Alias or ID>, indicating that the Call Alert has been sent.
7. The LED lights up red when your radio is sending the Call Alert.
8. If the Call Alert acknowledgment is received, a tone sounds and the display shows Call Alert successful. OR - If the Call Alert acknowledgment is not received, a tone sounds and the display shows Call Alert Failed.

Text Message Features

Your radio is able to receive data such as a text message from another radio. The maximum text message length is 138 characters.

Navigating to Messages

1. Press **[VK]** to access the menu.
2. Press **[▲]** or **[▼]** to navigate to Messages.

Note: Press **[P4]** button at any time to return to previous screen.

Receiving a Text Message

When your radio receives a message, the display shows the alias or ID of the sender and the Message icon at the far left of the screen.

You can select one of the following options when receiving a text message:

- Read?
- Read Later
- Delete

Reading a Text Message

1. Press **[▲]** or **[▼]** to navigate to **[Read?]** and press **[VK]** to select.
2. Selected message in the Inbox opens. Press **[VK]** to return to Home Screen or press **[▲]** or **[▼]** to Read Later or Delete option screen.
 - Select "Read Later" to return to the screen you were on prior to receiving the text message.
 - Select "Delete" to delete the text message.

Managing Received Text Messages

Use the Inbox to manage your text messages.

The Inbox is capable of storing a maximum of 50 messages. Your radio supports the following options for text messages:

- Reply
- Forward
- Delete
- Delete All

Text messages in the Inbox are sorted according the date they were received.

Viewing a Text Message from the Inbox

1. Press **[▲]** or **[▼]** to navigate to Messages and press **[VK]** to select.
2. Press **[▲]** or **[▼]** to navigate to Inbox and press **[VK]** to select.
3. Press **[VK]** to select the current message and press **[VK]** again to reply, forward or delete that message. Unread messages are indicated with an exclamation mark. (!)

Writing and Sending Text Message

1. Press **[VK]** to access the menu.
2. Press **[▲]** or **[▼]** to navigate to Messages and press **[VK]** to select.
3. Press **[▲]** or **[▼]** to navigate to Write and press **[VK]** to select.
4. A blinking cursor appears, use the keypad to type your message. Press **[▲]** to move one space to the left. Press **[▼]** or **[#]** to move one space to the right. Press **[*]** to delete unwanted characters.
5. Press **[VK]** once message is composed.
6. Press **[▲]** or **[▼]** to go to the required alias or ID and press **[VK]** to select the name. OR press **[▲]** or **[▼]** to access Manual Dial and press **[VK]**. Input subscriber ID and press **[VK]** to confirm.
7. The radio display shows Text Message: <Subscriber/Group Alias or ID>, which confirms your message is being sent.
8. If the message is sent, a tone sounds and the display shows Message Sent. If the message is not sent, a low tone sounds and the display shows Message Send Failed. If the text message fails to send, the radio returns you to the Resend option screen.

Sending a Quick Text Message

Your radio stores a maximum of 10 Quick Text messages as programmed by your RCA Communications Systems dealer. While Quick Text messages are predefined, you can edit each message before sending it.

1. Press **[VK]** to access the menu.
2. Press **[▲]** or **[▼]** to navigate to Messages.
3. Press **[▲]** or **[▼]** to Quick Text and press **[VK]**.
4. Press **[▲]** or **[▼]** to find the desired Quick Text and press **[VK]** to select.
5. A blinking cursor appears. Use the keypad to edit the message, if needed. Press **[▲]** to move one space to the left. Press **[▼]** or **[#]** to move one space to the right. Press **[*]** to delete any unwanted characters.
6. Press **[VK]** once message is composed.
7. Press **[▲]** or **[▼]** to find the required alias or ID and press **[VK]** to select. OR - press **[▲]** or **[▼]** to Manual Dial, press **[VK]** to select. Input subscriber ID and press **[VK]**.
8. The display shows Text Message: <Subscriber/Group Alias or ID>, confirming your message is being sent.
9. If the message is sent successfully, a tone sounds and the display shows Message Sent. OR - If the message is not sent, a low tone sounds and the display shows Message Send Failed. If the text message fails to send, the radio returns you to the Resend option screen.

Note: Your RCA Communications Systems dealer can program a One Touch Access button to send a predefined Quick Text message to a predefined alias or ID.

Managing Fail-to-Send Text Messages

You can select one of the following options while at the Resend option screen:

- Resend
- Forward
- Edit

Resending A Text Message

1. Press **[VK]** to resend the same message to the same subscriber / group alias or ID.
2. If the message is sent successfully, a tone sounds and the display shows Message Sent. OR - If the message cannot be sent, a low tone sounds and the display shows Message Send Failed.

Forwarding a Text Message

1. Once in Messages, press **[▲]** or **[▼]** to navigate to Inbox and press **[VK]** to select.
2. Press **[VK]** and **[▲]** or **[▼]** to Forward message and press **[VK]** to select.
3. Press **[▲]** or **[▼]** to find the required alias or ID and press **[VK]**. OR - Press **[▲]** or **[▼]** to access Manual Dial and press **[VK]**. Input subscriber ID then press **[VK]** button.
4. The display shows Text Message: <Subscriber/Group Alias or ID> confirming your message is being sent.
5. If the message is sent, a tone sounds and the display shows Message Sent. OR - If the message is not sent, a low tone sounds and the display shows Message Send Failed.

Managing Sent Text Message

Once a message is sent to another radio, it is saved in Sent Items. The most recent sent text message is always added to the top of the Sent Items list. The Sent Items folder is capable of storing a maximum of thirty (30) last sent message. When the folder is full, the next sent text message automatically replaces the oldest text message in the folder.

Viewing Sent Text Messages

1. Press [▲] or [▼] to navigate to Messages and press [VK] to select.
2. Press [▲] or [▼] to navigate to Sent Items and press [VK] to select.
3. Press [▲] or [▼] to navigate to the desired message and press [VK] button.

You can select one of the following options while viewing a sent text message:

- Resend
- Forward
- Edit
- Delete

To perform any of the functions:

1. Press [VK] again while viewing message.
2. Press [▲] or [▼] to navigate to Resend, Forward, Edit or Delete and press [VK] to select.
3. If you select [Resend] or [Edit] and then [Send], the display will show Text Message: <Subscriber/Group alias or ID>, confirming that the same message is being sent to the same target radio.
4. If the message is sent, a tone sounds and the display shows Message Sent. OR - If the message is not sent, a low tone sounds and the display shows Message Send Failed. The radio returns to the Resend option screen. Press [VK] to resend the message to the same subscriber/group alias or ID.

Deleting All Sent Text Messages from Sent Items

1. Press [▲] or [▼] to navigate to “Messages” and press [VK] to select.
2. Press [▲] or [▼] to navigate to “Sent Items” and press [VK] to select.
3. Press [▲] or [▼] to navigate “Delete All” and press [VK] to select.
4. The display shows “Delete Message?”, press [VK] to confirm. The display shows Sent Items Cleared.

Replying to a Text Message from the Inbox

1. Press [VK] to access the menu.
2. Press [▲] or [▼] to navigate to Messages and press [VK] to select.
3. Press [▲] or [▼] to navigate to Inbox and press [VK] to select.
4. Press [VK] to select current message, and press [VK] to select. Press [VK] again to access the sub-menu and select Reply, Forward or Delete the message.
5. Press [▲] or [▼] to navigate to Reply and press [VK] to select.
6. Press [▲] or [▼] to navigate to Write and press [VK] to select. A blinking cursor appears. Use the keypad to write your message OR press [▲] or [▼] to navigate to Quick Text and press [VK]. After selecting the desired message press [VK] button. A blinking cursor appears. Use the keypad to edit your message, if required.
7. Press [VK] to send and [VK] again to confirm.
8. The display shows Text Message: <Subscriber/Group Alias or ID>, confirming your message is being sent.
9. If the message is sent successfully, a tone sounds and the display shows Message Sent. If the message cannot be sent, the display shows Message Send Failed. If the message fails to send, the radio returns to the Resend option screen.

Deleting a Text Message from the Inbox

1. Press [VK] to access the menu.
2. Press [▲] or [▼] to navigate to Messages and press [VK] to select.
3. Press [▲] or [▼] to navigate to Inbox and press [VK] to select.
4. Press [VK] to select current message, and press [VK] to select. Press [VK] again to access the sub-menu to Reply, Forward or Delete the message.
5. Press [▲] or [▼] to navigate to Delete and press [VK] to select.
6. Press [▲] or [▼] to navigate to Delete and press [VK] to select.
7. At Delete Message?, press [▲] or [▼] to navigate to Yes and press [VK]. The display shows Message Deleted.

Note: When you select the Inbox and it contains no text messages, the display shows List Empty.

Privacy

If enabled, this feature helps to prevent eavesdropping by unauthorized users on a channel by the use of a software based scrambling solution. The signaling and user identification portions of a transmission are not scrambled.

Your radio must have privacy enabled on the channel to send a privacy-enabled transmission, although it is not required for receiving a privacy-enabled transmission. Your radio supports two types of privacy:

- Basic Privacy
- Enhanced Privacy

Only ONE privacy type above can be assigned to your radio.

To unscramble a privacy-enabled call or data transmission, your radio must be programmed to have the same Privacy Key (for Basic Privacy), OR the same Key Value and Key ID (for Enhanced Privacy) as the transmitting radio.

If your radio receives a scrambled call that is of a different Privacy Key, OR a different Key Value and Key ID, you will either hear a garbled transmission (Basic Privacy) or nothing (Enhanced Privacy).

The LED lights up solid green while the radio is transmitting and blinks green rapidly when the radio is receiving an ongoing privacy-enabled transmission.

To make a private call:

1. Press [▲] or [▼] to navigate to Utilities and press [VK] to select.
2. Press [▲] or [▼] to navigate to Radio Settings and press [VK] to select.
3. Press [▲] or [▼] to navigate to Privacy and press [VK] to select.
4. The display shows Privacy and Turn On. Press [VK] to enable privacy. The display shows Privacy On. If the Privacy was already on the display shows Privacy and Turn Off. Press [VK] to disable privacy. The display shows Privacy Off.

Note: This feature is available only in digital mode.

Dual Tone Multi Frequency (DTMF) Analog

The Dual Tone Multi Frequency (DTMF) feature allows the radio to operate in a radio system with an interface to telephone or other DTMF based systems. DTMF Codes can be programmed into the radio by your RCA Communications Systems dealer. DTMF receive/transmit feature has four optional modes with 32 encode groups with up to 30 characters per group.

To use this feature, your radio must have an access code, which is system dependent. Please contact with your RCA Communications Systems dealer or system administrator for more information.

To initiate a DTMF call.

1. Press and hold PTT button.
2. Enter the desired number.

You can turn off the DTMF tone by disabling all radio tones and alerts.

Security

The Security Feature allows you to enable or disable any radio within your system. For example, you might want to disable a stolen radio, to preventing a thief from using it, then enable that radio once recovered.

NOTE: The Disable/Enable feature requires your radio to have this function enabled. Check with your RCA dealer or system administrator for more information.

Radio Security enables you to perform the following functions:

Radio Disable: Radio's receive / transmit functions become disabled after the radio receives the Disable code set by your RCA Communications Systems dealer.

1. Press **[VK]** to access the main menu.
2. Press **[▲]** or **[▼]** to navigate to Contacts and press **[VK]** to select.
3. Press **[▲]** or **[▼]** to navigate to the desired subscriber alias or ID and press **[VK]** to select. OR - Press **[▲]** or **[▼]** to navigate to Manual Dial and press **[VK]**, input subscriber ID and press **[VK]** to select.
4. Press **[▲]** or **[▼]** to navigate to Radio Disable and press **[VK]** to select.
5. The display shows Radio Disable: <Subscriber alias or ID> and LED indicator lights red.
6. Wait for acknowledgment.
7. If successful, a tone sounds and the display shows Radio Disable successful. If failed, a tone sounds and the display shows Radio Disable failed.

Radio Enable: Radio's receive / transmit functions become enabled, when the radio is in Disable status, after the radio receives the Active code set by your RCA Communications Systems dealer. OR - Radio Enable can be initiated through the Menu of your radio.

1. Press **[VK]** to access the main menu.
2. Press **[▲]** or **[▼]** to navigate to Contacts and press **[VK]** to select. The entries are alphabetically sorted.
3. Press **[▲]** or **[▼]** to navigate to the desired subscriber alias or ID and press **[VK]** to select. OR - You can press **[▲]** or **[▼]** to navigate to Manual Dial and press **[VK]**, input subscriber ID and press **[VK]** to select.
4. Press **[▲]** or **[▼]** to navigate to Radio Enable and press **[VK]** to select.
5. The display shows Radio Active: <Subscriber alias or ID> and LED indicator lights red.
6. Wait for acknowledgment.
7. If successful, a tone sounds and the display shows Radio Enable successfully. If failed, a tone sounds and the display shows Radio Enable failed.

Scan Lists

Scan lists are created and assigned to individual channels/groups. The radio scans for voice activity by cycling through the channel/group sequence specified in the scan list for the current channel / group. Your radio has 250 scan lists with 16 members each. Each scan list supports a mixture of both analog and digital entries. You can add, delete, or prioritize channels by editing the scan lists.

Viewing an Entry in the Scan List

1. Use the Channel Selector Knob to select a channel programmed with a scan list.
2. Press **[VK]** to access the menu.
3. Press **[▲]** or **[▼]** to navigate to Scan and press **[VK]** to select.
4. Press **[▲]** or **[▼]** to navigate to View List and press **[VK]** to select.
5. Use **[▲]** or **[▼]** to view the members on the scan list.

Note: If set as priority, the Priority icon appears left of the member's alias, indicate whether the member is on a Priority 1 or Priority 2 channel list. You cannot have multiple Priority 1 or Priority 2 channels in a scan list. There is no priority icon if priority is set to None.

Scan Instructions and Methods

When a scan is initiated, your radio cycles through the programmed scan list for the current channel looking for voice activity. The LED blinks red and you see the Scan icon on the display.

There are two ways of initiating scan:

- **Manual Scan:** Initiate scan manually using the programmed Scan ON/OFF side button by your RCA Communications Systems dealer. OR - By menu function.
 - In Manual Scan, radio will detect all channel / groups on the programmed scan list.
- **Auto Scan:** Your radio automatically starts scanning when you select a channel / group that has Auto Scan enabled.

Starting and Stopping Scan

Press the programmed Scan ON/OFF button to start or stop the Scan. OR - Follow the procedure below:

1. Use the Channel Selector Knob to select a channel programmed with a scan list.
2. Press **[VK]** to access the menu.
3. Press **[▲]** or **[▼]** to navigate to Scan and press **[VK]** to select.
4. The display shows Turn Off if scan is disabled or the display shows Turn on if scan is enabled.
5. Press **[VK]** to select.
6. The LED blinks red and the Scan icon is displayed when Scan is enabled. The LED turns off and the Scan icon disappears when Scan is disabled.

Responding to a Scan

During scanning, your radio stops on any channel/group where activity is detected. After the transmission is over the radio remains on the active channel for a programmed time period known as "hang time".

1. Press the PTT button during "hang time" to respond to the call. The LED lights up red.
2. Release PTT button to listen.

Note: If you do not respond within the "hang time" period, the radio continues scanning other channels / groups.

Deleting a Nuisance Channel

If a channel continually generates unwanted calls or noise (termed a "nuisance" channel), you can temporarily remove the unwanted channel from the scan list.

Note: This capability does not apply to the channel designated as the Selected Channel. This feature is not accessible through the menu.

1. When your radio stops on an unwanted or nuisance channel, press the programmed Nuisance Channel Delete button until you hear a tone.
2. Release the Nuisance Channel Delete button. The nuisance channel is deleted.

Restoring a Nuisance Channel

To restore the deleted nuisance channel, power the radio off and back on again. OR - Press Stop and Start to restart a scan via the programmed Scan button.

Utilities

Keypad Locked or Unlocked (For use with optional MM301HD Keypad/Mic.)

You can lock your radio's keypad to avoid an inadvertent key entry.

1. Press **[VK]** to access the main menu.
2. Press **[▲]** or **[▼]** to navigate to Utilities and press **[VK]** to select.
3. Press **[▲]** or **[▼]** to navigate to Radio Settings and press **[VK]** to select.
4. Press **[▲]** or **[▼]** to navigate to Keypad Lock and press **[VK]** to select.
5. The display shows Keypad Locked and returns to the home screen.

To unlock the keypad, press **[VK]** button then press **[*]** button. The display shows Keypad Unlocked and returns to the home screen.

Keypad Tones On or Off (For use with optional MM301HD Keypad/Mic.)

You can enable and disable keypad tones if needed.

1. Press **[VK]** to access the main menu.
2. Press **[▲]** or **[▼]** to navigate to Utilities and press **[VK]** to select.
3. Press **[▲]** or **[▼]** to navigate to Radio Settings and press **[VK]** to select.
4. Press **[▲]** or **[▼]** to navigate to Tone/Alerts and press **[VK]** to select.
5. Press **[▲]** or **[▼]** to navigate to Keypad Tones and press **[VK]** to select.
6. If the display shows Turn On, Press **[VK]** to enable the keypad tones.
If the display shows Turn Off press **[VK]** to disable the keypad tones.

Setting the Power Level

You can customize your radio's power setting to high or low for each channel.

Settings:

Press the programmed Power Level button to toggle transmits power level between high and low. OR - Follow the procedure below to adjust the Power Level through the Menu.

1. Press **[VK]** to access the main menu.
2. Press **[▲]** or **[▼]** to navigate to Utilities and press **[VK]** to select.
3. Press **[▲]** or **[▼]** to navigate to Radio Settings and press **[VK]** to select.
4. Press **[▲]** or **[▼]** to navigate to Power and press **[VK]** button.
5. Change your current setting as prompted on the display and press **[VK]** to select.

Press the **[P4]** button to return to the Home screen. The display shows the Power Level icon.

Voice Operating Transmission (VOX) Feature On / Off

This feature allows you to initiate a hands-free voice activated call on a programmed channel. The radio automatically transmits, for a programmed period, whenever the microphone on the VOX-capable accessory detects a voice.

Note: This feature must be programmed by your RCA dealer to use this function.

To begin using VOX: Press the programmed VOX button to toggle the feature on or off. OR - Follow the procedure below to activate or deactivate VOX through the Menu.

1. Press **[VK]** to access the menu.
2. Press **[▲]** or **[▼]** to navigate to Utilities and press **[VK]** to select.
3. Press **[▲]** or **[▼]** to navigate to Radio Settings and press **[VK]** to select.
4. Press **[▲]** or **[▼]** to navigate to VOX and press **[VK]** to select.
5. If the display shows VOX On, press **[VK]** to disable VOX. The display will change to VOX Off. OR - If the display shows VOX Off, press **[VK]** to enable VOX and display shows VOX On.

Note: Pressing the PTT button during radio operation will disable VOX.

Controlling the Display Backlight

You can enable or disable the radio's display backlight. The setting also affects the Menu navigation buttons and keypad backlighting accordingly. Press the programmed Backlight button to toggle the backlight settings. OR -

1. Press **[VK]** to access the main menu.
2. Press **[▲]** or **[▼]** to navigate to Utilities and press **[VK]** to select.
3. Press **[▲]** or **[▼]** to navigate to Radio Settings and press **[VK]** to select.
4. Press **[▲]** or **[▼]** to navigate to Backlight and press **[VK]** button.
5. If the display shows "Auto On". Press **[VK]** to enable the display backlight and the display shows "Backlight Auto On". OR - If the display shows "Turn Off" press **[VK]** to disable the display backlight and the display shows "Backlight Turn Off".

Note: The display backlight and keypad backlight are automatically turned off if the LED indicator is disabled.

Talkaround

This feature toggles between repeater and talkaround (direct) mode. If you are using a repeater and your repeater is not operating or you are out of range, you can continue to communicate with other radios within your group through "Talkaround".

Press the programmed Repeater / Talkaround button to toggle between talkaround and repeater modes. OR -

1. Press **[VK]** to access the main menu.
2. Press **[▲]** or **[▼]** to navigate to Utilities and press **[VK]** to select.
3. Press **[▲]** or **[▼]** to navigate to Radio Settings and press **[VK]** to select.
4. Press **[▲]** or **[▼]** to navigate to Talkaround and press **[VK]** to select or **[P4]** to cancel.
5. After confirmation, the display shows "Talkaround On" OR "Talkaround Off"
6. Press or wait the presetting time to exit the menu.
7. The Talkaround setting is retained even after powering down.

Radio Tones/Alerts On or Off

You can enable and disable all radio tones and alerts (except for the incoming Emergency alert tone) if needed. Press the programmed All Tones/Alerts button to toggle all tones on or off.

1. Press **[VK]** to access the main menu.
2. Press **[▲]** or **[▼]** to navigate to Utilities and press **[VK]** to select.
3. Press **[▲]** or **[▼]** to navigate to Radio Settings and press **[VK]** to select.
4. Press **[▲]** or **[▼]** to navigate to Tones / Alerts and press **[VK]** to select.
5. Press **[▲]** or **[▼]** to navigate to All Tones and press **[VK]** to select.
6. If the display shows Turn On press **[VK]** to enable all tones and alerts and the display shows All Tones On. If the display shows Turn Off press **[VK]** to disable all tones and alerts and the display shows All Tones Off.

LED Indicator On or Off

You can enable and disable the LED Indicator if needed.

1. Press **[VK]** to access the main menu.
2. Press **[▲]** or **[▼]** to navigate to Utilities and press **[VK]** to select.
3. Press **[▲]** or **[▼]** to navigate to Radio Settings and press **[VK]** to select.
4. Press **[▲]** or **[▼]** to navigate to LED Indicator and press **[VK]** button.
5. If the display shows Turn On, press **[VK]** to enable the LED Indicator and the display shows All LEDs On. If the display shows Turn Off, press **[VK]** to disable the LED Indicator and the display shows All LEDs Off.

Note: The display backlight, buttons and keypad backlight are automatically turned off if the LED indicator is disabled.

Turning the Introduction Screen On/Off You can enable and disable the Introduction Screen if needed.

1. Press **[VK]** to access the main menu.
2. Press **[▲]** or **[▼]** to navigate to Utilities and press **[VK]** to select.
3. Press **[▲]** or **[▼]** to navigate to Radio Settings and press **[VK]** to select.
4. Press **[▲]** or **[▼]** to navigate to Intro Screen and press **[VK]** to select.
5. If The display shows Turn On, press **[VK]** to enable the Introduction Screen and the display shows Intro Screen On. If the display shows Turn Off, press **[VK]** to disable the Introduction Screen and the display shows Intro Screen Off.

Accessing General Radio Information Your radio contains information on the following:

- Radio ID
- Software version
- Codeplug Version

Checking the Radio ID

1. Press [VK] to access the main menu.
2. Press [▲] or [▼] to navigate to Utilities and press [VK] to select.
3. Press [▲] or [▼] to navigate to Radio Info and press [VK] to select.
4. Press [▲] or [▼] to navigate to My Number, or Firmware Vr., or CP Vr. and press [VK] button.
5. The display shows radio ID, the current firmware or the codeplug version.

CARE AND CLEANING

- Do not place anything on top of the radio that will prevent heat dissipation.
- Be sure radio is powered off before cleaning.
- Do not place the radio in a dusty or dirty environment.
- Clean the radio with a lint-free/non woven fabric moistened with clean water and/or a mild dish washing liquid to remove dirt, grease, and dust.
- Avoid subjecting the radio to corrosives, solvents or spirits.
- Make sure the radio is completely dry before use.



www.rcacommunicationssystem.com
products@rcacommunicationssystem.com
(877) 822-2915

Created in U.S.A.

TROUBLESHOOTING

Symptom	Solution
Radio will not power on	<ol style="list-style-type: none"> 1. Check the power connections to make sure they have a solid connection. 2. Check for (one or more) blown fuse(s)
Radio is on, but you cannot hear voice transmissions or they are not very loud	<ol style="list-style-type: none"> 1. Turn the volume control knob to maximum volume. 2. Make sure you are within communication range.
You cannot log on to the system	Check the antenna connection to make sure it has a solid connection.
Cannot talk to or hear from group members	<ol style="list-style-type: none"> 1. Make sure you are within communication range. 2. Check the squelch level 3. Digital: Be sure the CC, ID, Time Slot is set correctly 4. Analog: Be sure you're using the same channel and/or have the same CTCSS/ CDCSS settings as your group members.
Transmissions from non-group members are heard	Analog: Change CTCSS/DCS tone and make sure all other radios in your group are using the same CTCSS/DCS tone
Communication range is small	<ol style="list-style-type: none"> 1. Make sure antenna is not damaged and has a solid connection 2. Check the squelch level
Unable to transmit	<ol style="list-style-type: none"> 1. Make sure the PTT button has been pressed completely 2. Transmitting frequency has not been set on the radio 3. The radio has been killed remotely
Noise is too loud	<ol style="list-style-type: none"> 1. Check squelch level 2. Beyond efficient communication range
Buttons will not work	Restart the radio
Radio cannot lock out	Restart the radio
No display	Restart the radio

FCC Caution:

Any Changes or modifications not expressly approved by the party responsible for compliance could void the user's authority to operate the equipment.

This device complies with part 15 of the FCC Rules. Operation is subject to the following two conditions: (1) This device may not cause harmful interference, and (2) this device must accept any interference received, including interference that may cause undesired operation.

This transmitter must not be co-located or operating in conjunction with any other antenna or transmitter.

IMPORTANT NOTE:

Note: This equipment has been tested and found to comply with the limits for a Class B digital device, pursuant to part 15 of the FCC Rules. These limits are designed to provide reasonable protection against harmful interference in a residential installation. This equipment generates, uses and can radiate radio frequency energy and, if not installed and used in accordance with the instructions, may cause harmful interference to radio communications. However, there is no guarantee that interference will not occur in a particular installation. If this equipment does cause harmful interference to radio or television reception, which can be determined by turning the equipment off and on, the user is encouraged to try to correct the interference by one or more of the following measures:

- Reorient or relocate the receiving antenna.
- Increase the separation between the equipment and receiver.
- Connect the equipment into an outlet on a circuit different from that to which the receiver is connected.
- Consult the dealer or an experienced radio/TV technician for help.

FCC Radiation Exposure Statement:

This equipment complies with FCC radiation exposure limits set forth for an uncontrolled environment. This equipment should be installed and operated with minimum distance 50cm between the radiator & your body.

The device is authorized to operate at a duty factor not to exceed 50%.