



TEST REPORT

For

Applicant : RCA Communications Systems

Address : 133 W. Market Street, Suite 227, Indianapolis, IN 46240

Product Name : two way radio

Model Name : RDR2600V, RDR2550V

Remark : Different only by model number and appearance.

Brand Name : RCA

FCC Number : FCC ID:XYH-RDR2600V

Report No. : MTE/CEC/S16092090

Date of Issue : Sep. 29, 2016

Issued by : Most Technology Service Co., Ltd.

**Address : No.5, 2nd Langshan Road, North District, Hi-tech Industrial
Park, Nanshan, Shenzhen, Guangdong, China**

Tel : 86-755-8602 6850

Fax : 86-755-2601 6850

The report consists 51 pages in total. It may be duplicated completely for legal use with the approval of the applicant. It should not be reproduced except in full, without the written approval of our laboratory. The client should not use it to claim product endorsement by MOST. The test results in the report only apply to the tested sample. The test report shall be invalid without all the signatures of testing engineers, reviewer and approver.

TABLE OF CONTENTS

1. TEST STANDARDS	3
1.1 VERIFICATION OF CONFORMITY.....	4
2. <u>SUMMARY</u>.....	5
2.1 General Remarks.....	5
2.2 Equipment Under Test	5
2.3 Short description of the Equipment under Test (EUT).....	6
2.4 Short description of the Equipment under Test (EUT).....	7
2.5 EUT operation mode.....	7
3. <u>TEST ENVIRONMENT</u>.....	8
3. 1 TEST FACILITY	8
3.2 Environmental conditions	8
3.3 Configuration of Tested System	8
3.4 Measurement uncertainty	9
3.5. Equipments Used during the Test	10
3.6. General Technical Requirements and Summary of Test Results	11
4. TEST CONDITIONS AND RESULTS.....	12
4.1 Conducted Emissions Test.....	12
4.2 Occupied Bandwidth and Emission Mask.....	15
4.2.1 Occupied Bandwidth.....	16
4.3 Emission Mask.....	20
4.3. Radiated Spurious Emission Test.....	27
4.4. Spurious Emission On Antenna Port	30
4.5. Modulation Characteristics.....	40
4.6. Frequency Stability Measurement.....	41
4.7. Conducted Output Power	44
4.8. Transmitter Frequency Behavior.....	48
5 Test Setup Photos of the EUT	50

1. TEST STANDARDS

The tests were performed according to following standards:

FCC Part 90: PRIVATE LAND MOBILE RADIO SERVICES

TIA/EIA 603-D-2010: Land Mobile FM or PM Communications Equipment Measurement and Performance Standards.

47 CFR FCC Part 15 Subpart B - Unintentional Radiators

FCC Part 2: FREQUENCY ALLOCATIONS AND RADIO TREATY MATTERS; GENERAL RULES AND REGULATIONS

2. SUMMARY

2.1 General Remarks

Data of receipt of test sample	:	Sep. 05, 2016
Testing commenced on	:	Sep. 08, 2016
Testing concluded on	:	Sep. 28, 2016

2.2 Equipment Under Test

Power supply system utilised

Power supply voltage	:	<input type="radio"/> 120V/60 Hz	<input type="radio"/> 115V/60Hz
		<input type="radio"/> 12V DC	<input type="radio"/> 24V DC
		<input checked="" type="radio"/> Other(specified in blank below)	

7.4V by battery

2.3 Short description of the Equipment under Test (EUT)

The RCA Communications Systems Model: RDR2600V or the “EUT” as referred to in this report; more general information as follows, for more details, refer to the user’s manual of the EUT.

Name of EUT	two way radio	
Model Number	RDR2600V	
FCC ID Number	FCC ID:XYH-RDR2600V	
Rated Output Power	5 Watts(36.93dBm)	
Support data rate	9.6 kbps	
Modulation Type	4FSK for Digital Voice/ Digital Data	
	4FSK for Digital Data	
	Digital	F1W&F1D for 12.5KHz Channel Separation
Channel Separation	Digital Voice/ Data	12.5KHz: F1W
	Digital Data	12.5KHz: F1D
Antenna Type	External	
Frequency Range	From 136MHz to 174MHz	
Maximum Output Power	Digital	5.0W for 12.5KHz Channel Separation

Note: The product has the same digital working characters when operating in both two digitized voice/data mode. So only one set of test results for digital modulation modes are provided in this test report.

Test frequency list

Frequency Range (MHz)	Modulation Type	Channel Separation (KHz)	Test frequency (MHz)
136-174	Digital/4FSK	12.5	137.0125
			152.0125
			169.9870

2.4 Short description of the Equipment under Test (EUT)

136-174MHz two way radio (RDR2600V).
 For more details, refer to the user’s manual of the EUT.
 Serial number: Nil

2.5 EUT operation mode

The EUT has been tested under typical operating condition.

2.6 EUT operation mode

The following peripheral devices and interface cables were connected during the measurement:

- - supplied by the manufacturer
- - supplied by the lab

○	Power Cable	Length(m):	/
		Shield:	/
		Detachable:	/
○	Multimeter	Manufacturer:	/
		Model No:	/

2.7 Related Submittal(s) / Grant (s)

This submittal(s) (test report) is intended for FCC ID:XYH-RDR2600V filing to comply with the FCC Part 90 Rules.

2.8 Modifications

No modifications were implemented to meet testing criteria.

3. TEST ENVIRONMENT

3.1 TEST FACILITY

Test Site:	Most Technology Service Co., Ltd
Location:	No.5, Langshan 2nd Rd., North Hi-Tech Industrial park, Nanshan, Shenzhen, Guangdong, China
Description:	There is one 3m semi-anechoic an area test sites and two line conducted labs for final test. The Open Area Test Sites and the Line Conducted labs are constructed and calibrated to meet the FCC requirements in documents ANSI C63.4:2014 and CISPR 16 requirements. The FCC Registration Number is 490827 . The IC Registration Number is 7103A-1 .
Site Filing:	The site description is on file with the Federal Communications Commission, 7435 Oakland Mills Road, Columbia, MD 21046.
Instrument	All measuring equipment is in accord with ANSI C63.4:2014 and CISPR 16
Tolerance:	requirements that meet industry regulatory agency and accreditation agency requirement.
Ground Plane:	Two conductive reference ground planes were used during the Line Conducted Emission, one in vertical and the other in horizontal. The dimensions of these ground planes are as below. The vertical ground plane was placed distancing 40 cm to the rear of the wooden test table on where the EUT and the support equipment were placed during test. The horizontal ground plane projected 50 cm beyond the footprint of the EUT system and distanced 80 cm to the wooden test table. For Radiated Emission Test, one horizontal conductive ground plane extended at least 1m beyond the periphery of the EUT and the largest measuring antenna, and covered the entire area between the EUT and the antenna.

3.2 Environmental conditions

During the measurement the environmental conditions were within the listed ranges:

Temperature:	15-35 ° C
Humidity:	30-60 %
Atmospheric pressure:	950-1050mbar

3.3 Configuration of Tested System

Configuration of Tested System

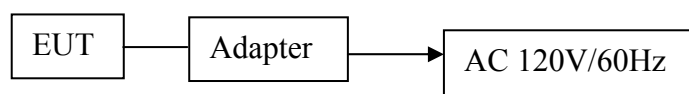

Table 2-1 Equipment Used in Tested System

Adapter: Input:100-240V~50/60Hz
Output: 9V DC 0.5A
Power Cable: 150cm
◇ Shielded ◆ Unshielded

3.4 Measurement uncertainty

No.	Item	Uncertainty
1.	Uncertainty for Conducted Disturbance Test	1.25dB
2.	Uncertainty for Radiated Disturbance Test	3.15dB

3.5. Equipments Used during the Test

Test Equipment	Manufacturer	Model No.	Serial No.	Calibration Date	Calibration Due Date
Bilog Antenna	Sunol Sciences Corp.	JB1	A061713	2016/07/11	2017/07/10
EMI Test Receiver & Spectrum Analyzer	R&S	ESCI	103710	2016/07/09	2017/07/08
Spectrum Analyzer	Agilent	E4407B	E4407B MY45108355	2016/07/05	2017/07/04
Controller	EM Electronics	Controller EM 1000	N/A	2016/07/05	2017/07/05
Horn Antenna	Sunol Sciences Corp.	DRH-118	A062013	2016/07/11	2017/07/10
Horn Antenna	SCHWARZBECK	BBHA9170	1562	2016/07/11	2017/07/10
Active Loop Antenna	SCHWARZBECK	FMZB1519	1519-037	2016/07/11	2016/07/10
LISN	R&S	ENV216	101316	2016/07/09	2017/07/08
LISN	SCHWARZBECK	NSLK8127	8127687	2016/07/09	2017/07/08
Microwave Preamplifier	HP	8349B	3155A00882	2016/07/09	2017/07/08
Amplifier	HP	8447D	3113A07663	2016/07/09	2017/07/08
Transient Limiter	Com-Power	LIT-153	532226	2016/07/09	2017/07/08
Radio Communication Tester	R&S	CMU200	3655A03522	2016/07/05	2017/07/04
Temperature/Humidity Meter	zhicheng	ZC1-2	22522	2016/07/09	2017/07/08
SIGNAL GENERATOR	HP	8647A	3200A00852	2016/07/09	2017/07/08
Wideband Peak Power Meter	Anritsu	ML2495A	220.23.35	2016/07/05	2017/07/04
Climate Chamber	ESPEC	EL-10KA	A20120523	2016/07/05	2017/07/04
High-Pass Filter	K&L	9SH10-2700/X 12750-O/O	/	2016/07/05	2017/07/04
High-Pass Filter	K&L	41H10-1375/U 12750-O/O	/	2016/07/05	2017/07/04
Storage oscilloscope	KENWOOD	CS-5450	3070002	2016/07/17	2017/07/17

3.6. General Technical Requirements and Summary of Test Results

FCC Rules	Description of Test	Test Result
§ 90.205	Maximum Transmitter Power	Complies
§ 90.207	Modulation Characteristic	Complies
§ 90.209	Occupied Bandwidth	Complies
§ 90.210	Emission Mask	Complies
§ 90.213	Frequency Stability	Complies
§ 90.214	Transient frequency behavior	Complies
§ 90.210	Transmitter Radiated Spurious Emission	Complies
§ 90.210	Spurious Emission On Antenna Port	Complies

4. TEST CONDITIONS AND RESULTS

4.1 Conducted Emissions Test

TEST CONFIGURATION

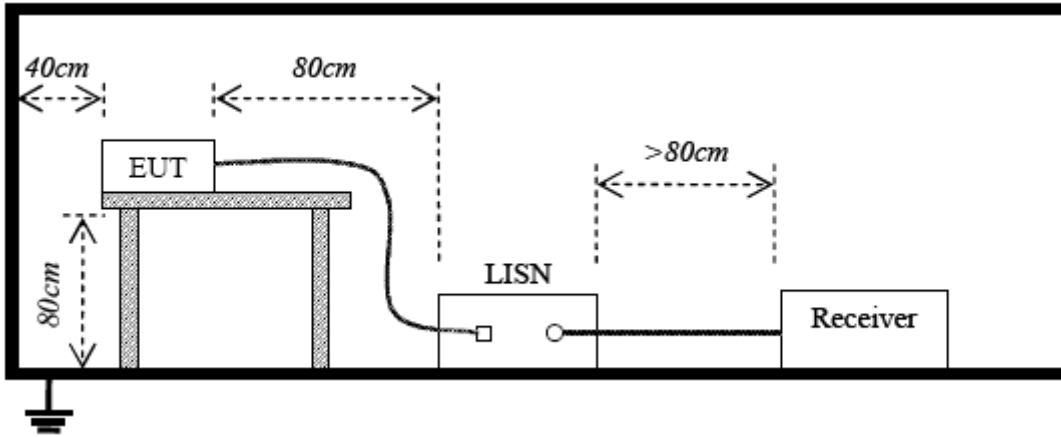

TEST PROCEDURE

- 1 The equipment was set up as per the test configuration to simulate typical actual usage per the user's manual. The EUT is a tabletop system, a wooden table with a height of 0.8 meters is used and is placed on the ground plane as per ANSI C63.4.
- 2 Support equipment, if needed, was placed as per ANSI C63.4.
- 3 All I/O cables were positioned to simulate typical actual usage as per ANSI C63.4.
- 4 The EUT received DC7.4V power from the battery.
- 5 All support equipments received AC power from a second LISN, if any.
- 6 The EUT test program was started. Emissions were measured on each current carrying line of the EUT using a spectrum Analyzer / Receiver connected to the LISN powering the EUT. The LISN has two monitoring points: Line 1 (Hot Side) and Line 2 (Neutral Side). Two scans were taken: one with Line 1 connected to Analyzer / Receiver and Line 2 connected to a 50 ohm load; the second scan had Line 1 connected to a 50 ohm load and Line 2 connected to the Analyzer / Receiver.
- 7 Analyzer / Receiver scanned from 150 KHz to 30MHz for emissions in each of the test modes.
- 8 During the above scans, the emissions were maximized by cable manipulation.

Conducted Power Line Emission Limit

For unintentional device, according to § 15.107(a) Line Conducted Emission Limits is as following :

Frequency (MHz)	Maximum RF Line Voltage (dBµV)			
	CLASS A		CLASS B	
	Q.P.	Ave.	Q.P.	Ave.
0.15-0.50	79	66	66-65	56-46
0.50-5.00	73	60	56	46
5.00-30.0	73	60	60	50

* Decreasing linearly with the logarithm of the frequency

For intentional device, according to §15.207(a) Line Conducted Emission Limit is same as above table.

TEST RESULTS

For 4FSK Modulation @ 12.5 KHz

EUT:	two way radio	M/N:	RDR2600V
Mode:	Charging	Phase:	L
Tested by:	Bilg Li (Engineer)	Power:	DC 9V by Adapter
Temperature: / Humidity	24.4°C / 50.8%	Test date:	2016-09-12

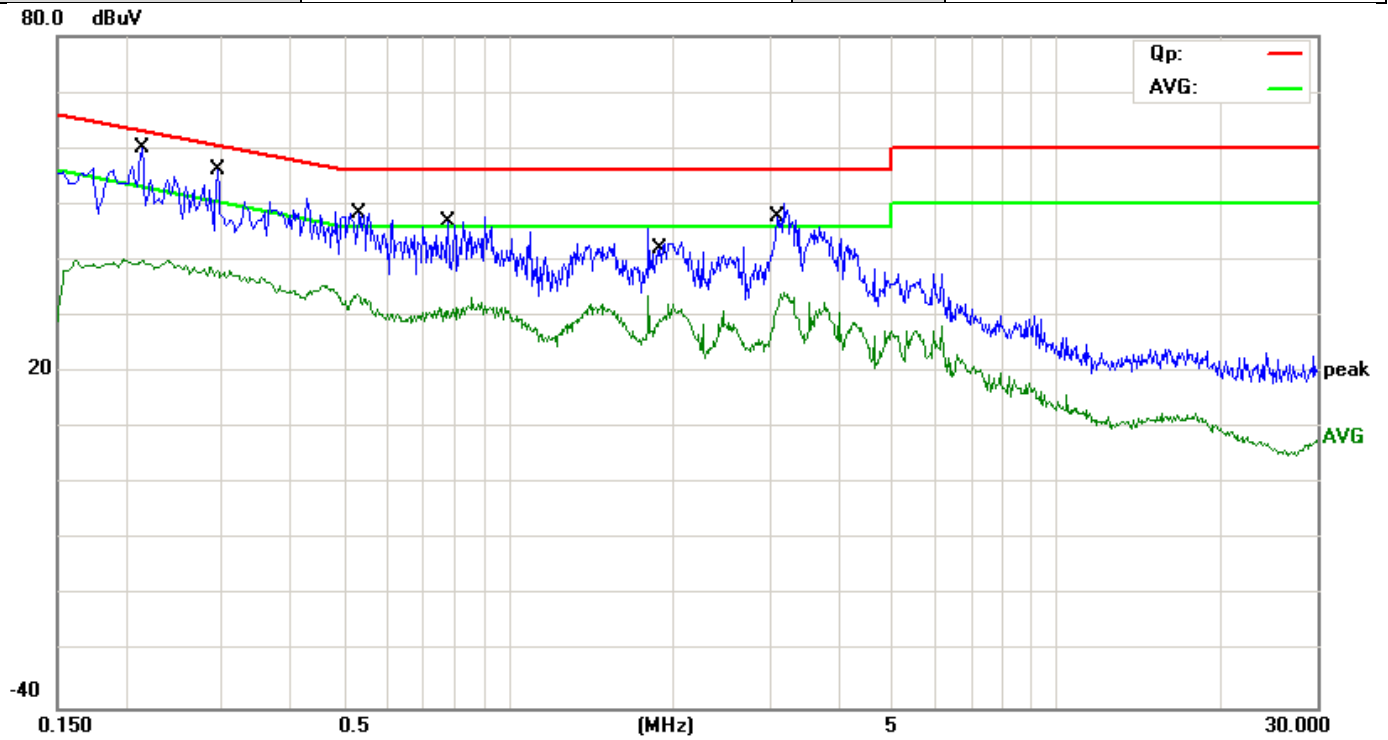

No.	Mk.	Freq. MHz	Reading Level dBuV	Correct Factor dB	Measure- ment dBuV	Limit dBuV	Over dB	Detector	Comment
1		0.2138	37.99	11.91	49.90	63.06	-13.16	QP	
2		0.2138	27.93	11.91	39.84	53.06	-13.22	AVG	
3		0.2941	33.15	11.37	44.52	60.41	-15.89	QP	
4		0.2941	26.15	11.37	37.52	50.41	-12.89	AVG	
5		0.5293	29.81	10.00	39.81	56.00	-16.19	QP	
6	*	0.5293	23.22	10.00	33.22	46.00	-12.78	AVG	
7		0.7680	26.55	10.00	36.55	56.00	-19.45	QP	
8		0.7680	20.04	10.00	30.04	46.00	-15.96	AVG	
9		1.8741	26.41	9.13	35.54	56.00	-20.46	QP	
10		1.8741	18.33	9.13	27.46	46.00	-18.54	AVG	
11		3.1161	30.75	10.12	40.87	56.00	-15.13	QP	
12		3.1161	21.39	10.12	31.51	46.00	-14.49	AVG	

*:Maximum data x:Over limit !:over margin

EUT:	two way radio	M/N:	RDR2600V
Mode:	Charging	Phase:	N
Tested by:	Bilg Li (Engineer)	Power:	DC 9V by Adapter
Temperature: / Humidity	24.4°C / 50.8%	Test date:	2016-09-12

80.0 dBuV

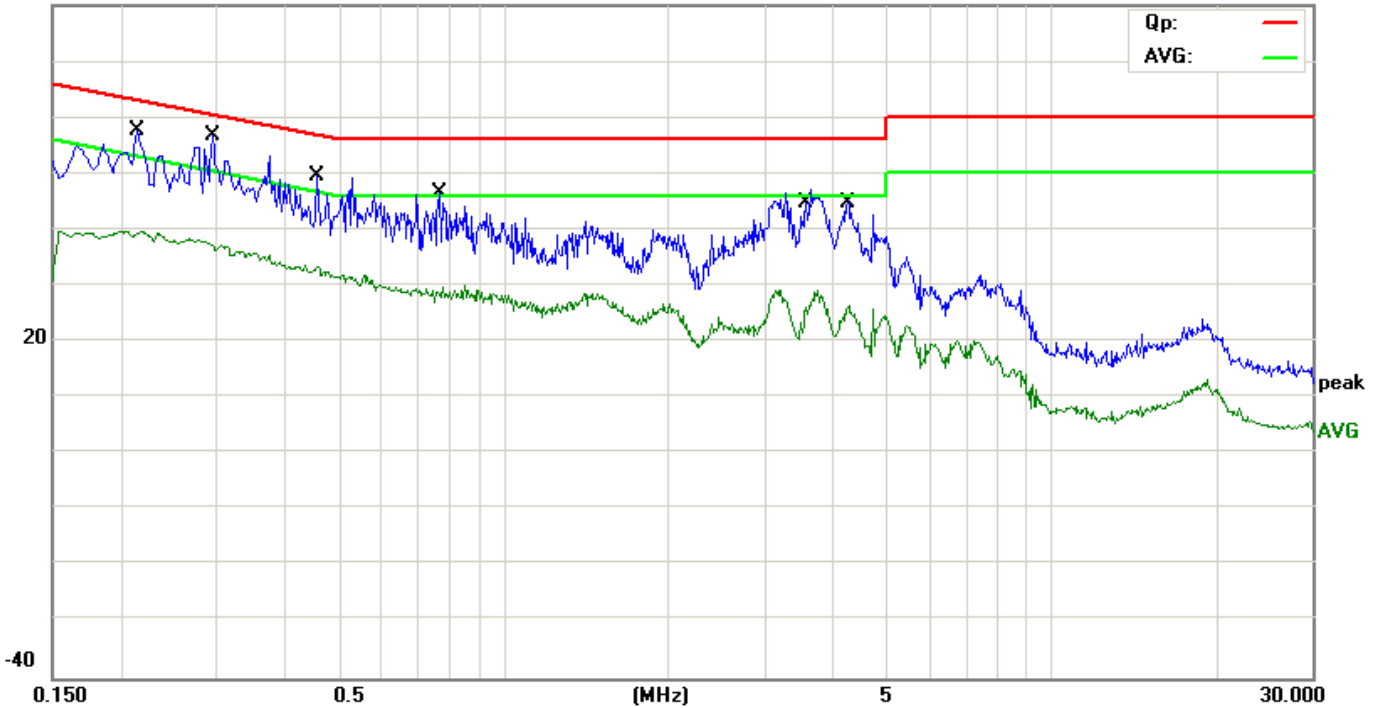

No.	Mk.	Freq. MHz	Reading Level dBuV	Correct Factor dB	Measurement dBuV	Limit dBuV	Over dB	Detector	Comment
1		0.2122	35.77	11.92	47.69	63.12	-15.43	QP	
2		0.2122	27.39	11.92	39.31	53.12	-13.81	AVG	
3		0.2921	32.49	11.39	43.88	60.46	-16.58	QP	
4	*	0.2921	25.56	11.39	36.95	50.46	-13.51	AVG	
5		0.4600	28.75	10.27	39.02	56.69	-17.67	QP	
6		0.4600	22.52	10.27	32.79	46.69	-13.90	AVG	
7		0.7620	24.87	10.00	34.87	56.00	-21.13	QP	
8		0.7620	18.25	10.00	28.25	46.00	-17.75	AVG	
9		3.5646	26.19	10.56	36.75	56.00	-19.25	QP	
10		3.5646	10.43	10.56	20.99	46.00	-25.01	AVG	
11		4.2045	25.97	11.20	37.17	56.00	-18.83	QP	
12		4.2045	11.11	11.20	22.31	46.00	-23.69	AVG	

*:Maximum data x:Over limit !:over margin

4.2 Occupied Bandwidth and Emission Mask

PROVISIONS APPLICABLE

a). Occupied Bandwidth: The EUT was connected to the audio signal generator and the spectrum analyzer via the main RF connector, and through an appropriate attenuator. The EUT was controlled to transmit its maximum power. Then the bandwidth of 99% power can be measured by the spectrum analyzer.

(b). Emission Mask B: For transmitters that are equipped with an audio low-pass filter pursuant to §90.211(a), the power of any emission must be below the unmodulated carrier power (P) as follows:

(1) On any frequency removed from the assigned frequency by more than 50 percent, but not more than 100 percent of the authorized bandwidth: At least 25 dB.

(2) On any frequency removed from the assigned frequency by more than 100 percent, but not more than 250 percent of the authorized bandwidth: At least 35 dB.

(3) On any frequency removed from the assigned frequency by more than 250 percent of the authorized bandwidth: At least $43 + 10 \log (P)$ dB.

(c). Emission Mask D, 12.5 kHz channel bandwidth equipment: For transmitters designed to operate with a 12.5 kHz channel bandwidth, any emission must be attenuated below the power (P) of the highest emission contained within the authorized bandwidth as follows:

(1) On any frequency from the center of the authorized bandwidth f_0 to 5.625 kHz removed from f_0 : Zero dB.

(2) On any frequency removed from the center of the authorized bandwidth by a displacement frequency (fd in kHz) of more than 5.625 kHz but no more than 12.5 kHz: At least $7.27(fd - 2.88 \text{ kHz})$ dB.

(3) On any frequency removed from the center of the authorized bandwidth by a displacement frequency (fd in kHz) of more than 12.5 kHz: At least $50 + 10 \log (P)$ dB or 70 dB, whichever is the lesser attenuation.

(d). Emission Mask E—6.25 kHz or less channel bandwidth equipment. For transmitters designed to operate with a 6.25 kHz or less bandwidth, any emission must be attenuated below the power (P) of the highest emission contained within the authorized bandwidth as follows

(1) On any frequency from the center of the authorized bandwidth f_0 to 3.0 kHz removed from f_0 : Zero dB.

(2) On any frequency removed from the center of the authorized bandwidth by a displacement frequency (fd in kHz) of more than 3.0 kHz but no more than 4.6 kHz: At least $30 + 16.67(fd - 3 \text{ kHz})$ or $55 + 10 \log (P)$ or 65 dB, whichever is the lesser attenuation.

(3) On any frequency removed from the center of the authorized bandwidth by more than 4.6 kHz: At least $55 + 10 \log (P)$ or 65 dB, whichever is the lesser attenuation.

TEST CONFIGURATION

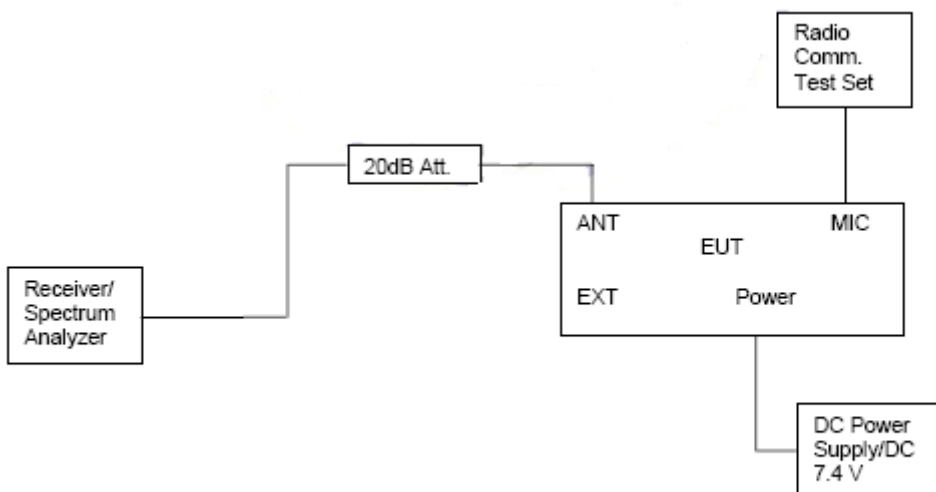

TEST PROCEDURE

1 The EUT was modulated by 2.5 KHz Sine wave audio signal; the level of the audio signal employed is 16 dB greater than that necessary to produce 50% of rated system deviation. Rated system deviation is 2.5 kHz (12.5 kHz channel spacing)

2 Set EUT as normal operation.

3 Set SPA Center Frequency = fundamental frequency, RBW=300Hz, VBW= 3 KHz, span =50 KHz.

4 Set SPA Max hold. Mark peak, Set 99% Occupied Bandwidth and 26dB Occupied Bandwidth.

6 Set SPA Center Frequency=fundamental frequency, set =100Hz, VBW=1 KHz, span=50 KHz for 12.5 channel spacing and set =100Hz, VBW=1 KHz, span=50 KHz for 6.25 channel spacing

TEST RESULTS:**4.2.1 Occupied Bandwidth**

High power:

Modulation Type	Channel Separation	Test Channel	Test Frequency	99% Occupied Bandwidth (KHz)	26dB Occupied Band width (KHz)
4FSK	12.5KHz	Low	137.0125 MHz	5.6	7.84
		Middle	152.0125 MHz	5.44	7.2
		High	169.9870 MHz	5.76	7.68
Limit		11.25KHz for 12.5KHz Channel Separation			
		6.00KHz for 6.25KHz Channel Separation			
Test Results		Compliance			

Low power:

Modulation Type	Channel Separation	Test Channel	Test Frequency	99% Occupied Bandwidth (KHz)	26dB Occupied Band width (KHz)
4FSK	12.5KHz	Low	137.0125 MHz	5.76	7.68
		Middle	152.0125 MHz	5.44	7.04
		High	169.9870 MHz	5.6	6.88
Limit		11.25KHz for 12.5KHz Channel Separation			
		6.00KHz for 6.25KHz Channel Separation			
Test Results		Compliance			

Plots of 99% and 26dB Bandwidth Measurement

High power:

Modulation Type	Channel Separation	Freq.(MHz)	99% Bandwidth (KHz)	26dB Bandwidth (KHz)	FCC Limit (KHz)	Results
4FSK	12.5KHz	137.0125	5.6	7.84	11.25	Compliance

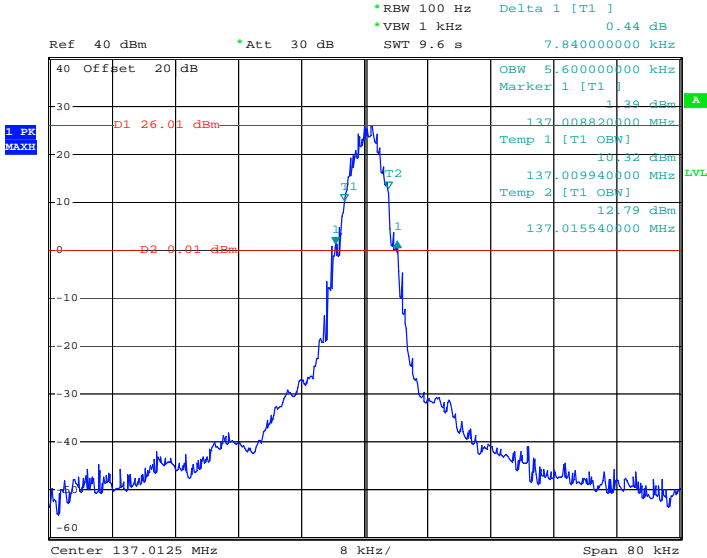

Date: 6.DEC.2016 10:25:02

High power:

Modulation Type	Channel Separation	Freq.(MHz)	99% Bandwidth (KHz)	26dB Bandwidth (KHz)	FCC Limit (KHz)	Results
4FSK	12.5KHz	152.0125	5.44	7.2	11.25	Compliance

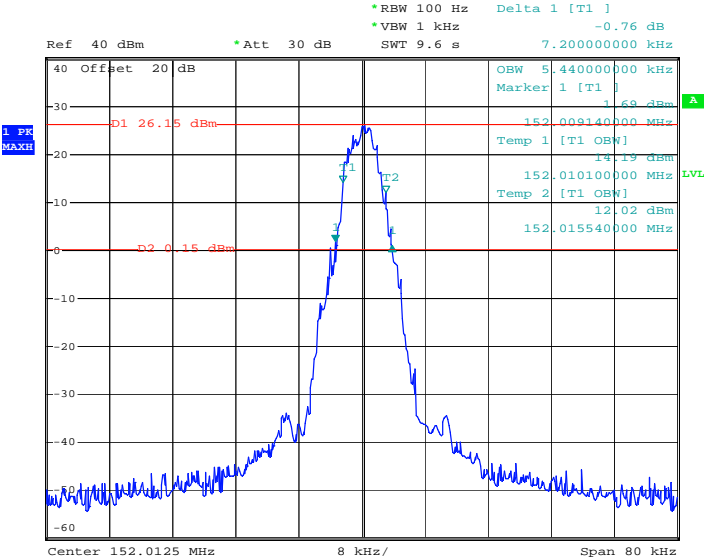

Date: 6.DEC.2016 10:08:19

High power:

Modulation Type	Channel Separation	Freq.(MHz)	99% Bandwidth (KHz)	26dB Bandwidth (KHz)	FCC Limit (KHz)	Results
4FSK	12.5KHz	169.9870	5.6	7.68	11.25	Compliance

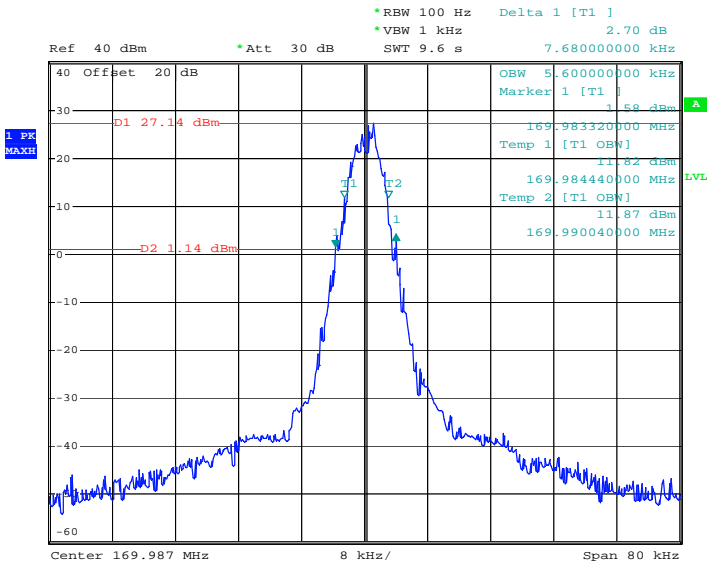

Date: 6.DEC.2016 09:57:48

Low power:

Modulation Type	Channel Separation	Freq.(MHz)	99% Bandwidth (KHz)	26dB Bandwidth (KHz)	FCC Limit (KHz)	Results
4FSK	12.5KHz	137.0125	5.76	7.68	11.25	Compliance

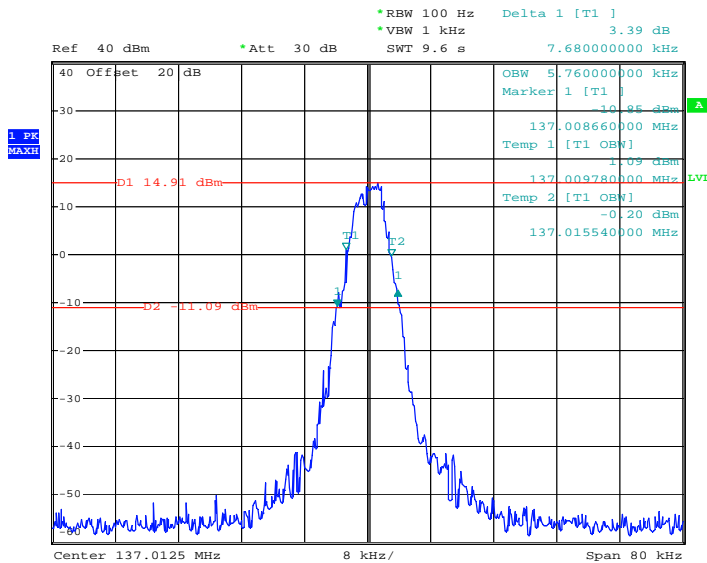

Date: 6.DEC.2016 10:17:50

Low power:

Modulation Type	Channel Separation	Freq.(MHz)	99% Bandwidth (KHz)	26dB Bandwidth (KHz)	FCC Limit (KHz)	Results
4FSK	12.5KHz	152.0125	5.44	7.04	11.25	Compliance

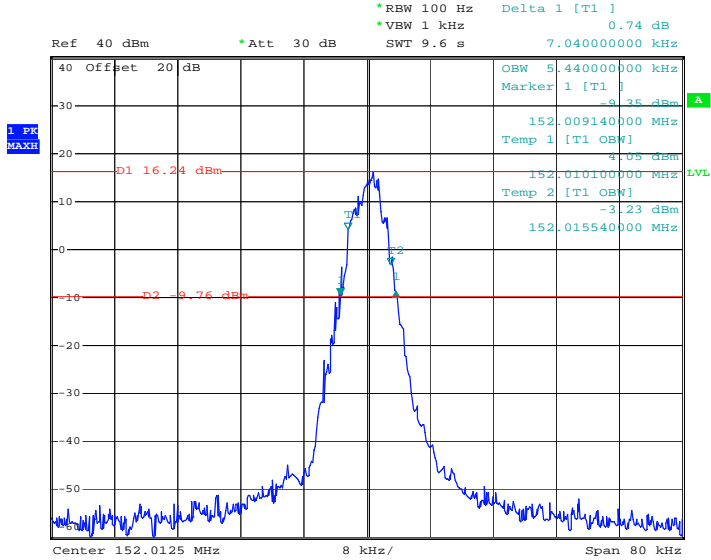

Date: 6.DEC.2016 10:03:02

Low power:

Modulation Type	Channel Separation	Freq.(MHz)	99% Bandwidth (KHz)	26dB Bandwidth (KHz)	FCC Limit (KHz)	Results
4FSK	12.5KHz	169.9870	5.6	6.88	11.25	Compliance

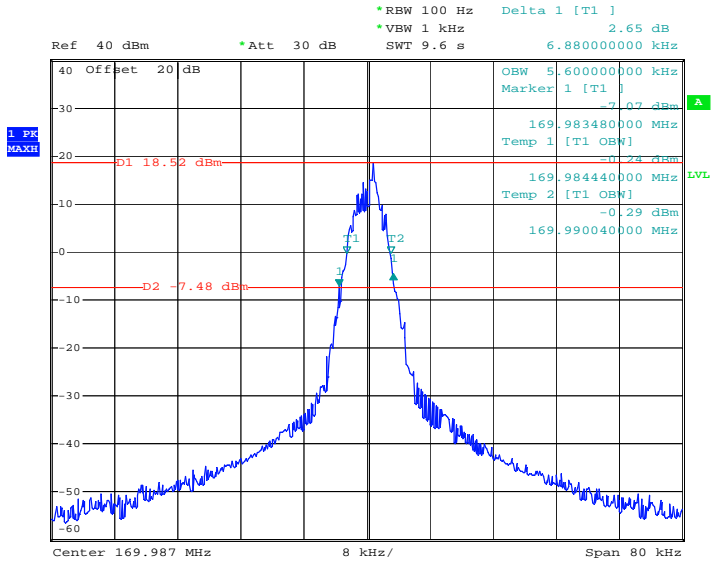

Date: 6.DEC.2016 09:51:46

4.3 Emission Mask

Applicable Standard

FCC § 90.210

(b) Emission Mask B. For transmitters that are equipped with an audio low-pass filter, the power of any emission must be attenuated below the unmodulated carrier power (P) as follows:

(1) On any frequency removed from the assigned frequency by more than 50 percent, but not more than 100 percent of the authorized bandwidth: At least 25 dB.

(2) On any frequency removed from the assigned frequency by more than 100 percent, but not more than 250 percent of the authorized bandwidth: At least 35 dB.

(3) On any frequency removed from the assigned frequency by more than 250 percent of the authorized bandwidth: At least $43 + 10 \log (P)$ dB.

(d) Emission Mask D—12.5 kHz channel bandwidth equipment. For transmitters designed to operate with a 12.5 kHz channel bandwidth, any emission must be attenuated below the power (P) of the highest emission contained within the authorized bandwidth as follows:

(1) On any frequency from the center of the authorized bandwidth f_0 to 5.625 kHz removed from f_0 : Zero dB.

(2) On any frequency removed from the center of the authorized bandwidth by a displacement frequency (f_d in kHz) of more than 5.625 kHz but no more than 12.5 kHz: At least $7.27(f_d - 2.88 \text{ kHz})$ dB.

(3) On any frequency removed from the center of the authorized bandwidth by a displacement frequency (f_d in kHz) of more than 12.5 kHz: At least $50 + 10 \log (P)$ dB or 70 dB, whichever is the lesser attenuation.

(4) The reference level for showing compliance with the emission mask shall be established using a resolution bandwidth sufficiently wide (usually two or three times the channel bandwidth) to capture the true peak emission of the equipment under test. In order to show compliance with the emission mask up to and including 50 kHz removed from the edge of the authorized bandwidth, adjust the resolution bandwidth to 100 Hz with the measuring instrument in a peak hold mode. A sufficient number of sweeps must be measured to insure that the emission profile is developed. If video filtering is used, its bandwidth must not be less than the instrument resolution bandwidth. For emissions beyond 50 kHz from the edge of the authorized bandwidth, see paragraph (o) of this section. If it can be shown that use of the above instrumentation settings do not accurately represent the true interference potential of the equipment under test, an alternate procedure may be used provided prior Commission approval is obtained.

Modulation Type	Channel Separation	Test Channel	Test Frequency	FCC Applicable Mask	RBW
4FSK	12.5KHz	Low	137.0125 MHz	B	100Hz
		Middle	152.0125 MHz	D	100Hz
		High	169.9870 MHz	D	100Hz
Test Results		Compliance			

Referred as the attached plot hereinafter

High power

Modulation Type	Channel Separation	Freq.(MHz)	FCC Applicable Mask	RBW	Audio Freq. (KHz)	Results
4FSK	12.5KHz	137.0125	B	100Hz	/	Compliance

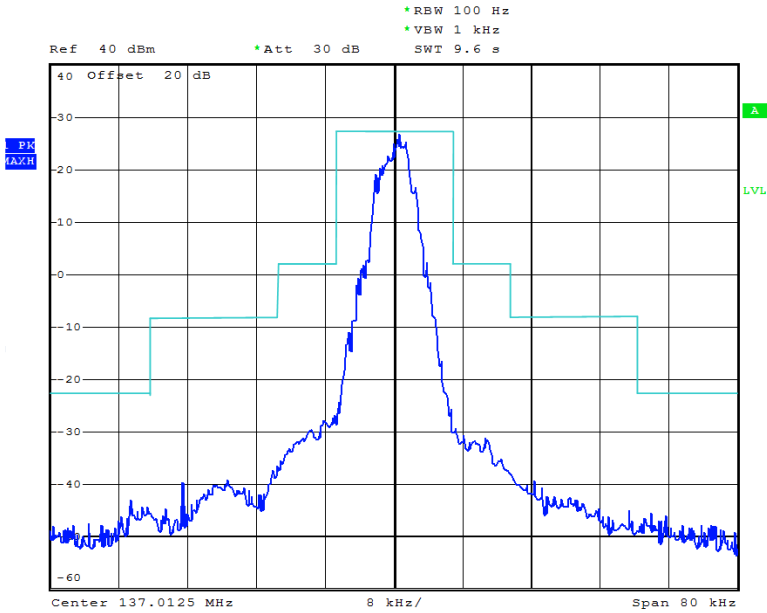

12.5 kHz Channel Spacing, 137.0125 MHz, 4FSK Modulation Only

High power

Modulation Type	Channel Separation	Freq.(MHz)	FCC Applicable Mask	RBW	Audio Freq. (KHz)	Results
4FSK	12.5KHz	152.0125	D	100Hz	/	Compliance

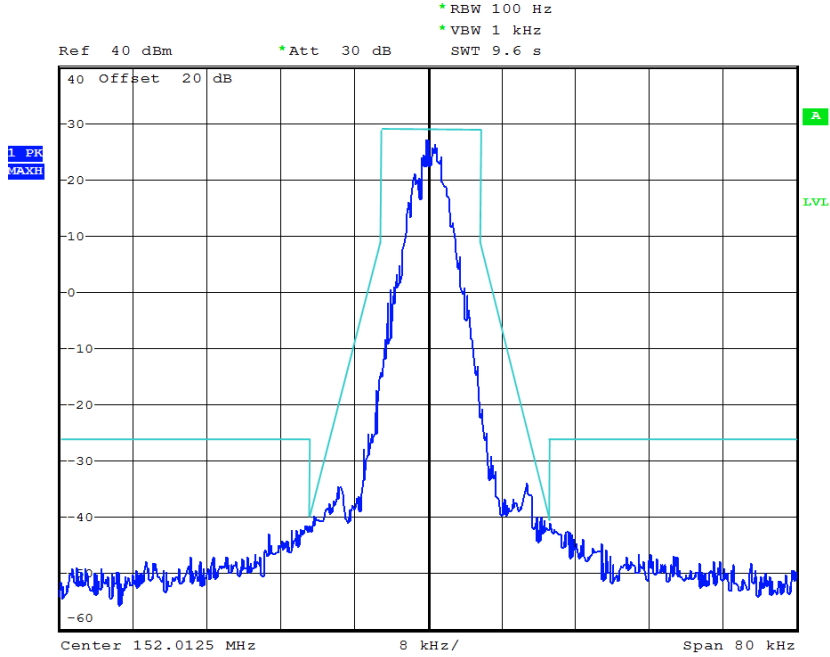

12.5 kHz Channel Spacing, 152.0125MHz, 4FSK Modulation Only

High power

Modulation Type	Channel Separation	Freq.(MHz)	FCC Applicable Mask	RBW	Audio Freq. (KHz)	Results
4FSK	12.5KHz	169.9870	D	100Hz	/	Compliance

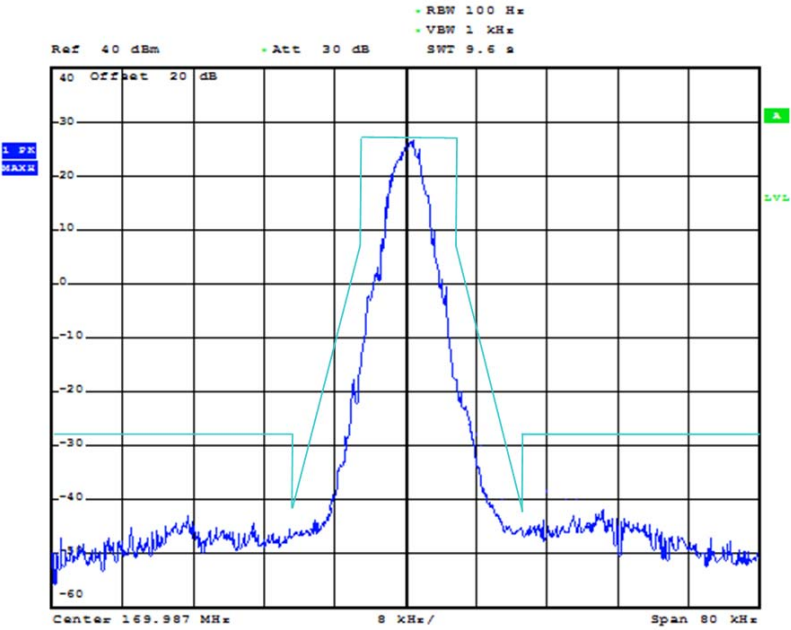

12.5 kHz Channel Spacing, 169.9870 MHz, 4FSK Modulation Only

Low power

Modulation Type	Channel Separation	Freq.(MHz)	FCC Applicable Mask	RBW	Audio Freq. (KHz)	Results
4FSK	12.5KHz	137.0125	B	100Hz	/	Compliance

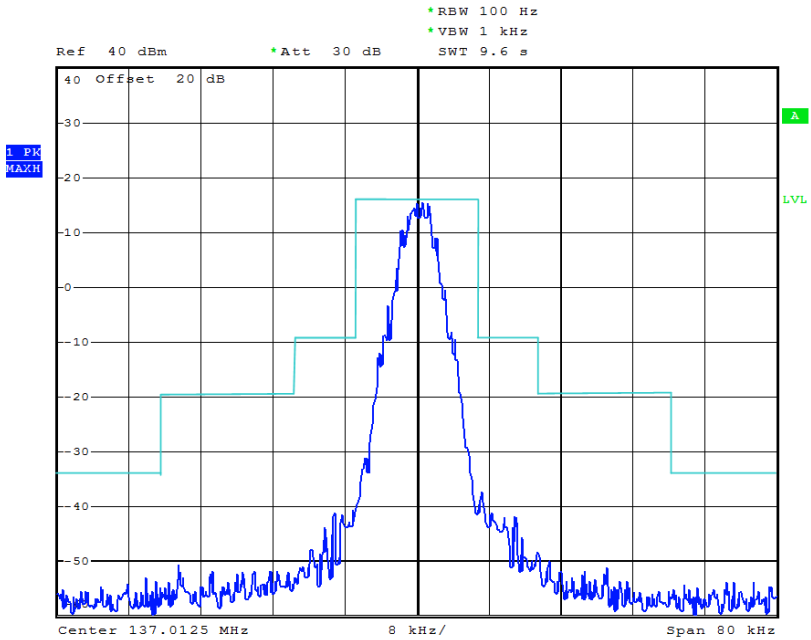

12.5 kHz Channel Spacing, 137.0125 MHz, 4FSK Modulation Only

Low power

Modulation Type	Channel Separation	Freq.(MHz)	FCC Applicable Mask	RBW	Audio Freq. (KHz)	Results
4FSK	12.5KHz	152.0125	D	100Hz	/	Compliance

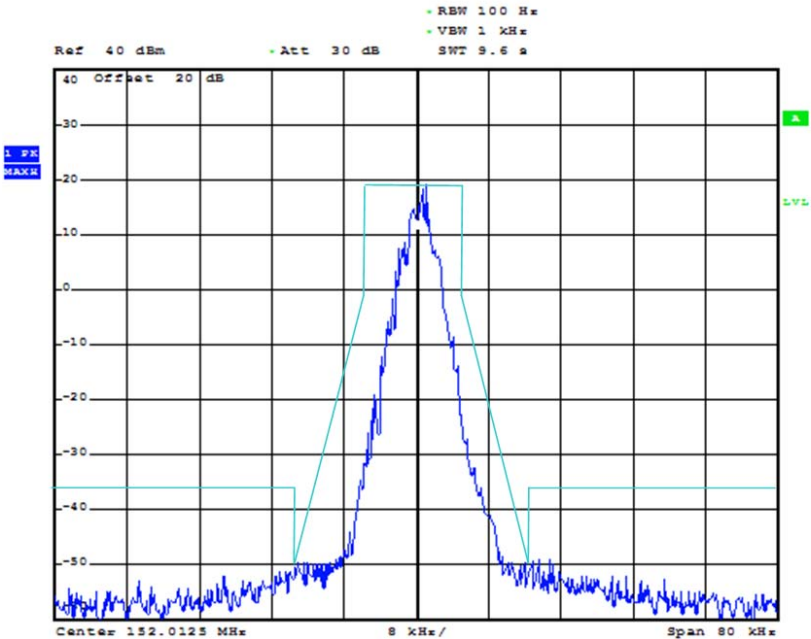

12.5 kHz Channel Spacing, 152.0125 MHz, 4FSK Modulation Only

Low power

Modulation Type	Channel Separation	Freq.(MHz)	FCC Applicable Mask	RBW	Audio Freq. (KHz)	Results
4FSK	12.5KHz	169.9870	D	100Hz	/	Compliance

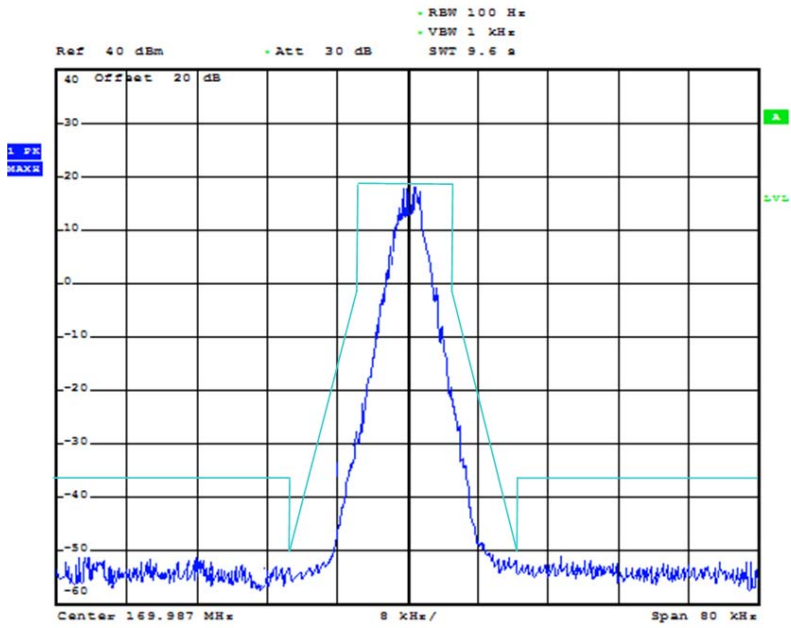

12.5 kHz Channel Spacing, 169.9870 MHz, 4FSK Modulation Only

4.3. Radiated Spurious Emission Test

TEST APPLICABLE

According to the TIA/EIA 603 test method, and according to Section 90.210, the power of each unwanted emission shall be less than Transmitted Power as specified below for transmitters designed to operate with 12.5 KHz channel bandwidth:

- 1 On any frequency removed from the center of the authorized bandwidth f_0 to 5.625 KHz removed from f_0 : Zero dB
- 2 On any frequency removed from the center of the authorized bandwidth by a displacement frequency (f_d in KHz) f_0 of more than 5.625 KHz but no more than 12.5 KHz: At least 7.27dB
- 3 On any frequency removed from the center of the authorized bandwidth by a displacement frequency (f_d in KHz) f_0 of more than 12.5 KHz: At least $50 + 10 \log (P)$ dB or 70 dB, which ever is lesser attenuation.

For transmitters designed to transmit with 6.25 KHz channel separation and equipped with an audio low-pass filter, the power of any emission must be attenuated below the unmodulated carrier power (P) as following:

- 1 On any frequency from the center of the authorized bandwidth f_0 to 3.0 kHz removed from f_0 : Zero dB.
- 2 On any frequency removed from the center of the authorized bandwidth by a displacement frequency (f_d in kHz) of more than 3.0 kHz but no more than 4.6 kHz: At least $30 + 16.67(f_d - 3 \text{ kHz})$ or $55 + 10 \log (P)$ or 65 dB, whichever is the lesser attenuation.
- 3 On any frequency removed from the center of the authorized bandwidth by more than 4.6 kHz: At least $55 + 10 \log (P)$ or 65 dB, whichever is the lesser attenuation.

TEST CONFIGURATION

Below 1GHz:

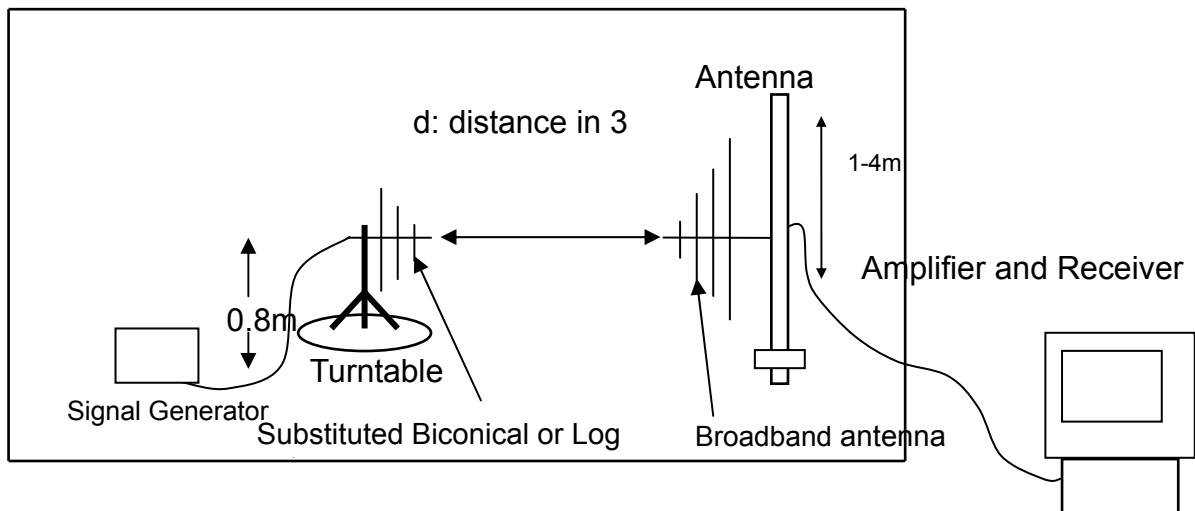

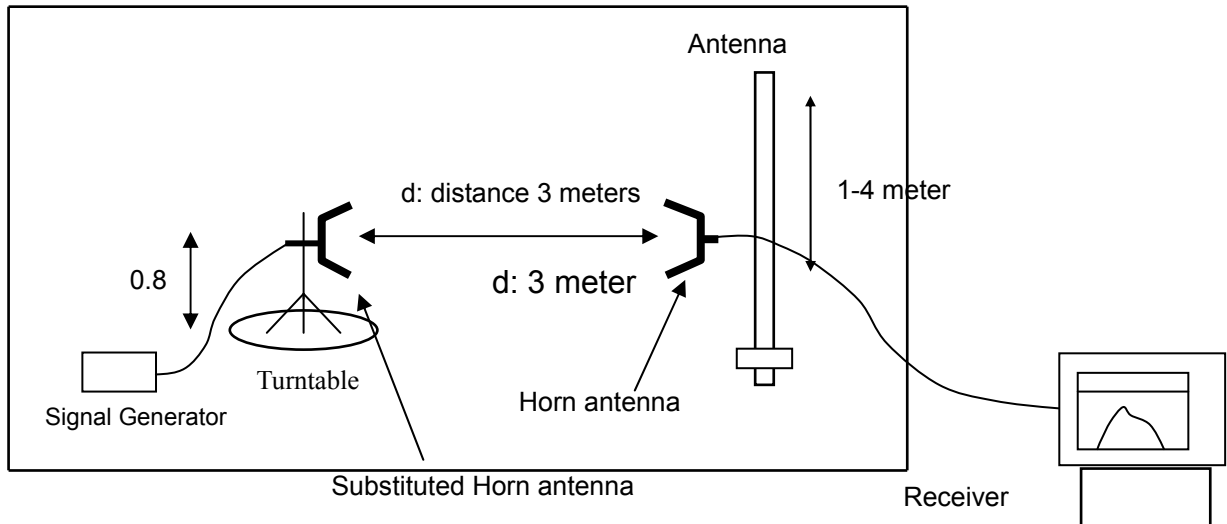
Above 1GHz:**TEST PROCEDURE**

The transmitter was placed on a wooden turntable, and it was transmitting into a non-radiating load, which was also placed on the turntable.

The measurement antenna was placed at a distance of 3 meters from the EUT. During the tests, the antenna height and polarization as well as EUT azimuth were varied in order to identify the maximum level of emissions from the EUT. The test was performed by placing the EUT on 3-orthogonal axis. The frequency range up to teeth harmonic of the fundamental frequency was investigated.

Remove the EUT and replace it with substitution antenna. A signal generator was connected to the substitution antenna by a non-radiating cable. The absolute levels of the spurious emissions were measured by the substitution.

Spurious emissions in dB = $10 \lg(\text{TX}_{\text{pwr}} \text{ in Watts}/0.001)$ - the absolute level Spurious attenuation limit in dB = $50 + 10 \lg(\text{power out in Watts})$ for EUT with a 12.5 kHz channel bandwidth.

TEST RESULTS**Modulation Type: 4FSK**

Note: 1. In general, the worse case attenuation requirement shown above was applied.

2. The measurement frequency range from 30 MHz to 5 GHz.

3. *** means that the emission level is too low to be measured or at least 20 dB down than the limit.

Modulation		4FSK		Channel Separation		12.5KHz		
Test Channel		Low Channel		Test Frequency		137.0125 MHz		
Frequency (MHz)	E-Field Level (dBuv/m)	EMI Detector (Peak/QP)	Antenna Polarization	Antenna Height (cm)	Table Angle (Degree)	ERP measured by Substitution Method(dBm)	Limit (dBm)	Margin (dB)
513.45	42.90	Peak	H	140	247	-52.45	-20	-32.45
2463.27	49.68	Peak	H	120	152	-45.71	-20	-25.71
3187.77	41.12	Peak	H	120	47	-53.12	-20	-33.12
...			H					
511.51	52.44	Peak	V	100	345	-46.85	-20	-26.85
2451.56	47.95	Peak	V	130	94	-48.11	-20	-28.11
3334.92	42.68	Peak	V	120	123	-54.07	-20	-34.07
...	...	/	V	/	/	/	/	/

Modulation		4FSK		Channel Separation		12.5KHz		
Test Channel		Middle Channel		Test Frequency		152.0125 MHz		
Frequency (MHz)	E-Field Level (dBuv/m)	EMI Detector (Peak/QP)	Antenna Polarization	Antenna Height (cm)	Table Angle (Degree)	ERP measured by Substitution Method(dBm)	Limit (dBm)	Margin (dB)
502.12	43.39	Peak	H	140	261	-51.12	-20	-30.12
2451.98	49.52	Peak	H	120	156	-44.70	-20	-24.70
3242.23	44.66	Peak	H	120	44	-53.25	-20	-33.25
...			H					
486.43	51.11	Peak	V	100	350	-45.71	-20	-25.71
2501.68	50.92	Peak	V	130	101	-47.04	-20	-27.04
3271.42	42.10	Peak	V	120	147	-51.24	-20	-31.24
...	...	/	V	/	/	/	/	/

Modulation		4FSK		Channel Separation		12.5KHz		
Test Channel		High Channel		Test Frequency		169.9870 MHz		
Frequency (MHz)	E-Field Level (dBuv/m)	EMI Detector (Peak/QP)	Antenna Polarization	Antenna Height (cm)	Table Angle (Degree)	ERP measured by Substitution Method(dBm)	Limit (dBm)	Margin (dB)
520.11	42.26	Peak	H	100	302	-52.13	-20	-32.13
2413.55	47.92	Peak	H	200	78	-46.02	-20	-26.02
3472.42	43.15	Peak	H	200	149	-52.66	-20	-32.66
...			H					
463.10	49.75	Peak	V	100	274	-46.74	-20	-26.74
2456.12	50.15	Peak	V	200	105	-46.16	-20	-26.16
3275.43	42.36	Peak	V	100	43	-55.37	-20	-35.37
...	...	/	V	/	/	/	/	/

4.4. Spurious Emission On Antenna Port

TEST APPLICABLE

The same as Section 4.3

TEST PROCEDURE

The RF output of the EUT was connected to a spectrum analyzer through appropriate attenuation. The resolution bandwidth of the spectrum analyzer was set to 100 kHz. Sufficient scans were taken to show any out of band emission up to 10th. Harmonic for the lower and the highest frequency range. Set RBW 100 kHz, VBW 300 kHz in the frequency band 30MHz to 1GHz, while set RBW=1MHz.VBW=3MHz from the 1GHz to 10th Harmonic.

The audio input was set to 0 to get the unmodulated carrier, the resulting picture is print out for each channel separation.

TEST CONFIGURATION

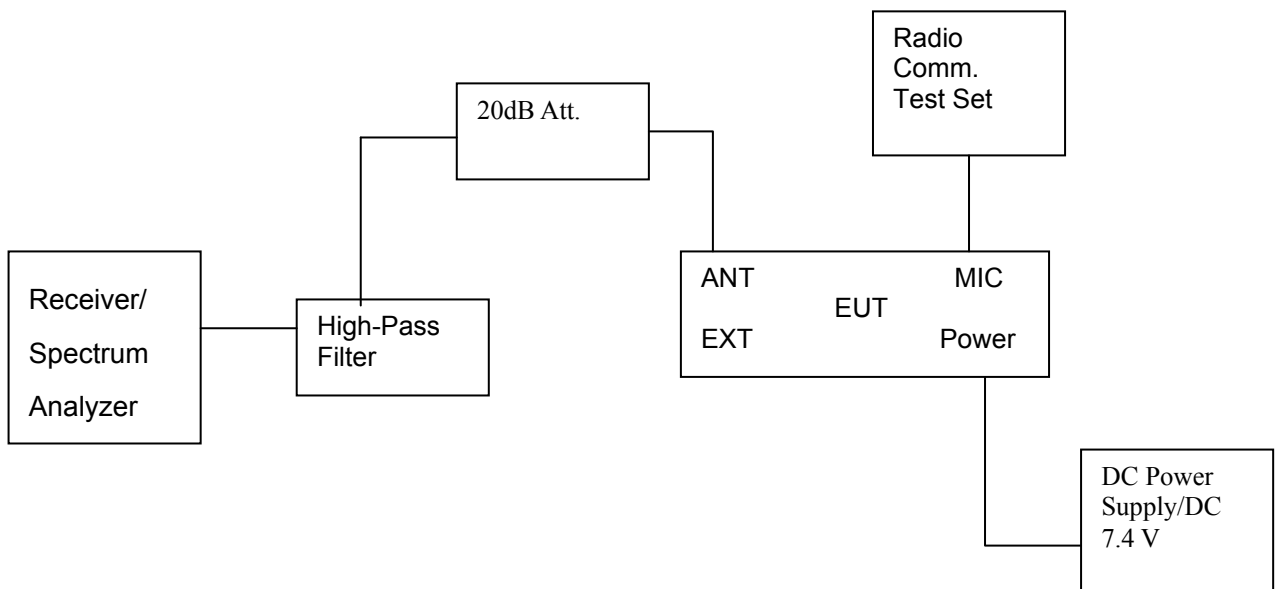

TEST RESULTS:

Modulation Type: 4FSK

Note: 1. In general, the worse case attenuation requirement shown above was applied.

2. The measurement frequency range from 30 MHz to 5 GHz.

Plots of Spurious Emission on Antenna Port Measurement

See next pages.

Modulation Type	Channel Separation	Rated Power (Watt)	Test Frequency (MHz)	Maximum Conducted Spurious Emissions Below 1GHz		Maximum Conducted Spurious Emissions Above 1GHz		FCC limit
				Frequency (MHz)	Results (dBm)	Frequency (MHz)	Results (dBm)	
4FSK	12.5KHz	5.0	137.0125	614	-16.78	2990	-13.04	-20dBc
Test Results			Compliance					

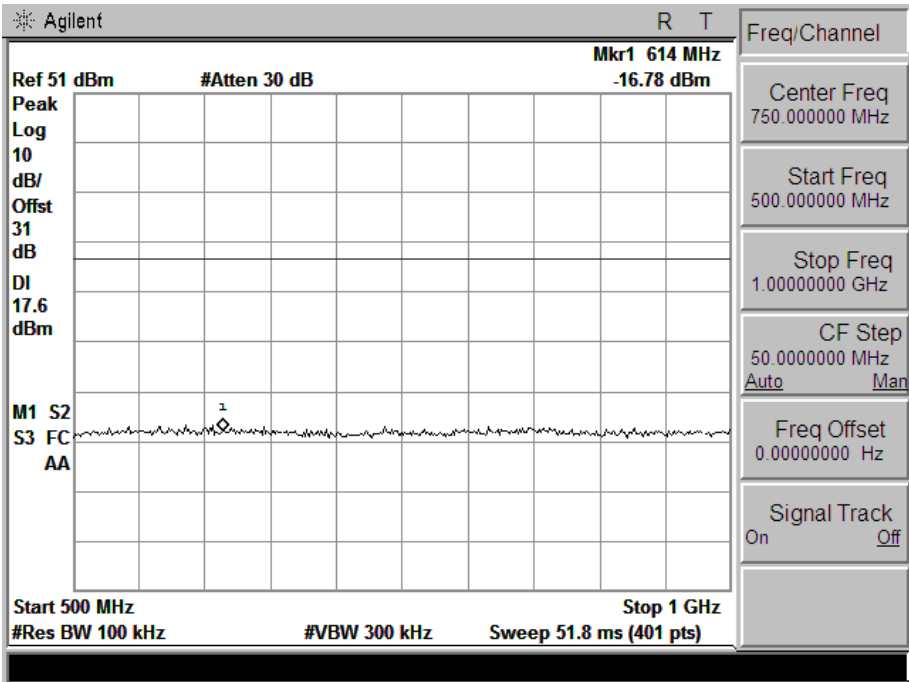
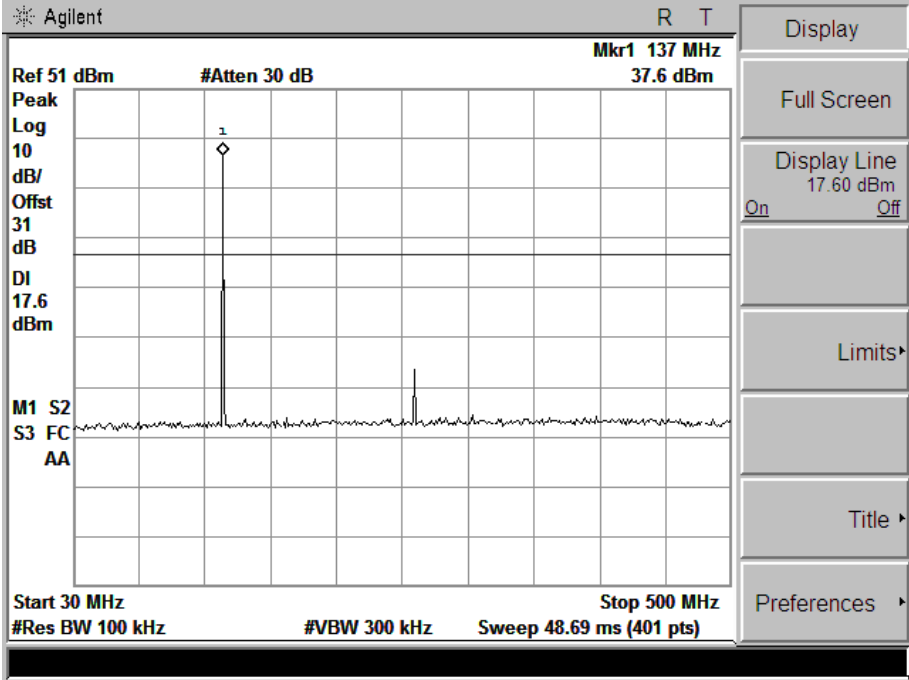

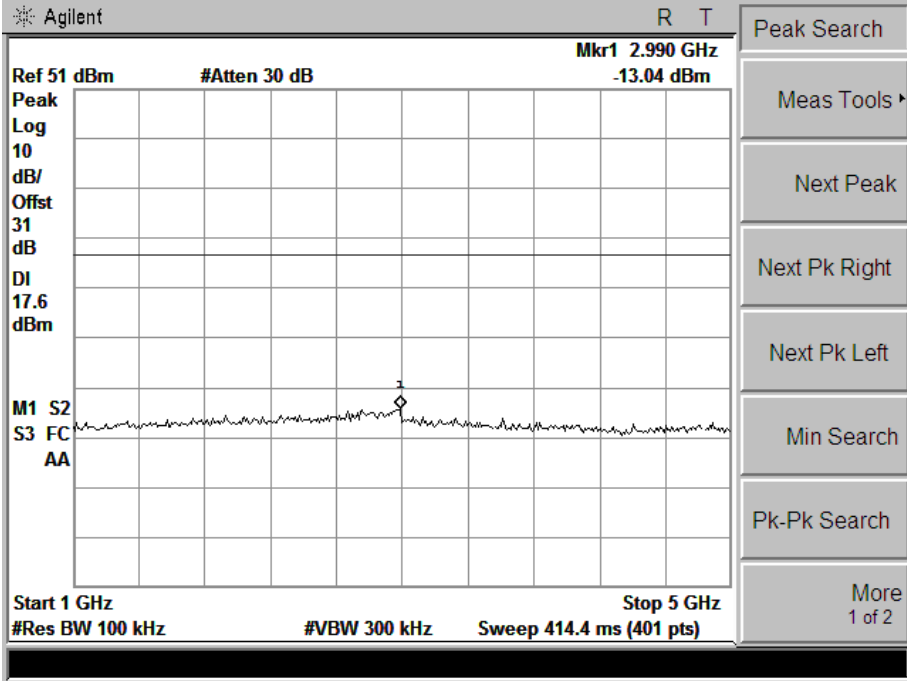

Modulation Type	Channel Separation	Rated Power (Watt)	Test Frequency (MHz)	Maximum Conducted Spurious Emissions Below 1GHz		Maximum Conducted Spurious Emissions Above 1GHz		FCC limit
				Frequency (MHz)	Results (dBm)	Frequency (MHz)	Results (dBm)	
4FSK	12.5KHz	5.0	152.0125	646.0	-15.21	2970.00	-13.24	-20dBc
Test Results			Compliance					

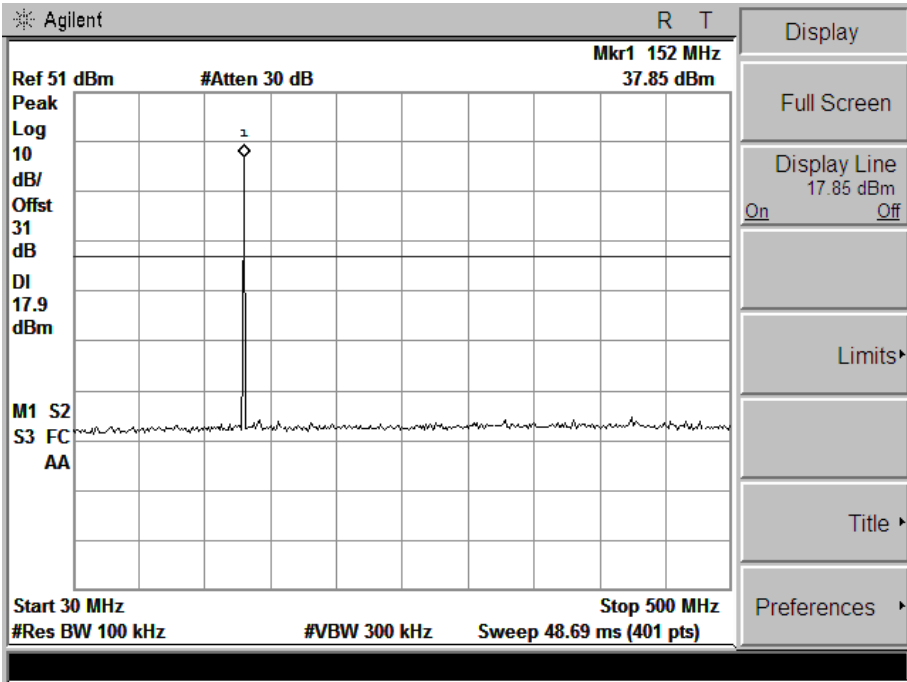

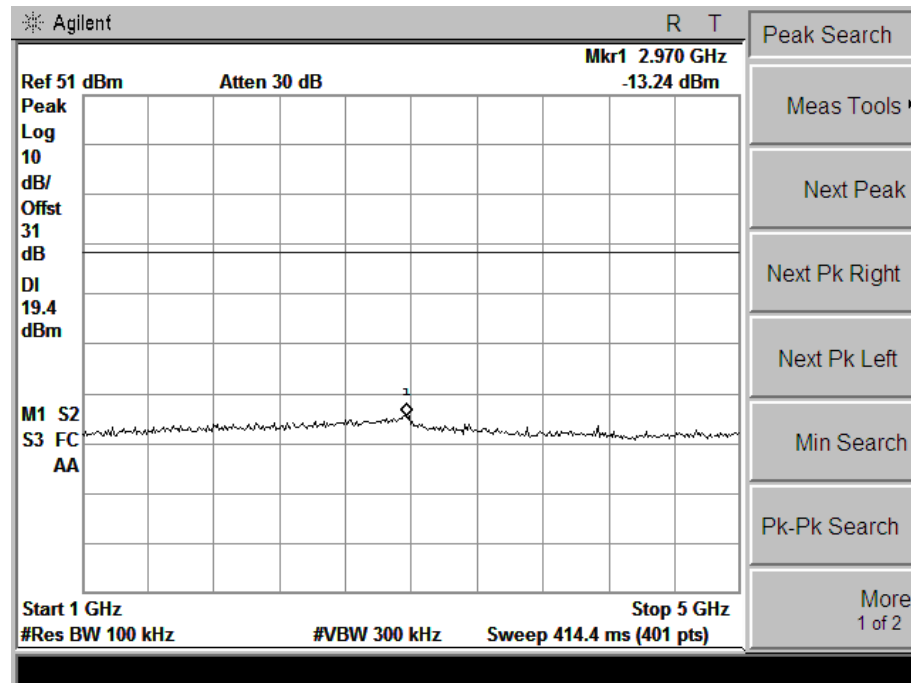
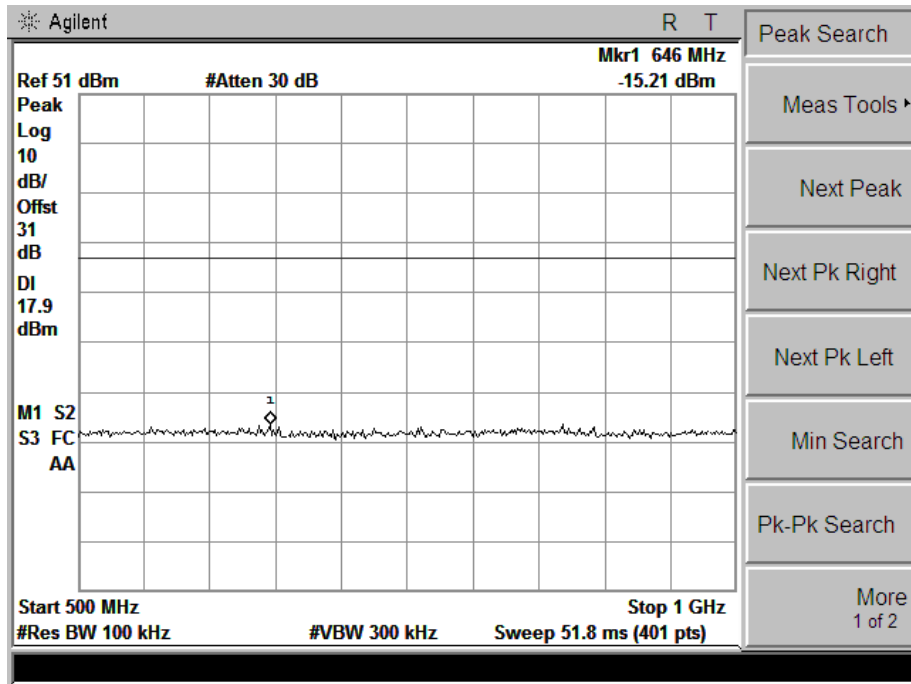

Modulation Type	Channel Separation	Rated Power (Watt)	Test Frequency (MHz)	Maximum Conducted Spurious Emissions Below 1GHz		Maximum Conducted Spurious Emissions Above 1GHz		FCC limit
				Frequency (MHz)	Results (dBm)	Frequency (MHz)	Results (dBm)	
4FSK	12.5KHz	5.0	169.9870	775.0	-16.11	2980.0	-13.21	-20dBc
Test Results			Compliance					

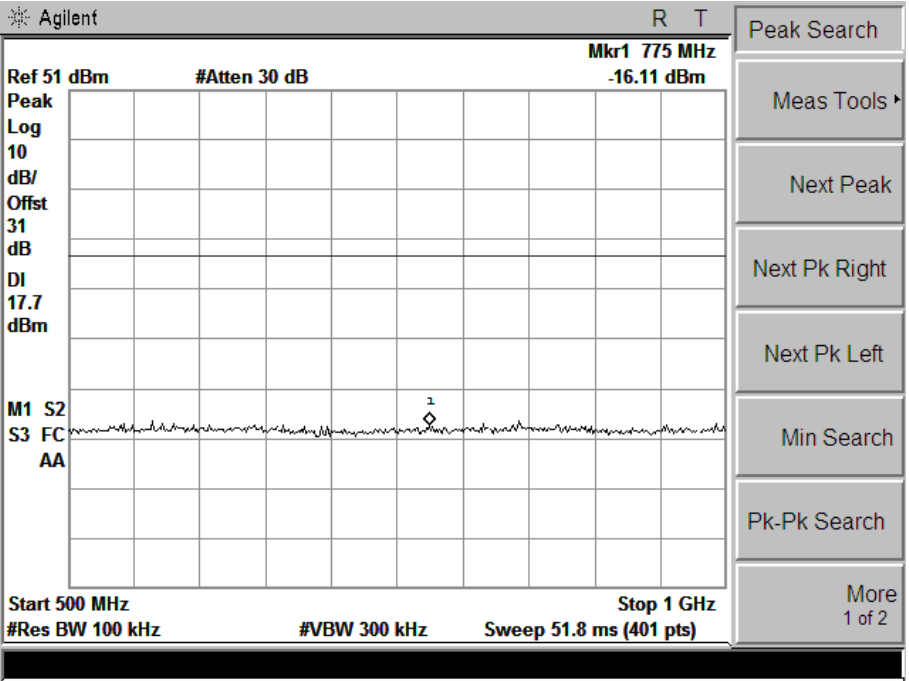
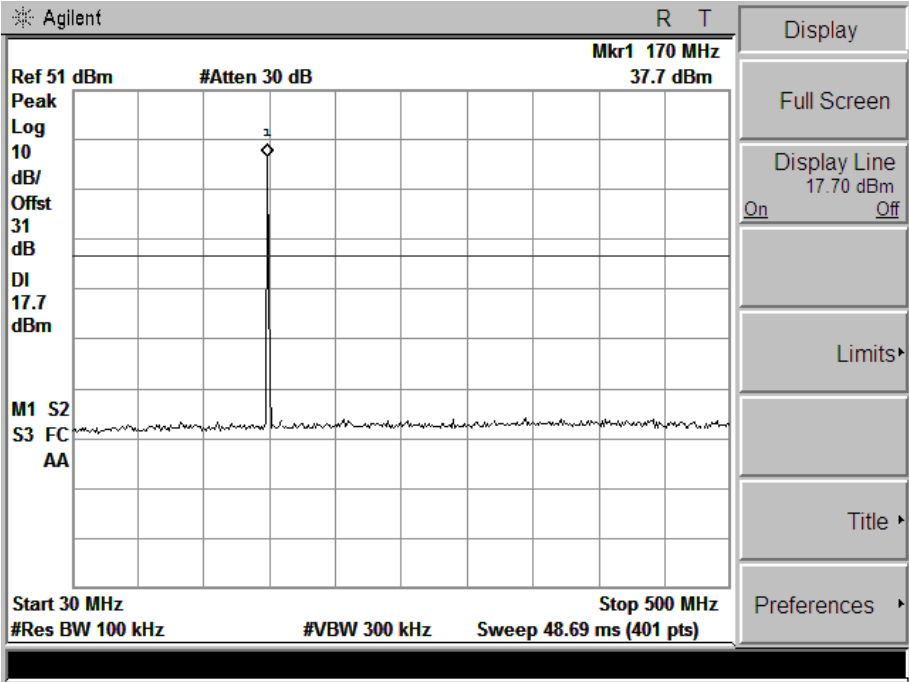

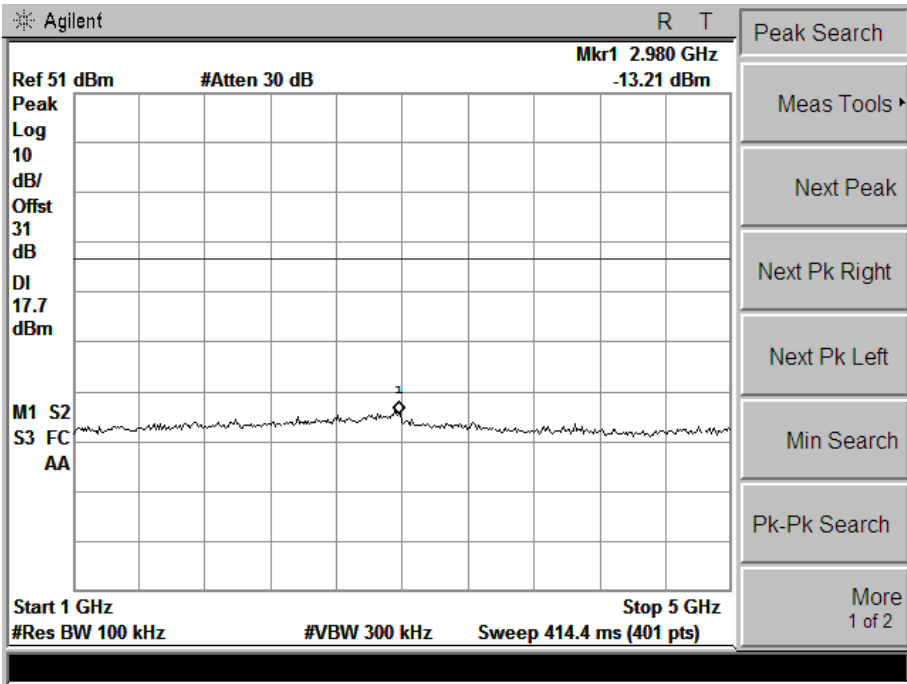

	Channel Separation	Rated Power (Watt)	Test Frequency (MHz)	Maximum Conducted Spurious Emissions Below 1GHz		Maximum Conducted Spurious Emissions Above 1GHz		FCC limit
				Frequency (MHz)	Results (dBm)	Frequency (MHz)	Results (dBm)	
4FSK	12.5KHz	0.5	137.0125	841.0	-15.15	2970.00	-13.35	-20dBc
Test Results			Compliance					

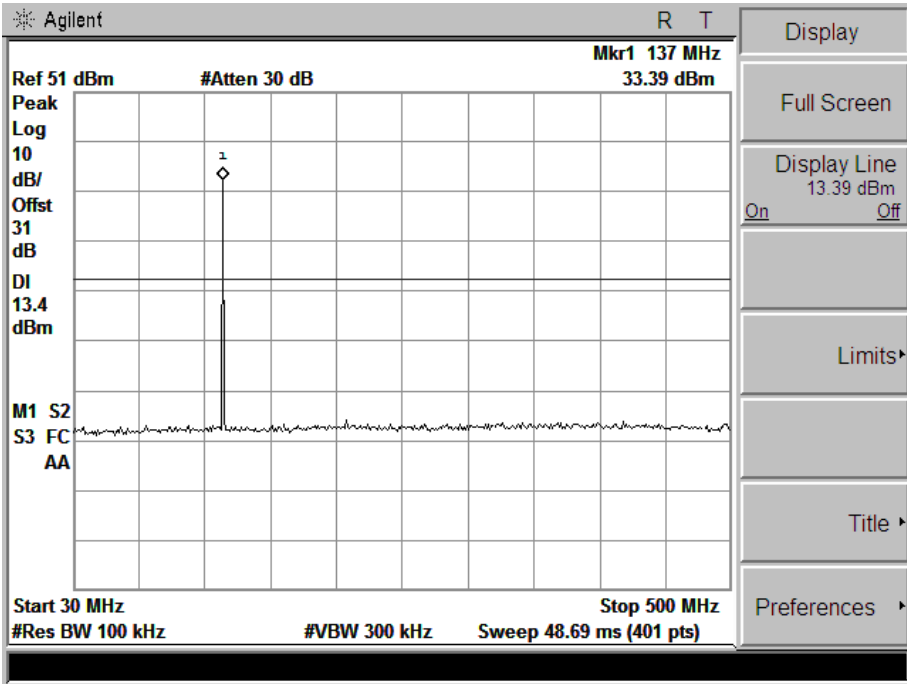

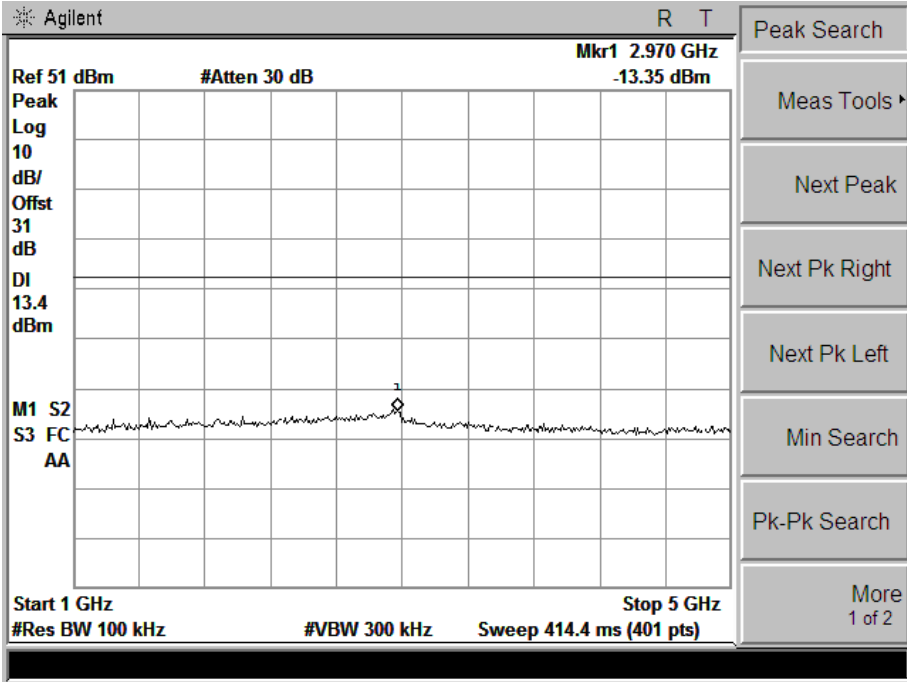
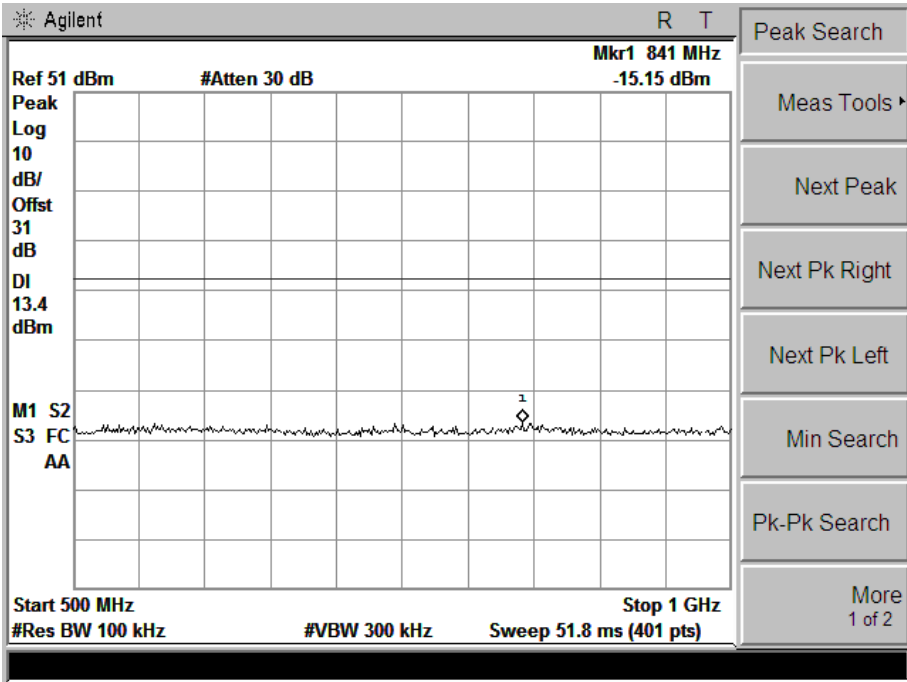

Modulation Type	Channel Separation	Rated Power (Watt)	Test Frequency (MHz)	Maximum Conducted Spurious Emissions Below 1GHz		Maximum Conducted Spurious Emissions Above 1GHz		FCC limit
				Frequency (MHz)	Results (dBm)	Frequency (MHz)	Results (dBm)	
4FSK	12.5KHz	0.5	152.0125	866.00	-16.06	2990.00	-12.6	-20dBc
Test Results			Compliance					

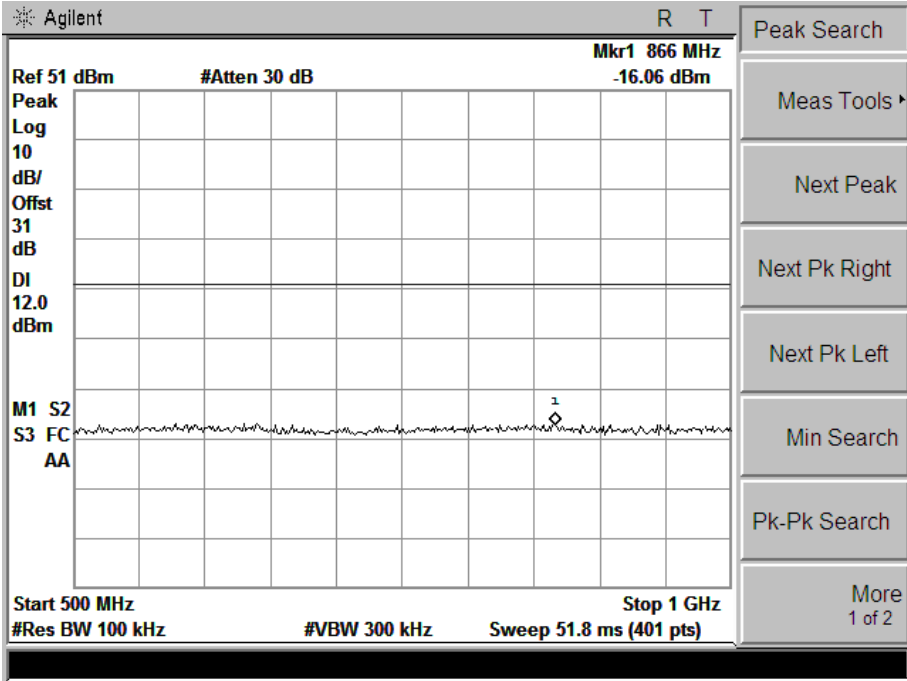
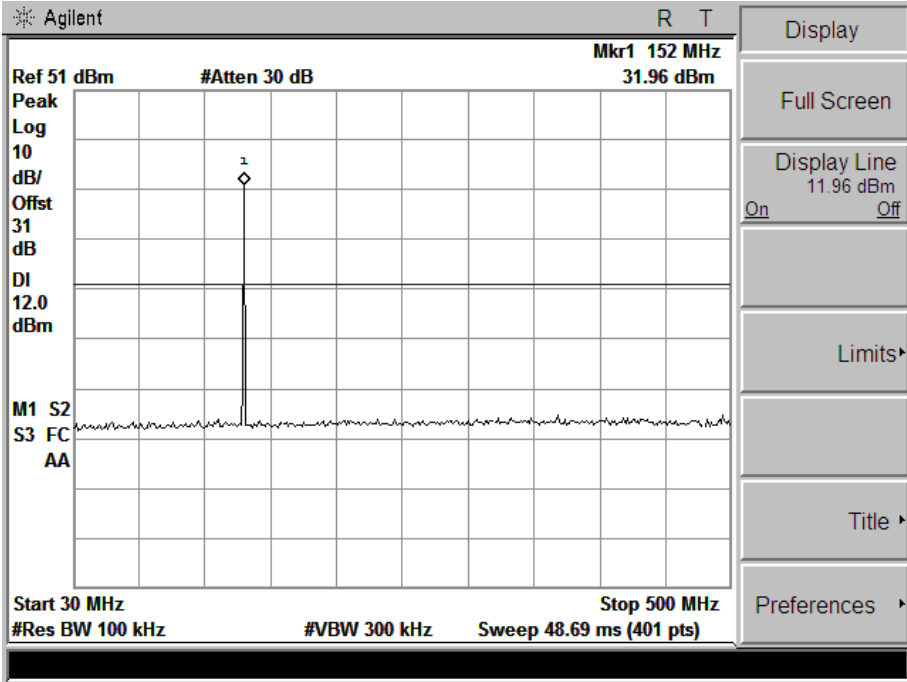

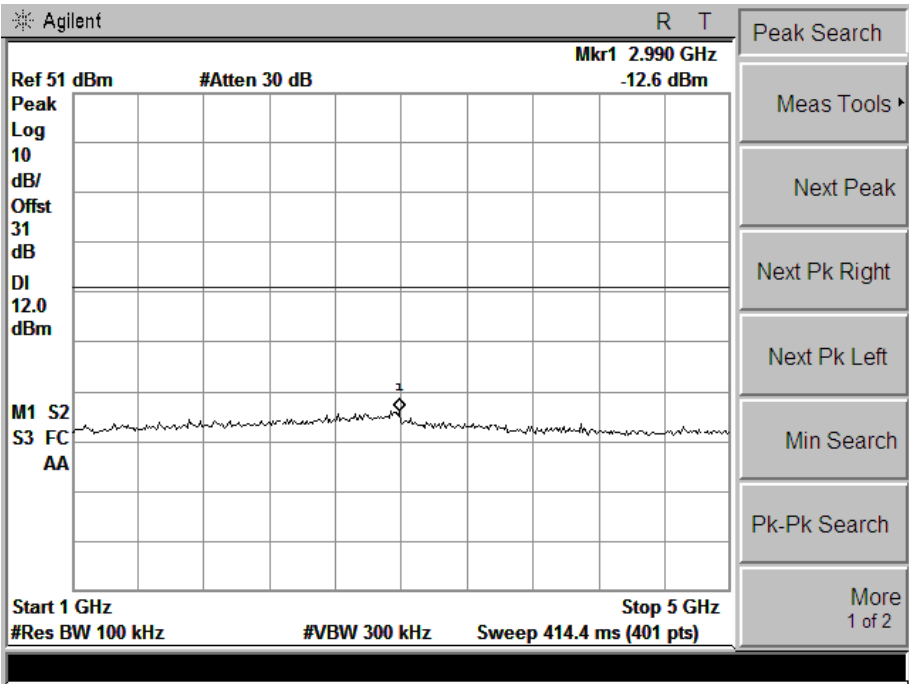

Modulation Type	Channel Separation	Rated Power (Watt)	Test Frequency (MHz)	Maximum Conducted Spurious Emissions Below 1GHz		Maximum Conducted Spurious Emissions Above 1GHz		FCC limit
				Frequency (MHz)	Results (dBm)	Frequency (MHz)	Results (dBm)	
4FSK	12.5KHz	0.5	169.9870	538.00	-15.75	2990.00	-13.53	-20dBc
Test Results			Compliance					

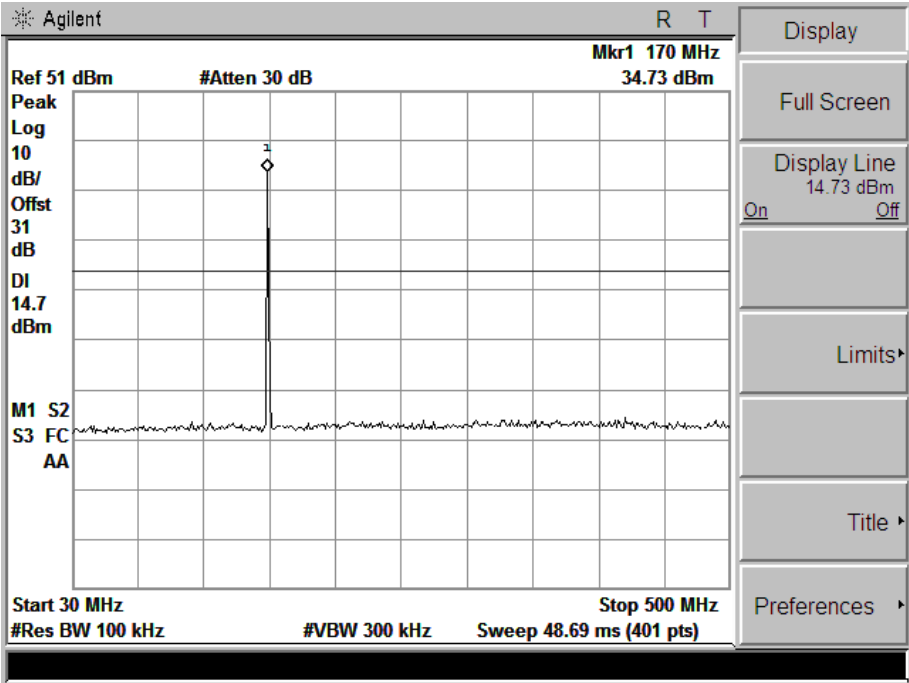

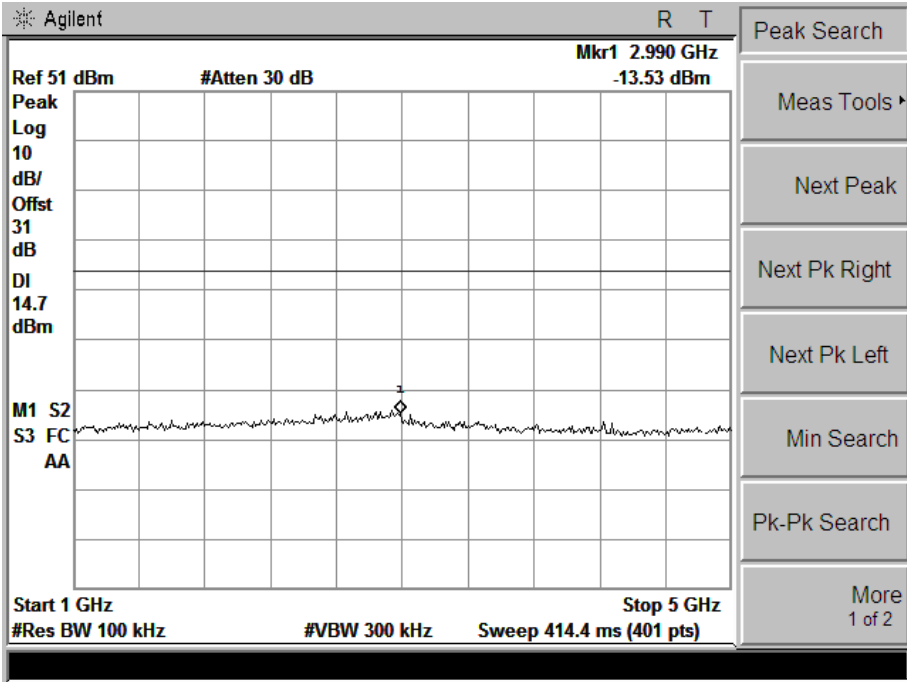
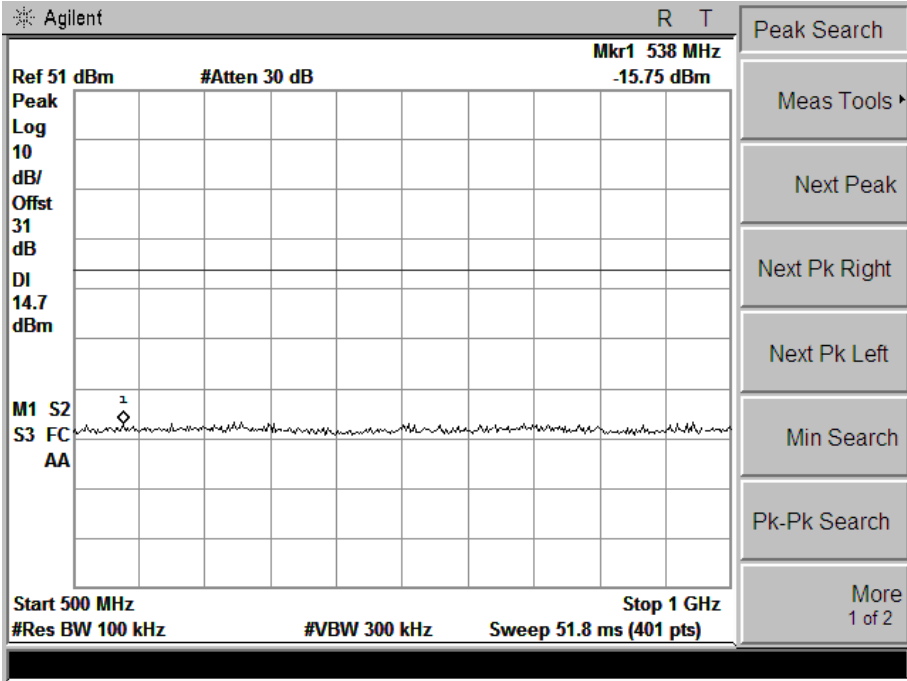

4.5. Modulation Characteristics

TEST APPLICABLE

According to CFR47 section 2.1047(a), for Voice Modulation Communication Equipment, the frequency response of the audio modulation circuit over a range of 100 to 5000Hz shall be measured.

TEST PROCEDURE

Modulation Limit

1 Configure the EUT as shown in figure 1, adjust the audio input for 60% of rated system deviation at 1 KHz using this level as a reference (0dB) and vary the input level from -20 to +20dB. Record the frequency deviation obtained as a function of the input level.

2 Repeat step 1 with input frequency changing to 300, 1004, 1500 and 2500Hz in sequence.

Audio Frequency Response

1 Configure the EUT as shown in figure 1.

2 Adjust the audio input for 20% of rated system deviation at 1 KHz using this level as a reference (0dB).

3 Vary the Audio frequency from 100 Hz to 3 KHz and record the frequency deviation.

4 Audio Frequency Response = $20\log_{10}$ (Deviation of test frequency/Deviation of 1 KHz reference).

TEST CONFIGURATION

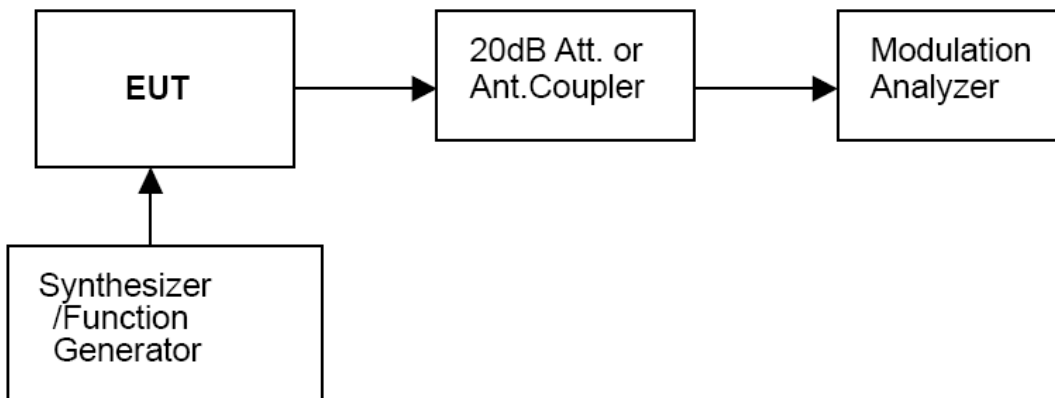

TEST RESULTS

It is not applicable for devices which operate with the digitized voice/data modulation type.

4.6. Frequency Stability Measurement

TEST APPLICABLE

1 According to FCC Part 2 Section 2.1055 (a)(1), the frequency stability shall be measured with variation of ambient temperature from -30°C to +50°C centigrade.

2 According to FCC Part 2 Section 2.1055 (a) (2), for battery powered equipment, the frequency stability shall be measured with reducing primary supply voltage to the battery operating end point, which is specified by the manufacture.

3 Vary primary supply voltage from 85 to 115 percent of the nominal value for other than hand carried battery equipment and tested end point voltage.

4 According to §90.213, the frequency stability limit is 2.5 ppm for 12.5 KHz channel separation and 1.0 ppm for 6.25KHz channel separation.

TEST PROCEDURE

The EUT was set in the climate chamber and connected to an external DC power supply. The RF output was directly connected to Spectrum Analyzer ESCI. The coupling loss of the additional cables was recorded and taken in account for all the measurements. After temperature stabilization (approx. 20 min for each stage), the frequency for the lower, the middle and the highest frequency range was recorded. For Frequency stability Vs. Voltage the EUT was connected to a DC power supply and the voltage was adjusted in the required ranges. The result was recorded.

TEST SETUP BLOCK DIAGRAM

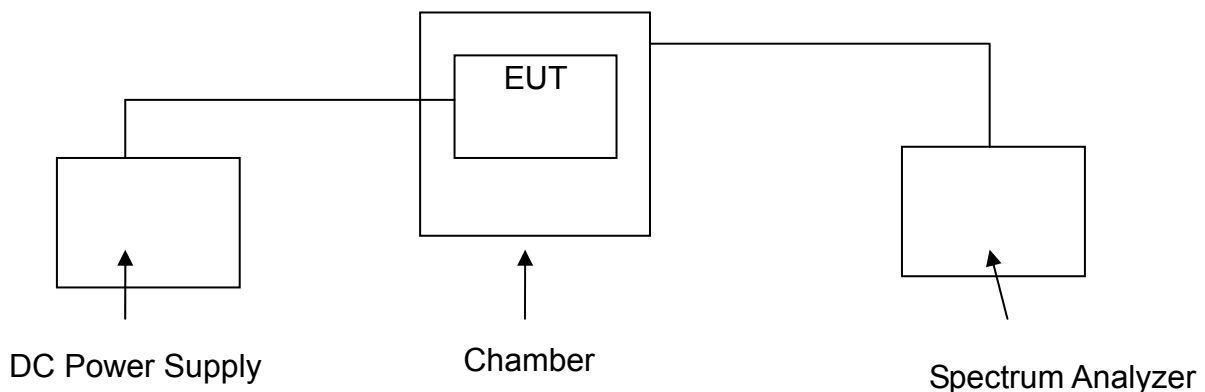

TEST LIMITS

According to 90.213, Transmitters used must have minimum frequency stability as specified in the following table.

Frequency range (MHz)	Fixed and base stations	Mobile stations	
		Over 2 watts output power	2 watts or less output power
Below 25	^{1,2,3} 100	100	200
25-50	20	20	50
72-76	5	-----	50
150-174	^{6,11} 5	⁶ 5	^{4,6} 50
216-220	1.0	-----	1.0
220-222 ¹²	0.1	1.5	1.5
421-512	^{7,11,14} 2.5	⁸ 5	⁸ 5
806-809	¹⁴ 1.0	1.5	1.5
809-824	¹⁴ 1.5	2.5	2.5
851-854	1.0	1.5	1.5
854-869	1.5	2.5	2.5
896-901	¹⁴ 0.1	1.5	1.5
902-928	2.5	2.5	2.5
902-928 ¹³	2.5	2.5	2.5
929-930	1.5	-----	-----
935-940	0.1	1.5	1.5
1427-1435	⁹ 300	300	300
Above 2450 ¹⁰	-----	-----	-----

Modulation Type	Channel separation	Test conditions		Frequency error (ppm)		
		Voltage(V)	Temp(°C)	136.0125 (MHz)	155.0125 (MHz)	173.9875 (MHz)
Digital/4FSK	12.5KHz	7.40	-30	-0.6	-0.62	-0.61
			-20	-0.50	-0.63	-0.58
			10	-0.54	-0.55	-0.54
			0	-0.49	-0.51	-0.44
			10	-0.42	-0.43	-0.39
			20	-0.23	-0.16	-0.17
			30	-0.33	-0.34	-0.34
			40	-0.44	-0.42	-0.41
			50	-0.60	-0.49	-0.48
		6.25 (End Point)	25	-0.58	-0.67	-0.67
		6.29 (85% Rated)	20	-0.33	-0.36	-0.28
		8.51 (115% Rated)	20	-0.29	-0.24	-0.23
Limit				1.00	1.00	1.00
Conclusion			Complies			

4.7. Conducted Output Power

TEST APPLICABLE

Per FCC § 2.1046 and § 90.205: Maximum ERP is dependent upon the station’s antenna HAAT and required service area.

Typical transmitter output powers are 110 watts for base and/or fixed stations (paging transmitters excepted), and 30 watts for mobile stations. Higher powers may be certified, but it should be noted that mobile stations are normally only licensed up to 30 watts. See the SRSP relevant to the operating frequency for equipment power limits.

TEST PROCEDURE

Measurements shall be made to establish the radio frequency power delivered by the transmitter the standard output termination. The power output shall be monitored and recorded and no adjustment shall be made to the transmitter after the test has begun, except as noted below:

If the power output is adjustable, measurements shall be made for the highest and lowest power levels.

The EUT connect to the Receiver through 40 dB attenuator.

Measurement with Spectrum Analyzer FSP40 or Aglient E4407B conducted, external power supply with 12.50 V stabilized supply voltage.

TEST CONFIGURATION

				Spectrum Analyzer/Receiver
EUT		Attenuator		

The EUT was directly connected to a RF Communication
 Test set by a 20 dB attenuator

TEST RESULTS

Plots of Maximum Transmitter Power Measurement

Modulation	Channel Separation	Freq.(MHz)	Rated Power (Watt)	Measurement (dBm)	FCC Limit	Type Results
4FSK	12.5 KHz	137.0125	5	36.87	Varies	Compliance

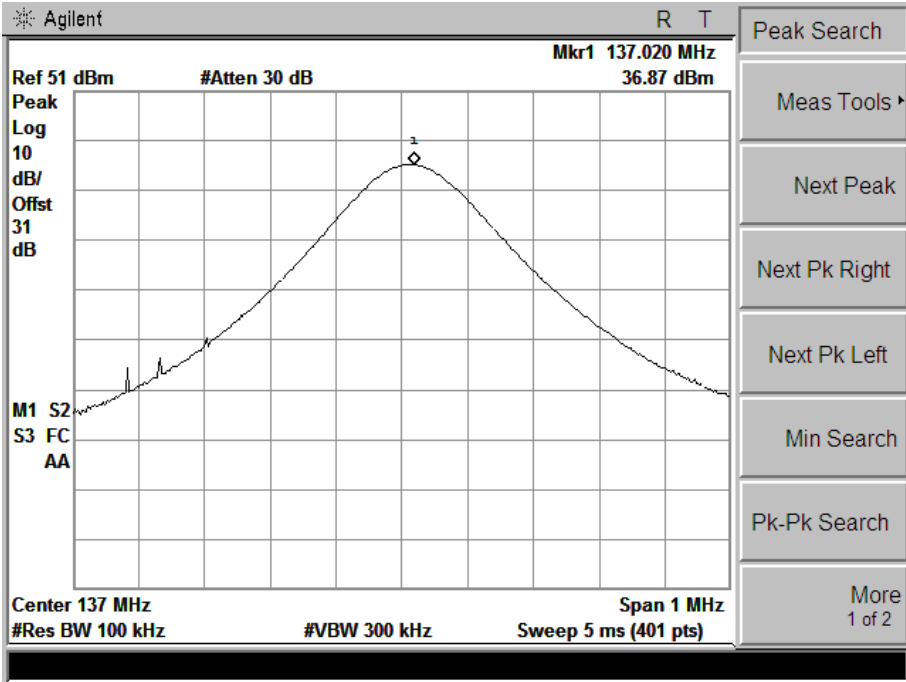

Modulation	Channel Separation	Freq.(MHz)	Rated Power (Watt)	Measurement (dBm)	FCC Limit	Type Results
4FSK	12.5 KHz	152.0125	5	36.91	Varies	Compliance

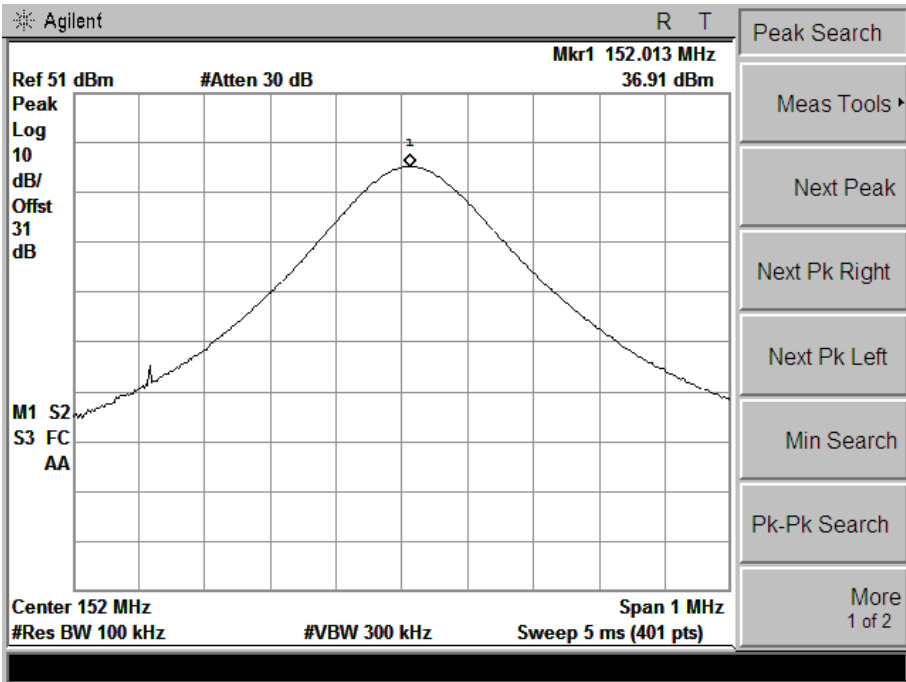

Modulation	Channel Separation	Freq.(MHz)	Rated Power (Watt)	Measurement (dBm)	FCC Limit	Type Results
4FSK	12.5 KHz	169.9870	5	36.93	Varies	Compliance

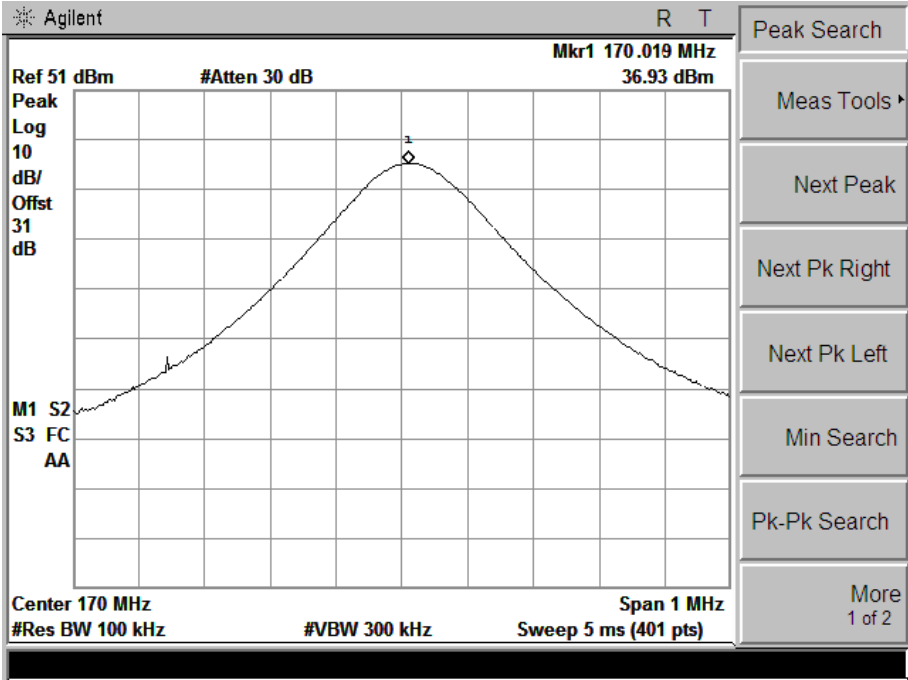

Modulation	Channel Separation	Freq.(MHz)	Rated Power (Watt)	Measurement (dBm)	FCC Limit	Type Results
4FSK	12.5 KHz	137.0125	0.5	26.86	Varies	Compliance

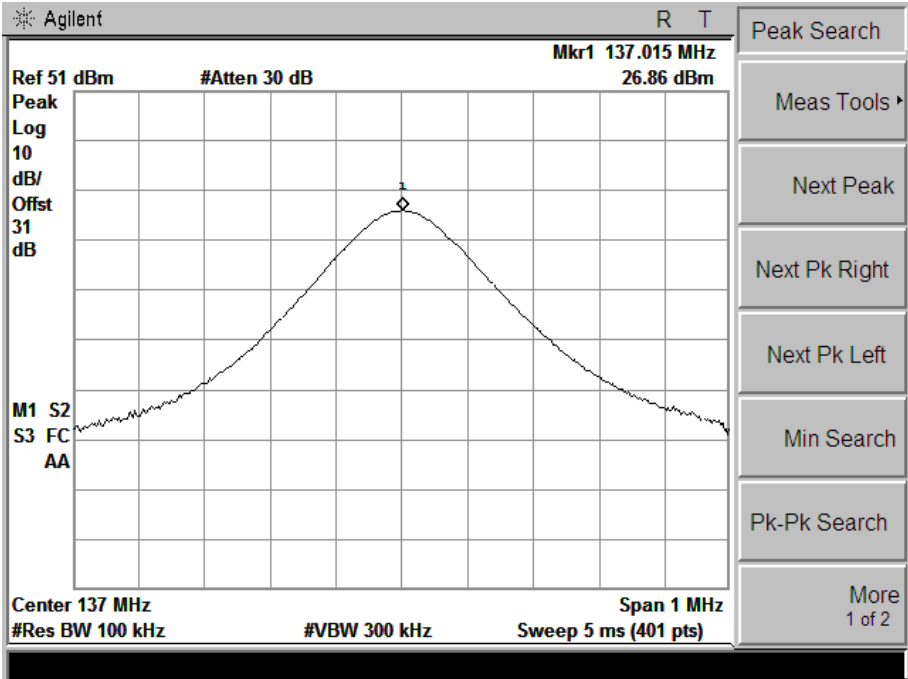

Modulation	Channel Separation	Freq.(MHz)	Rated Power (Watt)	Measurement (dBm)	FCC Limit	Type Results
4FSK	12.5 KHz	152.0125	0.5	26.87	Varies	Compliance

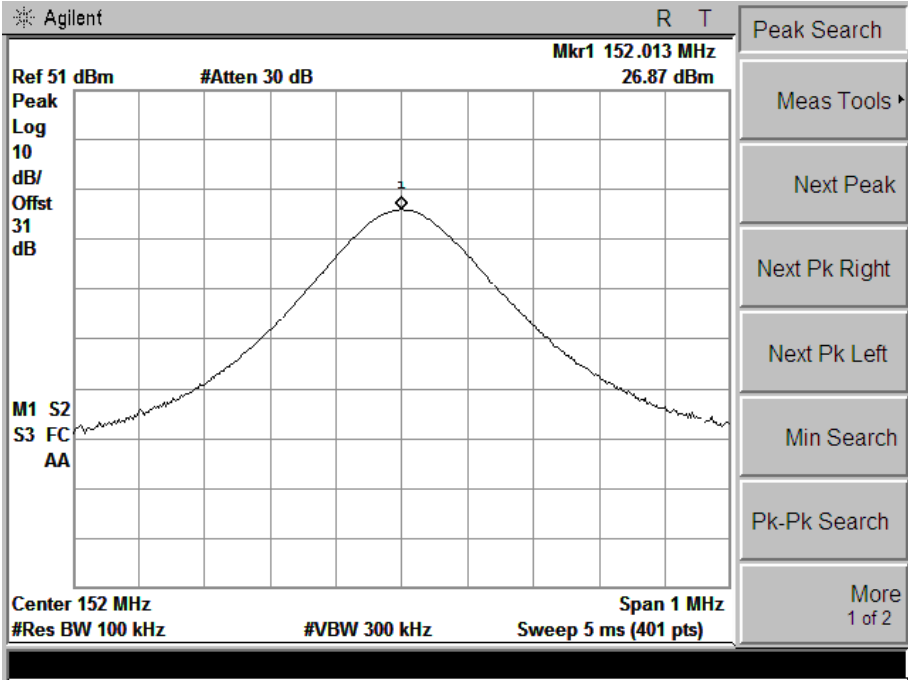

Modulation	Channel Separation	Freq.(MHz)	Rated Power (Watt)	Measurement (dBm)	FCC Limit	Type Results
4FSK	12.5 KHz	169.9870	0.5	26.88	Varies	Compliance

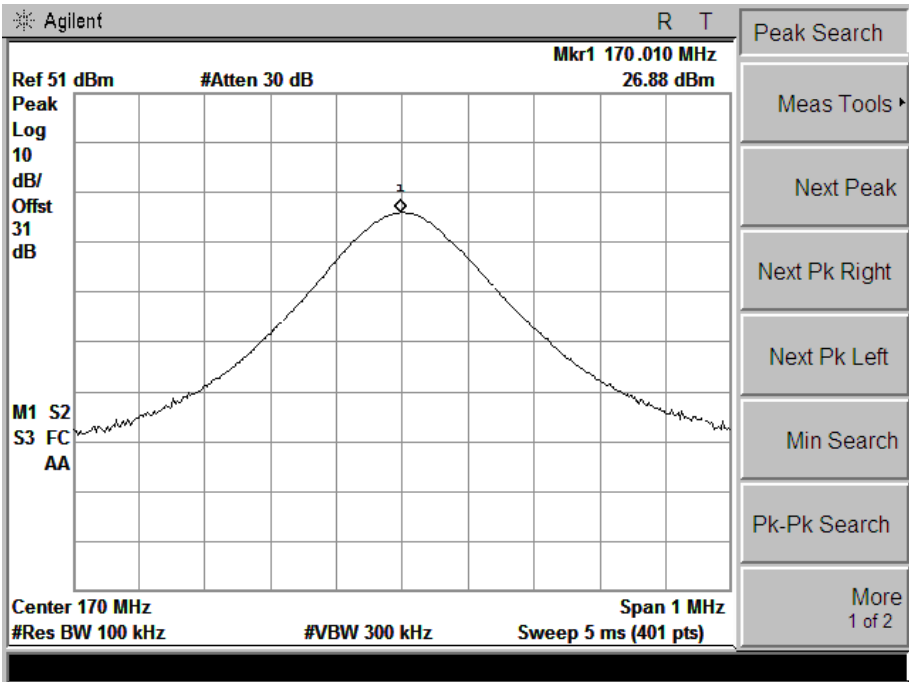

4.8. Transient frequency behavior

TEST APPLICABLE

Section 90.214

Transient frequencies must be within the maximum frequency difference limits during the time intervals indicated:

Time intervals ^{1, 2}	Maximum frequency difference ³	All equipment	
		150 to 174 MHz	421 to 512MHz
Transient Frequency Behavior for Equipment Designed to Operate on 25 KHz Channels			
t ₁ ⁴	± 25.0 KHz	5.0 ms	10.0 ms
t ₂	± 12.5 KHz	20.0 ms	25.0 ms
t ₃ ⁴	± 25.0 KHz	5.0 ms	10.0 ms
Transient Frequency Behavior for Equipment Designed to Operate on 12.5 KHz Channels			
t ₁ ⁴	± 12.5 KHz	5.0 ms	10.0 ms
t ₂	± 6.25 KHz	20.0 ms	25.0 ms
t ₃ ⁴	± 12.5 KHz	5.0 ms	10.0 ms
Transient Frequency Behavior for Equipment Designed to Operate on 6.25 KHz Channels			
t ₁ ⁴	±6.25 KHz	5.0 ms	10.0 ms
t ₂	±3.125 KHz	20.0 ms	25.0 ms
t ₃ ⁴	±6.25 KHz	5.0 ms	10.0 ms

- t_{on} is the instant when a 1 KHz test signal is completely suppressed, including any capture time due to phasing.
 t₁ is the time period immediately following t_{on}.
 t₂ is the time period immediately following t₁.
 t₃ is the time period from the instant when the transmitter is turned off until t_{off}.
 t_{off} is the instant when the 1 KHz test signal starts to rise.
- During the time from the end of t₂ to the beginning of t₃, the frequency difference must not exceed the limits specified in § 90.213.
- Difference between the actual transmitter frequency and the assigned transmitter frequency.
- If the transmitter carrier output power rating is 6 watts or less, the frequency difference during this time period may exceed the maximum frequency difference for this time period.

TEST PROCEDURE

TIA/EIA-603 2.2.19

TEST CONFIGURATION

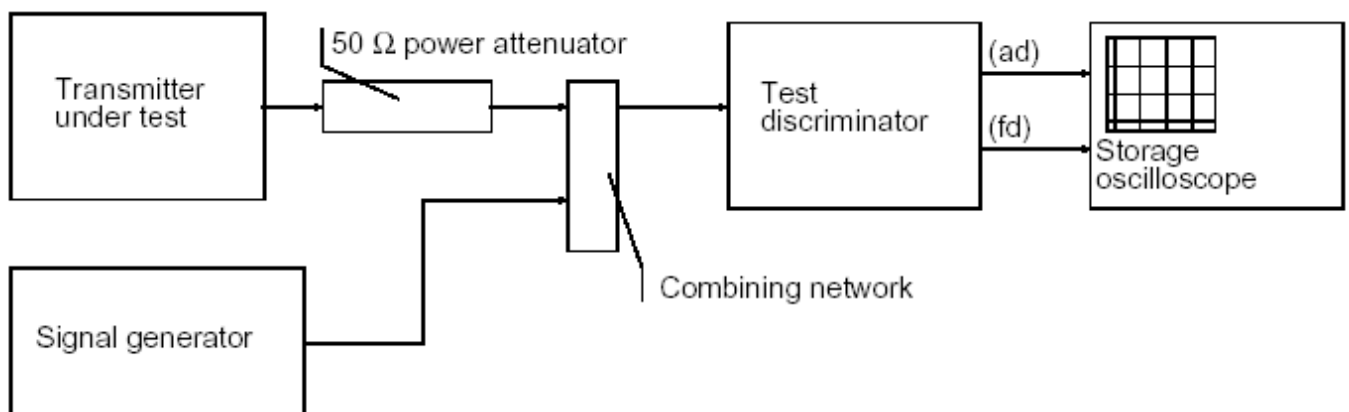

TEST RESULTS

Modulation Type: 4FSK

Transient frequency behavior @ 12.5 KHz Channel Separation-----Off – On

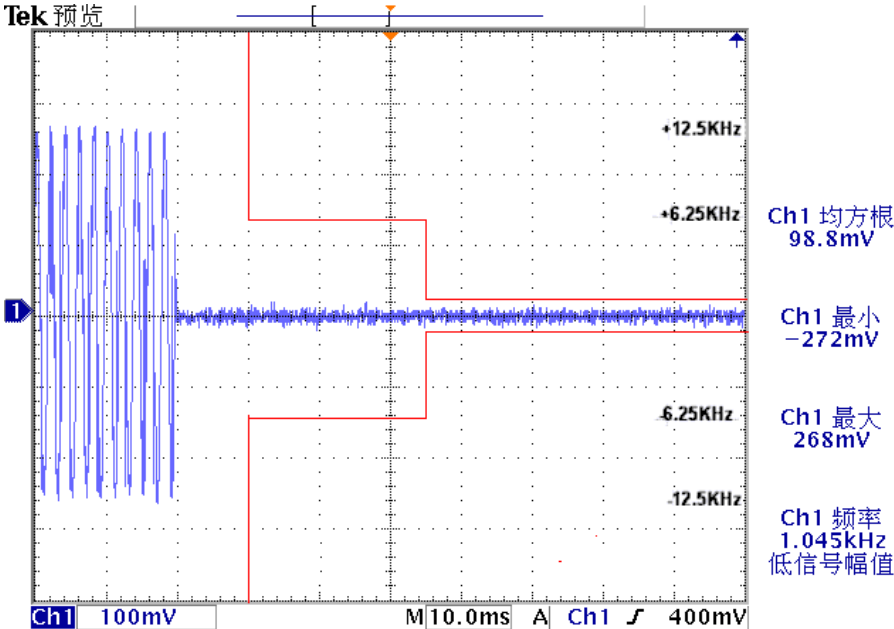

Transient frequency behavior @ 12.5KHz Channel Separation-----Off – On

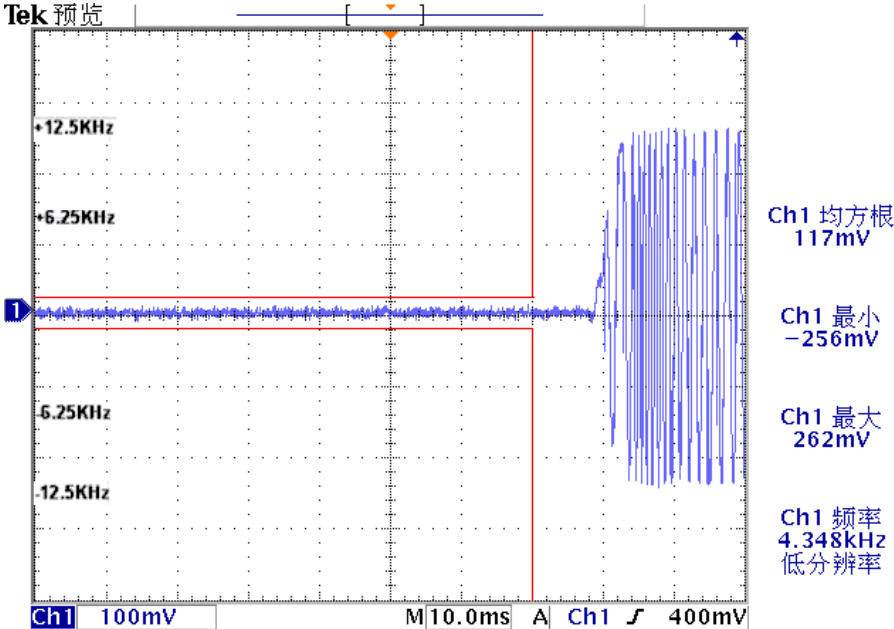

5 Test Setup Photos of the EUT

Radiated emission test

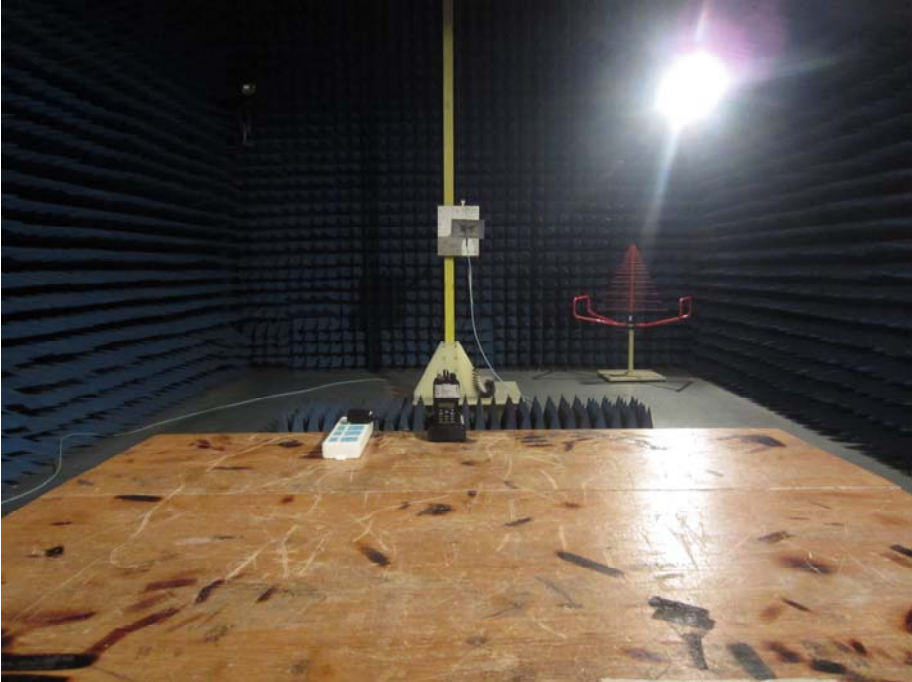

Conducted emission test



RF test



End of the report