



RADIO TESTREPORT

Report No: STS1705176F01

Issued for

FrSky Electronic Co., Ltd

F-4, Building C, Zhongxiu Technology Park, No.3 Yuanxi Road, Wuxi, 214125, Jiangsu, China

Product Name:	2.4G radio system
Brand Name:	N/A
Model Name:	W_CAN RF_Moudle
Series Model:	N/A
FCC ID:	XYFW2410MT
Test Standard:	FCC Part 15.247

Any reproduction of this document must be done in full. No single part of this document may be reproduced without permission from BZT, All Test Data Presented in this report is only applicable to presented Test sample.

BZT Testing Technology Co., Ltd

Add. : Buliding 17, Xinghua Road Xingwei industrial Park Fuyong,
Baoan District, Shenzhen, Guangdong, China

TEL: +86-755 3307 1680 FAX: +86-755 27341758 E-mail:bruce@bzt.Cn



TEST RESULT CERTIFICATION

Applicant's name.....: FrSky Electronic Co., Ltd
Address.....: F-4, Building C, Zhongxiu Technology Park, No.3 Yuanxi Road, Wuxi, 214125, Jiangsu, China
Manufacture's Name: FrSky Electronic Co., Ltd
Address.....: F-4, Building C, Zhongxiu Technology Park, No.3 Yuanxi Road, Wuxi, 214125, Jiangsu, China

Product description

Product name.....: 2.4G radio system
Brand name.....: N/A
Model and/or type reference .: W_CAN RF_Moudle
Series Model: N/A
Standards: FCC Part15.247
Test procedure: ANSI C63.10-2013

This device described above has been tested by BZT, the test results show that the equipment under test (EUT) is in compliance with the FCC requirements. And it is applicable only to the tested sample identified in the report.
This report shall not be reproduced except in full, without the written approval of BZT, this document may be altered or revised by BZT, personal only, and shall be noted in the revision of the document.

Date of Test.....:
Date (s) of performance of tests : 22 May. 2017 ~19 June. 2017
Date of Issue: 20 June. 2017
Test Result: Pass

Testing Engineer : Sean She
(Sean she)

Technical Manager : Hakim.hou
(Hakim.hou)

Authorized Signatory : Vita Li
(Vita Li)





Table of Contents	Page
1. SUMMARY OF TEST RESULTS	6
1.1 TEST FACTORY	7
1.2 MEASUREMENT UNCERTAINTY	7
2. GENERAL INFORMATION	8
2.1 GENERAL DESCRIPTION OF EUT	8
2.2 DESCRIPTION OF TEST MODES	10
2.3 BLOCK DIGRAM SHOWING THE CONFIGURATION OF SYSTEM TESTED	11
2.4 DESCRIPTION OF SUPPORT UNITS	12
2.5 EQUIPMENTS LIST FOR ALL TEST ITEMS	13
3. EMC EMISSION TEST	14
3.1 CONDUCTED EMISSION MEASUREMENT	14
3.2 RADIATED EMISSION MEASUREMENT	20
4. CONDUCTED SPURIOUS & BAND EDGE EMISSION	36
4.1 REQUIREMENT	36
4.2 TEST PROCEDURE	36
4.3 TEST SETUP	36
4.4 EUT OPERATION CONDITIONS	36
4.5 TEST RESULTS	36
5. NUMBER OF HOPPING CHANNEL	45
5.1 APPLIED PROCEDURES / LIMIT	45
5.2 TEST PROCEDURE	45
5.3 TEST SETUP	45
5.4 EUT OPERATION CONDITIONS	45
5.5 TEST RESULTS	46
6. AVERAGE TIME OF OCCUPANCY	48
6.1 APPLIED PROCEDURES / LIMIT	48
6.2 TEST PROCEDURE	48
6.3 TEST SETUP	48
6.4 EUT OPERATION CONDITIONS	48
6.5 TEST RESULTS	49
7. HOPPING CHANNEL SEPARATION MEASUREMEN	53
7.1 APPLIED PROCEDURES / LIMIT	53
7.2 TEST PROCEDURE	53



Table of Contents	Page
7.3 TEST SETUP	53
7.4 EUT OPERATION CONDITIONS	53
7.5 TEST RESULTS	54
8. BANDWIDTH TEST	58
8.1 APPLIED PROCEDURES / LIMIT	58
8.2 TEST PROCEDURE	58
8.3 TEST SETUP	58
8.4 EUT OPERATION CONDITIONS	58
8.5 TEST RESULTS	59
8.5 TEST RESULTS	61
9. OUTPUT POWER TEST	63
9.1 APPLIED PROCEDURES / LIMIT	63
9.2 TEST PROCEDURE	63
9.3 TEST SETUP	63
9.4 EUT OPERATION CONDITIONS	63
9.5 TEST RESULTS	64
10. ANTENNA REQUIREMENT	65
10.1 STANDARD REQUIREMENT	65
10.2 EUT ANTENNA	65



Revision History

Rev.	Issue Date	Report NO.	Effect Page	Contents
00	20 June. 2017	STS1705176F01	ALL	Initial Issue





1. SUMMARY OF TEST RESULTS

Test procedures according to the technical standards: DA 00-705

FCC Part 15.247, Subpart C			
Standard Section	Test Item	Judgment	Remark
15.207	Conducted Emission	PASS	--
15.247(a)(1)	Hopping Channel Separation	PASS	--
15.247(a)(1)&(b)(1)	Output Power	PASS	--
15.247(c)	Radiated Spurious Emission	PASS	--
15.247(d)	Conducted Spurious & Band Edge Emission	PASS	--
15.247(a)(iii)	Number of Hopping Frequency	PASS	--
15.247(a)(iii)	Dwell Time	PASS	--
15.247(a)(1)	Bandwidth	PASS	--
15.205	Restricted Band Edge Emission	PASS	--
Part 15.247(d)/part 15.209(a)	Band Edge Emission	PASS	--
15.203	Antenna Requirement	PASS	--

NOTE:

(1) "N/A" denotes test is not applicable in this Test Report

(2) All tests are according to ANSI C63.10-2013



1.1 TEST FACTORY

BZT Testing Technology Co., Ltd.
Add. : Buliding 17, Xinghua Road Xingwei industrial Park Fuyong,
Baoan District, Shenzhen, Guangdong, China
FCC Registration No.: 701733

1.2 MEASUREMENT UNCERTAINTY

The reported uncertainty of measurement $y \pm U$, where expended uncertainty U is based on a standard uncertainty multiplied by a coverage factor of $k=2$, providing a level of confidence of approximately **95 %** .

No.	Item	Uncertainty
1	Conducted Emission (9KHz-150KHz)	$\pm 2.88\text{dB}$
2	Conducted Emission (150KHz-30MHz)	$\pm 2.67\text{dB}$
3	RF power,conducted	$\pm 0.70\text{dB}$
4	Spurious emissions,conducted	$\pm 1.19\text{dB}$
5	All emissions,radiated (9KHz-30MHz)	$\pm 2.45\text{dB}$
6	All emissions,radiated (30MHz-200MHz)	$\pm 2.83\text{dB}$
7	All emissions,radiated (200MHz-1000MHz)	$\pm 2.94\text{dB}$
8	All emissions,radiated(>1G)	$\pm 3.03\text{dB}$
9	Temperature	$\pm 0.5^{\circ}\text{C}$
10	Humidity	$\pm 2\%$



2. GENERAL INFORMATION

2.1 GENERAL DESCRIPTION OF EUT

Equipment	2.4G radio system
Trade Name	N/A
Model Name	W_CAN RF_Moudle
Series Model	N/A
Model Difference	N/A
Channel List	Please refer to the Note 2.
Frequency& Modulation:	Frequency:2405 – 2475 MHz Modulation: GFSK
Ratings	DC 12V
Hardware version number	V 0.7
Software version number	V1.0
Connecting I/O Port(s)	Please refer to the User's Manual

Note:

1. For a more detailed features description, please refer to the manufacturer's specifications or the User's Manual.



2.

Channel	Frequency (MHz)	Channel	Frequency (MHz)
0	2405	15	2447
1	2407	16	2449
2	2409	17	2451
3	2411	18	2453
4	2413	19	2455
5	2415	20	2457
6	2417	21	2459
7	2419	22	2461
8	2421	23	2463
9	2423	24	2465
10	2425	25	2467
11	2427	26	2469
12	2429	27	2471
13	2431	28	2473
14	2433	29	2475

3. Table for Filed Antenna

Ant	Brand	Model Name	Antenna Type	Connector	Gain (dBi)	NOTE
1	N/A	W_CAN RF_Moudle	Internal Antenna	N/A	2	BT Antenna

Antenna number: 2

The 2 Antennas can not work simultaneously



2.2 DESCRIPTION OF TEST MODES

To investigate the maximum EMI emission characteristics generates from EUT, the test system was pre-scanning tested base on the consideration of following EUT operation mode or test configuration mode which possible have effect on EMI emission level. Each of these EUT operation mode(s) or test configuration mode(s) mentioned above was evaluated respectively.

Worst Mode	Description	Data Rate/Modulation
Mode 1	ANT I TX CH00	1Mbps/GFSK
Mode 2	ANT I TX CH15	1Mbps/GFSK
Mode 3	ANT I TX CH29	1Mbps/GFSK
Mode 4	ANT II TX CH00	1Mbps/GFSK
Mode 5	ANT II TX CH15	1Mbps/GFSK
Mode 6	ANT II TX CH29	1Mbps/GFSK

Note:

- (1) The measurements are performed at all Bit Rate of Transmitter, the worst data was reported
- (2) We have be tested for all avaiable U.S. voltage and frequencies(For 120V 60Hz) for which the device is capable of operation.
- (3) ANT I and ANT II have the same frequencies, but can not transmit at the same time.

For AC Conducted Emission

Test Case	
AC Conducted Emission	Mode 7 : ANT I Keeping TX
AC Conducted Emission	Mode 8 : ANT II Keeping TX



2.3 BLOCK DIGRAM SHOWING THE CONFIGURATION OF SYSTEM TESTED

During testing channel & power controlling software provided by the customer was used to control the operating channel as well as the output power level. The RF output power selection is for the setting of RF output power expected by the customer and is going to be fixed on the firmware of the final end product power parameters of FHSS

Radiated Spurious EmissionTest

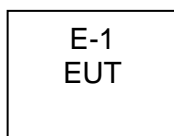

Conducted Emission Test

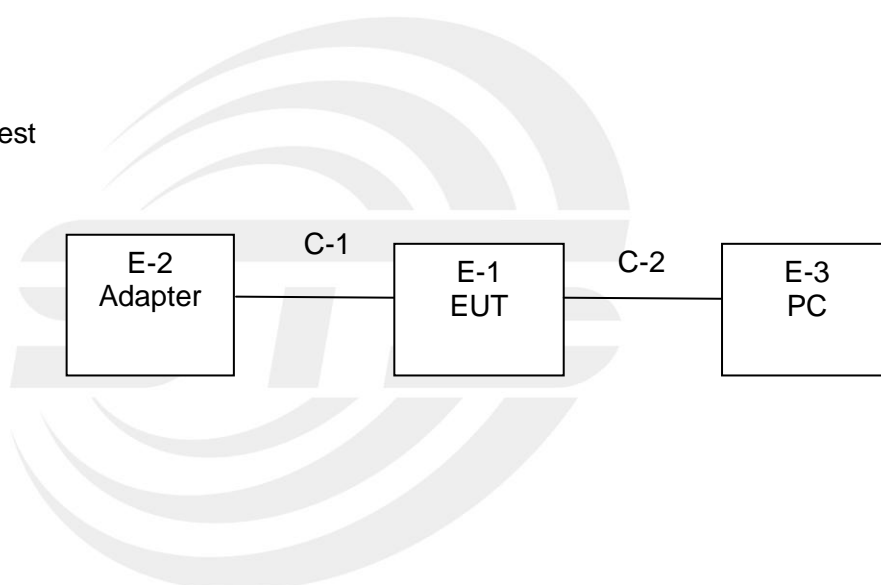



2.4 DESCRIPTION OF SUPPORT UNITS

The EUT has been tested as an independent unit together with other necessary accessories or support units. The following support units or accessories were used to form a representative test configuration during the tests.

Item	Equipment	Mfr/Brand	Model/Type No.	Serial No.	Note
E-1	2.4G radio system	N/A	W_CAN RF_Moudle	N/A	EUT
E-2	Adapter	N/A	PA-1650-86	N/A	N/A
E-3	PC	HP	500-320cx	N/A	N/A

Item	Shielded Type	Ferrite Core	Length	Note
C-1	Cable shielded line (Charging)	NO	100cm	N/A
C-2	USB connecting line	NO	90cm	N/A

Note:

- (1) The support equipment was authorized by Declaration of Confirmation.
- (2) For detachable type I/O cable should be specified the length in cm in 『Length』 column.
- (3) “YES” is means “shielded” “with core”; “NO” is means “unshielded” “without core”.



2.5 EQUIPMENTS LIST FOR ALL TEST ITEMS

Radiation Test equipment

Kind of Equipment	Manufacturer	Type No.	Serial No.	Last calibration	Calibrated until
Spectrum Analyzer	Agilent	E4407B	MY50140340	2016.10.23	2017.10.22
Test Receiver	R&S	ESCI	101427	2016.10.23	2017.10.22
Bilog Antenna	TESEQ	CBL6111D	34678	2014.11.24	2017.11.23
Horn Antenna	Schwarzbeck	BBHA 9120D(1201)	9120D-1343	2015.03.05	2018.03.04
Horn Antenna	Schwarzbeck	BBHA 9170	9170-0741	2016.03.06	2019.03.05
50Ω Coaxial Switch	Anritsu	MP59B	6200264416	2016.10.23	2017.10.22
PreAmplifier	Agilent	8449B	60538	2016.10.23	2017.10.22
Loop Antenna	EMCO	6502	9003-2485	2016.03.06	2019.03.05
Preamplifier	Agilent	8449B	60538	2016.10.23	2017.10.22
Low frequency cable	EM	R01	N/A	NCR	NCR
High frequency cable	SCHWARZBECK	AK9515H	SN-96286/96287	NCR	NCR
Semi-anechoic chamber	Changling	966	N/A	2016.10.23	2017.10.22

Conduction Test equipment

Kind of Equipment	Manufacturer	Type No.	Serial No.	Last calibration	Calibrated until
EMI Test Receiver	R&S	ESPI	102086	2016.10.23	2017.10.22
LISN	R&S	ENV216	101242	2016.10.23	2017.10.22
LISN	EMCO	3810/2NM	000-23625	2016.10.23	2017.10.22
Conduction Cable	EM	C01	N/A	NCR	NCR
Shielding Room	Changling	854	N/A	2016.10.23	2017.10.22

RF Connected Test

Kind of Equipment	Manufacturer	Type No.	Serial No.	Last calibration	Calibrated until
USB RF power sensor	DARE	RPR3006W	15I00041SNO03	2016.10.23	2017.10.22
Spectrum Analyzer	Agilent	E4407B	MY50140340	2016.10.23	2017.10.22
Signal Analyzer	Agilent	N9020A	MY49100060	2016.10.23	2017.10.22

Note: The temporary antenna connector is soldered on the PCB board in order to perform conducted tests and this temporary antenna connector is listed in the equipment list.



3. EMC EMISSION TEST

3.1 CONDUCTED EMISSION MEASUREMENT

3.1.1 POWER LINE CONDUCTED EMISSION LIMITS

Operating frequency band. In case the emission fall within the restricted band specified on Part 207(a) limit in the table below has to be followed.

FREQUENCY (MHz)	Conducted Emission limit (dBuV)	
	Quasi-peak	Average
0.15 -0.5	66 - 56 *	56 - 46 *
0.50 -5.0	56.00	46.00
5.0 -30.0	60.00	50.00

Note:

- (1) The tighter limit applies at the band edges.
- (2) The limit of " * " marked band means the limitation decreases linearly with the logarithm of the frequency in the range.

The following table is the setting of the receiver

Receiver Parameters	Setting
Attenuation	10 dB
Start Frequency	0.15 MHz
Stop Frequency	30 MHz
IF Bandwidth	9 kHz

3.1.2 TEST PROCEDURE

- a. The EUT was 0.8 meters from the horizontal ground plane and 0.4 meters from the vertical ground plane with EUT being connected to the power mains through a line impedance stabilization network (LISN). All other support equipments powered from additional LISN(s). The LISN provide 50 Ohm/ 50uH of coupling impedance for the measuring instrument.
- b. Interconnecting cables that hang closer than 40 cm to the ground plane shall be folded back and forth in the center forming a bundle 30 to 40 cm long.
- c. I/O cables that are not connected to a peripheral shall be bundled in the center. The end of the cable may be terminated, if required, using the correct terminating impedance. The overall length shall not exceed 1 m.
- d. LISN at least 80 cm from nearest part of EUT chassis.
- e. For the actual test configuration, please refer to the related Item –EUT Test Photos.

3.1.3 TEST SETUP

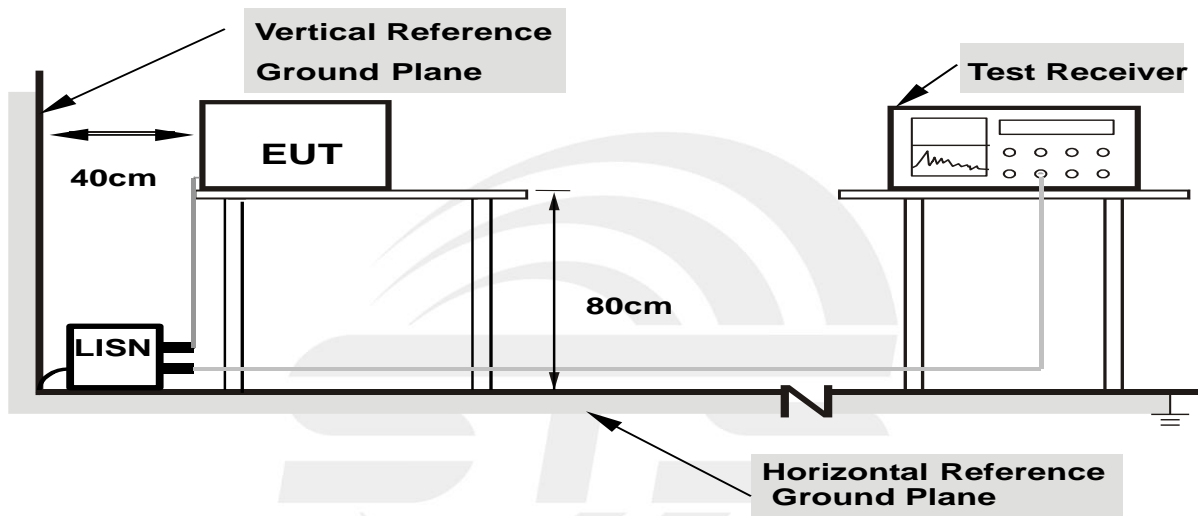

**Note: 1.Support units were connected to second LISN.
 2.Both of LISNs (AMN) are 80 cm from EUT and at least 80 from other units and other metal planes**

3.1.4 EUT OPERATING CONDITIONS

The EUT was configured for testing in a typical fashion (as a customer would normally use it). The EUT has been programmed to continuously transmit during test. This operating condition was tested and used to collect the included data.



3.1.5 TEST RESULT

ANT I			
Temperature:	23.1 °C	Relative Humidity:	61%
Pressure:	1010hPa	Phase:	L
Test Voltage:	AC 120V/60Hz	Test Mode:	Mode 7

Frequency (MHz)	Reading (dBuV)	Correct Factor(dB)	Result (dBuV)	Limit (dBuV)	Margin (dB)	Remark
0.1820	41.94	9.23	51.17	64.39	-13.22	QP
0.1820	24.56	9.23	33.79	54.39	-20.60	AVG
0.4940	40.20	9.16	49.36	56.10	-6.74	QP
0.4940	24.64	9.16	33.80	46.10	-12.30	AVG
0.6860	42.32	9.23	51.55	56.00	-4.45	QP
0.6860	22.38	9.23	31.61	46.00	-14.39	AVG
0.9460	43.74	9.17	52.91	56.00	-3.09	QP
0.9460	19.73	9.17	28.90	46.00	-17.10	AVG
2.0180	40.58	9.26	49.84	56.00	-6.16	QP
2.0180	21.37	9.26	30.63	46.00	-15.37	AVG
17.4740	35.16	9.70	44.86	60.00	-15.14	QP
17.4740	18.12	9.70	27.82	50.00	-22.18	AVG

Remark:

1. All readings are Quasi-Peak and Average values.
2. Margin = Result (Result =Reading + Factor) –Limit

100.0 dBuV

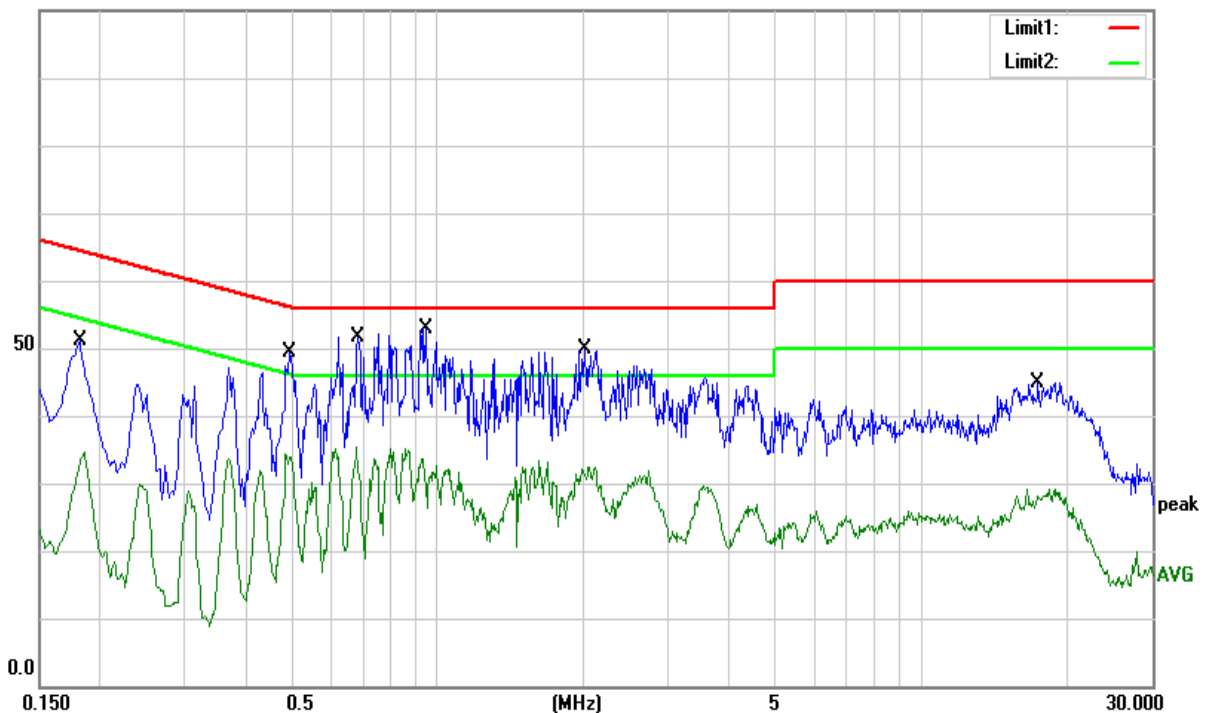



Temperature:	23.1 °C	Relative Humidity:	61%
Pressure:	1010hPa	Phase:	N
Test Voltage:	AC 120V/60Hz	Test Mode:	Mode 7

Frequency (MHz)	Reading (dBuV)	Correct Factor(dB)	Result (dBuV)	Limit (dBuV)	Margin (dB)	Remark
0.1820	40.52	9.23	49.75	64.39	-14.64	QP
0.1820	28.27	9.23	37.50	54.39	-16.89	AVG
0.4940	42.61	9.16	51.77	56.10	-4.33	QP
0.4940	26.60	9.16	35.76	46.10	-10.34	AVG
0.6340	43.16	9.21	52.37	56.00	-3.63	QP
0.6340	22.33	9.21	31.54	46.00	-14.46	AVG
0.9300	41.71	9.17	50.88	56.00	-5.12	QP
0.9300	22.97	9.17	32.14	46.00	-13.86	AVG
3.4220	38.81	9.26	48.07	56.00	-7.93	QP
3.4220	23.33	9.26	32.59	46.00	-13.41	AVG
15.8820	33.66	9.53	43.19	60.00	-16.81	QP
15.8820	17.62	9.53	27.15	50.00	-22.85	AVG

Remark:

1. All readings are Quasi-Peak and Average values.
2. Margin = Result (Result =Reading + Factor)-Limit

100.0 dBuV

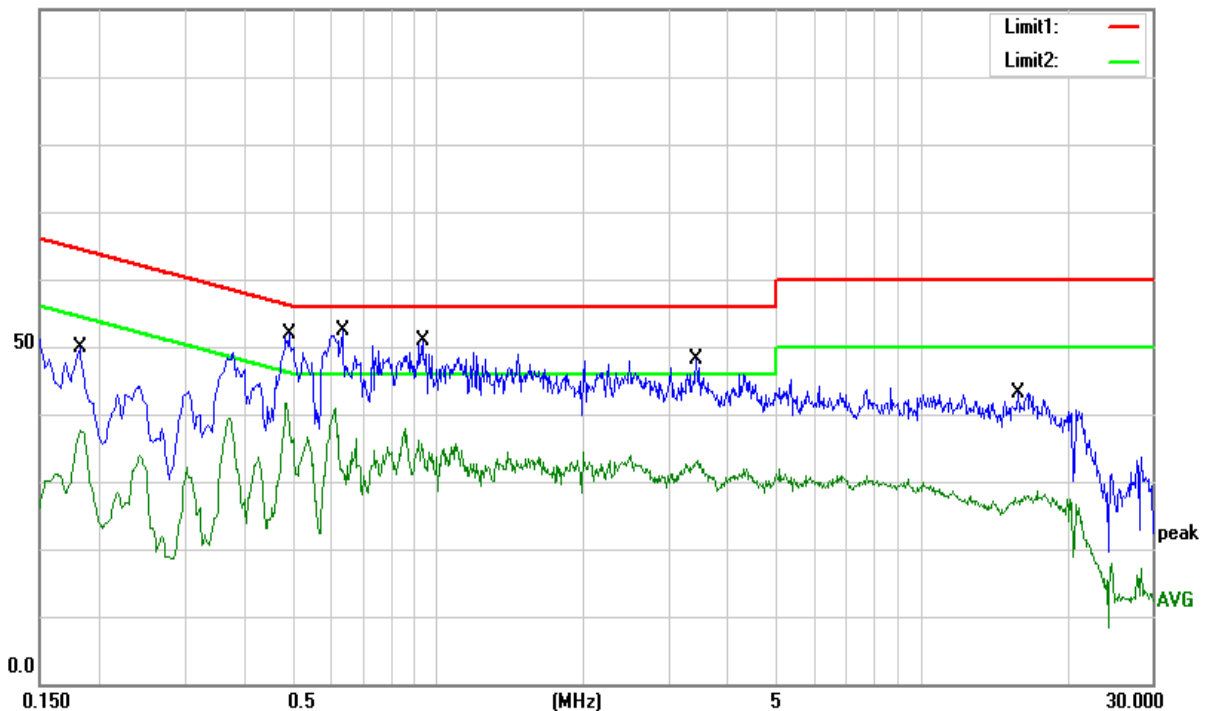



ANT II			
Temperature:	23.1 °C	Relative Humidity:	61%
Pressure:	1010hPa	Phase:	L
Test Voltage:	AC 120V/60Hz	Test Mode:	Mode 8

Frequency (MHz)	Reading (dBuV)	Correct Factor(dB)	Result (dBuV)	Limit (dBuV)	Margin (dB)	Remark
0.1500	51.76	9.75	61.51	66.00	-4.49	QP
0.1500	29.57	9.75	39.32	56.00	-16.68	AVG
0.1900	48.74	9.85	58.59	64.04	-5.45	QP
0.1900	29.52	9.85	39.37	54.04	-14.67	AVG
0.5340	39.50	9.96	49.46	56.00	-6.54	QP
0.5340	22.21	9.96	32.17	46.00	-13.83	AVG
0.8540	39.26	9.83	49.09	56.00	-6.91	QP
0.8540	16.82	9.83	26.65	46.00	-19.35	AVG
1.5780	39.56	9.84	49.40	56.00	-6.60	QP
1.5780	18.62	9.84	28.46	46.00	-17.54	AVG
2.2260	39.11	9.89	49.00	56.00	-7.00	QP
2.2260	16.70	9.89	26.59	46.00	-19.41	AVG

Remark:

1. All readings are Quasi-Peak and Average values.
2. Margin = Result (Result = Reading + Factor) – Limit

100.0 dBuV

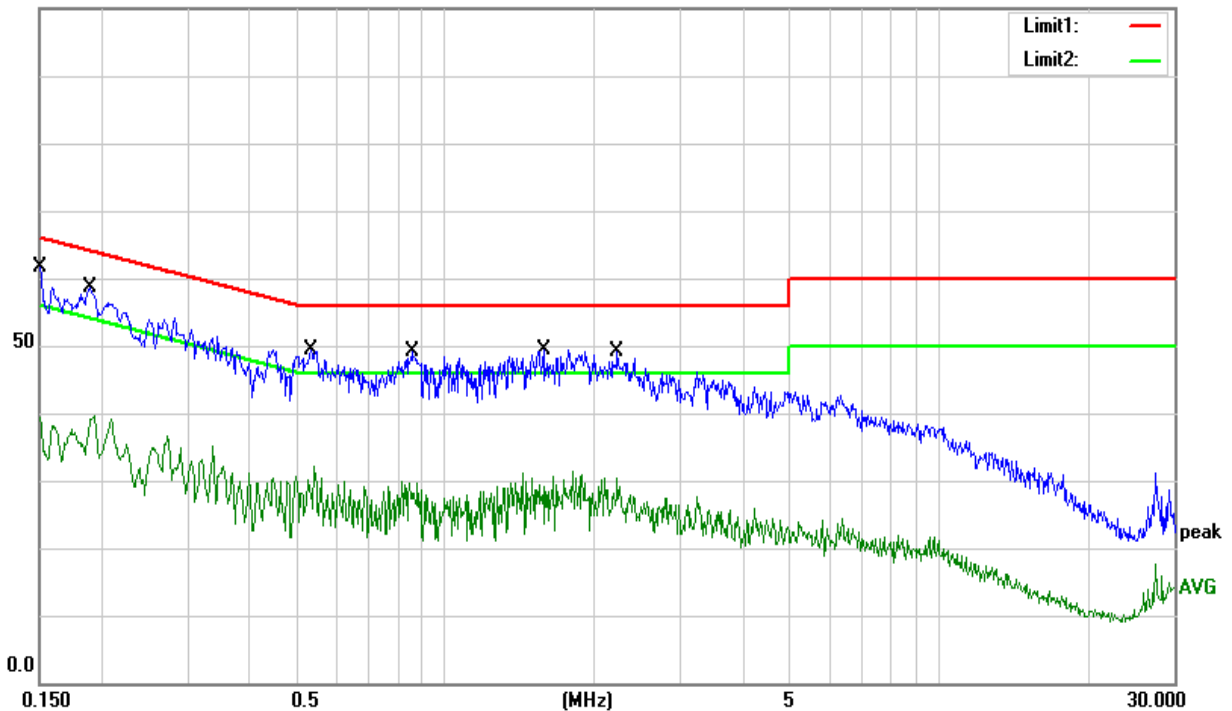



Temperature:	23.1 °C	Relative Humidity:	61%
Pressure:	1010hPa	Phase:	N
Test Voltage:	AC 120V/60Hz	Test Mode:	Mode 8

Frequency (MHz)	Reading (dBuV)	Correct Factor(dB)	Result (dBuV)	Limit (dBuV)	Margin (dB)	Remark
0.1500	51.52	9.75	61.27	66.00	-4.73	QP
0.1500	30.48	9.75	40.23	56.00	-15.77	AVG
0.3140	44.03	10.24	54.27	59.86	-5.59	QP
0.3140	23.71	10.24	33.95	49.86	-15.91	AVG
0.4580	42.49	10.01	52.50	56.73	-4.23	QP
0.4580	21.86	10.01	31.87	46.73	-14.86	AVG
0.8740	40.58	9.83	50.41	56.00	-5.59	QP
0.8740	18.19	9.83	28.02	46.00	-17.98	AVG
1.5060	39.07	9.84	48.91	56.00	-7.09	QP
1.5060	20.08	9.84	29.92	46.00	-16.08	AVG
3.4780	34.11	9.92	44.03	56.00	-11.97	QP
3.4780	13.37	9.92	23.29	46.00	-22.71	AVG

Remark:

1. All readings are Quasi-Peak and Average values.
2. Margin = Result (Result = Reading + Factor) - Limit

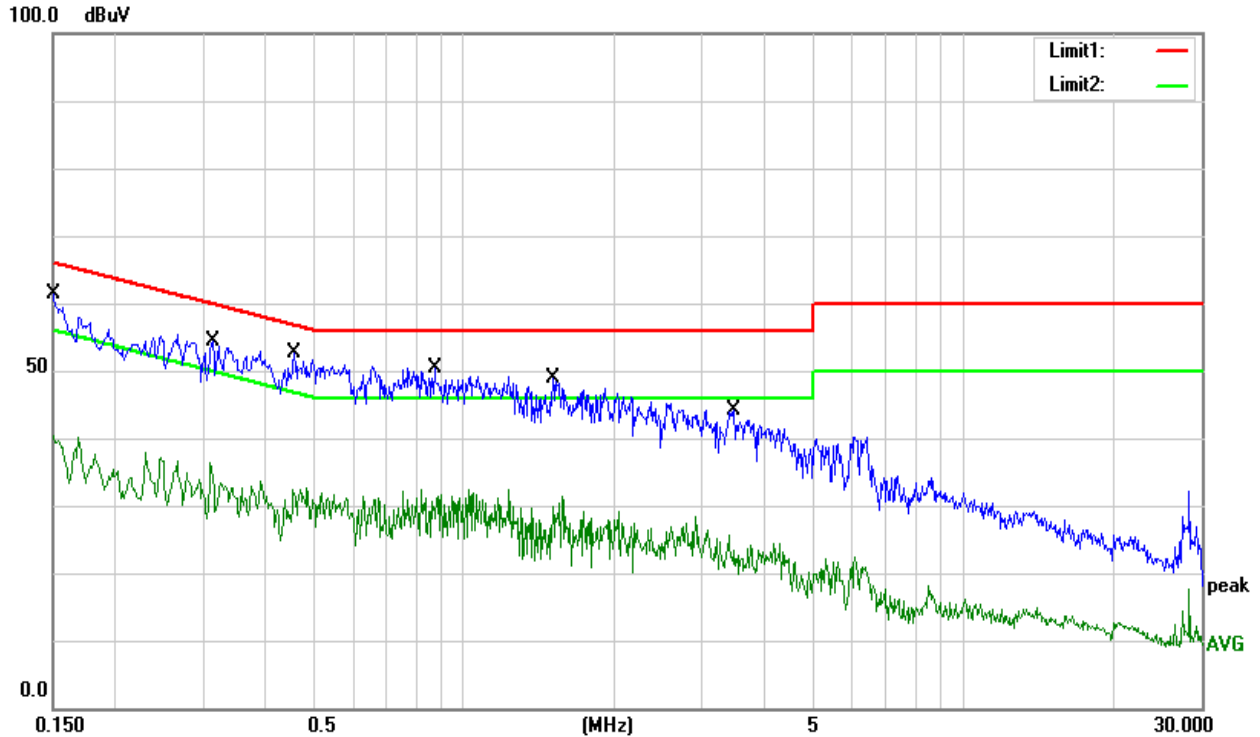



3.2 RADIATED EMISSION MEASUREMENT

3.2.1 RADIATED EMISSION LIMITS

in any 100 kHz bandwidth outside the operating frequency band. In case the emission fall within the Restricted band specified on Part15.205(a)&209(a) limit in the table and according to ANSI C63.10-2013 below has to be followed

LIMITS OF RADIATED EMISSION MEASUREMENT (0.009MHz - 1000MHz)

Frequencies (MHz)	Field Strength (micorvolts/meter)	Measurement Distance (meters)
0.009~0.490	2400/F(KHz)	300
0.490~1.705	24000/F(KHz)	30
1.705~30.0	30	30
30~88	100	3
88~216	150	3
216~960	200	3
Above 960	500	3

LIMITS OF RADIATED EMISSION MEASUREMENT (1GHz-25 GHz)

FREQUENCY (MHz)	(dBuV/m) (at 3M)	
	PEAK	AVERAGE
Above 1000	74	54

Notes:

- (1) The limit for radiated test was performed according to FCC PART 15C.
- (2) The tighter limit applies at the band edges.
- (3) Emission level (dBuV/m)=20log Emission level (uV/m).

For Radiated Emission

Spectrum Parameter	Setting
Attenuation	Auto
Detector	Peak
Start Frequency	1000 MHz(Peak/AV)
Stop Frequency	10th carrier hamonic(Peak/AV)
RB / VB (emission in restricted band)	PK=1MHz / 1MHz, AV=1 MHz / 10 Hz

For Band edge

Spectrum Parameter	Setting
Detector	Peak
Start/Stop Frequency	Lower Band Edge: 2300 to 2407 MHz Upper Band Edge: 2474 to 2500 MHz
RB / VB (emission in restricted band)	PK=1MHz / 1MHz, AV=1 MHz / 10 Hz



Receiver Parameter	Setting
Attenuation	Auto
Start ~ Stop Frequency	9kHz~90kHz / RB 200Hz for PK & AV
Start ~ Stop Frequency	90kHz~110kHz / RB 200Hz for QP
Start ~ Stop Frequency	110kHz~490kHz / RB 200Hz for PK & AV
Start ~ Stop Frequency	490kHz~30MHz / RB 9kHz for QP
Start ~ Stop Frequency	30MHz~1000MHz / RB 120kHz for QP

3.2.2 TEST PROCEDURE

- The measuring distance of at 3 m shall be used for measurements at frequency 0.009MHz up to 1GHz, and above 1GHz.
- The EUT was placed on the top of a rotating table 0.8 meters (above 1GHz is 1.5 m) above the ground at a 3 meter anechoic chamber test site. The table was rotated 360 degrees to determine the position of the highest radiation.
- The height of the equipment shall be 0.8 m (above 1GHz is 1.5 m); the height of the test antenna shall vary between 1 m to 4 m. horizontal and vertical polarizations of the antenna are set to make the measurement.
- The initial step in collecting conducted emission data is a spectrum analyzer peak detector mode pre-scanning the measurement frequency range. Significant peaks are then marked and then QuasiPeak detector mode re-measured.
- If the Peak Mode measured value compliance with and lower than Quasi Peak Mode Limit, the EUT shall be deemed to meet QP Limits and then no additional QP Mode measurement performed.
- For the actual test configuration, please refer to the related Item –EUT Test Photos.

Note:

Both horizontal and vertical antenna polarities were tested and performed pretest to three orthogonal axis. The worst case emissions were reported

3.2.3 DEVIATION FROM TEST STANDARD

No deviation

3.2.4 TESTSETUP

(A) Radiated Emission Test-Up Frequency Below 30MHz

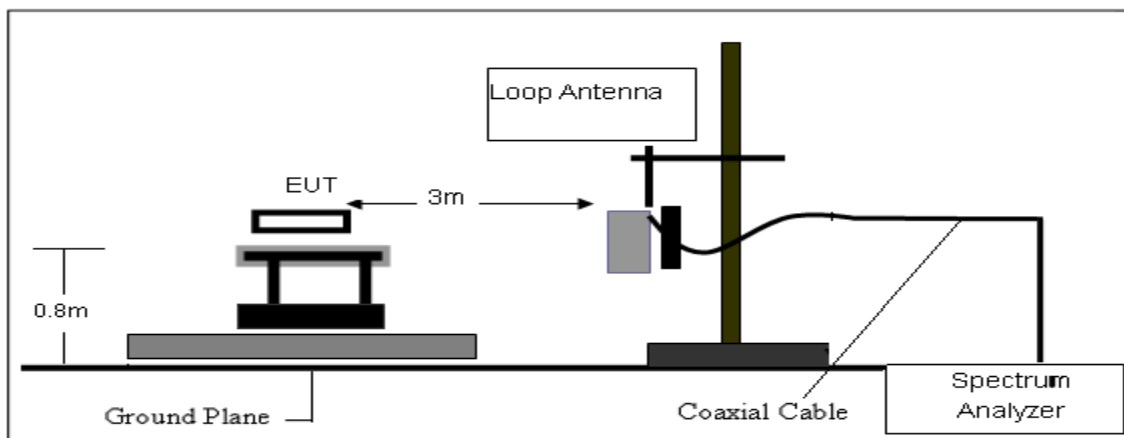

(B) Radiated Emission Test-Up Frequency 30MHz~1GHz

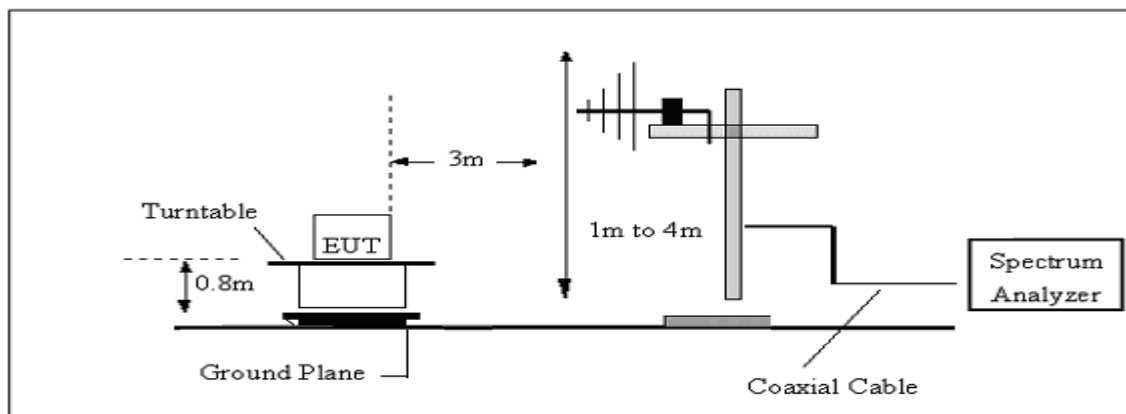

(C) Radiated Emission Test-Up Frequency Above 1GHz

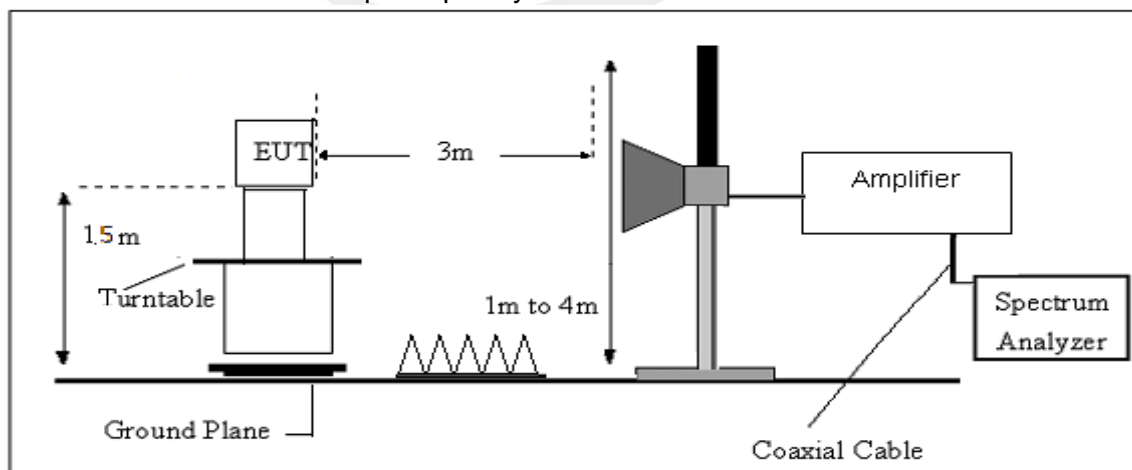

3.2.5 EUT OPERATING CONDITIONS

The EUT tested system was configured as the statements of 2.4 Unless otherwise a special operating condition is specified in the follows during the testing.



3.2.6 TEST RESULTS

(9KHz-30MHz)

Temperature:	26 °C	Relative Humidity:	60%
Pressure:	1010hPa	Test Mode:	TX Mode
Test Voltage:	DC 12V from Adapter		

Freq. (MHz)	Reading (dBuV/m)	Limit (dBuV/m)	Margin (dB)	State P/F	Test Result
--	--	--	--	--	PASS
--	--	--	--	--	PASS

Note:

The amplitude of spurious emissions which are attenuated by more than 20dB below the permissible value has no need to be reported.

Distance extrapolation factor = $40 \log(\text{specific distance}/\text{test distance})$ (dB);

Limit line = specific limits(dBuv) + distance extrapolation factor.

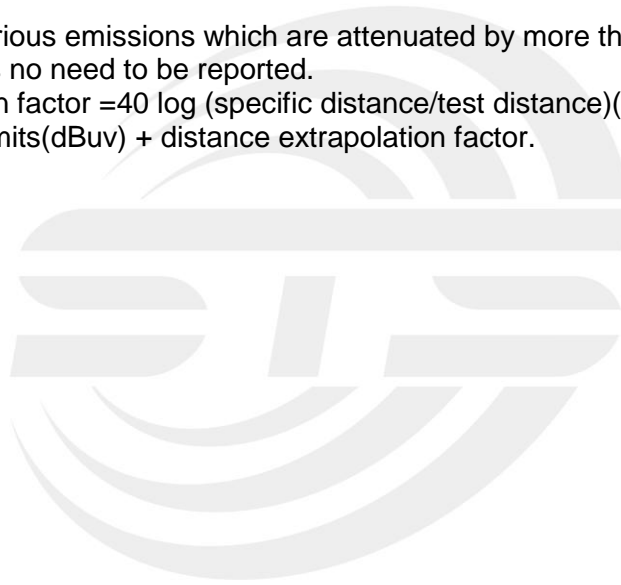



(30MHz-1000MHz)

ANT I			
Temperature:	26 °C	Relative Humidity:	60%
Pressure:	1010hPa	Phase:	Horizontal
Test Voltage:	DC 12V from Adapter	Test Mode:	Mode 1/2/3 (Mode 3-1M worst mode)

Frequency (MHz)	Reading (dBuV)	Correct Factor(dB/m)	Result (dBuV/m)	Limit (dBuV/m)	Margin (dB)	Remark
42.0066	42.10	-17.36	24.74	40.00	-15.26	QP
48.3318	43.04	-20.62	22.42	40.00	-17.58	QP
98.1420	46.97	-19.38	27.59	43.50	-15.91	QP
230.0985	44.42	-18.47	25.95	46.00	-20.05	QP
287.9904	35.95	-15.49	20.46	46.00	-25.54	QP
520.8882	33.14	-8.77	24.37	46.00	-21.63	QP

Remark:

1. Margin = Result (Result =Reading + Factor)-Limit

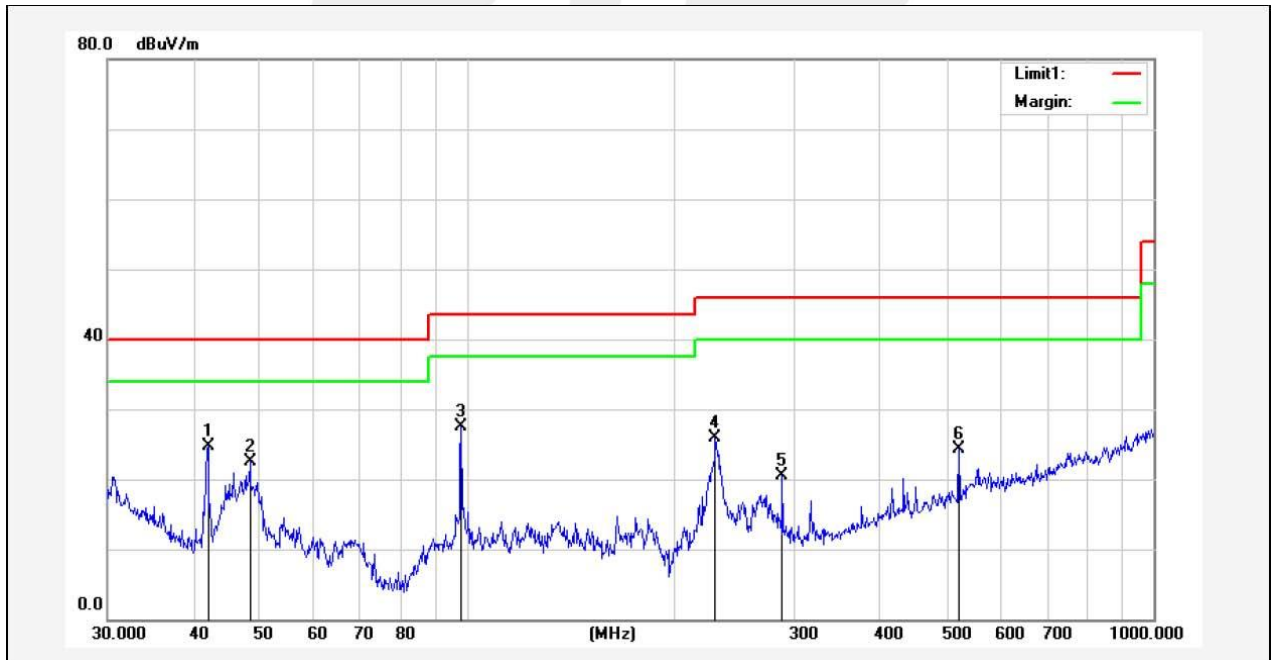



Temperature:	26 °C	Relative Humidity:	60%
Pressure:	1010hPa	Phase:	Vertical
Test Voltage:	DC 12V from Adapter	Test Mode:	Mode 1/2/3 (Mode 3-1M worst mode)

Frequency (MHz)	Reading (dBuV)	Correct Factor(dB/m)	Result (dBuV/m)	Limit (dBuV/m)	Margin (dB)	Remark
30.7455	47.39	-11.57	35.82	40.00	-4.18	QP
46.3402	47.74	-19.60	28.14	40.00	-11.86	QP
98.1420	46.22	-19.38	26.84	43.50	-16.66	QP
187.7530	44.98	-20.07	24.91	43.50	-18.59	QP
416.1791	35.85	-10.97	24.88	46.00	-21.12	QP
955.4381	29.43	-0.26	29.17	46.00	-16.83	QP

Remark:

1. Margin = Result (Result =Reading + Factor)–Limit

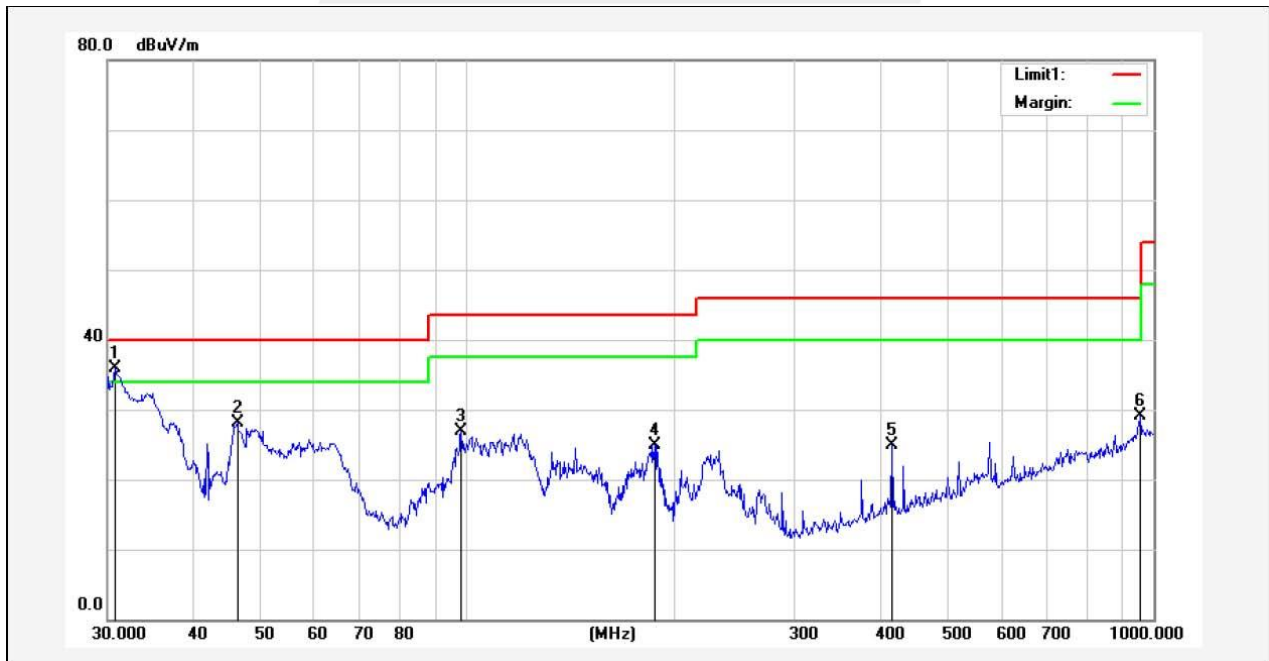



ANT II			
Temperature:	26 °C	Relative Humidity:	60%
Pressure:	1010hPa	Phase:	Horizontal
Test Voltage:	DC 12V from Adapter	Test Mode:	Mode 4/5/6 (Mode 6-1M worst mode)

Frequency (MHz)	Reading (dBuV)	Correct Factor(dB/m)	Result (dBuV/m)	Limit (dBuV/m)	Margin (dB)	Remark
30.5306	32.86	-11.47	21.39	40.00	-18.61	QP
180.0165	34.18	-19.44	14.74	43.50	-28.76	QP
270.3748	30.55	-15.48	15.07	46.00	-30.93	QP
574.6258	29.60	-6.67	22.93	46.00	-23.07	QP
750.1083	32.55	-3.56	28.99	46.00	-17.01	QP
935.5463	31.67	-0.90	30.77	46.00	-15.23	QP

Remark:

1. Margin = Result (Result =Reading + Factor)–Limit

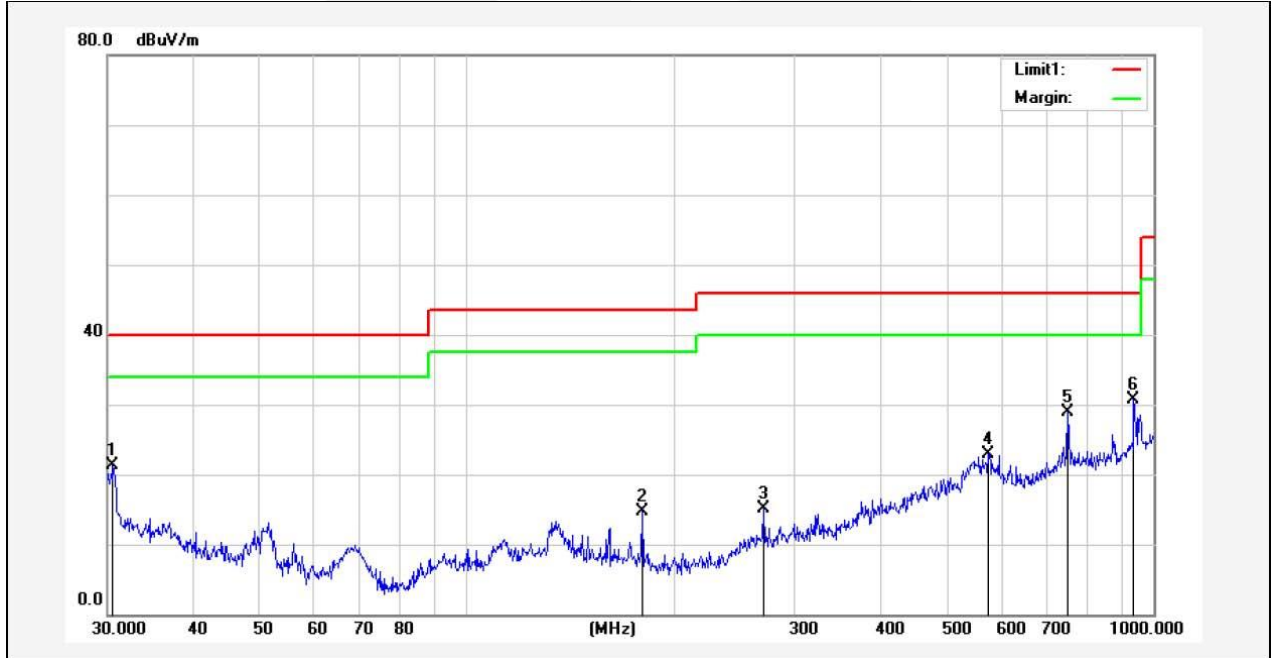



Temperature:	26 °C	Relative Humidity:	60%
Pressure:	1010hPa	Phase:	Vertical
Test Voltage:	DC 12V from Adapter	Test Mode:	Mode 4/5/6 (Mode 6-1M worst mode)

Frequency (MHz)	Reading (dBuV)	Correct Factor(dB/m)	Result (dBuV/m)	Limit (dBuV/m)	Margin (dB)	Remark
30.6380	32.99	-11.52	21.47	40.00	-18.53	QP
150.0108	32.68	-17.97	14.71	43.50	-28.79	QP
180.0165	34.49	-19.44	15.05	43.50	-28.45	QP
375.9385	32.41	-12.73	19.68	46.00	-26.32	QP
750.1083	33.44	-3.56	29.88	46.00	-16.12	QP
872.1832	32.51	-2.59	29.92	46.00	-16.08	QP

Remark:

1. Margin = Result (Result =Reading + Factor)–Limit

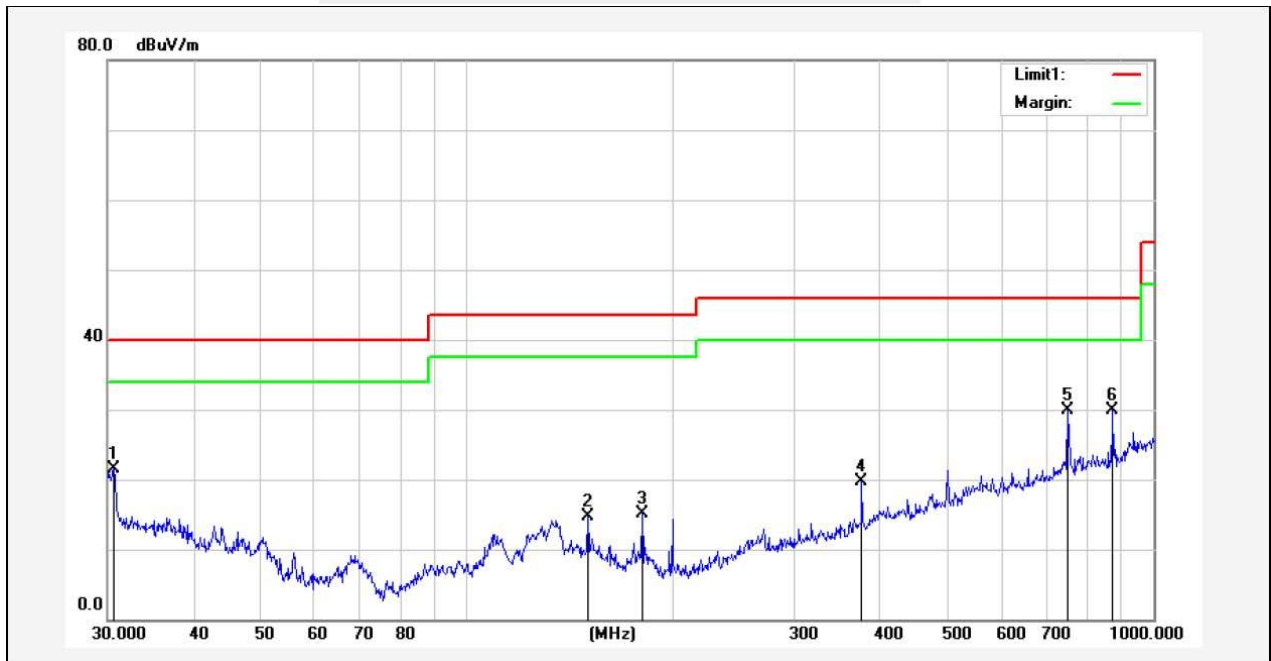



(1GHz~25GHz) Restricted band and Spurious emission Requirements

ANT I GFSK Low Channel

Frequency (MHz)	Reading (dBμV)	Amplifier (dB)	Loss (dB)	Antenna Factor (dB/m)	Corrected Factor (dB)	Emission Level (dBμV/m)	Limits (dBμV/m)	Margin (dB)	Detector Type	Comment
Low Channel (2405 MHz)										
3264.62	48.96	44.70	6.70	28.20	-9.80	39.16	74.00	-34.84	PK	Vertical
3264.62	38.93	44.70	6.70	28.20	-9.80	29.13	54.00	-24.87	AV	Vertical
3264.77	48.37	44.70	6.70	28.20	-9.80	38.57	74.00	-35.43	PK	Horizontal
3264.77	39.30	44.70	6.70	28.20	-9.80	29.50	54.00	-24.50	AV	Horizontal
4809.50	59.49	44.20	9.04	31.60	-3.56	55.93	74.00	-18.07	PK	Vertical
4809.50	38.81	44.20	9.04	31.60	-3.56	35.25	54.00	-18.75	AV	Vertical
4809.73	58.94	44.20	9.04	31.60	-3.56	55.38	74.00	-18.62	PK	Horizontal
4809.73	39.15	44.20	9.04	31.60	-3.56	35.59	54.00	-18.41	AV	Horizontal
5359.85	45.11	44.20	9.86	32.00	-2.34	42.77	74.00	-31.23	PK	Vertical
5359.85	37.71	44.20	9.86	32.00	-2.34	35.37	54.00	-18.63	AV	Vertical
5359.65	46.10	44.20	9.86	32.00	-2.34	43.76	74.00	-30.24	PK	Horizontal
5359.65	38.14	44.20	9.86	32.00	-2.34	35.80	54.00	-18.20	AV	Horizontal
7214.73	51.96	43.50	11.40	35.50	3.40	55.36	74.00	-18.64	PK	Vertical
7214.73	33.10	43.50	11.40	35.50	3.40	36.50	54.00	-17.50	AV	Vertical
7214.68	51.64	43.50	11.40	35.50	3.40	55.04	74.00	-18.96	PK	Horizontal
7214.68	32.72	43.50	11.40	35.50	3.40	36.12	54.00	-17.88	AV	Horizontal
11035.88	41.16	43.60	14.30	39.50	10.20	51.36	74.00	-22.64	PK	Vertical
11035.88	30.36	43.60	14.30	39.50	10.20	40.56	54.00	-13.44	AV	Vertical
11036.08	40.57	43.60	14.30	39.50	10.20	50.77	74.00	-23.23	PK	Horizontal
11036.08	30.69	43.60	14.30	39.50	10.20	40.89	54.00	-13.11	AV	Horizontal
13299.37	40.43	42.60	15.90	38.90	12.20	52.63	74.00	-21.37	PK	Vertical
13299.37	28.54	42.60	15.90	38.90	12.20	40.74	54.00	-13.26	AV	Vertical
13299.52	39.81	42.60	15.90	38.90	12.20	52.01	74.00	-21.99	PK	Horizontal
13299.52	28.59	42.60	15.90	38.90	12.20	40.79	54.00	-13.21	AV	Horizontal
15999.72	40.13	42.70	18.00	37.10	12.40	52.53	74.00	-21.47	PK	Vertical
15999.72	28.64	42.70	18.00	37.10	12.40	41.04	54.00	-12.96	AV	Vertical
15999.59	40.82	42.70	18.00	37.10	12.40	53.22	74.00	-20.78	PK	Horizontal
15999.59	30.09	42.70	18.00	37.10	12.40	42.49	54.00	-11.51	AV	Horizontal
17997.86	29.88	42.70	19.40	46.50	23.20	53.08	74.00	-20.92	PK	Vertical
17997.86	20.04	42.70	19.40	46.50	23.20	43.24	54.00	-10.76	AV	Vertical
17997.74	31.03	42.70	19.40	46.50	23.20	54.23	74.00	-19.77	PK	Horizontal
17997.74	18.20	42.70	19.40	46.50	23.20	41.40	54.00	-12.60	AV	Horizontal



ANT I GFSK Mid Channel

Frequency (MHz)	Reading (dBμV)	Amplifier (dB)	Loss (dB)	Antenna		Corrected		Emission		Margin (dB)	Detector Type	Comment
				Factor (dB/m)	Factor (dB)	Level (dBμV/m)	Limits (dBμV/m)					
Mid Channel (2447 MHz)												
3264.62	48.05	44.70	6.70	28.20	-9.80	38.25	74.00	-35.75	PK	Vertical		
3264.62	38.47	44.70	6.70	28.20	-9.80	28.67	54.00	-25.33	AV	Vertical		
3264.64	47.81	44.70	6.70	28.20	-9.80	38.01	74.00	-35.99	PK	Horizontal		
3264.64	38.00	44.70	6.70	28.20	-9.80	28.20	54.00	-25.80	AV	Horizontal		
4894.55	58.32	44.20	9.04	31.60	-3.56	54.76	74.00	-19.24	PK	Vertical		
4894.55	38.84	44.20	9.04	31.60	-3.56	35.28	54.00	-18.72	AV	Vertical		
4894.33	59.46	44.20	9.04	31.60	-3.56	55.90	74.00	-18.10	PK	Horizontal		
4894.33	38.16	44.20	9.04	31.60	-3.56	34.60	54.00	-19.40	AV	Horizontal		
5359.83	45.26	44.20	9.86	32.00	-2.34	42.92	74.00	-31.08	PK	Vertical		
5359.83	37.86	44.20	9.86	32.00	-2.34	35.52	54.00	-18.48	AV	Vertical		
5359.81	46.27	44.20	9.86	32.00	-2.34	43.93	74.00	-30.07	PK	Horizontal		
5359.81	37.95	44.20	9.86	32.00	-2.34	35.61	54.00	-18.39	AV	Horizontal		
7340.89	51.00	43.50	11.40	35.50	3.40	54.40	74.00	-19.60	PK	Vertical		
7340.89	33.22	43.50	11.40	35.50	3.40	36.62	54.00	-17.38	AV	Vertical		
7340.94	51.40	43.50	11.40	35.50	3.40	54.80	74.00	-19.20	PK	Horizontal		
7340.94	33.52	43.50	11.40	35.50	3.40	36.92	54.00	-17.08	AV	Horizontal		
9607.88	39.84	43.60	14.30	39.50	10.20	50.04	74.00	-23.96	PK	Vertical		
9607.88	29.88	43.60	14.30	39.50	10.20	40.08	54.00	-13.92	AV	Vertical		
9608.04	40.89	43.60	14.30	39.50	10.20	51.09	74.00	-22.91	PK	Horizontal		
9608.04	30.64	43.60	14.30	39.50	10.20	40.84	54.00	-13.16	AV	Horizontal		
13299.29	39.70	42.60	15.90	38.90	12.20	51.90	74.00	-22.10	PK	Vertical		
13299.29	28.54	42.60	15.90	38.90	12.20	40.74	54.00	-13.26	AV	Vertical		
13299.48	39.91	42.60	15.90	38.90	12.20	52.11	74.00	-21.89	PK	Horizontal		
13299.48	28.86	42.60	15.90	38.90	12.20	41.06	54.00	-12.94	AV	Horizontal		
15999.78	40.03	42.70	18.00	37.10	12.40	52.43	74.00	-21.57	PK	Vertical		
15999.78	28.64	42.70	18.00	37.10	12.40	41.04	54.00	-12.96	AV	Vertical		
15999.80	39.66	42.70	18.00	37.10	12.40	52.06	74.00	-21.94	PK	Horizontal		
15999.80	29.30	42.70	18.00	37.10	12.40	41.70	54.00	-12.30	AV	Horizontal		
17997.83	30.35	42.70	19.40	46.50	23.20	53.55	74.00	-20.45	PK	Vertical		
17997.83	19.78	42.70	19.40	46.50	23.20	42.98	54.00	-11.02	AV	Vertical		
17997.58	30.55	42.70	19.40	46.50	23.20	53.75	74.00	-20.25	PK	Horizontal		
17997.58	18.06	42.70	19.40	46.50	23.20	41.26	54.00	-12.74	AV	Horizontal		



ANT I GFSK High Channel

Frequency (MHz)	Reading (dBμV)	Amplifier (dB)	Loss (dB)	Antenna		Corrected		Emission		Margin (dB)	Detector Type	Comment
				Factor (dB/m)	Factor (dB)	Level (dBμV/m)	Limits (dBμV/m)					
High Channel (2475 MHz)												
3264.76	47.98	44.70	6.70	28.20	-9.80	38.18	74.00	-35.82	PK	Vertical		
3264.76	38.59	44.70	6.70	28.20	-9.80	28.79	54.00	-25.21	AV	Vertical		
3264.82	49.08	44.70	6.70	28.20	-9.80	39.28	74.00	-34.72	PK	Horizontal		
3264.82	38.59	44.70	6.70	28.20	-9.80	28.79	54.00	-25.21	AV	Horizontal		
4950.44	59.35	44.20	9.04	31.60	-3.56	55.79	74.00	-18.21	PK	Vertical		
4950.44	38.78	44.20	9.04	31.60	-3.56	35.22	54.00	-18.78	AV	Vertical		
4950.55	58.38	44.20	9.04	31.60	-3.56	54.82	74.00	-19.18	PK	Horizontal		
4950.55	39.27	44.20	9.04	31.60	-3.56	35.71	54.00	-18.29	AV	Horizontal		
5359.77	45.13	44.20	9.86	32.00	-2.34	42.79	74.00	-31.21	PK	Vertical		
5359.77	38.11	44.20	9.86	32.00	-2.34	35.77	54.00	-18.23	AV	Vertical		
5359.79	46.46	44.20	9.86	32.00	-2.34	44.12	74.00	-29.88	PK	Horizontal		
5359.79	37.92	44.20	9.86	32.00	-2.34	35.58	54.00	-18.42	AV	Horizontal		
7424.86	51.46	43.50	11.40	35.50	3.40	54.86	74.00	-19.14	PK	Vertical		
7424.86	32.89	43.50	11.40	35.50	3.40	36.29	54.00	-17.71	AV	Vertical		
7424.78	51.56	43.50	11.40	35.50	3.40	54.96	74.00	-19.04	PK	Horizontal		
7424.78	32.70	43.50	11.40	35.50	3.40	36.10	54.00	-17.90	AV	Horizontal		
9899.77	41.15	43.60	14.30	39.50	10.20	51.35	74.00	-22.65	PK	Vertical		
9899.77	30.43	43.60	14.30	39.50	10.20	40.63	54.00	-13.37	AV	Vertical		
9900.17	41.05	43.60	14.30	39.50	10.20	51.25	74.00	-22.75	PK	Horizontal		
9900.17	30.87	43.60	14.30	39.50	10.20	41.07	54.00	-12.93	AV	Horizontal		
13299.16	40.50	42.70	18.00	37.10	12.40	52.90	74.00	-21.10	PK	Vertical		
13299.16	28.54	42.70	18.00	37.10	12.40	40.94	54.00	-13.06	AV	Vertical		
13299.42	39.70	42.70	18.00	37.10	12.40	52.10	74.00	-21.90	PK	Horizontal		
13299.42	29.15	42.70	18.00	37.10	12.40	41.55	54.00	-12.45	AV	Horizontal		
17997.72	31.12	42.70	19.40	46.50	23.20	54.32	74.00	-19.68	PK	Vertical		
17997.72	18.79	42.70	19.40	46.50	23.20	41.99	54.00	-12.01	AV	Vertical		
17997.76	30.51	42.70	19.40	46.50	23.20	53.71	74.00	-20.29	PK	Horizontal		
17997.76	18.75	42.70	19.40	46.50	23.20	41.95	54.00	-12.05	AV	Horizontal		

Note:

- 1) Scan with GFSK, π, the worst case is GFSK Mode
- 2) Factor = Antenna Factor + Cable Loss – Pre-amplifier.

Emission Level = Reading + Factor



ANT II GFSK Low Channel

Frequency (MHz)	Reading (dBμV)	Amplifier (dB)	Loss (dB)	Antenna Factor (dB/m)	Corrected Factor (dB)	Emission Level (dBμV/m)	Limits (dBμV/m)	Margin (dB)	Detector Type	Comment
Low Channel (2405 MHz)										
3264.77	48.20	44.70	6.70	28.20	-9.80	38.40	74.00	-35.60	PK	Vertical
3264.77	39.69	44.70	6.70	28.20	-9.80	29.89	54.00	-24.11	AV	Vertical
3264.76	47.81	44.70	6.70	28.20	-9.80	38.01	74.00	-35.99	PK	Horizontal
3264.76	38.56	44.70	6.70	28.20	-9.80	28.76	54.00	-25.24	AV	Horizontal
4809.54	59.25	44.20	9.04	31.60	-3.56	55.69	74.00	-18.31	PK	Vertical
4809.54	39.52	44.20	9.04	31.60	-3.56	35.96	54.00	-18.04	AV	Vertical
4809.57	58.48	44.20	9.04	31.60	-3.56	54.92	74.00	-19.08	PK	Horizontal
4809.57	38.80	44.20	9.04	31.60	-3.56	35.24	54.00	-18.76	AV	Horizontal
5359.79	45.57	44.20	9.86	32.00	-2.34	43.23	74.00	-30.77	PK	Vertical
5359.79	38.08	44.20	9.86	32.00	-2.34	35.74	54.00	-18.26	AV	Vertical
5359.63	46.26	44.20	9.86	32.00	-2.34	43.92	74.00	-30.08	PK	Horizontal
5359.63	37.81	44.20	9.86	32.00	-2.34	35.47	54.00	-18.53	AV	Horizontal
7214.72	51.81	43.50	11.40	35.50	3.40	55.21	74.00	-18.79	PK	Vertical
7214.72	33.86	43.50	11.40	35.50	3.40	37.26	54.00	-16.74	AV	Vertical
7214.87	51.75	43.50	11.40	35.50	3.40	55.15	74.00	-18.85	PK	Horizontal
7214.94	32.68	43.50	11.40	35.50	3.40	36.08	54.00	-17.92	AV	Horizontal
11035.89	41.10	43.60	14.30	39.50	10.20	51.30	74.00	-22.70	PK	Vertical
11035.89	30.79	43.60	14.30	39.50	10.20	40.99	54.00	-13.01	AV	Vertical
11036.06	40.98	43.60	14.30	39.50	10.20	51.18	74.00	-22.82	PK	Horizontal
11036.06	29.99	43.60	14.30	39.50	10.20	40.19	54.00	-13.81	AV	Horizontal
13299.18	41.03	42.60	15.90	38.90	12.20	53.23	74.00	-20.77	PK	Vertical
13299.18	28.54	42.60	15.90	38.90	12.20	40.74	54.00	-13.26	AV	Vertical
13299.50	40.47	42.60	15.90	38.90	12.20	52.67	74.00	-21.33	PK	Horizontal
13299.50	29.10	42.60	15.90	38.90	12.20	41.30	54.00	-12.70	AV	Horizontal
15999.84	40.79	42.70	18.00	37.10	12.40	53.19	74.00	-20.81	PK	Vertical
15999.84	28.64	42.70	18.00	37.10	12.40	41.04	54.00	-12.96	AV	Vertical
15999.82	40.49	42.70	18.00	37.10	12.40	52.89	74.00	-21.11	PK	Horizontal
15999.82	29.90	42.70	18.00	37.10	12.40	42.30	54.00	-11.70	AV	Horizontal
17997.77	29.99	42.70	19.40	46.50	23.20	53.19	74.00	-20.81	PK	Vertical
17997.77	20.19	42.70	19.40	46.50	23.20	43.39	54.00	-10.61	AV	Vertical
17997.69	30.45	42.70	19.40	46.50	23.20	53.65	74.00	-20.35	PK	Horizontal
17997.69	18.22	42.70	19.40	46.50	23.20	41.42	54.00	-12.58	AV	Horizontal



ANT II GFSK Mid Channel

Frequency (MHz)	Reading (dBμV)	Amplifier (dB)	Loss (dB)	Antenna Factor (dB/m)	Corrected Factor (dB)	Emission Level (dBμV/m)	Limits (dBμV/m)	Margin (dB)	Detector Type	Comment
Mid Channel (2447 MHz)										
3264.85	48.57	44.70	6.70	28.20	-9.80	38.77	74.00	-35.23	PK	Vertical
3264.85	38.66	44.70	6.70	28.20	-9.80	28.86	54.00	-25.14	AV	Vertical
3264.74	48.83	44.70	6.70	28.20	-9.80	39.03	74.00	-34.97	PK	Horizontal
3264.74	38.91	44.70	6.70	28.20	-9.80	29.11	54.00	-24.89	AV	Horizontal
4894.33	58.82	44.20	9.04	31.60	-3.56	55.26	74.00	-18.74	PK	Vertical
4894.33	39.35	44.20	9.04	31.60	-3.56	35.79	54.00	-18.21	AV	Vertical
4894.51	58.81	44.20	9.04	31.60	-3.56	55.25	74.00	-18.75	PK	Horizontal
4894.51	39.03	44.20	9.04	31.60	-3.56	35.47	54.00	-18.53	AV	Horizontal
5359.69	46.42	44.20	9.86	32.00	-2.34	44.08	74.00	-29.92	PK	Vertical
5359.69	37.56	44.20	9.86	32.00	-2.34	35.22	54.00	-18.78	AV	Vertical
5359.58	45.22	44.20	9.86	32.00	-2.34	42.88	74.00	-31.12	PK	Horizontal
5359.58	37.16	44.20	9.86	32.00	-2.34	34.82	54.00	-19.18	AV	Horizontal
7340.98	50.59	43.50	11.40	35.50	3.40	53.99	74.00	-20.01	PK	Vertical
7340.98	33.00	43.50	11.40	35.50	3.40	36.40	54.00	-17.60	AV	Vertical
7340.77	50.96	43.50	11.40	35.50	3.40	54.36	74.00	-19.64	PK	Horizontal
7340.77	32.80	43.50	11.40	35.50	3.40	36.20	54.00	-17.80	AV	Horizontal
9607.73	40.51	43.60	14.30	39.50	10.20	50.71	74.00	-23.29	PK	Vertical
9607.73	30.19	43.60	14.30	39.50	10.20	40.39	54.00	-13.61	AV	Vertical
9608.21	40.84	43.60	14.30	39.50	10.20	51.04	74.00	-22.96	PK	Horizontal
9608.21	29.77	43.60	14.30	39.50	10.20	39.97	54.00	-14.03	AV	Horizontal
13299.30	41.01	42.60	15.90	38.90	12.20	53.21	74.00	-20.79	PK	Vertical
13299.30	28.54	42.60	15.90	38.90	12.20	40.74	54.00	-13.26	AV	Vertical
13299.36	40.91	42.60	15.90	38.90	12.20	53.11	74.00	-20.89	PK	Horizontal
13299.36	29.76	42.60	15.90	38.90	12.20	41.96	54.00	-12.04	AV	Horizontal
15999.94	39.99	42.70	18.00	37.10	12.40	52.39	74.00	-21.61	PK	Vertical
15999.94	28.64	42.70	18.00	37.10	12.40	41.04	54.00	-12.96	AV	Vertical
15999.79	40.87	42.70	18.00	37.10	12.40	53.27	74.00	-20.73	PK	Horizontal
15999.79	29.56	42.70	18.00	37.10	12.40	41.96	54.00	-12.04	AV	Horizontal
17997.65	31.06	42.70	19.40	46.50	23.20	54.26	74.00	-19.74	PK	Vertical
17997.65	19.68	42.70	19.40	46.50	23.20	42.88	54.00	-11.12	AV	Vertical
17997.80	30.72	42.70	19.40	46.50	23.20	53.92	74.00	-20.08	PK	Horizontal
17997.58	18.06	42.70	19.40	46.50	23.20	41.26	54.00	-12.74	AV	Horizontal



ANT II GFSK High Channel

Frequency (MHz)	Reading (dBμV)	Amplifier (dB)	Loss (dB)	Antenna	Corrected	Emission		Margin (dB)	Detector Type	Comment
				Factor (dB/m)	Factor (dB)	Level (dBμV/m)	Limits (dBμV/m)			
High Channel (2475 MHz)										
3264.75	48.71	44.70	6.70	28.20	-9.80	38.91	74.00	-35.09	PK	Vertical
3264.75	39.74	44.70	6.70	28.20	-9.80	29.94	54.00	-24.06	AV	Vertical
3264.63	49.24	44.70	6.70	28.20	-9.80	39.44	74.00	-34.56	PK	Horizontal
3264.63	38.44	44.70	6.70	28.20	-9.80	28.64	54.00	-25.36	AV	Horizontal
4950.30	59.18	44.20	9.04	31.60	-3.56	55.62	74.00	-18.38	PK	Vertical
4950.30	39.40	44.20	9.04	31.60	-3.56	35.84	54.00	-18.16	AV	Vertical
4950.53	58.82	44.20	9.04	31.60	-3.56	55.26	74.00	-18.74	PK	Horizontal
4950.53	38.94	44.20	9.04	31.60	-3.56	35.38	54.00	-18.62	AV	Horizontal
5359.78	45.98	44.20	9.86	32.00	-2.34	43.64	74.00	-30.36	PK	Vertical
5359.78	38.16	44.20	9.86	32.00	-2.34	35.82	54.00	-18.18	AV	Vertical
5359.81	45.47	44.20	9.86	32.00	-2.34	43.13	74.00	-30.87	PK	Horizontal
5359.81	38.52	44.20	9.86	32.00	-2.34	36.18	54.00	-17.82	AV	Horizontal
7424.80	51.13	43.50	11.40	35.50	3.40	54.53	74.00	-19.47	PK	Vertical
7424.80	32.76	43.50	11.40	35.50	3.40	36.16	54.00	-17.84	AV	Vertical
7424.89	51.11	43.50	11.40	35.50	3.40	54.51	74.00	-19.49	PK	Horizontal
7424.89	33.95	43.50	11.40	35.50	3.40	37.35	54.00	-16.65	AV	Horizontal
9899.79	40.38	43.60	14.30	39.50	10.20	50.58	74.00	-23.42	PK	Vertical
9899.79	30.00	43.60	14.30	39.50	10.20	40.20	54.00	-13.80	AV	Vertical
9900.00	40.80	43.60	14.30	39.50	10.20	51.00	74.00	-23.00	PK	Horizontal
9900.00	30.89	43.60	14.30	39.50	10.20	41.09	54.00	-12.91	AV	Horizontal
13299.40	39.84	42.70	18.00	37.10	12.40	52.24	74.00	-21.76	PK	Vertical
13299.40	28.54	42.70	18.00	37.10	12.40	40.94	54.00	-13.06	AV	Vertical
13299.31	40.48	42.70	18.00	37.10	12.40	52.88	74.00	-21.12	PK	Horizontal
13299.31	28.57	42.70	18.00	37.10	12.40	40.97	54.00	-13.03	AV	Horizontal
17997.80	30.10	42.70	19.40	46.50	23.20	53.30	74.00	-20.70	PK	Vertical
17997.80	18.95	42.70	19.40	46.50	23.20	42.15	54.00	-11.85	AV	Vertical
17997.52	30.77	42.70	19.40	46.50	23.20	53.97	74.00	-20.03	PK	Horizontal
17997.52	18.73	42.70	19.40	46.50	23.20	41.93	54.00	-12.07	AV	Horizontal



Band edge Requirements

ANT I

Frequency (MHz)	Reading (dBµV)	Amplifier (dB)	Loss (dB)	Antenna	Corrected	Emission	Limits (dBµV/m)	Margin (dB)	Detector Type	Comment
				Factor (dB/m)	Factor (dB)	Level (dBµV/m)				
GFSK										
2390.00	67.19	43.80	4.91	25.90	-12.99	54.20	74.00	-19.80	PK	Vertical
2390.00	53.04	43.80	4.91	25.90	-12.99	40.05	54.00	-13.95	AV	Vertical
2390.00	69.42	43.80	4.91	25.90	-12.99	56.43	74.00	-17.57	PK	Horizontal
2390.00	53.19	43.80	4.91	25.90	-12.99	40.20	54.00	-13.80	AV	Horizontal
2483.50	69.52	43.80	5.12	25.90	-12.78	56.74	74.00	-17.26	PK	Vertical
2483.50	53.31	43.80	5.12	25.90	-12.78	40.53	54.00	-13.47	AV	Vertical
2483.50	70.57	43.80	5.12	25.90	-12.78	57.79	74.00	-16.21	PK	Horizontal
2483.50	52.92	43.80	5.12	25.90	-12.78	40.14	54.00	-13.86	AV	Horizontal
Low measurement frequencies is range from 2300 to 2407 MHz, high measurement frequencies is range from 2474 to 2500 MHz. Only show the worst point data of the emissions in the frequency 2300-2407 MHz and 2474-2500 MHz.										

ANT II

Frequency (MHz)	Reading (dBµV)	Amplifier (dB)	Loss (dB)	Antenna	Corrected	Emission	Limits (dBµV/m)	Margin (dB)	Detector Type	Comment
				Factor (dB/m)	Factor (dB)	Level (dBµV/m)				
GFSK										
2390.00	68.25	43.80	4.91	25.90	-12.99	55.26	74.00	-18.74	PK	Vertical
2390.00	53.41	43.80	4.91	25.90	-12.99	40.42	54.00	-13.58	AV	Vertical
2390.00	69.68	43.80	4.91	25.90	-12.99	56.69	74.00	-17.31	PK	Horizontal
2390.00	53.24	43.80	4.91	25.90	-12.99	40.25	54.00	-13.75	AV	Horizontal
2483.50	70.43	43.80	5.12	25.90	-12.78	57.65	74.00	-16.35	PK	Vertical
2483.50	52.60	43.80	5.12	25.90	-12.78	39.82	54.00	-14.18	AV	Vertical
2483.50	69.55	43.80	5.12	25.90	-12.78	56.77	74.00	-17.23	PK	Horizontal
2483.50	52.11	43.80	5.12	25.90	-12.78	39.33	54.00	-14.67	AV	Horizontal
Low measurement frequencies is range from 2300 to 2407 MHz, high measurement frequencies is range from 2474 to 2500 MHz. Only show the worst point data of the emissions in the frequency 2300-2407 MHz and 2474-2500 MHz.										



Hopping Band edge

ANT I

Frequency (MHz)	Reading (dB μ V)	Amplifier (dB)	Loss (dB)	Antenna	Corrected	Emission	Limits (dB μ V/m)	Margin (dB)	Detector Type	Comment
				Factor (dB/m)	Factor (dB)	Level (dB μ V/m)				
GFSK										
2390.00	67.35	43.80	4.91	25.90	-12.99	54.36	74.00	-19.64	PK	Vertical
2390.00	53.34	43.80	4.91	25.90	-12.99	40.35	54.00	-13.65	AV	Vertical
2390.00	68.59	43.80	4.91	25.90	-12.99	55.60	74.00	-18.40	PK	Horizontal
2390.00	52.33	43.80	4.91	25.90	-12.99	39.34	54.00	-14.66	AV	Horizontal
2483.50	69.12	43.80	5.12	25.90	-12.78	56.34	74.00	-17.66	PK	Vertical
2483.50	52.86	43.80	5.12	25.90	-12.78	40.08	54.00	-13.92	AV	Vertical
2483.50	70.57	43.80	5.12	25.90	-12.78	57.79	74.00	-16.21	PK	Horizontal
2483.50	53.17	43.80	5.12	25.90	-12.78	40.39	54.00	-13.61	AV	Horizontal

Low measurement frequencies is range from 2300 to 2407 MHz high measurement frequencies is range from 2474 to 2500 MHz.
Only show the worst point data of the emissions in the frequency 2300-2407 MHz and 2474-2500 MHz.

ANT II

Frequency (MHz)	Reading (dB μ V)	Amplifier (dB)	Loss (dB)	Antenna	Corrected	Emission	Limits (dB μ V/m)	Margin (dB)	Detector Type	Comment
				Factor (dB/m)	Factor (dB)	Level (dB μ V/m)				
GFSK										
2390.00	67.94	43.80	4.91	25.90	-12.99	54.95	74.00	-19.05	PK	Vertical
2390.00	53.35	43.80	4.91	25.90	-12.99	40.36	54.00	-13.64	AV	Vertical
2390.00	69.50	43.80	4.91	25.90	-12.99	56.51	74.00	-17.49	PK	Horizontal
2390.00	52.61	43.80	4.91	25.90	-12.99	39.62	54.00	-14.38	AV	Horizontal
2483.50	69.19	43.80	5.12	25.90	-12.78	56.41	74.00	-17.59	PK	Vertical
2483.50	52.56	43.80	5.12	25.90	-12.78	39.78	54.00	-14.22	AV	Vertical
2483.50	69.89	43.80	5.12	25.90	-12.78	57.11	74.00	-16.89	PK	Horizontal
2483.50	52.68	43.80	5.12	25.90	-12.78	39.90	54.00	-14.10	AV	Horizontal

Low measurement frequencies is range from 2300 to 2407 MHz high measurement frequencies is range from 2474 to 2500 MHz.
Only show the worst point data of the emissions in the frequency 2300-2407 MHz and 2474-2500 MHz.

4. CONDUCTED SPURIOUS & BAND EDGE EMISSION

4.1 REQUIREMENT

According to FCC section 15.247(d), in any 100kHz bandwidth outside the frequency band in which the spread spectrum or digitally modulated intentional radiator is operating, the radio frequency power that is produced by the intentional radiator shall be at least 20dB below that in the 100kHz bandwidth within the band that contains the highest level of the desired power, based on either an RF conducted or a radiated measurement.

4.2 TEST PROCEDURE

Spectrum Parameter	Setting
Detector	Peak
Start/Stop Frequency	30 MHz to 10th carrier harmonic
RB / VB (emission in restricted band)	100 KHz/300 KHz
Trace-Mode:	Max hold

For Band edge

Spectrum Parameter	Setting
Detector	Peak
Start/Stop Frequency	Lower Band Edge: 2300– 2407 MHz Upper Band Edge: 2474 – 2500 MHz
RB / VB (emission in restricted band)	100 KHz/300 KHz
Trace-Mode:	Max hold

Remark : Hopping on and Hopping off mode all have been tested,only worst case hopping off is reported.

4.3 TEST SETUP

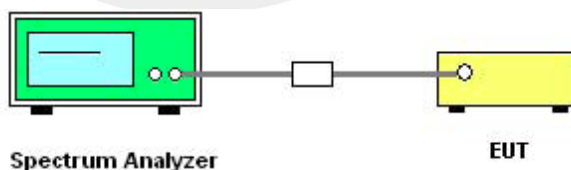

The EUT is coupled to the Spectrum Analyzer; the RF load attached to the EUT antenna terminal is 50Ohm; the path loss as the factor is calibrated to correct the reading. Make the measurement with the spectrum analyzer's resolution bandwidth(RBW) = 100 kHz. In order to make an accurate measurement, set the span greater than RBW.

4.4 EUT OPERATION CONDITIONS

The EUT tested system was configured as the statements of 2.3 Unless otherwise a special operating condition is specified in the follows during the testing.

4.5 TEST RESULTS

ANT I



Temperature:	25°C	Relative Humidity:	50%
Pressure:	1012 hPa	Test Voltage:	DC 12V
Test Mode:	GFSK(1Mbps)-00/16/29 CH		

00 CH

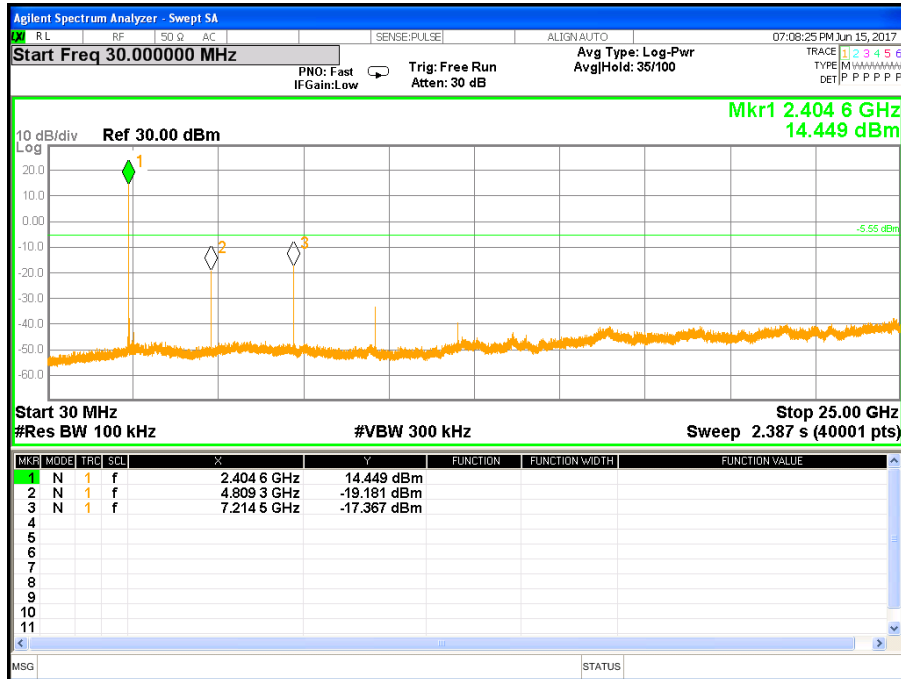

16 CH

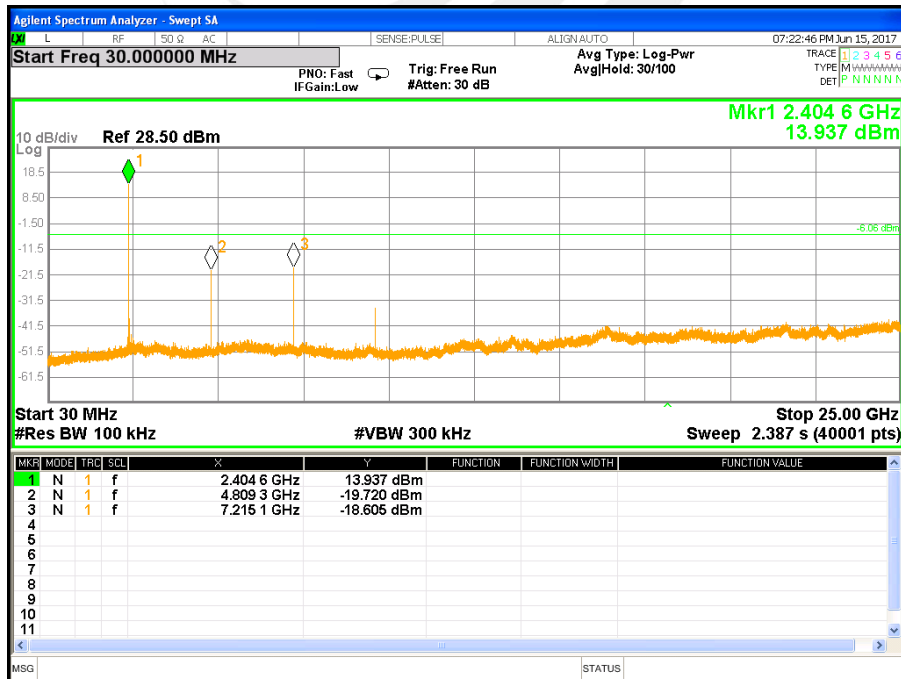

29 CH

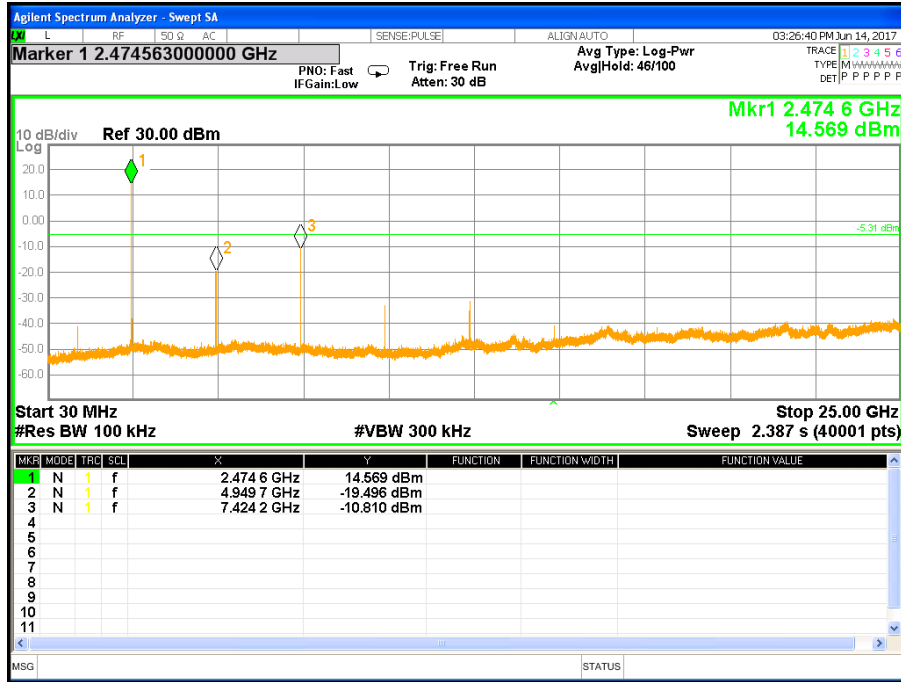



For Band edge

00 CH

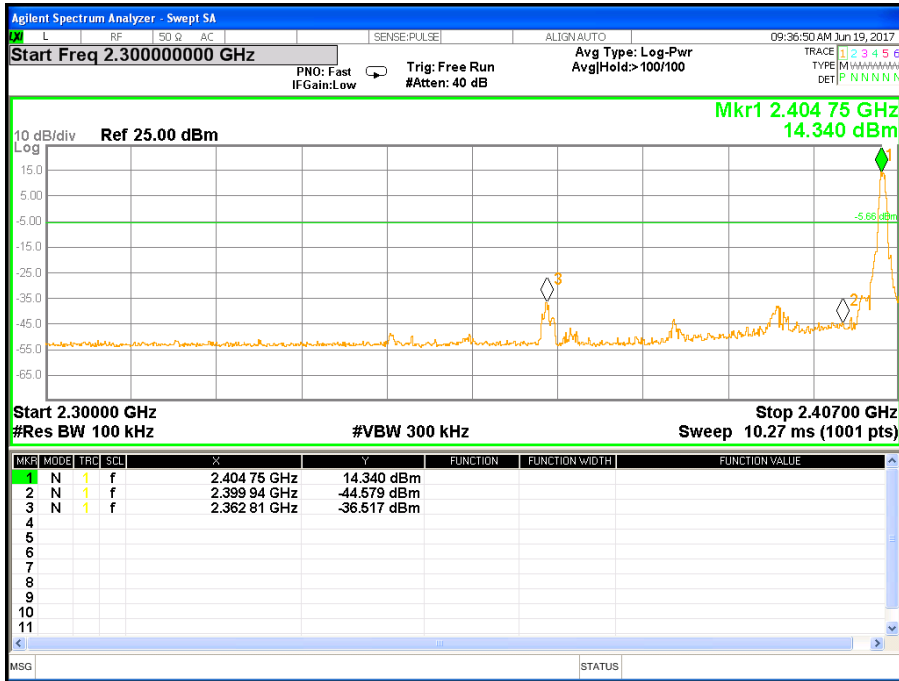

29 CH

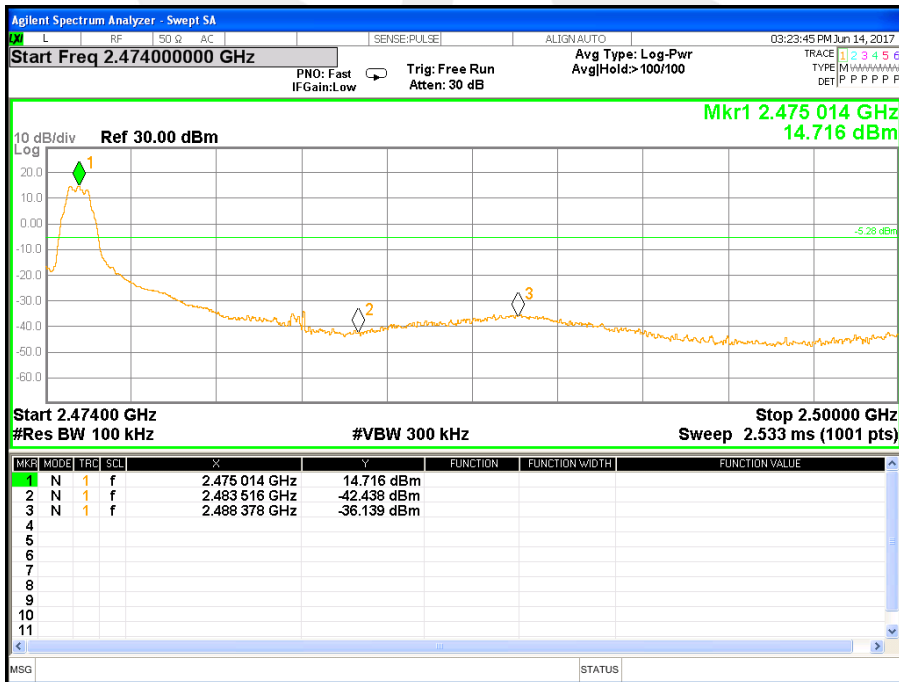



For Hopping Band edge

00 CH

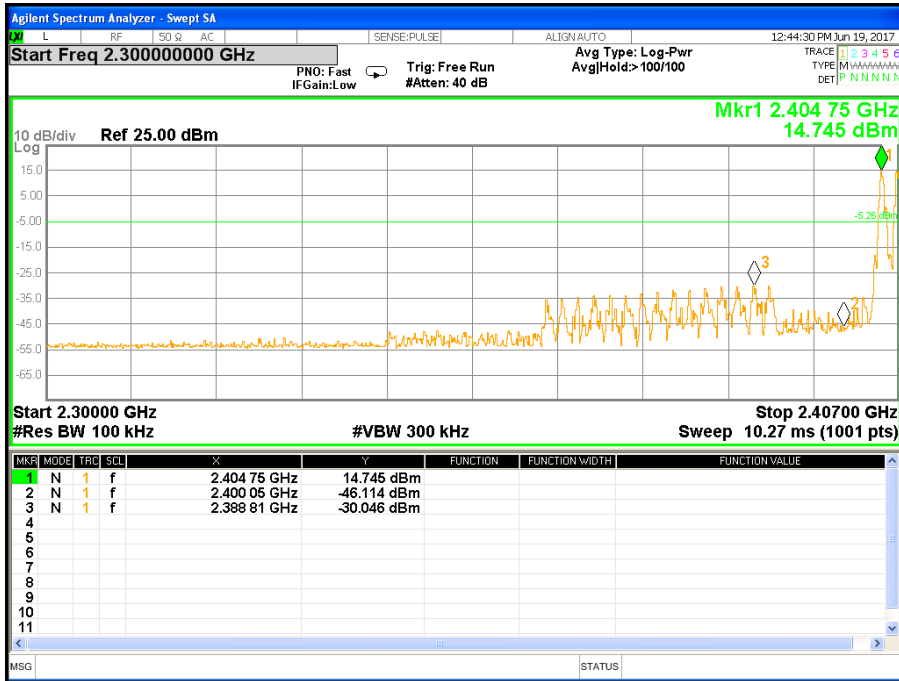

29 CH

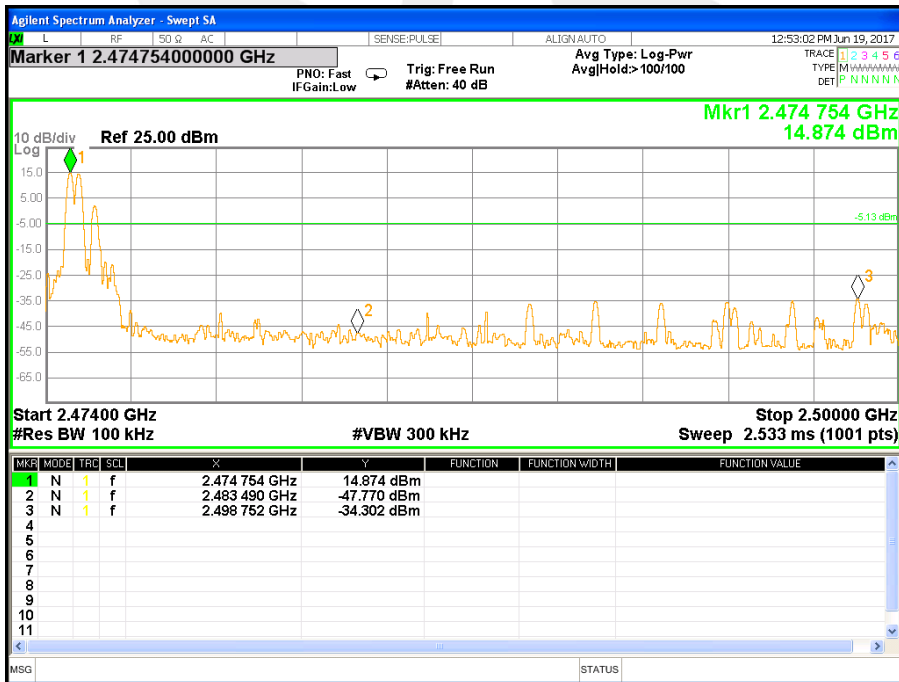



ANT II

Temperature:	25°C	Relative Humidity:	50%
Pressure:	1012 hPa	Test Voltage:	DC 12V
Test Mode:	GFSK(1Mbps)-00/16/29 CH		

00 CH

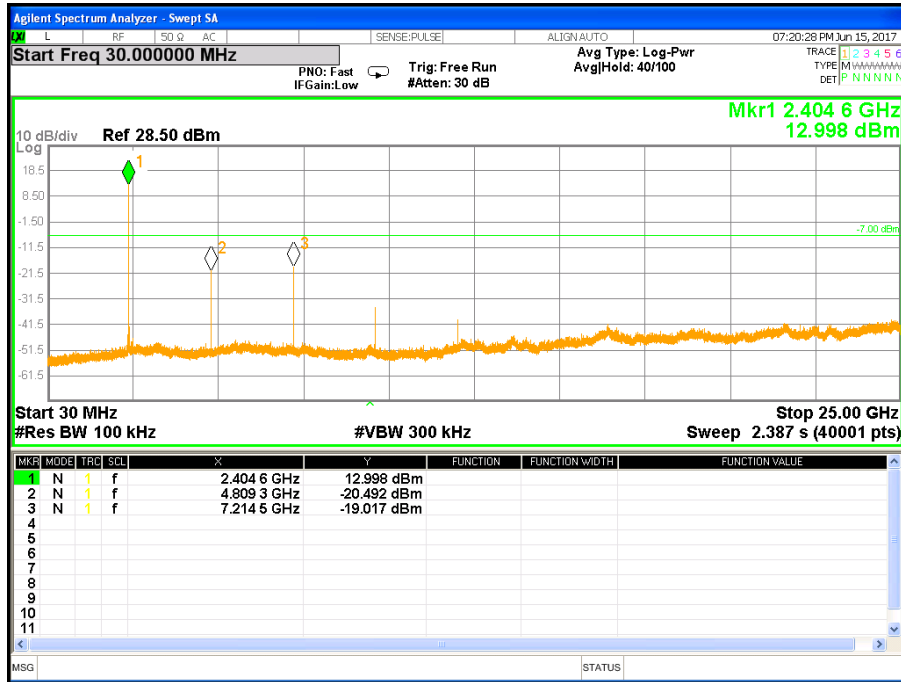

16 CH

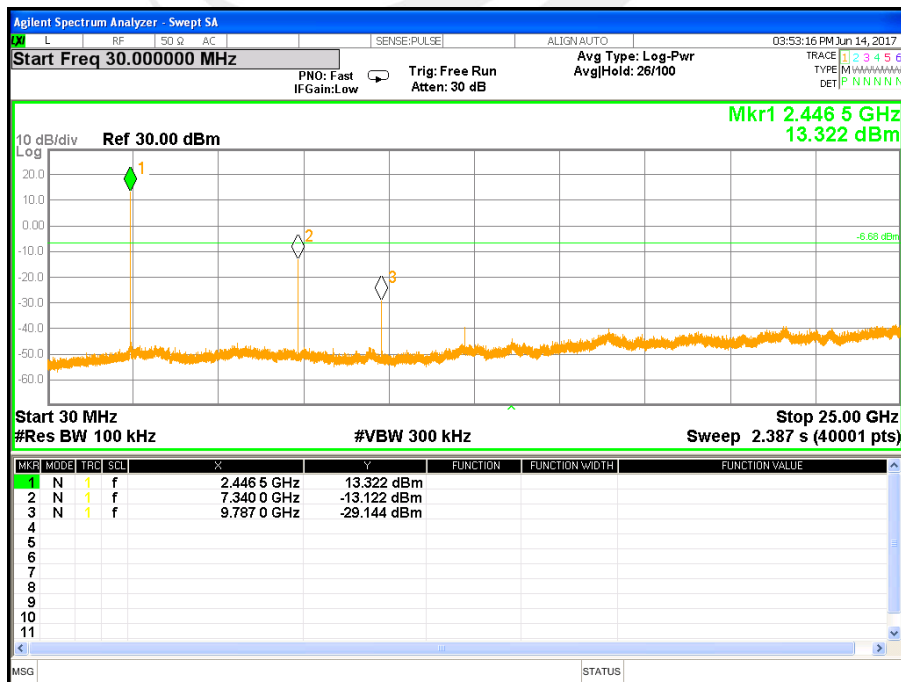



29 CH

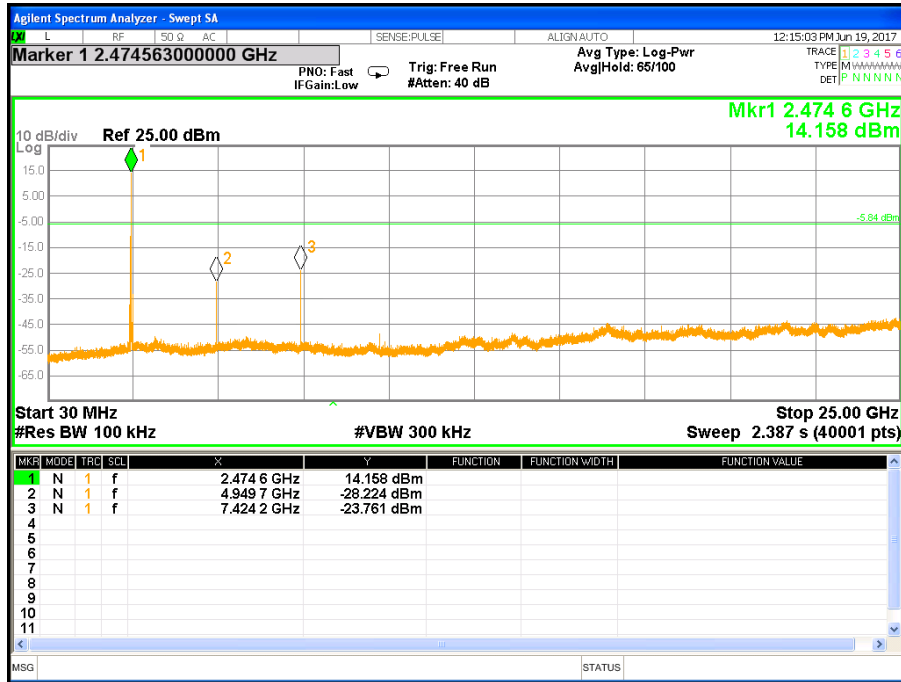



For Band edge

00 CH

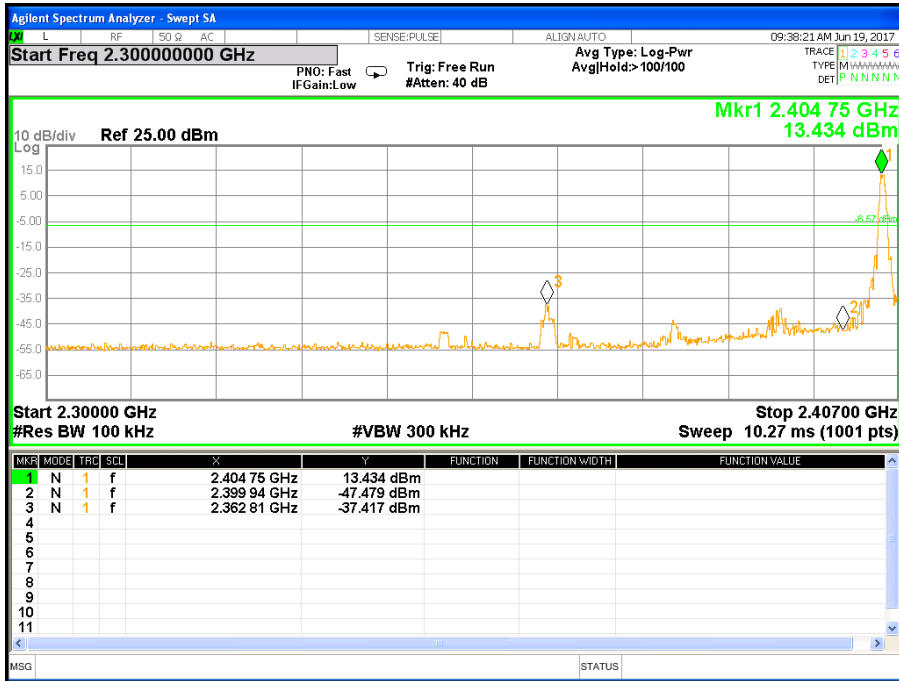

29 CH

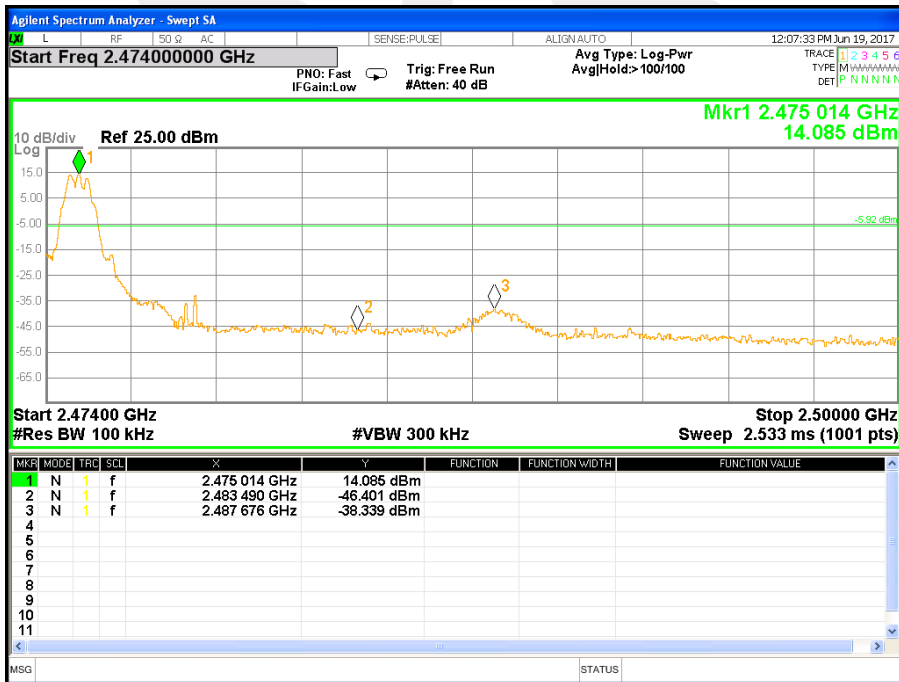



For Hopping Band edge

00 CH

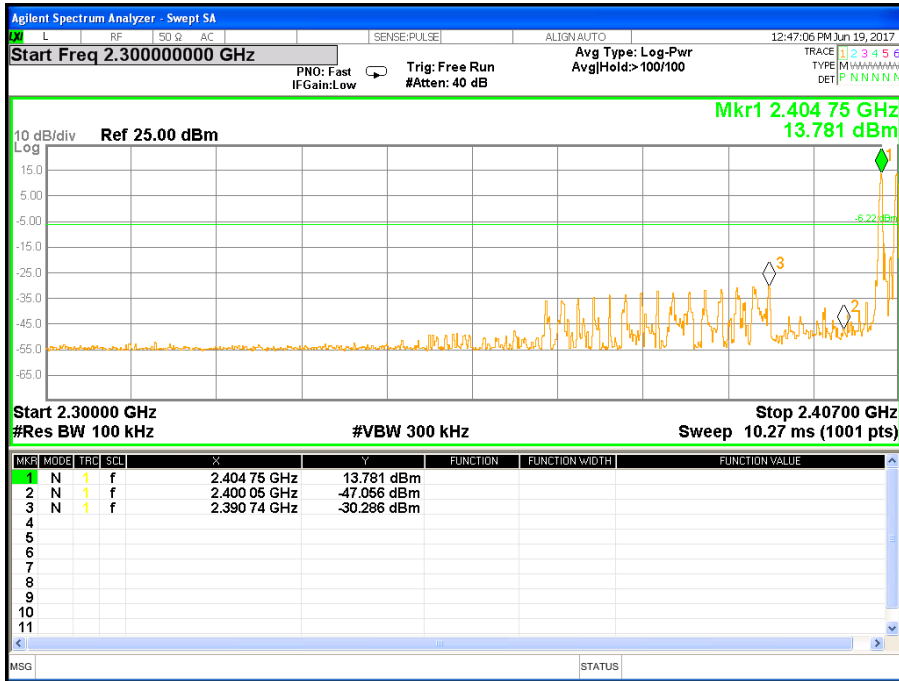

29 CH

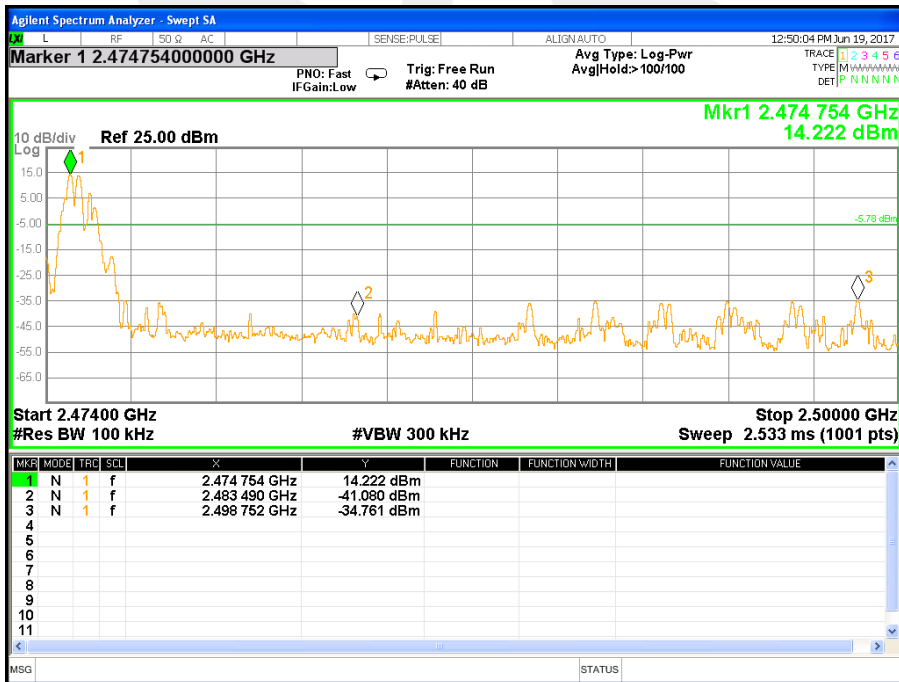



5. NUMBER OF HOPPING CHANNEL

5.1 APPLIED PROCEDURES / LIMIT

FCC Part 15.247, Subpart C				
Section	Test Item	Limit	FrequencyRange (MHz)	Result
15.247 (a)(1)(iii)	Number of Hopping Channel	≥15	2405-2475	PASS

Spectrum Parameters	Setting
Attenuation	Auto
Span Frequency	> Operating FrequencyRange
RB	100KHz
VB	100KHz
Detector	Peak
Trace	Max Hold
Sweep Time	Auto

5.2 TEST PROCEDURE

- The EUT was directly connected to the spectrum analyzer and antenna output port as show in the block diagram below,
- Spectrum Setting : RBW= 100KHz, VBW=100KHz, Sweep time = Auto.

5.3 TEST SETUP

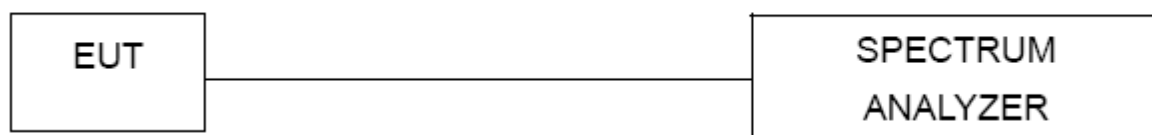

5.4 EUT OPERATION CONDITIONS

The EUT tested system was configured as the statements of 2.4 Unless otherwise a special operating condition is specified in the follows during the testing.



5.5 TEST RESULTS

ANT I

Temperature:	25°C	Relative Humidity:	60%
Pressure:	1015 hPa	Test Voltage:	DC 12V
Test Mode:	Hopping Mode		

Number of Hopping Channel

30

Hopping channel

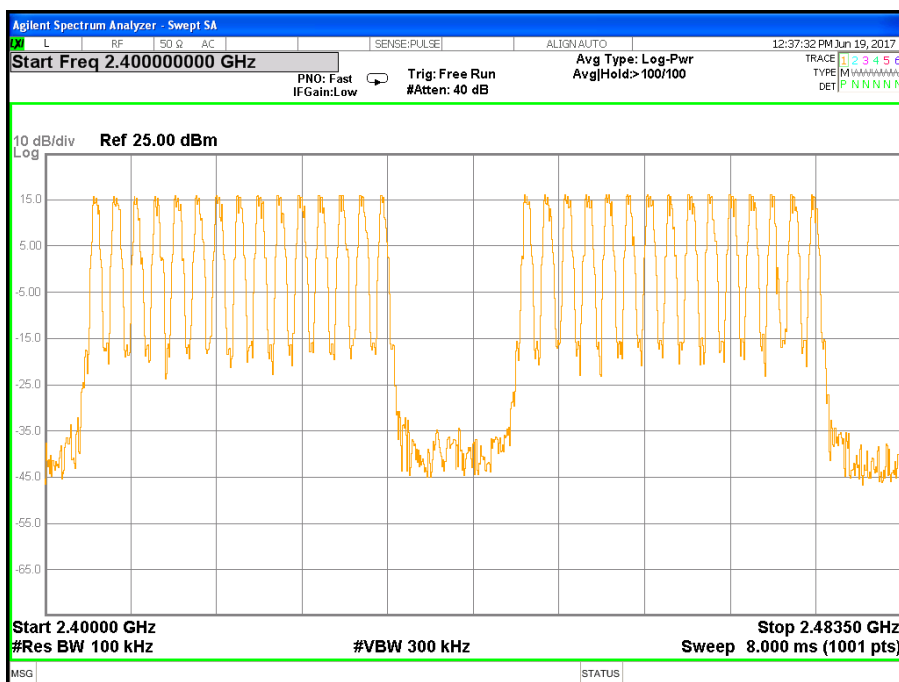



ANT II

Temperature:	25°C	Relative Humidity:	60%
Pressure:	1015 hPa	Test Voltage:	DC 12V
Test Mode:	Hopping Mode		

Number of Hopping Channel

30

Hopping channel

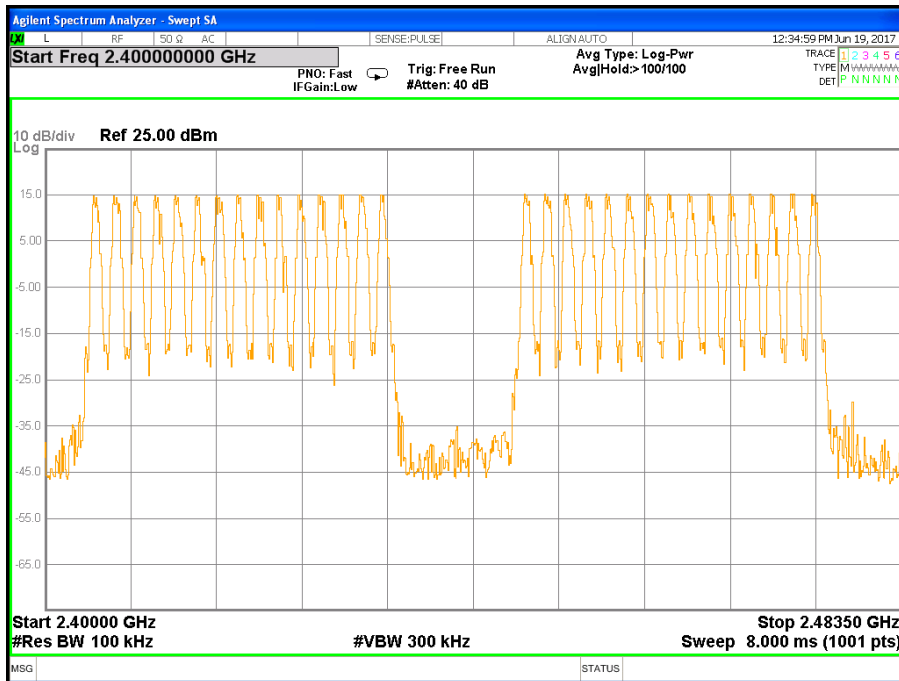



6. AVERAGE TIME OF OCCUPANCY

6.1 APPLIED PROCEDURES / LIMIT

FCC Part 15.247, Subpart C				
Section	Test Item	Limit	FrequencyRange (MHz)	Result
15.247 (a)(1)(iii)	Average Time of Occupancy	0.4sec	2405-2475	PASS

6.2 TEST PROCEDURE

- The transmitter output (antenna port) was connected to the spectrum analyzer
- Set RBW =1MHz/VBW =3MHz.
- Use a video trigger with the trigger level set to enable triggering only on full pulses.
- Sweep Time is more than once pulse time.
Set the center frequency on any frequency would be measure and set the frequency span to
- zero span.
- Measure the maximum time duration of one single pulse.

6.3 TEST SETUP

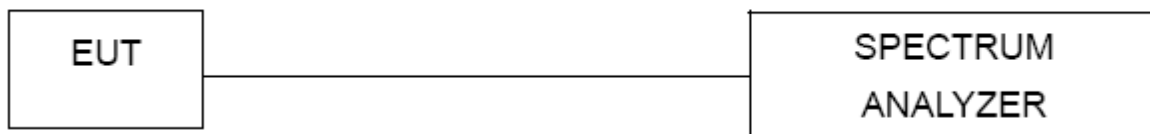

6.4 EUT OPERATION CONDITIONS

The EUT tested system was configured as the statements of 2.4 Unless otherwise a special operating condition is specified in the follows during the testing.



6.5 TEST RESULTS

ANT I

Temperature:	25°C	Relative Humidity:	50%
Pressure:	1012 hPa	Test Voltage:	DC 12V
Test Mode:	GFSK-Low/Mid/High		

Note:Dwell time= (30x0.4x1000 /100)x3 x0.9=324ms

Test channel	Frequency	Pulse Duration(ms)	Dwell Time(s)	Limits(s)
Low	2405	0.90	0.324	0.4
Middle	2447	0.90	0.324	0.4
High	2475	0.90	0.324	0.4

Low

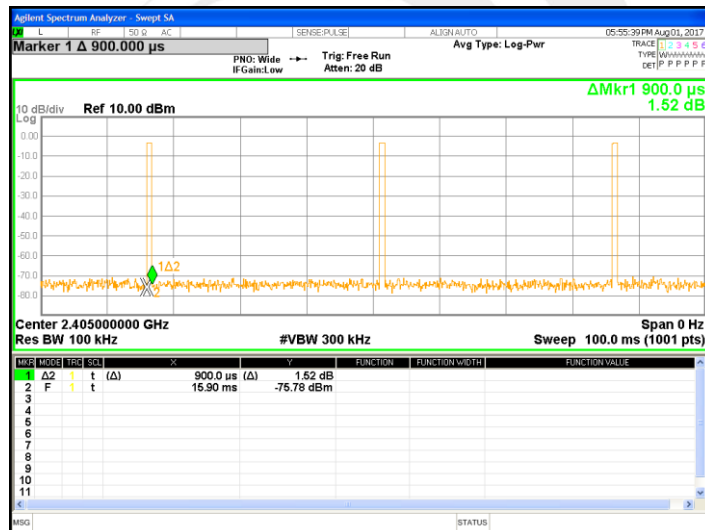

Middle

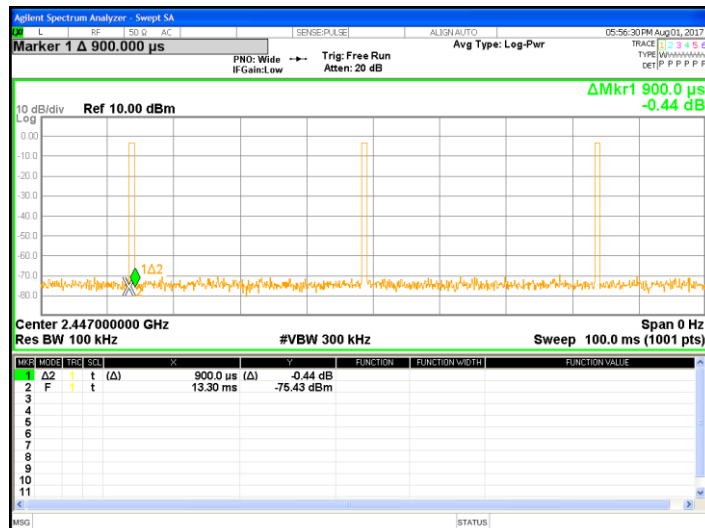



High

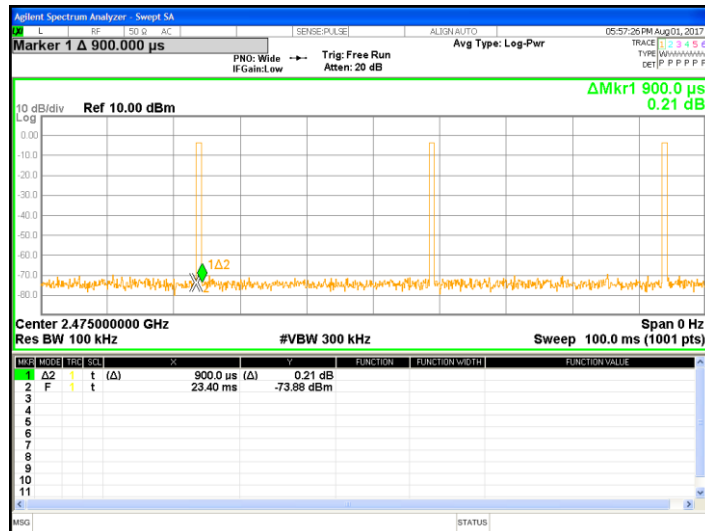



ANT II

Temperature:	25°C	Relative Humidity:	50%
Pressure:	1012 hPa	Test Voltage:	DC 12V
Test Mode:	GFSK-Low/Mid/High		

Note:Dwell time= (30x0.4x1000 / 100)x3 x0.9=324ms

Test channel	Frequency	Pulse Duration(ms)	Dwell Time(s)	Limits(s)
Low	2405	0.90	0.324	0.4
Middle	2447	0.90	0.324	0.4
High	2475	0.90	0.324	0.4

Low



Middle





High

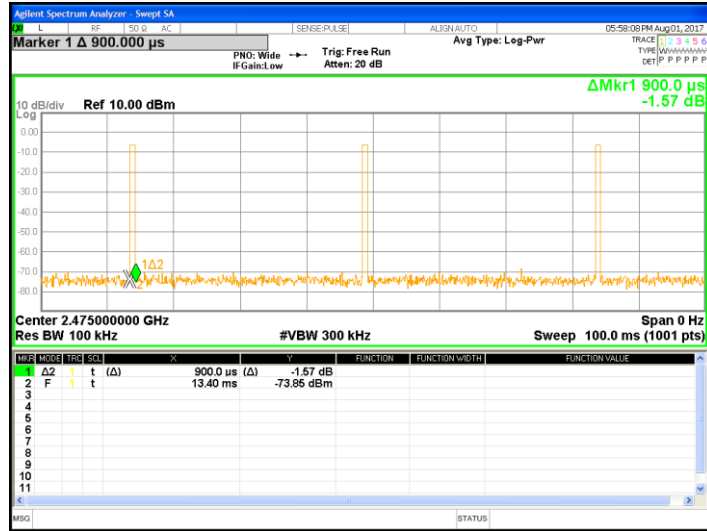

7. HOPPING CHANNEL SEPARATION MEASUREMENT

7.1 APPLIED PROCEDURES / LIMIT

Frequency hopping systems operating in the 2400-2483.5 MHz band may have hopping channel carrier frequencies that are separated by 20 dB bandwidth of the hopping channel, whichever is greater.

Spectrum Parameter	Setting
Attenuation	Auto
Span Frequency	> 20 dB Bandwidth or Channel Separation
RB	30 kHz (20dB Bandwidth) / 30 kHz (Channel Separation)
VB	100 kHz (20dB Bandwidth) / 100 kHz (Channel Separation)
Detector	Peak
Trace	Max Hold
Sweep Time	Auto

7.2 TEST PROCEDURE

- The transmitter output (antenna port) was connected to the spectrum analyser in peak hold mode.
- The resolution bandwidth of 30 kHz and the video bandwidth of 100 kHz were utilised for 20 dB bandwidth measurement.
- The resolution bandwidth of 30 kHz and the video bandwidth of 100 kHz were utilised for channel separation measurement.

7.3 TEST SETUP

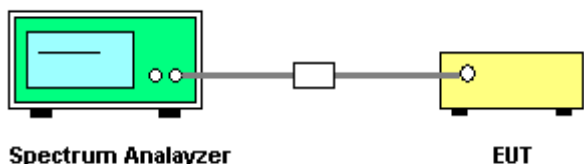

7.4 EUT OPERATION CONDITIONS

The EUT was programmed to be in continuously transmitting mode.



7.5 TEST RESULTS

ANT 1

Temperature:	25°C	Relative Humidity:	50%
Pressure:	1012 hPa	Test Voltage:	DC 12V
Test Mode:	CH00 / CH16 / CH29 (GFSK(1Mbps) Mode)		

Frequency	Ch. Separation (MHz)	Limit	Result
2405 MHz	1.996	1.054	Complies
2447 MHz	1.996	1.054	Complies
2475 MHz	2.004	1.061	Complies

For GFSK: Ch. Separation Limits: > 20dB bandwidth

CH00 -1Mbps

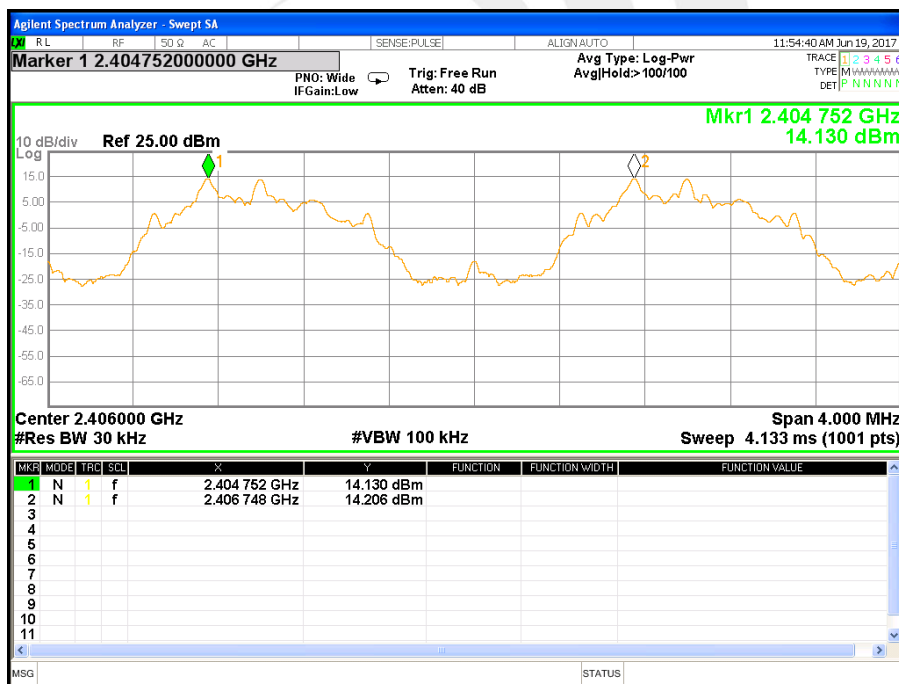



CH16 -1Mbps

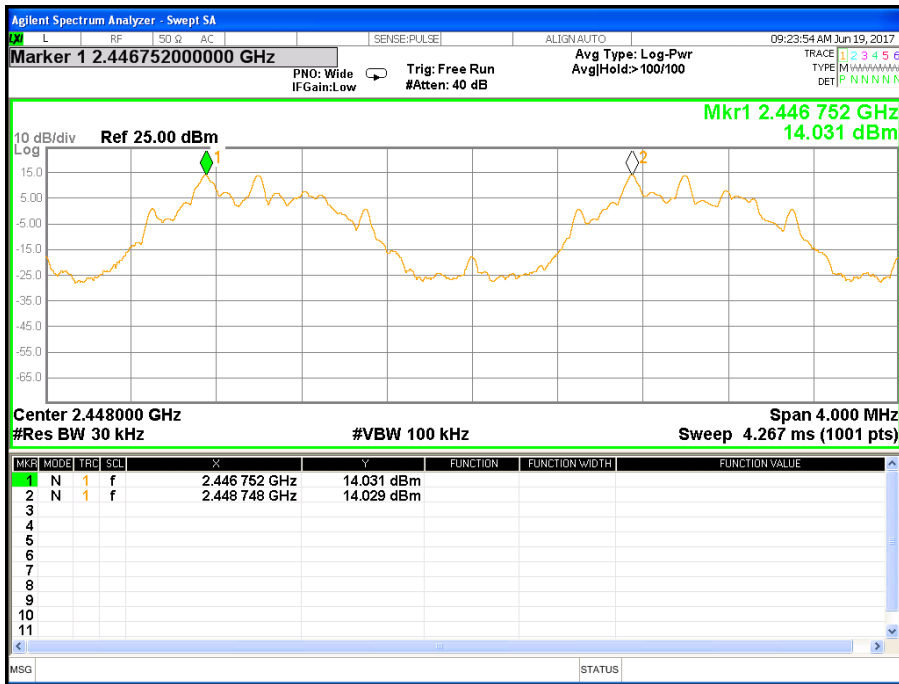

CH29 -1Mbps

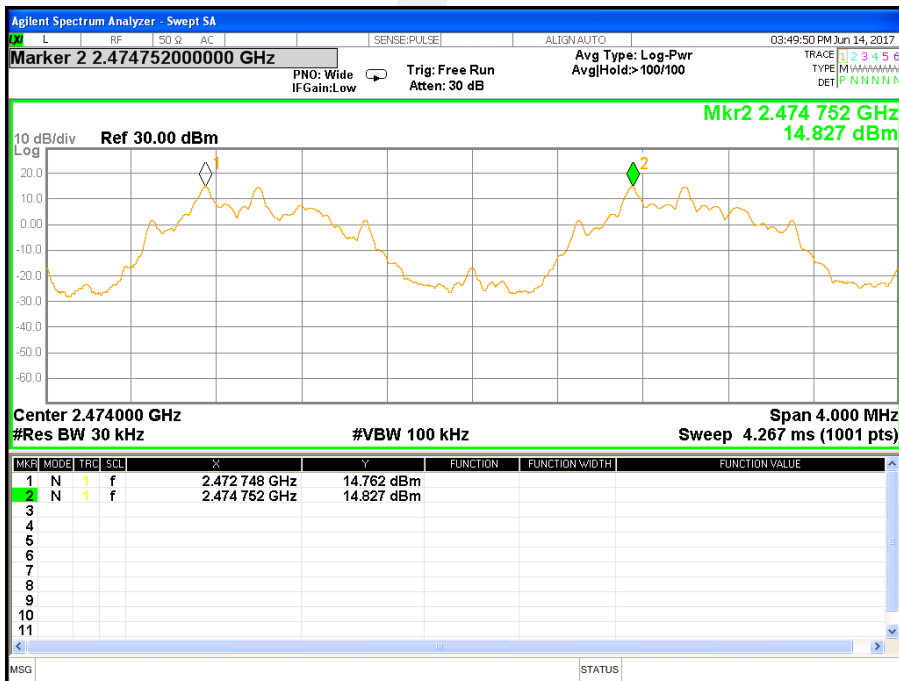



ANT II

Temperature:	25°C	Relative Humidity:	50%
Pressure:	1012 hPa	Test Voltage:	DC 12V
Test Mode:	CH00 / CH16 / CH29 (GFSK(1Mbps) Mode)		

Frequency	Ch. Separation (MHz)	Limit	Result
2405 MHz	2.000	1.052	Complies
2447 MHz	2.004	1.057	Complies
2475 MHz	2.000	1.057	Complies

For GFSK: Ch. Separation Limits: > 20dB bandwidth

CH00 -1Mbps

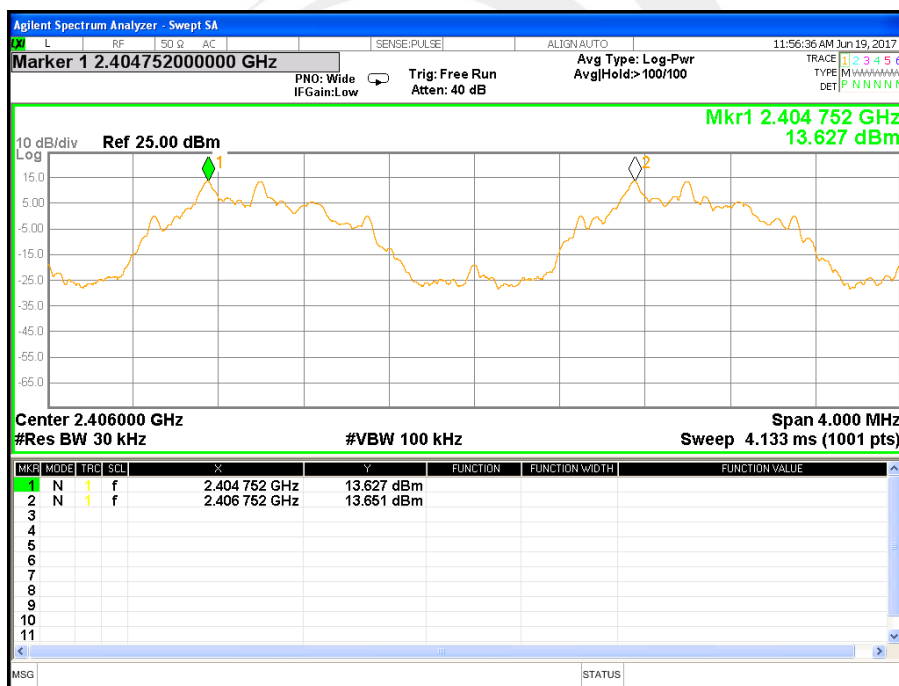



CH16 -1Mbps

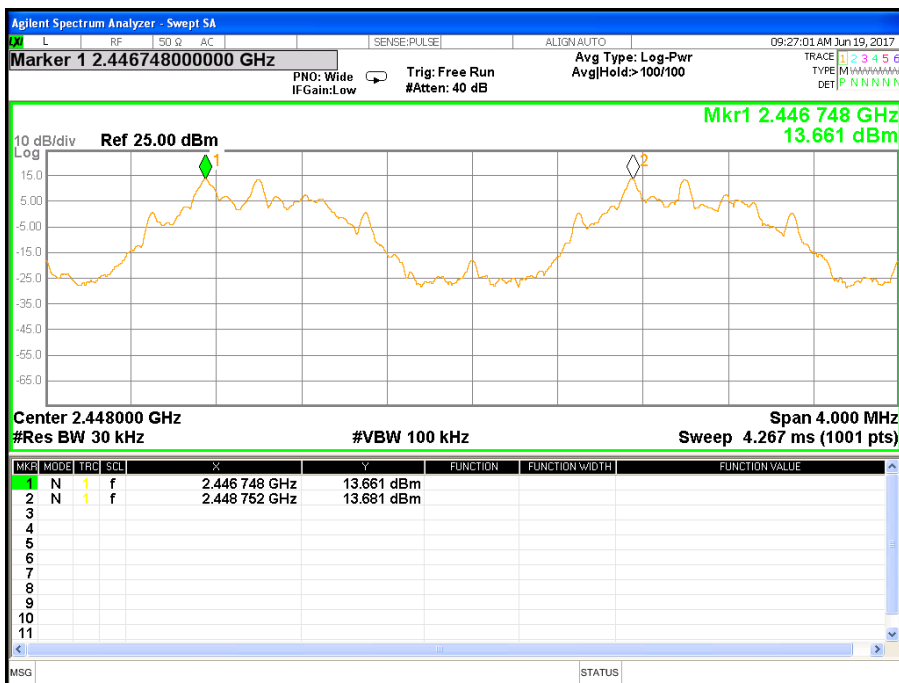

CH29 -1Mbps

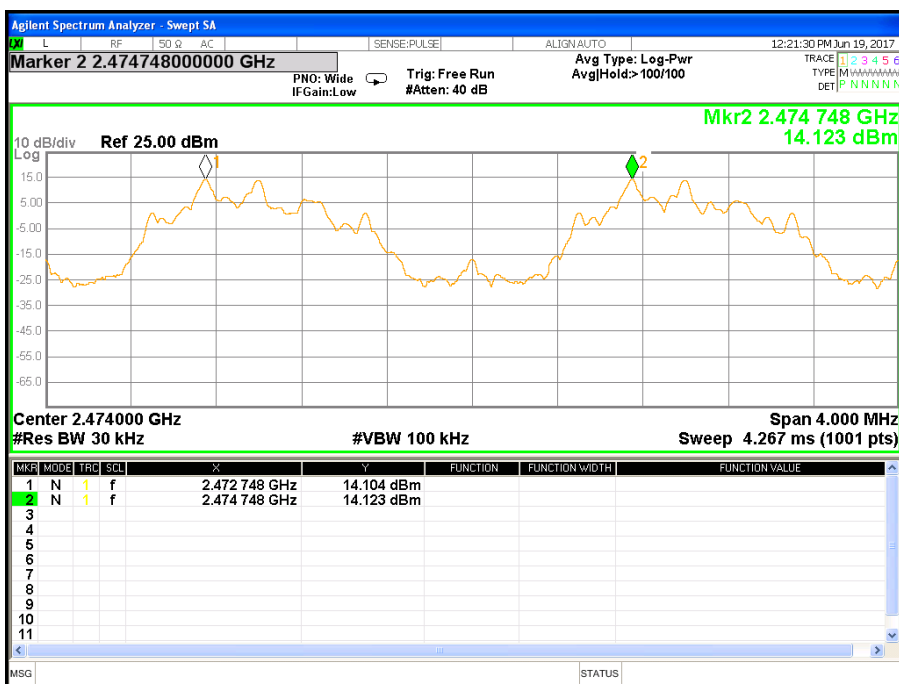



8. BANDWIDTH TEST

8.1 APPLIED PROCEDURES / LIMIT

FCC Part15 15.247,Subpart C				
Section	Test Item	Limit	FrequencyRange (MHz)	Result
15.247 (a)(1)	Bandwidth	(20dB bandwidth)	2405-2475	PASS

Spectrum Parameter	Setting
Attenuation	Auto
Span Frequency	> Measurement Bandwidth or Channel Separation
RB	30 kHz (20dB Bandwidth) / 30 kHz (Channel Separation)
VB	100 kHz (20dB Bandwidth) / 100 kHz (Channel Separation)
Detector	Peak
Trace	Max Hold
Sweep Time	Auto

8.2 TEST PROCEDURE

- The EUT was directly connected to the spectrum analyzer and antenna output port as show in the block diagram below,
- Spectrum Setting : RBW= 30KHz, VBW=100KHz, Sweep time = Auto.

8.3 TEST SETUP



8.4 EUT OPERATION CONDITIONS

The EUT tested system was configured as the statements of 2.4 Unless otherwise a special operating condition is specified in the follows during the testing.



8.5 TEST RESULTS

ANT I

Temperature:	25°C	Relative Humidity:	50%
Pressure:	1012 hPa	Test Voltage:	DC 12V
Test Mode:	GFSK(1Mbps)CH00 / CH15 / C29		

Frequency	20dB Bandwidth (MHz)	Result
2405 MHz	1.054	PASS
2447 MHz	1.054	PASS
2475 MHz	1.061	PASS

CH00 -1Mbps

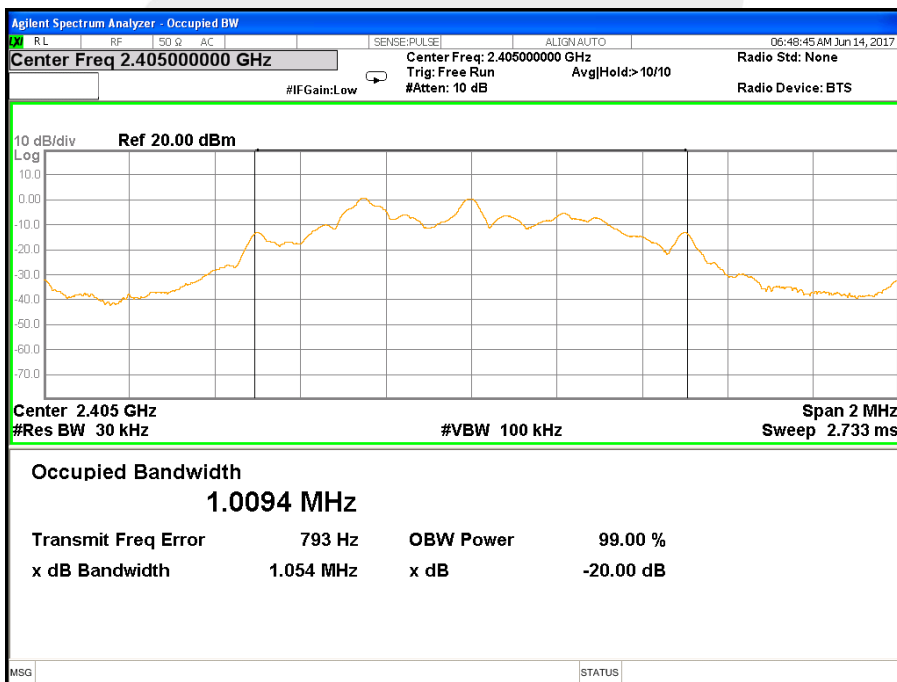



CH15 -1Mbps

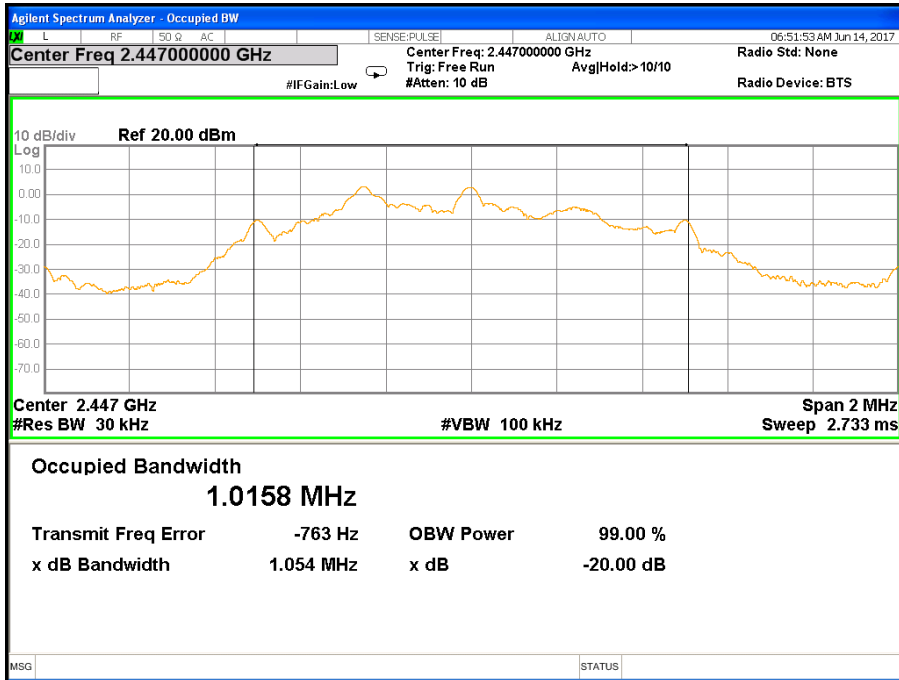

CH29 -1Mbps

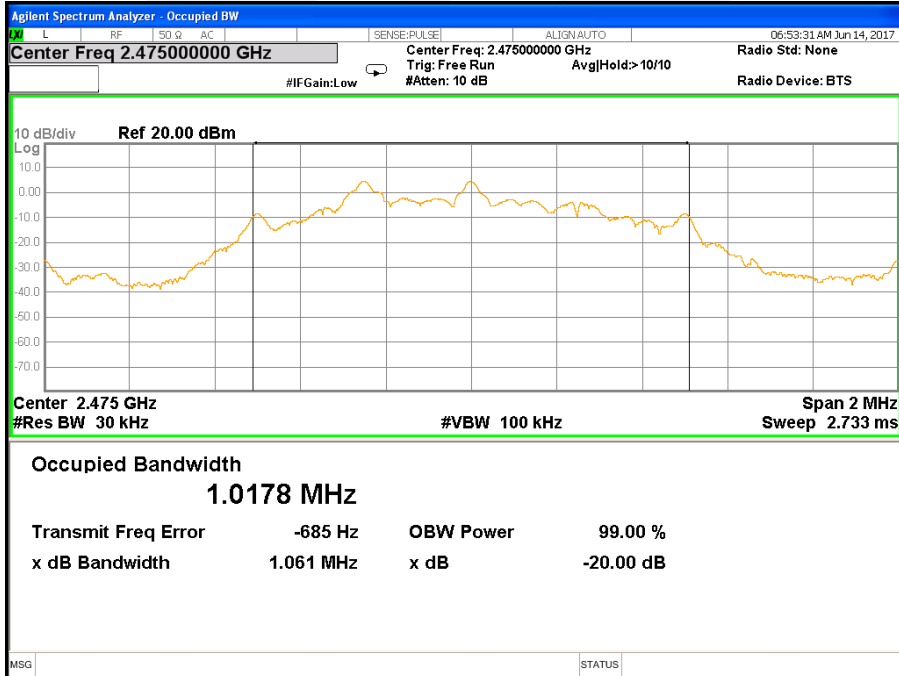



8.5 TEST RESULTS

ANT II

Temperature:	25°C	Relative Humidity:	50%
Pressure:	1012 hPa	Test Voltage:	DC 12V
Test Mode:	GFSK(1Mbps)CH00 / CH15 / C29		

Frequency	20dB Bandwidth (MHz)	Result
2405 MHz	1.052	PASS
2447 MHz	1.057	PASS
2475 MHz	1.057	PASS

CH00 -1Mbps

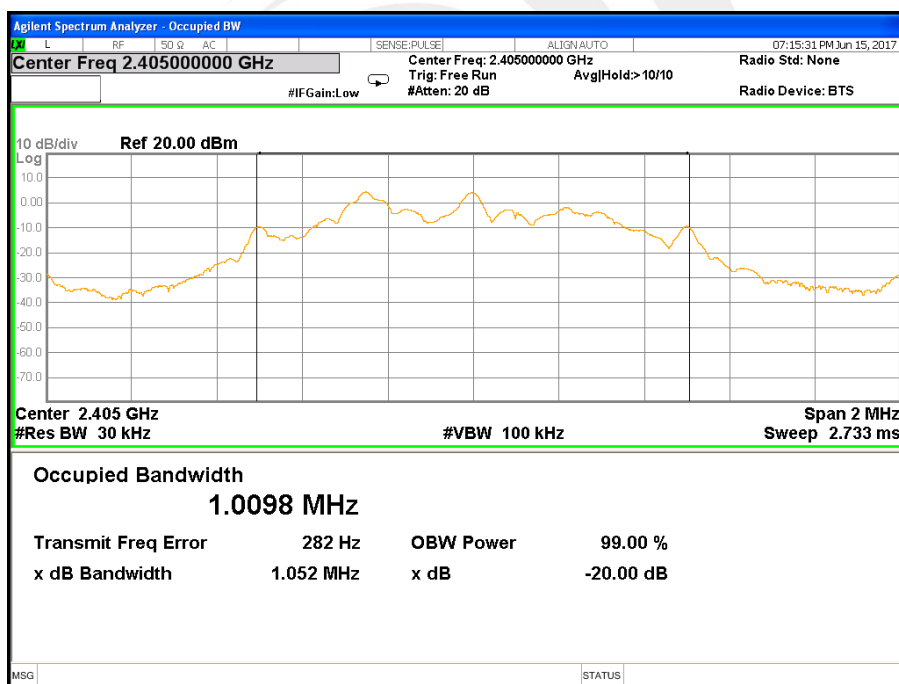



CH15 -1Mbps

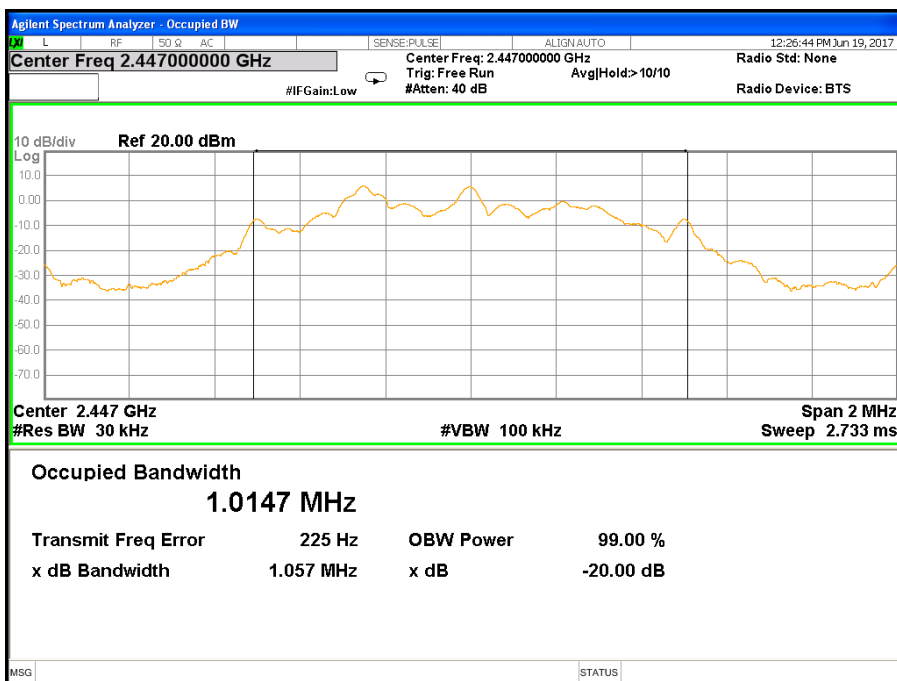

CH29 -1Mbps

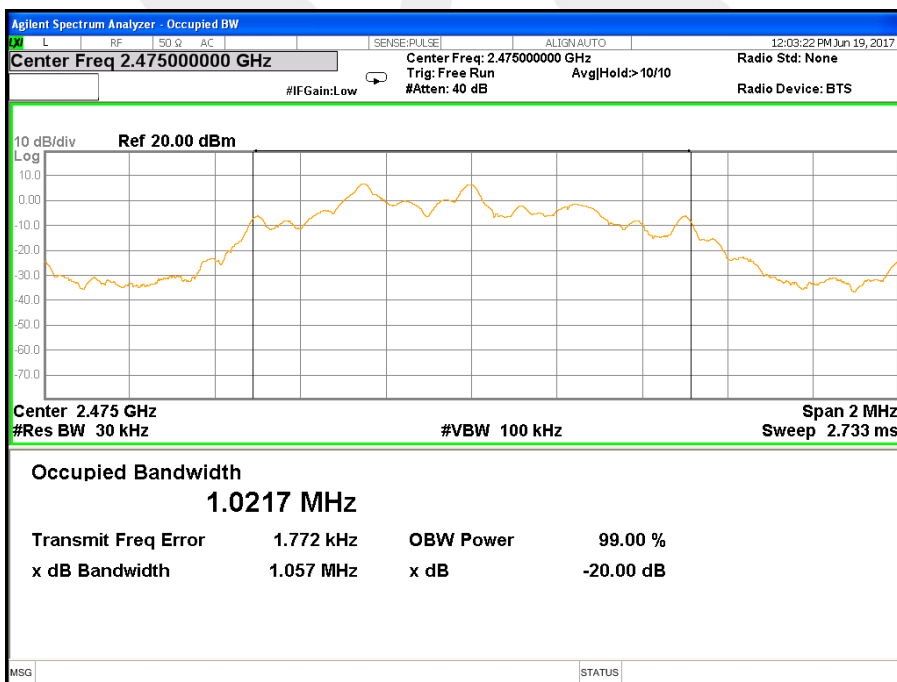



9. OUTPUT POWER TEST

9.1 APPLIED PROCEDURES / LIMIT

FCC Part 15.247, Subpart C				
Section	Test Item	Limit	Frequency Range (MHz)	Result
15.247 (a)(1)&(b)(1)	Output Power	1 W or 0.125W	2405-2475	PASS
		if channel separation > 2/3 bandwidth provided the systems operate with an output power no greater than 125 mW (20.96dBm)		

9.2 TEST PROCEDURE

- a. The EUT was directly connected to the Power Sensor & PC

9.3 TEST SETUP



9.4 EUT OPERATION CONDITIONS

The EUT tested system was configured as the statements of 2.4 Unless otherwise a special operating condition is specified in the follows during the testing.



9.5 TEST RESULTS

ANT I

Temperature:	25°C	Relative Humidity:	60%
Pressure:	1012 hPa	Test Voltage:	DC 12V

GFSK(1Mbps)				
Test Channel	Frequency	Conducted Output Power		LIMIT
	(MHz)	Peak (dBm)	AVG (dBm)	dBm
CH00	2405	17.82	11.93	30
CH15	2447	17.88	12.01	30
CH29	2475	17.91	12.06	30

ANT II

Temperature:	25°C	Relative Humidity:	60%
Pressure:	1012 hPa	Test Voltage:	DC 12V

GFSK(1Mbps)				
Test Channel	Frequency	Conducted Output Power		LIMIT
	(MHz)	Peak (dBm)	AVG (dBm)	dBm
CH00	2405	17.61	11.73	30
CH15	2447	17.75	11.89	30
CH29	2475	17.86	11.96	30

Note:the channel separation > bandwidth



10. ANTENNA REQUIREMENT

10.1 STANDARD REQUIREMENT

15.203 requirement: For intentional device, according to 15.203: an intentional radiator shall be designed to ensure that no antenna other than that furnished by the responsible party shall be used with the device.

10.2 EUT ANTENNA

The EUT antenna is Fixed Internal Antenna. It comply with the standard requirement.





APPENDIX-PHOTOS OF TEST SETUP

Radiated Measurement Photos

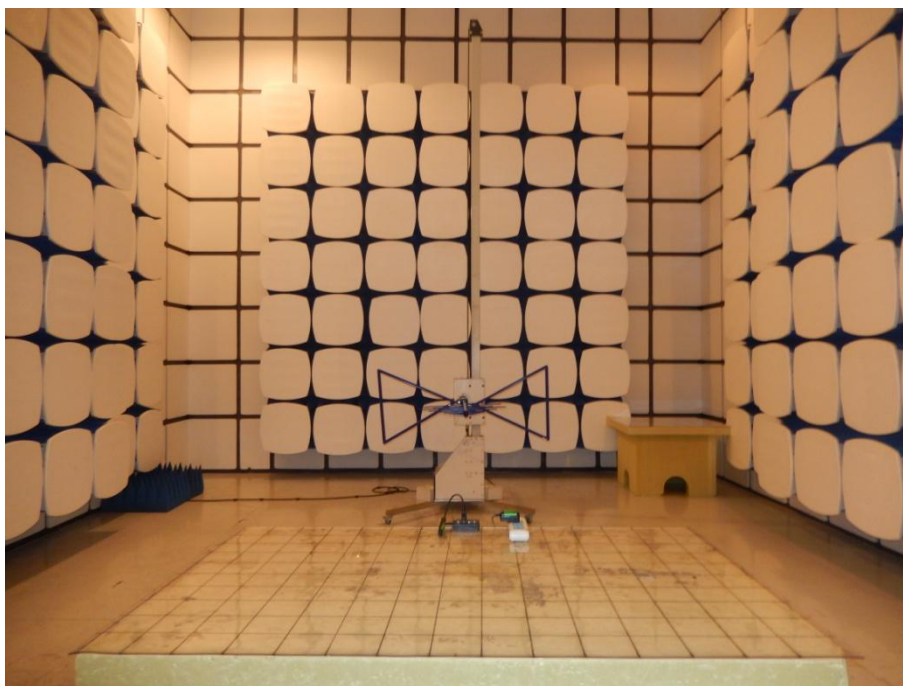



Conducted Measurement Photos



*****END OF THE REPORT*****