



RADIO TESTREPORT

Report No: STS1705175F01

Issued for

FrSky Electronic Co., Ltd.

F-4, Building C, Zhongxiu Technology Park, No.3 Yuanxi Road, Wuxi, 214125, Jiangsu, China

Product Name:	900MHz receiver
Brand Name:	N/A
Model Name:	R9
Series Model:	R9S,R9D
FCC ID:	XYFR9S09R
Test Standard:	FCC Part 15.247

Any reproduction of this document must be done in full. No single part of this document may be reproduced without permission from BZT, All Test Data Presented in this report is only applicable to presented Test sample.

BZT Testing Technology Co., Ltd

Add. : Bulding 17, Xinghua Road Xingwei industrial Park Fuyong,
Baoan District, Shenzhen, Guangdong, China

TEL: +86-755 3307 1680 FAX: +86-755 27341758 E-mail:bruce@bzt.Cn



TEST RESULT CERTIFICATION

Applicant's name.....: FrSky Electronic Co., Ltd.
Address.....: F-4, Building C, Zhongxiu Technology Park, No.3 Yuanxi Road, Wuxi, 214125, Jiangsu, China
Manufacture's Name: FrSky Electronic Co., Ltd
Address.....: F-4, Building C, Zhongxiu Technology Park, No.3 Yuanxi Road, Wuxi, 214125, Jiangsu, China

Product description

Product name.....: 900MHz receiver
Brand name.....: N/A
Model and/or type reference .: R9
Series Model: R9S, R9D

Standards: FCC Part15.247
Test procedure: ANSI C63.10-2013

This device described above has been tested by BZT the test results show that the equipment under test (EUT) is in compliance with the FCC requirements. And it is applicable only to the tested sample identified in the report.

This report shall not be reproduced except in full, without the written approval of STS, this document may be altered or revised by STS, personal only, and shall be noted in the revision of the document

Date of Test.....:
Date (s) of performance of tests : 24 May. 2017~13 Jun. 2017
Date of Issue: 15 Jun. 2017
Test Result: Pass

Testing Engineer : Sean She
(Sean she)

Technical Manager : hakim.hou
(Hakim.hou)

Authorized Signatory : Vita Li
(Vita Li)





Table of Contents	Page
1. SUMMARY OF TEST RESULTS	6
1.1 TEST FACTORY	7
1.2 MEASUREMENT UNCERTAINTY	7
2. GENERAL INFORMATION	8
2.1 GENERAL DESCRIPTION OF EUT	8
2.2 DESCRIPTION OF TEST MODES	10
2.3 BLOCK DIGRAM SHOWING THE CONFIGURATION OF SYSTEM TESTED	10
2.4 DESCRIPTION OF SUPPORT UNITS	11
2.5 EQUIPMENTS LIST FOR ALL TEST ITEMS	12
3.EMC EMISSION TEST	13
3.1 CONDUCTED EMISSION MEASUREMENT	13
3.2 RADIATED EMISSION MEASUREMENT	17
4. CONDUCTED SPURIOUS & BAND EDGE EMISSION	28
4.1 REQUIREMENT	28
4.2 TEST PROCEDURE	28
4.3 TEST SETUP	28
4.4 EUT OPERATION CONDITIONS	28
4.5 TEST RESULTS	29
5. NUMBER OF HOPPING CHANNEL	33
5.1 APPLIED PROCEDURES / LIMIT	33
5.2 TEST PROCEDURE	33
5.3 TEST SETUP	33
5.4 EUT OPERATION CONDITIONS	33
5.5 TEST RESULTS	34
6. AVERAGE TIME OF OCCUPANCY	35
6.1 APPLIED PROCEDURES / LIMIT	35
6.3 TEST SETUP	35
6.4 EUT OPERATION CONDITIONS	35
6.5 TEST RESULTS	36
7. HOPPING CHANNEL SEPARATION MEASUREMENT	39
7.1 APPLIED PROCEDURES / LIMIT	39
7.2 TEST PROCEDURE	39
7.3 TEST SETUP	39



Table of Contents	Page
7.4 EUT OPERATION CONDITIONS	39
7.5 TEST RESULTS	40
8. BANDWIDTH TEST	42
8.1 APPLIED PROCEDURES / LIMIT	42
8.2 TEST PROCEDURE	42
8.3 TEST SETUP	42
8.4 EUT OPERATION CONDITIONS	42
8.5 TEST RESULTS	43
9. OUTPUT POWER TEST	45
9.1 APPLIED PROCEDURES / LIMIT	45
9.2 TEST PROCEDURE	45
9.3 TEST SETUP	45
9.4 EUT OPERATION CONDITIONS	45
9.5 TEST RESULTS	46
10. ANTENNA REQUIREMENT	47
10.1 STANDARD REQUIREMENT	47
10.2 EUT ANTENNA	47



Revision History

Rev.	Issue Date	Report NO.	Effect Page	Contents
00	15 Jun. 2017	STS1705175F01	ALL	Initial Issue





1. SUMMARY OF TEST RESULTS

Test procedures according to the technical standards: DA 00-705

FCC Part 15.247, Subpart C			
Standard Section	Test Item	Judgment	Remark
15.207	Conducted Emission	PASS	--
15.247(a)	Hopping Channel Separation	PASS	--
15.247(a) &(b)	Output Power	PASS	--
15.247(c)	Radiated Spurious Emission	PASS	--
15.247(d)	Conducted Spurious & Band Edge Emission	PASS	--
15.247(a)	Number of Hopping Frequency	PASS	--
15.247(a)	Dwell Time	PASS	--
15.247(a)	Bandwidth	PASS	--
15.205	Restricted Band Edge Emission	PASS	--
Part 15.247(d)/part 15.209(a)	Band Edge Emission	PASS	--
15.203	Antenna Requirement	PASS	--

NOTE:

(1) "N/A" denotes test is not applicable in this Test Report

(2) All tests are according to ANSI C63.10-2013



1.1 TEST FACTORY

BZT Testing Technology Co., Ltd.
Add. : Buliding 17, Xinghua Road Xingwei industrial Park Fuyong,
Baoan District, Shenzhen, Guangdong, China
FCC Registration No.: 701733

1.2 MEASUREMENT UNCERTAINTY

The reported uncertainty of measurement $y \pm U$, where expended uncertainty U is based on a standard uncertainty multiplied by a coverage factor of $k=2$, providing a level of confidence of approximately **95 %**.

No.	Item	Uncertainty
1	Conducted Emission (9KHz-150KHz)	$\pm 2.88\text{dB}$
2	Conducted Emission (150KHz-30MHz)	$\pm 2.67\text{dB}$
3	RF power,conducted	$\pm 0.70\text{dB}$
4	Spurious emissions,conducted	$\pm 1.19\text{dB}$
5	All emissions,radiated (9KHz-30MHz)	$\pm 2.45\text{dB}$
6	All emissions,radiated (30MHz-200MHz)	$\pm 2.83\text{dB}$
7	All emissions,radiated (200MHz-1000MHz)	$\pm 2.94\text{dB}$
8	All emissions,radiated(>1G)	$\pm 3.03\text{dB}$
9	Temperature	$\pm 0.5^{\circ}\text{C}$
10	Humidity	$\pm 2\%$



2. GENERAL INFORMATION

2.1 GENERAL DESCRIPTION OF EUT

Equipment	900MHz receiver
Trade Name	N/A
Model Name	R9
Series Model	R9S, R9D
Model Difference	Only different in model name.
Channel List	Please refer to the Note 2.
Frequency& Modulation	Frequency:904– 925 MHz Modulation: GFSK
Power rating	DC 5V
Hardware version number	V3
Software version number	V 1.0
Connecting I/O Port(s)	Please refer to the User's Manual

Note:

1. For a more detailed features description, please refer to the manufacturer's specifications or the User's Manual.



2.

Channel List					
Channel	Frequency (MHz)	Channel	Frequency (MHz)	Channel	Frequency (MHz)
01	904	17	912	32	919.5
02	904.5	18	912.5	33	920
03	905	19	913	34	920.5
04	905.5	20	913.5	35	921
05	906	21	914	36	921.5
06	906.5	22	914.5	37	922
07	907	23	915	38	922.5
08	907.5	24	915.5	39	923
09	908	25	916	40	923.5
10	908.5	26	916.5	41	924
11	909	27	917	42	924.5
12	909.5	28	917.5	43	925
13	910	29	918		
14	910.5	30	918.5		
15	911	31	919		
16	911.5	32	919.5		

3. Table for Filed Antenna

Ant	Brand	Model Name	Antenna Type	Connector	Gain (dBi)	NOTE
1	N/A	R9	FPC	N/A	2	Antenna

Note :

Antenna number : 2

Antenna 1 and Antenna 2 can not transmit simultaneously



2.2 DESCRIPTION OF TEST MODES

To investigate the maximum EMI emission characteristics generates from EUT, the test system was pre-scanning tested base on the consideration of following EUT operation mode or test configuration mode which possible have effect on EMI emission level. Each of these EUT operation mode(s) or test configuration mode(s) mentioned above was evaluated respectively.

Worst Mode	Description	Data Rate/Modulation
Mode 1	TX CH01	1Mbps/ Lora™
Mode 2	TX CH22	1Mbps/ Lora™
Mode 3	TX CH43	1Mbps/ Lora™

Note:

- (1) The measurements are performed at all Bit Rate of Transmitter, the worst data was reported
- (2) We have be tested for all avaiable U.S. voltage and frequencies(For 120V,60Hz) for which the device is capable of operation.

For AC Conducted Emission

Test Case	
AC Conducted Emission	Mode 4 : Keeping TX

2.3 BLOCK DIGRAM SHOWING THE CONFIGURATION OF SYSTEM TESTED

During testing channel & power controlling software provided by the customer was used to control the operating channel as well as the output power level. The RF output power selection is for the setting of RF output power expected by the customer and is going to be fixed on the firmware of the final end product power parameters of FHSS

Radiated Spurious EmissionTest

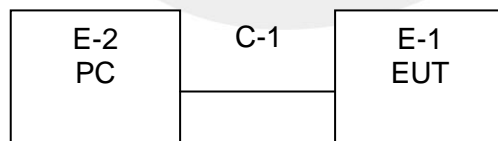

Conducted Emission Test

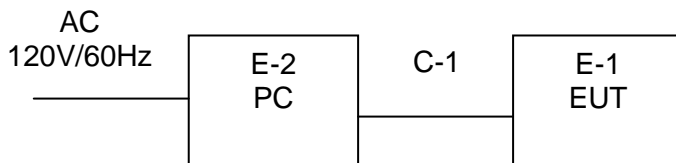



2.4 DESCRIPTION OF SUPPORT UNITS

The EUT has been tested as an independent unit together with other necessary accessories or support units. The following support units or accessories were used to form a representative test configuration during the tests.

Item	Equipment	Mfr/Brand	Model/Type No.	Serial No.	Note
E-1	900MHz receiver	N/A	R9	N/A	EUT
E-2	PC	HP	500-320cx	N/A	N/A

Item	Shielded Type	Ferrite Core	Length	Note
C-1	USB Cable shielded line (Charging)	NO	100cm	N/A

Note:

- (1) The support equipment was authorized by Declaration of Confirmation.
- (2) For detachable type I/O cable should be specified the length in cm in 『Length』 column.
- (3) “YES” is means “shielded” “with core”; “NO” is means “unshielded” “without core”.



2.5 EQUIPMENTS LIST FOR ALL TEST ITEMS

Radiation Test equipment

Kind of Equipment	Manufacturer	Type No.	Serial No.	Last calibration	Calibrated until
Spectrum Analyzer	Agilent	E4407B	MY50140340	2016.10.23	2017.10.22
Test Receiver	R&S	ESCI	101427	2016.10.23	2017.10.22
Bilog Antenna	TESEQ	CBL6111D	34678	2014.11.24	2017.11.23
Horn Antenna	Schwarzbeck	BBHA 9120D(1201)	9120D-1343	2015.03.05	2018.03.04
Horn Antenna	Schwarzbeck	BBHA 9170	9170-0741	2016.03.06	2019.03.05
50Ω Coaxial Switch	Anritsu	MP59B	6200264416	2016.10.23	2017.10.22
PreAmplifier	Agilent	8449B	60538	2016.10.23	2017.10.22
Loop Antenna	EMCO	6502	9003-2485	2016.03.06	2019.03.05
Preamplifier	Agilent	8449B	60538	2016.10.23	2017.10.22
Low frequency cable	EM	R01	N/A	NCR	NCR
High frequency cable	SCHWARZBECK	AK9515H	SN-96286/96287	NCR	NCR
Semi-anechoic chamber	Changling	966	N/A	2016.10.23	2017.10.22

Conduction Test equipment

Kind of Equipment	Manufacturer	Type No.	Serial No.	Last calibration	Calibrated until
EMI Test Receiver	R&S	ESPI	102086	2016.10.23	2017.10.22
LISN	R&S	ENV216	101242	2016.10.23	2017.10.22
LISN	EMCO	3810/2NM	000-23625	2016.10.23	2017.10.22
Conduction Cable	EM	C01	N/A	NCR	NCR
Shielding Room	Changling	854	N/A	2016.10.23	2017.10.22

RF Connected Test

Kind of Equipment	Manufacturer	Type No.	Serial No.	Last calibration	Calibrated until
USB RF power sensor	DARE	RPR3006W	15I00041SNO03	2016.10.23	2017.10.22
Spectrum Analyzer	Agilent	E4407B	MY50140340	2016.10.23	2017.10.22
Signal Analyzer	Agilent	N9020A	MY49100060	2016.10.23	2017.10.22

Note: The temporary antenna connector is soldered on the PCB board in order to perform conducted tests and this temporary antenna connector is listed in the equipment list.



3. EMC EMISSION TEST

3.1 CONDUCTED EMISSION MEASUREMENT

3.1.1 POWER LINE CONDUCTED EMISSION LIMITS

Operating frequency band. In case the emission fall within the restricted band specified on Part 207(a) limit in the table below has to be followed.

FREQUENCY (MHz)	Conducted Emission limit (dBuV)	
	Quasi-peak	Average
0.15 -0.5	66 - 56 *	56 - 46 *
0.50 -5.0	56.00	46.00
5.0 -30.0	60.00	50.00

Note:

- (1) The tighter limit applies at the band edges.
- (2) The limit of " * " marked band means the limitation decreases linearly with the logarithm of the frequency in the range.

The following table is the setting of the receiver

Receiver Parameters	Setting
Attenuation	10 dB
Start Frequency	0.15 MHz
Stop Frequency	30 MHz
IF Bandwidth	9 kHz

3.1.2 TEST PROCEDURE

- a. The EUT was 0.8 meters from the horizontal ground plane and 0.4 meters from the vertical ground plane with EUT being connected to the power mains through a line impedance stabilization network (LISN). All other support equipments powered from additional LISN(s). The LISN provide 50 Ohm/ 50uH of coupling impedance for the measuring instrument.
- b. Interconnecting cables that hang closer than 40 cm to the ground plane shall be folded back and forth in the center forming a bundle 30 to 40 cm long.
- c. I/O cables that are not connected to a peripheral shall be bundled in the center. The end of the cable may be terminated, if required, using the correct terminating impedance. The overall length shall not exceed 1 m.
- d. LISN at least 80 cm from nearest part of EUT chassis.
- e. For the actual test configuration, please refer to the related Item –EUT Test Photos.

3.1.3 TEST SETUP

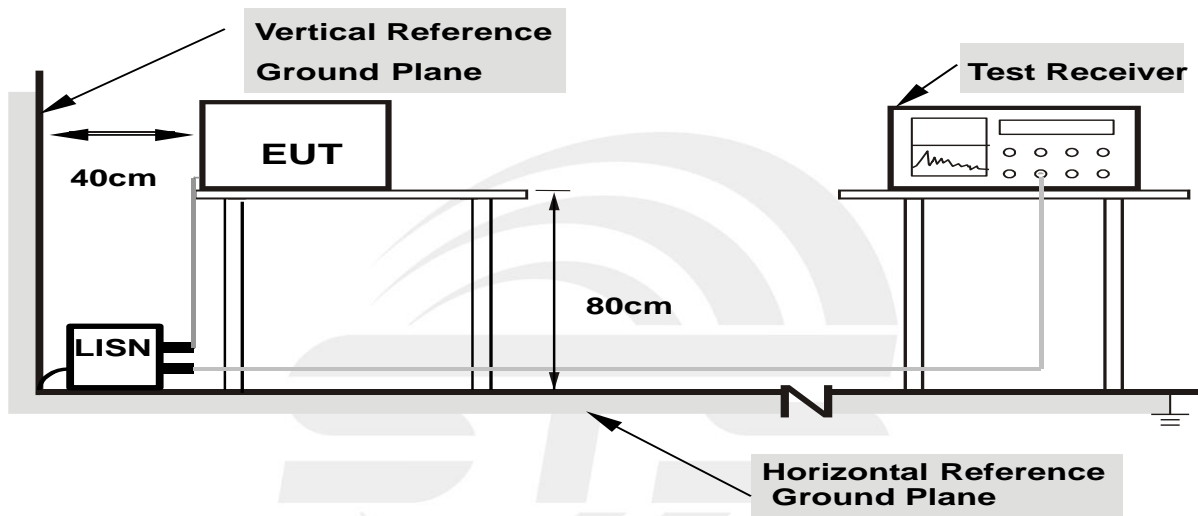

**Note: 1.Support units were connected to second LISN.
 2.Both of LISNs (AMN) are 80 cm from EUT and at least 80 from other units and other metal planes**

3.1.4 EUT OPERATING CONDITIONS

The EUT was configured for testing in a typical fashion (as a customer would normally use it). The EUT has been programmed to continuously transmit during test. This operating condition was tested and used to collect the included data.



3.1.5 TEST RESULT

Temperature:	23.1 °C	Relative Humidity:	61%
Pressure:	1010hPa	Phase:	L
Test Voltage:	AC 120V/60Hz	Test Mode:	Model 4

Frequency (MHz)	Reading (dBuV)	Correct Factor(dB)	Result (dBuV)	Limit (dBuV)	Margin (dB)	Remark
0.1620	48.33	9.78	58.11	65.36	-7.25	QP
0.1620	24.98	9.78	34.76	55.36	-20.60	AVG
0.2580	34.24	10.10	44.34	61.50	-17.16	QP
0.2580	15.48	10.10	25.58	51.50	-25.92	AVG
0.5140	23.43	9.97	33.40	56.00	-22.60	QP
0.5140	10.16	9.97	20.13	46.00	-25.87	AVG
2.6980	19.69	9.90	29.59	56.00	-26.41	QP
2.6980	7.48	9.90	17.38	46.00	-28.62	AVG
3.5980	25.68	9.93	35.61	56.00	-20.39	QP
3.5980	9.21	9.93	19.14	46.00	-26.86	AVG
9.7700	30.55	9.93	40.48	60.00	-19.52	QP
9.7700	19.16	9.93	29.09	50.00	-20.91	AVG

Remark:

1. All readings are Quasi-Peak and Average values.
2. Margin = Result (Result =Reading + Factor)–Limit
- 3.ANT 1 and ANT 2 mode all have been tested ,only worse case is reported

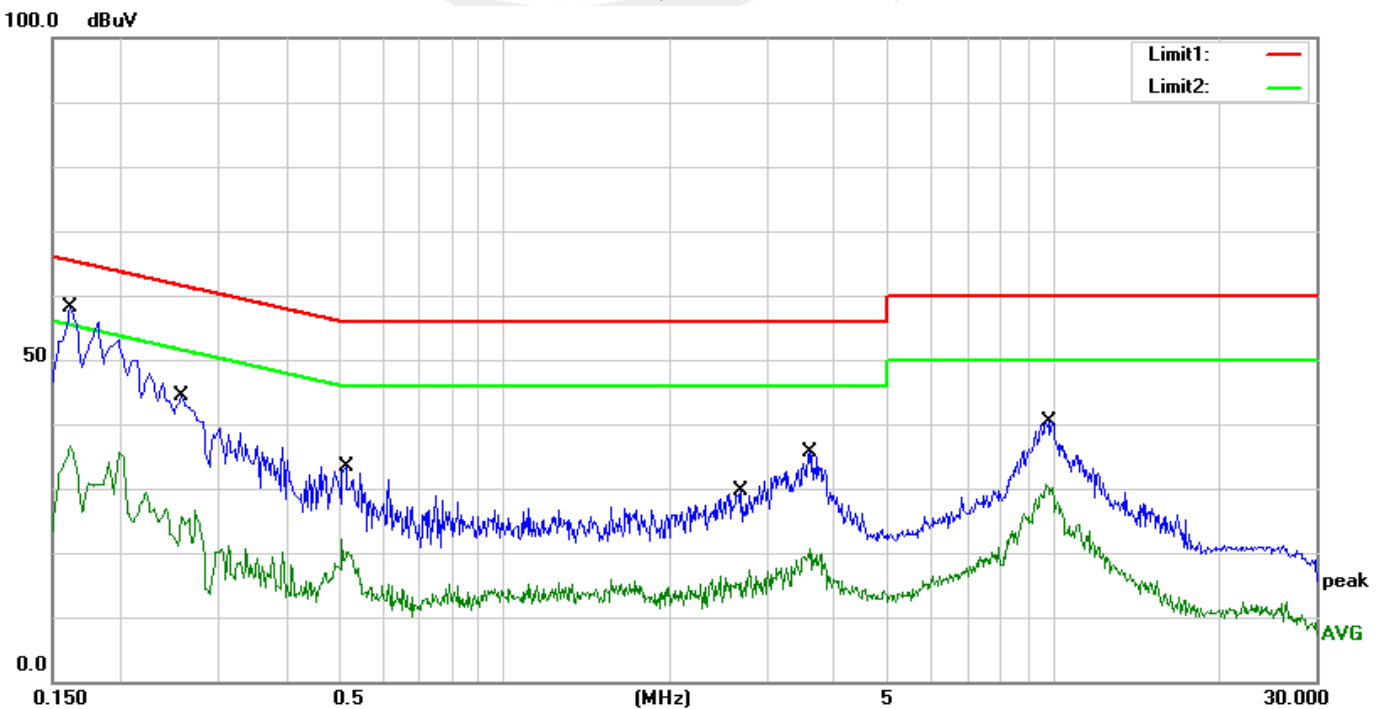



Temperature:	23.1 °C	Relative Humidity:	61%
Pressure:	1010hPa	Phase:	N
Test Voltage:	AC 120V/60Hz	Test Mode:	Model 4

Frequency (MHz)	Reading (dBuV)	Correct Factor(dB)	Result (dBuV)	Limit (dBuV)	Margin (dB)	Remark
0.1500	47.92	9.75	57.67	66.00	-8.33	QP
0.1500	24.80	9.75	34.55	56.00	-21.45	AVG
0.2300	40.59	9.99	50.58	62.45	-11.87	QP
0.2300	11.32	9.99	21.31	52.45	-31.14	AVG
0.4980	25.87	9.98	35.85	56.03	-20.18	QP
0.4980	9.83	9.98	19.81	46.03	-26.22	AVG
2.6180	22.25	9.90	32.15	56.00	-23.85	QP
2.6180	7.77	9.90	17.67	46.00	-28.33	AVG
3.6300	26.71	9.93	36.64	56.00	-19.36	QP
3.6300	9.55	9.93	19.48	46.00	-26.52	AVG
9.6700	31.56	9.93	41.49	60.00	-18.51	QP
9.6700	18.50	9.93	28.43	50.00	-21.57	AVG

Remark:

1. All readings are Quasi-Peak and Average values.
2. Margin = Result (Result =Reading + Factor)–Limit
3. ANT 1 and ANT 2 mode all have been tested ,only worse case is reported

100.0 dBuV

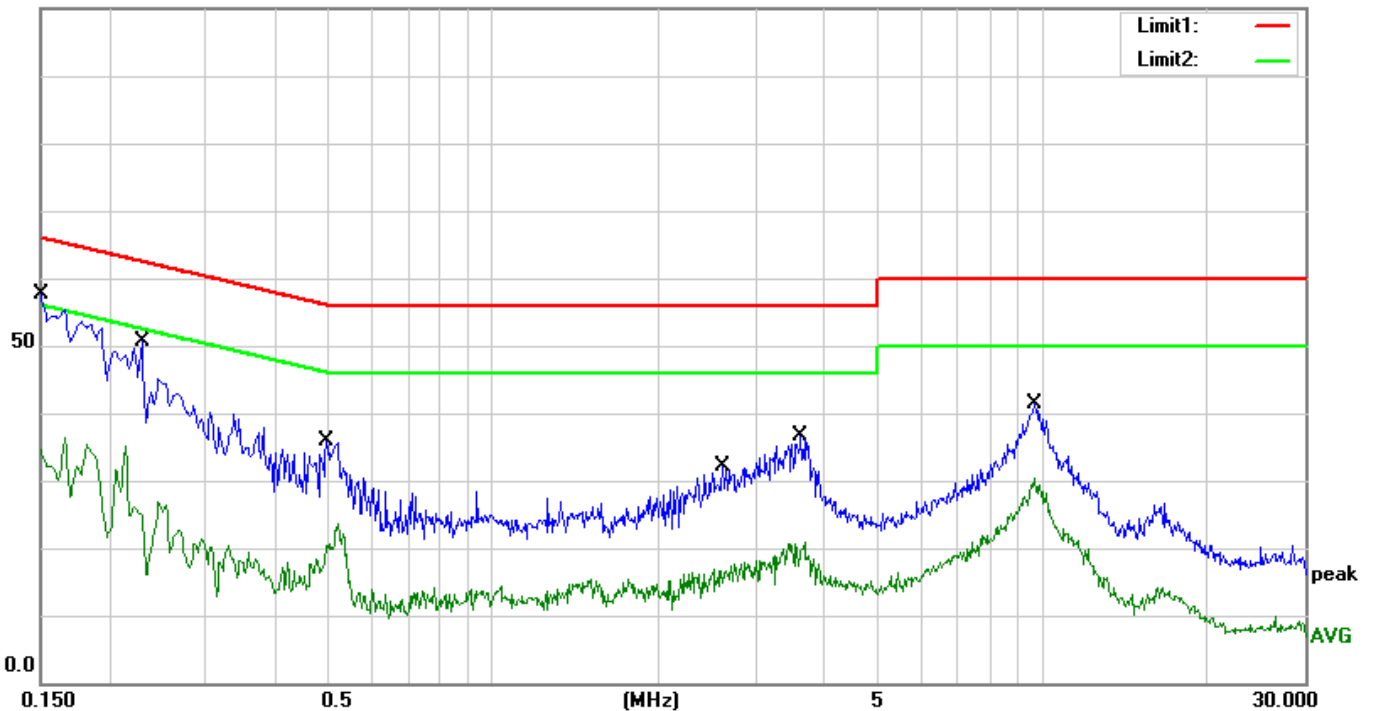



3.2 RADIATED EMISSION MEASUREMENT

3.2.1 RADIATED EMISSION LIMITS

in any 100 kHz bandwidth outside the operating frequency band. In case the emission fall within the Restricted band specified on Part15.205(a)&209(a) limit in the table and according to ANSI C63.10-2013 below has to be followed

LIMITS OF RADIATED EMISSION MEASUREMENT (0.009MHz - 1000MHz)

Frequencies (MHz)	Field Strength (micorvolts/meter)	Measurement Distance (meters)
0.009~0.490	2400/F(KHz)	300
0.490~1.705	24000/F(KHz)	30
1.705~30.0	30	30
30~88	100	3
88~216	150	3
216~960	200	3
Above 960	500	3

LIMITS OF RADIATED EMISSION MEASUREMENT (1GHz-25 GHz)

FREQUENCY (MHz)	(dBuV/m) (at 3M)	
	PEAK	AVERAGE
Above 1000	74	54

Notes:

- (1) The limit for radiated test was performed according to FCC PART 15C.
- (2) The tighter limit applies at the band edges.
- (3) Emission level (dBuV/m)=20log Emission level (uV/m).

For Radiated Emission

Spectrum Parameter	Setting
Attenuation	Auto
Detector	Peak
Start Frequency	1000 MHz(Peak/AV)
Stop Frequency	10th carrier hamonic(Peak/AV)
RB / VB (emission in restricted band)	PK=1MHz / 1MHz, AV=1 MHz / 10 Hz

For Band edge

Spectrum Parameter	Setting
Detector	Peak
Start/Stop Frequency	Lower Band Edge: 800 to 906 MHz Upper Band Edge: 923 to 1000 MHz
RB / VB (emission in restricted band)	PK=1MHz / 1MHz, AV=1 MHz / 10 Hz



Receiver Parameter	Setting
Start ~ Stop Frequency	9kHz~90kHz / RB 200Hz for PK & AV
Start ~ Stop Frequency	90kHz~110kHz / RB 200Hz for QP
Start ~ Stop Frequency	110kHz~490kHz / RB 200Hz for PK & AV
Start ~ Stop Frequency	490kHz~30MHz / RB 9kHz for QP
Start ~ Stop Frequency	30MHz~1000MHz / RB 120kHz for QP

3.2.2 TEST PROCEDURE

- The measuring distance of at 3 m shall be used for measurements at frequency 0.009MHz up to 1GHz, and above 1GHz.
- The EUT was placed on the top of a rotating table 0.8 meters (above 1GHz is 1.5 m) above the ground at a 3 meter anechoic chamber test site. The table was rotated 360 degrees to determine the position of the highest radiation.
- The height of the equipment shall be 0.8 m (above 1GHz is 1.5 m); the height of the test antenna shall vary between 1 m to 4 m. horizontal and vertical polarizations of the antenna are set to make the measurement.
- The initial step in collecting conducted emission data is a spectrum analyzer peak detector mode pre-scanning the measurement frequency range. Significant peaks are then marked and then QuasiPeak detector mode re-measured.
- If the Peak Mode measured value compliance with and lower than Quasi Peak Mode Limit, the EUT shall be deemed to meet QP Limits and then no additional QP Mode measurement performed.
- For the actual test configuration, please refer to the related Item –EUT Test Photos.

Note:

Both horizontal and vertical antenna polarities were tested and performed pretest to three orthogonal axis. The worst case emissions were reported

3.2.3 DEVIATION FROM TEST STANDARD

No deviation

3.2.4 TESTSETUP

(A) Radiated Emission Test-Up Frequency Below 30MHz

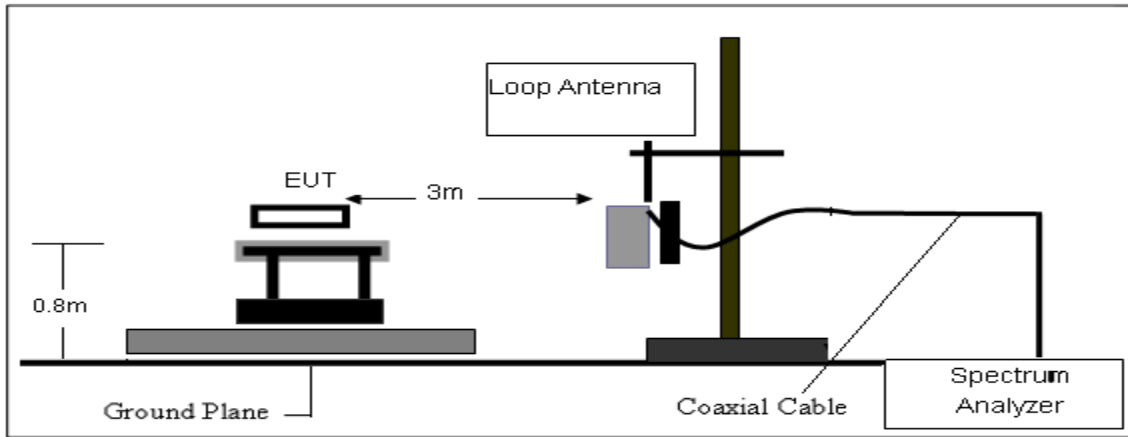

(B) Radiated Emission Test-Up Frequency 30MHz~1GHz

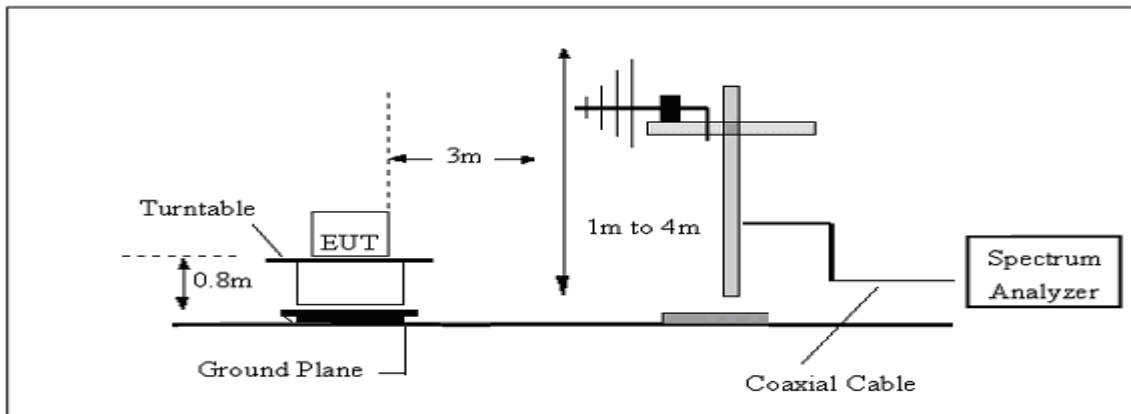

(C) Radiated Emission Test-Up Frequency Above 1GHz

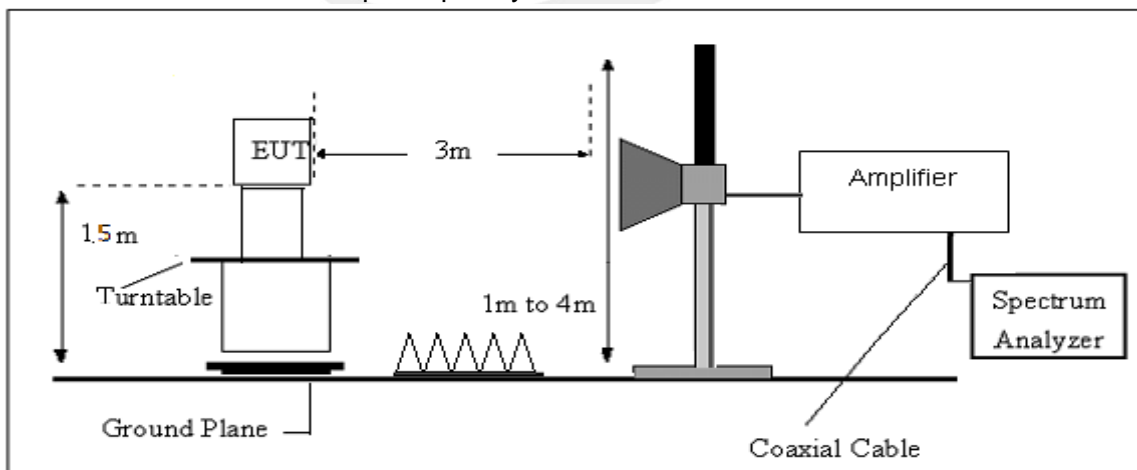

3.2.5 EUT OPERATING CONDITIONS

The EUT tested system was configured as the statements of 2.4 Unless otherwise a special operating condition is specified in the follows during the testing.



3.2.6 TEST RESULTS

Note: ANT 1 and ANT 2 mode all have been tested ,only worse case is reported

(9KHz-30MHz)

Temperature:	23.1℃	Relative Humidity:	61%
Pressure:	1010hPa	Test Mode:	N/A
Test Voltage:	DC 5V		

Freq. (MHz)	Reading (dBuV/m)	Limit (dBuV/m)	Margin (dB)	State P/F	Test Result
--	--	--	--	--	PASS
--	--	--	--	--	PASS

Note:

The amplitude of spurious emissions which are attenuated by more than 20dB below the permissible value has no need to be reported.

Distance extrapolation factor = $40 \log (\text{specific distance}/\text{test distance})$ (dB);

Limit line = specific limits(dBuv) + distance extrapolation factor.



(30MHz-1000MHz)

Temperature:	26 °C	Relative Humidity:	60%
Pressure:	1010hPa	Phase:	Horizontal
Test Voltage:	DC 5V	Test Mode:	Mode 1/2/3 (Mode 1 worst mode)

Frequency (MHz)	Reading (dBuV)	Correct Factor(dB/m)	Result (dBuV/m)	Limit (dBuV/m)	Margin (dB)	Remark
30.6380	35.54	-11.52	24.02	40.00	-15.98	QP
99.8777	47.07	-19.20	27.87	43.50	-15.63	QP
119.8556	51.57	-17.70	33.87	43.50	-9.63	QP
199.8856	53.42	-20.17	33.25	43.50	-10.25	QP
400.4320	53.72	-11.22	42.50	46.00	-3.50	QP
601.4265	49.26	-7.12	42.14	46.00	-3.86	QP

Remark:

1. Margin = Result (Result =Reading + Factor)–Limit
2. ANT 1 and ANT 2 mode all have been tested ,only worse case is reported

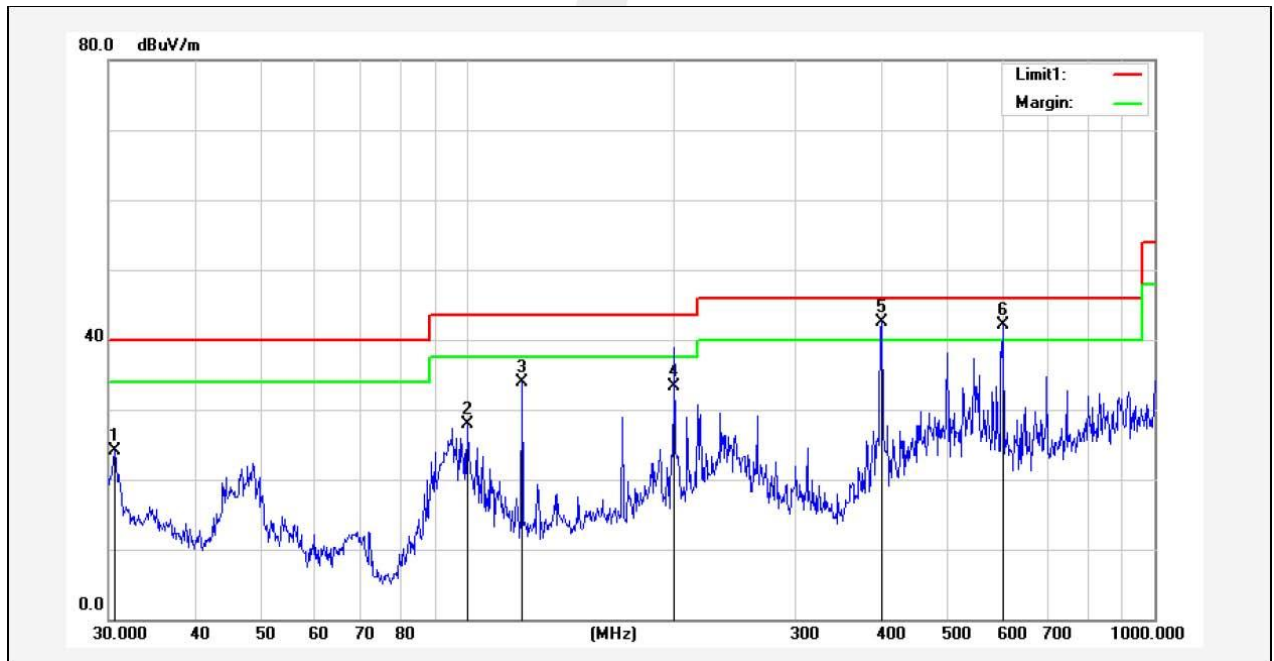



Temperature:	26 °C	Relative Humidity:	60%
Pressure:	1010hPa	Phase:	Vertical
Test Voltage:	DC 5V	Test Mode:	Mode 1/2/3 (Mode 1 worst mode)

Frequency (MHz)	Reading (dBuV)	Correct Factor(dB/m)	Result (dBuV/m)	Limit (dBuV/m)	Margin (dB)	Remark
30.6380	36.57	-11.52	25.05	40.00	-14.95	QP
119.8556	45.57	-17.70	27.87	43.50	-15.63	QP
199.9856	50.54	-20.17	30.37	43.50	-13.13	QP
263.8190	44.64	-15.22	29.42	46.00	-16.58	QP
399.0302	52.84	-11.28	41.56	46.00	-4.44	QP
599.3212	49.98	-7.14	42.84	46.00	-3.16	QP

Remark:

- Margin = Result (Result = Reading + Factor) – Limit
- ANT 1 and ANT 2 mode all have been tested , only worse case is reported

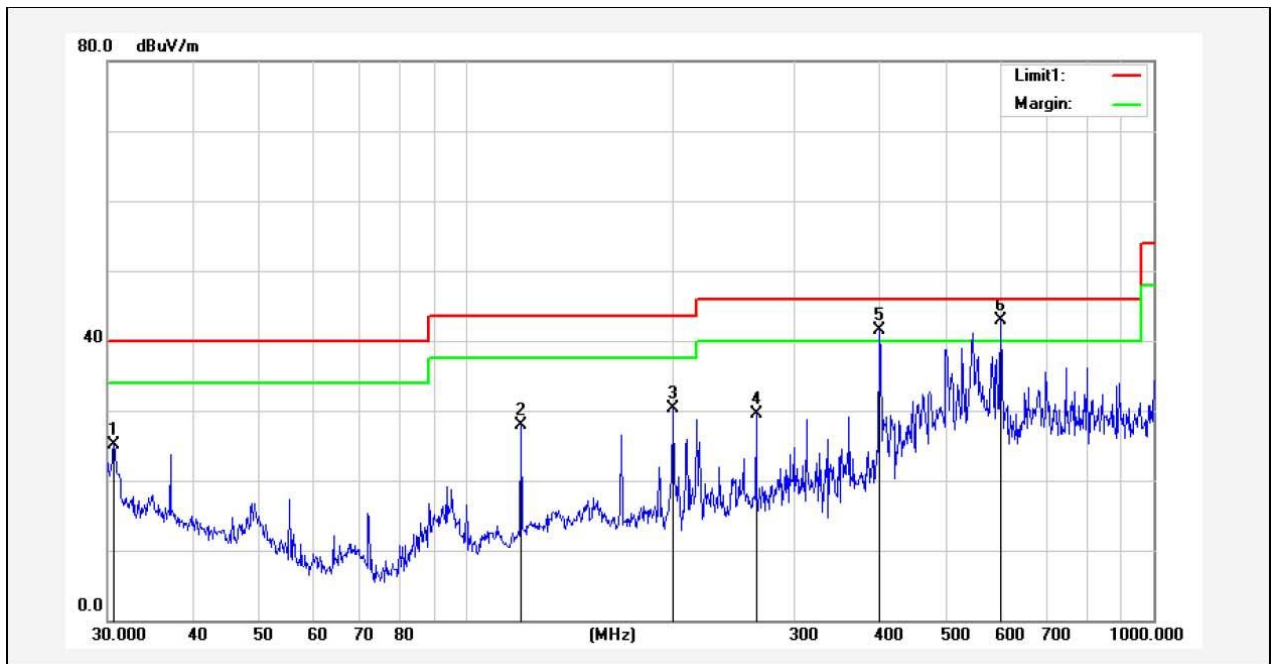



(1GHz~25GHz) Restricted band and Spurious emission Requirements

GFSK Low Channel

Frequency (MHz)	Reading (dBμV)	Amplifier (dB)	Loss (dB)	Antenna Factor (dB/m)	Corrected Factor (dB)	Emission Level (dBμV/m)	Limits (dBμV/m)	Margin (dB)	Detector Type	Comment
Low Channel (904 MHz)										
1099.87	68.09	46.30	3.70	24.30	-18.30	49.79	74	-24.21	PK	Vertical
1099.87	57.05	46.30	3.70	24.30	-18.30	38.75	54	-15.25	AV	Vertical
1100.27	67.92	46.30	3.70	24.30	-18.30	49.62	74	-24.38	PK	Horizontal
1100.27	57.47	46.30	3.70	24.30	-18.30	39.17	54	-14.83	AV	Horizontal
1516.91	65.88	44.90	4.19	25.00	-15.71	50.17	74	-23.83	PK	Vertical
1516.91	57.16	44.90	4.19	25.00	-15.71	41.45	54	-12.55	AV	Vertical
1516.94	65.81	44.90	4.19	25.00	-15.71	50.10	74	-23.90	PK	Horizontal
1516.94	58.19	44.90	4.19	25.00	-15.71	42.48	54	-11.52	AV	Horizontal
1807.60	64.38	44.10	5.30	25.00	-13.80	50.58	74	-23.42	PK	Vertical
1807.60	54.79	44.10	5.30	25.00	-13.80	40.99	54	-13.01	AV	Vertical
1807.57	64.79	44.10	5.30	25.00	-13.80	50.99	74	-23.01	PK	Horizontal
1807.57	53.59	44.10	5.30	25.00	-13.80	39.79	54	-14.21	AV	Horizontal
2144.95	63.15	43.80	5.40	25.90	-12.50	50.65	74	-23.35	PK	Vertical
2144.95	53.15	43.80	5.40	25.90	-12.50	40.65	54	-13.35	AV	Vertical
2144.93	63.28	43.80	5.40	25.90	-12.50	50.78	74	-23.22	PK	Horizontal
2144.93	49.87	43.80	5.40	25.90	-12.50	37.37	54	-16.63	AV	Horizontal
2711.76	66.37	44.40	6.20	27.60	-10.60	55.77	74	-18.23	PK	Vertical
2711.76	50.58	44.40	6.20	27.60	-10.60	39.98	54	-14.02	AV	Vertical
2711.71	65.86	44.40	6.20	27.60	-10.60	55.26	74	-18.74	PK	Horizontal
2711.71	50.98	44.40	6.20	27.60	-10.60	40.38	54	-13.62	AV	Horizontal
3265.06	62.92	44.70	6.70	28.20	-9.80	53.12	74	-20.88	PK	Vertical
3265.06	51.09	44.70	6.70	28.20	-9.80	41.29	54	-12.71	AV	Vertical
3264.84	63.02	44.70	6.70	28.20	-9.80	53.22	74	-20.78	PK	Horizontal
3264.84	51.46	44.70	6.70	28.20	-9.80	41.66	54	-12.34	AV	Horizontal
3999.83	64.83	44.20	7.90	29.70	-6.60	58.23	74	-15.77	PK	Vertical
3999.83	47.12	44.20	7.90	29.70	-6.60	40.52	54	-13.48	AV	Vertical
3999.94	67.24	44.20	7.90	29.70	-6.60	60.64	74	-13.36	PK	Horizontal
3999.94	48.21	44.20	7.90	29.70	-6.60	41.61	54	-12.39	AV	Horizontal
7222.13	55.61	43.50	11.40	35.50	3.40	59.01	74	-14.99	PK	Vertical
7222.13	38.01	43.50	11.40	35.50	3.40	41.41	54	-12.59	AV	Vertical
7222.17	55.81	43.50	11.40	35.50	3.40	59.21	74	-14.79	PK	Horizontal
7222.17	38.69	43.50	11.40	35.50	3.40	42.09	54	-11.91	AV	Horizontal



GFSK Mid Channel

Frequency (MHz)	Reading (dBμV)	Amplifier (dB)	Loss (dB)	Antenna Factor (dB/m)	Corrected Factor (dB)	Emission Level (dBμV/m)	Limits (dBμV/m)	Margin (dB)	Detector Type	Comment
Mid Channel (914.5 MHz)										
1099.78	67.69	46.30	3.70	24.30	-18.30	49.39	74	-24.61	PK	Vertical
1099.78	57.23	46.30	3.70	24.30	-18.30	38.93	54	-15.07	AV	Vertical
1100.06	68.05	46.30	3.70	24.30	-18.30	49.75	74	-24.25	PK	Horizontal
1100.06	56.22	46.30	3.70	24.30	-18.30	37.92	54	-16.08	AV	Horizontal
1516.81	65.71	44.90	4.19	25.00	-15.71	50.00	74	-24.00	PK	Vertical
1516.81	56.30	44.90	4.19	25.00	-15.71	40.59	54	-13.41	AV	Vertical
1516.90	66.29	44.90	4.19	25.00	-15.71	50.58	74	-23.42	PK	Horizontal
1516.90	57.72	44.90	4.19	25.00	-15.71	42.01	54	-11.99	AV	Horizontal
1828.67	64.70	44.10	5.30	25.00	-13.80	50.90	74	-23.10	PK	Vertical
1828.67	54.64	44.10	5.30	25.00	-13.80	40.84	54	-13.16	AV	Vertical
1828.70	65.33	44.10	5.30	25.00	-13.80	51.53	74	-22.47	PK	Horizontal
1828.70	53.27	44.10	5.30	25.00	-13.80	39.47	54	-14.53	AV	Horizontal
2144.92	63.05	43.80	5.40	25.90	-12.50	50.55	74	-23.45	PK	Vertical
2144.92	52.50	43.80	5.40	25.90	-12.50	40.00	54	-14.00	AV	Vertical
2145.01	62.84	43.80	5.40	25.90	-12.50	50.34	74	-23.66	PK	Horizontal
2145.01	49.18	43.80	5.40	25.90	-12.50	36.68	54	-17.32	AV	Horizontal
2743.12	67.33	44.40	6.20	27.60	-10.60	56.73	74	-17.27	PK	Vertical
2743.12	51.07	44.40	6.20	27.60	-10.60	40.47	54	-13.53	AV	Vertical
2743.06	65.76	44.40	6.20	27.60	-10.60	55.16	74	-18.84	PK	Horizontal
2743.06	51.31	44.40	6.20	27.60	-10.60	40.71	54	-13.29	AV	Horizontal
3264.99	63.25	44.70	6.70	28.20	-9.80	53.45	74	-20.55	PK	Vertical
3264.99	51.04	44.70	6.70	28.20	-9.80	41.24	54	-12.76	AV	Vertical
3265.01	62.34	44.70	6.70	28.20	-9.80	52.54	74	-21.46	PK	Horizontal
3265.01	51.42	44.70	6.70	28.20	-9.80	41.62	54	-12.38	AV	Horizontal
3999.98	64.87	44.20	7.90	29.70	-6.60	58.27	74	-15.73	PK	Vertical
3999.98	47.66	44.20	7.90	29.70	-6.60	41.06	54	-12.94	AV	Vertical
3999.89	68.45	44.20	7.90	29.70	-6.60	61.85	74	-12.15	PK	Horizontal
3999.89	48.90	44.20	7.90	29.70	-6.60	42.30	54	-11.70	AV	Horizontal
7317.87	55.27	43.50	11.40	35.50	3.40	58.67	74	-15.33	PK	Vertical
7317.87	38.43	43.50	11.40	35.50	3.40	41.83	54	-12.17	AV	Vertical
7318.05	55.73	43.50	11.40	35.50	3.40	59.13	74	-14.87	PK	Horizontal
7318.05	38.45	43.50	11.40	35.50	3.40	41.85	54	-12.15	AV	Horizontal



GFSK High Channel

Frequency (MHz)	Reading (dBμV)	Amplifier (dB)	Loss (dB)	Antenna	Corrected	Emission		Margin (dB)	Detector	
				Factor (dB/m)	Factor (dB)	Level (dBμV/m)	Limits (dBμV/m)		Type	Comment
High Channel (925 MHz)										
1099.99	67.92	46.30	3.70	24.30	-18.30	49.62	74	-24.38	PK	Vertical
1099.99	57.12	46.30	3.70	24.30	-18.30	38.82	54	-15.18	AV	Vertical
1100.07	67.08	46.30	3.70	24.30	-18.30	48.78	74	-25.22	PK	Horizontal
1100.07	57.04	46.30	3.70	24.30	-18.30	38.74	54	-15.26	AV	Horizontal
1516.83	65.96	44.90	4.19	25.00	-15.71	50.25	74	-23.75	PK	Vertical
1516.83	56.05	44.90	4.19	25.00	-15.71	40.34	54	-13.66	AV	Vertical
1516.90	65.16	44.90	4.19	25.00	-15.71	49.45	74	-24.55	PK	Horizontal
1516.90	56.99	44.90	4.19	25.00	-15.71	41.28	54	-12.72	AV	Horizontal
1849.61	65.00	44.10	5.30	25.00	-13.80	51.20	74	-22.80	PK	Vertical
1849.61	55.69	44.10	5.30	25.00	-13.80	41.89	54	-12.11	AV	Vertical
1849.68	64.34	44.10	5.30	25.00	-13.80	50.54	74	-23.46	PK	Horizontal
1849.68	53.55	44.10	5.30	25.00	-13.80	39.75	54	-14.25	AV	Horizontal
2144.95	62.84	43.80	5.40	25.90	-12.50	50.34	74	-23.66	PK	Vertical
2144.95	53.09	43.80	5.40	25.90	-12.50	40.59	54	-13.41	AV	Vertical
2145.09	62.50	43.80	5.40	25.90	-12.50	50.00	74	-24.00	PK	Horizontal
2145.09	49.63	43.80	5.40	25.90	-12.50	37.13	54	-16.87	AV	Horizontal
2774.60	67.45	44.40	6.20	27.60	-10.60	56.85	74	-17.15	PK	Vertical
2774.60	51.64	44.40	6.20	27.60	-10.60	41.04	54	-12.96	AV	Vertical
2774.63	65.25	44.40	6.20	27.60	-10.60	54.65	74	-19.35	PK	Horizontal
2774.63	50.58	44.40	6.20	27.60	-10.60	39.98	54	-14.02	AV	Horizontal
3264.91	62.73	44.70	6.70	28.20	-9.80	52.93	74	-21.07	PK	Vertical
3264.91	51.32	44.70	6.70	28.20	-9.80	41.52	54	-12.48	AV	Vertical
3264.96	63.57	44.70	6.70	28.20	-9.80	53.77	74	-20.23	PK	Horizontal
3264.96	51.23	44.70	6.70	28.20	-9.80	41.43	54	-12.57	AV	Horizontal
4000.06	64.27	44.20	7.90	29.70	-6.60	57.67	74	-16.33	PK	Vertical
4000.06	47.55	44.20	7.90	29.70	-6.60	40.95	54	-13.05	AV	Vertical
3999.96	67.50	44.20	7.90	29.70	-6.60	60.90	74	-13.10	PK	Horizontal
3999.96	48.25	44.20	7.90	29.70	-6.60	41.65	54	-12.35	AV	Horizontal

Note:

- 1) Scan with two antennas , only show the worst case in the report.
- 2) Corrected Factor = -Antenna Factor --+Cable Loss- Amplifier.
Emission Level = Reading + Corrected Factor
- 3 ANT 1 and ANT 2 mode all have been tested , only worse case is reported



Band edge Requirements

Frequency (MHz)	Reading (dBμV)	Amplifier (dB)	Loss (dB)	Antenna Factor (dB/m)	Corrected Factor (dB)	Emission Level (dBμV/m)	Limits (dBμV/m)	Margin (dB)	Detector Type	Comment
Low channel										
902.00	35.42	43.80	4.91	25.90	-12.99	22.43	46.00	-23.57	QP	Vertical
902.00	28.32	43.80	4.91	25.90	-12.99	15.33	46.00	-30.67	QP	Horizontal
High channel										
928.00	36.20	43.80	5.12	25.90	-12.78	23.42	46.00	-22.58	QP	Vertical
928.00	28.14	43.80	5.12	25.90	-12.78	15.36	46.00	-30.64	QP	Horizontal
<p>1. Low measurement frequencies is range from 800 to 906 MHz, high measurement frequencies is range from 923 to 1000 MHz. Only show the worst point data of the emissions in the frequency 800-906 MHz and 923-1000 MHz.</p> <p>2. Scan with two antennas , only show the worst case in the report</p> <p>3. ANT 1 and ANT 2 mode all have been tested , only worse case is reported</p>										

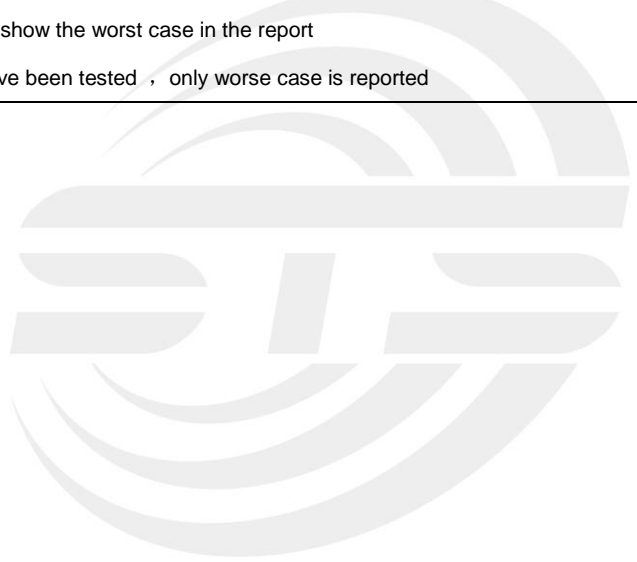



Hopping Band edge

Frequency (MHz)	Reading (dBμV)	Amplifier (dB)	Loss (dB)	Antenna Factor (dB/m)	Corrected Factor (dB)	Emission Level (dBμV/m)	Limits (dBμV/m)	Margin (dB)	Detector Type	Comment
Low channel										
902.00	35.22	43.80	4.91	25.90	-12.99	22.23	46.00	-23.77	QP	Vertical
902.00	27.16	43.80	4.91	25.90	-12.99	14.17	46.00	-31.83	QP	Horizontal
High Channel										
928.00	36.36	43.80	5.12	25.90	-12.78	23.58	46.00	-22.42	QP	Vertical
928.00	28.21	43.80	5.12	25.90	-12.78	15.43	46.00	-30.57	QP	Horizontal
<p>1.Low measurement frequencies is range from 800 to 906 MHz,high measurement frequencies is range from 923 to 1000 MHz. Only showthe worst point data of the emissions in the frequency 800-906 MHz and 923-1000 MHz.</p> <p>2. Scan with two antennas , only show the worst case in the report</p> <p>3. ANT 1 and ANT 2 mode all have been tested , only worse case is reported</p>										

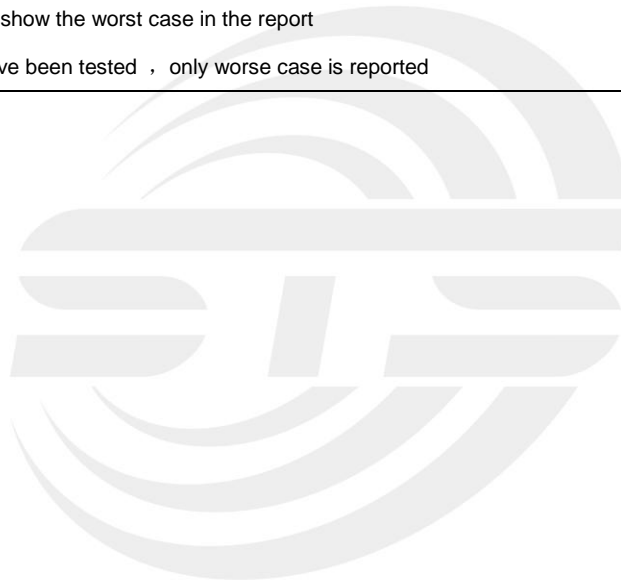

4. CONDUCTED SPURIOUS & BAND EDGE EMISSION

4.1 REQUIREMENT

According to FCC section 15.247(d), in any 100kHz bandwidth outside the frequency band in which the spread spectrum or digitally modulated intentional radiator is operating, the radio frequency power that is produced by the intentional radiator shall be at least 20dB below that in the 100kHz bandwidth within the band that contains the highest level of the desired power, based on either an RF conducted or a radiated measurement.

4.2 TEST PROCEDURE

Spectrum Parameter	Setting
Detector	Peak
Start/Stop Frequency	30 MHz to 10th carrier harmonic
RB / VB (emission in restricted band)	100 KHz/300 KHz
Trace-Mode:	Max hold

For Band edge

Spectrum Parameter	Setting
Detector	Peak
Start/Stop Frequency	Lower Band Edge: 800 – 906 MHz Upper Band Edge: 923 – 1000 MHz
RB / VB (emission in restricted band)	100 KHz/300 KHz
Trace-Mode:	Max hold

Remark : Hopping on and Hopping off mode all have been tested, only worst case hopping off is reported.

4.3 TEST SETUP

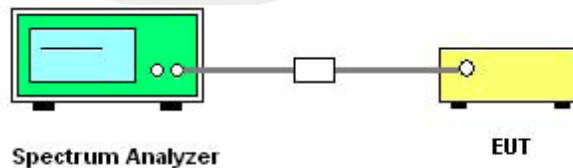

The EUT is coupled to the Spectrum Analyzer; the RF load attached to the EUT antenna terminal is 50Ohm; the path loss as the factor is calibrated to correct the reading. Make the measurement with the spectrum analyzer's resolution bandwidth(RBW) = 100 kHz. In order to make an accurate measurement, set the span greater than RBW.

4.4 EUT OPERATION CONDITIONS

The EUT tested system was configured as the statements of 2.3 Unless otherwise a special operating condition is specified in the follows during the testing.



4.5 TEST RESULTS

Temperature:	25°C	Relative Humidity:	50%
Pressure:	1012 hPa	Test Voltage:	DC 5V
Test Mode:	GFSK-01/22/43CH		

01 CH

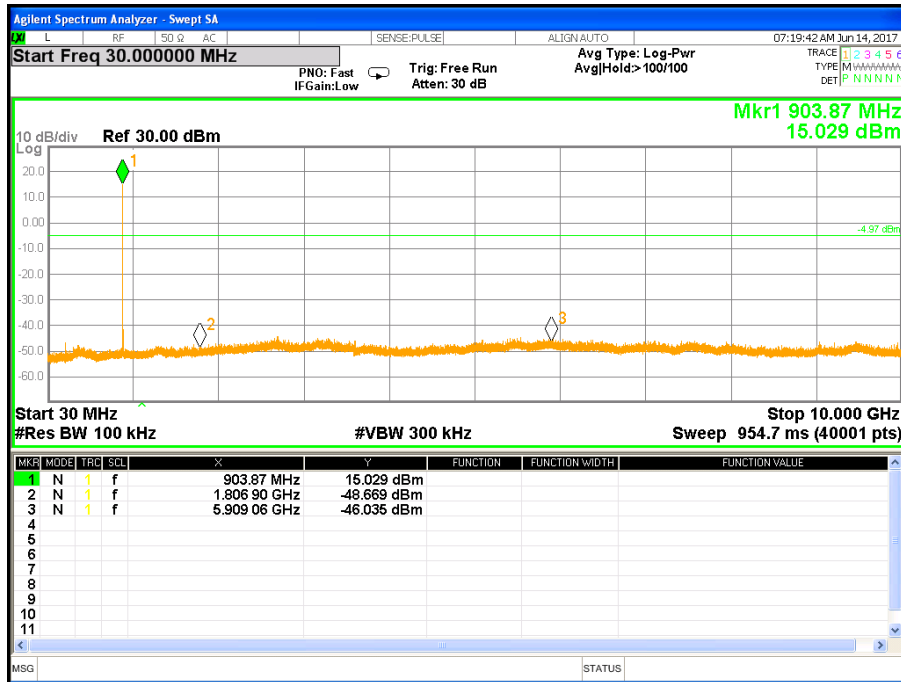

22 CH

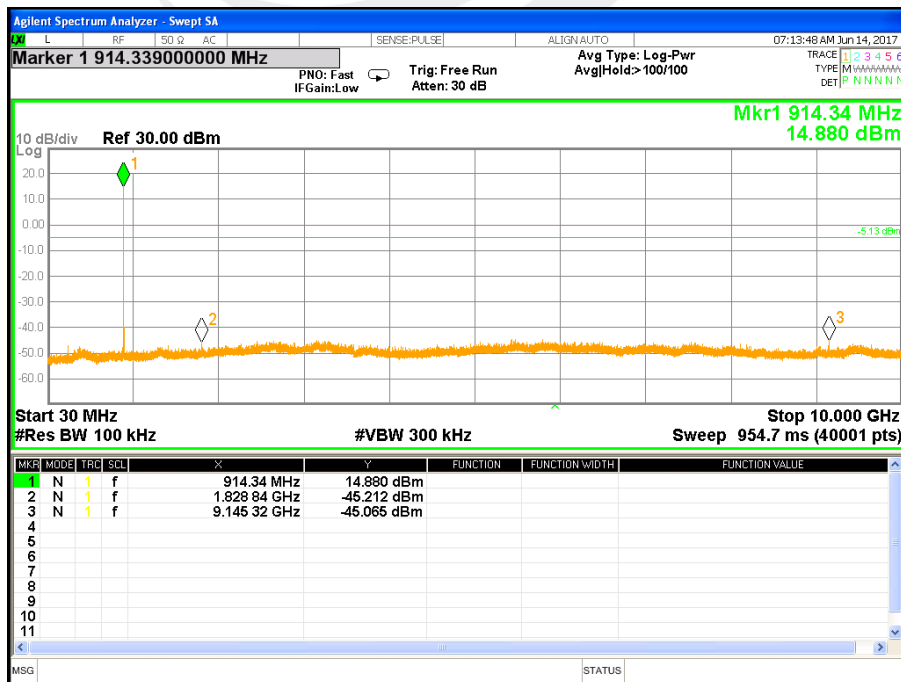



43 CH

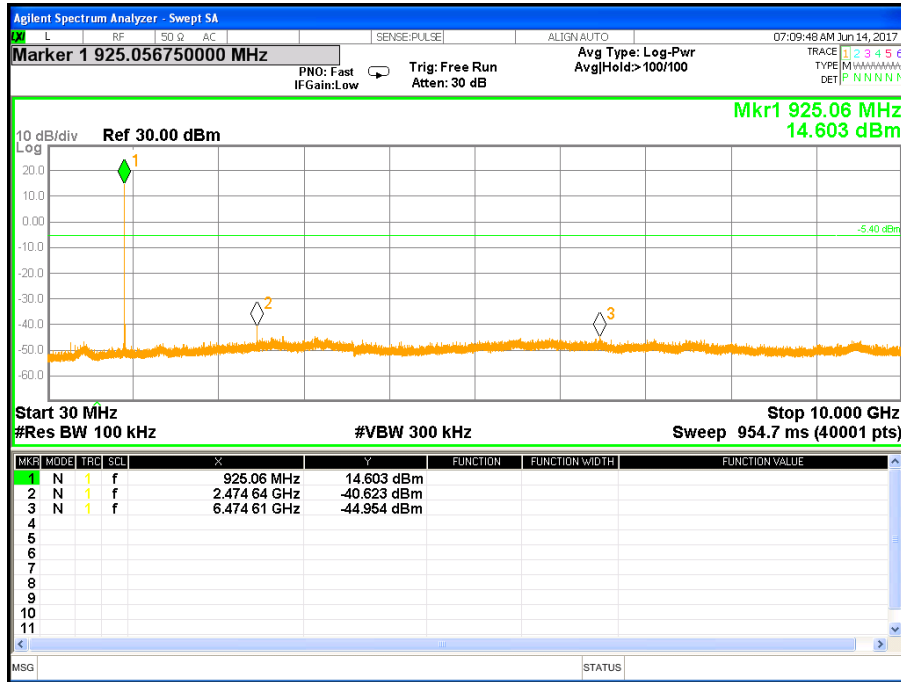



For Band edge

01 CH

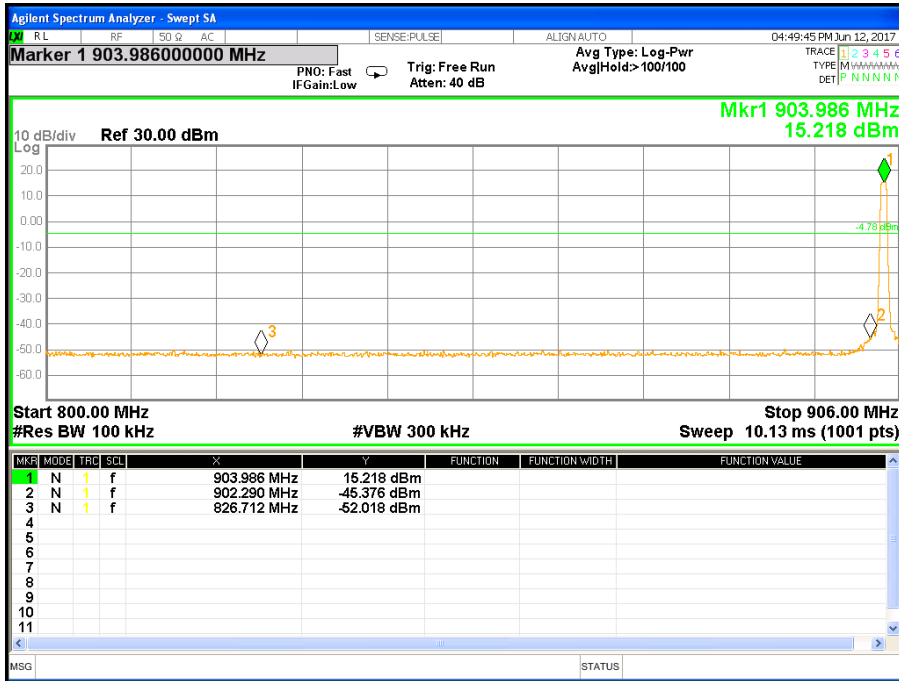

43 CH

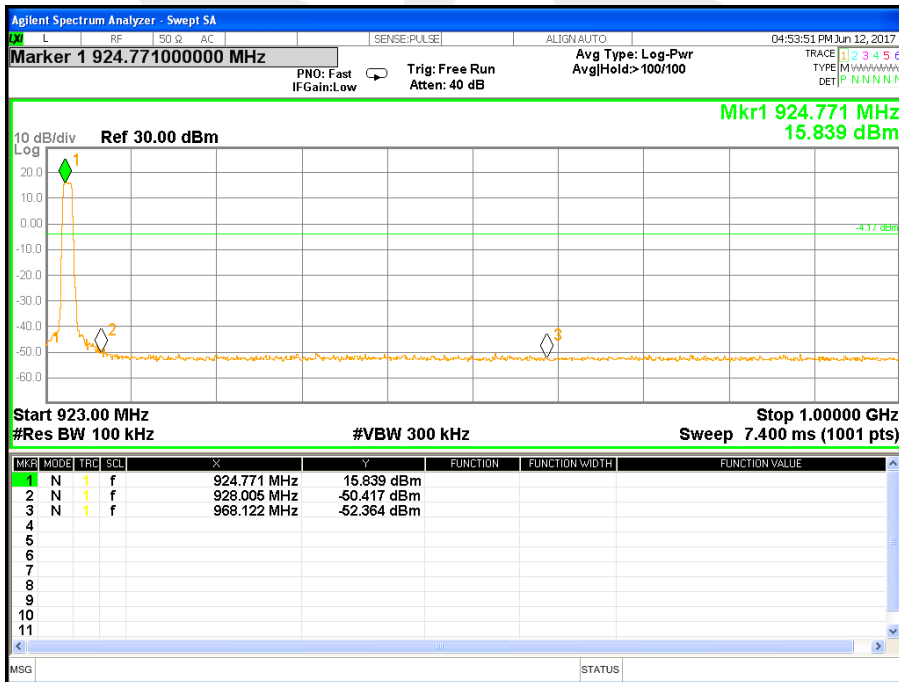



For Hopping Band edge

01 CH

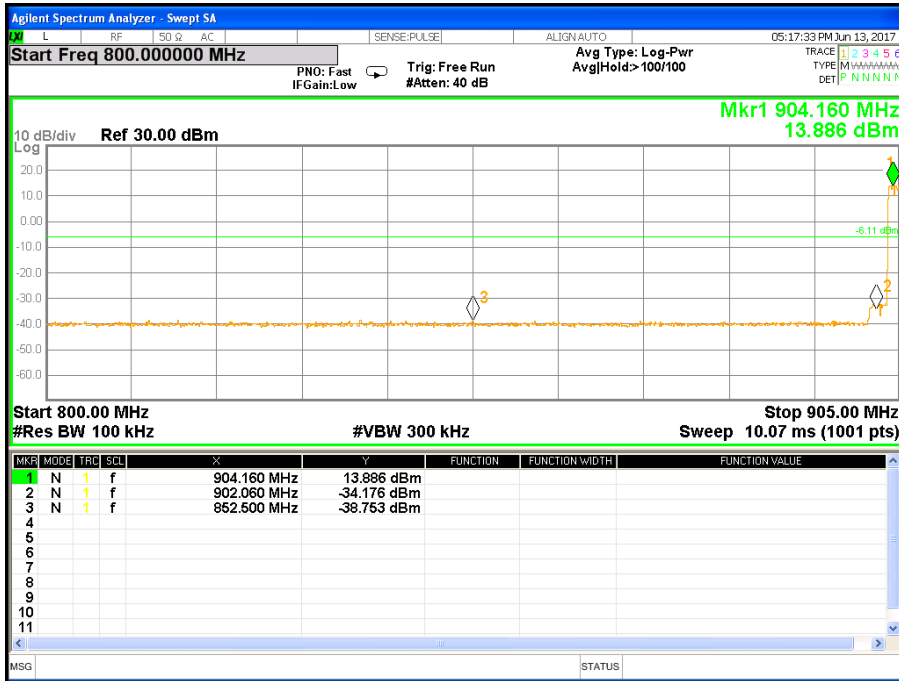

43 CH

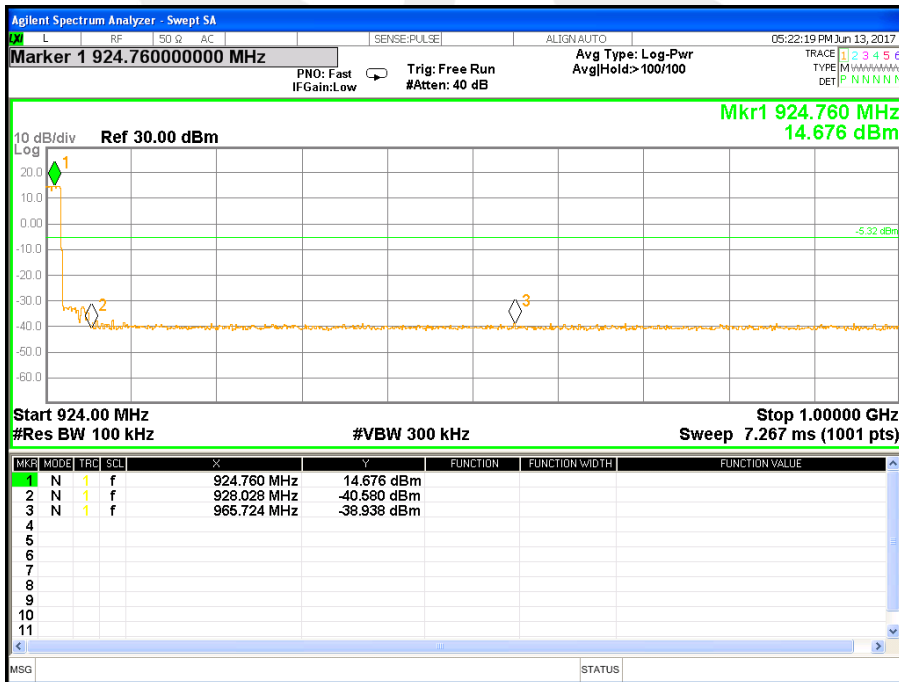



5. NUMBER OF HOPPING CHANNEL

5.1 APPLIED PROCEDURES / LIMIT

FCC Part 15.247, Subpart C				
Section	Test Item	Limit	FrequencyRange (MHz)	Result
15.247 (a)	Number of Hopping Channel	≥25	902-928	PASS

Spectrum Parameters	Setting
Attenuation	Auto
Span Frequency	> Operating FrequencyRange
RB	100KHz
VB	100KHz
Detector	Peak
Trace	Max Hold
Sweep Time	Auto

5.2 TEST PROCEDURE

- The EUT was directly connected to the spectrum analyzer and antenna output port as show in the block diagram below,
- Spectrum Setting : RBW= 100KHz, VBW=100KHz, Sweep time = Auto.

5.3 TEST SETUP

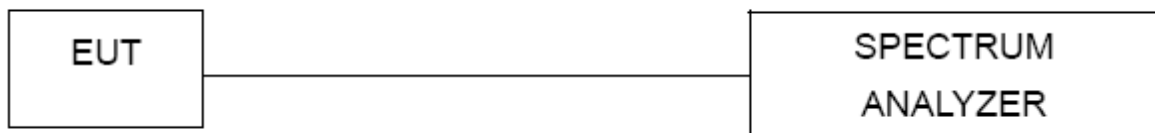

5.4 EUT OPERATION CONDITIONS

The EUT tested system was configured as the statements of 2.4 Unless otherwise a special operating condition is specified in the follows during the testing.



5.5 TEST RESULTS

Temperature:	25°C	Relative Humidity:	60%
Pressure:	1015 hPa	Test Voltage:	DC 5V
Test Mode:	Hopping Mode		

Number of Hopping Channel

43

Hopping channel

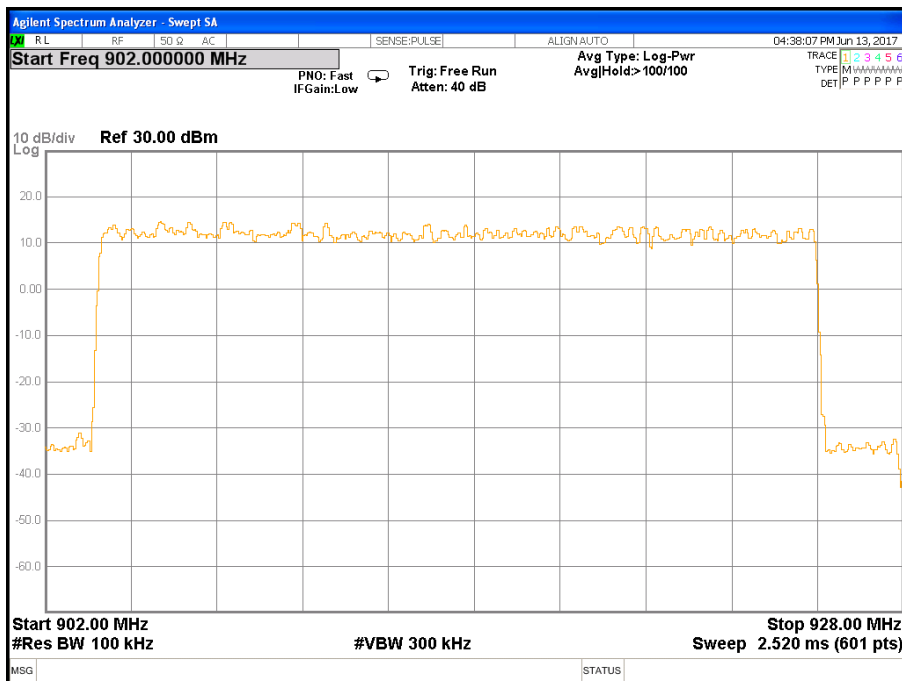

6. AVERAGE TIME OF OCCUPANCY

6.1 APPLIED PROCEDURES / LIMIT

FCC Part 15.247, Subpart C				
Section	Test Item	Limit	FrequencyRange (MHz)	Result
15.247 (a)	Average Time of Occupancy	0.4sec	902-928	PASS

6.2 TEST PROCEDURE

- The transmitter output (antenna port) was connected to the spectrum analyzer
 - Set RBW =1MHz/VBW =1MHz.
 - Use a video trigger with the trigger level set to enable triggering only on full pulses.
 - Sweep Time is more than once pulse time.
 - Set the center frequency on any frequency would be measure and set the frequency span to zero span.
 - Measure the maximum time duration of one single pulse.
- Note: 20 dB bandwidth of the hopping channel is 250 kHz or greater, the system shall use at least 25 hopping frequencies and the average time of occupancy on any frequency shall not be greater than 0.4 seconds within a 10 second period. The maximum allowed 20 dB bandwidth of the hopping channel is 500 kHz

6.3 TEST SETUP



6.4 EUT OPERATION CONDITIONS

The EUT tested system was configured as the statements of 2.4 Unless otherwise a special operating condition is specified in the follows during the testing.



6.5 TEST RESULTS

Temperature:	25°C	Relative Humidity:	50%
Pressure:	1012 hPa	Test Voltage:	DC 5V
Test Mode:	GFSK-Low/Middle/High		

Frequency	Pulse Duration(ms)	Dwell Time(s)	Limits(s)
904.0 MHz	3.667	0.367	0.4
914.5 MHz	4.000	0.400	0.4
925.0 MHz	4.000	0.400	0.4

Note: Dwell Time=10000/200*2*Pulse Duration





CH01

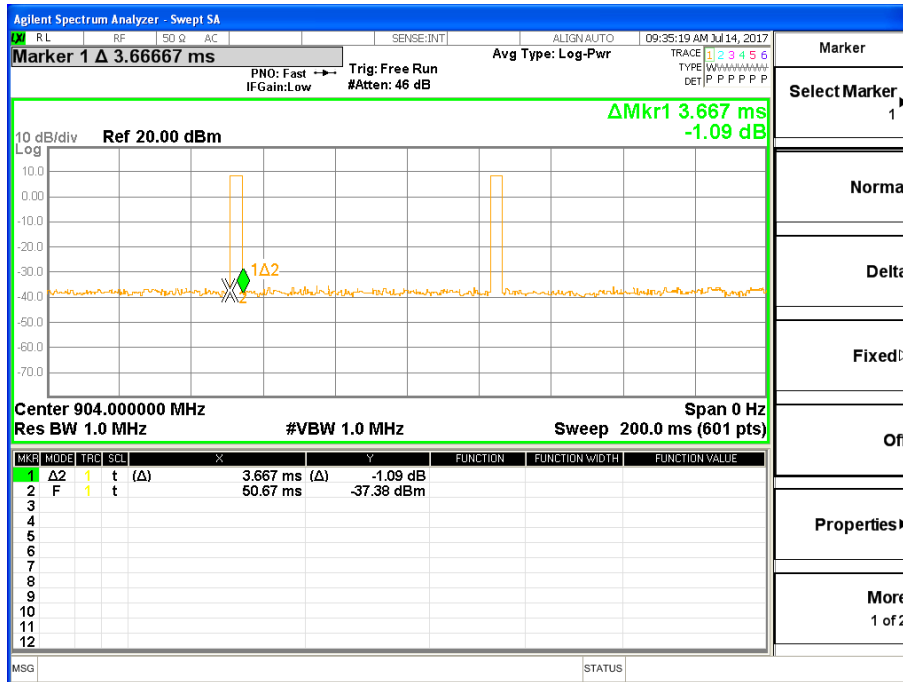

CH22

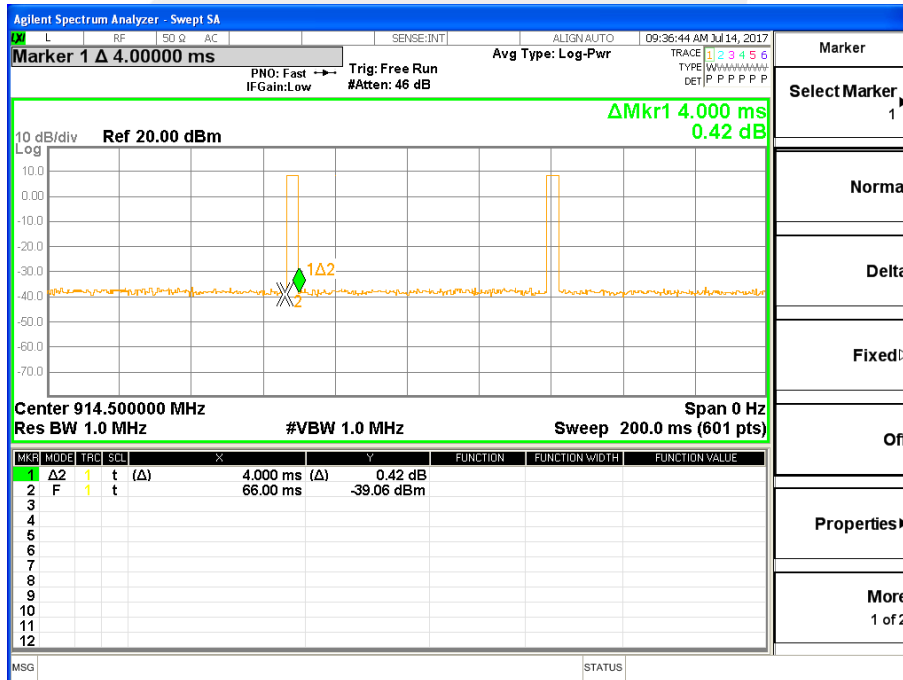



CH43

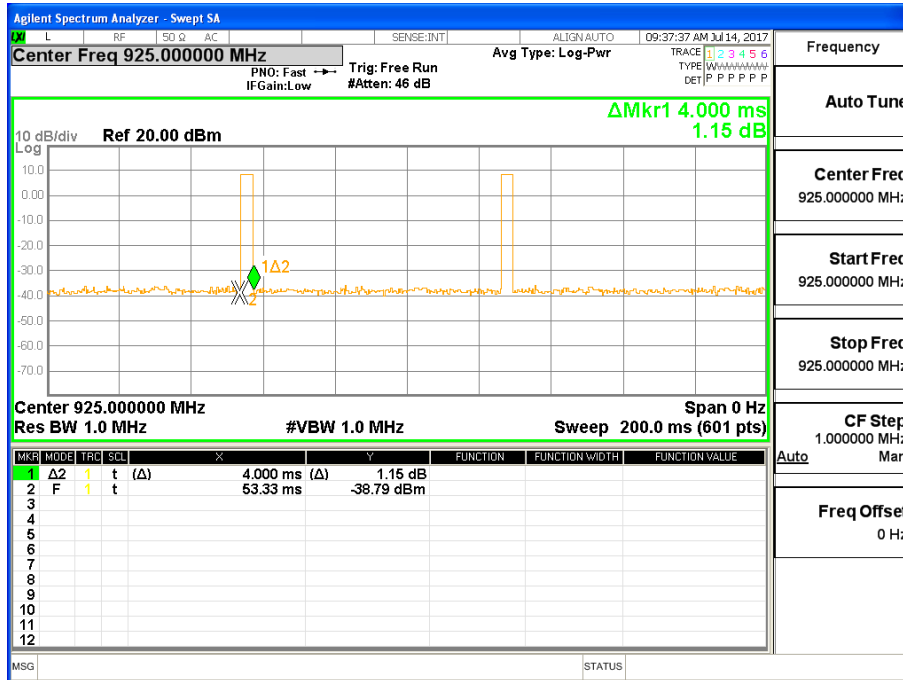

7. HOPPING CHANNEL SEPARATION MEASUREMENT

7.1 APPLIED PROCEDURES / LIMIT

Frequency hopping systems operating in the 2400-2483.5 MHz band may have hopping channel carrier frequencies that are separated by 20 dB bandwidth of the hopping channel, whichever is greater.

Spectrum Parameter	Setting
Attenuation	Auto
Span Frequency	> 20 dB Bandwidth or Channel Separation
RB	30 kHz (20dB Bandwidth) / 30 kHz (Channel Separation)
VB	100 kHz (20dB Bandwidth) / 100 kHz (Channel Separation)
Detector	Peak
Trace	Max Hold
Sweep Time	Auto

7.2 TEST PROCEDURE

- The transmitter output (antenna port) was connected to the spectrum analyser in peak hold mode.
- The resolution bandwidth of 30 kHz and the video bandwidth of 100 kHz were utilised for 20 dB bandwidth measurement.
- The resolution bandwidth of 30 kHz and the video bandwidth of 100 kHz were utilised for channel separation measurement.

7.3 TEST SETUP

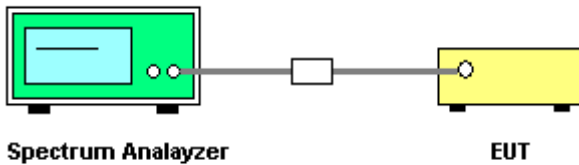

7.4 EUT OPERATION CONDITIONS

The EUT was programmed to be in continuously transmitting mode.



7.5 TEST RESULTS

Temperature:	25°C	Relative Humidity:	50%
Pressure:	1012 hPa	Test Voltage:	DC 5V
Test Mode:	CH01 / CH22 / CH43 (Lora™ (1Mbps) Mode)		

Note: ANT1 and ANT2 can not transmitter at the same time, Scan with two antennas , only show the worst case in the report

Frequency	Ch. Separation (MHz)	Limit (MHz)	Result
904 MHz	0.532	0.741	Complies
914.5 MHz	0.500	0.748	Complies
925 MHz	0.497	0.740	Complies

For GFSK: Ch. Separation Limits: > 20dB bandwidth

CH01 -1Mbps

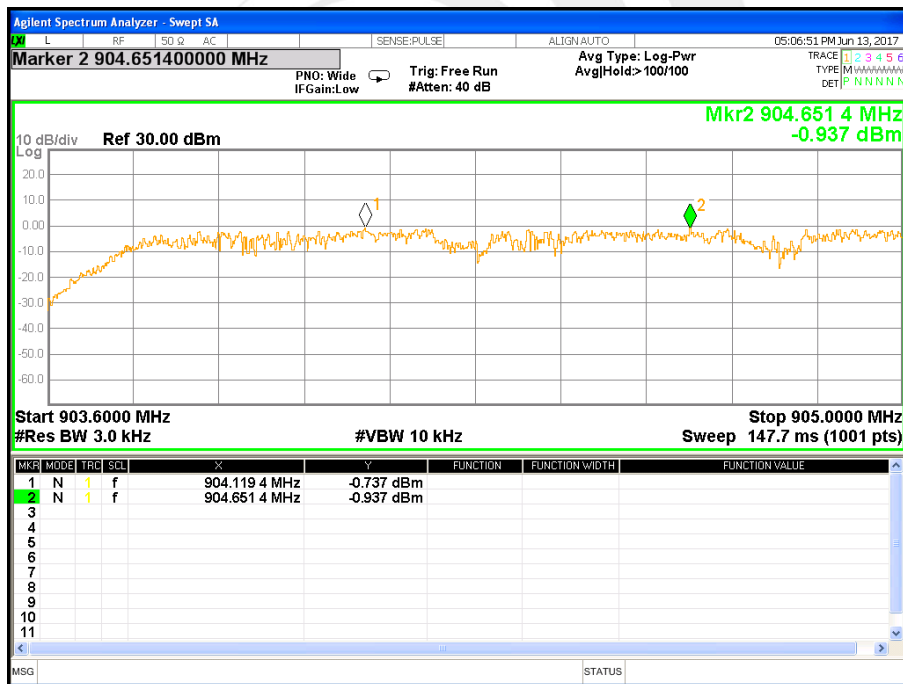



CH22 -1Mbps

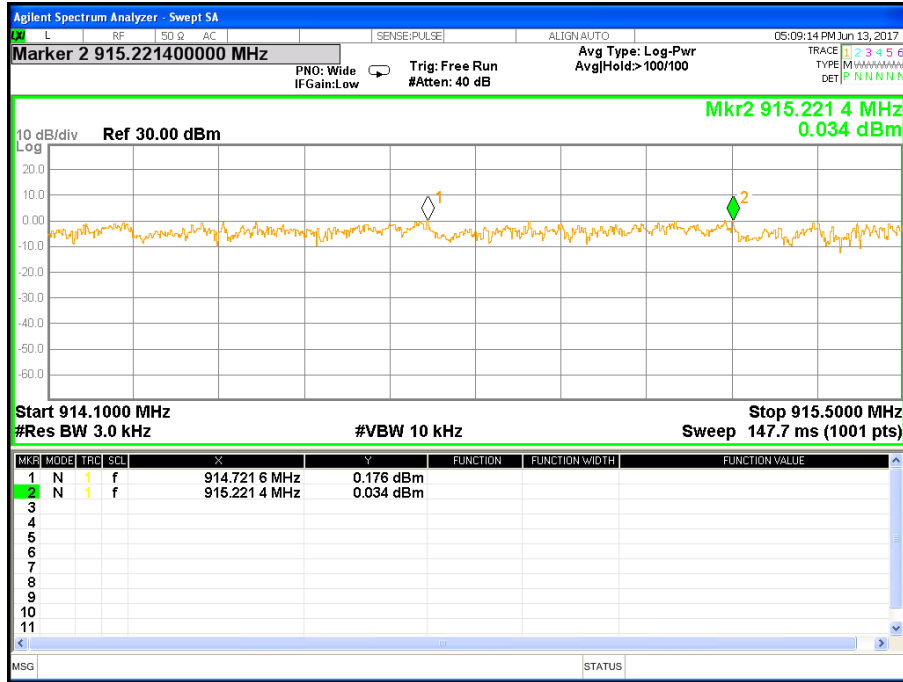

CH43 -1Mbps

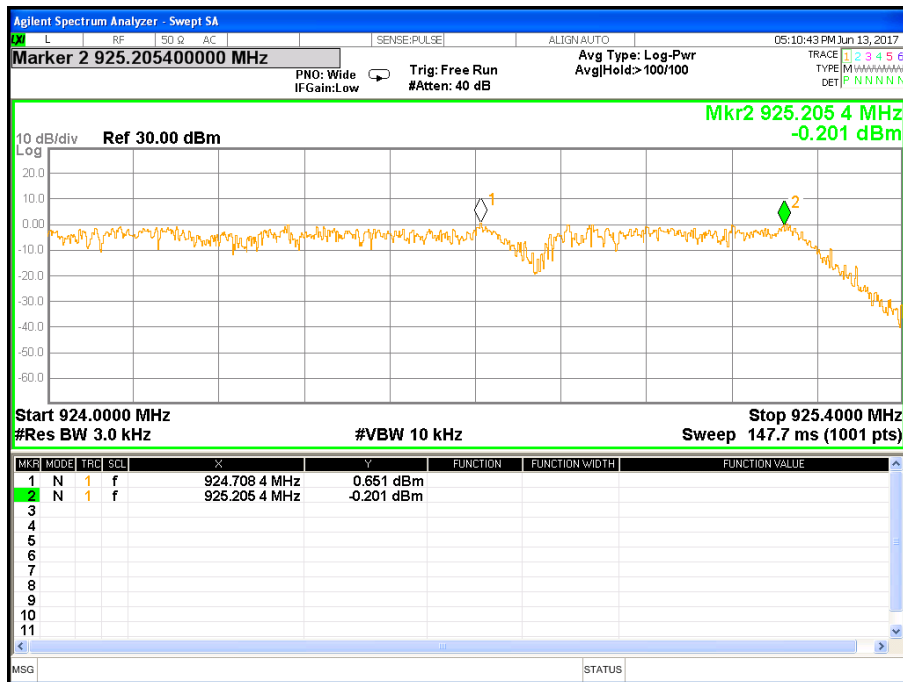



8. BANDWIDTH TEST

8.1 APPLIED PROCEDURES / LIMIT

FCC Part15 15.247,Subpart C				
Section	Test Item	Limit	FrequencyRange (MHz)	Result
15.247 (a)	Bandwidth	(20dB bandwidth) Less than 500KHz	902-928	PASS

Spectrum Parameter	Setting
Attenuation	Auto
Span Frequency	> Measurement Bandwidth or Channel Separation
RB	30 kHz (20dB Bandwidth) / 30 kHz (Channel Separation)
VB	100 kHz (20dB Bandwidth) / 100 kHz (Channel Separation)
Detector	Peak
Trace	Max Hold
Sweep Time	Auto

8.2 TEST PROCEDURE

- a. The EUT was directly connected to the spectrum analyzer and antenna output port as show in the block diagram below,
- b. Spectrum Setting : RBW= 30KHz, VBW=100KHz, Sweep time = Auto.

8.3 TEST SETUP

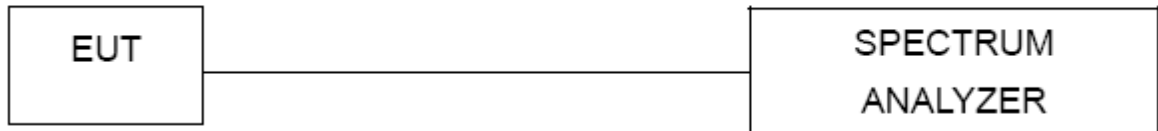

8.4 EUT OPERATION CONDITIONS

The EUT tested system was configured as the statements of 2.4 Unless otherwise a special operating condition is specified in the follows during the testing.



8.5 TEST RESULTS

Temperature:	25°C	Relative Humidity:	50%
Pressure:	1012 hPa	Test Voltage:	DC 5V
Test Mode:	GFSK CH01 / CH22 / C43		
Frequency	20dB Bandwidth (MHz)	Limit (KHz)	Result
904 MHz	0.471	500	PASS
914.5 MHz	0.448	500	PASS
925 MHz	0.440	500	PASS

CH01 -1Mbps

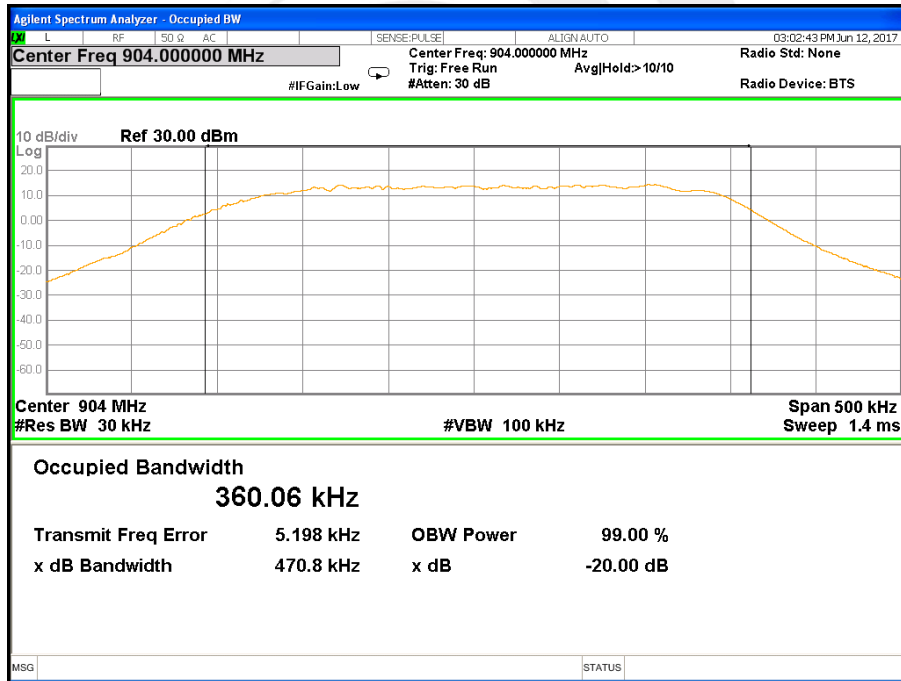



CH22 -1Mbps

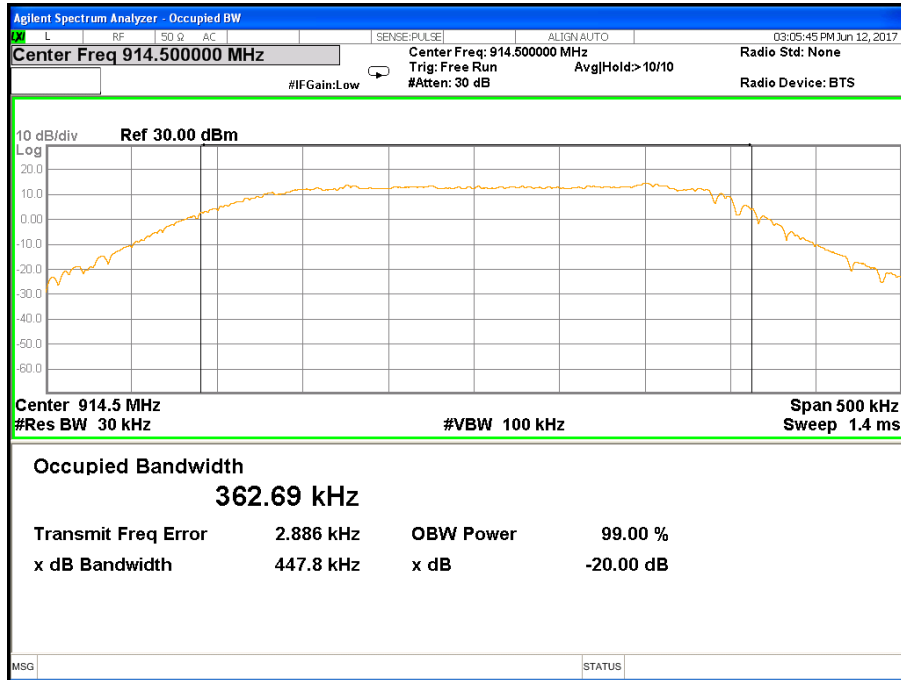

CH43 -1Mbps

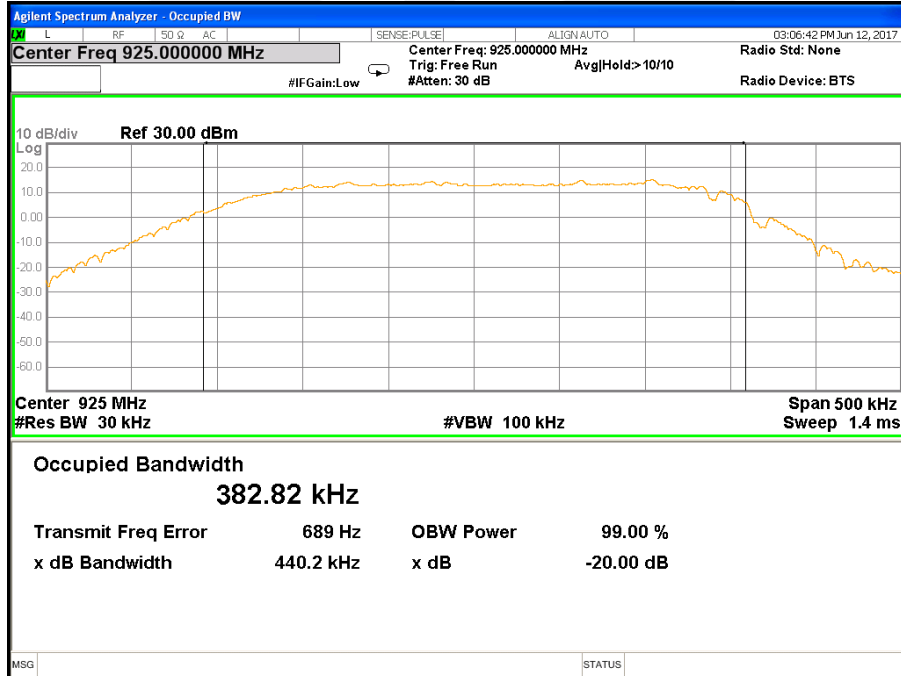



9. OUTPUT POWER TEST

9.1 APPLIED PROCEDURES / LIMIT

FCC Part 15.247, Subpart C				
Section	Test Item	Limit	Frequency Range (MHz)	Result
15.247 (b)(2)	Output Power	0.25W	902-928	PASS

9.2 TEST PROCEDURE

- a. The EUT was directly connected to the Power Sensor&PC

9.3 TEST SETUP



9.4 EUT OPERATION CONDITIONS

The EUT tested system was configured as the statements of 2.4 Unless otherwise a special operating condition is specified in the follows during the testing.



9.5 TEST RESULTS

Temperature:	25°C	Relative Humidity:	60%	
Pressure:	1012 hPa	Test Voltage:	DC 5V	
GFSK				
Test Channel	Frequency	Conducted Output Power		LIMIT
	(MHz)	Peak (dBm)	AVG (dBm)	dBm
CH00	904 MHz	15.42	10.15	23.98
CH39	914.5 MHz	14.83	9.56	23.98
CH78	925 MHz	14.65	8.93	23.98

Note: the channel separation > bandwidth

ANT 1 and ANT 2 mode all have been tested , only worse case is reported



10. ANTENNA REQUIREMENT

10.1 STANDARD REQUIREMENT

15.203 requirement: For intentional device, according to 15.203: an intentional radiator shall be designed to ensure that no antenna other than that furnished by the responsible party shall be used with the device.

10.2 EUT ANTENNA

The EUT antenna is FPC Antenna. It comply with the standard requirement.



APPENDIX-PHOTOS OF TEST SETUP

Radiated Measurement Photos

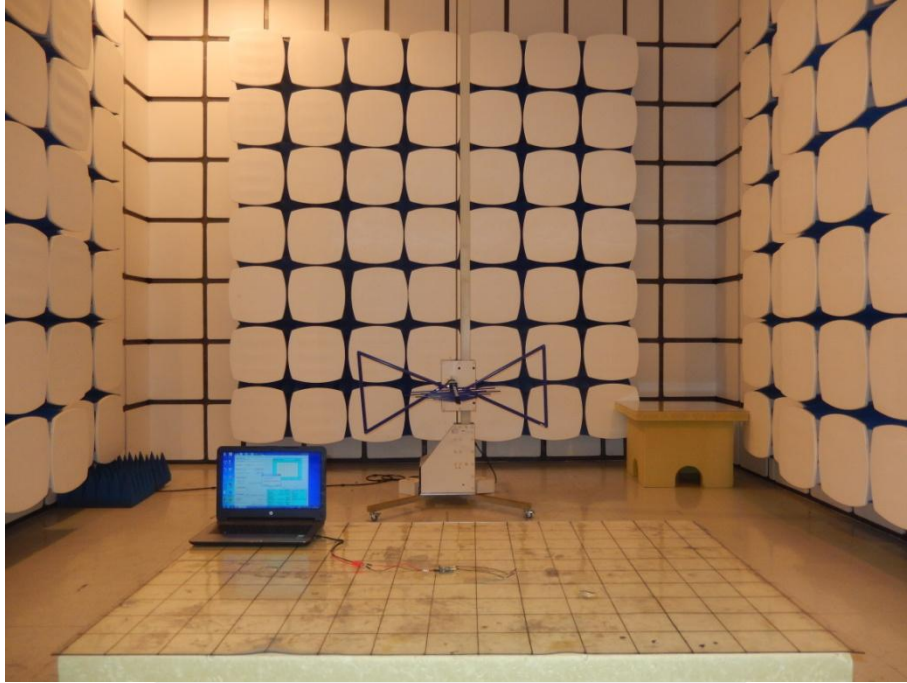



Conducted Measurement Photos



※※※※END OF THE REPORT※※※※

