

FRSKY ELECTRONIC CO., LTD

2.4G RADIO SYSTEM

Model:

V8FT,V8JT,V8HT,DFT,DHT,DJT,V8FR,V8R4,V8R7,D8R,
TFR8,TFR4,TFR6,TFR14,TF-8M,TF-14M

Nov 01th 2010

Report No.: 1002720(SAR_FCC) Rev1.0
(This report supersedes 1002720(SAR_FCC))



SAR Test Report

To: C95.1, IEEE 1528, OET Bulletin 65 Suppl. C (Edition 01-01)

SIEMIC, INC.
Accessing global markets



Modifications made to the product : None

This Test Report is Issued Under the Authority of:

David Zhang
Compliance Engineer

Leslie Bai
Director of Certification

This test report may be reproduced in full only.
All Test Data Presented in this report is only applicable to presented Test sample.

Laboratory Introduction

SIEMIC, headquartered in the heart of Silicon Valley, with superior facilities in US and Asia, is one of the leading independent testing and certification facilities providing customers with one-stop shop services for Compliance Testing and Global Certifications.



In addition to [testing](#) and [certification](#), SIEMIC provides initial design reviews and [compliance management](#) through out a project. Our extensive experience with [China](#), [Asia Pacific](#), [North America](#), [European](#), and [international](#) compliance requirements, assures the fastest, most cost effective way to attain regulatory compliance for the [global markets](#).

Accreditations for Conformity Assessment

Country/Region	Accreditation Body	Scope
USA	FCC, A2LA	EMC , RF/Wireless , Telecom
Canada	IC, A2LA, NIST	EMC, RF/Wireless , Telecom
Taiwan	BSMI , NCC , NIST	EMC, RF, Telecom , Safety
Hong Kong	OFTA , NIST	RF/Wireless , Telecom
Australia	NATA, NIST	EMC, RF, Telecom , Safety
Korea	KCC/RRA, NIST	EMI, EMS, RF , Telecom, Safety
Japan	VCCI, JATE, TELEC, RFT	EMI, RF/Wireless, Telecom
Mexico	NOM, COFETEL, Caniety	Safety, EMC , RF/Wireless, Telecom
Europe	A2LA, NIST	EMC, RF, Telecom , Safety

Accreditations for Product Certifications

Country	Accreditation Body	Scope
USA	FCC TCB, NIST	EMC , RF , Telecom
Canada	IC FCB , NIST	EMC , RF , Telecom
Singapore	iDA, NIST	EMC , RF , Telecom
EU	NB, NIST	EMC, RF, Safety, Telecom

This page has been left blank intentionally.

CONTENTS

1 EXECUTIVE SUMMARY & EUT INFORMATION.....6

2 TECHNICAL DETAILS.....7

3 INTRODUCTION8

4 SAR MEASUREMENT SETUP9

5 ANSI/IEEE C95.1 – 1999 RF EXPOSURE LIMIT19

6 SYSTEM AND LIQUID VALIDATION20

7 TYPE A MEASUREMENT UNCERTAINTY24

8 OUTPUT POWER VERIFICATION26

9 SAR TEST RESULTS27

ANNEX A. TEST INSTRUMENT & METHOD40

ANNEX B EUT AND TEST SETUP PHOTOGRAPHS42

ANNEX C CALIBRATION REPORTS45

This page has been left blank intentionally.

1 Executive Summary & EUT information

The purpose of this test programmed was to demonstrate compliance of the FrSky Electronic Co., Ltd Model: V8FT,V8JT,V8HT,DFT,DHT,DJT,V8FR,V8R4,V8R7,D8R,TFR8,TFR4,TFR6,TFR14,TF-8M,TF-14M against the current Stipulated Standards. The 2.4G Radio System have demonstrated compliance with the C95.1 , IEEE 1528, OET Bulletin 65 Supplement C(Edition 01-01) , and Safety Code 6. The test has demonstrated that this unit complies with stipulated standards.

EUT Information

EUT Description	:	Remote control model
Model No	:	V8FT,V8JT,V8HT,DFT,DHT,DJT,V8FR,V8R4,V8R7,D8R,TFR8,TFR4,TFR6,TFR14,TF-8M,TF-14M
Serial No	:	N/A
Input Power	:	6-13VDC
Maximum Output Power to Antenna		17.67 dBm
Classification Per Stipulated Test Standard	:	Mobile Device
Co-located TX	:	N/A
Antenna Separation distances	:	N/A

Note : only the test result of worst case model, D8T(transmitter) & D8R (receiver) are measured and presented.

2 TECHNICAL DETAILS

Purpose	Compliance testing of 2.4G Radio System model V8FT,V8JT,V8HT,DFT,DHT,DJT,V8FR,V8R4,V8R7,D8R,TFR8,TFR4,TFR6,TF R14,TF-8M,TF-14M with stipulated standard
Applicant / Client	FrSky Electronic Co., Ltd
Manufacturer	FrSky Electronic Co., Ltd No.100 Jinxi Road, Wuxi, Jiangsu, China
Laboratory performing the tests	SIEMIC Laboratories
Test report reference number	1002720(SAR_FCC) Rev1.0
Date EUT received	Oct 18th 2010
Standard applied	See Page 9
Dates of test (from – to)	Oct 18th-Nov 01th 2010
No of Units:	1
Equipment Category:	Spread Spectrum System/Device
Trade Name:	FrSky Electronic Co., Ltd
Model Name:	V8FT,V8JT,V8HT,DFT,DHT,DJT,V8FR,V8R4,V8R7,D8R,TFR8,TFR4,TFR6,TF R14,TF-8M,TF-14M
RF Operating Frequency (ies)	2403.940MHz – 2448.305MHz
Number of Channels:	50
Modulation:	FSK
FCC ID:	XYFD8TD8R

3 INTRODUCTION

Introduction

This measurement report shows compliance of the EUT with FCC OET Bulletin 65 Supplement C (Edition 01-01).

The test procedures, as described in ANSI C95.1 – 1999 Standard for Safety Levels with Respect to Human Exposure to Radio Frequency Electromagnetic Fields, 3 kHz to 300 GHz [2], and ANSI C95.3 – 2002 Recommended Practice for the Measurement of Potentially Hazardous Electromagnetic Fields [3], were employed.

SAR Definition

Specific Absorption Rate is defined as the time derivative (rate) of the incremental energy (dW) absorbed by (dissipated in) an incremental mass (dm) contained in a volume element (dV) of a given density (ρ).

$$SAR = \frac{d}{dt} \left(\frac{dW}{dm} \right) = \frac{d}{dt} \left(\frac{dW}{\rho dV} \right)$$

SAR is expressed in units of watts per kilogram (W/kg). SAR can be related to the electric field at a point by

$$SAR = \frac{\sigma |E|^2}{\rho}$$

where:

- σ = conductivity of the tissue (S/m)
- ρ = mass density of the tissue (kg/m³)
- E = rms electric field strength (V/m)

4 SAR Measurement Setup

Dosimetric Assessment System

These measurements were performed with the automated near-field scanning system OPENSAR from SATIMO. The system is based on a high precision robot (working range: 850 mm), which positions the probes with a positional repeatability of better than ± 0.02 mm. Special E- and H-field probes have been developed for measurements close to material discontinuity, the sensors of which are directly loaded with a Schottky diode and connected via highly resistive lines to the data acquisition unit.

The SAR measurements were conducted with dosimetric probe (manufactured by SATIMO), designed in the classical triangular configuration and optimized for dosimetric evaluation. The probe has been calibrated according to the procedure described in SAR standard with accuracy of better than $\pm 10\%$. The spherical isotropy was evaluated with the procedure described in SAR standard and found to be better than ± 0.25 dB. The phantom used was the SAM Phantom as described in FCC supplement C, IEEE P1528 and CENELEC EN62209-1.

Measurement System Diagram

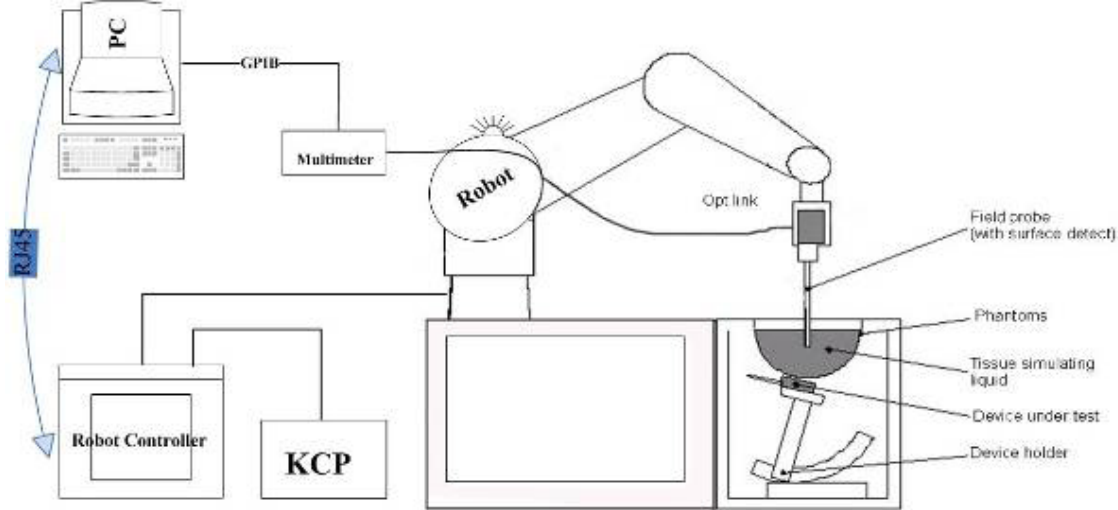

The OPENSAR system for performing compliance tests consist of the following items:

1. A standard high precision 6-axis robot (KUKA) with controller and software.
2. KUKA Control Panel (KCP).
3. A dosimetric probe, i.e., an isotropic E-field probe optimized and calibrated for usage in tissue simulating liquid. The probe is equipped with an optical surface detector system.
4. The functions of the PC plug-in card are to perform the time critical task such as signal filtering, surveillance of the robot operation fast movement interrupts.

5. A computer operating Windows XP.
6. OPENSAR software.
7. Remote control with teaches pendant and additional circuitry for robot safety such as warning lamps, etc.
8. The SAM phantom enabling testing left-hand right-hand and body usage.
9. The Position device for handheld EUT.
10. Tissue simulating liquid mixed according to the given recipes (see Application Note).
11. System validation dipoles to validate the proper functioning of the system.

EP100 Probe



Construction Symmetrical design with triangular Core. Built-in shielding against static charges Calibration in air from 100 MHz to 2.5 GHz. In brain and muscle simulating tissue at frequencies from 800 to 6000 MHz (accuracy of 8%) .

Frequency 100 MHz to 6 GHz;

Linearity ; 0.25 dB (100 MHz to 6 GHz) ,

Directivity : 0.25 dB in brain tissue (rotation around probe axis) 0.5 dB in brain tissue (rotation normal probe axis)

Dynamic : 0.001W/kg to > 100W/kg;

Range Linearity: 0.25 dB

Surface : 0.2 mm repeatability in air and liquids

Dimensions Overall length: 330 mm

Tip length: 16 mm

Body diameter: 8 mm

Tip diameter: 2.6 mm

Distance from probe tip to dipole centers: <1.5 mm

Application General dosimetric up to 6 GHz

Compliance tests of mobile phones

Fast automatic scanning in arbitrary phantoms

The SAR measurements were conducted with the dosimetric probe designed in the classical triangular configuration and optimized for dosimetric evaluation. The probe is constructed using the thick film technique, with printed resistive lines on ceramic substrates.

It is connected to the KRC box on the robot arm and provides an automatic detection of the phantom surface. The 3D file of the phantom is include in OpenSAR software. The Video Positioning System allow the system to take the automatic reference and to move the probe safely and accurately on the phantom.

E-Field Probe Calibration Process

Each probe is calibrated according to a dosimetric assessment procedure described in SAR standard with accuracy better than +/- 10%. The spherical isotropy was evaluated with the procedure described in SAR standard and found to be better than +/-0.25dB. The sensitivity parameters (NormX, NormY, NormZ), the diode compression parameter (DCP) and the conversion factor (ConvF) of the probe are tested.

The free space E-field from probe outputs is determined in a test chamber. This is performed in a TEM cell for frequencies bellow 0.8 GHz, and in a waveguide above 0.8 GHz for free space. For the free space calibration, the probe is placed in the volumetric center of the cavity and at the proper orientation with the field. E-field correlation calibration is performed in a flat phantom filled with the appropriate simulated brain tissue.

SAM Phantom

The SAM Phantom SAM29 is constructed of a fiberglass shell ntegrated in a wooden table. The shape of the shell is in compliance with the specification set in IEEE P1528 and CENELEC EN62209-1. The phantom enables the dosimetric evaluation of left and right hand phone usage as well as body mounted usage at the flat phantom region.

A cover prevents the evaporation of the liquid.

Reference markings on the Phantom allow the complete setup of all predefined phantom positions and measurement grids by manually teaching three points in the robot.

Shell Thickness: 2 0.2 mm

Filling Volume: Approx. 25 liters

Dimensions (H x L x W): 810 x 1000 x 500 mm

Liquid is filled to at least 15mm from the bottom of Phantom.



Device Holder

In combination with the Generic Twin Phantom V3.0, the Mounting Device enables the rotation of the mounted transmitter in spherical coordinates whereby the rotation points is the ear opening. The devices can be easily, accurately, and repeatedly positioned according to the FCC and CENELEC specifications. The device holder can be locked at different phantom locations (left head, right head, flat phantom).



Note: A simulating human hand is not used due to the complex anatomical and geometrical structure of the hand that may produced infinite number of configurations [10]. To produce the worst-case condition (the hand absorbs antenna output power), the hand is omitted during the tests.

Data Evaluation

The OPENSAR software automatically executes the following procedure to calculate the field units from the microvolt readings at the probe connector. The parameters used in the valuation are stored in the configuration modules of the software:

Probe Parameters	- Sensitivity	Norm _i
	- Conversion factor	ConvFi
	- Diode compression point Dcp _i	
Device Parameter	- Frequency	f
	- Crest factor	cf
Media Parametrs	- Conductivity	σ
	- Density	ρ

These parameters must be set correctly in the software. They can either be found in the component documents or be imported into the software from the configuration files issued for the OPENSAR components.

The first step of the evaluation is a linearization of the filtered input signal to account for the compression characteristics of the detector diode. The compensation depends on the input signal, the diode type and the DC-transmission factor from the diode to the evaluation electronics. If the exciting field is pulsed, the crest factor of the signal must be known to correctly compensate for peak power. The formula for each channel can be given as

$$V_i = U_i + U_i^2 \cdot \frac{cf}{dcp_i}$$

Where V_i = Compensated signal of channel i ($i = x, y, z$)
 U_i = Input signal of channel i ($i = x, y, z$)
 cf = Crest factor of exciting field (DASY parameter)
 dcp_i = Diode compression point (DASY parameter)

From the compensated input signals the primary field data for each channel can be evaluated:

$$E\text{-field probes: } E_i = \sqrt{\frac{V_i}{Norm_i \cdot ConvF}}$$

$$H\text{-field probes: } H_i = \sqrt{V_i} \cdot \frac{a_{i10} + a_{i11}f + a_{i12}f^2}{f}$$

Where V_i = Compensated signal of channel i ($i = x, y, z$)
 $Norm_i$ = Sensor sensitivity of channel i ($i = x, y, z$)
 $\mu V / (V/m)^2$ for E0field Probes
 $ConvF$ = Sensitivity enhancement in solution
 a_{ij} = Sensor sensitivity factors for H-field probes

f = Carrier frequency (GHz)
 E_i = Electric field strength of channel i in V/m
 H_i = Magnetic field strength of channel i in A/m

The RSS value of the field components gives the total field strength (Hermitian magnitude):

$$E_{tot} = \sqrt{E_x^2 + E_y^2 + E_z^2}$$

The primary field data are used to calculate the derived field units.

$$SAR = E_{tot}^2 \cdot \frac{\sigma}{\rho \cdot 1000}$$

where SAR = local specific absorption rate in mW/g
 E_{tot} = total field strength in V/m
 σ = conductivity in [mho/m] or [siemens/m]
 ρ = equivalent tissue density in g/cm³

Note that the density is normally set to 1 (or 1.06), to account for actual brain density rather than the density of the simulation liquid.

The power flow density is calculated assuming the excitation field as a free space field.

$$P_{pwe} = \frac{E_{tot}^2}{3770} \quad \text{or} \quad P_{pwe} = H_{tot}^2 \cdot 37.7$$

where P_{pwe} = Equivalent power density of a plane wave in mW/cm²
 E_{tot} = total electric field strength in V/m
 H_{tot} = total magnetic field strength in A/m

SAR Evaluation – Peak Spatial - Average

The procedure for assessing the peak spatial-average SAR value consists of the following steps

- **Power Reference Measurement**

The reference and drift jobs are useful jobs for monitoring the power drift of the device under test in the batch process. Both jobs measure the field at a specified reference position, at a selectable distance from the phantom surface. The reference position can be either the selected section's grid reference point or a user point in this section. The reference job projects the selected point onto the phantom surface, orients the probe perpendicularly to the surface, and approaches the surface using the selected detection method.

- **Area Scan**

The area scan is used as a fast scan in two dimensions to find the area of high field values, before doing a finer measurement around the hot spot. The sophisticated interpolation routines implemented in OPENSAR software can find the maximum locations even in relatively coarse grids. The scan area is defined by an editable grid. This grid is anchored at the grid reference point of the selected section in the phantom. When the area scan's property sheet is brought-up, grid was at to 15 mm by 15 mm and can be edited by a user.

- **Zoom Scan**

Zoom scans are used to assess the peak spatial SAR values within a cubic averaging volume containing 1 g and 10 g of simulated tissue. The default zoom scan measures 5 x 5 x 7 points within a cube whose base faces are centered around the maximum found in a preceding area scan job within the same procedure. If the preceding Area Scan job indicates more than one maximum, the number of Zoom Scans has to be enlarged accordingly (The default number inserted is 1).

- **Power Drift measurement**

The drift job measures the field at the same location as the most recent reference job within the same procedure, and with the same settings. The drift measurement gives the field difference in dB from the reading conducted within the last reference measurement. Several drift measurements are possible for one reference measurement. This allows a user to monitor the power drift of the device under test within a batch process. In the properties of the Drift job, the user can specify a limit for the drift and have OPENSAR software stop the measurements if this limit is exceeded.

SAR Evaluation – Peak SAR

The procedure for spatial peak SAR evaluation has been implemented according to the IEEE1529 standard. It can be conducted for 1 g and 10 g. The OPENSAR system allows evaluations that combine measured data and robot positions, such as:

- maximum search
- extrapolation
- boundary correction
- peak search for averaged SAR

During a maximum search, global and local maximum searches are automatically performed in 2-D after each Area Scan measurement with at least 6 measurement points. It is based on the evaluation of the local SAR gradient calculated by the Quadratic Shepard's method. The algorithm will find the global maximum and all local maxima within -2 dB of the global maxima for all SAR distributions.

Extrapolation

Extrapolation routines are used to obtain SAR values between the lowest measurement points and the inner phantom surface. The extrapolation distance is determined by the surface detection distance and the probe sensor offset. Several measurements at different distances are necessary for the extrapolation. They are used in the Cube Scan to obtain SAR values between the lowest measurement points and the inner phantom surface. The routine uses the fourth order least square polynomial method for extrapolation. For a grid using 5x5x7 measurement points with 5mm resolution amounting to 343 measurement points, the uncertainty of the extrapolation routines is less than 1% for 1 g and 10 g cubes.

Definition of Reference Points

Ear Reference Point

Figure 6.2 shows the front, back and side views of the SAM Phantom. The point "M" is the reference point for the center of the mouth, "LE" is the left ear reference point (ERP), and "RE" is the right ERP. The ERPs are 15mm posterior to the entrance to the ear canal (EEC) along the B-M line (Back-Mouth), as shown in Figure 6.1. The plane passing through the two ear canals and M is defined as the Reference Plane. The line N-F (Neck-Front) is perpendicular to the reference plane and passing through the RE (or LE) is called the Reference Pivoting Line (see Figure 6.1). Line B-M is perpendicular to the N-F line. Both N-F and B-M lines are marked on the external phantom shell to facilitate handset positioning [5].

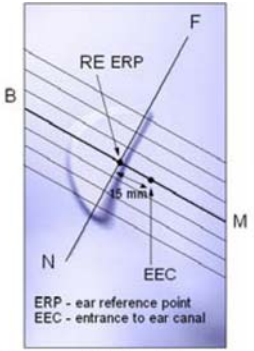

Figure 6.1 Close-up side view of ERP's



Figure 6.2 Front, back and side view of SAM

Device Reference Points

Two imaginary lines on the device need to be established: the vertical centerline and the horizontal line. The test device is placed in a normal operating position with the "test device reference point" located along the "vertical centerline" on the front of the device aligned to the "ear reference point" (See Fig. 6.3). The "test device reference point" is then located at the same level as the center of the ear reference point. The test device is positioned so that the "vertical centerline" is bisecting the front surface of the device at its top and bottom edges, positioning the "ear reference point" on the outer surface of both the left and right head phantoms on the ear reference point [5].

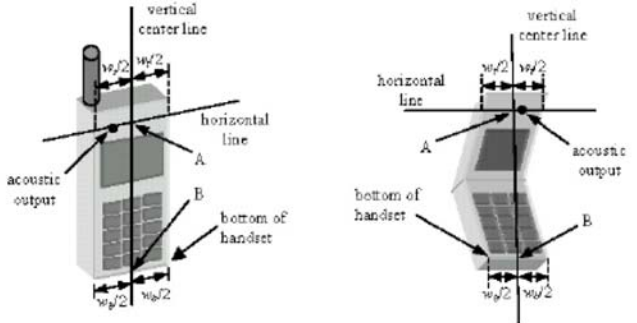

Figure 6.3 Handset Vertical Center & Horizontal Line Reference Points

Test Configuration – Positioning for Cheek / Touch

1. Position the device close to the surface of the phantom such that point A is on the (virtual) extension of the line passing through points RE and LE on the phantom (see Figure below), such that the plane defined by the vertical center line and the horizontal line of the device is approximately parallel to the sagittal plane of the phantom

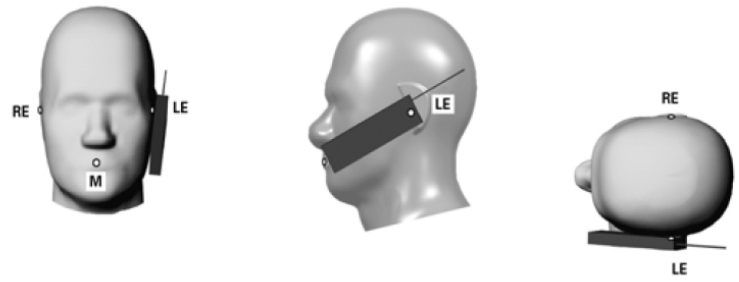

Figure 7.1 Front, Side and Top View of Cheek/Touch Position

2. Translate the device towards the phantom along the line passing through RE and LE until the device touches the ear.
3. While maintaining the device in this plane, rotate it around the LE-RE line until the vertical centerline is in the plane normal to MB-NF including the line MB (called the reference plane).
4. Rotate the device around the vertical centerline until the device (horizontal line) is symmetrical with respect to the line NF.
5. While maintaining the vertical centerline in the reference plane, keeping point A on the line passing through RE and LE and maintaining the device contact with the ear, rotate the device about the line NF until any point on the device is in contact with a phantom point below the ear (cheek). See Figure below.

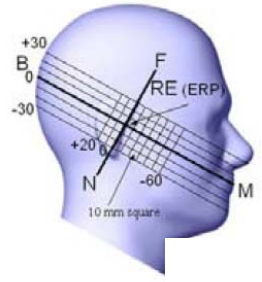

Figure 7.2 Side view w/ relevant markings

Test Configuration – Positioning for Ear / 15° Tilt

With the test device aligned in the Cheek/Touch Position”:

1. While maintaining the orientation of the device, retracted the device parallel to the reference plane far enough to enable a rotation of the device by 15 degrees.
2. Rotate the device around the horizontal line by 15 degrees.
3. While maintaining the orientation of the device, move the device parallel to the reference plane until any part of the device touches the head. (In this position, point A is located on the line RE-LE). The tilted position is obtained when the contact is on the pinna. If the contact is at any location other than the pinna, the angle of the device shall be reduced. The tilted position is obtained when any part of the device is in contact with the ear as well as a second part of the device is in contact with the head (see Figure below).

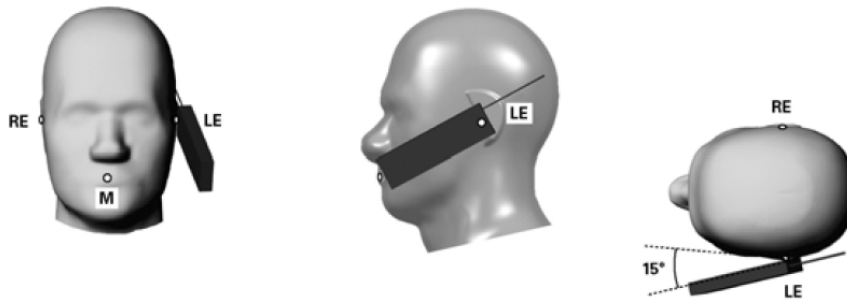

Figure 7.3 Front, Side and Top View of Ear/15° Tilt Position

Test Position – Body Worn Configurations

Body-worn operating configurations are tested with the accessories attached to the device and positioned against a flat phantom in a normal use configuration. A device with a headset output is tested with a headset connected to the device. Body dielectric parameters are used.

Accessories for Body-worn operation configurations are divided into two categories: those that do not contain metallic components and those that do contain metallic components. When multiple accessories that do not contain metallic components are supplied with the device, the device is tested with only the accessory that dictates the closest spacing to the body. Then, when multiple accessories that contain metallic components are supplied with the device, the device is tested with each accessory that contains a unique metallic component. If multiple accessories share an identical metallic component (i.e. the same metallic belt-clip used with different holsters with no other metallic components) only the accessory that dictates the closest spacing to the body is tested.

Body-worn accessories may not always be supplied or available as options for some devices intended to be authorized for body-worn use. In this case, a test configuration where a separation distance between the back of the device and the flat phantom is used. All test position spacings are documented.

Transmitters that are designed to operate in front of a person’s face, as in push-to-talk configurations, are tested for SAR compliance with the front of the device positioned to face the flat phantom. For devices that are carried next to the body such as a shoulder, waist or chest-worn transmitters, SAR compliance is tested with the accessory(ies), including headsets and microphones, attached to the device and positioned against a flat phantom in a normal use configuration.

In all cases SAR measurements are performed to investigate the worst-case positioning. Worst-case positioning is then documented and used to perform Body SAR testing.

5 ANSI/IEEE C95.1 – 1999 RF Exposure Limit

In order for users to be aware of the body-worn operating requirements for meeting RF exposure compliance, operating instructions and cautions statements are included in the user’s manual.

Uncontrolled Environment

Uncontrolled Environments are defined as locations where there is the exposure of individuals who have no knowledge or control of their exposure. The general population/uncontrolled exposure limits are applicable to situations in which the general public may be exposed or in which persons who are exposed as a consequence of their employment may not be made fully aware of the potential for exposure or cannot exercise control over their exposure. Members of the general public would come under this category when exposure is not employment-related; for example, in the case of a wireless transmitter that exposes persons in its vicinity.

Controlled Environment

Controlled Environments are defined as locations where there is exposure that may be incurred by persons who are aware of the potential for exposure, (i.e. as a result of employment or occupation). In general, occupational/controlled exposure limits are applicable to situations in which persons are exposed as a consequence of their employment, who have been made fully aware of the potential for exposure and can exercise control over their exposure. This exposure category is also applicable when the exposure is of a transient nature due to incidental passage through a location where the exposure levels may be higher than the general population/uncontrolled limits, but the exposed person is fully aware of the potential for exposure and can exercise control over his or her exposure by leaving the area or by some other appropriate means.

Table 8.1 Human Exposure Limits

	UNCONTROLLED ENVIRONMENT General Population (W/kg) or (mW/g)	CONTROLLED ENVIROMENT Professional Population (W/kg) or (mW/g)
SPATIAL PEAK SAR ¹ Brain	1.60	8.00
SPATIAL AVERAGE SAR ² Whole Body	0.08	0.40
SPATIAL PEAK SAR ³ Hands, Feet, Ankles, Wrists	4.00	20.00

¹ The Spatial Peak value of the SAR averaged over any 1 gram of tissue (defined as a tissue volume in the shape of a cube) and over the appropriate averaging time.
² The Spatial Average value of the SAR averaged over the whole body.
³ The Spatial Peak value of the SAR averaged over any 10 grams of tissue (defined as a tissue volume in the shape of a cube) and over the appropriate averaging time.

6 SYSTEM AND LIQUID VALIDATION

System Validation

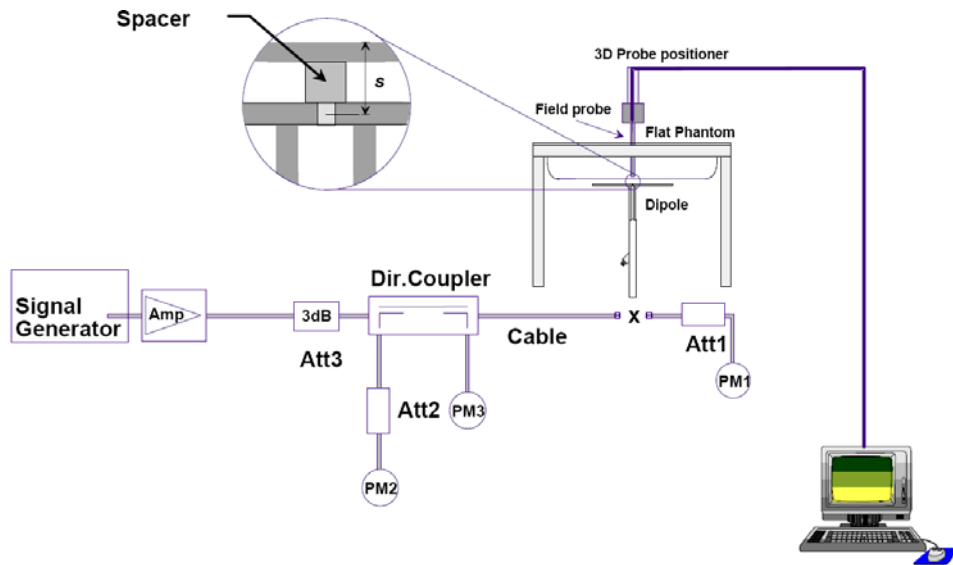

Fig 8.1 System Setup for System Evaluation

The system performance check verifies that the system operates within its specifications. System and operator errors can be detected and corrected. It is recommended that the system performance check be performed prior to any usage of the system in order to guarantee reproducible results. The system performance check uses normal SAR measurements in a simplified setup with a well characterized source. This setup was selected to give a high sensitivity to all parameters that might fail or vary over time. The system check does not intend to replace the calibration of the components, but indicates situations where the system uncertainty is exceeded due to drift or failure.

In the simplified setup for system evaluation, the DUT is replaced by a calibrated dipole and the power source is replaced by a continuous wave that comes from a signal generator. The calibrated dipole must be placed beneath the flat phantom section of the SAM twin phantom with the correct distance holder. The distance holder should touch the phantom surface with a light pressure at the reference marking and be oriented parallel to the long side of the phantom. The equipment setup is shown below:

1. Signal Generator
2. Amplifier
3. Directional Coupler
4. Power Meter
5. Calibrated Dipole

The output power on dipole port must be calibrated to 30 dBm (1000 mW) before dipole is connected.

Numerical reference SAR values (W/kg) for reference dipole and flat phantom

Frequency (MHz)	1 g SAR	10 g SAR	Local SAR at surface (above feed-point)	Local SAR at surface (y = 2 cm offset from feed-point) ^a
300	3.0	2.0	4.4	2.1
450	4.9	3.3	7.2	3.2
835	9.5	6.2	4.1	4.9
900	10.8	6.9	16.4	5.4
1450	29.0	16.0	50.2	6.5
1800	38.1	19.8	69.5	6.8
1900	39.7	20.5	72.1	6.6
2000	41.1	21.1	74.6	6.5
2450	52.4	24.0	104.2	7.7
3000	63.8	25.7	140.2	9.5

Target and measurement SAR after Normalized

Measurement Date	Frequency (MHz)	Target SAR1g (W/kg)	Measured SAR1g (W/kg)	Deviation (%)
Oct 27 2010	2450	52.4	51.390	-1.93

Liquid Validation

The dielectric parameters were checked prior to assessment using the HP85070C dielectric probe kit. The dielectric parameters measured are reported in each correspondent section.

IEEE SCC-34/SC-2 P1528 recommended Tissue Dielectric Parameters

The head tissue dielectric parameters recommended by the IEEE SCC-34/SC-2 in P1528 have been incorporated in the following table. These head parameters are derived from planar layer models simulating the highest expected SAR for the dielectric properties and tissue thickness variations in a human head. Other head and body tissue parameters that have not been specified in P1528 are derived from the tissue dielectric parameters computed from the 4-Cole-Cole equations and extrapolated according to the head parameters specified in P1528

Target Frequency	Head		Body	
MHz	ϵ_r	σ (S/m)	ϵ_r	σ (S/m)
150	52.3	0.76	61.9	0.80
300	45.3	0.87	58.2	0.92
450	43.5	0.87	56.7	0.94
835	41.5	0.90	55.2	0.97
900	41.5	0.97	55.0	1.05
915	41.5	0.98	55.0	1.06
1450	40.5	1.20	54.0	1.30
1610	40.3	1.29	53.8	1.40
1800-2000	40.0	1.40	53.3	1.52
2450	39.2	1.80	52.7	1.95
3000	38.5	2.40	52.0	2.73
5800	35.3	5.27	48.2	6.00

Note: ϵ_r = relative permittivity, σ = conductivity and $\rho = 1000 \text{ kg/m}^3$

Liquid Confirmation Result :

Temperature: <u>21°C</u>		Relative humidity: <u>58%</u>			
2450MHz		Target	Measured	Deviation (%)	Limit (%)
Head	Permittivity	39.2	38.89	-0.79	5
	Conductivity	1.80	1.83	0.17	5
Body	Permittivity	52.7	53.12	0.80	5
	Conductivity	1.95	1.962	0.62	5

System Validation Plots

Product Description : Mobile Computer

Model : D8T D8R

Test Date : Oct 27 2010

Frequency (MHz)	2451.000000(Head)
Relative permittivity (real part)	39.198727
Relative permittivity (imaginary part)	13.222145
Conductivity (S/m)	1.800415
Variation (%)	-0.390000
SAR 1g (W/Kg)	5.139499

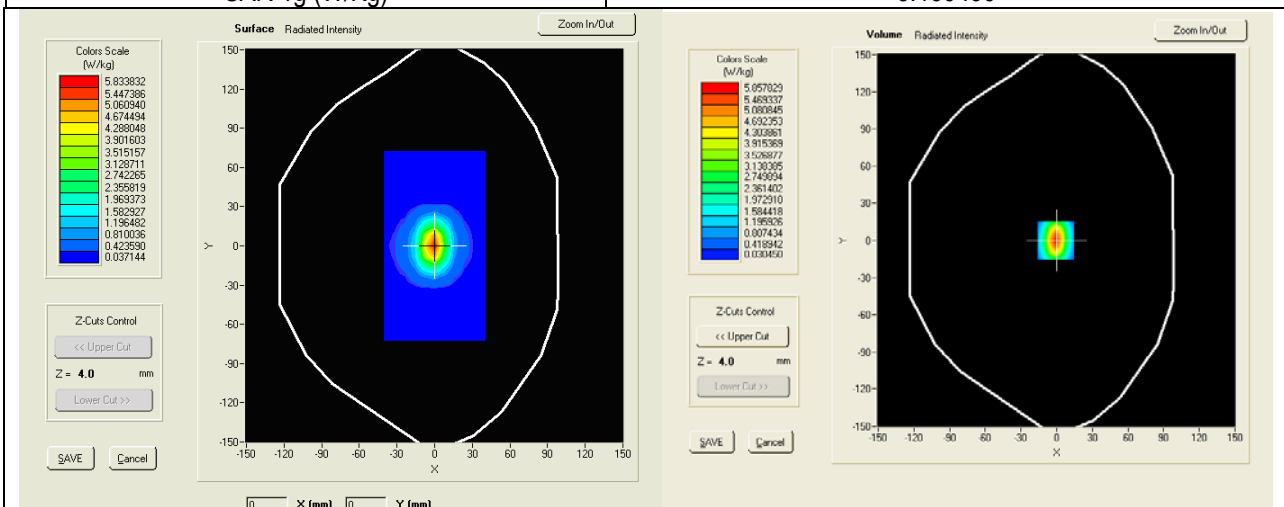

SAR, Z Axis Scan (X = -1, Y = 0)

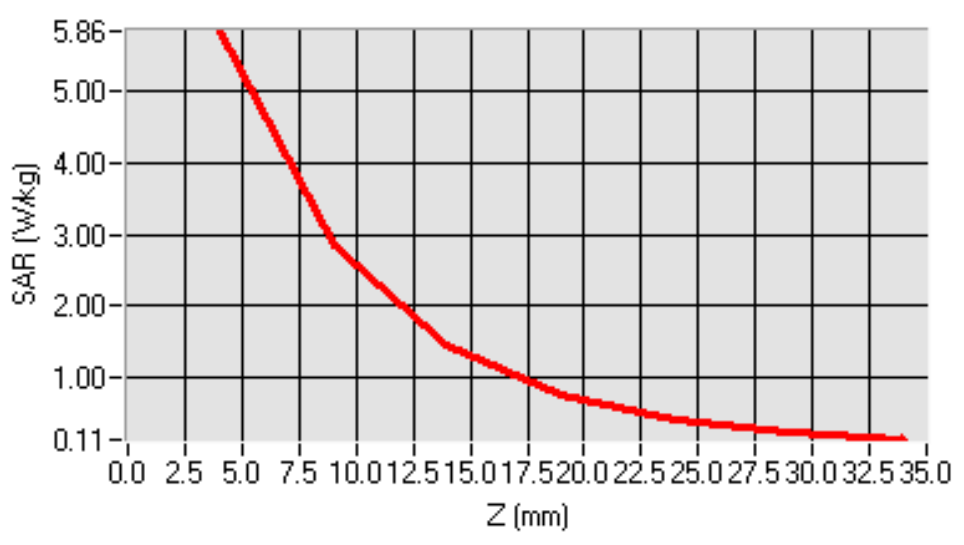

7 TYPE A MEASUREMENT UNCERTAINTY

The component of uncertainty may generally be categorized according to the methods used to evaluate them. The evaluation of uncertainty by the statistical analysis of a series of observations is termed a Type A evaluation of uncertainty. The evaluation of uncertainty by means other than the statistical analysis of a series of observation is termed a Type B evaluation of uncertainty. Each component of uncertainty, however evaluated, is represented by an estimated standard deviation, termed standard uncertainty, which is determined by the positive square root of the estimated variance

A Type A evaluation of standard uncertainty may be based on any valid statistical method for treating data. This includes calculating the standard deviation of the mean of a series of independent observations; using the method of least squares to fit a curve to the data in order to estimate the parameter of the curve and their standard deviations; or carrying out an analysis of variance in order to identify and quantify random effects in certain kinds of measurement.

A type B evaluation of standard uncertainty is typically based on scientific judgment using all of the relevant information available. These may include previous measurement data, experience and specification, data provided in calibration reports and uncertainties assigned to reference data taken from handbooks. Broadly speaking, the uncertainty is either obtained from an outdoor source or obtained from an assumed distribution, such as the normal distribution, rectangular or triangular distributions indicated in Table below :

Uncertainty Distribution	Normal	Rectangle	Triangular	U Shape
Multi-plying Factor ^(a)	1/ $k^{(b)}$	1 / $\sqrt{3}$	1 / $\sqrt{6}$	1 / $\sqrt{2}$

(a) standard uncertainty is determined as the product of the multiplying factor and the estimated range of variations in the measured quantity

(b) k is the coverage factor

Standard Uncertainty for Assumed Distribution

The combined standard uncertainty of the measurement result represents the estimated standard deviation of the result. It is obtained by combining the individual standard uncertainties of both Type A and Type B -sum-by taking the positive square root of the estimated variances.

Expanded uncertainty is a measure of uncertainty that defines an interval about the measurement result within which the measured value is confidently believed to lie. It is obtained by multiplying the combined standard uncertainty by a coverage factor. Typically, the coverage factor ranges from 2 to 3. Using a coverage factor allows the true value of a measured quantity to be specified with a defined probability within the specified uncertainty range. For purpose of this document, a coverage factor two is used, which corresponds to confidence interval of about 95 %.

The COMOSAR Uncertainty Budget is show in below table :

Uncertainty Budget of COMOSAR for frequency range 300 MHz to 6 GHz

Uncertainty Component	Tolerances %	Probability Distribution	Divisor	Ci (1g)	Ci (10g)	Uncertainty 1g(%)	Uncertainty 10g(%)
Measurement System Related							
Probe Calibration	6	N	1	1	1	6	6
Axial Isotropy	3	R	$\sqrt{3}$	$\sqrt{(1-Cp)}$	$\sqrt{(1-Cp)}$	1.22474	1.22474
Hemispherical Isotropy	4	R	$\sqrt{3}$	\sqrt{Cp}	\sqrt{Cp}	1.63299	1.63299
Boundary Effect	1	R	$\sqrt{3}$	1	1	0.57735	0.57735
Linearity	5	R	$\sqrt{3}$	1	1	2.88675	2.88675
System Detection Limits	1	R	$\sqrt{3}$	1	1	0.57735	0.57735
Readout Electronics	0.5	N	1	1	1	0.5	0.5
Response Time	0.2	R	$\sqrt{3}$	1	1	0.11547	0.11547
Integration Time	2	R	$\sqrt{3}$	1	1	1.1547	1.1547
RF Ambient Conditions	3	R	$\sqrt{3}$	1	1	1.73205	1.73205
Probe Positioner Mechanical Tolerances	2	R	$\sqrt{3}$	1	1	1.1547	1.1547
Probe Positioning with respect to Phantom Shell	1	R	$\sqrt{3}$	1	1	0.57735	0.57735
Extrapolation, Interpolation and integration Algorithms for Max. SAR Evaluation.	1.5	R	$\sqrt{3}$	1	1	0.86603	0.86603
Test Sample Related							
Test Sample Positioning	1.5	N	1	1	1	1.5	1.5
Device Holder Uncertainty	5	N	1	1	1	5	5
Output Power Variation – SAR Drift measurement	3	R	$\sqrt{3}$	1	1	1.73205	1.73205
Phantom and Tissue Parameters Related							
Phantom Uncertainty (Shape and thickness Tolerances)	4	R	$\sqrt{3}$	1	1	2.3094	2.394
Liquid Conductivity – deviation from target value	5	R	$\sqrt{3}$	0.64	0.43	1.84752	1.2413
Liquid Conductivity – Measurement Uncertainty	2.5	N	1	0.64	0.43	1.6	1.075
Liquid Permittivity – deviation from target value	3	R	$\sqrt{3}$	0.6	0.49	1.03923	0.8487
Liquid Permittivity – Measurement Uncertainty	2.5	N	1	0.6	0.49	1.5	1.225
Combined Standard Uncertainty						9.66051 %	9.52428 %
Expanded Standard Uncertainty (K=2 , confidence 95%)						18.9346 %	18.6676 %

8 OUTPUT POWER VERIFICATION

8.1 Transmitter Output Power

Channel	Frequency (MHz)	Peak Output Power(dBm)
Low	2403.940	17.33
Mid	2425.874	17.33
High	2448.305	17.67

9 SAR TEST RESULTS

SAR Test Result

Body Worn(Separation distance : 0cm) :

Test Configuration	Body	Antenna orientation	Date of Measured	Oct 27 2010	
Freq Band	Channel		SAR 10g (W/kg)	SAR 1g(W/kg)	Limit (W/kg)
2403.940MHz	Low	Left side orientation	0.109	0.238	1.6
2403.940MHz	Low	Right side orientation	0.207	0.497	1.6
2403.940MHz	Low	Front orientation	0.462	0.991	1.6
2403.940MHz	Low	Vertical down orientation	0.010	0.024	1.6

Body Worn(Separation distance : 0cm) :

Test Configuration	Body	Antenna orientation	Date of Measured	Oct 27 2010	
Freq Band	Channel		SAR 10g (W/kg)	SAR 1g(W/kg)	Limit (W/kg)
2425.874MHz	Mid	Left side orientation	0.519	1.083	1.6
2425.874MHz	Mid	Right side orientation	0.218	0.524	1.6
2425.874MHz	Mid	Front orientation	0.538	1.350	1.6
2425.874MHz	Mid	Vertical down orientation	0.030	0.068	1.6

Body Worn(Separation distance : 0cm) :

Test Configuration	Body	Antenna orientation	Date of Measured	Oct 27 2010	
Freq Band	Channel		SAR 10g (W/kg)	SAR 1g(W/kg)	Limit (W/kg)
2448.305MHz	High	Left side orientation	0.416	0.870	1.6
2448.305MHz	High	Right side orientation	0.145	0.384	1.6
2448.305MHz	High	Front orientation	0.533	1.408	1.6
2448.305MHz	High	Vertical down orientation	0.015	0.030	1.6

SAR measurement Plots

Product Description : 2.4G Radio system
 Model : D8T D8R
 Test Date : Oct 27 2010

Antenna Orientation : Left side orientation (Low channel)

Frequency (MHz)	2403.940000
Relative permittivity (real part)	52.764000
Relative permittivity (imaginary part)	14.260667
Conductivity (S/m)	1.903007
Variation (%)	2.560000
SAR 1g (W/Kg)	0.237919
SURFACE SAR	VOLUME SAR

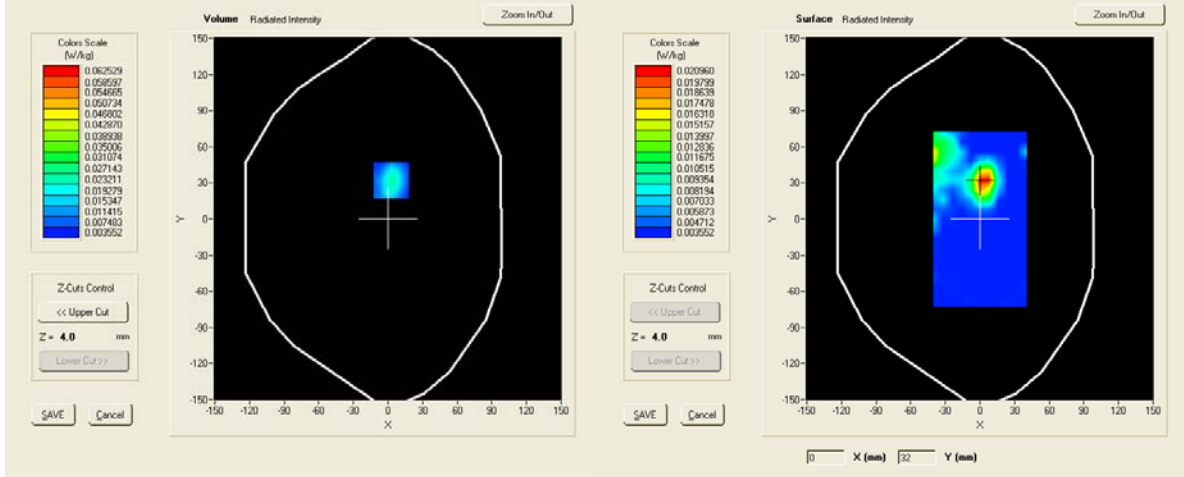

SAR, Z Axis Scan (X = 3, Y = 32)

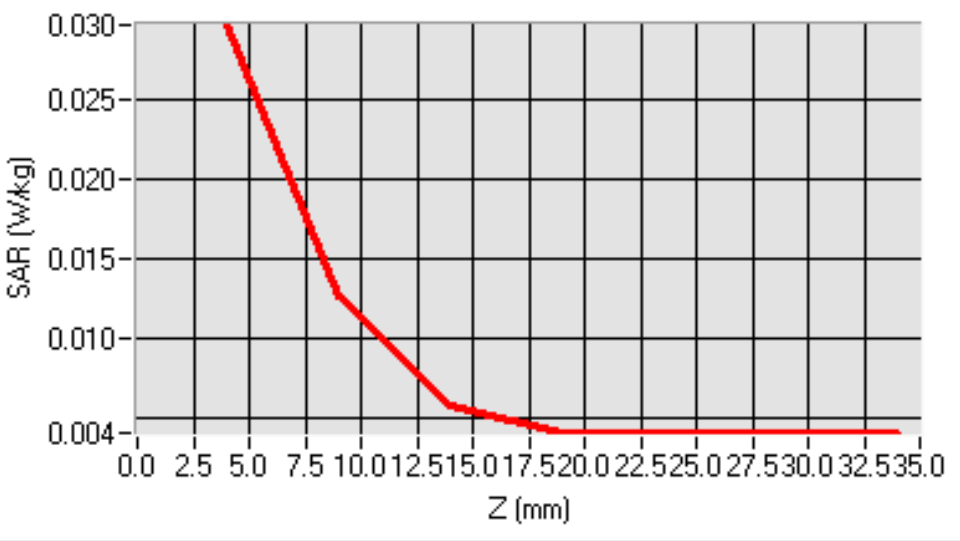

Product Description : 2.4G Radio system
Model : D8T D8R
Test Date : Oct 27 2010

Antenna Orientation : Right orientation (Low channel)

Frequency (MHz)	2403.940000
Relative permittivity (real part)	52.764000
Relative permittivity (imaginary part)	14.260667
Conductivity (S/m)	1.903007
Variation (%)	-1.230000
SAR 1g (W/Kg)	0.497016
SURFACE SAR	VOLUME SAR

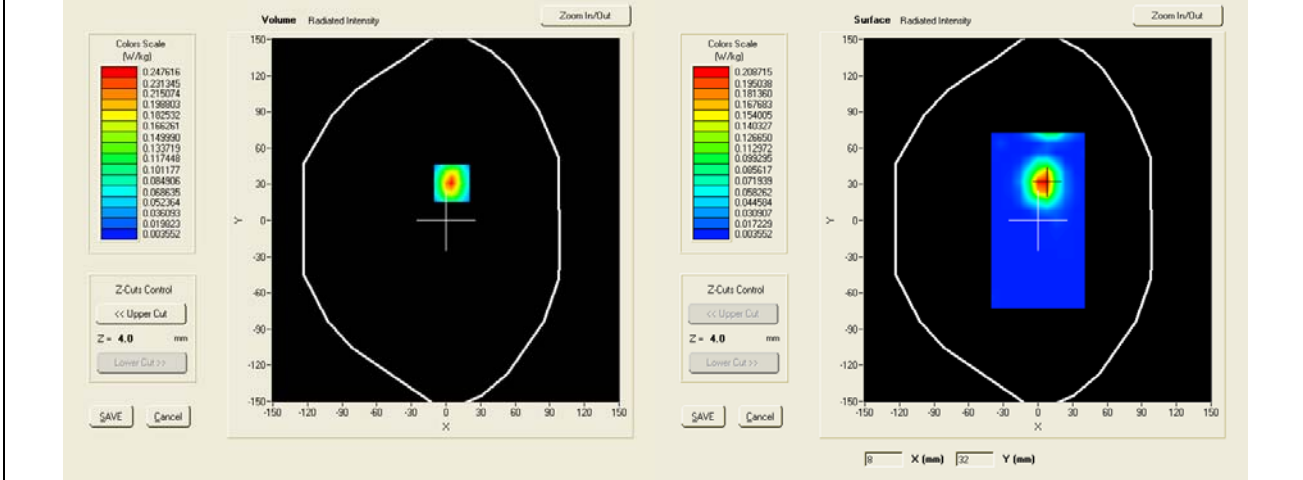

SAR, Z Axis Scan (X = 5, Y = 31)

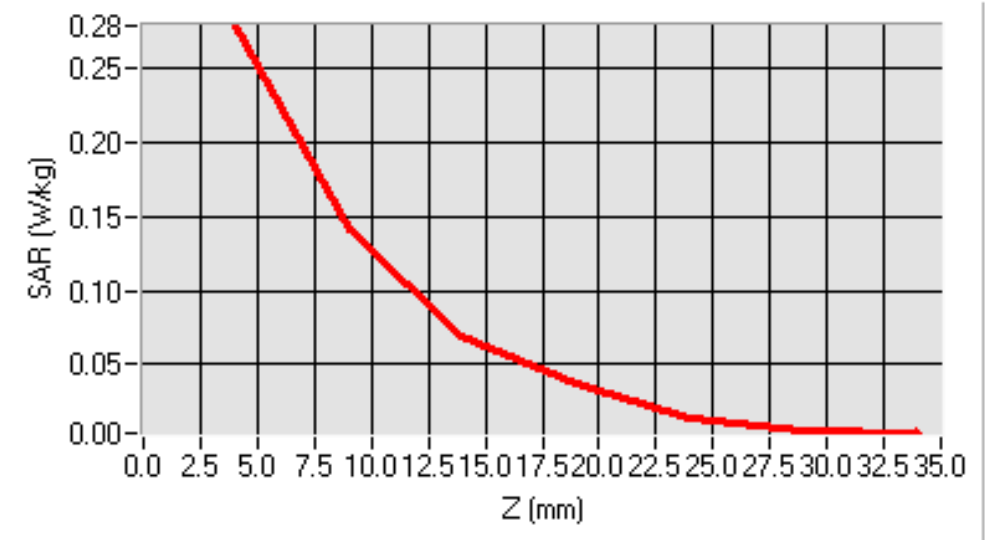

Product Description : 2.4G Radio system
Model : D8T D8R
Test Date : Oct 27 2010

Antenna Orientation : Front orientation (Low channel)

Frequency (MHz)	2403.940000
Relative permittivity (real part)	52.764000
Relative permittivity (imaginary part)	14.260667
Conductivity (S/m)	1.903007
Variation (%)	-2.900000
SAR 1g (W/Kg)	0.991391
SURFACE SAR	VOLUME SAR

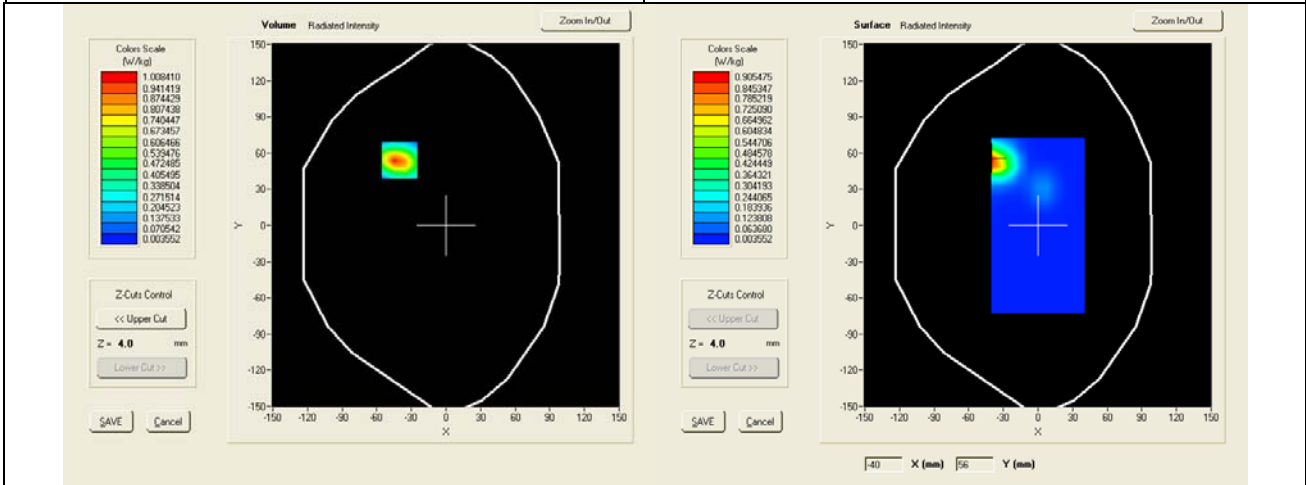

SAR, Z Axis Scan (X = -40, Y = 54)

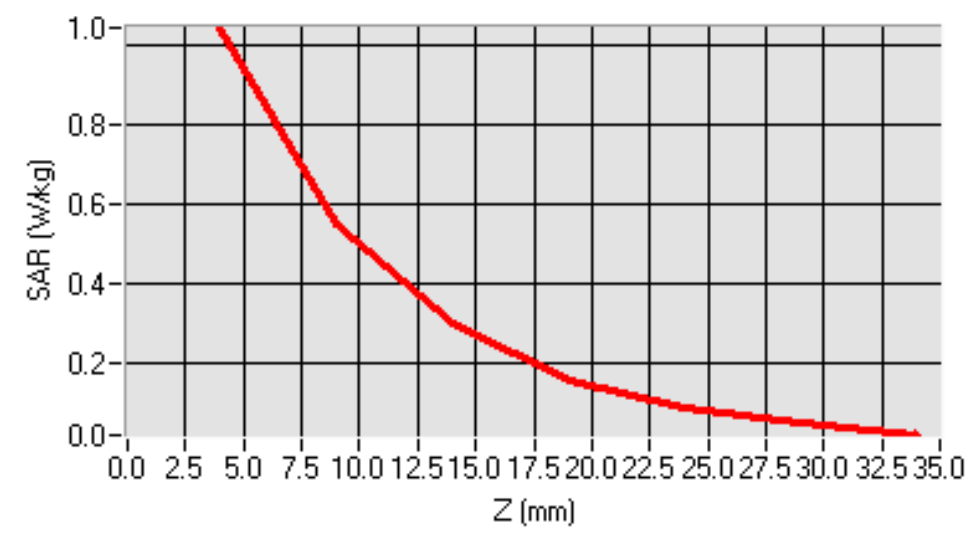

Product Description : 2.4G Radio system
 Model : D8T D8R
 Test Date : Oct 27 2010

Antenna Orientation : Vertical down orientation (Low channel)

Frequency (MHz)	2403.940000
Relative permittivity (real part)	52.764000
Relative permittivity (imaginary part)	14.260667
Conductivity (S/m)	1.903007
Variation (%)	2.370000
SAR 1g (W/Kg)	0.024502
SURFACE SAR	VOLUME SAR

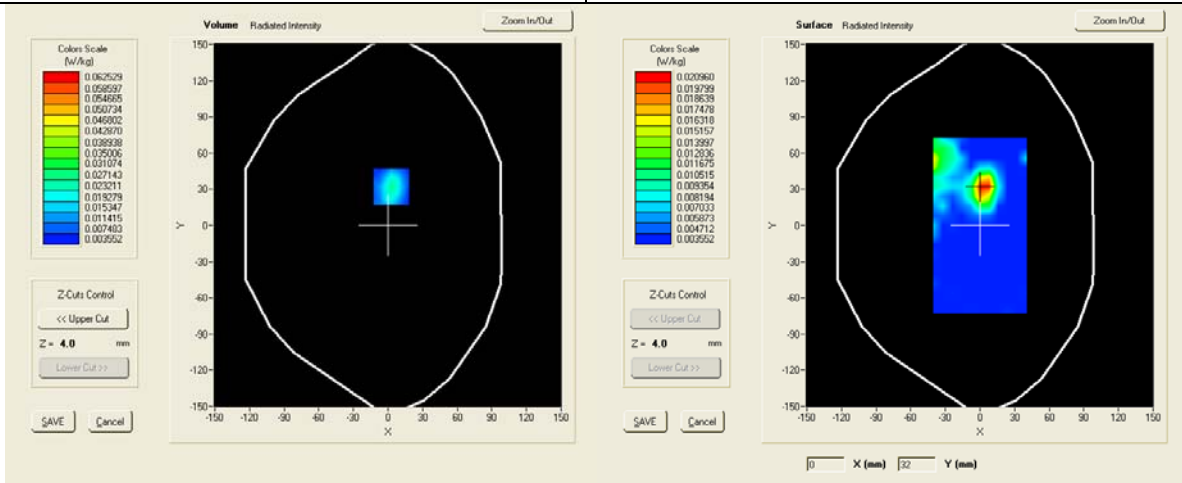

SAR, Z Axis Scan (X = 3, Y = 32)

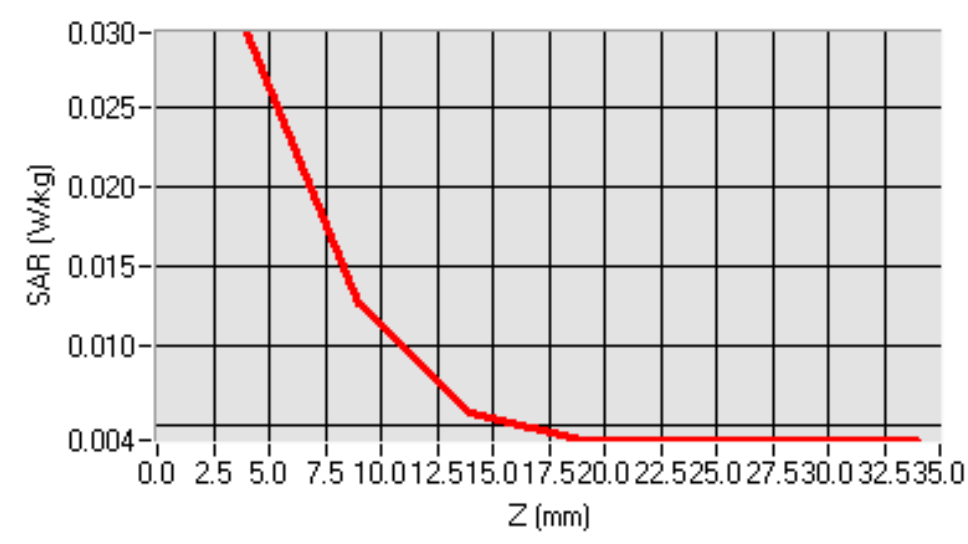

Product Description : 2.4G Radio system
 Model : D8T D8R
 Test Date : Oct 27 2010

Antenna Orientation : Left side orientation (Mid channel)

Frequency (MHz)	2425.874000
Relative permittivity (real part)	52.714668
Relative permittivity (imaginary part)	14.314111
Conductivity (S/m)	1.939562
Variation (%)	4.230000
SAR 1g (W/Kg)	1.083671
SURFACE SAR	VOLUME SAR

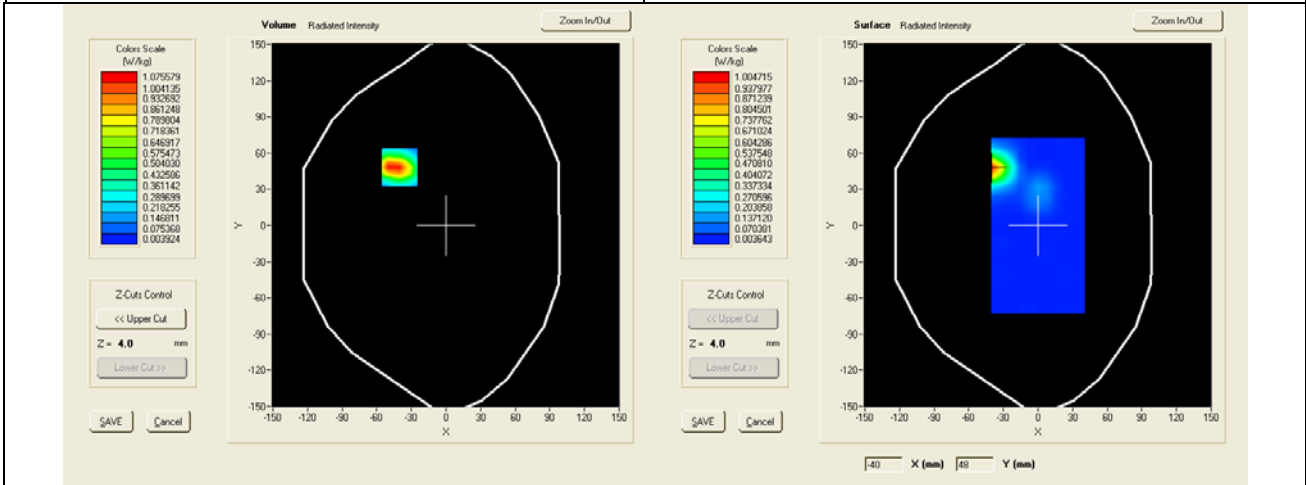

SAR, Z Axis Scan (X = -40, Y = 48)

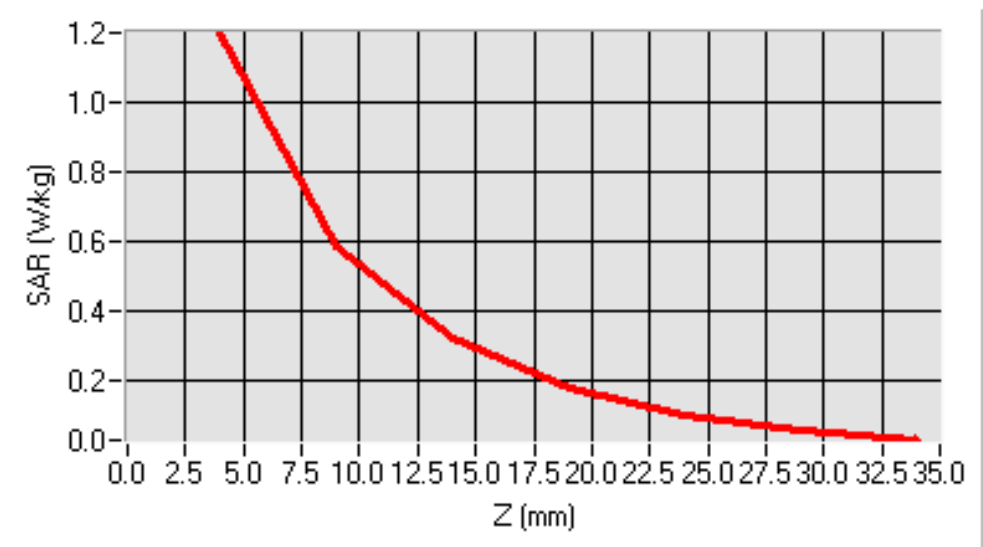

Product Description : 2.4G Radio system
Model : D8T D8R
Test Date : Oct 27 2010

Antenna Orientation : Right side orientation (Mid channel)

Frequency (MHz)	2425.874000
Relative permittivity (real part)	52.714668
Relative permittivity (imaginary part)	14.314111
Conductivity (S/m)	1.939562
Variation (%)	-2.760000
SAR 1g (W/Kg)	0.524272
SURFACE SAR	VOLUME SAR

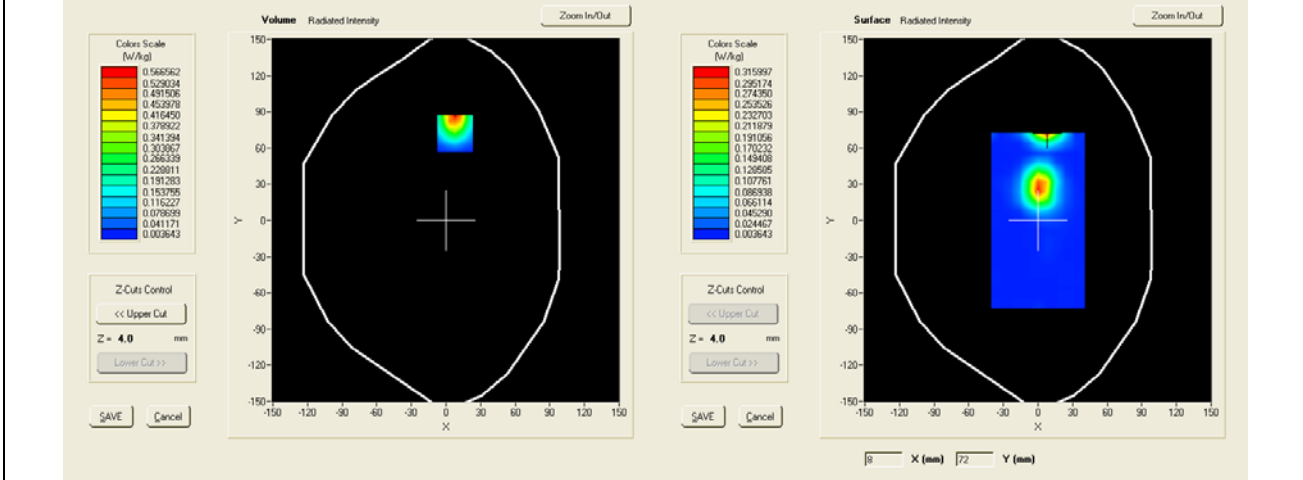

SAR, Z Axis Scan (X = 8, Y = 72)

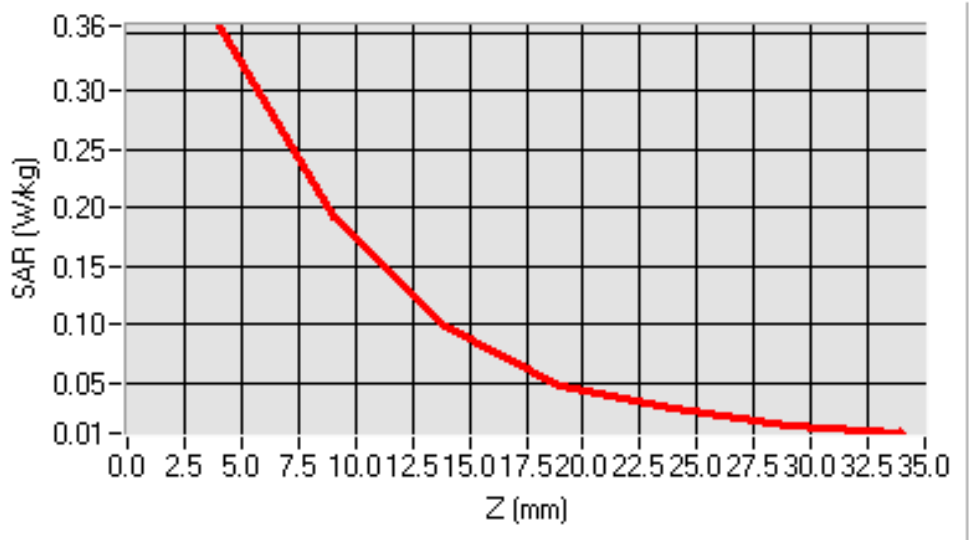

Product Description : 2.4G Radio system
Model : D8T D8R
Test Date : Oct 27 2010

Antenna Orientation : Front orientation (Mid channel)

Frequency (MHz)	2425.874000
Relative permittivity (real part)	52.714668
Relative permittivity (imaginary part)	14.314111
Conductivity (S/m)	1.939562
Variation (%)	0.540000
SAR 1g (W/Kg)	1.350278
SURFACE SAR	VOLUME SAR

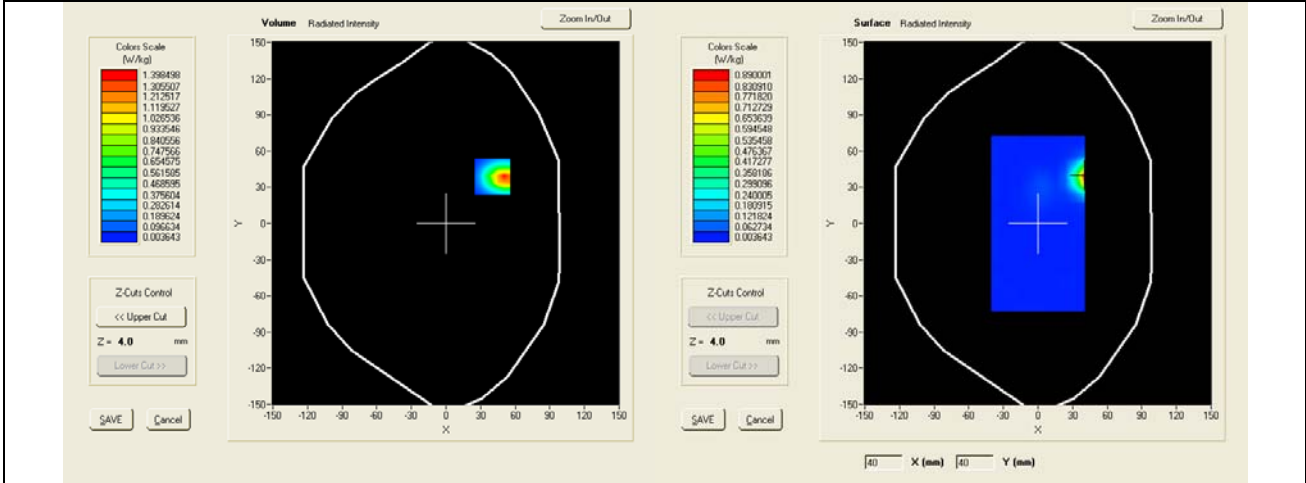

SAR, Z Axis Scan (X = 40, Y = 39)

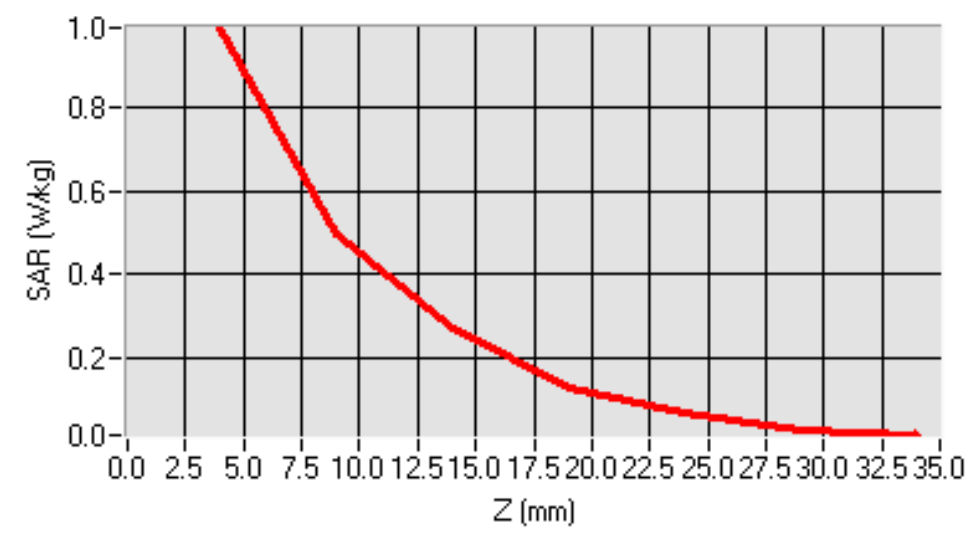

Product Description : 2.4G Radio system
Model : D8T D8R
Test Date : Oct 27 2010

Antenna Orientation : Vertical down orientation (Mid channel)

Frequency (MHz)	2425.874000
Relative permittivity (real part)	52.714668
Relative permittivity (imaginary part)	14.314111
Conductivity (S/m)	1.939562
Variation (%)	-1.250000
SAR 1g (W/Kg)	0.067763
SURFACE SAR	VOLUME SAR

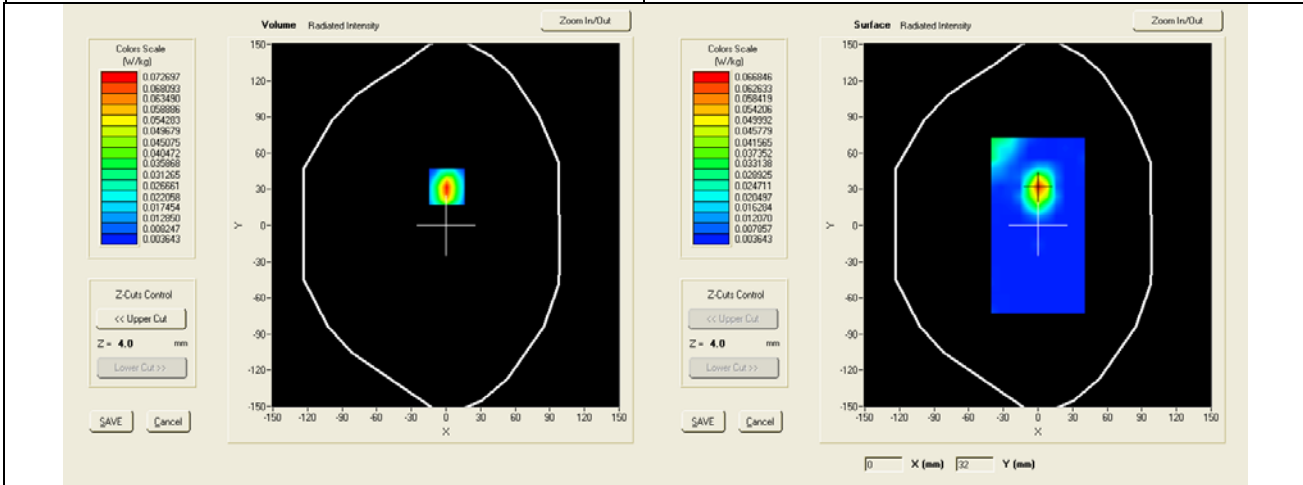

SAR, Z Axis Scan (X = 1, Y = 32)

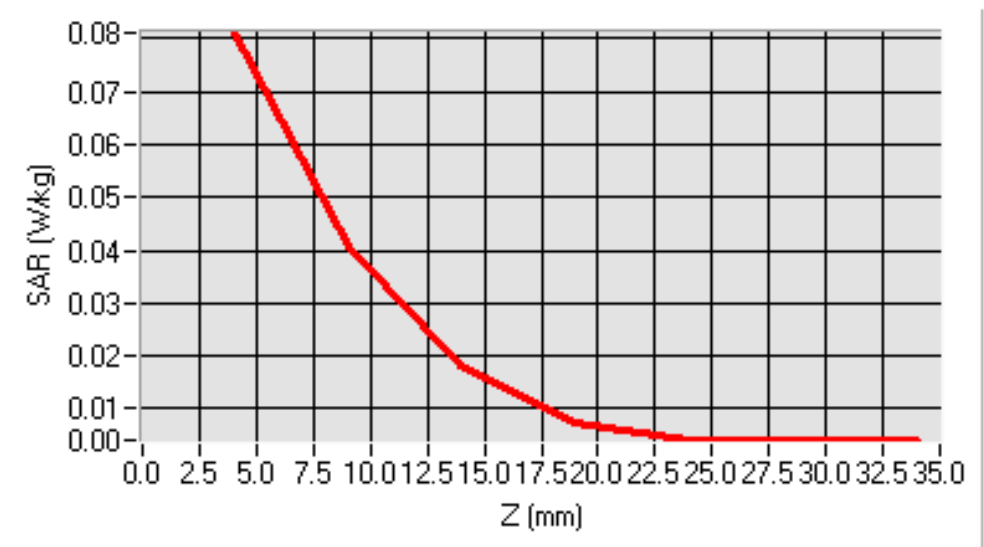

Product Description : 2.4G Radio system
Model: D8T D8R
Test Date: Oct 27 2010

Antenna Orientation : Left side orientation (High channel)

Frequency (MHz)	2448.305000
Relative permittivity (real part)	52.661819
Relative permittivity (imaginary part)	14.441818
Conductivity (S/m)	1.989762
Variation (%)	-1.320000
SAR 1g (W/Kg)	0.870115
SURFACE SAR	VOLUME SAR

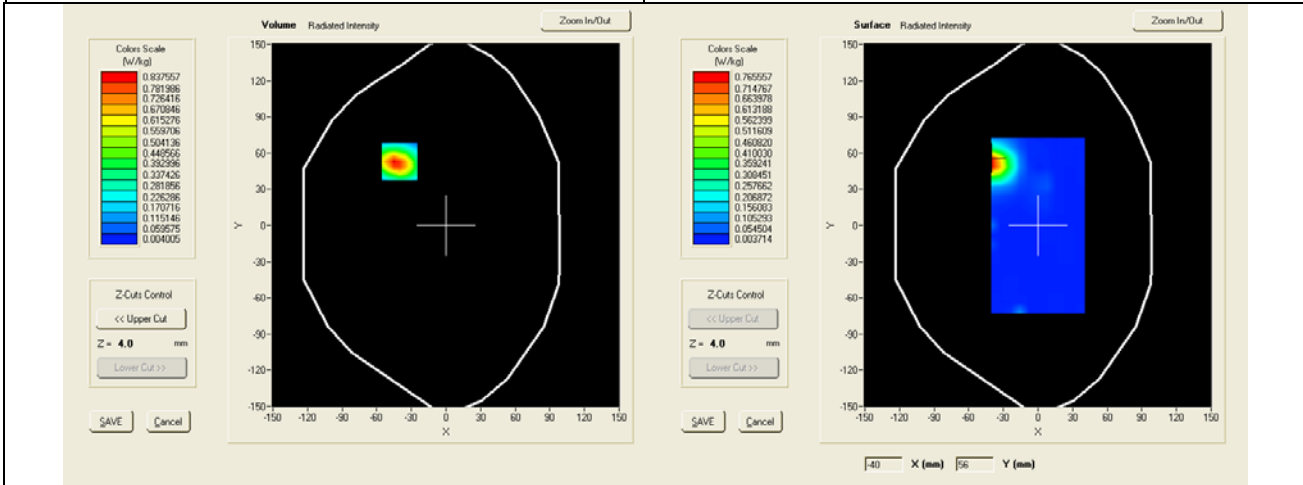

SAR, Z Axis Scan (X = -40, Y = 53)

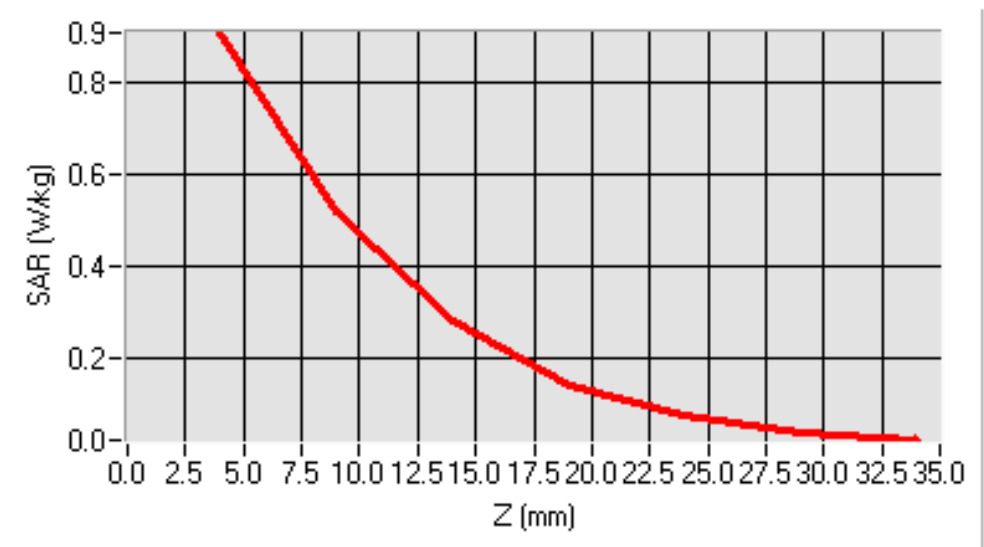

Product Description : 2.4G Radio system
Model: D8T D8R
Test Date: Oct 27 2010

Antenna Orientation : Right side orientation (High channel)

Frequency (MHz)	2448.305000
Relative permittivity (real part)	52.661819
Relative permittivity (imaginary part)	14.441818
Conductivity (S/m)	1.989762
Variation (%)	-0.480000
SAR 1g (W/Kg)	0.384814
SURFACE SAR	VOLUME SAR

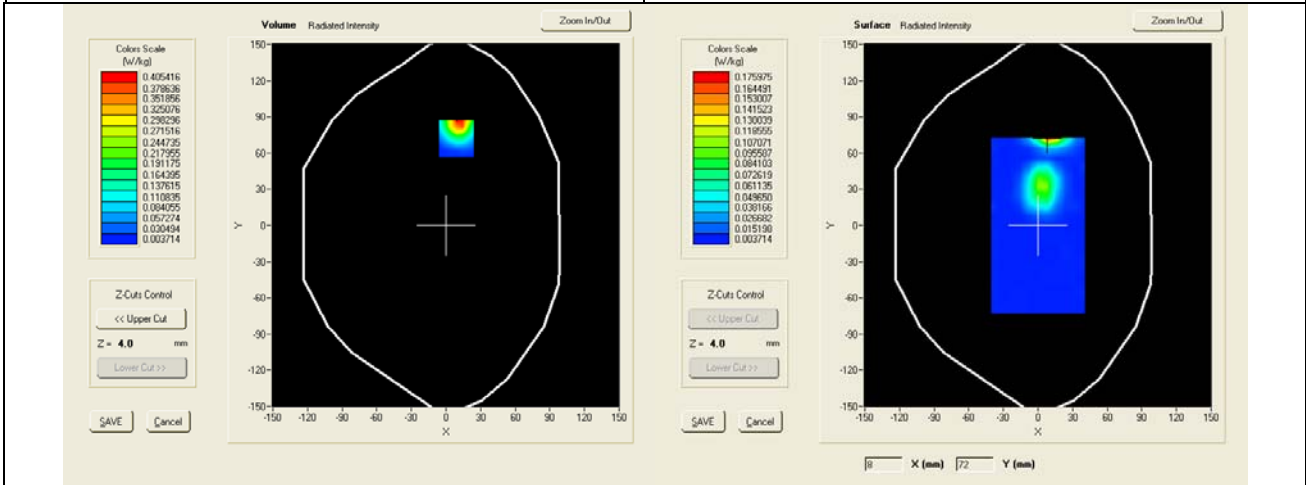

SAR, Z Axis Scan (X = 9, Y = 72)

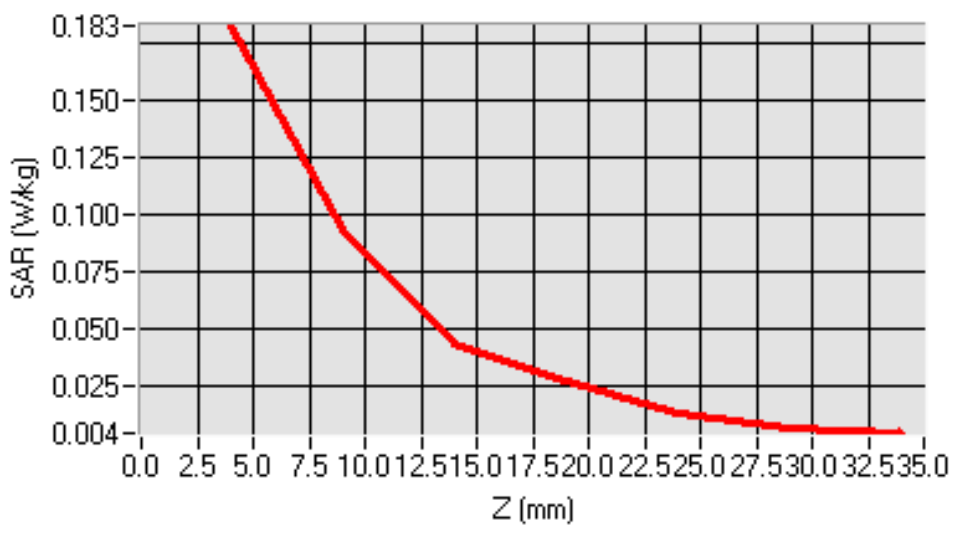

Product Description : 2.4G Radio system
Model: D8T D8R
Test Date: Oct 27 2010

Antenna Orientation : Front orientation (High channel)

Frequency (MHz)	2448.305000
Relative permittivity (real part)	52.661819
Relative permittivity (imaginary part)	14.441818
Conductivity (S/m)	1.989762
Variation (%)	-0.790000
SAR 1g (W/Kg)	1.407573
SURFACE SAR	VOLUME SAR

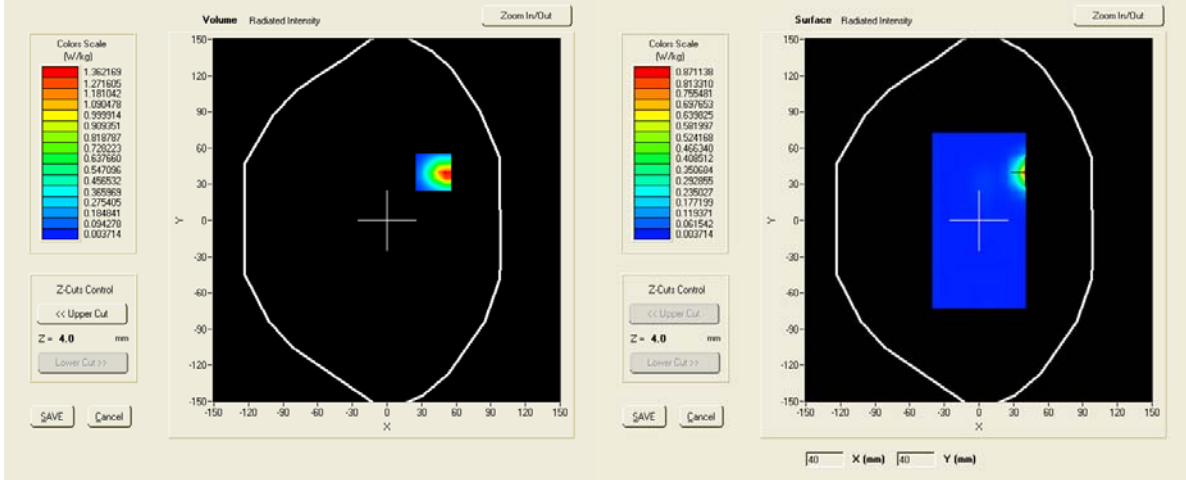

SAR, Z Axis Scan (X = 40, Y = 40)

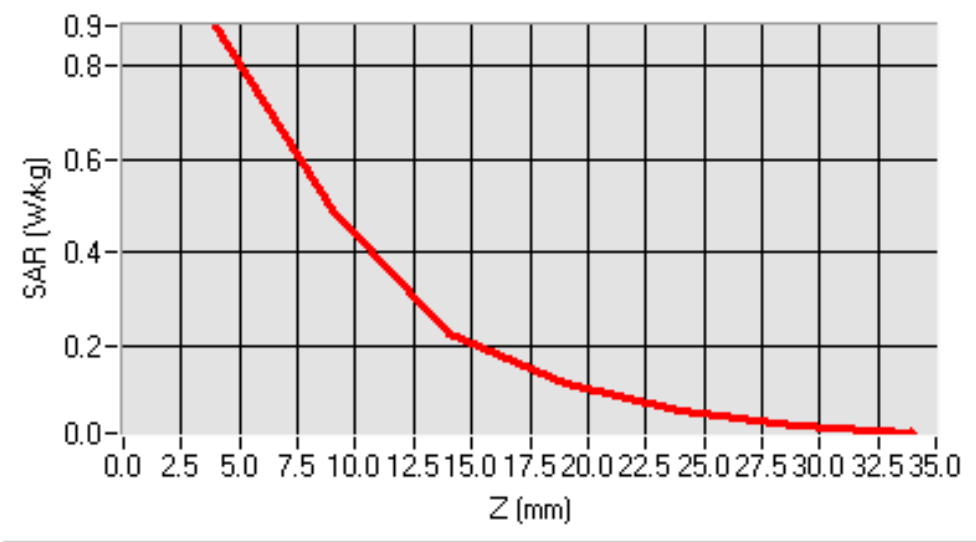

Product Description : 2.4G Radio system
Model: D8T D8R
Test Date: Oct 27 2010

Antenna Orientation : Vertical down orientation (High channel)

Frequency (MHz)	2448.305000
Relative permittivity (real part)	52.661819
Relative permittivity (imaginary part)	14.441818
Conductivity (S/m)	1.989762
Variation (%)	-1.910000
SAR 1g (W/Kg)	0.030220
SURFACE SAR	VOLUME SAR

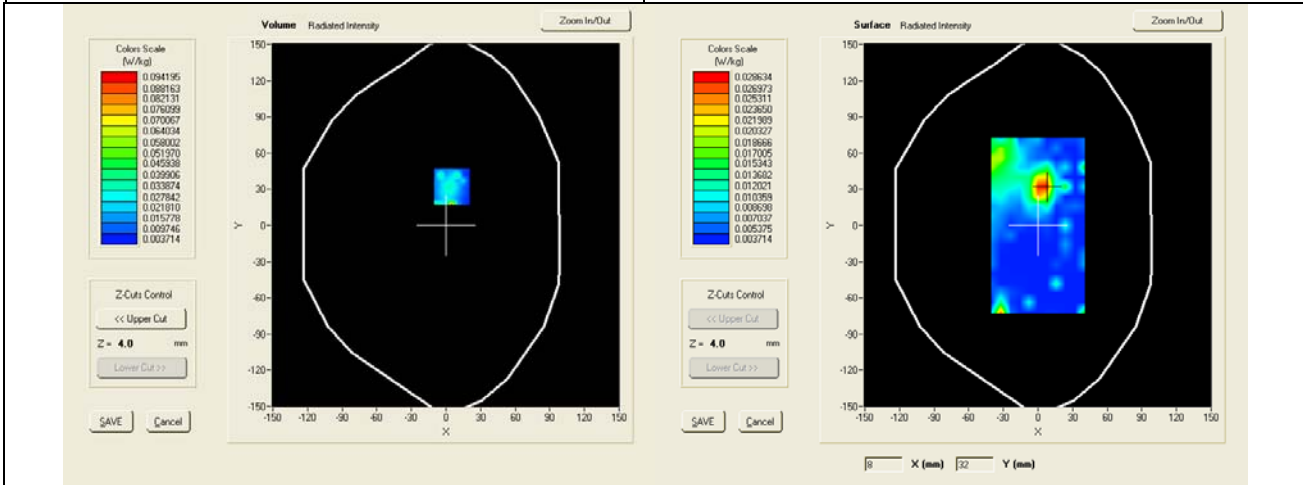

SAR, Z Axis Scan (X = 5, Y = 32)

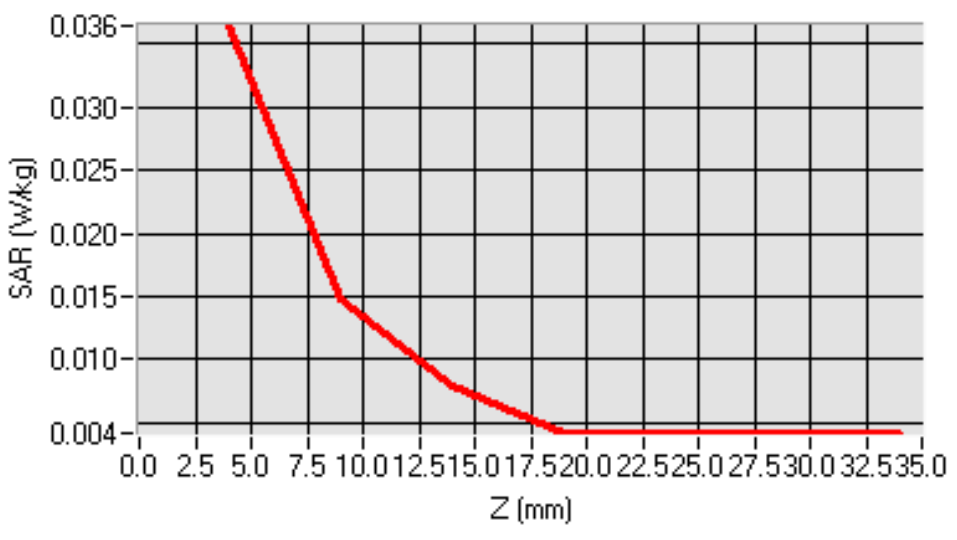

Annex A. TEST INSTRUMENT & METHOD

Annex A.i. TEST INSTRUMENTATION & GENERAL PROCEDURES

Name of Equipment	Manufacturer	Type/Model	Serial Number	Calibration Due
P C	Compaq	PV 3.06GHz	375052-AA1	N/A
Signal Generator	Agilent	8665B-008	3744A01304	5/17/2011
MultiMeter	Keithley	MiltiMeter 2000	1259033	08/13/2011
S-Parameter Network Analyzer	Agilent	8753ES	US38161019	08/04/2012
Wireless Communication Test Set	R & S	CMU200	111078	2/22/2012
Power Meter	HP	437B	3038A03648	5/17/2011
E-field PROBE	SATIMO	EPG111	SN31-10 EPG111	08/04/2011
DIPOLE 900	SATIMO	DIPOLE 900MHz	SN 31/10 DIPD134	08/04/2011
DIPOLE 1800	SATIMO	DIPOLE 1800MHz	SN 31/10 DIPF135	08/04/2011
Dipole 835	SATIMO	Dipole 835MHz	SN 31/10 DIPG133	08/04/2011
DIPOLE 1900	SATIMO	DIPOLE 1900MHz	SN 31/10 DIPG136	08/04/2011
DIPOLE 2000	SATIMO	DIPOLE 2000MHz	SN 31/10 DIP1137	08/04/2011
DIPOLE 2450	SATIMO	DIPOLE 2450MHz	SN 31/10 DIPJ138	08/04/2011
DIPOLE 3500	SATIMO	DIPOLE 3500MHz	SN 31/10 DIPL139	08/04/2011
WaveGuide 5/6 GHz	SATIMO	Wave Guide 5/6GHz	SN 31/10 DIPWGA13	08/04/2011
COMOHAC E-Field Probe	SATIMO	EPH25	SN 3110 EPH25	08/04/2011
COMOHAC H-Field Probe	SATIMO	HPH38	SN 3110 HPH38	08/04/2011
COMOSAR Open Coaxial Probe	SATIMO	OCP36	SN 31/10 OCP36	08/04/2012
T-Coil Probe	SATIMO	TCP17	SN 31/10 TCP17	08/04/2011
Communication Antenna	SATIMO	ANTA30	SN 31/10 ANTA30	N/A
Laptop POSITIONING DEVICE	SATIMO	LSH63	SN 31/10 LSH13	N/A
Mobile Phone POSITIONING DEVICE	SATIMO	MSH63	SN 31/10 MSH63	N/A
COMOHAC Broadband Dipole 800-950	SATIMO	COMOHAC Broadband Dipole 800-950MHz	SN 31/10 DHA25	08/04/2012
COMOHAC Broadband Dipole 1700-2000	SATIMO	COMOHAC Broadband Dipole 1700-2000MHz	SN 31/10 DHB26	08/04/2012
COMOHAC TELEPHONE MAGNETIC FIELD SIMULATOR	SATIMO	TMFS08	SN 31/10 TMFS08	08/04/2012
DUMMY PROBE	ANTENNESSA	None	SN 31/10	N/A

SAM PHANTOM	SATIMO	SAM77	SN 31/10 SAM77	N/A
Elliptic Phantom	SATIMO	ELLI17	SN 31-10 ELL17	N/A
PHANTOM TABLE	SATIMO	N/A	N/A	N/A
6 AXIS ROBOT	KUKA	KR5	949319	N/A
High Power Solid State Amplifier (80MHz~1000MHz)	Instruments for Industry	CMC150	M631-0408	N/A
Medium Power Solid State Amplifier (0.8~4.2GHz)	Instruments for Industry	S41-25	M629-0408	N/A
Wave Tube Amplifier 4-8 GHz at 20Watt	Hughes Aircraft Company	1277H02F000	81	N/A

Annex B EUT AND TEST SETUP PHOTOGRAPHS

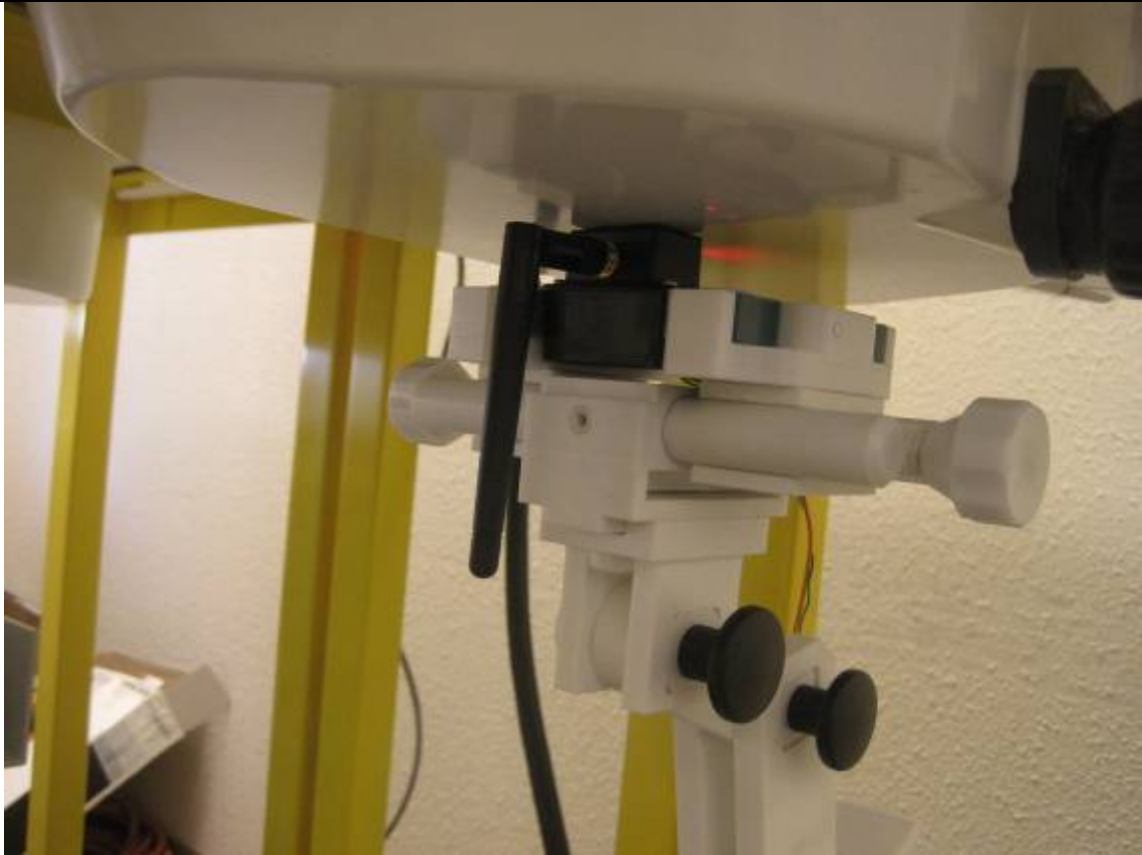

SAR Test setup - 1



SAR Test setup - 2

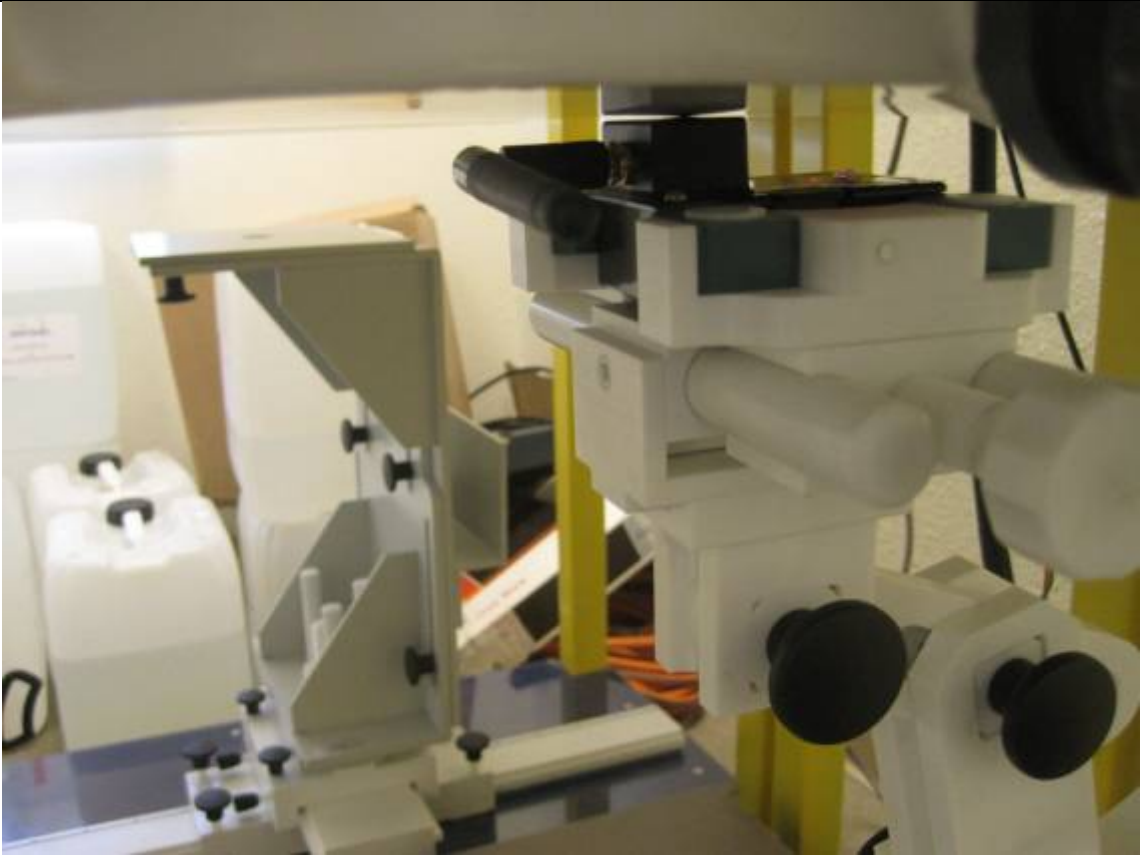

SAR Test setup - 3



SAR Test setup - 4

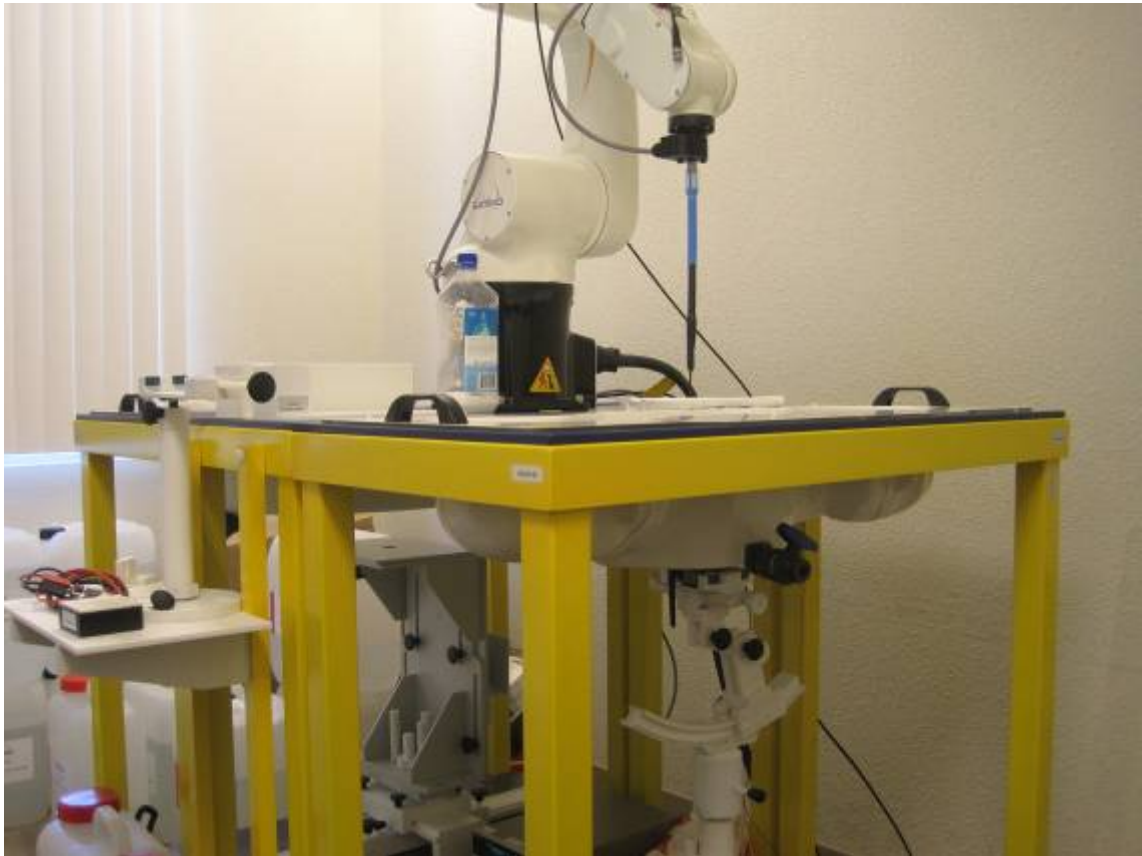

SAR Test setup - 5

Annex C CALIBRATION REPORTS

COMOSAR E-Field probe Calibration Report			
	Ref: CR.216.1.10.SATBA		
	Page: 1/25	Issue: A	Date: 2010/08/04

COMOSAR E-FIELD PROBE CALIBRATION REPORT

Prepared By: LUC Jérôme, SATIMO
 Project Description: SAR TEST BENCH
 Prepared For (End User): SIEMIC, INC.

This document is issued by SATIMO, in confidence and is not to be reproduced in whole or in part without the prior written permission. The information contained herein is to be used only for the purpose for which it is submitted and is not to be released in whole or in part without the prior written permission of SATIMO.

COMOSAR E-Field probe Calibration Report	 Ref: CR.216.1.10.SATB.A	
	Page: 2/25	Issue: A
	Date: 2010/08/04	

COMOSAR SEPT ISOTROPIC E-FIELD PROBE CALIBRATION REPORT

DATE: 15/09/2010

OBJECT: COMOSAR SEPT ISOTROPIC E-FIELD PROBE

MANUFACTURER: SATIMO

SERIAL NUMBER: SN 31/10 EPG111

CUSTOMER: SIEMIC, INC.

CONTRACT: PO1007001

DATE OF CALIBRATION: 04/08/2010

WARRANTY:

This Calibration certificate may not be reproduced other than in full. Calibration certificates without signature and seal are not valid. This documentation contains property information which is protected by copyright. All right are reserved. No part of this document may be photocopied, reproduced without the prior written agreement of SATIMO. SATIMO shall not be liable for errors contained herein or for incidental or consequential in connection with the furnishing, performance or use of this material. Warranty doesn't apply to Normal wear, Normal tear, Improper use, Improper maintain, Improper installation.

Date

09-09-10

SAR TEAM MANAGER



 2105 Barrett Park Dr., Suite 104
 Kennesaw, GA - USA
 Tel: +1 678 797 9172
 Fax: +1 678 797 9173
 www.satimo.com

<h2 style="margin: 0;">COMOSAR E-Field probe Calibration Report</h2>	 Ref: CR.216.1.10.SATB.A			
	<table border="1" style="width: 100%; border-collapse: collapse;"> <tr> <td style="width: 33%;">Page: 3/25</td> <td style="width: 33%;">Issue: A</td> <td style="width: 33%;">Date: 2010/08/04</td> </tr> </table>	Page: 3/25	Issue: A	Date: 2010/08/04
Page: 3/25	Issue: A	Date: 2010/08/04		

PRODUCT DESCRIPTION



Frequency Range	100 MHz - 30 GHz
Probe length	330 mm
Length of one dipole	2.0 mm
Maximum external diameter	8 mm
Probe extremity diameter	2.8 mm
Distance between dipoles/probe extremity	< 1.5 mm
Resistance of the three dipole (at the connector)	Dipole 1: R1=0.291 MΩ Dipole 2: R2=0.223 MΩ Dipole 3: R3=0.303 MΩ
Diode Compression Point	Dipole 1: DCP1=121 mV Dipole 2: DCP2=119 mV Dipole 3: DCP3=116 mV

The probe could be checked by measuring the resistance of the three dipoles.

CALIBRATION TEST EQUIPMENT

TYPE	IDENTIFICATION	DATE OF CALIBRATION
Calibration bench	CALISAR CALIBRATION SYSTEM V2.0	
Multimeter	Keithley (2000, SN: 1000572)	Date of calibration: 01-07-2009

<h2 style="margin: 0;">COMOSAR E-Field probe Calibration Report</h2>	 Ref: CR.216.1.10.SATB.A	
Page: 4/25	Issue: A	Date: 2010/08/04

MEASUREMENT PROCEDURE

Probe calibration is realized, in compliance with CENELEC EN 50361 and IEEE 1528 std, with CALISAR, SATIMO proprietary calibration system. The calibration is performed with the EN 50361 annexe technique using reference guide at the five frequencies.

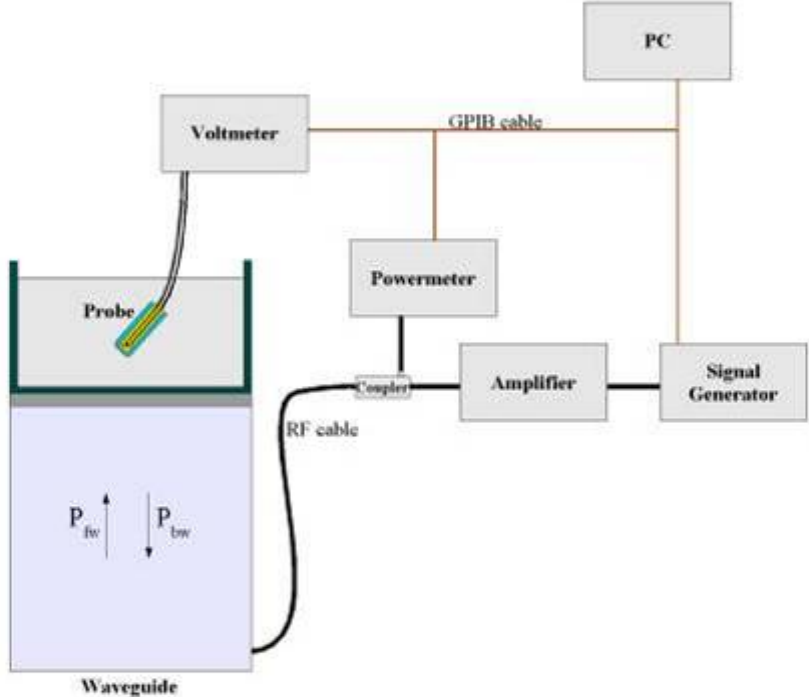

$$SAR = \frac{4(P_{fw} - P_{bw})}{ab\delta} \cos^2\left(\frac{\pi y}{a}\right) e^{-(2z/\delta)}$$

- Where :
- P_{fw} = Forward Power
 - P_{bw} = Backward Power
 - a and b = Waveguide dimensions
 - δ = Skin depth

Keithley configuration:

Rate = Medium; Filter =ON; RDGS=10; FILTER TYPE =MOVING AVERAGE; RANGE AUTO

After each calibration, a SAR measurement is performed on a validation dipole and compared with a NPL calibrated probe, to verify it.

<h2 style="margin: 0;">COMOSAR E-Field probe Calibration Report</h2>	 Ref: CR.216.1.10.SATB.A	
Page: 5/25	Issue: A	Date: 2010/08/04

PROBE UNCERTAINTIES

**Calibration report of dosimetric
SATIMO probe**

Uncertainty on calibration system					
ERROR SOURCES	Uncertainty value (%)	Probability Distribution	Divisor	ci	Standard Uncertainty (%)
Incident or forward power	3,00%	Rectangular	$\sqrt{3}$	1	1,732%
Reflected power	3,00%	Rectangular	$\sqrt{3}$	1	1,732%
Liquid conductivity	5,00%	Rectangular	$\sqrt{3}$	1	2,887%
Liquid permittivity	4,00%	Rectangular	$\sqrt{3}$	1	2,309%
Field homogeneity	3,00%	Rectangular	$\sqrt{3}$	1	1,732%
Field probe positioning	5,00%	Rectangular	$\sqrt{3}$	1	2,887%
Field probe linearity	3,00%	Rectangular	$\sqrt{3}$	1	1,732%
Combined standard uncertainty					4,761%
Expanded uncertainty (confidence interval of 95%)					9,331%

<h2>COMOSAR E-Field probe Calibration Report</h2>	 Ref: CR.216.1.10.SATB.A
Page: 6/25	Issue: A
Date: 2010/08/04	

1. Calibration at 835.00 MHz

A. Calibration parameters.

Label	850
Epsilon	41.44
Sigma	0.90 S/m
Temperature	21 °C
Cable loss	0.10 dB
Coupler loss	20.50 dB
Waveguide S11	-20.90 dB
Low limit detection	0.75 V/m (0.51 mW/kg)

Calibration curves $e_i=f(V)$ ($i=1,2,3$) allow to obtain E-field value using the formula:
 $E=(e1*e1+e2*e2+e3*e3)pow(1/2)$

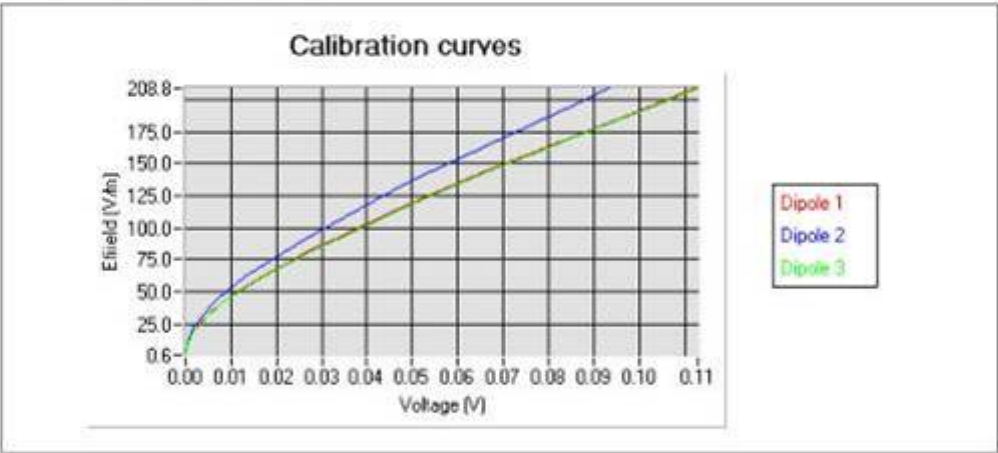

The following tables represent the calibration curves linearization by curve segment in CW signal.

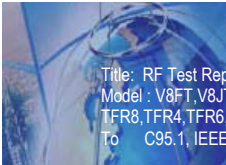

<h2>COMOSAR E-Field probe Calibration Report</h2>			
	Ref: CR.216.1.10.SATB.A		
	Page: 7/25	Issue: A	Date: 2010/08/04

Calibration coefficients for the three dipoles in CW:

Liquid	Epsilon	Sigma (S/m)	Sensitivity in liquid:		
			CF dipole 1 (W.kg-1 (mV)-1)	CF dipole 2 (W.kg-1 (mV)-1)	CF dipole 3 (W.kg-1 (mV)-1)
Head	41.44	0.90	168.8	225.03	167.83
Body	53.21	0.98	181.88	242.53	180.89

B. Isotropy.

- Axial isotropy: 0.03 dB
- Hemispherical isotropy: 0.03 dB

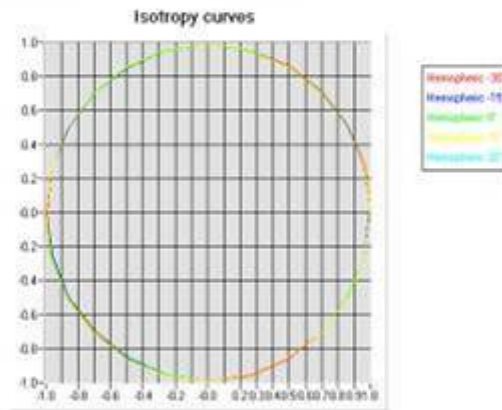

C. Linearity.

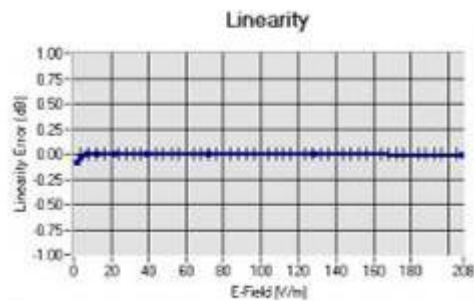

Linearity $\pm 2.00\%$ ($\pm 0.09\text{dB}$)

<h2>COMOSAR E-Field probe Calibration Report</h2>	 Ref: CR.216.1.10.SATB.A
Page: 8/25 Issue: A Date: 2010/08/04	

2. Calibration at 897.00 MHz

A. Calibration parameters.

Label	900
Epsilon	40.99
Sigma	0.99 S/m
Temperature	21 °C
Cable loss	0.10 dB
Coupler loss	20.27 dB
Waveguide S11	-12.70 dB
Low limit detection	0.78 V/m (0.60 mW/kg)

Calibration curves $e_i=f(V)$ ($i=1,2,3$) allow to obtain E-field value using the formula:
 $E=(e1*e1+e2*e2+e3*e3)pow(1/2)$

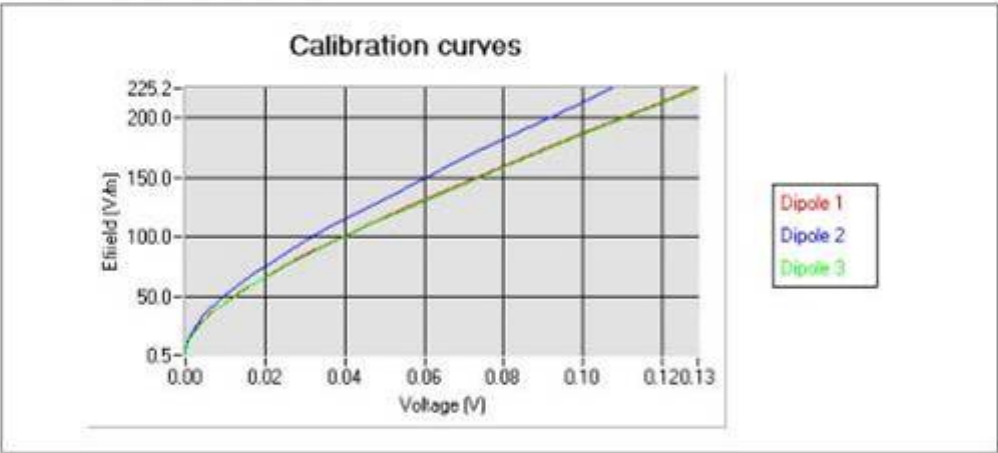

The following tables represent the calibration curves linearization by curve segment in CW signal.

COMOSAR E-Field probe Calibration Report	 Ref: CR.216.1.10.SATB.A		
	Page: 9/25	Issue: A	Date: 2010/08/04

Calibration coefficients for the three dipoles in CW:

Liquid	Epsilon	Sigma (S/m)	Sensitivity in liquid:		
			CF dipole 1 (W.kg-1 (mV)-1)	CF dipole 2 (W.kg-1 (mV)-1)	CF dipole 3 (W.kg-1 (mV)-1)
Head	40.99	0.99	173.98	227.41	169.94
Body	52.68	1.04	182.79	238.90	178.51

B. Isotropy.

- Axial isotropy: 0.03 dB
- Hemispherical isotropy: 0.04 dB

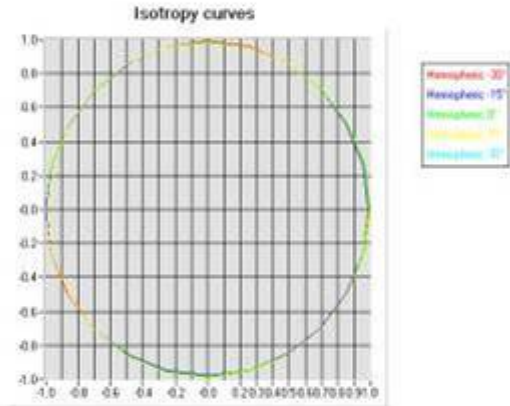

C. Linearity.

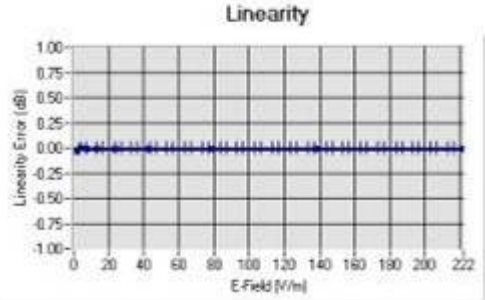

Linearity: $\pm 0.92\%$ ($\pm 0.04\text{dB}$)

<h2>COMOSAR E-Field probe Calibration Report</h2>	 Ref: CR.216.1.10.SATB.A Page: 10/25 Issue: A Date: 2010/08/04
---	---

3. Calibration at 1747.00 MHz

A. Calibration parameters.

Label	1800
Epsilon	39.55
Sigma	1.42 S/m
Temperature	21 °C
Cable loss	0.14 dB
Coupler loss	20.18 dB
Waveguide S11	-12.70 dB
Low limit detection	0.85 V/m (1.02 mW/kg)

Calibration curves $e_i=f(V)$ ($i=1,2,3$) allow to obtain E-field value using the formula:
 $E=(e1*e1+e2*e2+e3*e3)pow(1/2)$

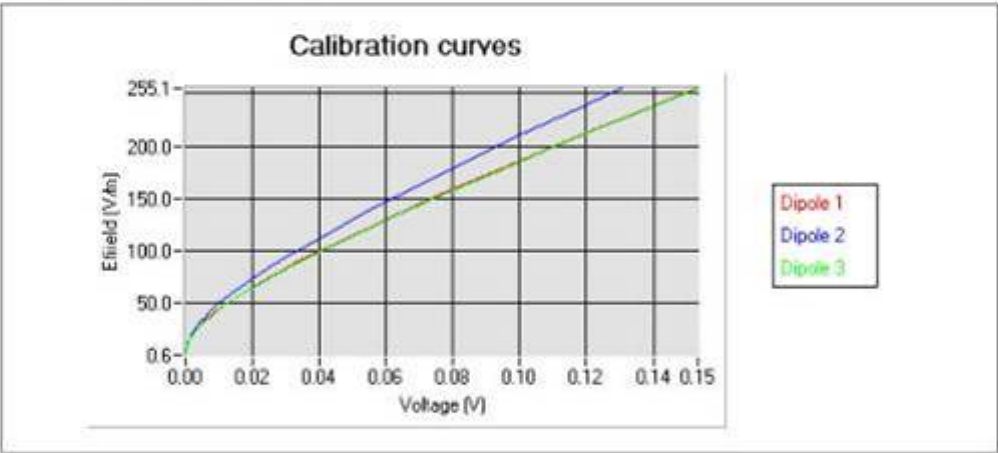

The following tables represent the calibration curves linearization by curve segment in CW signal.

<h2 style="margin: 0;">COMOSAR E-Field probe Calibration Report</h2>	 Ref: CR.216.1.10.SATB.A			
<table border="1" style="width: 100%; border-collapse: collapse;"> <tr> <td style="width: 33%;">Page: 11/25</td> <td style="width: 33%;">Issue: A</td> <td style="width: 33%;">Date: 2010/08/04</td> </tr> </table>		Page: 11/25	Issue: A	Date: 2010/08/04
Page: 11/25	Issue: A	Date: 2010/08/04		

Calibration coefficients for the three dipoles in CW:

Liquid	Epsilon	Sigma (S/m)	Sensitivity in liquid:		
			CF dipole 1 (W.kg-1 (mV)-1)	CF dipole 2 (W.kg-1 (mV)-1)	CF dipole 3 (W.kg-1 (mV)-1)
Head	39.55	1.42	255.29	323.02	243.31
Body	53.55	1.51	270.69	339.85	258.45

B. Isotropy.

- Axial isotropy: 0.05 dB
- Hemispherical isotropy: 0.06 dB

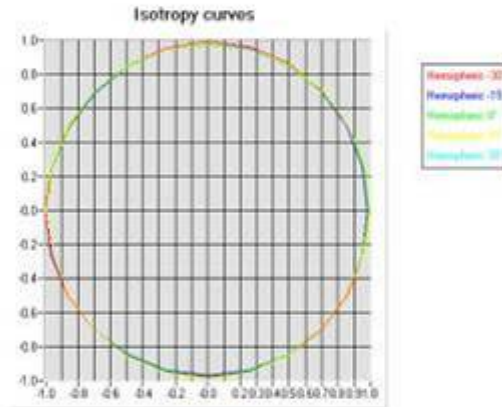

C. Linearity.

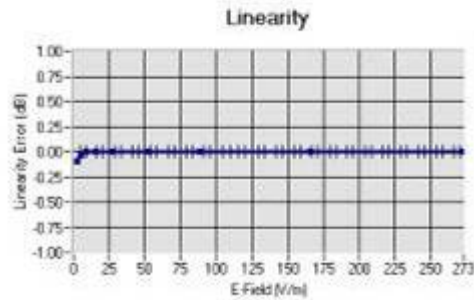

Linearity: $\pm 2.25\%$ ($\pm 0.10\text{dB}$)

<h2>COMOSAR E-Field probe Calibration Report</h2>	 Ref: CR.216.1.10.SATB.A			
	<table border="1" style="width: 100%; border-collapse: collapse;"> <tr> <td style="width: 33%;">Page: 12/25</td> <td style="width: 33%;">Issue: A</td> <td style="width: 33%;">Date: 2010/08/04</td> </tr> </table>	Page: 12/25	Issue: A	Date: 2010/08/04
Page: 12/25	Issue: A	Date: 2010/08/04		

4. Calibration at 1880.00 MHz

A. Calibration parameters.

Label	1900
Epsilon	40.23
Sigma	1.41 S/m
Temperature	21 °C
Cable loss	0.15 dB
Coupler loss	20.12 dB
Waveguide S11	-32.10 dB
Low limit detection	0.83 V/m (0.97 mW/kg)

Calibration curves $e_i=f(V)$ ($i=1,2,3$) allow to obtain E-field value using the formula:
 $E=(e1*e1+e2*e2+e3*e3)pow(1/2)$

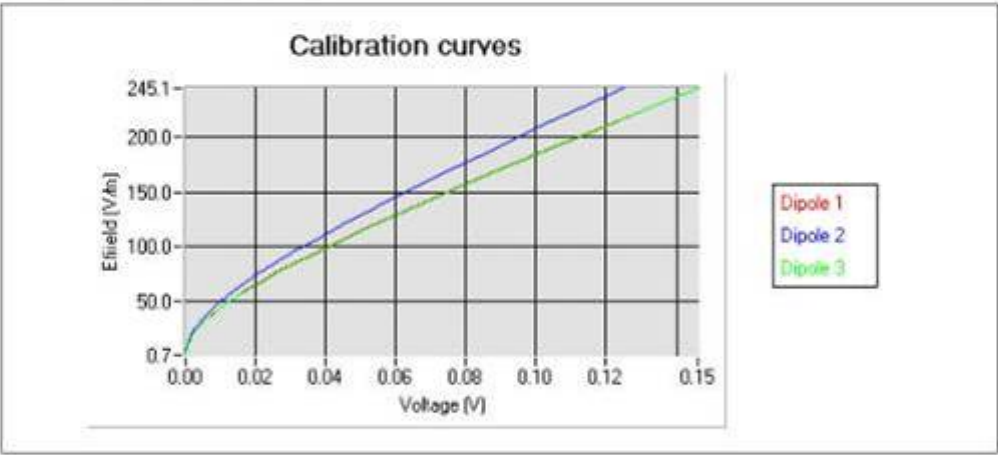

The following tables represent the calibration curves linearization by curve segment in CW signal.

COMOSAR E-Field probe Calibration Report	 Ref: CR.216.1.10.SATB.A	
Page: 13/25	Issue: A	Date: 2010/08/04

Calibration coefficients for the three dipoles in CW:

Liquid	Epsilon	Sigma (S/m)	Sensitivity in liquid:		
			CF dipole 1 (W.kg-1 (mV)-1)	CF dipole 2 (W.kg-1 (mV)-1)	CF dipole 3 (W.kg-1 (mV)-1)
Head	40.23	1.41	250.56	317.11	241.74
Body	54.65	1.54	273.66	346.35	264.03

B. Isotropy.

- Axial isotropy: 0.06 dB
- Hemispherical isotropy: 0.08 dB

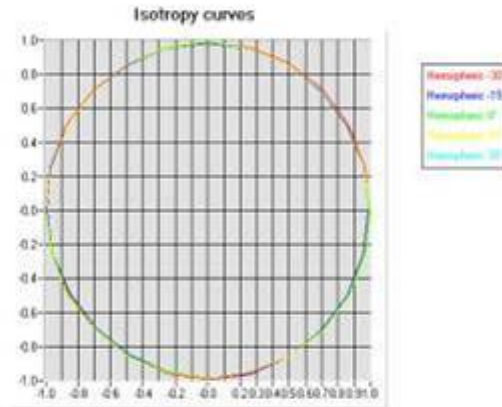

C. Linearity.

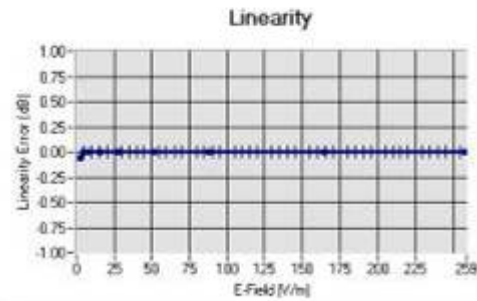

Linearity $\pm 1.51\%$ ($\pm 0.07\text{dB}$)

<h2>COMOSAR E-Field probe Calibration Report</h2>	 Ref: CR.216.1.10.SATB.A Page: 14/25 Issue: A Date: 2010/08/04
---	---

5. Calibration at 1950.00 MHz

A. Calibration parameters.

Label	2000
Epsilon	41.39
Sigma	1.39 S/m
Temperature	21 °C
Cable loss	0.14 dB
Coupler loss	20.12 dB
Waveguide S11	-31.20 dB
Low limit detection	0.86 V/m (1.03 mW/kg)

Calibration curves $e_i=f(V)$ ($i=1,2,3$) allow to obtain E-field value using the formula:
 $E=(e1*e1+e2*e2+e3*e3)pow(1/2)$

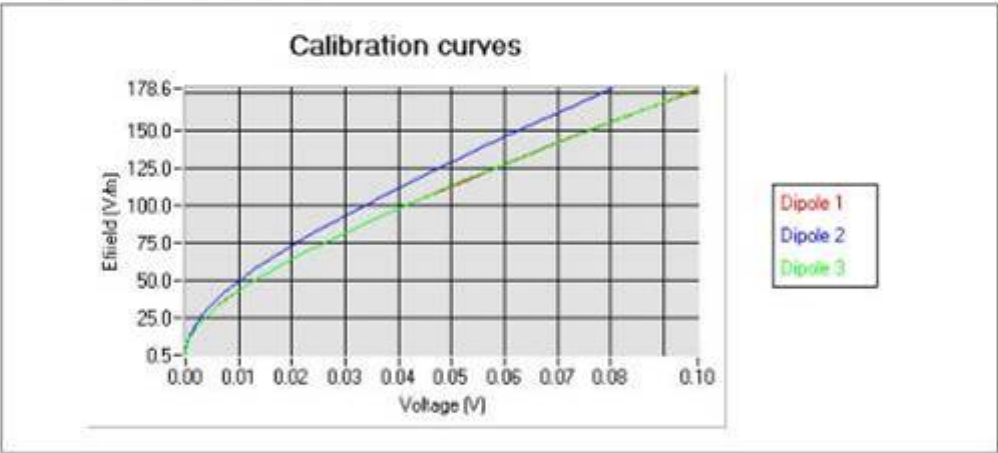

The following tables represent the calibration curves linearization by curve segment in CW signal.

COMOSAR E-Field probe Calibration Report	 Ref: CR.216.1.10.SATB.A	
Page: 15/25	Issue: A	Date: 2010/08/04

Calibration coefficients for the three dipoles in CW:

Liquid	Epsilon	Sigma (S/m)	Sensitivity in liquid:		
			CF dipole 1 (W.kg-1 (mV)-1)	CF dipole 2 (W.kg-1 (mV)-1)	CF dipole 3 (W.kg-1 (mV)-1)
Head	41.39	1.39	232.12	304.13	228.24
Body	53.54	1.49	237.24	310.84	233.28

B. Isotropy.

- Axial isotropy: 0.07 dB
- Hemispherical isotropy: 0.09 dB

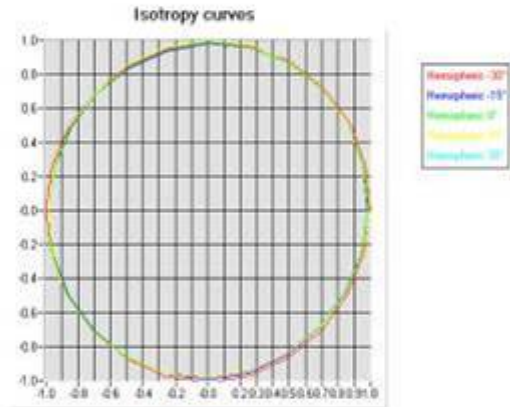

C. Linearity.

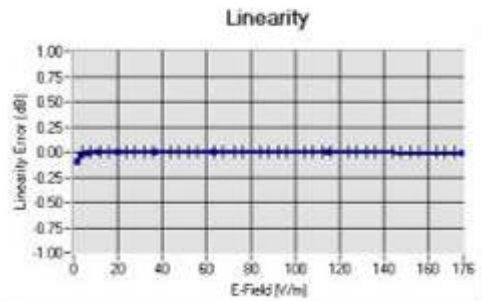

Linearity $\pm 2.25\%$ ($\pm 0.10\text{dB}$)

<h2>COMOSAR E-Field probe Calibration Report</h2>	 Ref: CR.216.1.10.SATB.A			
	<table border="1" style="width: 100%; border-collapse: collapse;"> <tr> <td style="width: 33%;">Page: 16/25</td> <td style="width: 33%;">Issue: A</td> <td style="width: 33%;">Date: 2010/08/04</td> </tr> </table>	Page: 16/25	Issue: A	Date: 2010/08/04
Page: 16/25	Issue: A	Date: 2010/08/04		

6. Calibration at 2450.00 MHz

A. Calibration parameters.

Label	2450
Epsilon	38.51
Sigma	1.79 S/m
Temperature	21 °C
Cable loss	0.13 dB
Coupler loss	21.51 dB
Waveguide S11	-13.20 dB
Low limit detection	0.90 V/m (1.45 mW/kg)

Calibration curves $e_i=f(V)$ ($i=1,2,3$) allow to obtain E-field value using the formula:
 $E=(e1*e1+e2*e2+e3*e3)pow(1/2)$

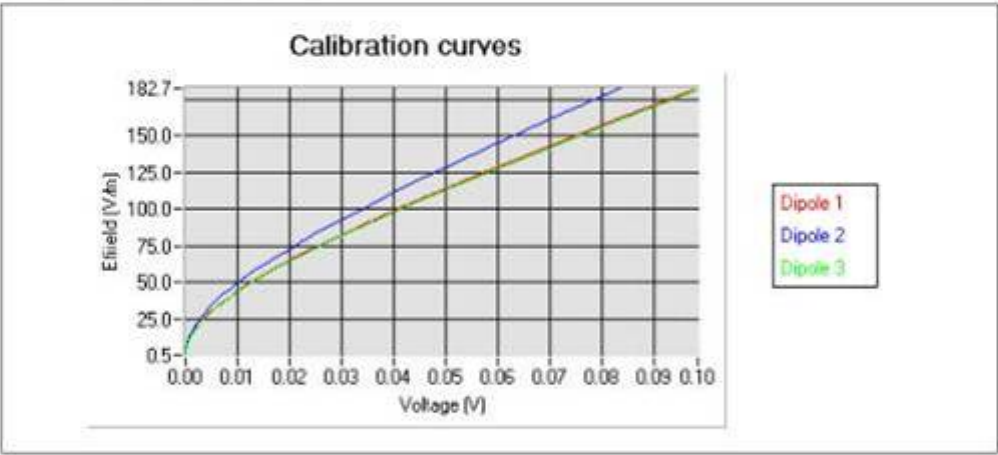

The following tables represent the calibration curves linearization by curve segment in CW signal.

<h2 style="margin: 0;">COMOSAR E-Field probe Calibration Report</h2>	 Ref: CR.216.1.10.SATB.A	
Page: 17/25	Issue: A	Date: 2010/08/04

Calibration coefficients for the three dipoles in CW:

Liquid	Epsilon	Sigma (S/m)	Sensitivity in liquid:		
			CF dipole 1 (W.kg-1 (mV)-1)	CF dipole 2 (W.kg-1 (mV)-1)	CF dipole 3 (W.kg-1 (mV)-1)
Head	38.51	1.79	296.04	397.04	300.71
Body	52.36	1.97	325.81	436.97	330.95

B. Isotropy.

- Axial isotropy: 0.09 dB
- Hemispherical isotropy: 0.11 dB

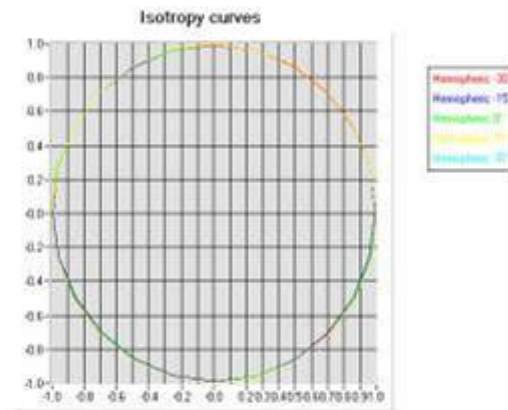

C. Linearity.

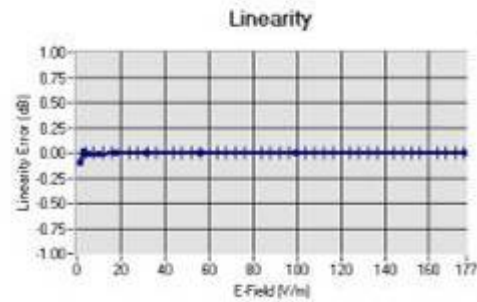

Linearity $\pm 2.25\%$ ($\pm 0.10\text{dB}$)

<h2>COMOSAR E-Field probe Calibration Report</h2>	 Ref: CR.216.1.10.SATB.A			
	<table border="1" style="width: 100%; border-collapse: collapse;"> <tr> <td style="width: 33%;">Page: 18/25</td> <td style="width: 33%;">Issue: A</td> <td style="width: 33%;">Date: 2010/08/04</td> </tr> </table>	Page: 18/25	Issue: A	Date: 2010/08/04
Page: 18/25	Issue: A	Date: 2010/08/04		

7. Calibration at 3500.00 MHz

A. Calibration parameters.

Label	3500
Epsilon	38.10
Sigma	2.88 S/m
Temperature	21 °C
Cable loss	0.23 dB
Coupler loss	20.67 dB
Waveguide S11	-17.32 dB
Low limit detection	0.88 V/m (2.23 mW/kg)

Calibration curves $e_i=f(V)$ ($i=1,2,3$) allow to obtain E-field value using the formula:
 $E=(e1*e1+e2*e2+e3*e3)pow(1/2)$

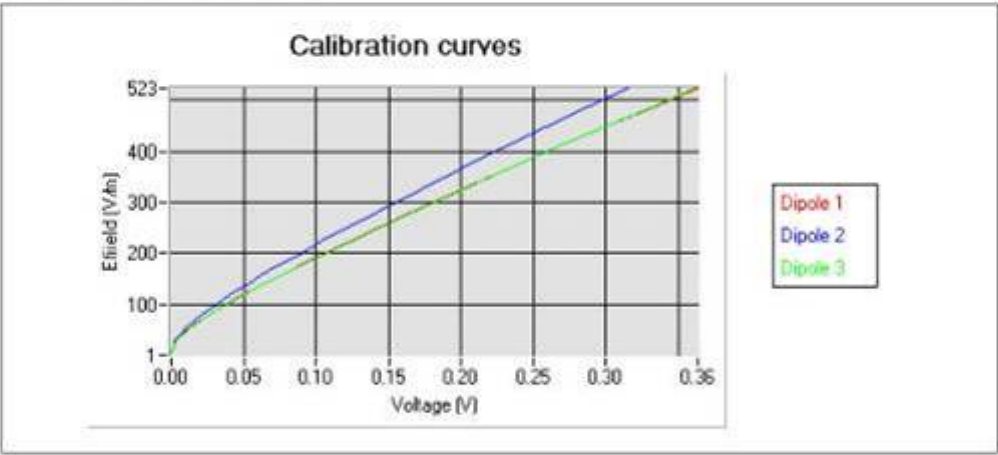

The following tables represent the calibration curves linearization by curve segment in CW signal.

COMOSAR E-Field probe Calibration Report	 Ref: CR.216.1.10.SATB.A			
	<table border="1" style="width: 100%; border-collapse: collapse;"> <tr> <td style="width: 33%;">Page: 19/25</td> <td style="width: 33%;">Issue: A</td> <td style="width: 33%;">Date: 2010/08/04</td> </tr> </table>	Page: 19/25	Issue: A	Date: 2010/08/04
Page: 19/25	Issue: A	Date: 2010/08/04		

Calibration coefficients for the three dipoles in CW:

Liquid	Epsilon	Sigma (S/m)	Sensitivity in liquid:		
			CF dipole 1 (W.kg-1 (mV)-1)	CF dipole 2 (W.kg-1 (mV)-1)	CF dipole 3 (W.kg-1 (mV)-1)
Head	38.10	2.88	562.79	712.62	546.19
Body	51.47	3.21	627.28	794.27	608.77

B. Isotropy.

- Axial isotropy: 0.10 dB
- Hemispherical isotropy: 0.12 dB

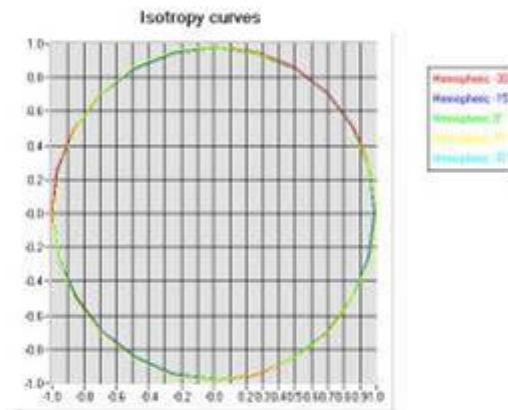

C. Linearity.

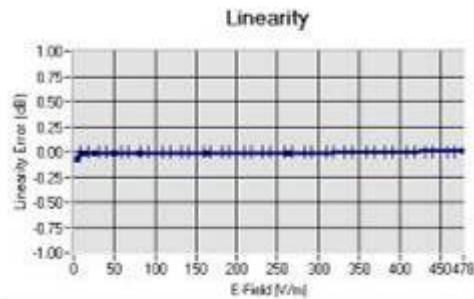

Linearity: +/-1.55% (+/-0.07dB)

<h2>COMOSAR E-Field probe Calibration Report</h2>	 Ref: CR.216.1.10.SATB.A			
	<table border="1" style="width: 100%; border-collapse: collapse;"> <tr> <td style="width: 33%;">Page: 20/25</td> <td style="width: 33%;">Issue: A</td> <td style="width: 33%;">Date: 2010/08/04</td> </tr> </table>	Page: 20/25	Issue: A	Date: 2010/08/04
Page: 20/25	Issue: A	Date: 2010/08/04		

8. Calibration at 5200.00 MHz

A. Calibration parameters.

Label	5200
Epsilon	35.55
Sigma	4.51 S/m
Temperature	21 °C
Cable loss	0.35 dB
Coupler loss	20.04 dB
Waveguide S11	-11.20 dB
Low limit detection	0.69 V/m (2.15 mW/kg)

Calibration curves $e_i=f(V)$ ($i=1,2,3$) allow to obtain E-field value using the formula:
 $E=(e1*e1+e2*e2+e3*e3)pow(1/2)$

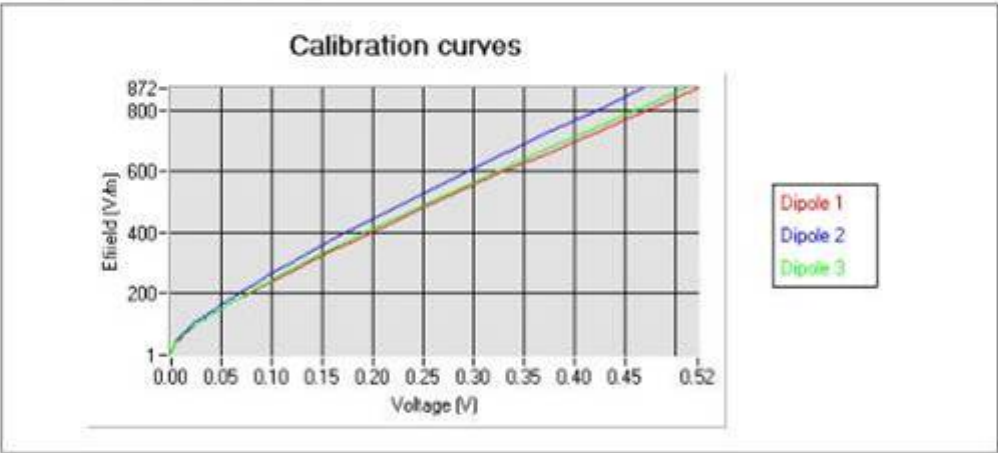

The following tables represent the calibration curves linearization by curve segment in CW signal.

COMOSAR E-Field probe Calibration Report	 Ref: CR.216.1.10.SATB.A	
Page: 21/25	Issue: A	Date: 2010/08/04

Calibration coefficients for the three dipoles in CW:

Liquid	Epsilon	Sigma (S/m)	Sensitivity in liquid:		
			CF dipole 1 (W.kg-1 (mV)-1)	CF dipole 2 (W.kg-1 (mV)-1)	CF dipole 3 (W.kg-1 (mV)-1)
Head	35.55	4.51	1386.9	1724.9	1441.5
Body	47.21	5.21	1571.5	1954.3	1633.3

B. Isotropy.

- Axial isotropy: 0.10 dB
- Hemispherical isotropy: 0.13 dB

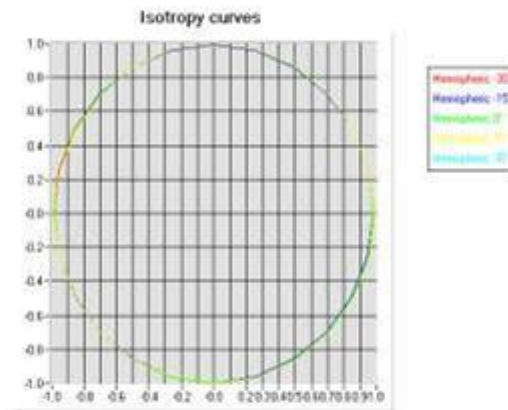

C. Linearity.

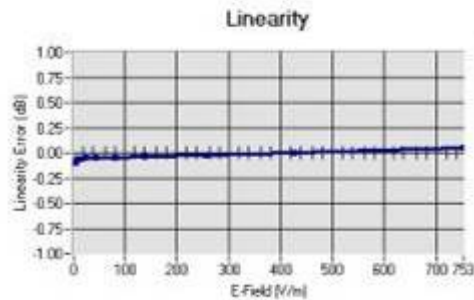

Linearity 0±2.25% (±0.10dB)

<h2>COMOSAR E-Field probe Calibration Report</h2>	 Ref: CR.216.1.10.SATB.A			
<table border="1" style="width: 100%; border-collapse: collapse;"> <tr> <td style="width: 33%;">Page: 22/25</td> <td style="width: 33%;">Issue: A</td> <td style="width: 33%;">Date: 2010/08/04</td> </tr> </table>		Page: 22/25	Issue: A	Date: 2010/08/04
Page: 22/25	Issue: A	Date: 2010/08/04		

9. Calibration at 5500.00 MHz

A. Calibration parameters.

Label	5500
Epsilon	35.10
Sigma	5.00 S/m
Temperature	21 °C
Cable loss	0.37 dB
Coupler loss	20.01 dB
Waveguide S11	-10.99 dB
Low limit detection	0.65 V/m (2.11 mW/kg)

Calibration curves $e_i=f(V)$ ($i=1,2,3$) allow to obtain E-field value using the formula:
 $E=(e1*e1+e2*e2+e3*e3)pow(1/2)$

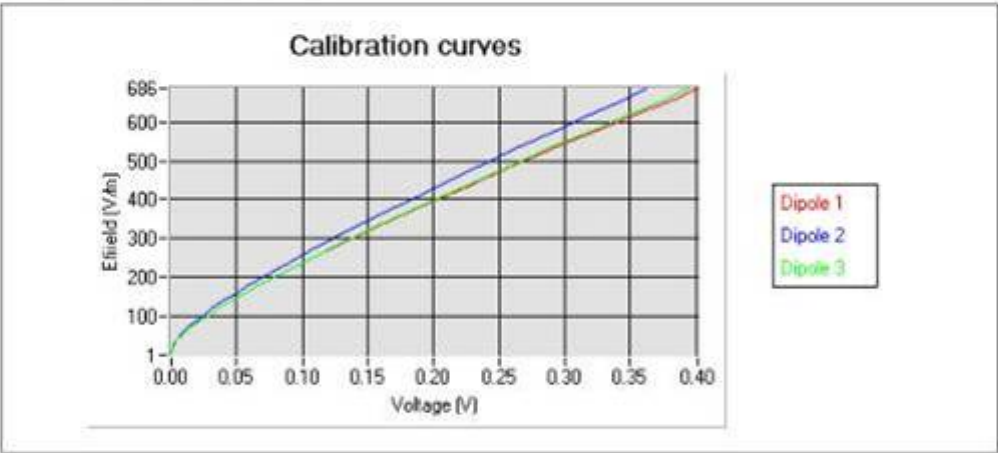

The following tables represent the calibration curves linearization by curve segment in CW signal.

<h2>COMOSAR E-Field probe Calibration Report</h2>	 Ref: CR.216.1.10.SATB.A	
Page: 23/25	Issue: A	Date: 2010/08/04

Calibration coefficients for the three dipoles in CW:

Liquid	Epsilon	Sigma (S/m)	Sensitivity in liquid:		
			CF dipole 1 (W.kg-1 (mV)-1)	CF dipole 2 (W.kg-1 (mV)-1)	CF dipole 3 (W.kg-1 (mV)-1)
Head	35.10	5.00	1477.7	1812.8	1531.4
Body	47.54	5.58	1649.1	2023.1	1709.0

B. Isotropy.

- Axial isotropy: 0.11 dB
- Hemispherical isotropy: 0.14 dB

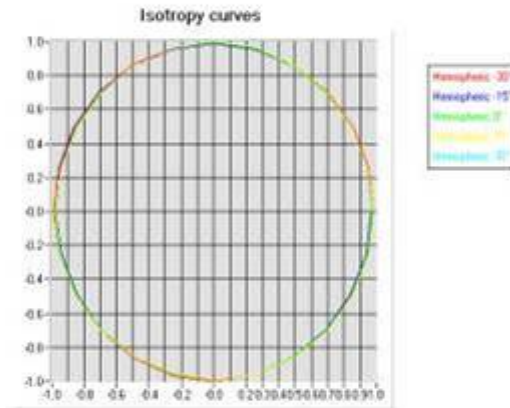

C. Linearity.

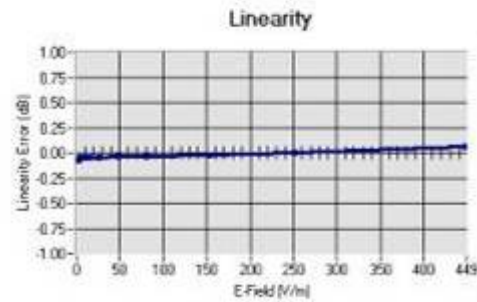

Linearity: +/-1.79% (+/-0.08dB)

<h2>COMOSAR E-Field probe Calibration Report</h2>	 Ref: CR.216.1.10.SATB.A			
	<table border="1" style="width: 100%; border-collapse: collapse;"> <tr> <td style="width: 33%;">Page: 24/25</td> <td style="width: 33%;">Issue: A</td> <td style="width: 33%;">Date: 2010/08/04</td> </tr> </table>	Page: 24/25	Issue: A	Date: 2010/08/04
Page: 24/25	Issue: A	Date: 2010/08/04		

10. Calibration at 5800.00 MHz

A. Calibration parameters.

Label	5800
Epsilon	35.10
Sigma	5.41 S/m
Temperature	21 °C
Cable loss	0.13 dB
Coupler loss	21.51 dB
Waveguide S11	-13.20 dB
Low limit detection	0.58 V/m (1.82 mW/kg)

Calibration curves $e_i=f(V)$ ($i=1,2,3$) allow to obtain E-field value using the formula:
 $E=(e1*e1+e2*e2+e3*e3)pow(1/2)$

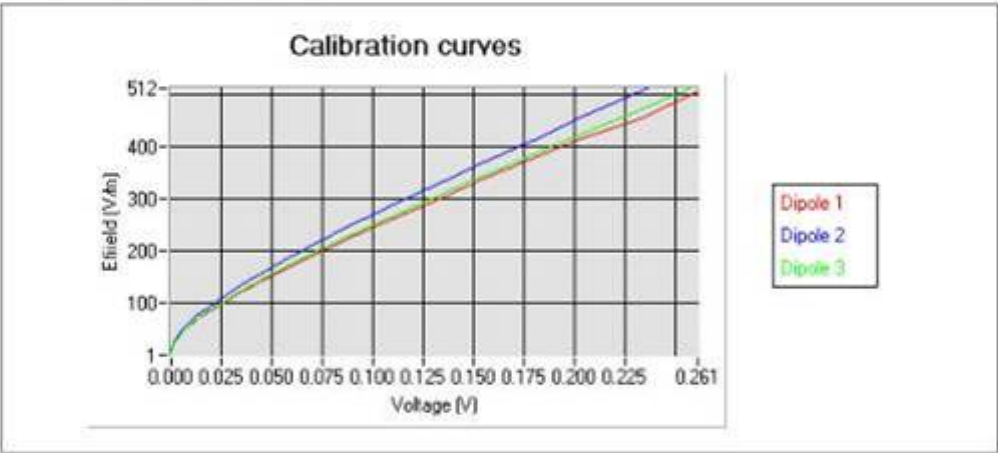

The following tables represent the calibration curves linearization by curve segment in CW signal.

<h2>COMOSAR E-Field probe Calibration Report</h2>	 Ref: CR.216.1.10.SATB.A			
	<table border="1" style="width: 100%; border-collapse: collapse;"> <tr> <td style="width: 33%;">Page: 25/25</td> <td style="width: 33%;">Issue: A</td> <td style="width: 33%;">Date: 2010/08/04</td> </tr> </table>	Page: 25/25	Issue: A	Date: 2010/08/04
Page: 25/25	Issue: A	Date: 2010/08/04		

Calibration coefficients for the three dipoles in CW:

Sensitivity in liquid:					
Liquid	Epsilon	Sigma (S/m)	CF dipole 1 (W.kg-1 (mV)-1)	CF dipole 2 (W.kg-1 (mV)-1)	CF dipole 3 (W.kg-1 (mV)-1)
Head	35.10	5.41	1756.0	2145.7	1819.0
Body	47.98	5.87	1905.3	2328.1	1973.7

B. Isotropy.

- Axial isotropy: 0.13 dB
- Hemispherical isotropy: 0.13 dB

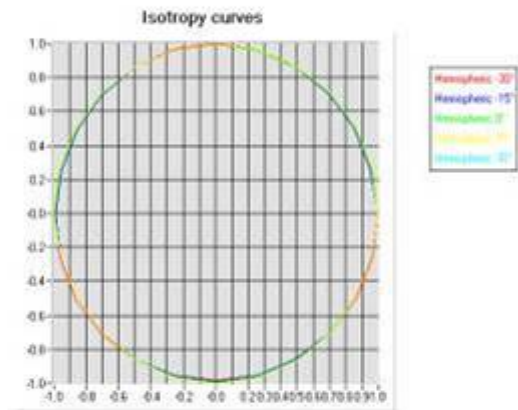

C. Linearity.

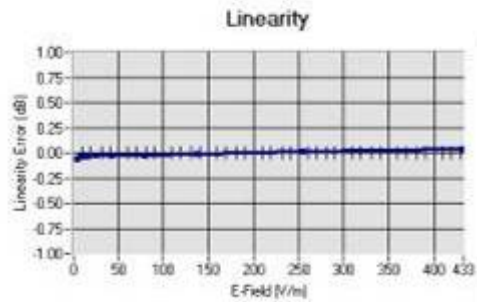

Linearity 0±1.52% (±0.07dB)

COMOSAR Dipole 835 MHz Calibration Report			
	Ref: CR.216.2.10.SATB.A		
	Page: 1/6	Issue: A	Date: 2010/08/04

DIPOLE 835 MHZ CALIBRATION REPORT

Prepared By: LUC Jérôme, SATIMO
 Project Description: SAR TEST BENCH
 Prepared For (End User): SIEMIC, INC.

This document is issued by SATIMO, in confidence and is not to be reproduced in whole or in part without the prior written permission. The information contained herein is to be used only for the purpose for which it is submitted and is not to be released in whole or in part without the prior written permission of SATIMO.

COMOSAR Dipole 835 MHz Calibration Report	 Ref: CR.216.2.10.SATB.A	
	Page: 2/6	Issue: A
	Date: 2010/08/04	

DIPOLE 835 MHz CALIBRATION REPORT

DATE: 15/09/2010

OBJECT: COMOSAR IEEE REFERENCE DIPOLE

MANUFACTURER: SATIMO

SERIAL NUMBER: SN 31/10 DIP133

CUSTOMER: SIEMIC, INC.

CONTRACT: PO1007001

DATE OF CALIBRATION: 04/08/2010

WARRANTY:

This Calibration certificate may not be reproduced other than in full. Calibration certificates without signature and seal are not valid. This documentation contains property information which is protected by copyright. All right are reserved. No part of this document may be photocopied, reproduced without the prior written agreement of SATIMO. SATIMO shall not be liable for errors contained herein or for incidental or consequential in connection with the furnishing, performance or use of this material. Warranty doesn't apply to Normal wear, Normal tear, Improper use, Improper maintain, Improper installation.

Date

09-09-10

SAR TEAM MANAGER



2105 Barrett Park Dr., Suite 104
Kennesaw, GA - USA
 Tel: +1 678 797 9172
 Fax: +1 678 797 9173
 www.satimo.com

<h2>COMOSAR Dipole 835 MHz Calibration Report</h2>	 Ref: CR.216.2.10.SATB.A			
<table border="1" style="width: 100%; border-collapse: collapse;"> <tr> <td style="width: 33%;">Page: 3/6</td> <td style="width: 33%;">Issue: A</td> <td style="width: 33%;">Date: 2010/08/04</td> </tr> </table>		Page: 3/6	Issue: A	Date: 2010/08/04
Page: 3/6	Issue: A	Date: 2010/08/04		

PRODUCT DESCRIPTION

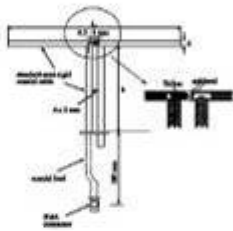

Dimension: L=161.0 mm/ h=89.8 mm / d=3.6 mm

CALIBRATION TEST EQUIPMENT

TYPE	IDENTIFICATION	DATE OF CALIBRATION
Vector Network Analyzer	HP8753D (SN: 5410A08882)	08-06-2009

MEASUREMENT PROCEDURE

We placed the dipole under the flat part of SAM phantom fill with 835 MHz head liquid.

<h2 style="margin: 0;">COMOSAR Dipole 835 MHz Calibration Report</h2>	 Ref: CR.216.2.10.SATB.A
Page: 4/6	Issue: A
Date: 2010/08/04	

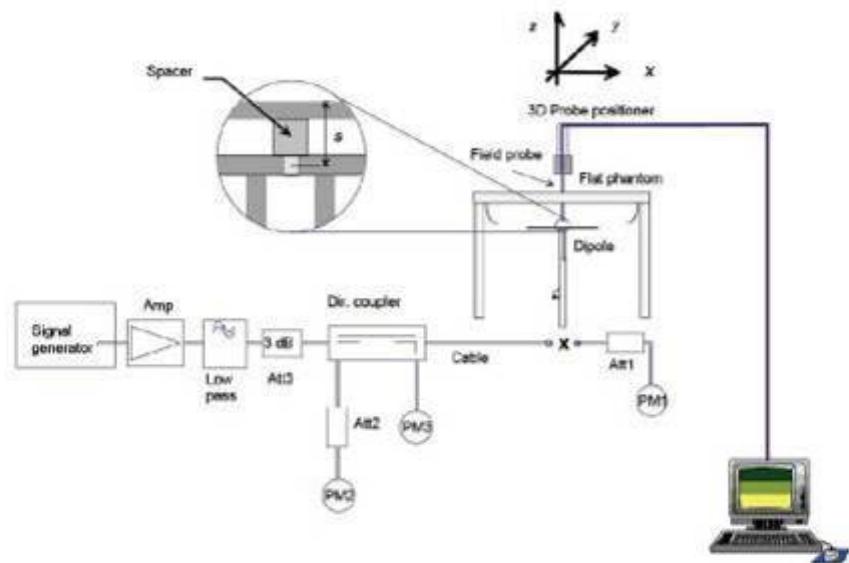

Calibration was performed according to IEEE Std P1528-2003 and OET bulletin 65 Supplement C (Ed. 01-01)

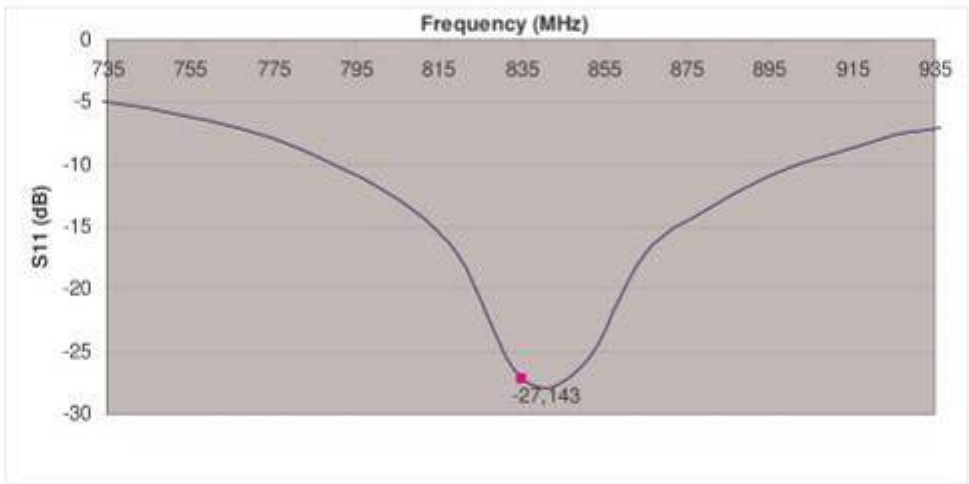

VSWR at 835 MHz: -27.14 dB.

<h2>COMOSAR Dipole 835 MHz Calibration Report</h2>	 Ref: CR.216.2.10.SATB.A			
	<table border="1" style="width: 100%; border-collapse: collapse;"> <tr> <td style="width: 33%;">Page: 5/6</td> <td style="width: 33%;">Issue: A</td> <td style="width: 33%;">Date: 2010/08/04</td> </tr> </table>	Page: 5/6	Issue: A	Date: 2010/08/04
Page: 5/6	Issue: A	Date: 2010/08/04		

SAR MEASUREMENT EQUIPEMENT

Voltmeter	Keithley (2000, SN:1000572)	Date of calibration: 24-06-2009
Signal generator	Rohde&Schwarz (SML_03, SN:101868)	Date of calibration: 14-11-2008
Power amplifier	Nuclétudes (ALB216, SN:10800)	Date of calibration: 20-10-2008
Power meter	Rohde&Schwarz (NRVD, SN:101066)	Date of calibration: 02-07-2009
Probe	SATIMO Bretagne (SN:EP37) CF (30.11,28.89,32.11)	Date of calibration: 08-06-2010

SAR MEASUREMENT CONDITION

Software	OpenSAR V3
Phantom	SATIMO Bretagne (SN: SN_20_07_SAM42)
Liquid	SATIMO Bretagne (Last Calibration: 04 08 10) Head Liquid Values: eps' : 41.15 sigma : 0.87
Distance between the center of the dipole and the liquid (set with a spacer)	15 mm
Area scan resolution	dx=8mm/dy=8mm
Zoom scan resolution	dx=8mm/dy=8m/dz=5mm
Frequency	835 MHz
Input power	20 dBm
Expanded uncertainty (K=1)	8.09%

SAR MEASUREMENT RESULT

	10g	1g
R	SAR measured Liquid : HL	0.623 W/Kg +0.1 %
		0.958 W/Kg +0.2 %

<h2>COMOSAR Dipole 835 MHz Calibration Report</h2>			
	Ref: CR.216.2.10.SATB.A		
	Page: 6/6	Issue: A	Date: 2010/08/04

SAR MEASUREMENT PLOTS

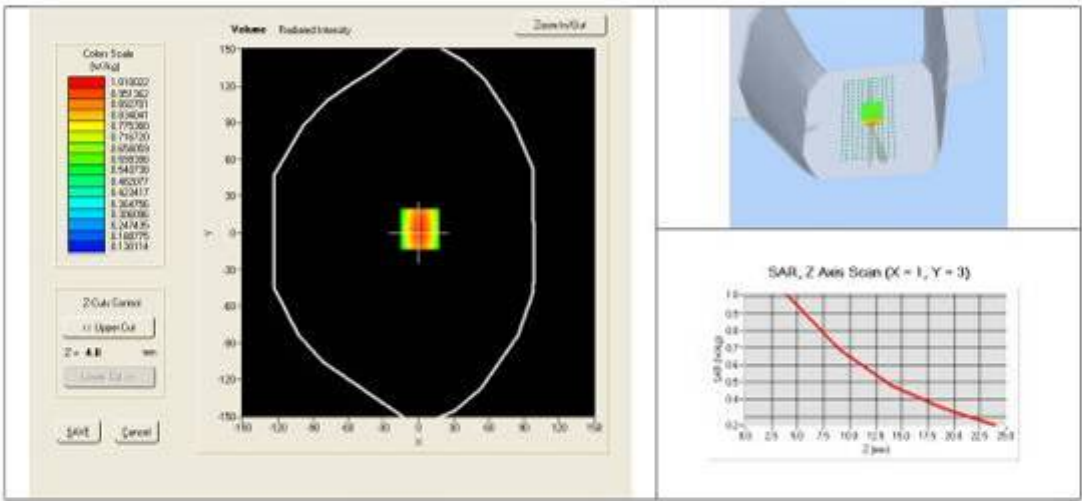

COMOSAR Dipole 1800 MHz Calibration Report			
	Ref: CR.216.4.10.SATB.A		
	Page: 1/6	Issue: A	Date: 2010/08/04

DIPOLE 1800 MHZ CALIBRATION REPORT

Prepared By: LUC Jérôme, SATIMO
 Project Description: SAR TEST BENCH
 Prepared For (End User): SIEMIC, INC.

This document is issued by SATIMO, in confidence and is not to be reproduced in whole or in part without the prior written permission. The information contained herein is to be used only for the purpose for which it is submitted and is not to be released in whole or in part without the prior written permission of SATIMO.

COMOSAR Dipole 1800 MHz Calibration Report	 Ref: CR.216.4.10.SATB.A		
	Page: 2/6	Issue: A	Date: 2010/08/04

DIPOLE 1800 MHz CALIBRATION REPORT

DATE: 15/09/2010

OBJECT: COMOSAR IEEE REFERENCE DIPOLE

MANUFACTURER: SATIMO

SERIAL NUMBER: SN 31/10 DIPF135

CUSTOMER: SIEMIC, INC.

CONTRACT: PO1007001

DATE OF CALIBRATION: 04/08/2010

WARRANTY:

This Calibration certificate may not be reproduced other than in full. Calibration certificates without signature and seal are not valid. This documentation contains property information which is protected by copyright. All right are reserved. No part of this document may be photocopied, reproduced without the prior written agreement of SATIMO. SATIMO shall not be liable for errors contained herein or for incidental or consequential in connection with the furnishing, performance or use of this material. Warranty doesn't apply to Normal wear, Normal tear, Improper use, Improper maintain, Improper installation.

Date

09-09-10

SAR TEAM MANAGER



2105 Barrett Park Dr., Suite 104
Kennesaw, GA - USA
 Tel: +1 678 797 9172
 Fax: +1 678 797 9173
 www.satimo.com

<h2>COMOSAR Dipole 1800 MHz Calibration Report</h2>			
	Ref: CR.216.4.10.SATB.A		
	Page: 3/6	Issue: A	Date: 2010/08/04

PRODUCT DESCRIPTION

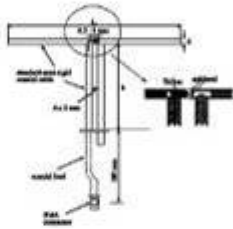

Dimension: L=72 mm/ h=41,7 mm / d=3.6 mm

CALIBRATION TEST EQUIPMENT

TYPE	IDENTIFICATION	DATE OF CALIBRATION
Vector Network Analyzer	HP8753D (SN: 5410A08882)	08-06-2009

MEASUREMENT PROCEDURE

We placed the dipole under the flat part of SAM phantom fill with 1800 MHz head liquid.

<h2 style="margin: 0;">COMOSAR Dipole 1800 MHz Calibration Report</h2>	 Ref: CR.216.4.10.SATB.A
Page: 4/6	Issue: A
Date: 2010/08/04	

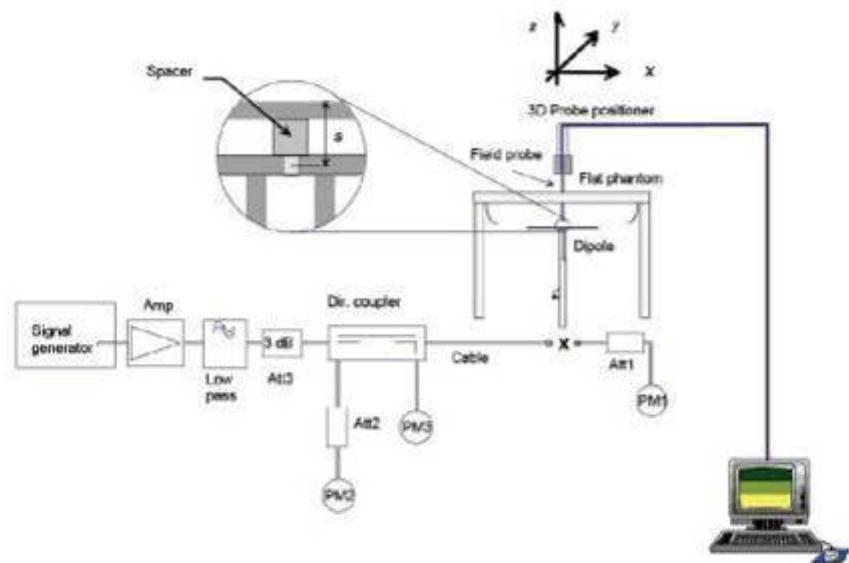

Calibration was performed according to IEEE Std P1528-2003 and OET bulletin 65 Supplement C (Ed. 01-01)

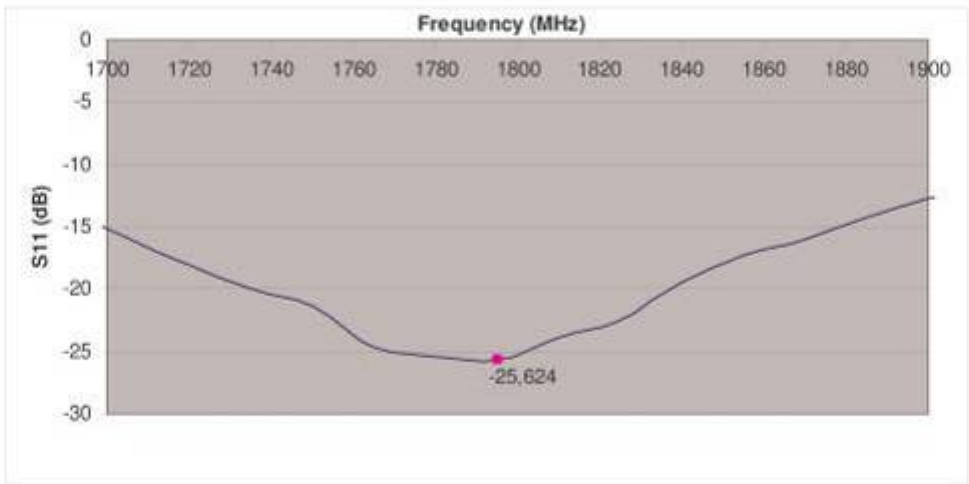

VSWR at 1800 MHz: -25.62 dB.

<h2>COMOSAR Dipole 1800 MHz Calibration Report</h2>	 Ref: CR.216.4.10.SATB.A			
	<table border="1" style="width: 100%; border-collapse: collapse;"> <tr> <td style="width: 33%;">Page: 5/6</td> <td style="width: 33%;">Issue: A</td> <td style="width: 33%;">Date: 2010/08/04</td> </tr> </table>	Page: 5/6	Issue: A	Date: 2010/08/04
Page: 5/6	Issue: A	Date: 2010/08/04		

SAR MEASUREMENT EQUIPEMENT

Voltmeter	Keithley (2000, SN:1000572)	Date of calibration: 24-06-2009
Signal generator	Rohde&Schwarz (SML_03, SN:101868)	Date of calibration: 14-11-2008
Power amplifier	Nuclétudes (ALB216, SN:10800)	Date of calibration: 20-10-2008
Power meter	Rohde&Schwarz (NRVD, SN:101066)	Date of calibration: 02-07-2009
Probe	SATIMO Bretagne (SN:EP37) CF (35.00,34.54,37.71)	Date of calibration: 08-06-2010

SAR MEASUREMENT CONDITION

Software	OpenSAR V3
Phantom	SATIMO Bretagne (SN: SN_20_07_SAM42)
Liquid	SATIMO Bretagne (Last Calibration: 04 08 10) Head Liquid Values: eps' : 39.33 sigma : 1.39
Distance between the center of the dipole and the liquid (set with a spacer)	10 mm
Area scan resolution	dx=8mm/dy=8mm
Zoom scan resolution	dx=8mm/dy=8m/dz=5mm
Frequency	1800 MHz
Input power	20 dBm
Expanded uncertainty (K=1)	8.09%

SAR MEASUREMENT RESULT

	10g	1g
R	SAR measured Liquid : HL	2.028 W/Kg +0.9 %
		3.859 W/Kg +0.5 %

<h2>COMOSAR Dipole 1800 MHz Calibration Report</h2>			
	Ref: CR.216.4.10.SATB.A		
	Page: 6/6	Issue: A	Date: 2010/08/04

SAR MEASUREMENT PLOTS

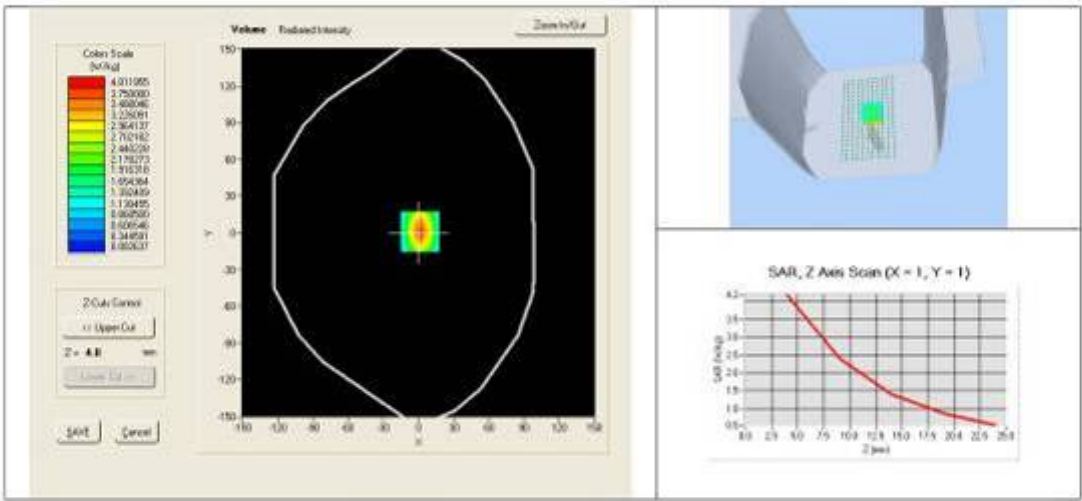

COMOSAR Dipole 1900 MHz Calibration Report			
	Ref: CR.216.5.10.SATB.A		
	Page: 1/6	Issue: A	Date: 2010/08/04

DIPOLE 1900 MHZ CALIBRATION REPORT

Prepared By: LUC Jérôme, SATIMO
 Project Description: SAR TEST BENCH
 Prepared For (End User): SIEMIC, INC.

This document is issued by SATIMO, in confidence and is not to be reproduced in whole or in part without the prior written permission. The information contained herein is to be used only for the purpose for which it is submitted and is not to be released in whole or in part without the prior written permission of SATIMO.

COMOSAR Dipole 1900 MHz Calibration Report	 Ref: CR.216.5.10.SATB.A		
	Page: 2/6	Issue: A	Date: 2010/08/04

DIPOLE 1900 MHz CALIBRATION REPORT

DATE: 15/09/2010

OBJECT: COMOSAR IEEE REFERENCE DIPOLE

MANUFACTURER: SATIMO

SERIAL NUMBER: SN 31/10 DIPG136

CUSTOMER: SIEMIC, INC.

CONTRACT: PO1007001

DATE OF CALIBRATION: 04/08/2010

WARRANTY:

This Calibration certificate may not be reproduced other than in full. Calibration certificates without signature and seal are not valid. This documentation contains property information which is protected by copyright. All right are reserved. No part of this document may be photocopied, reproduced without the prior written agreement of SATIMO. SATIMO shall not be liable for errors contained herein or for incidental or consequential in connection with the furnishing, performance or use of this material. Warranty doesn't apply to Normal wear, Normal tear, Improper use, Improper maintain, Improper installation.

Date

09-09-10

SAR TEAM MANAGER



2105 Barrett Park Dr., Suite 104
Kennesaw, GA - USA
 Tel: +1 678 797 9172
 Fax: +1 678 797 9173
 www.satimo.com

<h2 style="margin: 0;">COMOSAR Dipole 1900 MHz Calibration Report</h2>	 Ref: CR.216.5.10.SATB.A			
<table border="1" style="width: 100%; border-collapse: collapse;"> <tr> <td style="width: 33%;">Page: 3/6</td> <td style="width: 33%;">Issue: A</td> <td style="width: 33%;">Date: 2010/08/04</td> </tr> </table>		Page: 3/6	Issue: A	Date: 2010/08/04
Page: 3/6	Issue: A	Date: 2010/08/04		

PRODUCT DESCRIPTION

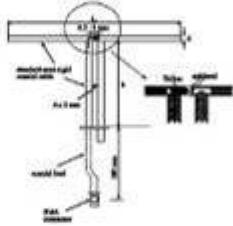

Dimension: L=68 mm/ h=39.5 mm / d=3.6 mm

CALIBRATION TEST EQUIPMENT

TYPE	IDENTIFICATION	DATE OF CALIBRATION
Vector Network Analyzer	HP8753D (SN: 5410A08882)	08-06-2009

MEASUREMENT PROCEDURE

We placed the dipole under the flat part of SAM phantom fill with 1900 MHz head liquid.

<h2 style="margin: 0;">COMOSAR Dipole 1900 MHz Calibration Report</h2>	 Ref: CR.216.5.10.SATB.A
Page: 4/6	Issue: A
Date: 2010/08/04	

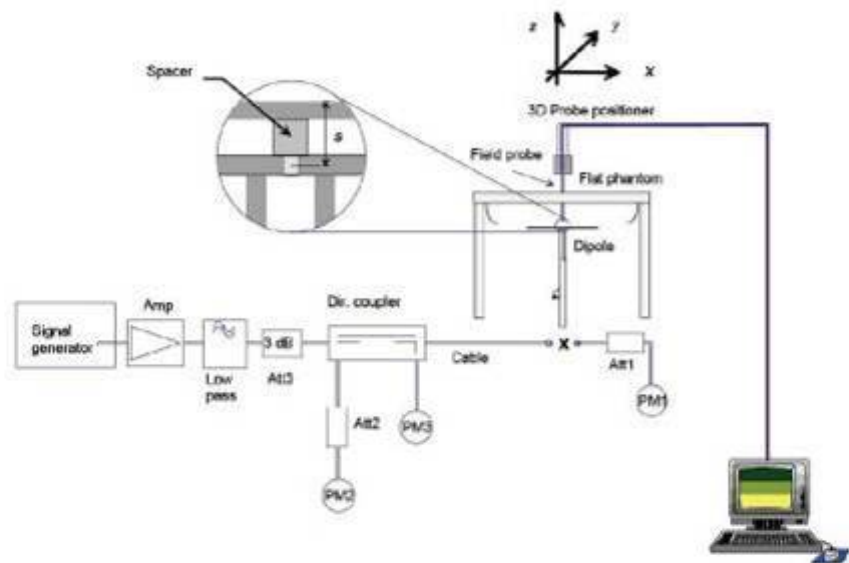

Calibration was performed according to IEEE Std P1528-2003 and OET bulletin 65 Supplement C (Ed. 01-01)

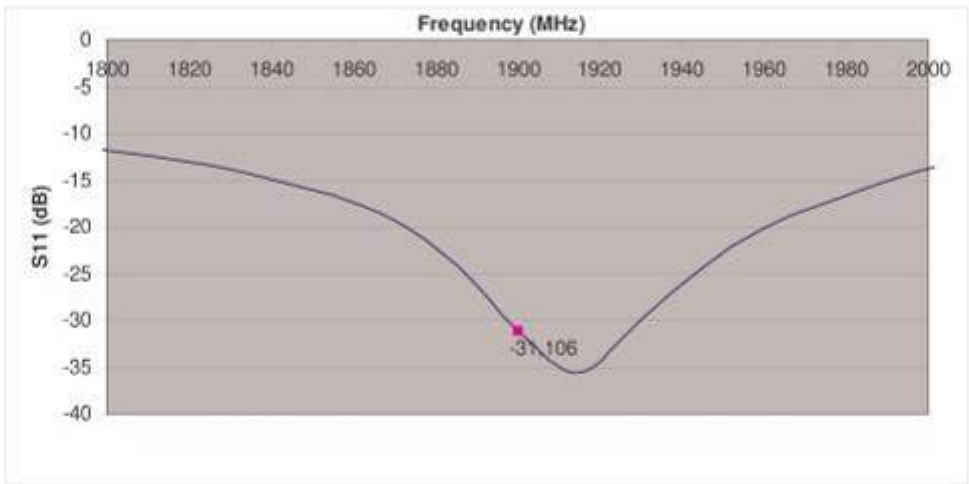

VSWR at 1900 MHz: -31.11 dB.

<h2>COMOSAR Dipole 1900 MHz Calibration Report</h2>	 Ref: CR.216.5.10.SATB.A			
	<table border="1" style="width: 100%; border-collapse: collapse;"> <tr> <td style="width: 33%;">Page: 5/6</td> <td style="width: 33%;">Issue: A</td> <td style="width: 33%;">Date: 2010/08/04</td> </tr> </table>	Page: 5/6	Issue: A	Date: 2010/08/04
Page: 5/6	Issue: A	Date: 2010/08/04		

SAR MEASUREMENT EQUIPEMENT

Voltmeter	Keithley (2000, SN:1000572)	Date of calibration: 24-06-2009
Signal generator	Rohde&Schwarz (SML_03, SN:101868)	Date of calibration: 14-11-2008
Power amplifier	Nucléudes (ALB216, SN:10800)	Date of calibration: 20-10-2008
Power meter	Rohde&Schwarz (NRVD, SN:101066)	Date of calibration: 02-07-2009
Probe	SATIMO Bretagne (SN:EP37) CF (35.57,34.83,37.93)	Date of calibration: 08-06-2010

SAR MEASUREMENT CONDITION

Software	OpenSAR V3
Phantom	SATIMO Bretagne (SN: SN_20_07_SAM42)
Liquid	SATIMO Bretagne (Last Calibration: 04 08 10) Head Liquid Values: eps' : 39.13 sigma : 1.44
Distance between the center of the dipole and the liquid (set with a spacer)	10 mm
Area scan resolution	dx=8mm/dy=8mm
Zoom scan resolution	dx=8mm/dy=8m/dz=5mm
Frequency	1900 MHz
Input power	20 dBm
Expanded uncertainty (K=1)	8.09%

SAR MEASUREMENT RESULT

	10g	1g
R	SAR measured Liquid : HL	2.093 W/Kg +2.1 %
		4.077 W/Kg +2.7 %

<h2>COMOSAR Dipole 1900 MHz Calibration Report</h2>			
	Ref: CR.216.5.10.SATB.A		
	Page: 6/6	Issue: A	Date: 2010/08/04

SAR MEASUREMENT PLOTS

