

**Intellian C700**  
Iridium Certus® L-band terminal



Installation & Operation User Guide

## Serial number of the product

This serial number will be required for all troubleshooting or service inquiries.

# Intellian

© 2020 Intellian Technologies, Inc. All rights reserved. Intellian and the Intellian logo are trademarks of Intellian Technologies, Inc., registered in the U.S. and other countries. The Intellian C700 is a trademark of Intellian Technologies, Inc. Intellian may have patents, patent applications, trademarks, copyrights, or other intellectual property rights covering subject matter in this document. Except as expressly provided in any written license agreement from Intellian, the furnishing of this document does not give you any license to these patents, trademarks, copyrights, or other intellectual property. All other logos, trademarks, and registered trademarks are the property of their respective owners. Information in this document is subject to change without notice. Every effort has been made to ensure that the information in this manual is accurate. Intellian is not responsible for printing or clerical errors.

### Disclaimer

The information in this user manual is subject to change without prior notice through a product life cycle. A printed version of the user manual is periodically updated and may contain inaccuracies or omissions compared to the recent product information. The most up-to-date information is available on our website at <https://www.intelliantech.com>.

# Table of Contents

<b>Chapter 1. Precautions</b>	8
1.1 Warnings, Cautions, and Notes	8
1.2 General Precautions	8
1.3 Iridium Satellite Network	9
<b>Chapter 2. Certifications</b>	10
2.1 Certifications	10
<b>Chapter 3. Introduction</b>	11
3.1 Introduction of Intellian C700	11
3.2 Features of Intellian C700	11
<b>Chapter 4. Planning Installation</b>	12
4.1 Selecting Installation Site	12
4.1.1 Avoiding RF Interference	12
4.1.2 RF Hazard Precautions	13
4.2 System Package	14
4.2.1 Above Deck Unit (ADU)	14
4.2.2 Below Deck Unit (BDU)	14
4.2.3 Packing List	15
4.3 System Cables	16
4.3.1 RF Cable (Connecting ADU - BDU)	16
4.4 Unpacking System Package	17
<b>Chapter 5. Installing ADU</b>	19
5.1 Antenna Dimensions	19
5.2 ADU Mounting Template	20
5.3 Mast Designing (Installation Example)	21
5.4 Mounting Antenna	23
5.4.1 Mounting Antenna using Inner Holes (with M6 Bolts)	23
5.4.2 Mounting Antenna using Outer Holes (with M10 Bolts)	23
5.4.3 Mounting Antenna on Pole (Optional)	24
5.5 Vent Hole	25
5.6 Connecting RF Cable to Antenna	26
<b>Chapter 6. Installing BDU</b>	27

<b>6.1 BDU Dimensions</b>	27
<b>6.2 Selecting BDU Installation Site</b>	28
<b>6.3 BDU Mounting Template</b>	29
<b>6.4 Mounting BDU</b>	29
6.4.1 Direct Mounting Type	29
6.4.2 19-inch Rack Mounting Type (Optional)	30
<b>6.5 Setting up SIM Card</b>	31
6.5.1 Inserting SIM Card	31
<b>6.6 Antenna System Configuration</b>	32
6.6.1 Antenna System Configuration	32
6.6.2 Data sessions and voice calls	32
<b>6.7 BDU Cable Connection</b>	33
6.7.1 BDU Back Panel View	33
<b>6.8 BDU Connector Pinout Guide</b>	33
6.8.1 LAN Ports (RJ45)	33
6.8.2 Phone Port (RJ14 & 6P4C)	34
6.8.3 General Purpose Inputs/Outputs (GPIO) Connector	35
6.8.4 Power Connector (DC Power)	36
6.8.5 Connecting BDU to ADU (Antenna)	37
<b>6.9 Grounding Stud</b>	37

**Chapter 7. Operating BDU** ..... 38

<b>7.1 BDU Front Panel</b>	38
<b>7.2 Powering On System</b>	39
<b>7.3 Making POTS Phone Call</b>	39
<b>7.4 Using PoE Devices</b>	40
7.4.1 Accessing Internet	40
<b>7.5 Using Wireless Devices</b>	40
7.5.1 Installing Mobile Application	40
7.5.2 Setting up Wi-Fi	41
7.5.3 Setting up New Extension (Optional)	41
7.5.4 Making Wireless Device Call	42

**Chapter 8. Using AptusLX** ..... 43

<b>8.1 Introduction</b>	43
8.1.1 How to Access Internal Webpage of BDU	43
<b>8.2 Main Page</b>	44
8.2.1 Page Login	44
<b>8.3 Top Menus</b>	45

<b>8.4 Account Menu</b>	46
8.4.1 User	46
<b>8.5 Dashboard</b>	47
<b>8.6 Status</b>	48
8.6.1 Network	48
8.6.2 Wi-Fi	49
8.6.3 Phone/PBX	50
8.6.4 Data	51
8.6.5 Certus	52
8.6.6 SIM	53
8.6.7 Terminal info	54
8.6.8 External GPIO	55
8.6.9 SDF	56
<b>8.7 Settings</b>	57
8.7.1 Network	57
8.7.2 Wi-Fi	58
8.7.3 Firewall	59
8.7.4 Phone/PBX	60
8.7.5 Data	61
8.7.6 SDF	63
8.7.7 External GPIO	64
<b>8.8 Tools</b>	65
8.8.1 Software Upgrade	65
8.8.2 Backup & Restore	67
8.8.3 Reset	68
8.8.4 Logs	69
8.8.5 Diagnostic	70
<b>Chapter 9. Specification</b>	71
9.1 Technical Specification	71
9.2 Environmental Specification	72
<b>Chapter 10. Warranty</b>	73
10.1 Warranty Policy	73
<b>Chapter 11. Appendix</b>	74
11.1 Tightening Torque Specification	74

# List of Figures



<b>Chapter 1. Precautions</b> .....	8
Figure 1: Earth Showing Iridium Satellite in Six Defined Orbital Planes.....	9
<b>Chapter 4. Planning Installation</b> .....	12
Figure 2: Potential RF Interference.....	12
Figure 3: RF Hazard Precautions.....	13
Figure 4: Above Deck Unit (ADU) / Antenna Unit.....	14
Figure 5: Below Deck Unit (BDU).....	14
Figure 6: Unpacking System Package (with ADU & BDU Sub-package).....	17
Figure 7: Unpacking BDU Package.....	17
Figure 8: Unpacking ADU Package.....	18
<b>Chapter 5. Installing ADU</b> .....	19
Figure 9: Antenna Dimensions.....	19
Figure 10: ADU Mounting Template.....	20
Figure 11: Recommended Mast Design using Inner Holes (with M6 Bolts).....	21
Figure 12: Recommended Mast Design using Outer Holes (with M10 Bolts).....	22
Figure 13: Mounting Antenna using Inner Holes (with M6 Bolts).....	23
Figure 14: Mounting Antenna using Outer Holes (with M10 Bolts).....	23
Figure 15: Installing 40A Pole Bushing inside Pole Tube.....	24
Figure 16: Installing Pole Bracket.....	24
Figure 17: Mounting Antenna on Pole Mounted Bracket.....	25
Figure 18: Vent Hole.....	25
Figure 19: Connecting RF Cable using Inner Holes (with M6 Bolts).....	26
Figure 20: Connecting RF Cable using Outer Holes (with M10 Bolts).....	26
<b>Chapter 6. Installing BDU</b> .....	27
Figure 21: BDU Dimensions (Direct Mounting Type).....	27
Figure 22: BDU Dimensions (19-inch Rack Mounting Type_Optional).....	28
Figure 23: BDU Mounting Template.....	29
Figure 24: Direct Mounting of BDU.....	29
Figure 25: Attach Connector Tray to BDU.....	30
Figure 26: Attach Rackmount Plate to BDU.....	30
Figure 27: Intellian C700 System with Connected Devices.....	32
Figure 28: BDU Back Panel View.....	33
Figure 29: LAN Ports (RJ45) Pinout.....	33
Figure 30: Phone Port (RJ14 & 6P4C) Pinout.....	34
Figure 31: Using Cable Splitter with RJ14 Phones.....	34

Figure 32: GPIO Connector Pinout.....	35
Figure 33: Power Connector Pinout.....	36
Figure 34: BDU to Antenna Cable Connection.....	37
Figure 35: Grounding Stud Connection.....	37
<b>Chapter 7. Operating BDU.....</b>	<b>38</b>
Figure 36: BDU Front Panel.....	38

# Chapter 1. Precautions





## 1.1 Warnings, Cautions, and Notes

WARNING, CAUTION, and NOTE statements are used throughout this manual to emphasize important and critical information. You must read these statements to help ensure safety and to prevent product damage. The statements are defined below.

	<p><b>WARNING</b></p> <p>WARNING indicates a potentially hazardous situation which, if not avoided, could result in death or serious injury.</p>
	<p><b>CAUTION</b></p> <p>CAUTION indicates a potentially hazardous situation which, if not avoided, could result in minor or moderate injury or damage to equipment. It may also be used to alert against unsafe practices.</p>
	<p><b>NOTE</b></p> <p>A NOTE statement is used to notify people of installation, operation, programming, or maintenance information that is important, but not hazard-related.</p>

## 1.2 General Precautions

Before you use the antenna, make sure that you have read and understood all safety requirements.

	<p><b>THIS WAY UP</b></p> <ul style="list-style-type: none"> <li>Place the boxes/crates on the floor with the arrow pointing up.</li> </ul>
	<p><b>FRAGILE</b></p> <ul style="list-style-type: none"> <li>Since the Radome is fragile, handle it with care. Do not apply excessive pressure or shock. These may cause surface cracking or other damage.</li> </ul>
	<p><b>DO NOT STACK MORE THAN FOUR UNITS</b></p> <ul style="list-style-type: none"> <li>Do not stack boxes/crates more than four units as there is a risk boxes/crates may fall and be damaged.</li> </ul>
	<p><b>KEEP DRY</b></p> <ul style="list-style-type: none"> <li>Always make sure the antenna is stored on a dry surface in a dry, well-ventilated area.</li> <li>The antenna is designed to withstand a normal rain shower; however, water resistance cannot be guaranteed if the antenna is submerged.</li> </ul>

\* **DO NOT SHIP VIA RAIL:** Ensure not to ship any system via Rail.

\* **DO NOT STORE THE ANTENNA WRAPPED IN A TARP, TENT, VINYL, AND OTHERS:**

To avoid damage to radome paint, do not use a cover on the radome. Using any type of cover may cause paint damage. Intellian radomes are designed to withstand exposure to rain, humidity, and sun/UV rays when assembled according to Intellian instructions, and when the supplied approved hardware and sealants are used. Under no circumstances should an Intellian radome be covered by any protective covering that adheres, bonds, or clings to the surface, whether by self-adhesion or tension.



**\* Shock Hazard:**

To minimize shock hazard and to protect against lightning, you must connect the equipment chassis and cabinet to an electrical ground. Make sure the system is correctly grounded and power is off when installing, configuring, and connecting components.

**\* Do not operate in an explosive atmosphere:**

Do not operate the equipment in explosive environments or in the presence of flammable gases. Operating this equipment in such an environment causes a definite safety hazard.

**\* Keep away from living circuits:**

Operating personnel must at all times observe all safety regulations. Do not replace components or make adjustment inside the equipment with any power supply turned on. Under certain conditions, dangerous potentials may exist in the power supplies even with the power cable removed. To avoid injuries, always remove the power and discharge a circuit before touching it.

## 1.3 Iridium Satellite Network

The Iridium satellite network is comprised of 66 low-earth orbiting (LEO), cross-linked satellites, providing voice and data coverage over Earth's entire surface.

At only 476 (780 km) from the earth, the proximity of Iridium's LEO network means pole-to-pole coverage, a shorter transmission path, stronger signals, lower latency, and shorter registration time than with GEO satellites. The network is considered a meshed constellation of interconnected, cross-linked satellites so that each satellite "talks" with the other nearby satellites in front, behind, and adjacent orbits.

In space, each Iridium satellite is linked to up to four others creating a dynamic network that routes traffic among satellites to ensure global coverage, even when traditional local systems are unavailable.



Figure 1: Earth Showing Iridium Satellite in Six Defined Orbital Planes

# Chapter 2. Certifications

## 2.1 Certifications

This device complies with part 15 of the FCC Rules and with Industry Canada licence-exempt RSS standard(s).

Operation is subject to the following two conditions:

- (1) This device may not cause harmful interference, and
- (2) this device must accept any interference received, including interference that may cause undesired operation.

*L'émetteur/récepteur exempt de licence contenu dans le présent appareil est conforme aux CNR d'Innovation, Sciences et Développement économique Canada applicables aux appareils radio exempts de licence. L'exploitation est autorisée aux deux conditions suivantes :*

*(1) L'appareil ne doit pas produire de brouillage;*

*(2) L'appareil doit accepter tout brouillage radioélectrique subi, même si le brouillage est susceptible d'en compromettre le fonctionnement.*

Changes or modifications made to this equipment not expressly approved by Intellian Technologies, Inc. may void the FCC authorization to operate this equipment.

Radiofrequency radiation exposure Information:

This equipment complies with RED and FCC, IC radiation exposure limits set forth for an uncontrolled environment. This equipment should be installed and operated with minimum distance of 1.5 m between the radiator and your body.

This transmitter must not be co-located or operating in conjunction with any other antenna or transmitter.

Note: This equipment has been tested and found to comply with the limits for a Class B digital device, pursuant to part 15 of the FCC Rules. These limits are designed to provide reasonable protection against harmful interference in a residential installation. This equipment generates, uses and can radiate radio frequency energy and, if not installed and used in accordance with the instructions, may cause harmful interference to radio communications. However, there is no guarantee that interference will not occur in a particular installation. If this equipment does cause harmful interference to radio or television reception, which can be determined by turning the equipment off and on, the user is encouraged to try to correct the interference by one or more of the following measures:

- Reorient or relocate the receiving antenna.
- Increase the separation between the equipment and receiver.
- Connect the equipment into an outlet on a circuit different from that to which the receiver is connected.
- Consult the dealer or an experienced radio/TV technician for help.

# Chapter 3. Introduction

## 3.1 Introduction of Intellian C700

Intellian C700 maritime satellite terminal utilizes Iridium NEXT network of 66 Low-Earth Orbit (LEO) satellites, providing pole-to-pole communication. Using the Iridium Certus® service, the Intellian C700 provides three high-quality voice lines and the IP data speeds up to 704 kbps. The Intellian C700 introduces the most competitive, highly efficient RF performance, and easy to install solutions that aim to satisfy customers' demand for a low cost of ownership in terms of deployment, installation, and efficient operation.

## 3.2 Features of Intellian C700

### Superior Data Connection

With the Iridium Certus® service, the Intellian C700 allows for 3 simultaneous high-quality voice calls along with 352 kbps uplink and 704 kbps downlink and up to 256 kbps for IP streaming.

### RF Performance

The 12-element patch antenna improves low elevation angle performance. This innovative electronic phased-array antenna guarantees a reliable and high-throughput connection in all conditions. Also, the H2 class high power amplifier enables uplink data speeds up to 352 kbps as standard.

### Single Coaxial Cable Connection

The BDU and ADU are connected by a single coaxial cable. Ethernet over Coaxial technology allows for both power and control signals to transfer to the ADU through a single cable with economical cable solutions.

### Built-in Security and Networking Features

A powerfully designed Below Deck Unit enables various network features with strong security measures. A dedicated WAN port provides a solution for an alternative data connection. Also embedded 4 LAN ports allows various IP device connections, with PoE features for simple use such as SIP phones. The BDU supports rich network functions such as DHCP, NAT, Port Forwarding to perform as a router.

### Rich Voice Features

Intellian C700 supports multi-standard for voice devices. Both wired and wireless SIP phones can be utilized for the voice connection. Also, BDU can connect the analog phones with the built-in ATA, Analog Telephone Adapter. In addition, the SIP applications for a smartphone can access the BDU through the Wi-Fi antenna. For these multiple types of voice equipment solutions, embedded soft PBX maneuvers up to 16 SIP phones for inter and intra network communications.

# Chapter 4. Planning Installation

The antenna installation requires precaution and safety measures. Failure to follow the correct installation process may lead to injury of the installer and/or cause damage to the system. In order to maximize the performance of the system, a thorough review of this installation guide is strongly recommended, as well as executing the installation process as it is noted in this manual.

## 4.1 Selecting Installation Site

The antenna should be placed in an area on-board of the vessel with an unobstructed view extending from (at least)  $-30^\circ$  below the horizontal surface in all azimuth direction. When the antenna is transmitting, obstacles in way of the beam path will cause decreased satellite signal strength. The antenna unit should have direct line-of-sight with the desired satellite without any obstacles in the beam path. Certain minimum distances between the antenna and other onboard devices must also be considered during installation.

Do not place the antenna near to a funnel because smoke deposits can cause corrosion of the antenna. In addition, the deposit can result in any malfunction of the antenna.

Do not place the antenna where there is a direct spray of seawater to avoid percolating any water into the vent hole.

### 4.1.1 Avoiding RF Interference

Do not install the antenna near the high power shortwave radar. Most radar transmitters emit RF energy within an elevation range of  $-15^\circ$  to  $+15^\circ$ . For this reason, it is recommended to position the antenna at least 4.6 m (15.09 feet) away from any radars (s-band, c-band, and x-band radar up to 50kW).

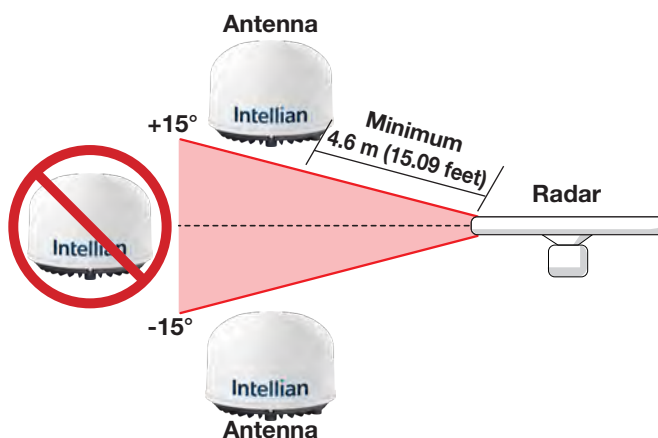

Figure 2: Potential RF Interference



#### WARNING

Never place the antenna in the beam path of the radar regardless of distance. The high power shortwave radar may impair its performance or damage the antenna.

### 4.1.2 RF Hazard Precautions

The antenna is designed to be used with radiation transmitting equipment manufactured by others. Exposure to RF radiation, including exposure associated with improper use of the transmitting equipment, may be hazardous to people who work close to the Above Deck Unit. Ensure the safety of personnel who work with in the system.

During transmission, ensure to keep the minimum safety distance. The recommended minimum safety distance to the reflector on the focal line is about 1 m (3.28 ft) based on a radiation level of 1 mW/cm<sup>2</sup> that applies under uncontrolled environment. No hazard exists >20° below the antenna's mounting plane.

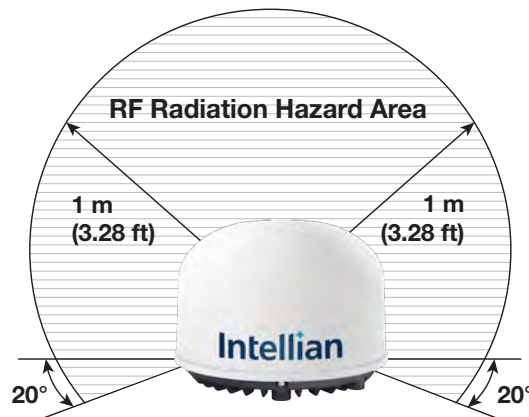

Figure 3: RF Hazard Precautions

## 4.2 System Package

### 4.2.1 Above Deck Unit (ADU)

The Above Deck Unit (ADU) is an antenna unit with 12-element patch antenna, active RF switch circuitry, BCX (L-band modem), and GNSS circuit. The radome protects the antenna unit from a severe marine environment. All signals (and DC power) shall pass through a single coaxial antenna cable, which connects the ADU to the BDU.



Figure 4: Above Deck Unit (ADU) / Antenna Unit

### 4.2.2 Below Deck Unit (BDU)

The Below Deck Unit (BDU) supports voice and data communications in a marine environment. The BDU is the main control unit of an antenna system that monitors and controls the antenna operation through Intellian's web-based software. The BDU contains user interfaces and controls all communication between the ADU and the local communication devices such as phones, and computers, etc.



Figure 5: Below Deck Unit (BDU)

### 4.2.3 Packing List

Before beginning installation, make sure you have all the included components.

The ADU Package & BDU Package are provided in one box.

**NOTE:** The SIM card is provided by the service provider and may be packaged separately.

#### **Above Deck Unit (ADU) Package**

Description	Q'ty	Size	Remarks
Above Deck Unit (ADU)	1	370 mm x 370 mm x 270 mm	Antenna Unit
LMR200 RF Cable (TNC/F-TNC/F Type)	1	25 m	To connect ADU - BDU
Antenna Mounting Template	1		Antenna Mounting Template
Hex Bolt	5	M6 x 20L	To Mount Antenna on Mounting Surface (M6 Bolt Kit)
Spring Washer	5	M6	
Flat Washer	5	M6	
Hex Bolt	5	M10 x 20L	To Mount Antenna on Mounting Surface (M10 Bolt Kit)
Spring Washer	5	M10	
Flat Washer	5	M10	

#### **Below Deck Unit (BDU) Package**

Description	Q'ty	Size	Remarks
Below Deck Unit (BDU)	1	315 mm x 190 mm x 42 mm	Antenna Control Unit
DC Power Cable	1	1 m	BDU Power
Wire Connector	3		For DC Power Cable Extension
Ethernet Cable (RJ45 / LAN)	1	1 m	To connect BDU to PC
Wi-Fi Antenna	1		
Quick Installation Guide (QIG)	1		Quick Installation Guide
Tapping Screw	5	M5 x 16L	To Fix BDU (Direct Mounting Type)

#### **19-inch Rack Mount Kit (Optional)**

The 19-inch Rack Mount Kit can be purchased separately. When this kit is supplied, it is packaged in the BDU Package.

Description	Q'ty	Size	Remarks
Rackmount Plate	1		Kit for Rackmount Plate
Pan Head Screw (with Spring & Flat Washer)	5	M4 x 16L	
Connector Tray	1		Kit for Connector Tray
Flat Head Screw	4	M3 x 6L	

**Antenna Pole Mount Kit (Optional)**

The Antenna Pole Mount Kit can be purchased separately. When this kit is supplied, it is provided in a separate box.

Description	Q'ty	Size	Remarks
Pole Bracket	1		
Pole Tube	1		
Hex Bolt	10	M6 x 20L	
Spring Washer	10	M6	
Flat Washer	10	M6	
40A (1½ inch) Pole Bushing	1		For Mounting Aantenn on 40A (1½ inch) Pole
Socket Set Screw	4	M12 x 12L	

**4.3 System Cables**

Make sure of the following before installing system cables.

1. All cables need to be well clamped and protected from physical damage and exposure to heat and humidity.
2. Don't use any acutely bent cable.
3. Use watertight glands or swan neck tubes on exposed bulkheads or deck heads where the cable passes through.
4. For installing cables longer than the recommended length, consult with Intellian Technologies first.

**4.3.1 RF Cable (Connecting ADU - BDU)**

Due to the signal losses across the length of the RF coax on L-Band, Intellian recommends the following 50 Ω coax cable types for standard system installations. Check the instructions from the cable supplier.

The table below shows the recommended cable types and maximum cable lengths for the antenna system.

Coaxial Cable Type	@900MHz	@900MHz	loss 10 dB	Recommended Max. Cable Length
LMR200	32.6 dB/100 M	0.326 dB/1 M	27.6 M	25 M
LMR300	19.9 dB/100 M	0.199 dB/1 M	45.2 M	45 M
LMR400	12.16 dB/100 M	0.1216 dB/1 M	74.0 M	75 M

- Maximum DC resistance of RF cable: 0.5 Ω.
- RF loss at 900MHz : 10 dB incl. connector.
- Optimal tightening torque for TNC-type connector: 1.5 N-m.



## 4.4 Unpacking System Package

Follow steps for easy and safe unpacking. The system package consists of two sub-packages that an ADU Package and a BDU Package.

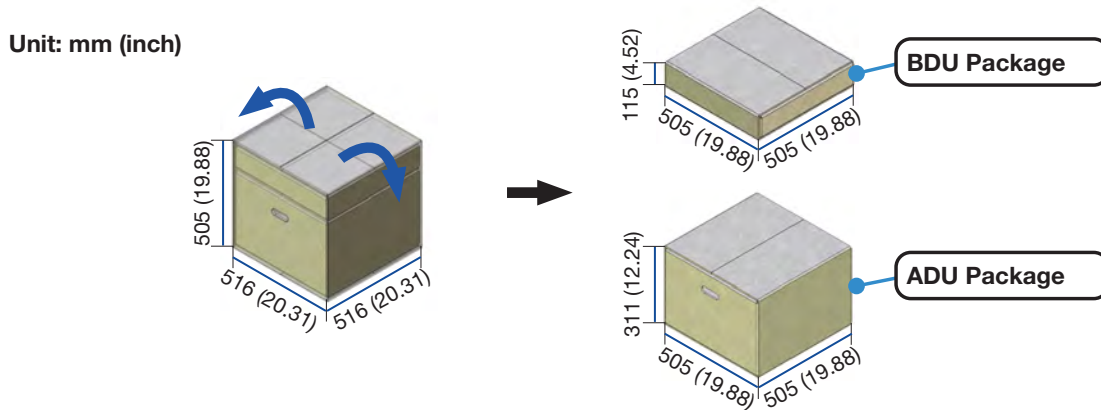

Figure 6: Unpacking System Package (with ADU & BDU Sub-package)

1. Remove the top cover and take out the BDU package including a Quick Installation Guide, a BDU Unit, a Wi-Fi Antenna, a DC Power Cable, an Ethernet Cable, a BDU Bolt Kit, and Wire Nut Connectors.

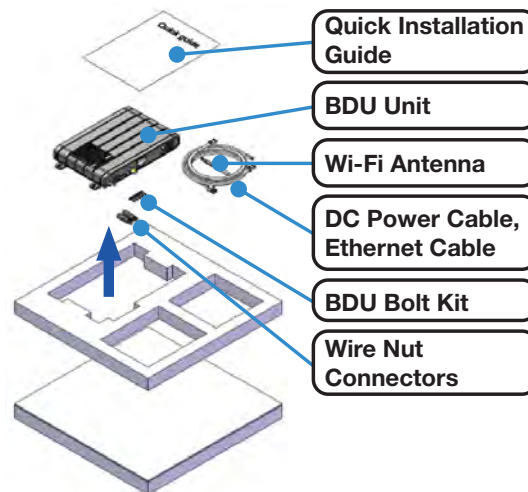

Figure 7: Unpacking BDU Package

2. Take out the ADU package including an Antenna Mounting Template, an ADU Bolt Kit, an RF Cable, and an ADU Unit.

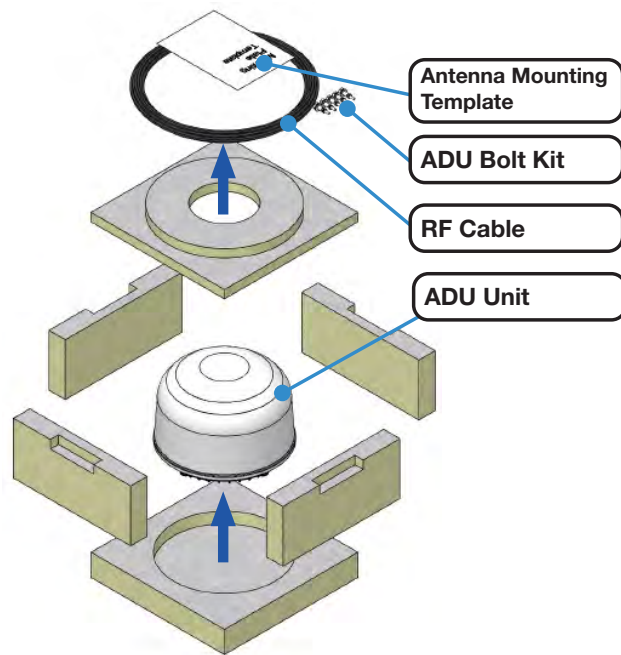

Figure 8: Unpacking ADU Package

# Chapter 5. Installing ADU

## 5.1 Antenna Dimensions

Confirm the height and diameter of the antenna unit shown in the following figure before installing it. To protect the cable connectors on the radome bottom, the antenna is shipped from the factory with protective stickers on the Inner Holes and protective covers on the Outer Holes.

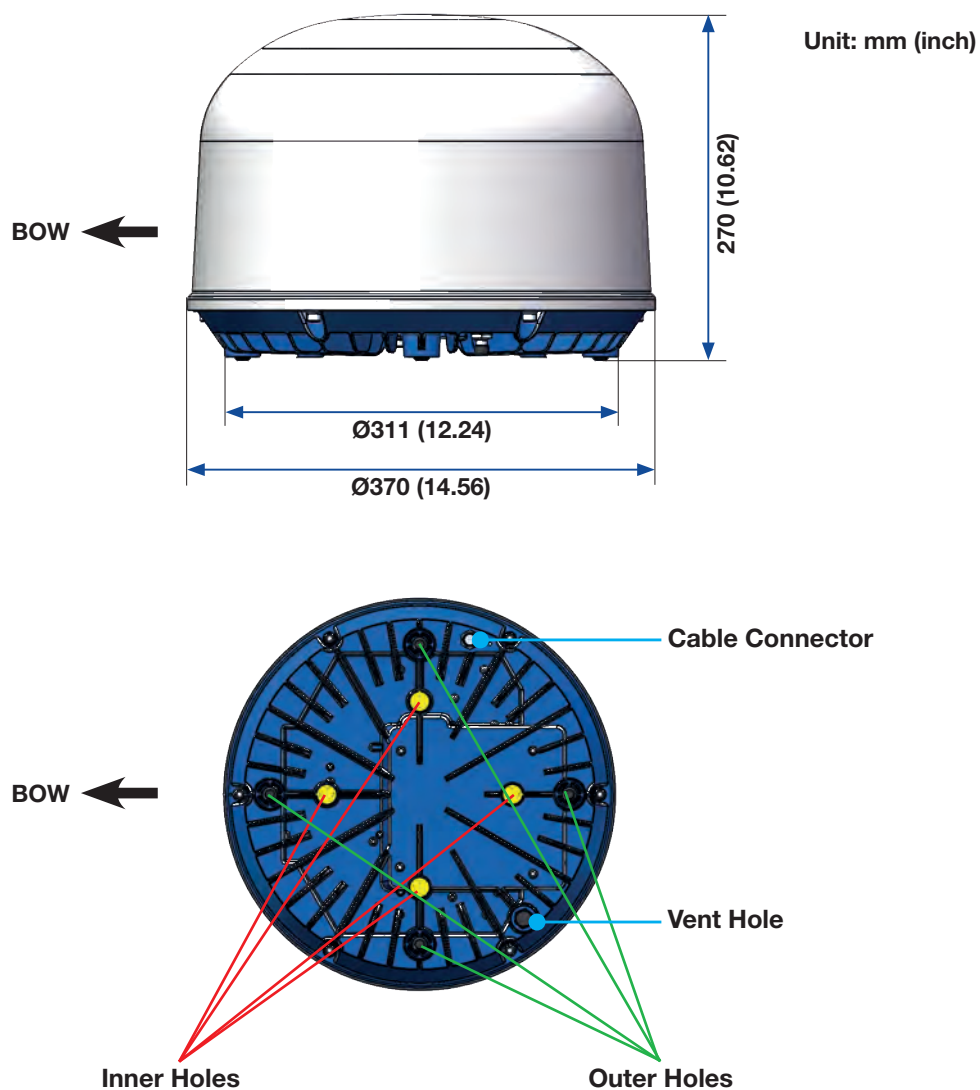

Figure 9: Antenna Dimensions

## 5.2 ADU Mounting Template

The lower radome has two types of industry-standard mounting holes, each with four mounting points. This hole pattern is compatible with other companies' mounting holes. Select one of the two mounting types to secure the antenna to the desired mounting surface.

- **Inner Hole Type:** mount the antenna using 'Inner Drill Holes' (with M6 Bolts). Intellian offers the Antenna Pole Mount Kit (separate purchase) that uses Inner Holes (with M6 Bolts) to mount the antenna on a pole.
- **Outer Hole Type:** mount the antenna using 'Outer Drill Holes' (with M10 Bolts). Make a cut-out in the flange using the 'Cutting Hole for Cable Connector' patten to avoid hiding the cable connector. Make a cut-out in the flange using the 'Cutting Hole for Vent Hole' patten to avoid hiding the vent hole.

The mounting holes must be in the exact same place as shown in the provided mounting template below.

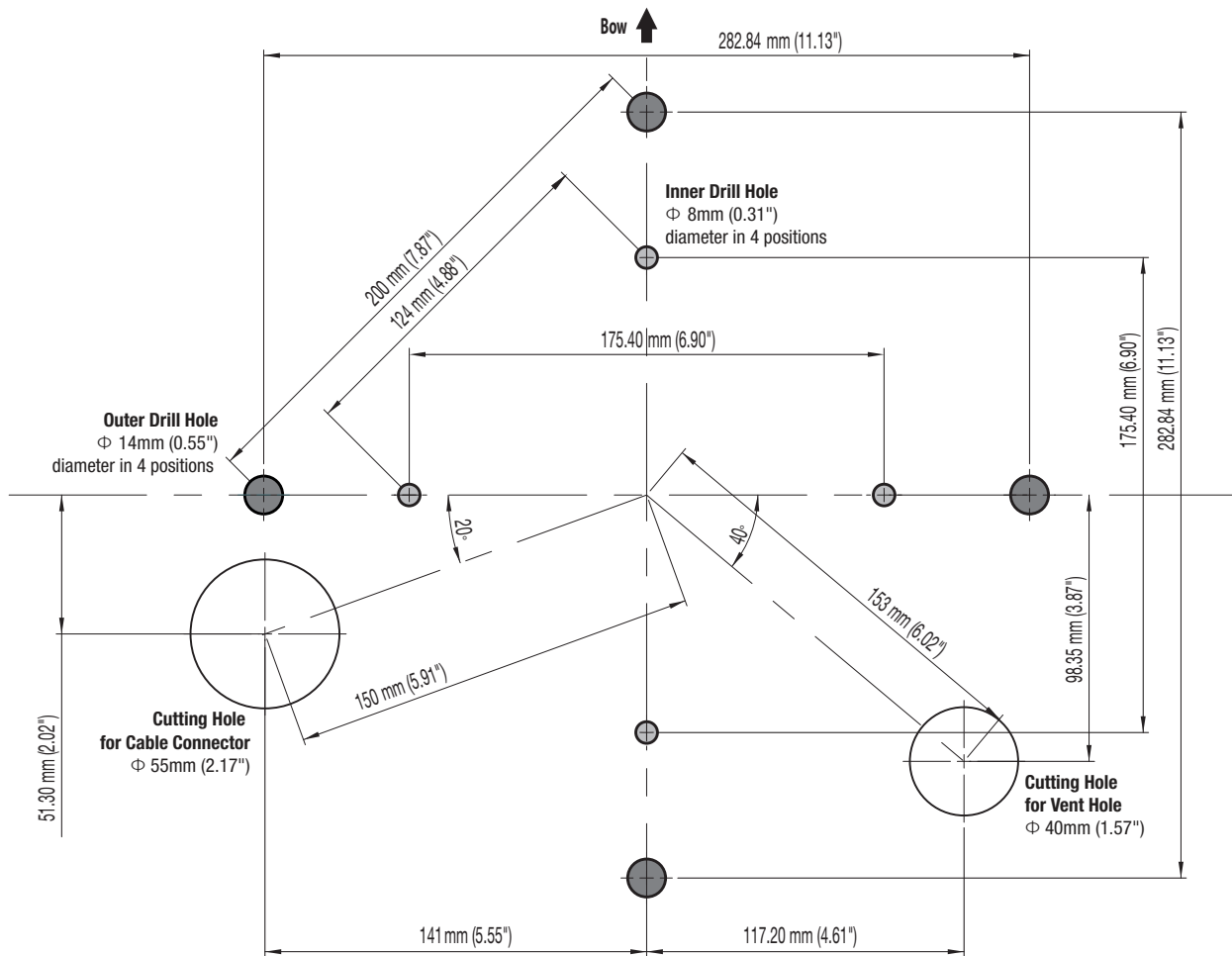
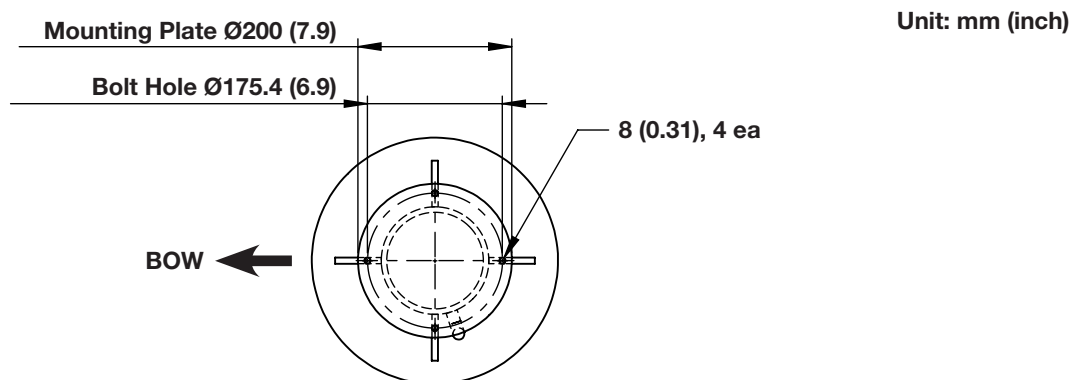

Figure 10: ADU Mounting Template

### 5.3 Mast Designing (Installation Example)

The installation mast must be robust enough to prevent flection, vibration, and sway when an external force is exerted on the mast with antenna and radome. Intellian strongly recommends installing the antenna less than 1200mm (47") above the deck. The flange thickness must be at least 8 mm. Refer to the following mast drawing for more details.

**Option 1. When Mounting Antenna using Inner Holes (with M6 Bolts)**



**\*NOTE:** There is no need to install gusset at the top end of the mast when using Inner Holes.

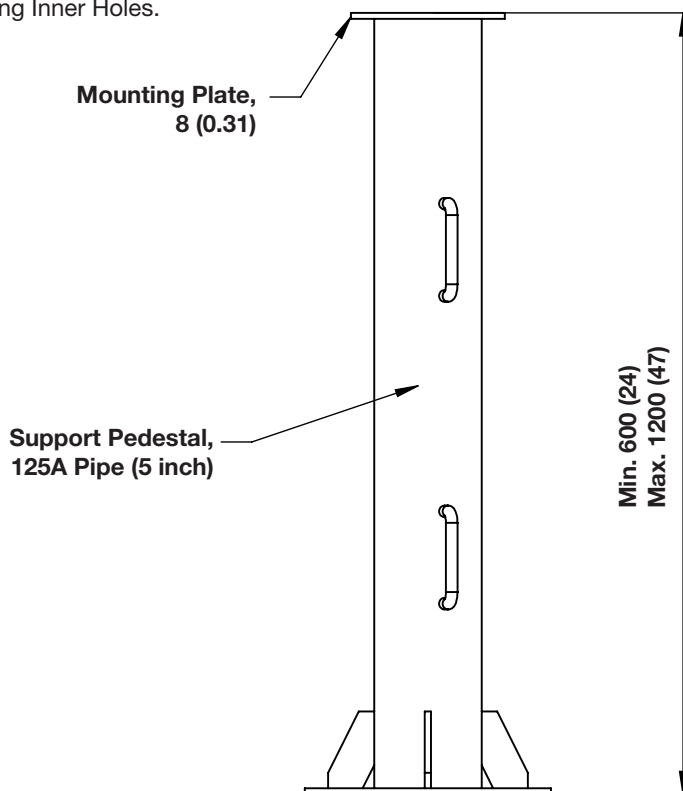

Figure 11: Recommended Mast Design using Inner Holes (with M6 Bolts)

Option 2. When Mounting Antenna using Outer Holes (with M10 Bolts)

Unit: mm (inch)

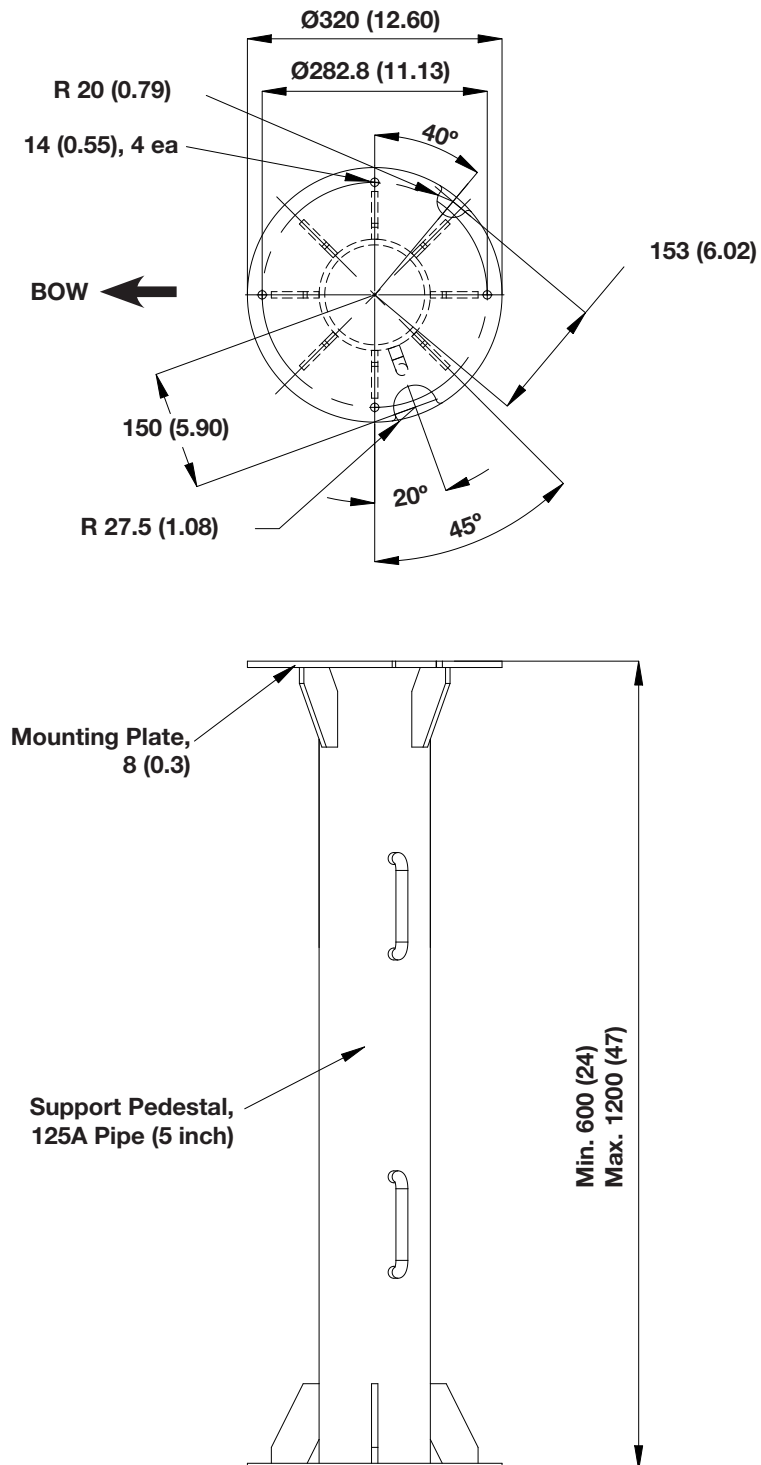

Figure 12: Recommended Mast Design using Outer Holes (with M10 Bolts)

## 5.4 Mounting Antenna

The lower radome has two types of industry-standard mounting holes, each with four mounting points. Select one of the two mounting types to secure the antenna to the desired mounting surface. Bring the provided Antenna Mounting Template and the Bolts from the BDU box. Create the appropriate hole pattern in the desired mounting surface for the chosen mounting bolts type.

### 5.4.1 Mounting Antenna using Inner Holes (with M6 Bolts)

First, remove the protective stickers on the Inner Holes. Check the position of the **A** antenna's cable connector and BOW direction. Lift the antenna above the mounting surface using hands and carefully put the antenna down in place. Before assembling bolts, apply Loctite #263 to the bolt's threads to ensure the bolts are fastened firmly. **B** Insert the bolts and washers from under the mast into the radome, and fasten them to the nuts assembled inside the radome using the torque wrench.

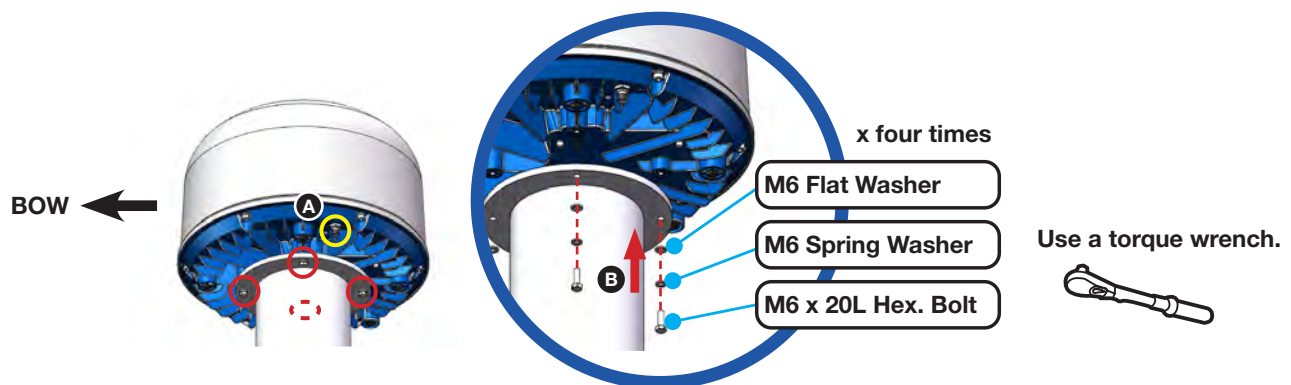

Figure 13: Mounting Antenna using Inner Holes (with M6 Bolts)

### 5.4.2 Mounting Antenna using Outer Holes (with M10 Bolts)

First, remove the protective covers on the Outer Holes. Check the position of the **A** antenna's cable connector and BOW direction. When placing the antenna on the mounting surface, be careful of the direction of the cutting holes. Lift the antenna above the mounting surface using hands and carefully put the antenna down in place. Before assembling bolts, apply Loctite #263 to the bolt's threads to ensure the bolts are fastened firmly. **B** Insert the bolts and washers from under the mast into the radome, and fasten them to the nuts assembled inside the radome using the torque wrench.

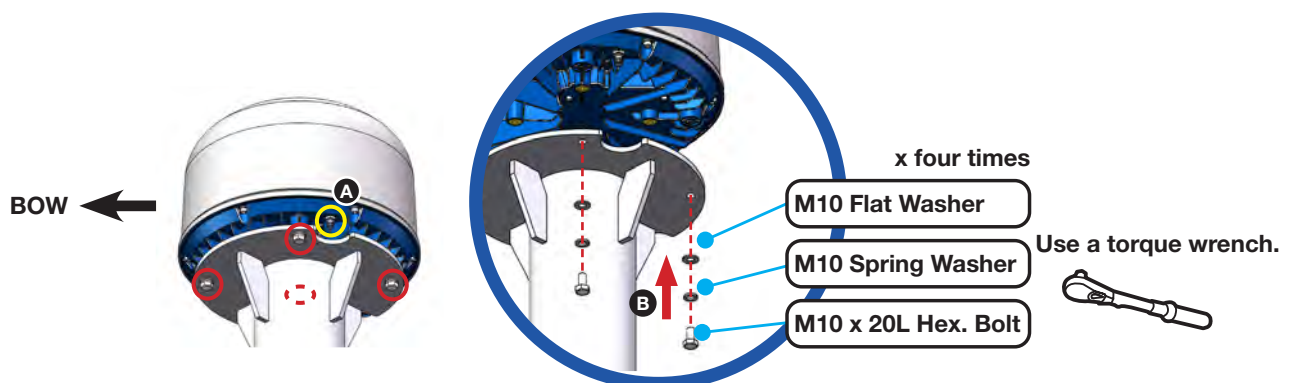

Figure 14: Mounting Antenna using Outer Holes (with M10 Bolts)

### 5.4.3 Mounting Antenna on Pole (Optional)

Intellian offers the Antenna Pole Mount Kit (separate purchase) to mount the antenna on the pole. The kit is designed to work on 40A pole. The kit has mounting holes that match the inner hole with M6 bolts on the bottom of the antenna.

Name (A)	Diameter (inch)	External Diameter (mm)
40A	1½	48.6

- When mounting antenna on the 40A pole, the 40A pole bushing needs to be installed inside pole tube additionally. **A** The one hole of the pole tube must be aligned with the BOW direction. Place the 40A pole bushing inside pole tube, then tighten them on the top end of the 40A pole using bolts. Before assembling bolts, apply Loctite #263 to the bolt's threads to ensure the bolts are fastened firmly.  
\*The pole tube Inner Diameter is Ø52 mm.

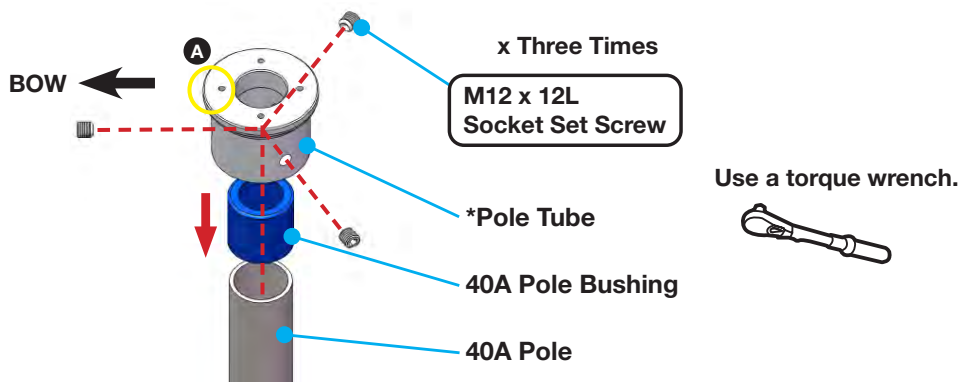

Figure 15: Installing 40A Pole Bushing inside Pole Tube

- A** The end of one leg of the pole bracket must be aligned with the BOW direction. Place the pole bracket onto the pole tube then tighten them using bolts. Before assembling bolts, apply Loctite #263 to the bolt's threads to ensure the bolts are fastened firmly.

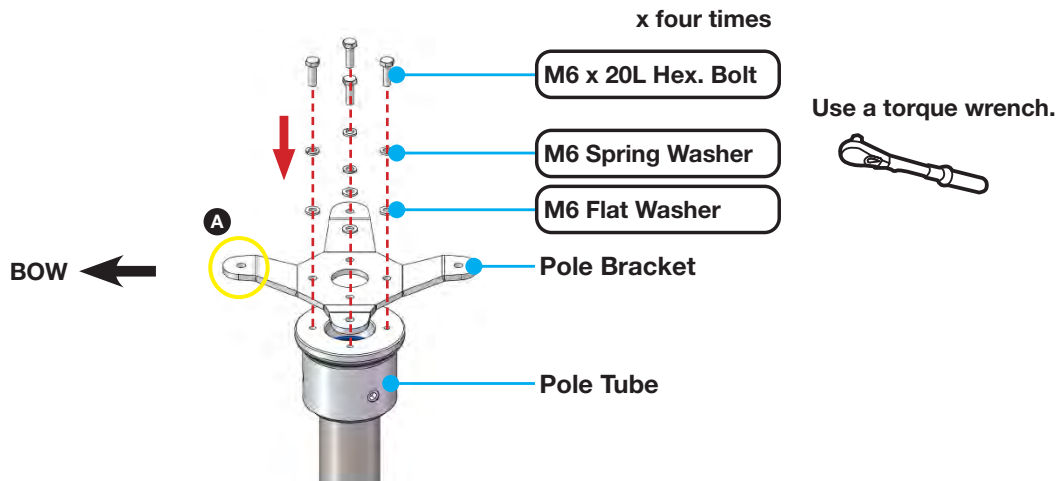

Figure 16: Installing Pole Bracket



- Place the antenna on the pole mounted bracket then tighten them using bolts. Before assembling bolts, apply Loctite #263 to the bolt's threads to ensure the bolts are fastened firmly.

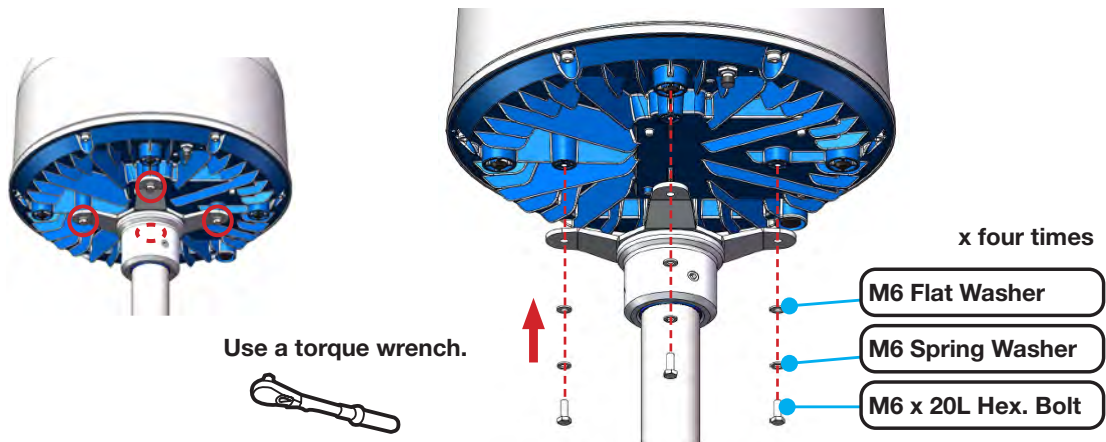

Figure 17: Mounting Antenna on Pole Mounted Bracket

## 5.5 Vent Hole

In some weather conditions, there may occur condensation and moisture inside the ADU. The vent hole is designed to allow easy air exchange and thus ensures that the enclosed area remains dry, and prevent water condensation. There is no need to open the vent hole assembled at the factory.

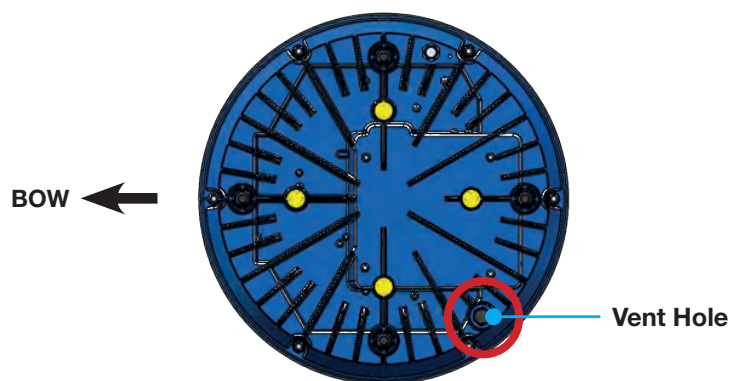

Figure 18: Vent Hole

## 5.6 Connecting RF Cable to Antenna

The cable must be routed from the antenna and through various areas of the ship to end up at the Below Deck Unit. When pulling the cables in place, avoid sharp bends, kinking, and excessive force. After placement, seal the deck penetration gland and tie the cable securely in place. The cable bracket must be installed on the mast to fix the relevant cable. The gooseneck must be installed on the side of the mast to protect the relevant cable against water. The supplied RF cable connector has the rubber grommet to protect inside the ADU from any water.

1. The RF cable is connected to the **Antenna** port of the BDU. Route the RF cable from the gooseneck placed on the deck to the antenna.
2. Maintain a cable length at least 2 m considering service loops when routing the cable on the mast. Connect the RF cable to the cable connector on the radome bottom, adjust the length, and fix the cable position along the routing path using cable ties on the cable brackets. Since the cable connector at the radome bottom is waterproofed at the factory, there is no need to work waterproofing.

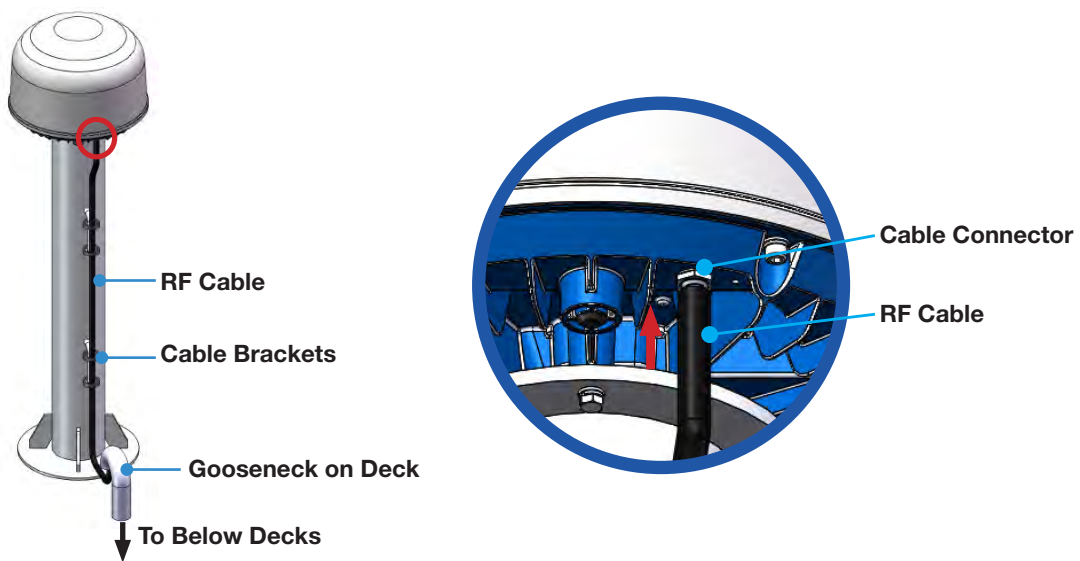

Figure 19: Connecting RF Cable using Inner Holes (with M6 Bolts)

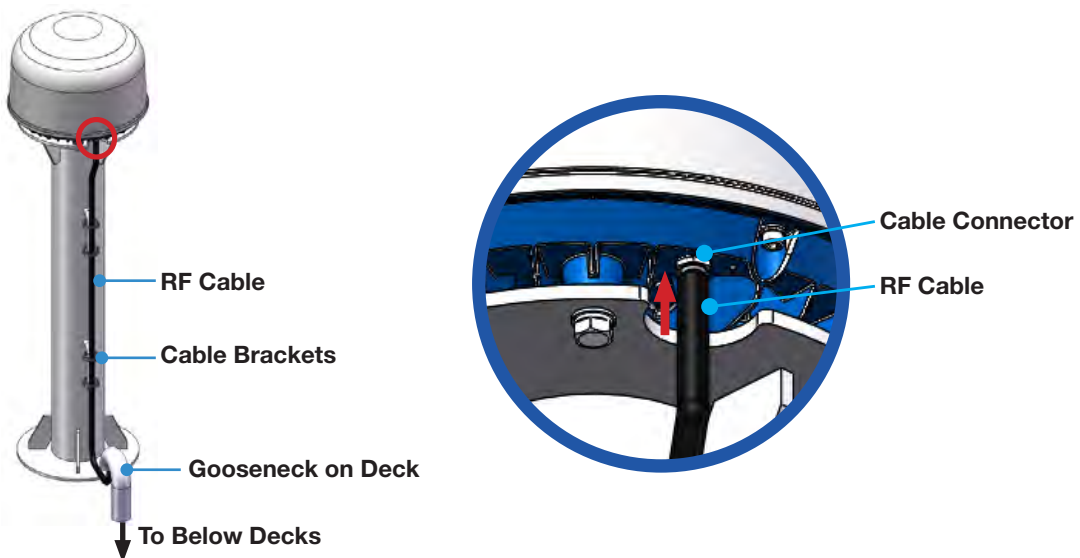

Figure 20: Connecting RF Cable using Outer Holes (with M10 Bolts)

## Chapter 6. Installing BDU

The Intellian offers two versions of BDU installation, one can be installed to the surface of the wall or desktop, and one can be installed to the 19-inch rack frame using the BDU Rack Mount Kit (separate purchase).

### 6.1 BDU Dimensions

Confirm the dimension of the BDU before installing it.

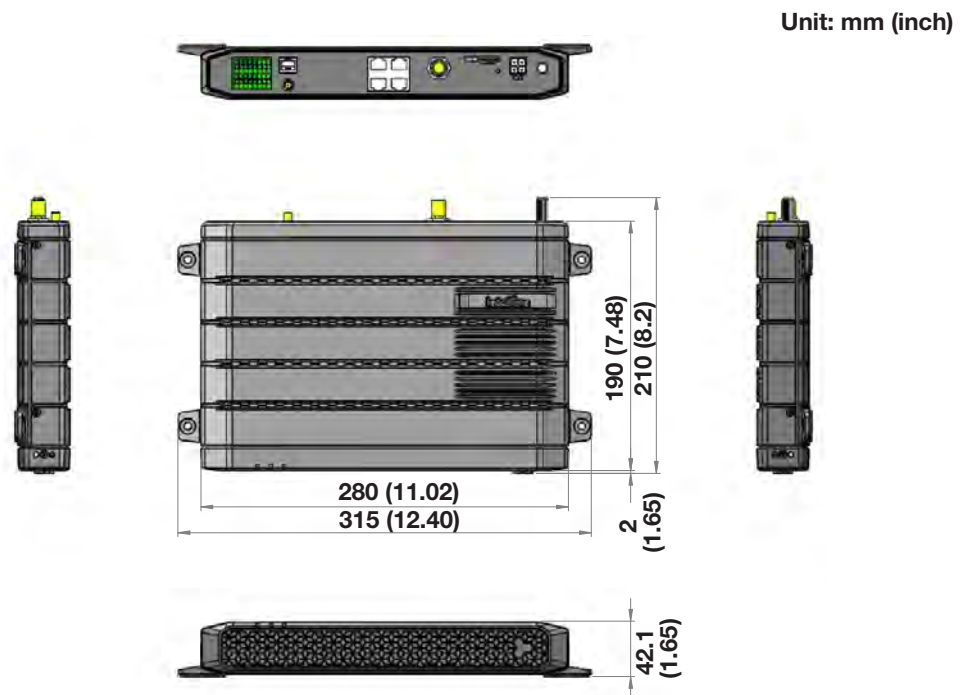

Figure 21: BDU Dimensions (Direct Mounting Type)

Unit: mm (inch)

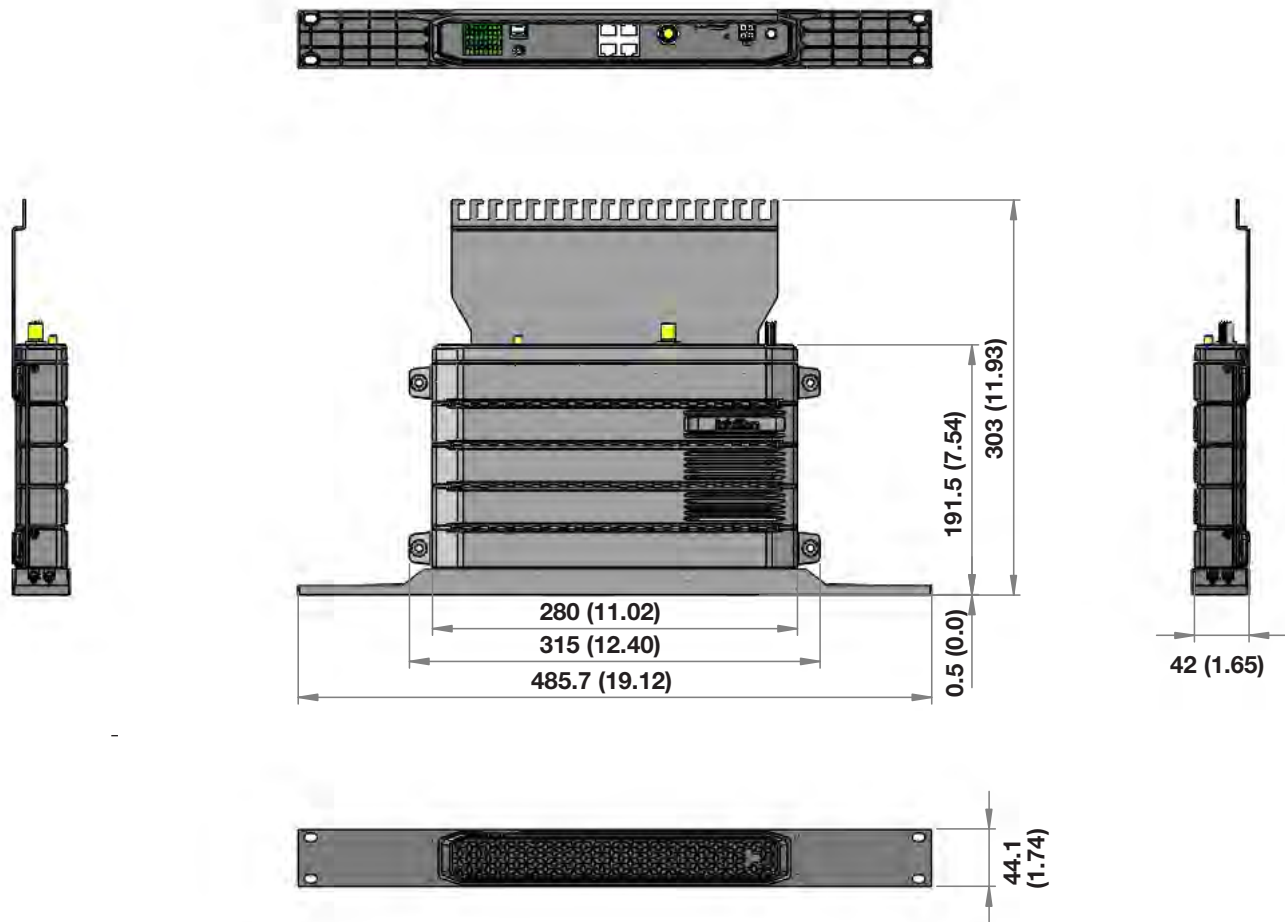

Figure 22: BDU Dimensions (19-inch Rack Mounting Type\_Optional)

## 6.2 Selecting BDU Installation Site

The BDU should be installed below the deck in a location that is dry, cool, and ventilated. The front panel of BDU should be easily accessible to users.

## 6.3 BDU Mounting Template

The BDU mounting holes must be in the exact same place as shown in the provided mounting template below.

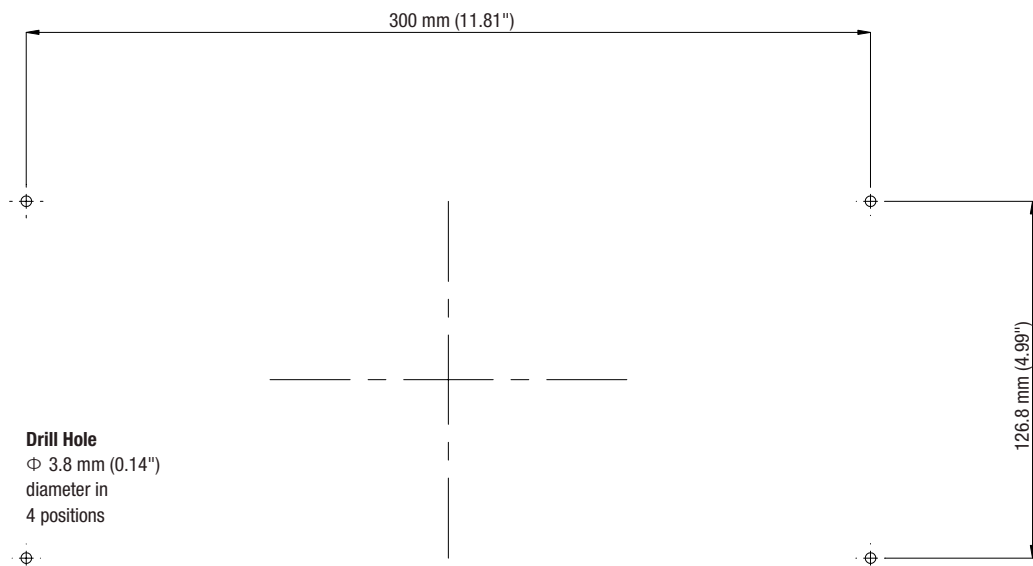

Figure 23: BDU Mounting Template

## 6.4 Mounting BDU

The BDU can be mounted in any orientation but for best performance, Intellian recommends that it is mounted horizontally.



### WARNING

Ensure that the cables connected to the BDU are long enough to prevent damage when the BDU is pulled out from the rack.

### 6.4.1 Direct Mounting Type

The BDU is designed with four corner mounting holes to makes direct mounting on the wall or desktop easy.

1. Mount the BDU on the mounting surface by inserting four screws through the mounting holes.

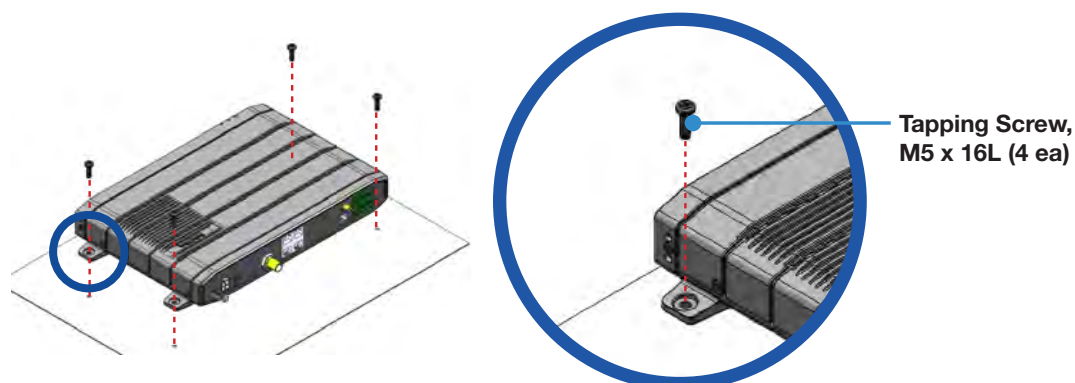

Figure 24: Direct Mounting of BDU

### 6.4.2 19-inch Rack Mounting Type (Optional)

Intellian offers the BDU Rack Mount Kit (separate purchase) including the rackmount plate and connector tray to mount the BDU in a 19" rack.

1. Using the Screws supplied, attach the connector tray to the BDU.

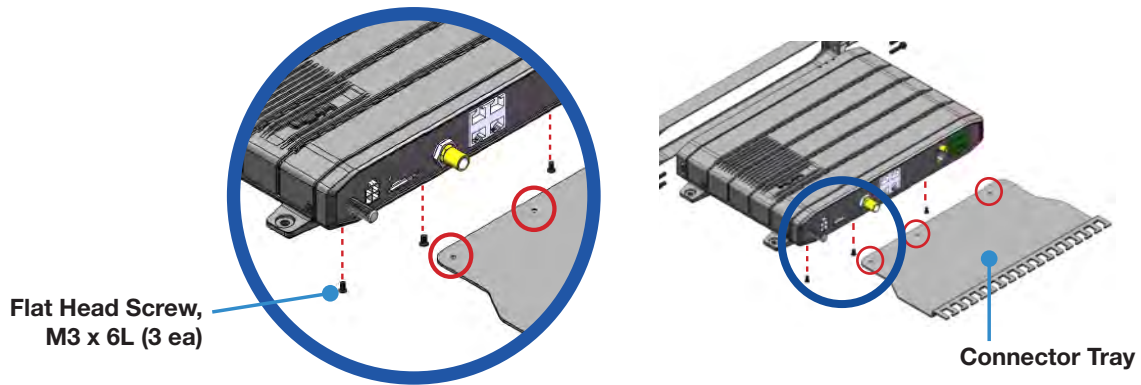

Figure 25: Attach Connector Tray to BDU

2. Using the Screws supplied, attach the rackmount plate to the BDU.

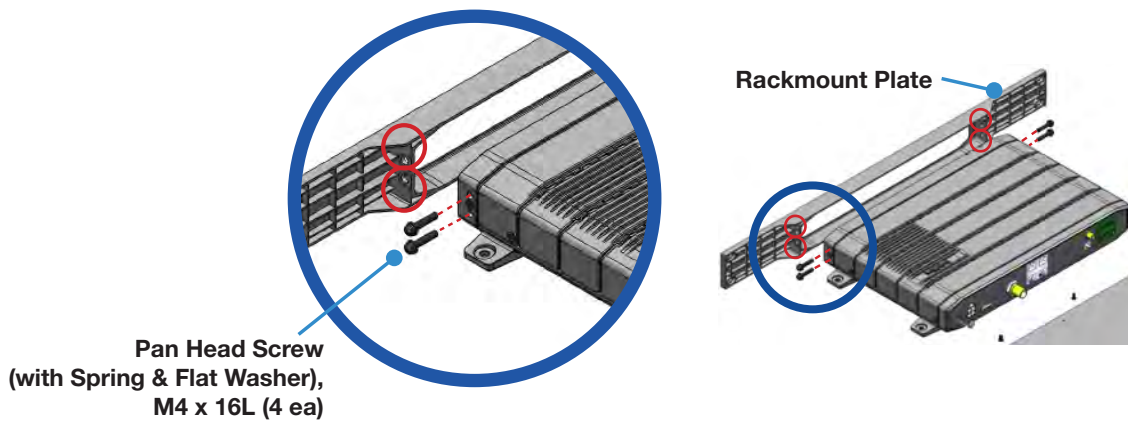
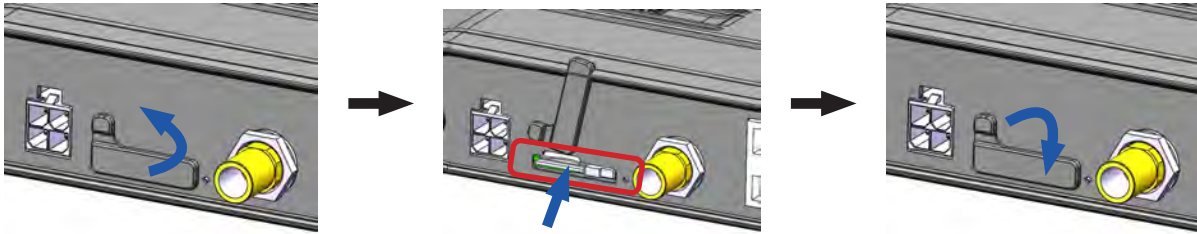

Figure 26: Attach Rackmount Plate to BDU

## 6.5 Setting up SIM Card

### 6.5.1 Inserting SIM Card

The system requires a SIM card from the service provider to use the terminal and configure the settings of the BDU.



1. Pull the SIM Card protective cover away from the BDU and expose the SIM card slot.
2. Install the SIM card by pushing it in the slot until it clicks into place. The contact surface of the SIM card faces down.
3. After the SIM Card has been locked into place, secure the SIM Card cover.

## 6.6 Antenna System Configuration

For your satellite communication system to work properly, refer to the figure as the following.

### 6.6.1 Antenna System Configuration

The basic system consists of one antenna and one BDU. A typical user setup that includes the standard kit items as well as a POTS phone, SIP phones, and a computer is shown in Figure. A modem can be connected to the WAN port for data least-cost routing operations. Voice calls are always routed through the Iridium system unless using a data call application.

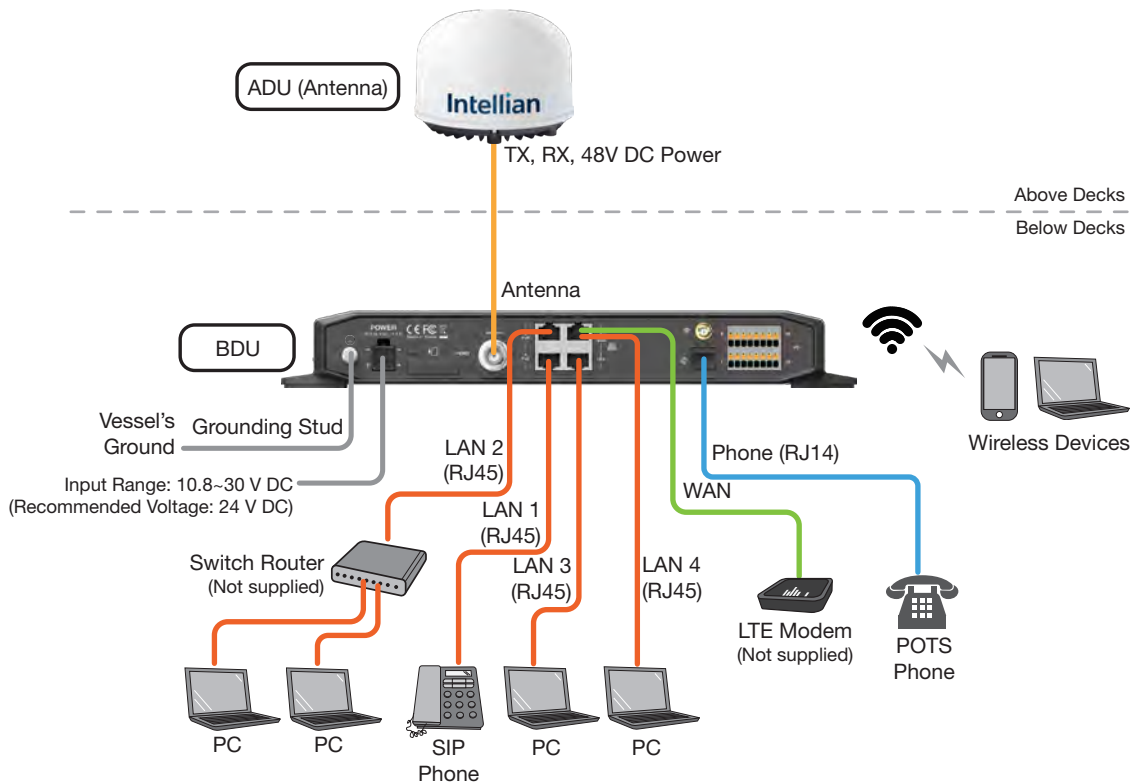

Figure 27: Intellian C700 System with Connected Devices

### 6.6.2 Data sessions and voice calls

The System provides up to High quality voice calls, multiple data sessions, Wi-Fi, and supports up to 18 extensions (including 2 analog phones and 16 sip phones).

The BDU communicates directly with SIP phones on any of the three LAN user ports (LAN 1, 2, 3, or 4). The SIP phones register directly to the SIP server in the BDU.

#### Supported VoIP Phones

- Grandstream GXP16 Series: 1610, 1615, 1620, 1625, 1628, 1630
- Grandstream GXP17 Series: 1760, 1780
- Grandstream GXP21 Series: 2120, 2130, 2135, 2140, 2160, 2170
- Grandstream GXV32 Series: 3240, 3275



## 6.7 BDU Cable Connection

### 6.7.1 BDU Back Panel View

The following figure shows the BDU back panel.

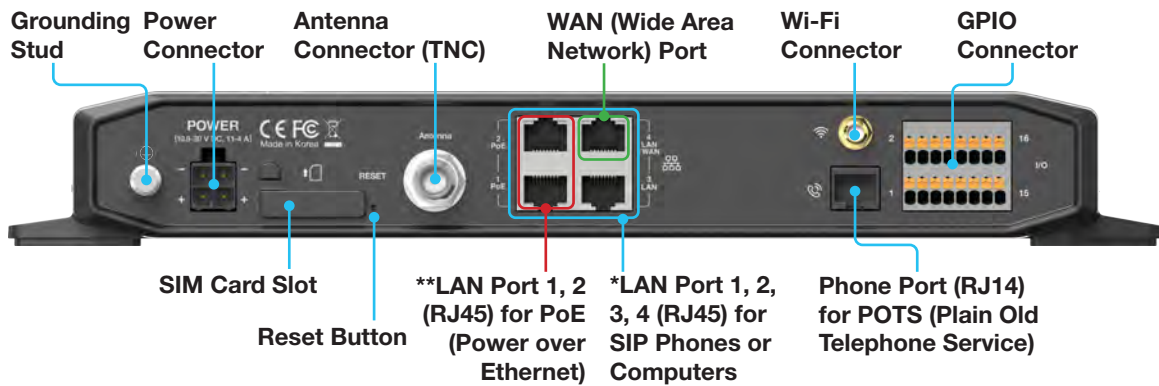

\* All LAN ports are IEEE 802.3 compliant.

\*\* Each PoE Port is designed to use 7.5W power. When using over 12.5W in one port, the PoE function will be stopped in port 1 or port 2.

Figure 28: BDU Back Panel View

## 6.8 BDU Connector Pinout Guide

The BDU connector pins and their corresponding descriptions are shown in the following figures and tables

### 6.8.1 LAN Ports (RJ45)

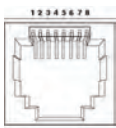

RJ45 Connector

Pin	Signal
1	TD+
2	TD-
3	RD+
4	NC
5	NC
6	RD-
7	NC
8	NC

\* Cable Length: 1.5 meter (59.05 inches)

Figure 29: LAN Ports (RJ45) Pinout

### 6.8.2 Phone Port (RJ14 & 6P4C)



RJ14 & 6P4C (6-Positions 4-Contacts)

Pin	Signal
1	N/A
2	T2+ (POTS Phone 2, no. 102)
3	R1- (POTS Phone 1, no. 101)
4	T1+ (POTS Phone 1, no. 101)
5	R2- (POTS Phone 2, no. 102)
6	N/A

\* Cable Length: 1.5 meter (59.05 inches)

Figure 30: Phone Port (RJ14 & 6P4C) Pinout

When connecting RJ14 phones, it is recommended to use a separate cable splitter (not supplied by Intellian). The POTS phone 1 (no. 101) is connected to a pair of Pin 3 (R1-) and Pin 4 (T1+) wires. The POTS phone 2 (no. 102) is connected to a pair of Pin 5 (R2-) and Pin 2 (T2+) wires.

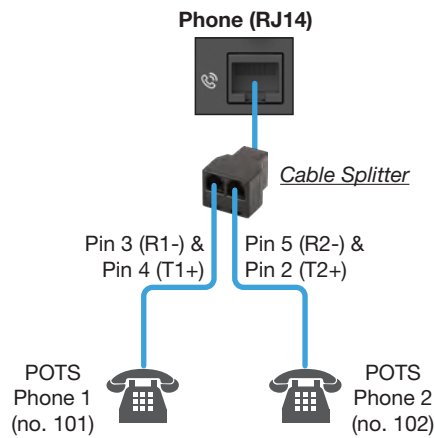
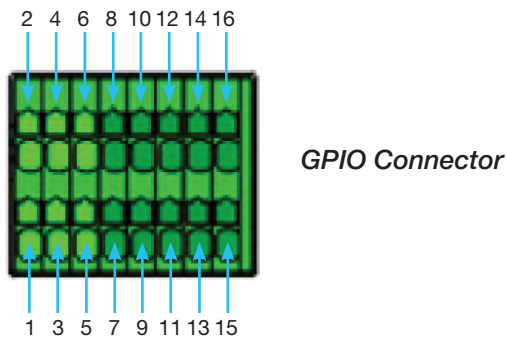

Figure 31: Using Cable Splitter with RJ14 Phones

### 6.8.3 General Purpose Inputs/Outputs (GPIO) Connector

All wires for the GPIO connector must use AWG 24 unscreened wire type.



Pin	Signal	Pin	Signal
1	External Power Input	2	External Power Return
3	Input 1	4	
5	Input 2	6	
7	Reserved	8	
9	Output 1	10	
11	Output 2	12	
12	Output 3	14	
15	Remote Power On/Off	16	

Figure 32: GPIO Connector Pinout

### 6.8.4 Power Connector (DC Power)

DC Operation for vessels operating from battery power (default): Intellian provides the DC power cable (1 m) and wire connector for connecting DC power from a battery to the BDU directly (Input Range: 10.8~30 V DC). The power cable is supplied with the Molex connector (part number: 1716920204) and has the maximum wire gauge of 12 AWG. The wire connector is used for DC power cable extension. Intellian recommends using 1~2 m (3.28~6.56 ft) length power cable to prevent DC voltage drop. If you need a power cable longer than 2 m (6.56 ft), refer to the table as the following.

Cable length	Maximum Wire Size
5 m (16.40 ft)	AWG 16
10 m (32.80 ft)	AWG 14
20 m (65.61 ft)	AWG 12

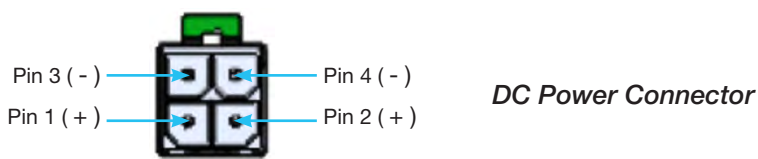

Pin	Signal
1	+
2	+
3	-
4	-

Figure 33: Power Connector Pinout

### 6.8.5 Connecting BDU to ADU (Antenna)

Connect the **RF Cable** from the **ANTENNA** connector on the back of the BDU to the **RF Connector** on the radome bottom (Antenna).

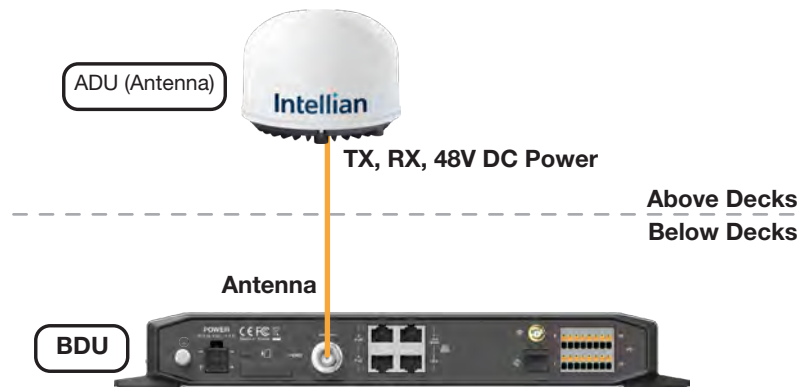

Figure 34: BDU to Antenna Cable Connection

## 6.9 Grounding Stud

The BDU should be grounded. Use a heavy ground cable (Not supplied) to connect the BDU to the vessel's ground during normal use. A safety grounding system is necessary to protect your radio hardware from lightning strikes and the build-up of static electricity. The grounding system must comply with the safety standards that apply in your country.

Ground the BDU using a heavy ground cable (not included) from the **Grounding Stud** of the BDU back panel to the vessel's ground to protect the system from unwanted surges and voltage differentials.



Figure 35: Grounding Stud Connection

# Chapter 7. Operating BDU

The BDU and ADU are connected through single coaxial cable through which power from BDU is delivered to ADU and Ethernet data is exchanged between the BDU and ADU. The BDU controller is responsible for all the terminal management, system monitoring, control, error detection, and maintenance operations.

## 7.1 BDU Front Panel

The following figure shows the BDU's front panel.



Figure 36: BDU Front Panel

The following table shows status indicators on the face of BDU.

LED Indicator	Color	Description
Power	Off	The BDU is powered off.
	Blinking	The BDU is booting a system. The BDU is calibrating a system. The system is in error. There is no SIM card inside BDU.
	Steady Green	The BDU is powered on.
Satellite	Off	The antenna is not connected to a satellite.
	Blinking	The antenna is acquiring a satellite. The antenna is searching for a satellite.
	Steady Green	The antenna is connected to a satellite.
Event	Off	The antenna has no event (call or data).
	Blinking	The antenna has an alert, an unread message, an incoming call.
	Steady Green	The antenna has a voice or data.

**NOTE:** When 3 LEDs blink simultaneously, the BDU is in a low power state. Check the current input voltage status.

## 7.2 Powering On System

Use the power ON/OFF button on the BDU's front panel. Wait for all LED indicators to turn green to indicate the system is completely powered up.

## 7.3 Making POTS Phone Call

To make POTS phone calls, do as follows:

1. Connect an ethernet cable from the Phone Port (RJ14) on the back of the BDU to the POTS phone.

**NOTE**

When connecting a cable to Phone Port (RJ14), refer to the following; The analog phone 1 (no. 101) is connected to a pair of Pin 3 (R1-) and Pin 4 (T1+) wires. The analog phone 2 (no. 102) is connected to a pair of Pin 5 (R2-) and Pin 2 (T2+) wires.

2. Lift the POTS phone and listen for a dial tone.
3. Call a known number to test call and voice clarity Dial Country code, area code, and phone number #.

## 7.4 Using PoE Devices

### 7.4.1 Accessing Internet

To use PoE Devices and Wireless Devices, you need to access the Internet. The network is automatically configured by DHCP without the need for additional PC IP configuration.

1. Connect an Ethernet cable from the **LAN Port 1** or **LAN Port 2** on the back of the BDU to devices. The network connection is established automatically.
2. Use the following IP address to access the Intellian AptusLX Web page.
  - **IP Address: 192.168.200.1 (Default)**
3. Log into the AptusLX Web by typing in a user name and password information. If this system has not been changed from the factory default:
  - **User Name: intellian**
  - **Password: 12345678**
4. Select the **SETTING** on the main menu then go to the **Network → Port** menu.
5. Toggle PoE button to the ON position on the port 1 or port 2. If you don't want to use PoE Connection, choose the OFF position.
6. Select the **LAN** from the **Port Type** drop-down list.
7. Click the **Apply** button to apply the settings to the system.

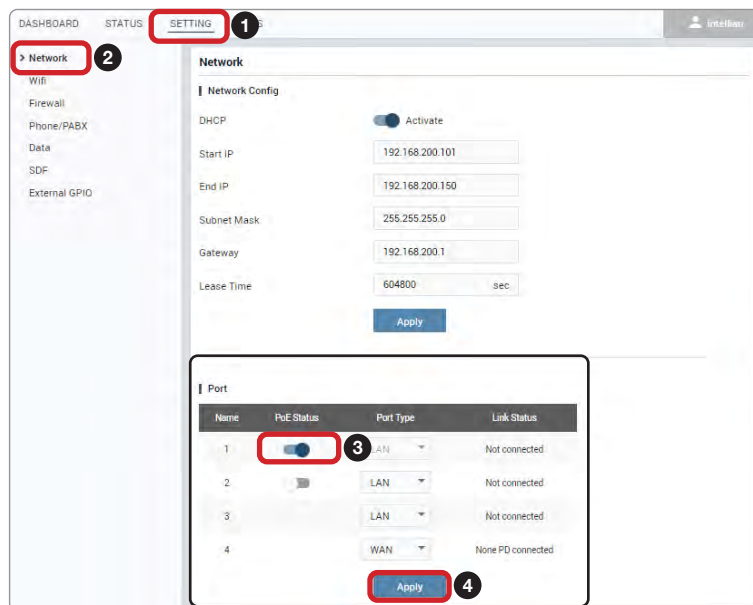

## 7.5 Using Wireless Devices

### 7.5.1 Installing Mobile Application

To be able to use a mobile phone you must install a compatible mobile application. Intellian recommends using the following mobile application:

#### Grandstream Wave App

- **App Store:** <https://itunes.apple.com/us/app/grandstream-wave/id1029274043?ls=1&mt=8>
- **Google Play:** <https://play.google.com/store/apps/details?id=com.grandstream.wave>



## 7.5.2 Setting up Wi-Fi

You can connect to the BDU via Wi-Fi for easy management and control whenever you are on the vessel.

1. Bring the Wi-Fi Antenna located in the BDU package. Plug the Wi-Fi Antenna into the USB port on the back of the BDU.
2. Connect an Ethernet cable from the **LAN Port 1**, **LAN Port 2**, **LAN Port 3**, or **LAN Port 4** on the back of the BDU to the LAN port of PC. The network connection is established automatically.
3. Use the following IP address to access the Intellian AptusLX Web page.
  - **IP Address: 192.168.200.1 (Default)**
4. Log into the AptusLX Web by typing in a user name and password information. If this system has not been changed from the factory default:
  - **User Name: intellian**
  - **Password: 12345678**
5. Select the **SETTING** on the main menu then go to the **Wifi → Wifi Config** menu.
6. Toggle Activation button to the **Enable** position on the **Activate**. If you don't want to use Wi-Fi Connection, choose the **Disable** position.
7. Check the **SSID (Wi-Fi AP Name)** information.
8. Choose the SSID Broadcast **Enable** button to show the SSID (Wi-Fi AP Name) on the Wi-Fi list.
9. Click the **SECRET** button on the **Mode** menu.
10. Set a Wi-Fi password on the **Passphres** menu.
11. Click the **Apply** button to apply the settings to the system.
12. Connect to the Wi-Fi you set.

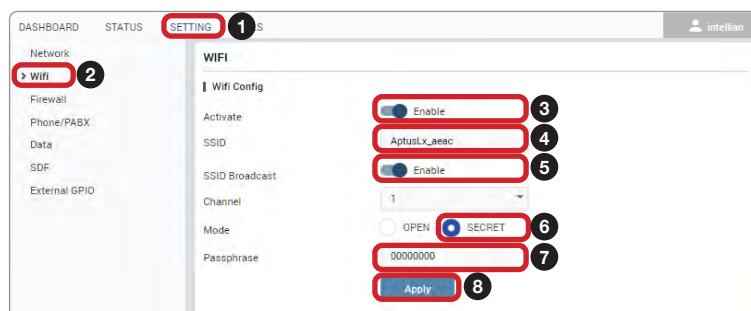

## 7.5.3 Setting up New Extension (Optional)

If voice services are required, set up the new extension of the terminal.

1. Select the **SETTING** on the main menu then go to the **Phone/PBX** menu.
2. To add a new extension, click the **Add** button (plus symbol).

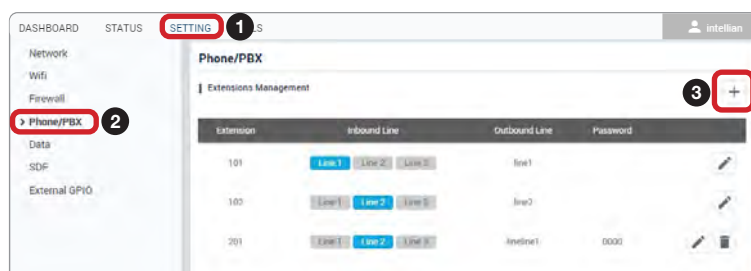

- The registration window will appear in the pop-up window. Enter the new extension information. When you want to use the external call, select the **Inbound Line** and **Outbound Line** after checking the **Active** line on the **SIM** menu of the **STATUS** menu. Click the **Update** button.

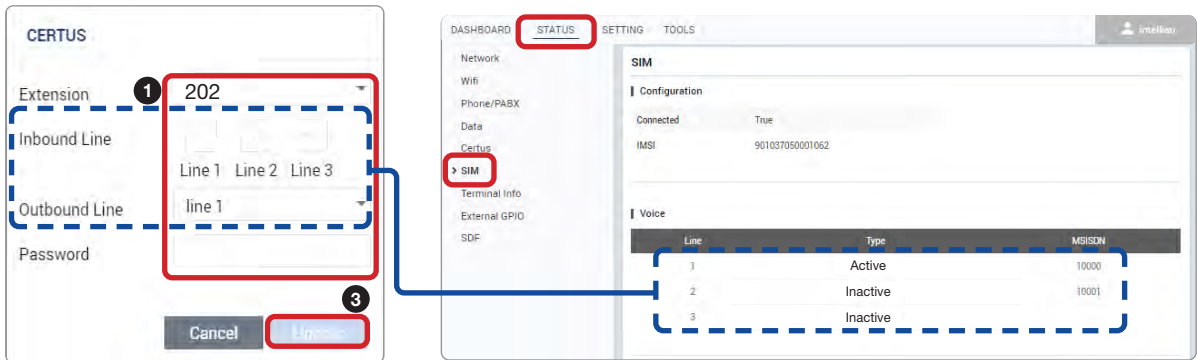

- Check the new extension added.

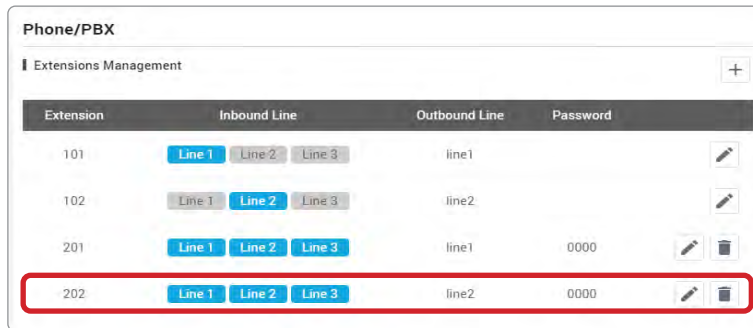

### 7.5.4 Making Wireless Device Call

#### Using Grandstream Wave App (Recommended) through Mobile Phone

To make a call on your mobile phone, Intellian recommends using the Grandstream Wave app. Follow steps below to set up your mobile phone.

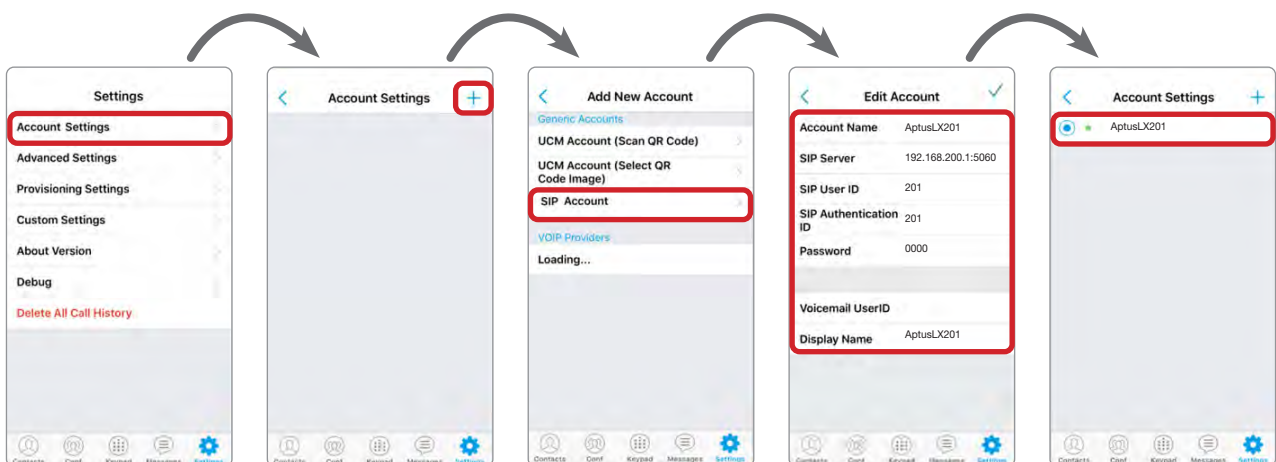

# Chapter 8. Using AptusLX

## 8.1 Introduction

With the embedded **AptusLX** software, the antenna can be monitored, controlled, and diagnosed remotely, anytime through the TCP/IP protocol. It saves your time and cost generated by various maintenance activities such as operating firmware upgrades, tracking parameter resets, and system diagnosis, etc.

### 8.1.1 How to Access Internal Webpage of BDU



The network is automatically configured by DHCP with no additional PC IP configuration.

1. Connect an Ethernet cable from the **LAN Port 1**, **LAN Port 2**, **LAN Port 3**, or **LAN Port 4** on the back of the BDU to the LAN port of PC. The network connection is established automatically.
2. Enter the BDU IP address (**Default: 192.168.200.1**) or (**https://portal.aptuslx.local**) into the address bar of the web browser to login into the internal HTML page of BDU.

#### NOTE

AptusLX works on Internet Explorer 11 or higher (Windows 7 or higher editions), Firefox, Microsoft Edge and Chrome web browsers.

If you're having trouble connecting your Chrome web browser to the internet, try the steps below.

1. On your computer, open Chrome.
2. Delete your Chrome browsing history;
  - 2-1. At the top right, click More .
  - 2-2. Click History > History.
  - 2-3. On the left, click Clear browsing data. A box will appear.
  - 2-4. From the drop-down menu, to clear everything, select All time.
  - 2-5. Check the boxes for the info you want Chrome to clear, including "browsing history."
  - 2-6. Click Clear data.
3. Clear all cookies;
  - 3-1. At the top right, click More  > Settings.
  - 3-2. Under "Privacy and security," click Cookies and other site data.
  - 3-3. Click See all cookies and site data > Remove all.
  - 3-4. Confirm by clicking Clear all.



## 8.2 Main Page

### 8.2.1 Page Login

The Intellian software Aptus provides different user access levels to protect the system for safe operation. Depending on the user level, the accessible range of functions in the software can be limited.

1. Log into the ACU by typing in User Name and Password information. If this system has not been changed from the factory default:

User ID	Password	Access Authority
<i>intellian</i>	<i>12345678</i>	Supports all menus for monitoring and setting.
<i>guest</i>	<i>guest</i>	Only some menus for monitoring are supported.

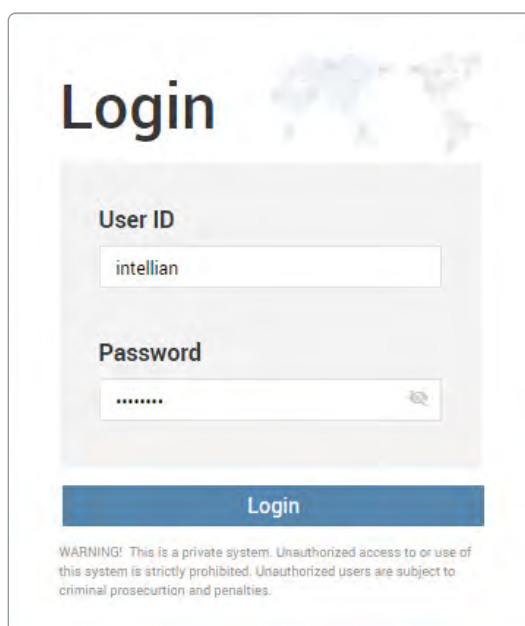

#### NOTE

After entering the default password, the user must change the default password to a new password for security. If you have forgotten your ID and/or password, you can reset it on the Reset ID/Password menu. Refer to the "User" on page 46.

## 8.3 Top Menus

Once you log in, the following information and menus are displayed. The overall state of the system is always displayed in the system status field.



No.	Item	Description
①	Satellite Status	<p>Displays the status of the satellite network connection.</p> <ul style="list-style-type: none"> <li>Off: The system is not detected in the satellite network.</li> <li>Steady Green: The system is detected in the satellite network. Ready to connect.</li> <li>Blinking Green (Acquiring): The system is connecting to the satellite network.</li> <li>Steady Blue: The system is registered and connected to the satellite network.</li> <li>Steady Red: Registration on the network was denied. If the SIM card is inserted incorrectly, insert the SIM card in place. Refer to the "6.5.1 Inserting SIM Card" on page 31. If there is no error with the SIM card status, contact the service provider.</li> </ul>
②	WAN Status	<p>Displays the status of the wide-area network (WAN) connection. The system connects to the WAN according to the setting of the routing policy. You can also check the status of the WAN connection on the 'Current Route Selection' panel of the "8.5 Dashboard" on page 47.</p> <ul style="list-style-type: none"> <li>Steady Blue: The WAN is connected.</li> <li>Red/Off: The WAN is not connected.</li> </ul>
③	Wi-Fi Status	<p>Displays the status of the Wi-Fi connection.</p> <ul style="list-style-type: none"> <li>Off: The Wi-Fi connection is disabled.</li> <li>Steady Green: The Wi-Fi connection is enabled. Ready to connect.</li> <li>Steady Blue: The Wi-Fi is connected.</li> </ul>
④	Signal Strength	<p>Displays the current signal level.</p> <ul style="list-style-type: none"> <li>Off: The network is disabled.</li> <li>Steady Green: The network is enabled. Displays the current signal level.</li> </ul>
⑤	System Power	<p>Displays the current system power.</p> <ul style="list-style-type: none"> <li>Steady Blue: The system is in normal operation.</li> <li>Steady Red: A error is detected.</li> </ul>
⑥	Call	<p>Displays the status of the call connection.</p> <ul style="list-style-type: none"> <li>Steady Green: The extension call is available.</li> <li>Steady Blue: The extension and external call is available.</li> <li>Blinking Blue: The external call is active.</li> </ul>
⑦	Main Menu	<p>Select the Main Menu. Each main menu offers side menus on the left of the screen.</p>
⑧	Account Button	<p>Select the <b>Intellian</b> button to manage your account details and select the <b>Logout</b> menu to log out of the AptusLX web page.</p>

## 8.4 Account Menu

Click the **Intellian** button to manage the user account.

The **User** and **Info** menus are for user management. Click the **Logout** button to log- out of the AptusLX web page.



### 8.4.1 User

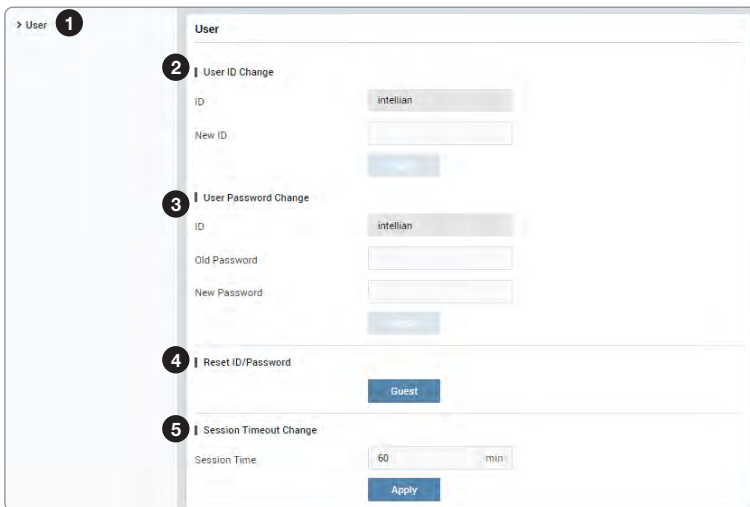

No.	Item	Description
①	User	Updates your password and ID.
②	User ID Change	You can change your password. <ul style="list-style-type: none"> <li>• ID: Displays the user current ID.</li> <li>• New ID: Enter the new ID you want to change.</li> </ul> Click the <b>Apply</b> button to set the ID to the new ID.
③	User Password Change	You can change your password. <ul style="list-style-type: none"> <li>• ID: Displays the user current ID.</li> <li>• Old Password: Enter the current password.</li> <li>• New Password: Enter the new password.</li> </ul> Click the <b>Apply</b> button to set the password to the new password. For the next login, the new password is required.
④	Reset ID/ Password	If you have forgotten your ID and/or password, you can reset depending on your account level. The <b>intellian</b> account allows you to reset the <b>guest</b> account. Click the account button to reset to the default id and password. For the next login, the default id and password are required.
⑤	Session Timeout Change	Enter the session timeout (min.). Click the <b>Apply</b> button to apply the settings to the system.

## 8.5 Dashboard

The Dashboard menu is displayed as below to provide quick monitoring of the antenna status. The Dashboard helps you arrange panels on a single screen while providing you with a broad view of a variety of information at once.

The screenshot displays the AptusLX Dashboard interface. At the top, there is a navigation bar with 'DASHBOARD' highlighted in a red box, followed by 'STATUS', 'SETTING', and 'TOOLS'. A user profile icon labeled 'ntel@lxi' is visible on the right. The dashboard is divided into several panels:

- Service:** Shows 'Network Detected' (Yes), 'Active Voice Call' (0), 'Network Type' (EBBS), 'Active Satellite Data Session' (0), 'Network Status' (Accessing), and 'Current Route Selection' (WAN). A 'NOTE' callout points to the 'WAN' selection.
- Tracking Satellite:** Displays 'SvId' (4), 'Beam ID' (1), 'Signal Strength' (-103 dBm), 'Modcod' (DEQPSK), 'UL bitrate' (0 bps), and 'DL bitrate' (0 bps).
- Terminal:** Shows 'Terminal Status' (Ok), 'Operation' (Normal), 'Mode' (Normal), 'SM Present' (True), 'SIM Connected' (Provisioned), 'ADU Status' (Ok), and 'Modem Status' (Ok).
- Traffic Statistics:** Includes 'Call Statistics' (Accumulated MO Voice Calls: 0, Accumulated MT Voice Calls: 0), 'Data Statistics' (Accumulated Data Flows: 0), and 'Traffic Octets' (Voice Tx: 0, Voice Rx: 0, Postpaid Tx: 0, Postpaid Rx: 0, Streaming Tx: 0, Streaming Rx: 0).
- Tracking Info:** Lists 'APV Rx A' (7), 'APV Rx B' (20), 'APV Tx A' (7), 'Rx Power' (-103 dBm), 'TX1 Power' (12.40 dBm), 'TX2 Power' (12.40 dBm), 'Element A' (7), and 'Element B' (8).
- Active Antenna:** A hexagonal grid of 12 elements, with element 7 highlighted in blue.
- Location:** Shows 'Valid' (False), 'Latitude' (0.0), 'Longitude' (0.0), 'Dop' (0), 'Date' (1970-01-01), and 'Time' (00:00:00 GMT+0).
- Product Information:** Displays 'Package S/W Version' (0.8.7), 'BDU Serial' (Unknown), 'BDU Mac' (88:3f:4a:ab:ae:ac), 'ADU S/W Version' (0.5.6), 'ADU Serial' (-), and 'Antenna Class' (H2).
- Modem Information:** Shows 'S/W Version' (2.4.2-12743), 'H/W Version' (Unknown), 'REV D' (Unknown), 'IMEI' (300008060503940), 'Serial' (Unknown), and 'W00037' (Unknown).
- Voice Mail:** Shows three indicators (1, 2, 3).



### NOTE

You can check the status of the WAN connection on the right of the top menu as well.

## 8.6 Status

This menu displays the Network, Wi-Fi, Phone/PBX, Data, Certus, SIM, Terminal Info, External GPIO, and SDF function.

### 8.6.1 Network

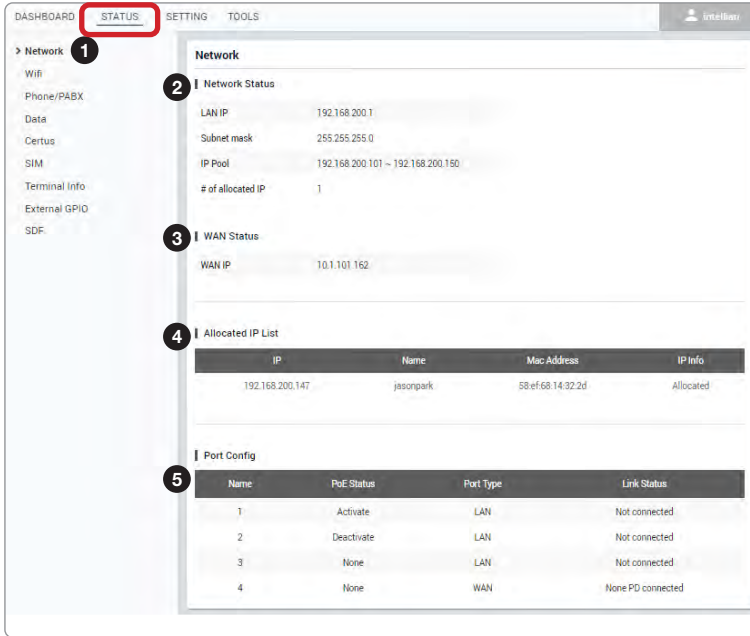

No.	Item	Description
①	Network	Displays the information about a network and ports.
②	Network Status	Displays the network information in use. <ul style="list-style-type: none"> <li>LAN IP: displays the network IP address (Factory default: 192.168.200.1).</li> <li>Subnet Mask: displays the subnet mask (Factory default: 255.255.255.0).</li> <li>IP Pool: displays the range of available IP.</li> <li># of allocated IP: displays the number of IP devices assigned.</li> </ul>
③	WAN Status	Displays the WAN information in use. <ul style="list-style-type: none"> <li>WAN IP: displays the WAN IP address.</li> </ul>
④	Allocated IP List	Displays the allocated IP list and information.
⑤	Port Config	Displays the switch port list (LAN or WAN port) and information.



## 8.6.2 Wi-Fi

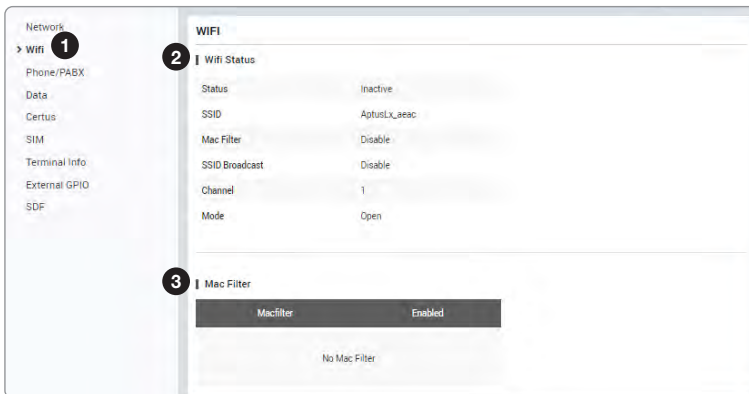

No.	Item	Description
①	Wi-Fi	Displays Wi-Fi access information.
②	Wi-Fi Status	Displays the Wi-Fi access point configuration. <ul style="list-style-type: none"> <li>• Status: displays the Wi-Fi status (Active / Inactive).</li> <li>• SSID: displays the SSID network name.</li> <li>• Mac Filter: displays the MAC address filtering status (Enable/Disable).</li> <li>• SSID Broadcast: displays the SSID broadcast status (Enable/Disable).</li> <li>• Channel: displays the WLAN (wireless local area network) channel in use.</li> <li>• Mode: displays the security mode (Open/Secret).</li> </ul>
③	Mac Filter List	Displays devices to either your whitelist or blacklist simply.

### 8.6.3 Phone/PBX

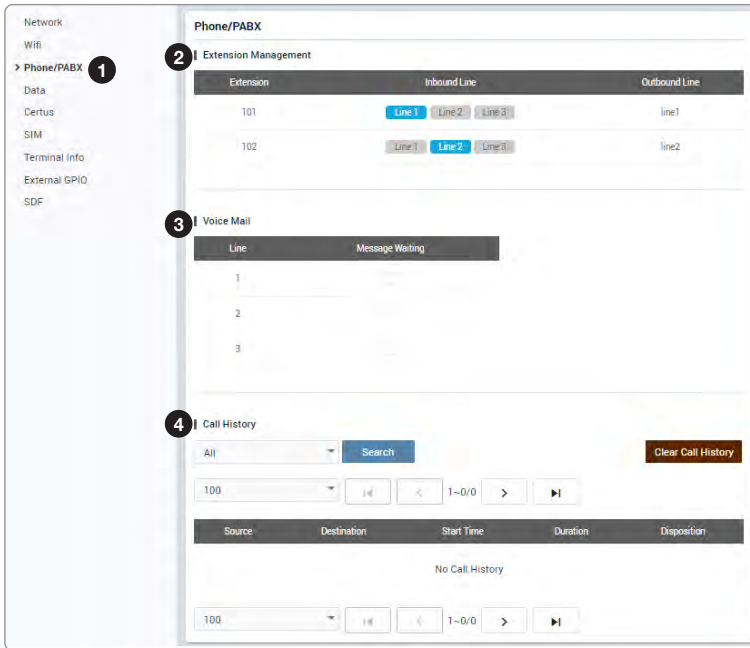

No.	Item	Description
①	Phone/PBX	Displays the phone and Private Branch Exchange (PBX) status.
②	Extension Management	Displays the extension number and details. <ul style="list-style-type: none"> <li>Extension: displays the registered extension.</li> <li>Inbound Line: displays the inbound line in use through the blue indicator.</li> <li>Outbound Line: displays the outbound line.</li> </ul>
③	Voice Mail	Displays the received new voice mail.
④	Call History	Displays the received call history. You can set view details from the drop-down list. Remove the history by clicking the <b>Clear Call History</b> button.

## 8.6.4 Data

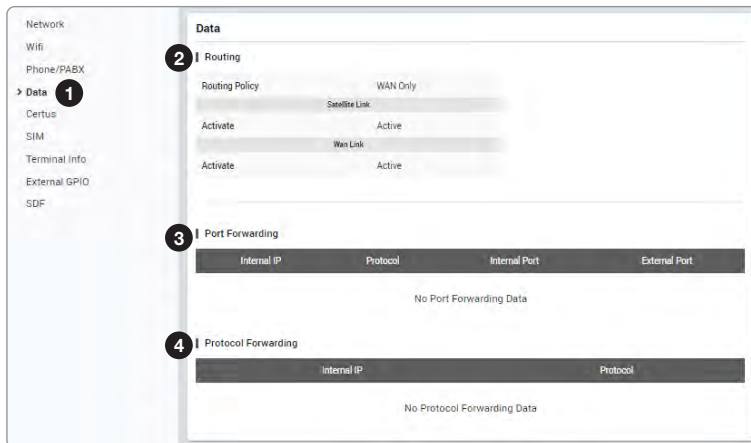

No.	Item	Description
①	Data	Displays the data setting status.
②	Routing	Displays the data route (None, Satellite Only, WAN Only, Satellite Preferred, WAN Preferred) in use.
③	Port Forwarding	Displays the port forwarding data information.
④	Protocol Forwarding	Displays the protocol forwarding data information.

## 8.6.5 Certus

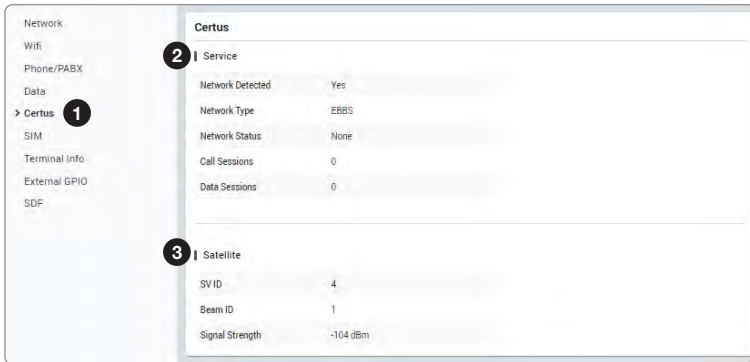

No.	Item	Description
①	Certus	Displays the modem state and the satellite information.
②	Service	Displays the modem status. <ul style="list-style-type: none"> <li>• Network Detected: displays the network connection status (Yes/No).</li> <li>• Network Type: displays the network type in use.</li> <li>• Network Status: displays the network connection status.</li> <li>• Call Sessions: displays the number of external devices in use.</li> <li>• Data Sessions: displays the number currently active data sessions.</li> </ul>
③	Satellite	Displays the satellite information. <ul style="list-style-type: none"> <li>• SV ID: displays the satellite number.</li> <li>• Beam ID: displays the satellite beam number.</li> <li>• Signal Strength: displays the signal strength.</li> </ul>

## 8.6.6 SIM

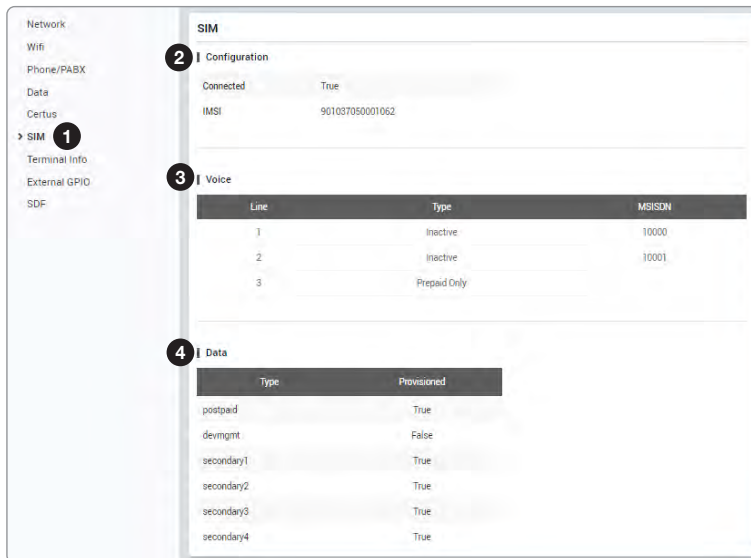

No.	Item	Description
①	SIM	Displays information about the SIM card, and the voice and data status.
②	Configuration	Displays the SIM card information in use. <ul style="list-style-type: none"> <li>Connected: displays connection status of the SIM card. The SIM must be inserted.</li> <li>IMSI: displays a unique identifier to the SIM card.</li> </ul>
③	Voice	Displays the active status of the voice.
④	Data	Displays the status of data communications.

## 8.6.7 Terminal info

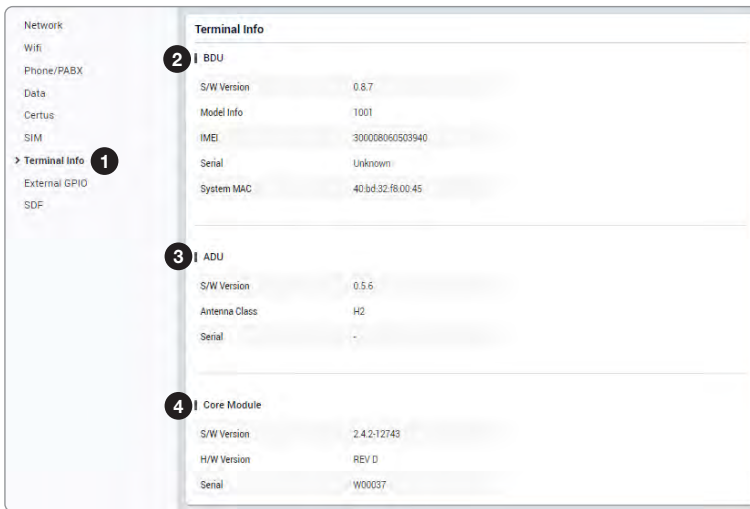

No.	Item	Description
①	Terminal info	Displays the system terminal information.
②	BDU	Displays BDU information in use.
③	ADU	Displays ADU information in use.
④	Core Module	Displays the core module information in use.

## 8.6.8 External GPIO

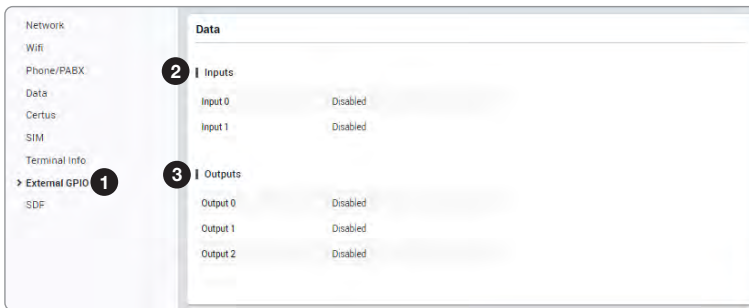

No.	Item	Description
①	External GPIO	Displays external GPIO.
②	Inputs	Displays input information in use.
③	Outputs	Displays output information in use.

## 8.6.9 SDF

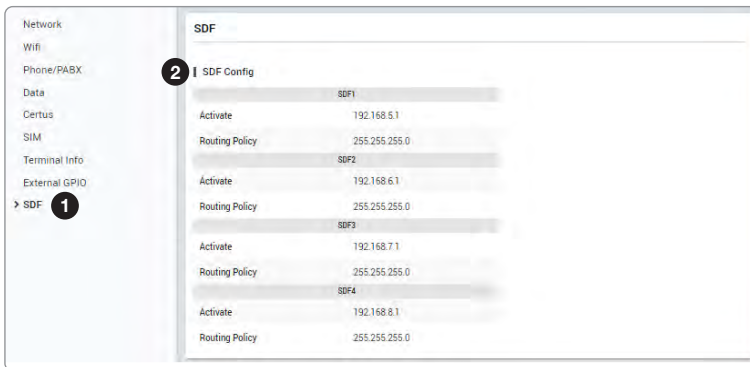

No.	Item	Description
①	SDF	This menu is for service providers. Displays Secondary Data Flow (SDF) information.
②	SDF Config	Displays the IP address assigned to the SDF.



## 8.7 Settings

This menu sets and displays the Network, Wi-Fi, Firewall, Phone/PBX, Data, SDF, and External GPIO function.

### 8.7.1 Network

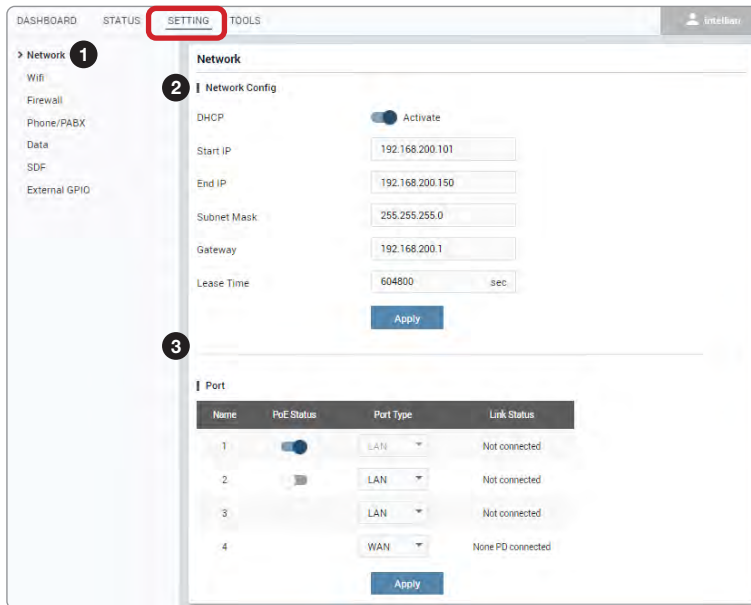

No.	Item	Description
①	Network	Sets the information about a network and ports.
②	Network Config	<p>Sets the network configuration.</p> <ul style="list-style-type: none"> <li>• DHCP: sets the DHCP function by toggling the activation button (Activate/ Inactivate).</li> <li>• Start IP: sets the start range of lease IP address.</li> <li>• End IP: sets the end range of lease IP address.</li> <li>• Subnet Mask: sets the subnet mask (Factory default: 255.255.255.0).</li> <li>• Gateway: sets the gateway IP address.</li> <li>• Lease Time: sets the lease time (sec).</li> </ul> <p>Click the <b>Apply</b> button to apply the settings to the system.</p>
③	Port	<p>Sets each switch port.</p> <ul style="list-style-type: none"> <li>• Name: displays the port name (port 1, 2, 3, and 4).</li> <li>• PoE Status: sets the PoE function by toggling the activation button on port 1 and 2.</li> <li>• Port Type: the port 1 is fixed for LAN. The port 4 can be selected as LAN, SDF, or WAN from the drop-down list. Port 2 and 3 can be selected as LAN or SDF from the drop-down list.</li> <li>• Link Status: displays the link status (Up/Down).</li> </ul> <p>Click the <b>Apply</b> button to apply the settings to the system.</p>

### 8.7.2 Wi-Fi

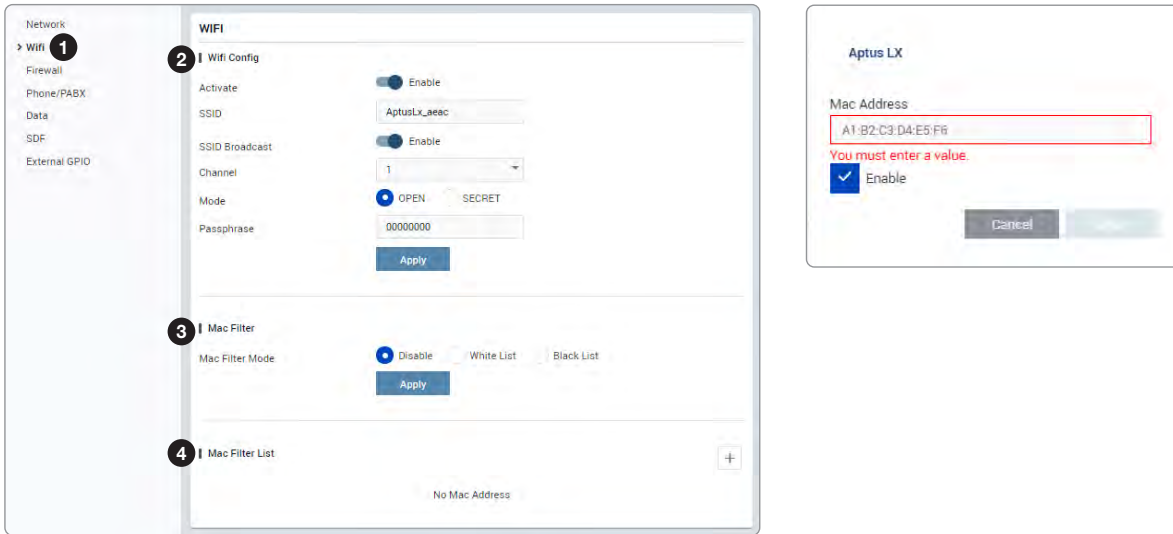

No.	Item	Description
①	Wi-Fi	Sets the Wi-Fi access information.
②	Wi-Fi Config	<p>Sets the Wi-Fi access point configuration.</p> <ul style="list-style-type: none"> <li>• <b>Activate:</b> sets the Wi-Fi function by toggling the activation button (Enable/Disable).</li> <li>• <b>SSID:</b> the SSID is the network name shared among all devices in a wireless network. The SSID must be identical for all devices in the wireless network. It is case-sensitive and must not exceed 32 alphanumeric characters, which may be any keyboard character. Make sure this setting is the same for all devices in your wireless network.</li> <li>• <b>SSID Broadcast:</b> sets the SSID broadcast function by toggling the activation button (Enable/Disable).</li> <li>• <b>Channel:</b> selects an appropriate channel from the list provided to correspond with your network settings. All devices in your wireless network must use the same channel in order to function correctly. Try to avoid conflicts with other wireless networks by choosing a channel where the upper and lower three channels are not in use.</li> <li>• <b>Mode:</b> sets the security mode type (Open/Secret).</li> <li>• <b>Passphrase:</b> enter the user name connected to Wi-Fi.</li> </ul> <p>Click the <b>Apply</b> button to apply the settings to the system.</p>
③	Mac Filter	<p>Select the mac filter mode (Disable/White List/Black List).</p> <ul style="list-style-type: none"> <li>• <b>Disable:</b> the MAC filter is disabled.</li> <li>• <b>White List:</b> in Whitelist mode, the router will restrict LAN access to all computers except those contained in the "Mac Address" menu.</li> <li>• <b>Black List:</b> in Blacklist mode, the listed devices are completely blocked from local network access.</li> </ul> <p>Click the <b>Apply</b> button to apply the settings to the system.</p> <p><b>NOTE:</b> Use caution when using the MAC Filter to avoid accidentally blocking yourself from accessing the router.</p>
④	Mac Address	<p>Displays the mac address. To create new mac addresses, click the plus icon. Then the pop-up window is opened. You can assign the new mac address. Click the <b>Create</b> button. The created mac addresses display on the list.</p>

## 8.7.3 Firewall

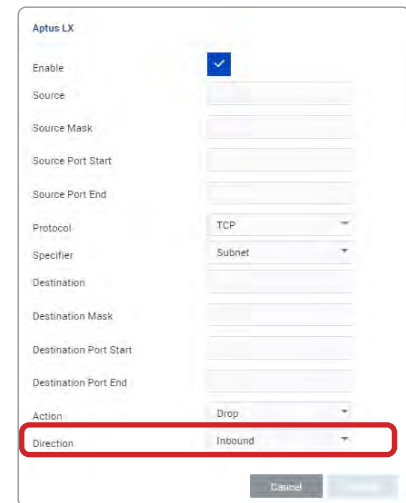
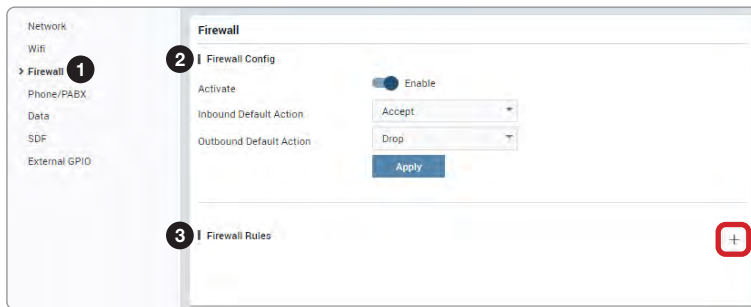

No.	Item	Description
①	Firewall	Sets the firewall, network security system, which monitors and controls incoming and outgoing network traffic based on predetermined security rules.
②	Firewall Config	<p>Sets the firewall configuration.</p> <ul style="list-style-type: none"> <li>• <b>Activate:</b> sets the firewall function by toggling the activation button (Enable/Disable).</li> <li>• <b>Inbound Default Action:</b> select the default settings for the incoming network from the drop-down list (Accept/Drop).</li> <li>• <b>Outbound Default Action:</b> select the default settings for the outgoing network from the drop-down list (Accept/Drop).</li> </ul> <p>Click the <b>Apply</b> button to apply the settings to the system.</p>
③	Firewall Rules	To create new firewall rules, click the plus icon. Then the pop-up window is opened. You can assign the new rule entered above to the <b>Inbound</b> (Inbound Default Action) or the <b>Outbound</b> (Outbound Default Action) in the <b>Direction</b> menu. Click the <b>Update</b> button. The created firewall rules are displayed on the list.

### 8.7.4 Phone/PBX

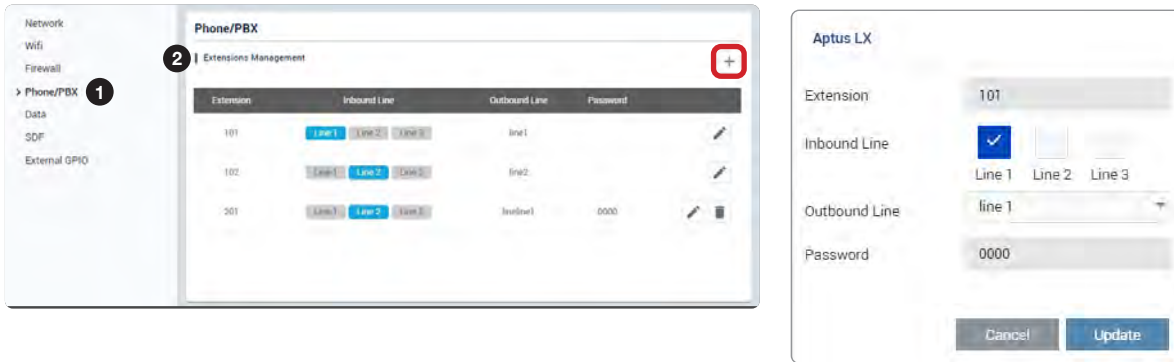

No.	Item	Description
①	Phone/PBX	Sets the phone and Private Branch Exchange (PBX).
②	Extensions Management	<p>Sets the extension number and details.</p> <ul style="list-style-type: none"> <li>• Extension: displays the registered extension.</li> <li>• Inbound Line: each inbound line can be controlled and managed by individual selection through the blue indicator.</li> <li>• Outband Line: displays the outbound line.</li> <li>• Password: displays the password.</li> <li>• Edit button: to edit the registered extension, click the edit button. Then the pop-up window is opened. You can edit details.</li> <li>• Delete button: to delete the registered extension, click the delete button. (Extension 101 and 102 have no delete button.)</li> </ul> <p>To create new extension numbers, click the plus icon. Then the pop-up window is opened. You can assign the new extension number. Click the <b>Update</b> button. The created extension numbers are displayed on the list.</p>

## 8.7.5 Data

The screenshot shows the 'Data' configuration page in AptusLX. The left sidebar has 'Data' selected. The main content area is divided into sections:

- 2 | Routing Config:** 'WAN Only' is selected in the 'Routing Policy' dropdown. An 'Apply' button is below.
- 3 | Satellite Link:** 'Active' is toggled on. 'Healthcheck' section has 'Active Threshold Count' set to 1 and 'Inactive Threshold Count' set to 10. An 'Apply' button is below.
- 4 | WAN Link:** 'Active' is toggled on. 'Address Mode' is set to 'Dynamic'. 'Static Config' section has empty fields for IP, Subnet Mask, and Gateway. 'Healthcheck' section has 'Ping Destination' set to 8.8.8.8, 'Interval' set to 5 sec, 'Response Timeout' set to 2 sec, 'Active Threshold Count' set to 2, and 'Inactive Threshold Count' set to 2. An 'Apply' button is below.
- 5 | Port/Protocol Forwarding:** Shows 'No Data' with a plus icon in a red box.

The 'Aptus LX' dialog box for Port/Protocol Forwarding is shown. It includes the following fields and options:

- Enable:** Checked (blue checkmark).
- Internal IP:** Empty text field.
- Link:** Dropdown menu set to 'Satellite'.
- Specifier:** Dropdown menu set to 'Port Forwarding'.
- Protocol:** Dropdown menu.
- Internal Port:** Empty text field.
- External Port:** Empty text field.
- Buttons:** 'Cancel' and 'Apply' buttons at the bottom.

No.	Item	Description
①	Data	Sets the data settings.
②	Routing Config	Selects the data route type (None, Satellite Only, WAN Only, Satellite Preferred, WAN Preferred). Click the <b>Apply</b> button to apply the settings to the system.
③	Satellite Link	Sets the satellite link. <ul style="list-style-type: none"> <li>Active: sets the satellite link function by toggling the activation button (Enable/Disable).</li> <li>Active Threshold Count: enter the active threshold count.</li> <li>Inactive Threshold Count: enter the inactive threshold count.</li> </ul> Click the <b>Apply</b> button to apply the settings to the system.

No.	Item	Description
④	WAN Link	<p>Sets the wide-area network (WAN) link.</p> <ul style="list-style-type: none"> <li>• Link: sets the WAN link function by toggling the activation button (Enable/Disable).</li> <li>• Address Mode: selects the IP address type (Dynamic/Static).               <ul style="list-style-type: none"> <li>- Dynamic: the IP address is assigned by the network automatically.</li> <li>- Static: the IP address is assigned manually.</li> </ul> </li> <li>• Static Config IP: enter the static IP address.</li> <li>• Subnet Mask: enter the subnet mask.</li> <li>• Gateway: enter the gateway.</li> <li>• DNS: enter the DNS.</li> <li>• Health Check Ping Destination: enter the health check ping.</li> <li>• Interval: enter the interval.</li> <li>• Response Timeout: enter the response timeout.</li> <li>• Active Threshold Count: enter the active threshold count.</li> <li>• Inactive Threshold Count: enter the inactive threshold count.</li> </ul> <p>Click the <b>Apply</b> button to apply the settings to the system.</p>
⑤	Port/Protocol Forwarding	<p>Displays the port/protocol forwarding list. To create new ports, click the plus icon. Then the pop-up window is opened. Enter the details, then click the <b>Update</b> button. The created ports are displayed on the list.</p>

## 8.7.6 SDF

No.	Item	Description
①	SDF	Sets each SDF settings.
②	SDF Config	Enter each SDF IP and subnet address. Click the <b>Apply</b> button to apply the settings to the system.

### 8.7.7 External GPIO

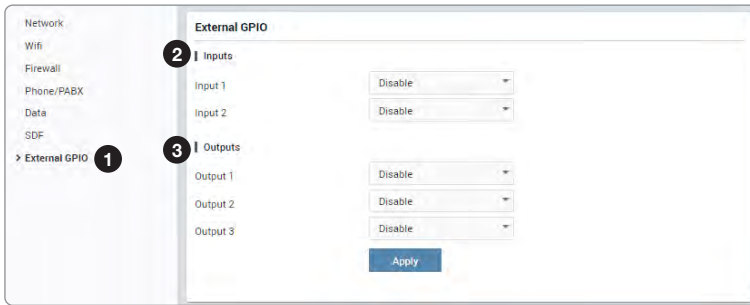

No.	Item	Description
①	External GPIO	Select the external General Purpose Inputs/Outputs (GPIO) settings from the drop-down list.
②	Inputs	Select the input settings from the drop-down list.
③	Outputs	Select the outputs settings from the drop-down list.



## 8.8 Tools

This menu sets and displays the Software Upgrade, Backup & Restore, Reset, Logs, and Diagnostic function.

### 8.8.1 Software Upgrade

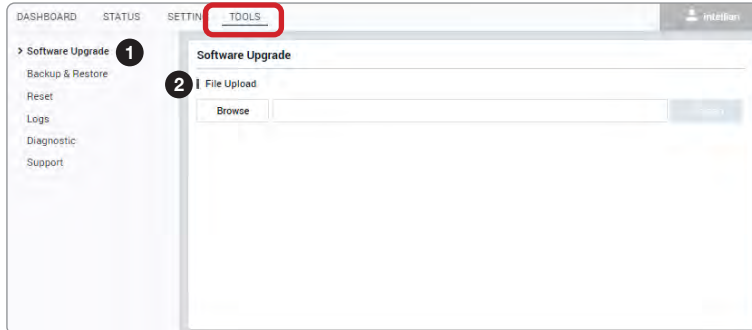

No.	Item	Description
①	Software Upgrade	Upgrades antenna software firmware.
②	Config	Browse and select the package firmware file to upload and click the <b>Upload</b> button. The update may take a few minutes to complete. The upload time may vary due to a variety of factors such as the speeds of your network. Uploading an incorrect firmware file may cause serious damage to your antenna and BDU. Refer to the following "Package Update Procedures" page for more details.

**Package Update Procedures:**

1. Browse and select the upgrade package file to upload. Click on the **Upload** button to transfer the Firmware package file (\*.bin) to the BDU module.



2. The antenna firmware state will appear in the pop-up window. Check the current version and the new version. Click the **Upgrade** button.

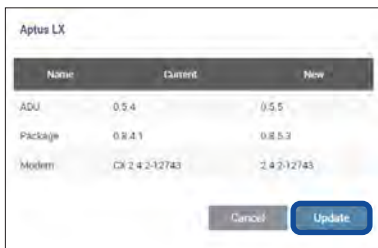

3. During the upgrade process, the window will display process status.

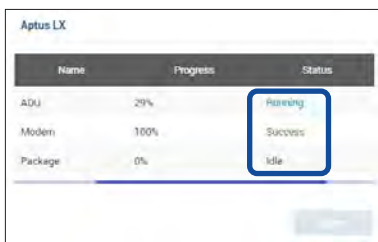

4. If the firmware is successfully upgraded, it will display as **Success**. Click the **Done** button to close the pop-up window.

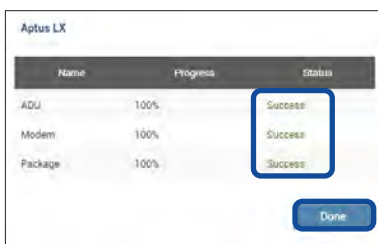

## 8.8.2 Backup & Restore

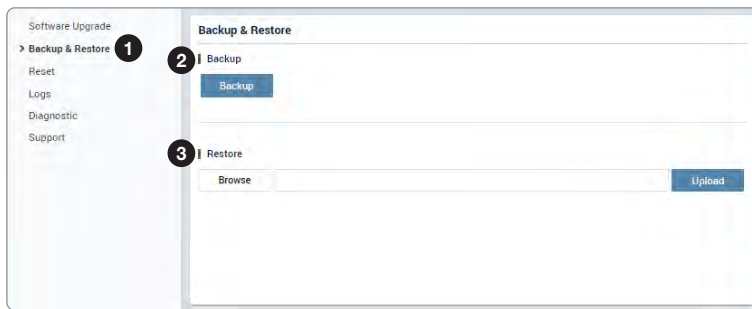

No.	Item	Description
①	Backup & Restore	Backs up user configuration files to PC and Restores the antenna settings.
②	Backup	Saves user configuration files to PC. Click the <b>Backup</b> button to apply the settings to the system.
③	Restore	Restores the antenna setting by using the setting files saved from the PC. Click the <b>Restore</b> button to apply the settings to the system.

### 8.8.3 Reset

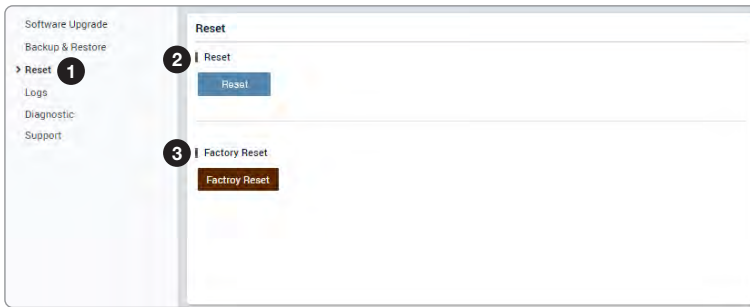

No.	Item	Description
①	Reset	Resets the antenna system and factory reset.
②	Reset	Click the <b>Reset</b> button to reset the antenna system. The user configuration is not reinitialized.
③	Factory Reset	Click the <b>Factory Reset</b> button to initialize the antenna system. The user configuration is initialized.

## 8.8.4 Logs

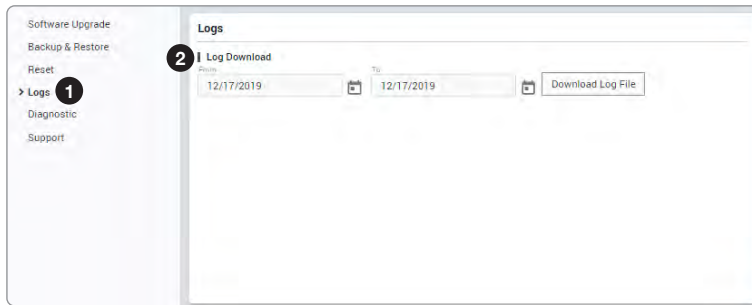

No.	Item	Description
①	Logs	Downloads the antenna log data.
②	Logs	Displays the antenna log list. <ul style="list-style-type: none"> <li>Download Log File: Any log data (.gz) within a month can be downloaded. Click the Download Log File button.</li> </ul>

### 8.8.5 Diagnostic

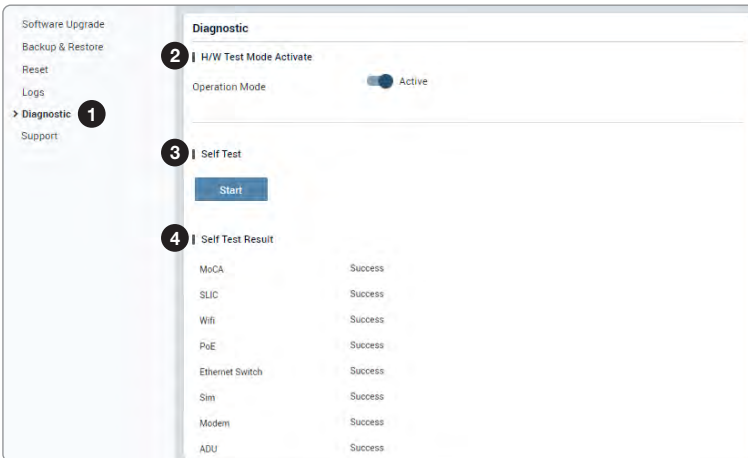

No.	Item	Description
①	Diagnostic	Executes antenna diagnosis test to check the antenna status.
②	H/W (Hardware) Test Mode Activate	Sets the hardware test function by toggling the activation button (Active/Inactive).
③	Self Test	The activation button must be selected to the "Active" in the previous step. Click the <b>Start</b> button to run the self-test.
④	Self Test Result	Displays the self-test result.



**WARNING**

While selecting the **Active** button in the H/W Test Mode Activate menu, the system is in the hardware test mode. Select the **Inactive** button for normal operation.

# Chapter 9. Specification

## 9.1 Technical Specification

Above Decks Unit (ADU)		
ADU Height		270 mm (10.62")
ADU Diameter		370 mm (14.99")
ADU Weight		6.8 kg (15 lbs)
Ship's Motion	Roll	$\pm 20^\circ$ at 0.4 Hz and $\pm 15^\circ$ at 0.33 Hz
	Pitch	$\pm 20^\circ$ at 0.45 Hz and $\pm 30^\circ$ at 0.25 Hz
	Yaw	$\pm 20^\circ$ at 0.45 Hz and $\pm 10^\circ$ at 0.2 Hz
	Turning Rate	12°/sec
Rx	Frequency	1616 MHz ~ 1626.5 MHz
	Gain	10.2 dBi
Tx	Frequency	1616 MHz ~ 1626 MHz
	Gain	10.4 dBi
Polarization		RHCP (Rx and Tx)
ADU to BDU Cable (Antenna Cable)		Single Coaxial Cable
RF Output Power		38.8 dBm
EIRP		18.2 dBW
Number of Channel		254
GNSS		Support GPS, GLONASS Band: 1559 MHz ~ 1610 MHz
Input Power		DC 48 V, 2 A
Below Decks Unit (BDU)		
BDU Size		315 mm x 190 mm x 42 mm (12.4" x 7.48" x 1.655")
BDU Weight		1.5 kg (3.3 lbs) [stand-alone type]
LED Indicator		3 LEDs for Power, Satellite link, and Event
Wi-Fi		802.11 b/g Frequency : 2400 MHz - 2483.5 MHz Output Power : below 30 dBm (10 mW/MHz in Korea, Japan) Max. Antenna gain: 2 dBi
Ethernet		RJ45 (4)
Analog Phone (POTS)		RJ14 (1)
I/O		10 pin GPIO
Wireless		1 Wi-Fi (SMA Reverse Polarity)
Web Interface		Embedded in BDU, available by Ethernet or Wi-Fi
Output Power		DC 48 V, 2 A
Input Power		DC (10.8 ~ 30) V (nominal DC 24 V), 12 A
Power (max)		120 W

## 9.2 Environmental Specification

Test	Intellian Standard	
Temperature (ADU)	Operational	IEC-60945 (-25°C to +55°C / Power On)
	Survival	IEC-60945 (-40° to +80° / Powered On and a non-functional state)
	Storage	IEC-60945 (-40° to +85° / Power off)
Temperature (BDU)	Operational	IEC-60945 (-25° to +55°)
	Survival	IEC-60945 (-40° to +80°)
	Storage	IEC-60945 (-40° to +85°)
Humidity	IEC-60068-2-30	
Vibration	Operational	IEC-60945
	Survival	IEC-60721-3-6 Class 6M3
Shock	Operational	IEC-60068-2-27
	Survival (Transient)	IEC-60721-3-6 Class 6M3
	Survival (Bump)	IEC-60721-3-6 Class 6M3
Salt Mist	IEC-60068-2-52	
Ingress Rating (ADU)	IP56	
Ingress Rating (BDU)	IP31	



# Chapter 10. Warranty

## 10.1 Warranty Policy

Intellian systems are warranted against defects in parts and workmanship, these warranties cover THREE (3) YEAR of parts and THREE (3) YEAR of factory repair labor to return the system to its original operational specification.

Warranty periods commence from the date of shipment from Intellian facility, or date of installation which is come sooner. Providing maximum 6 months Warranty additionally if submission of authorized form which is described installation occurs within 6 months from the shipment date.

Intellian Technologies warranty does not apply to product that has been damaged and subjected to accident, abuse, misuse, non-authorized modification, incorrect and/or non-authorized service, or to a product on which the serial number has been altered, mutilated or removed. Intellian Technologies, will (at its sole discretion) repair or replace during the warranty period any product which is proven to be defective in materials or workmanship, in accordance with the relevant product warranty policy. All products returned to Intellian Technologies, during the warranty period must be accompanied by a Service Case reference number issued by the dealer/distributor from Intellian Technologies, and (where applicable) a copy of the purchase receipt as a proof of purchase date, prior to shipment. Alternatively, you may bring the product to an authorized Intellian Technologies, dealer/distributor for repair.

# Chapter 11. Appendix

## 11.1 Tightening Torque Specification

The material qualities of screws are standardized. Refer to the tightening torque N-m according to ISO 898/1.

Bolt Size	Tightening Torque (N-m)	
	A2-70 (6.8)	A4-80 (8.8)
M4	1.5	2
M5	3	4
M6	5.1	6.8
M8	12.2	16.6
M10	25.2	33.1
M12	43.9	58.3
M16	114	139

