



# InterLab<sup>®</sup>

## Final Report on

### OM12001

**Report Reference:** MDE\_NXP\_1201\_FCCc  
According to:  
FCC 47 CFR Ch.1 Part 22, Subpart H

**Date:** July 20, 2012

**Test Laboratory:**

7Layers AG  
Borsigstr. 11  
40880 Ratingen  
Germany



**Note:**

The following test results relate only to the devices specified in this document. This report shall not be reproduced in parts without the written approval of the test laboratory.

7Layers AG  
Borsigstrasse 11  
40880 Ratingen, Germany  
Phone: +49 (0) 2102 749 0  
Fax: +49 (0) 2102 749 350  
www.7Layers.com

Aufsichtsratsvorsitzender •  
Chairman of the Supervisory Board:  
Ralf Mertens  
Vorstand • Board:  
Dr. H.-J. Meckelburg

Registergericht • registered in:  
Düsseldorf, HRB 44096  
USt-IdNr • VAT No.:  
DE 203159652  
TAX No. 147/5869/0385

## 1 Administrative Data

### 1.1 Project Data

*Project Responsible:* Patrick Lomax  
*Date Of Test Report:* 2012/07/20  
*Date of first test:* 2012/06/04  
*Date of last test:* 2012/06/06

### 1.2 Applicant Data

*Company Name:* NXP Semiconductors  
  
*Street:* 2 esplanade Anton Philips,  
Campus EffiScience,  
Colombelles BP2000  
*City:* 14906 Caen Cedex 9  
*Country:* France  
  
*Contact Person:* Mr. Hugues de Perthuis  
  
*Department:* BU Automotive & Identification  
*Phone:* +33 2.31.45.23.98  
*Fax:* +33 2.31.45.38.60

### 1.3 Test Laboratory Data

The following list shows all places and laboratories involved for test result generation:

#### 7 layers DE

---

*Company Name :* 7 layers AG  
*Street :* Borsigstrasse 11  
*City :* 40880 Ratingen  
*Country :* Germany  
*Contact Person :* Mr. Michael Albert  
*Phone :* +49 2102 749 201  
*Fax :* +49 2102 749 444  
*E Mail :* michael.albert@7Layers.de

#### Laboratory Details

---

<i>Lab ID</i>	<i>Identification</i>	<i>Responsible</i>	<i>Accreditation Info</i>
Lab 1	Radiated Emissions	Mr. Robert Machulec Mr. Andreas Petz	DAkkS-Registration no. D-PL-12140-01-01
Lab 2	Radio Lab	Mr. Robert Machulec Mr. Andreas Petz	DAkkS-Registration no. D-PL-12140-01-01

**1.4 Signature of the Testing Responsible**

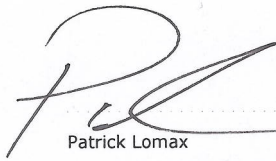

Patrick Lomax  
 responsible for tests performed in: Lab 1, Lab 2



7layers AG, Borsigstr. 11  
 40880 Ratingen, Germany  
 Phone +49 (0)2102 749 0

**1.5 Signature of the Accreditation Responsible**

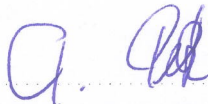

Accreditation scope responsible person  
 responsible for Lab 1, Lab 2

[A. Petz]

**2 Test Object Data**

**2.1 General OUT Description**

The following section lists all OUTs (Object's Under Test) involved during testing.

**OUT: OM12001**

*Product Category:* Module  
*Manufacturer:*  
*Company Name:* Please see applicant data  
*Contact Person:* -

**Parameter List:**

Parameter name	Value
<b>Parameter for Scope FCC_v2:</b>	
DC Power Supply	4.2 (V)
highest channel	251 (848.8MHz) for GSM850, 810 (1909.8MHz) for GSM1900
lowest channel	128 (824.2MHz) for GSM850, 512 (1850.2MHz) for GSM1900 (MHz)
mid channel	190 (836.6MHz) for GSM850, 661 (1880.0MHz) for GSM1900

## 2.2 Detailed Description of OUT Samples

### Sample : A01

<i>OUT Identifier</i>	OM12001		
<i>Sample Description</i>	Conducted Sample		
<i>Serial No.</i>	35477104016187		
<i>HW Status</i>	B2.3		
<i>SW Status</i>	7.4.4		
<i>Date of Receipt</i>	2012/05/09		
<i>Low Voltage</i>	3.4 V	<i>Low Temp.</i>	-40 °C
<i>High Voltage</i>	4.8 V	<i>High Temp.</i>	85 °C
<i>Nominal Voltage</i>	4.2 V	<i>Normal Temp.</i>	23 °C

### Sample : B01

<i>OUT Identifier</i>	OM12001		
<i>Sample Description</i>	Conducted Sample		
<i>Serial No.</i>	35477104016156		
<i>HW Status</i>	B2.3		
<i>SW Status</i>	7.4.4		
<i>Date of Receipt</i>	2012/05/09		
<i>Low Voltage</i>	3.4 V	<i>Low Temp.</i>	-40 °C
<i>High Voltage</i>	4.8 V	<i>High Temp.</i>	85 °C
<i>Nominal Voltage</i>	4.2 V	<i>Normal Temp.</i>	23 °C

## 2.3 OUT Features

### Features for OUT: **OM12001**

<i>Designation</i>	<i>Description</i>	<i>Allowed Values</i>	<i>Supported Value(s)</i>
<b>Features for scope: FCC_v2</b>			
Dant	removable antenna supplied and type tested with the radio equipment, designed as an example part of the equipment		
DC	The OUT is powered by or connected to DC Mains		
GSM850	EUT supports GSM850 band 824MHz - 849MHz		
PCS1900	EUT supports PCS1900 band 1850MHz - 1910MHz		
SRD	EUT is a short range device		
TantC	temporary antenna connector, which may be only built-in for testing, designed as an example part of the equipment		

## 2.4 Auxiliary Equipment

AE No.	Type Designation	Serial No.	HW Status	SW Status	Description
AE 01	Omni-Dir 1dBi Gain				GSM Multiband Magnet Antenna SMA

## 2.5 Setups used for Testing

For each setup a relation is given to determine if and which samples and auxiliary equipment is used. The left side list all OUT samples and the right side lists all auxiliary equipment for the given setup.

Setup No.	List of OUT samples		List of auxiliary equipment	
	Sample No.	Sample Description	AE No.	AE Description
<b>S01_A01</b>				
	Sample: A01	Conducted Sample	AE 01	GSM Multiband Magnet Antenna SMA
<b>S01_B01</b>				
	Sample: B01	Conducted Sample	AE 01	GSM Multiband Magnet Antenna SMA

## 3 Results

### 3.1 General

**Documentation of tested devices:**

Available at the test laboratory.

**Interpretation of the test results:**

The results of the inspection are described on the following pages, where 'Conformity' or 'Passed' means that the certification criteria were verified and that the tested device is conform to the applied standard.

In cases where 'Declaration' is printed, the required documents are available in the manufacturers product documentation.

In cases where 'not applicable' is printed, the test case requirements are not relevant to the specific equipment implementation.

**Note:**

The laboratory environmental conditions are recorded and available in the Interlab system for each performed test.

### 3.2 List of the Applicable Body

(Body for Scope: FCC\_v2)

Designation	Description
FCC47CFRChIPART22PUBLIC MOBILE SERVICES	Part 22, Subpart H - Cellular Radiotelephone Service

### 3.3 List of Test Specification

Test Specification:	<b>FCC part 2 and 22</b>
Version	10-1-11 Edition
Title:	PART 2 - GENERAL RULES AND REGULATIONS PART 22 - PUBLIC MOBILE SERVICES

### 3.4 Summary

<i>Test Case Identifier / Name</i>	<i>Result</i>	<i>Date of Test</i>	<i>Lab Ref.</i>	<i>Setup</i>
<b>22.1 RF Power Output §2.1046, §22.913</b>				
22.1; Frequency Band = 850, Mode = GSM, Channel = 128, Frequency = 824.2MHz, Method = conducted	Passed	2012/06/05	Lab 2	S01_A01
22.1; Frequency Band = 850, Mode = GSM, Channel = 128, Frequency = 824.2MHz, Method = radiated	Passed	2012/06/05	Lab 1	S01_B01
22.1; Frequency Band = 850, Mode = GSM, Channel = 190, Frequency = 836.6MHz, Method = conducted	Passed	2012/06/05	Lab 2	S01_A01
22.1; Frequency Band = 850, Mode = GSM, Channel = 190, Frequency = 836.6MHz, Method = radiated	Passed	2012/06/05	Lab 1	S01_B01
22.1; Frequency Band = 850, Mode = GSM, Channel = 251, Frequency = 848.8MHz, Method = conducted	Passed	2012/06/05	Lab 2	S01_A01
22.1; Frequency Band = 850, Mode = GSM, Channel = 251, Frequency = 848.8MHz, Method = radiated	Passed	2012/06/05	Lab 1	S01_B01
<b>22.2 Frequency stability §2.1055</b>				
22.2; Frequency Band = 850, Mode = GSM, Channel = 190, Frequency = 836.6MHz	Passed	2012/06/06	Lab 2	S01_B01
<b>22.3 Spurious emissions at antenna terminals §2.1051, §22.917</b>				
22.3; Frequency Band = 850, Mode = GSM, Channel = 128, Frequency = 824.2MHz,	Passed	2012/06/05	Lab 2	S01_A01
22.3; Frequency Band = 850, Mode = GSM, Channel = 190, Frequency = 836.6MHz	Passed	2012/06/05	Lab 2	S01_A01
22.3; Frequency Band = 850, Mode = GSM, Channel = 251, Frequency = 848.8MHz	Passed	2012/06/05	Lab 2	S01_A01
<b>22.4 Field strength of spurious radiation §2.1053, §22.917</b>				
22.4; Frequency Band = 850, Mode = GSM, Channel = 128, Frequency = 824.2MHz	Passed	2012/06/04	Lab 1	S01_B01
22.4; Frequency Band = 850, Mode = GSM, Channel = 190, Frequency = 836.6MHz	Passed	2012/06/05	Lab 1	S01_B01
22.4; Frequency Band = 850, Mode = GSM, Channel = 251, Frequency = 848.8MHz	Passed	2012/06/05	Lab 1	S01_B01
<b>22.5 Emission and Occupied Bandwidth §2.1049, §22.917</b>				
22.5; Frequency Band = 850, Mode = GSM, Channel = 128, Frequency = 824.2MHz	Passed	2012/06/05	Lab 2	S01_A01
22.5; Frequency Band = 850, Mode = GSM, Channel = 190, Frequency = 836.6MHz	Passed	2012/06/05	Lab 2	S01_A01
22.5; Frequency Band = 850, Mode = GSM, Channel = 251, Frequency = 848.8MHz	Passed	2012/06/05	Lab 2	S01_A01
<b>22.6 Band edge compliance §2.1053, §22.917</b>				
22.6; Frequency Band = 850, Mode = GSM, Channel = 128, Frequency = 824.2MHz	Passed	2012/06/05	Lab 2	S01_A01
22.6; Frequency Band = 850, Mode = GSM, Channel = 251, Frequency = 848.8MHz	Passed	2012/06/05	Lab 2	S01_A01



### 3.5 Detailed Results

#### 3.5.1 22.1 RF Power Output §2.1046, §22.913

**Test: 22.1; Frequency Band = 850, Mode = GSM, Channel = 128, Frequency = 824.2MHz, Method = conducted**

<i>Result:</i>	Passed
<i>Setup No.:</i>	S01_A01
<i>Date of Test:</i>	2012/06/05 9:13
<i>Body:</i>	FCC47CFRChIPART22PUBLIC MOBILE SERVICES
<i>Test Specification:</i>	FCC part 2 and 22





detector	trace	resolution bandwidth /kHz	conducted peak value /dBm	verdict
peak	maxhold	300	31.66	passed
average	maxhold	300	31.27	passed
rms	maxhold	300	31.28	passed

no external antenna gain is specified, the verdict is valid for external antenna gains equal or less than 8.93 dBi

**Test: 22.1; Frequency Band = 850, Mode = GSM, Channel = 128, Frequency = 824.2MHz, Method = radiated**

*Result:* Passed  
*Setup No.:* S01\_B01  
*Date of Test:* 2012/06/05 4:21  
*Body:* FCC47CFRChIPART22PUBLIC MOBILE SERVICES  
*Test Specification:* FCC part 2 and 22

**Detailed Results:**

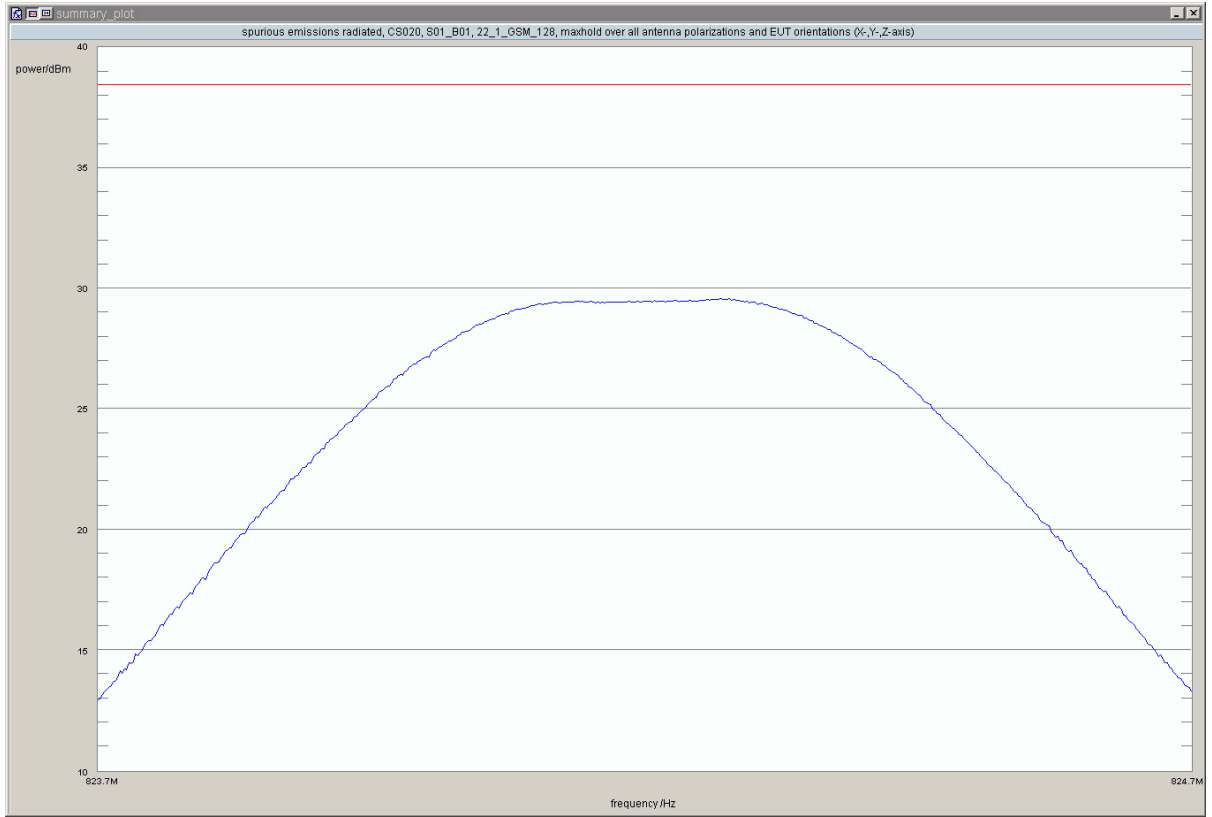

detector	trace	resolution bandwidth /kHz	frequency /MHz	peak value /dBm	limit /dBm	margin to limit /dB	azimuth /°	antenna polarization	EUT orientation	verdict
peak	maxhold	300	824.27	29.59	38.45	8.86	45.0	horizontal	vertical	passed

no further values have been found with a margin of less than 30 dB

**Test: 22.1; Frequency Band = 850, Mode = GSM, Channel = 190, Frequency = 836.6MHz, Method = conducted**

*Result:* Passed

*Setup No.:* S01\_A01

*Date of Test:* 2012/06/05 9:11

*Body:* FCC47CFRChIPART22PUBLIC MOBILE SERVICES

*Test Specification:* FCC part 2 and 22

**Detailed Results:**

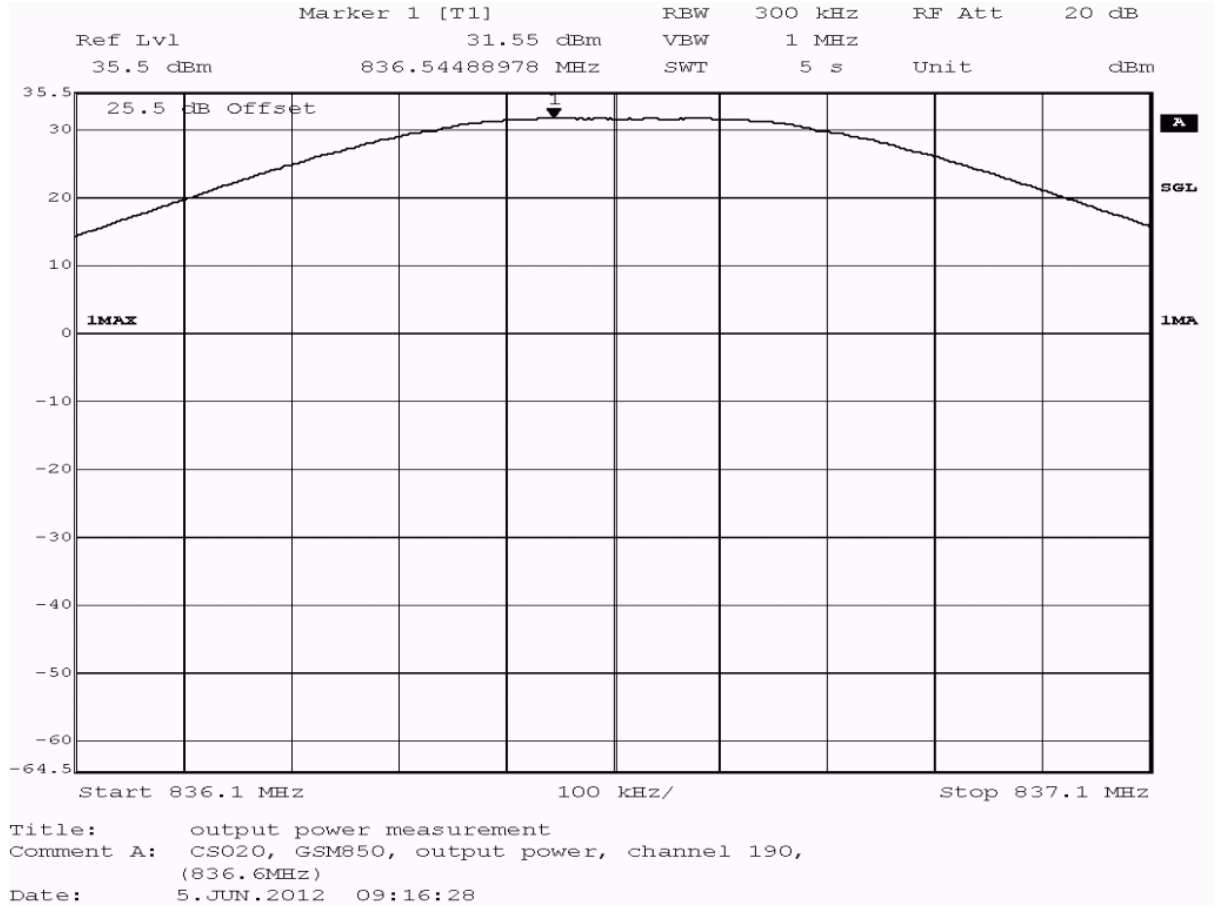

detector	trace	resolution bandwidth /kHz	conducted peak value /dBm	verdict
peak	maxhold	300	31.55	passed
average	maxhold	300	31.15	passed
rms	maxhold	300	31.16	passed

no external antenna gain is specified, the verdict is valid for external antenna gains equal or less than 9.04 dBi

**Test: 22.1; Frequency Band = 850, Mode = GSM, Channel = 190, Frequency = 836.6MHz, Method = radiated**

*Result:* Passed  
*Setup No.:* S01\_B01  
*Date of Test:* 2012/06/05 4:54  
*Body:* FCC47CFRChIPART22PUBLIC MOBILE SERVICES  
*Test Specification:* FCC part 2 and 22

**Detailed Results:**

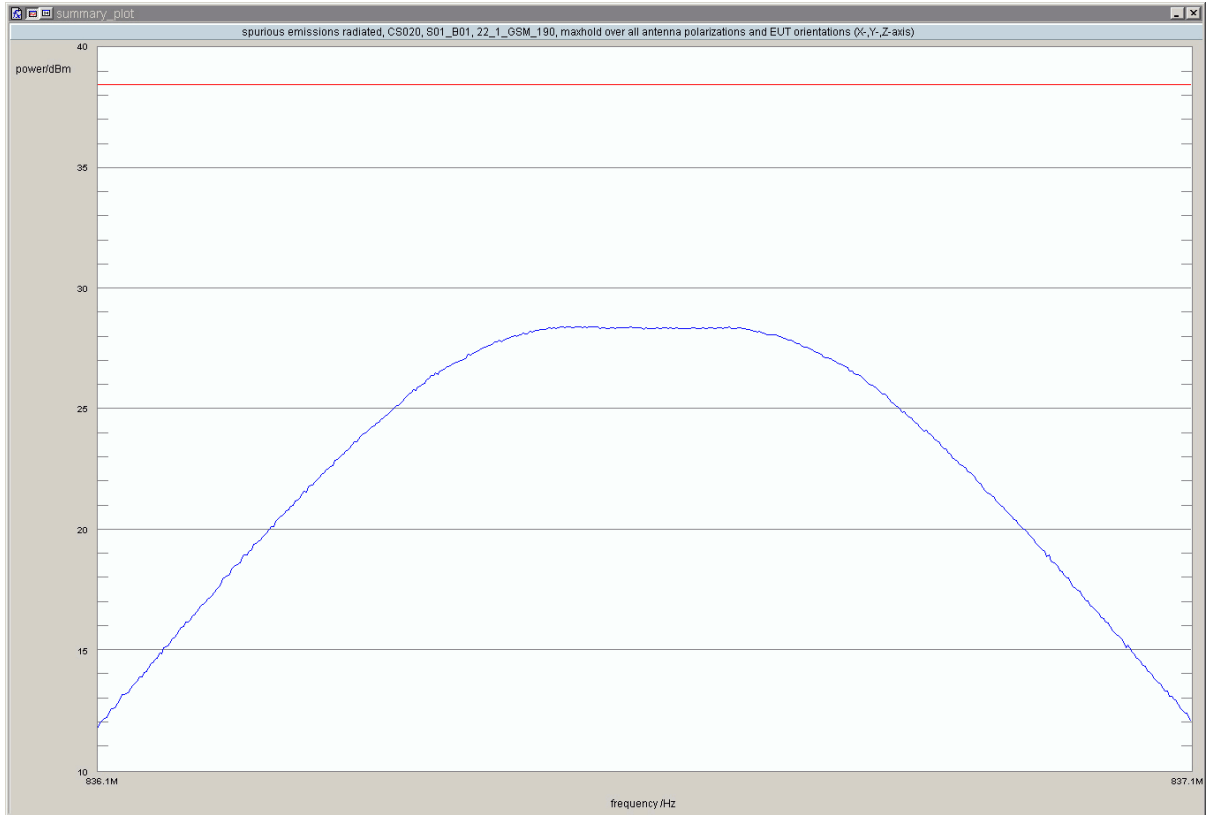

detector	trace	resolution bandwidth /kHz	frequency /MHz	peak value /dBm	limit /dBm	margin to limit /dB	azimuth /°	antenna polarization	EUT orientation	verdict
peak	maxhold	300	836.54	28.42	38.45	10.03	45.0	horizontal	vertical	passed

no further values have been found with a margin of less than 30 dB

**Test: 22.1; Frequency Band = 850, Mode = GSM, Channel = 251, Frequency = 848.8MHz, Method = conducted**

*Result:* Passed  
*Setup No.:* S01\_A01  
*Date of Test:* 2012/06/05 9:08  
*Body:* FCC47CFRChIPART22PUBLIC MOBILE SERVICES  
*Test Specification:* FCC part 2 and 22

**Detailed Results:**

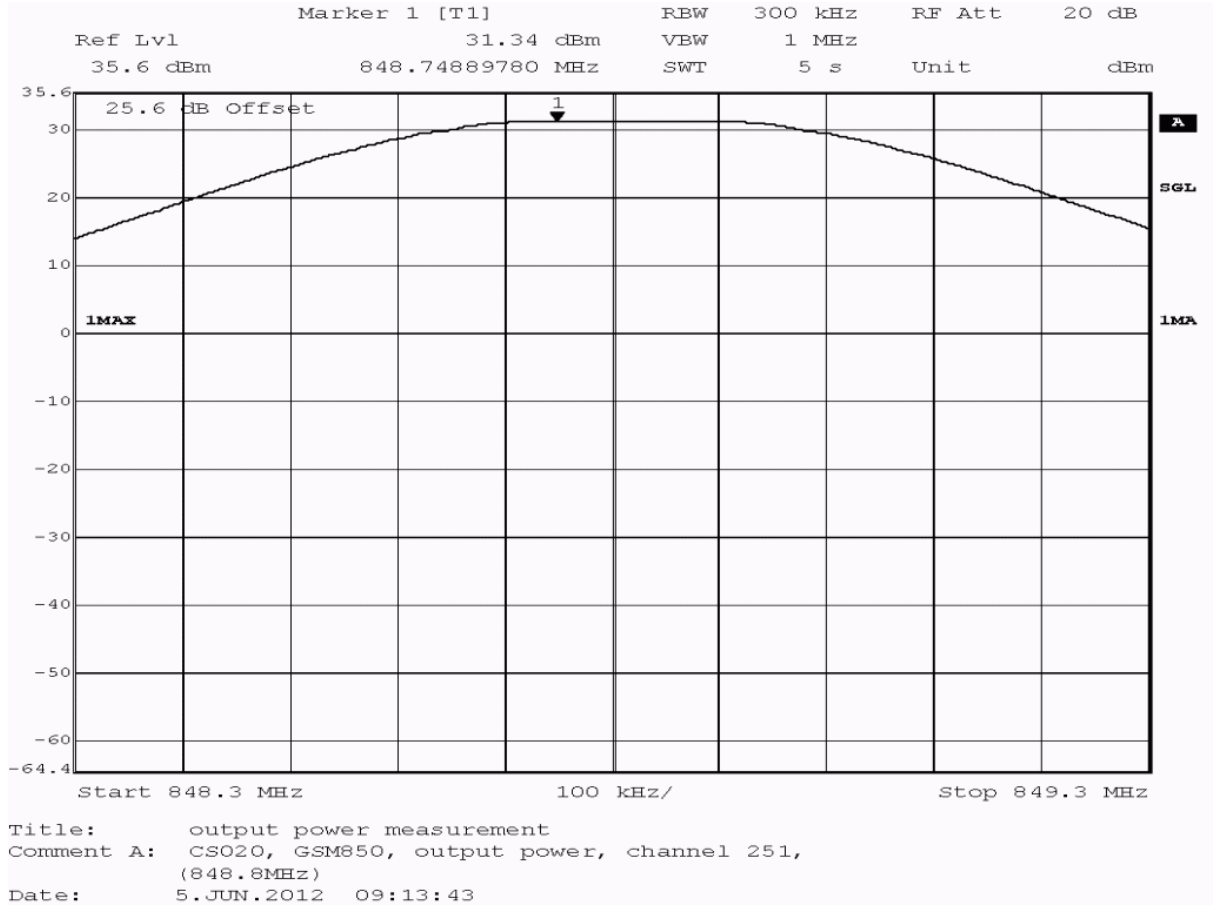

detector	trace	resolution bandwidth /kHz	conducted peak value /dBm	verdict
peak	maxhold	300	31.34	passed
average	maxhold	300	30.90	passed
rms	maxhold	300	30.91	passed

no external antenna gain is specified, the verdict is valid for external antenna gains equal or less than 9.25 dBi

**Test: 22.1; Frequency Band = 850, Mode = GSM, Channel = 251, Frequency = 848.8MHz, Method = radiated**

*Result:* Passed  
*Setup No.:* S01\_B01  
*Date of Test:* 2012/06/05 5:27  
*Body:* FCC47CFRChIPART22PUBLIC MOBILE SERVICES  
*Test Specification:* FCC part 2 and 22

**Detailed Results:**

detector	trace	resolution bandwidth /kHz	frequency /MHz	peak value /dBm	limit /dBm	margin to limit /dB	azimuth /°	antenna polarization	EUT orientation	verdict
peak	maxhold	300	848.86	25.88	38.45	12.57	45.0	horizontal	vertical	passed

no further values have been found with a margin of less than 30 dB

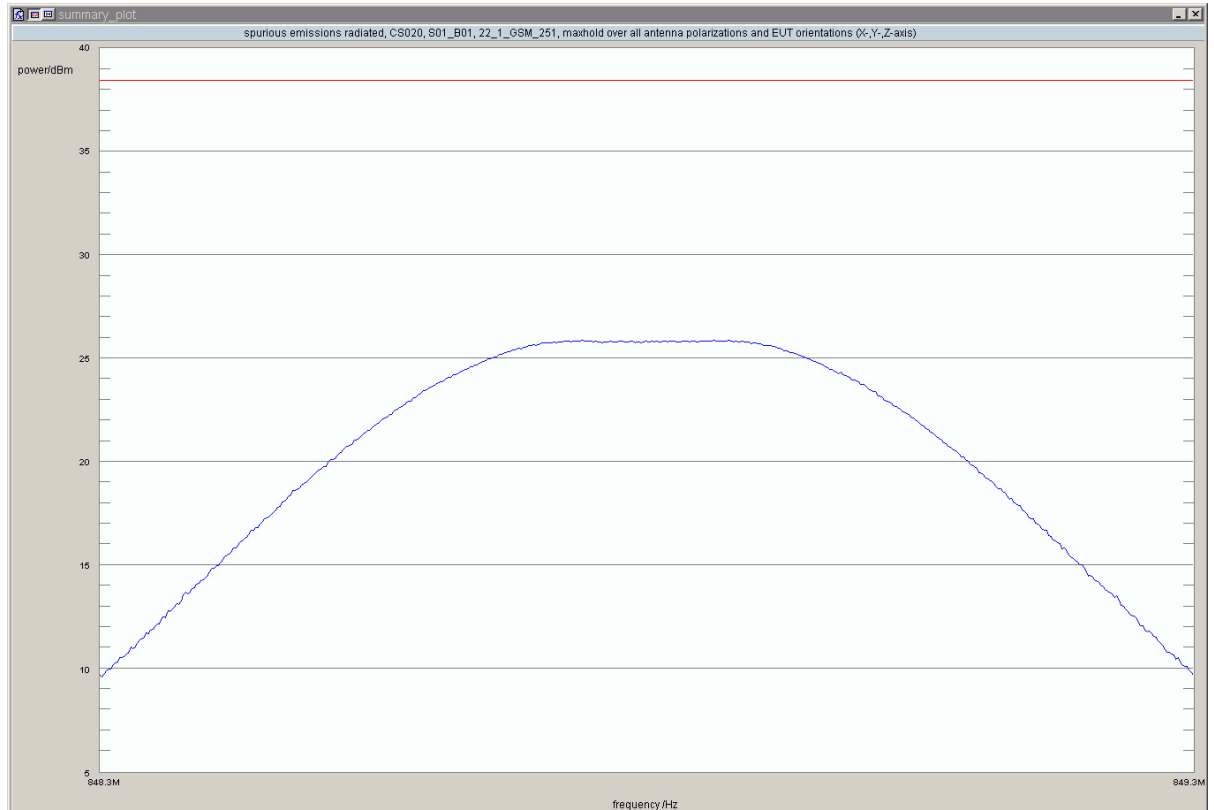

### 3.5.2 22.2 Frequency stability §2.1055

**Test: 22.2; Frequency Band = 850, Mode = GSM, Channel = 190, Frequency = 836.6MHz**

Result: Passed  
Setup No.: S01\_B01  
Date of Test: 2012/06/06 5:54  
Body: FCC47CFRChIPART22PUBLIC MOBILE SERVICES  
Test Specification: FCC part 2 and 22

**Detailed Results:**

Temp. °C	Duration min	Voltage	Limit Hz	Freq. error Average (Hz)	Freq. error Max. (Hz)	Verdict
-30	0	normal	2095.5	-9	-25	passed
-30	5			-13	-24	passed
-30	10			-18	-26	passed
-20	0	normal	2095.5	-14	-23	passed
-20	5			-19	-26	passed
-20	10			-20	-27	passed
-10	0	normal	2095.5	-21	-30	passed
-10	5			-27	-33	passed
-10	10			-24	-33	passed
0	0	normal	2095.5	-20	-29	passed
0	5			-24	-30	passed
0	10			-30	-34	passed
10	0	normal	2095.5	-35	-45	passed
10	5			-31	-38	passed
10	10			-34	-41	passed
20	0	low	2095.5	-37	-44	passed
20	5			-44	-50	passed
20	10			-27	-34	passed
20	0	normal	2095.5	-39	-45	passed
20	5			-42	-63	passed
20	10			-28	-37	passed
20	0	high	2095.5	-24	-33	passed
20	5			-13	-23	passed
20	10			-24	-31	passed
30	0	normal	2095.5	-36	-42	passed
30	5			-33	-40	passed
30	10			-34	-41	passed
40	0	normal	2095.5	-35	-44	passed
40	5			-34	-40	passed
40	10			-33	-37	passed
50	0	normal	2095.5	-34	-40	passed
50	5			-34	-40	passed
50	10			-29	-35	passed

Battery operating end point voltage <sup>1)</sup>						
Temp. °C	Duration min	Voltage V	Limit Hz	Freq. error Average (Hz)	Freq. error Max. (Hz)	Verdict
20	0	3.25	2095.5	-59	-72	passed
20	5			-55	-64	passed
20	10			-53	-59	passed

1) The call is established at high voltage and the voltage is then reduced to the battery operating end.



**3.5.3      22.3      Spurious emissions at antenna terminals §2.1051, §22.917**

**Test: 22.3; Frequency Band = 850, Mode = GSM, Channel = 128, Frequency = 824.2MHz,**

<i>Result:</i>	Passed
<i>Setup No.:</i>	S01_A01
<i>Date of Test:</i>	2012/06/05 10:13
<i>Body:</i>	FCC47CFRChIPART22PUBLIC MOBILE SERVICES
<i>Test Specification:</i>	FCC part 2 and 22

**Detailed Results:**

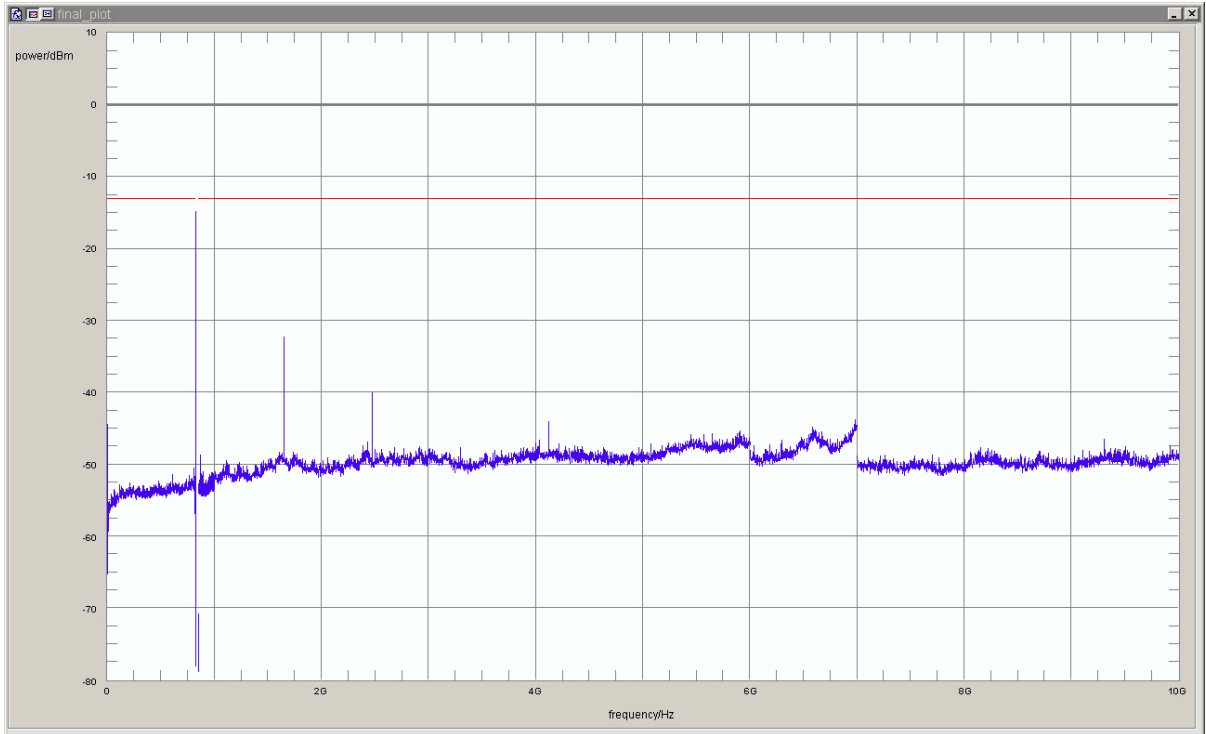

detector	trace	resolution bandwidth /kHz	frequency /MHz	peak value /dBm	margin to limit /dB	limit /dBm	verdict
peak	maxhold	3	823.9118	-27.5	14.5	-13.0	passed
peak	maxhold	3	823.9319	-24.1	11.1	-13.0	passed
peak	maxhold	3	823.9639	-15.9	2.9	-13.0	passed
peak	maxhold	3	823.9719	-14.9	1.9	-13.0	passed
peak	maxhold	3	823.9820	-14.8	1.8	-13.0	passed
peak	maxhold	3	823.9980	-14.9	1.9	-13.0	passed
peak	maxhold	100	1649.30	-32.3	19.3	-13.0	passed

no further values have been found with a margin of less than 20 dB

Peak at 823 MHz is generated by base station simulator and not EUT

**Test: 22.3; Frequency Band = 850, Mode = GSM, Channel = 190, Frequency = 836.6MHz**

Result: Passed  
 Setup No.: S01\_A01  
 Date of Test: 2012/06/05 8:38  
 Body: FCC47CFRChIPART22PUBLIC MOBILE SERVICES  
 Test Specification: FCC part 2 and 22

**Detailed Results:**

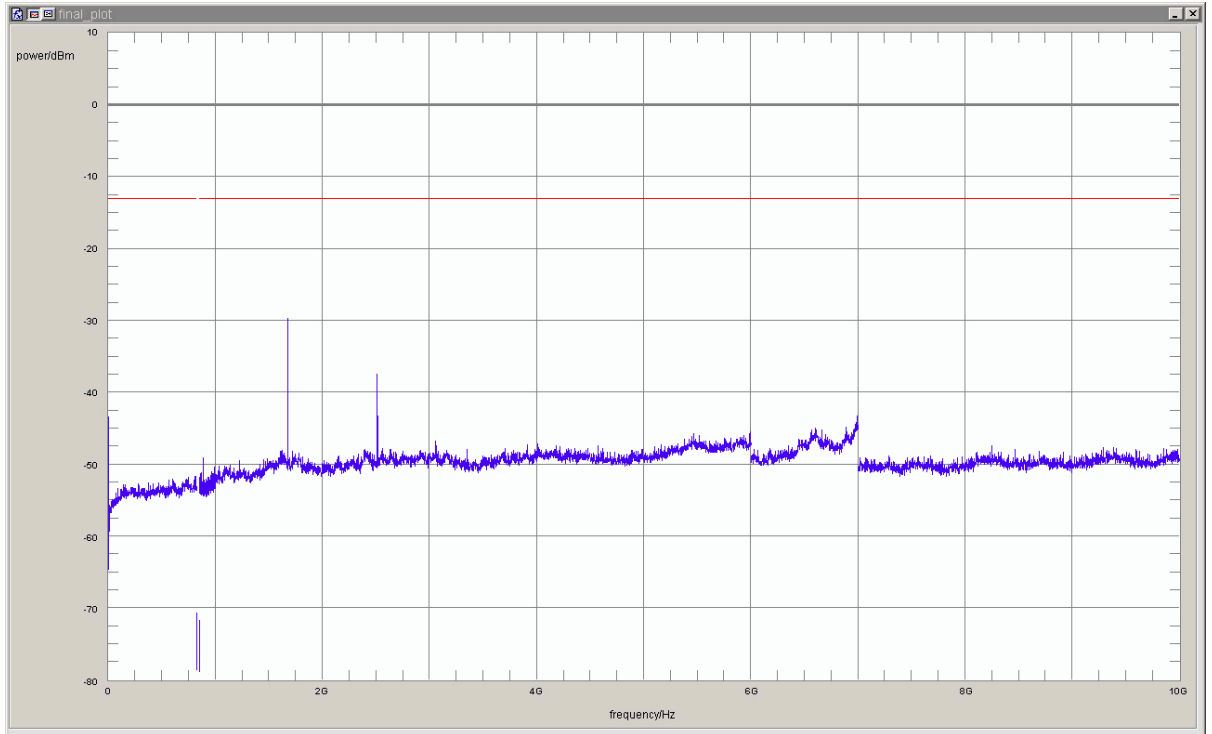

detector	trace	resolution bandwidth /kHz	frequency /MHz	peak value /dBm	margin to limit /dB	limit /dBm	verdict
peak	maxhold	100	1673.35	-29.6	16.6	-13.0	passed

no further values have been found with a margin of less than 20 dB

**Test: 22.3; Frequency Band = 850, Mode = GSM, Channel = 251, Frequency = 848.8MHz**

*Result:* Passed  
*Setup No.:* S01\_A01  
*Date of Test:* 2012/06/05 9:56  
*Body:* FCC47CFRChIPART22PUBLIC MOBILE SERVICES  
*Test Specification:* FCC part 2 and 22

**Detailed Results:**

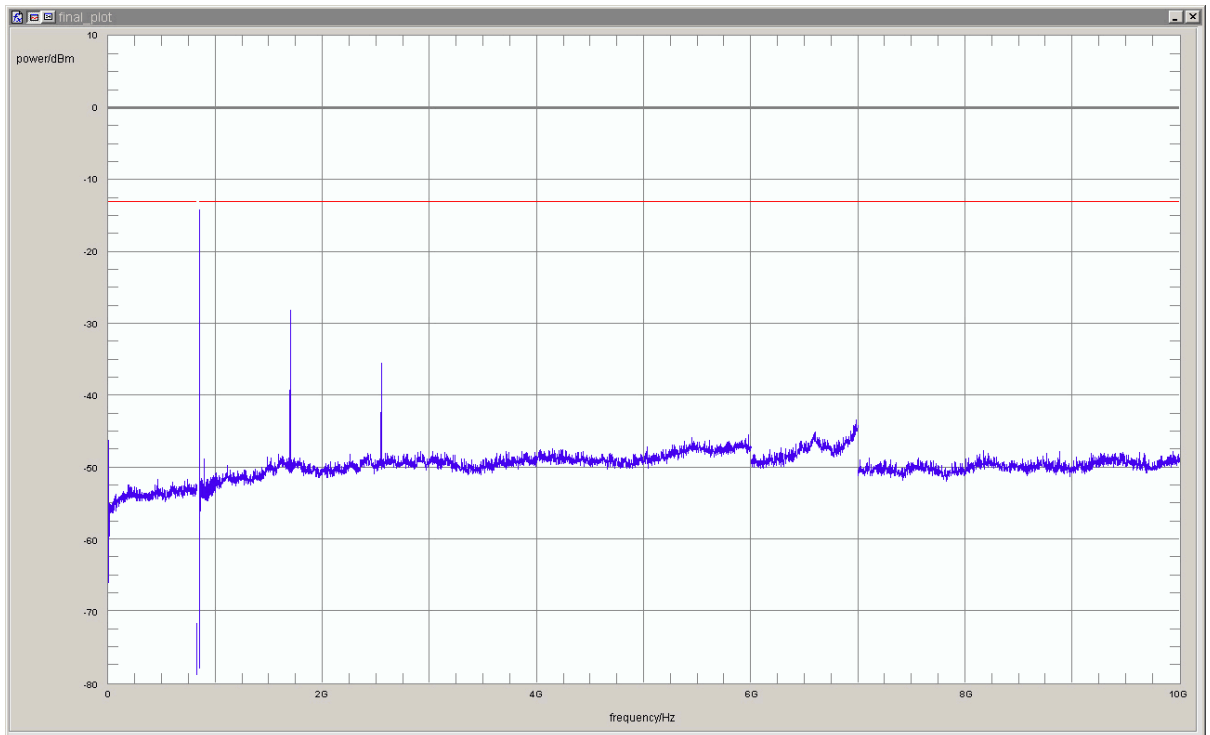

detector	trace	resolution bandwidth /kHz	frequency /MHz	peak value /dBm	margin to limit /dB	limit /dBm	verdict
peak	maxhold	3	849.0020	-21.8	8.8	-13.0	passed
peak	maxhold	3	849.0080	-15.1	2.1	-13.0	passed
peak	maxhold	3	849.0220	-14.2	1.2	-13.0	passed
peak	maxhold	3	849.0361	-17.2	4.2	-13.0	passed
peak	maxhold	3	849.0481	-19.1	6.1	-13.0	passed
peak	maxhold	3	849.0721	-25.8	12.8	-13.0	passed
peak	maxhold	3	849.0762	-25.7	12.7	-13.0	passed
peak	maxhold	3	849.0802	-26.5	13.5	-13.0	passed
peak	maxhold	100	1697.39	-28.1	15.1	-13.0	passed

no further values have been found with a margin of less than 20 dB

Peak at 849 MHz is generated by base station simulator and not EUT

### 3.5.4 22.4 Field strength of spurious radiation §2.1053, §22.917

**Test: 22.4; Frequency Band = 850, Mode = GSM, Channel = 128, Frequency = 824.2MHz**

Result: Passed  
Setup No.: S01\_B01  
Date of Test: 2012/06/04 18:18  
Body: FCC47CFRChIPART22PUBLIC MOBILE SERVICES  
Test Specification: FCC part 2 and 22

**Detailed Results:**

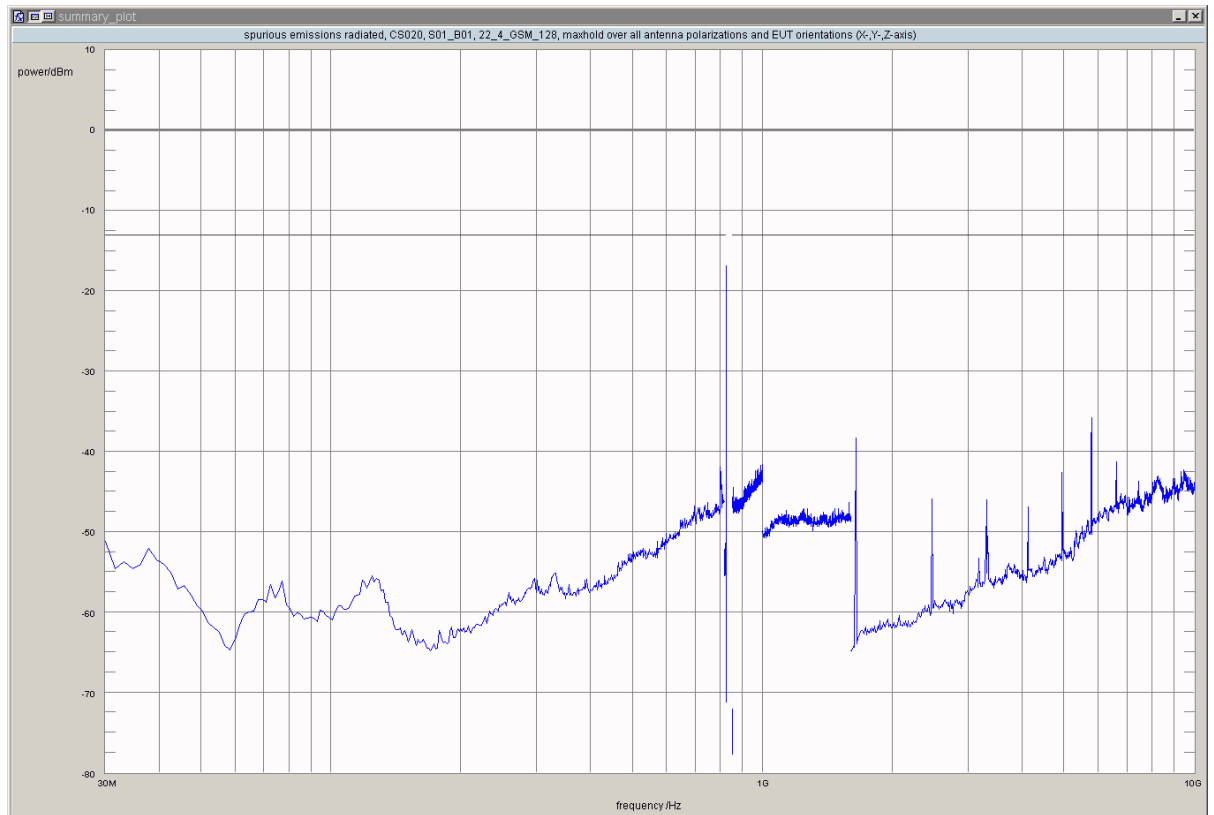

detector	trace	resolution bandwidth /kHz	frequency /MHz	peak value /dBm	limit /dBm	margin to limit /dB	azimuth /°	antenna polarization	EUT orientation	verdict
peak	maxhold	3	823.9259	-31.12	-13.00	18.12	-180.0	vertical	horizontal	passed
peak	maxhold	3	823.9339	-29.51	-13.00	16.51	0.0	vertical	vertical	passed
peak	maxhold	3	823.9379	-29.20	-13.00	16.20	-180.0	vertical	horizontal	passed
peak	maxhold	3	823.9479	-23.85	-13.00	10.85	0.0	vertical	vertical	passed
peak	maxhold	3	823.9519	-29.78	-13.00	16.78	-180.0	horizontal	vertical	passed
peak	maxhold	3	823.9719	-20.54	-13.00	7.54	0.0	vertical	vertical	passed
peak	maxhold	3	823.9820	-16.85	-13.00	3.85	0.0	vertical	vertical	passed
peak	maxhold	3	823.9940	-20.37	-13.00	7.37	-180.0	vertical	horizontal	passed
peak	maxhold	3	823.9980	-19.20	-13.00	6.20	-180.0	vertical	vertical	passed

no further values have been found with a margin of less than 20 dB

Peak at 823 MHz is generated from basestation simulator and not EUT

**Test: 22.4; Frequency Band = 850, Mode = GSM, Channel = 190, Frequency = 836.6MHz**

*Result:* Passed  
*Setup No.:* S01\_B01  
*Date of Test:* 2012/06/05 7:30  
*Body:* FCC47CFRChIPART22PUBLIC MOBILE SERVICES  
*Test Specification:* FCC part 2 and 22

**Detailed Results:**

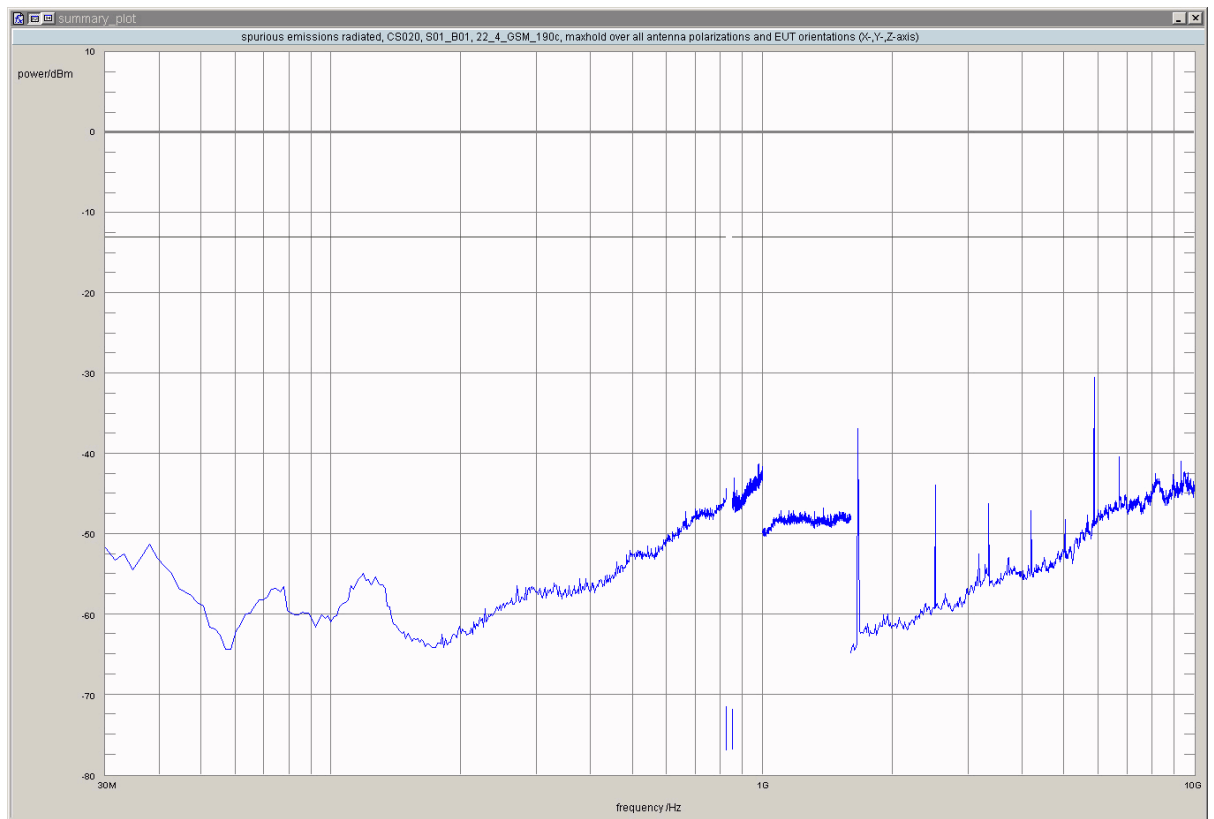

detector	trace	resolution bandwidth /kHz	frequency /MHz	peak value /dBm	limit /dBm	margin to limit /dB	azimuth /°	antenna polarization	EUT orientation	verdict
peak	maxhold	1000	5863.7	-30.46	-13.00	17.46	120.0	vertical	horizontal	passed

no further values have been found with a margin of less than 20 dB

**Test: 22.4; Frequency Band = 850, Mode = GSM, Channel = 251, Frequency = 848.8MHz**

*Result:* Passed  
*Setup No.:* S01\_B01  
*Date of Test:* 2012/06/05 6:28  
*Body:* FCC47CFRChIPART22PUBLIC MOBILE SERVICES  
*Test Specification:* FCC part 2 and 22

**Detailed Results:**

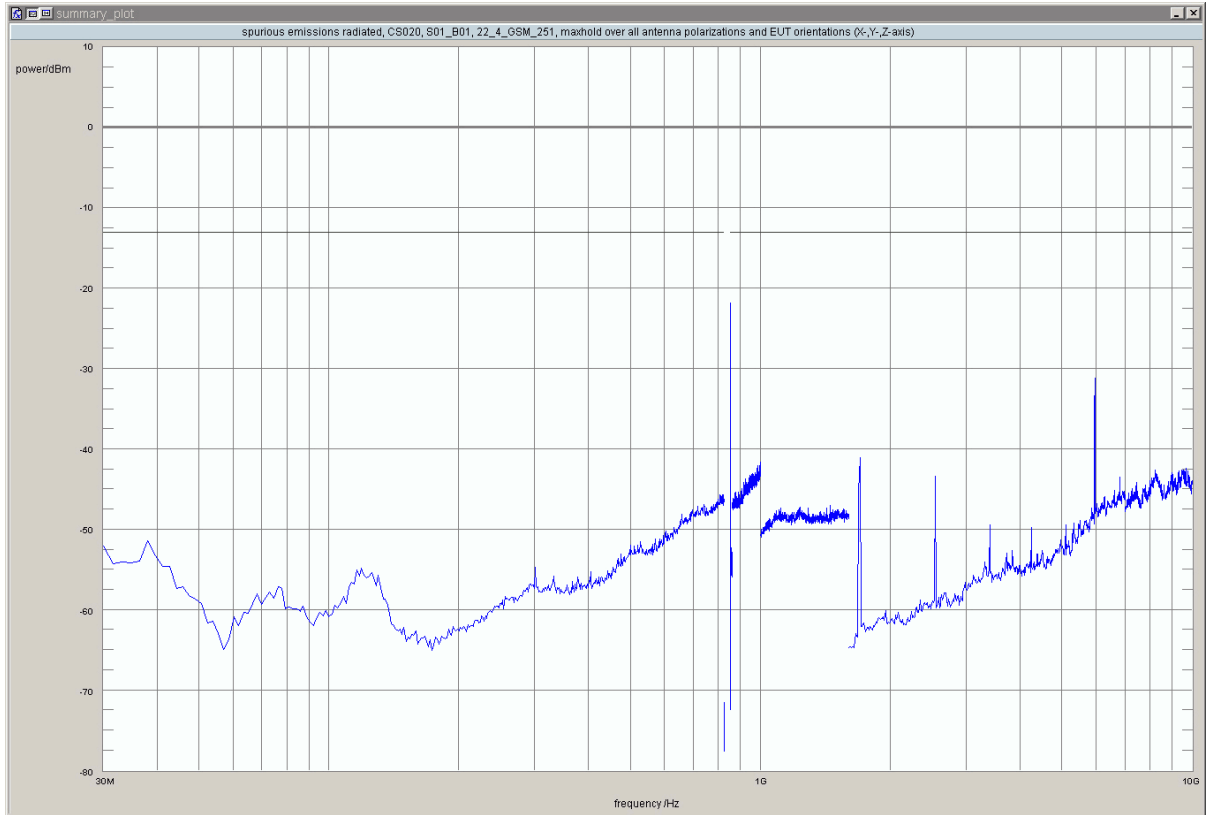

detector	trace	resolution bandwidth /kHz	frequency /MHz	peak value /dBm	limit /dBm	margin to limit /dB	azimuth /°	antenna polarization	EUT orientation	verdict
peak	maxhold	3	849.0000	-24.43	-13.00	11.43	90.0	horizontal	vertical	passed
peak	maxhold	3	849.0080	-23.59	-13.00	10.59	0.0	vertical	horizontal	passed
peak	maxhold	3	849.0200	-21.83	-13.00	8.83	0.0	vertical	horizontal	passed
peak	maxhold	3	849.0321	-26.22	-13.00	13.22	0.0	horizontal	horizontal	passed
peak	maxhold	3	849.0361	-25.59	-13.00	12.59	-180.0	vertical	horizontal	passed
peak	maxhold	3	849.0461	-28.16	-13.00	15.16	0.0	vertical	horizontal	passed
peak	maxhold	3	849.0541	-27.26	-13.00	14.26	0.0	vertical	horizontal	passed
peak	maxhold	3	849.0601	-29.41	-13.00	16.41	90.0	horizontal	vertical	passed
peak	maxhold	3	849.0661	-32.49	-13.00	19.49	-180.0	vertical	horizontal	passed
peak	maxhold	1000	5950.3	-31.11	-13.00	18.11	120.0	vertical	horizontal	passed

no further values have been found with a margin of less than 20 dB

Peak at 849 MHz is generated by base station simulator and not EUT

**3.5.5      22.5      Emission and Occupied Bandwidth §2.1049, §22.917**

**Test: 22.5; Frequency Band = 850, Mode = GSM, Channel = 128, Frequency = 824.2MHz**

<i>Result:</i>	Passed
<i>Setup No.:</i>	S01_A01
<i>Date of Test:</i>	2012/06/05 8:47
<i>Body:</i>	FCC47CFRChIPART22PUBLIC MOBILE SERVICES
<i>Test Specification:</i>	FCC part 2 and 22



**Detailed Results:**

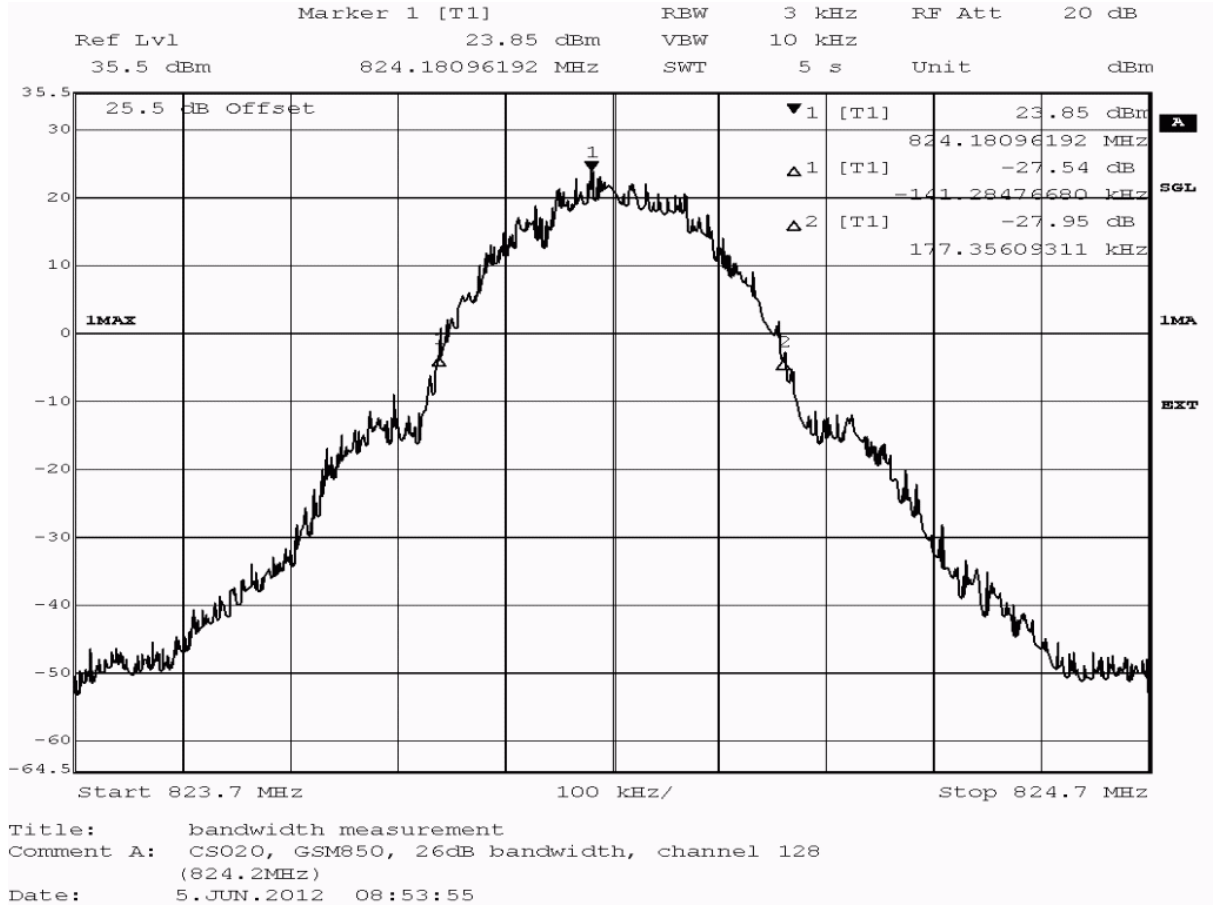

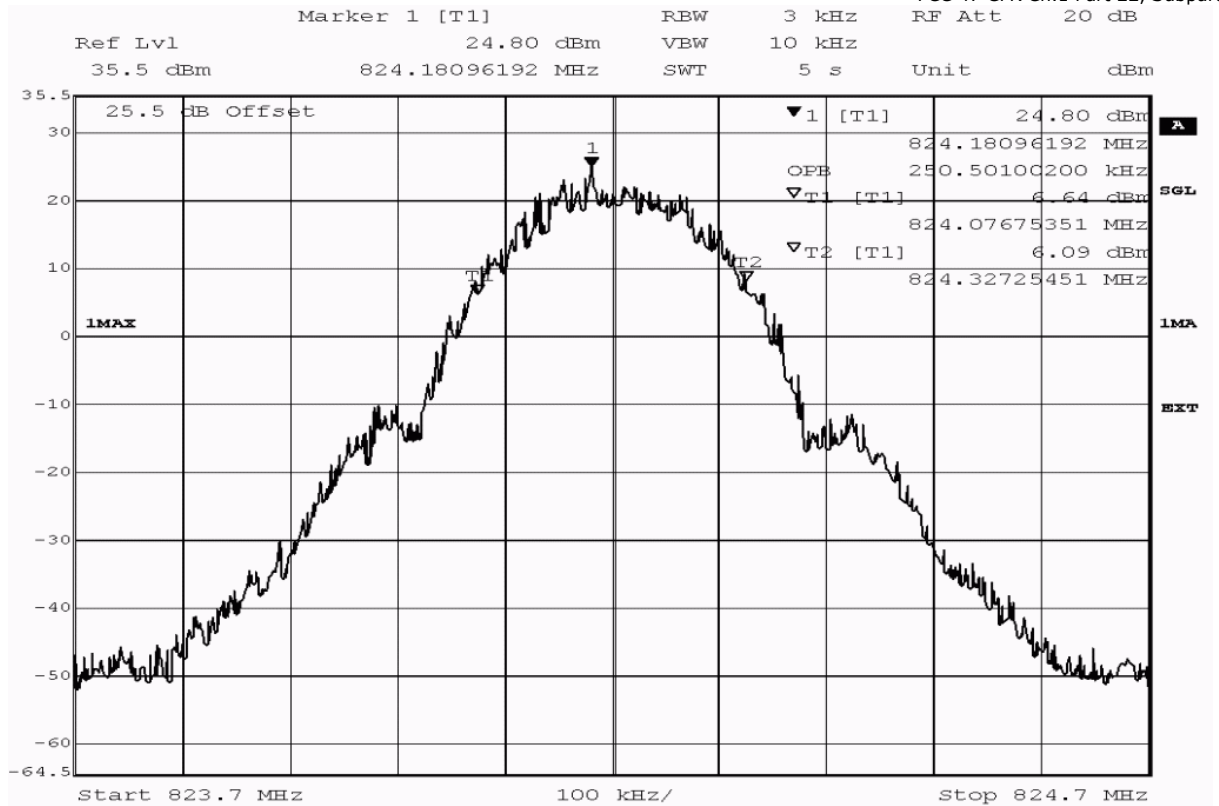

Title: bandwidth measurement  
 Comment A: CS020, GSM850, occupied bandwidth (99%),  
 channel 128 (824.2MHz)  
 Date: 5.JUN.2012 08:54:13

detector	trace	resolution bandwidth /kHz	type of measurement	measured value /kHz	verdict
peak	maxhold	3	-26dB bandwidth	318.6	passed
peak	maxhold	3	99% bandwidth	250.5	passed

**Test: 22.5; Frequency Band = 850, Mode = GSM, Channel = 190, Frequency = 836.6MHz**

*Result:* Passed

*Setup No.:* S01\_A01

*Date of Test:* 2012/06/05 8:41

*Body:* FCC47CFRChIPART22PUBLIC MOBILE SERVICES

*Test Specification:* FCC part 2 and 22

**Detailed Results:**

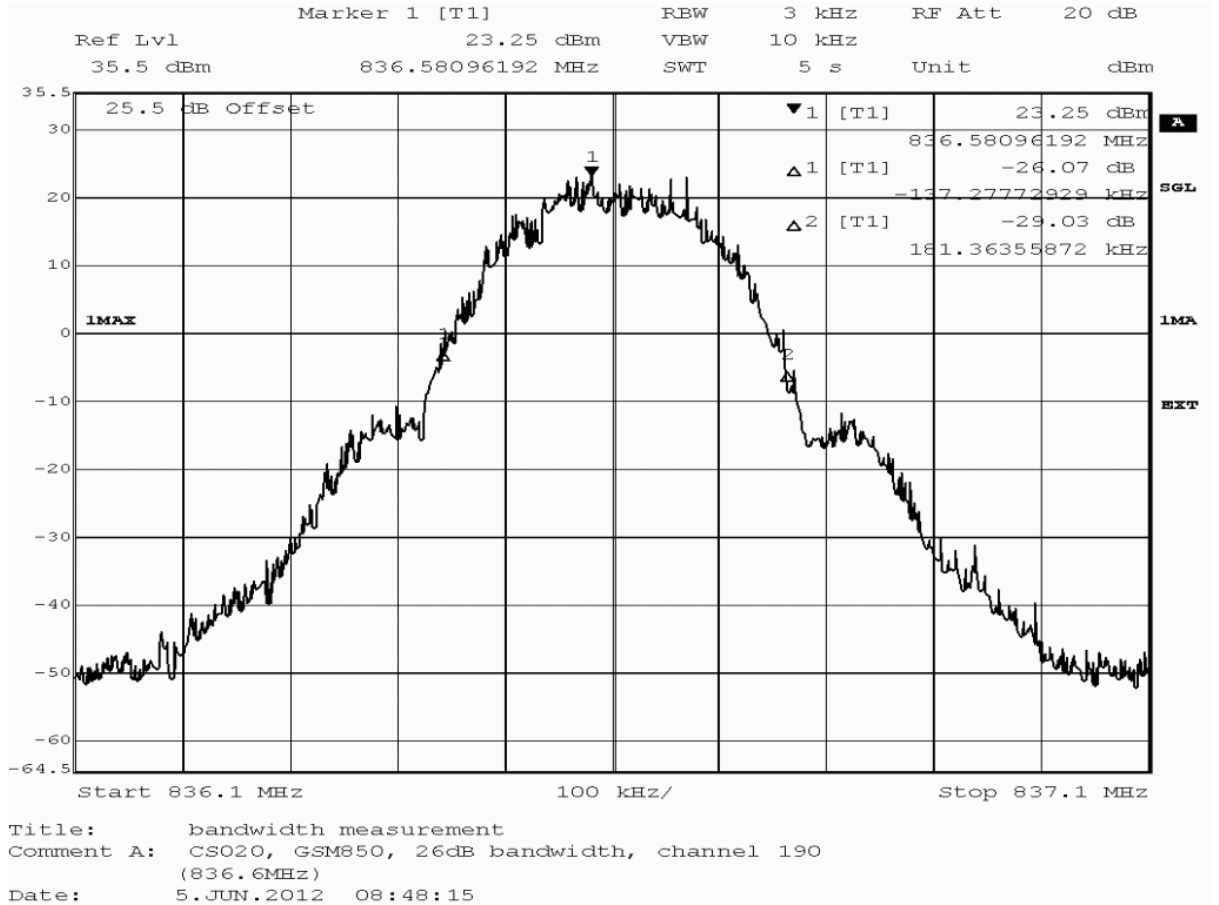

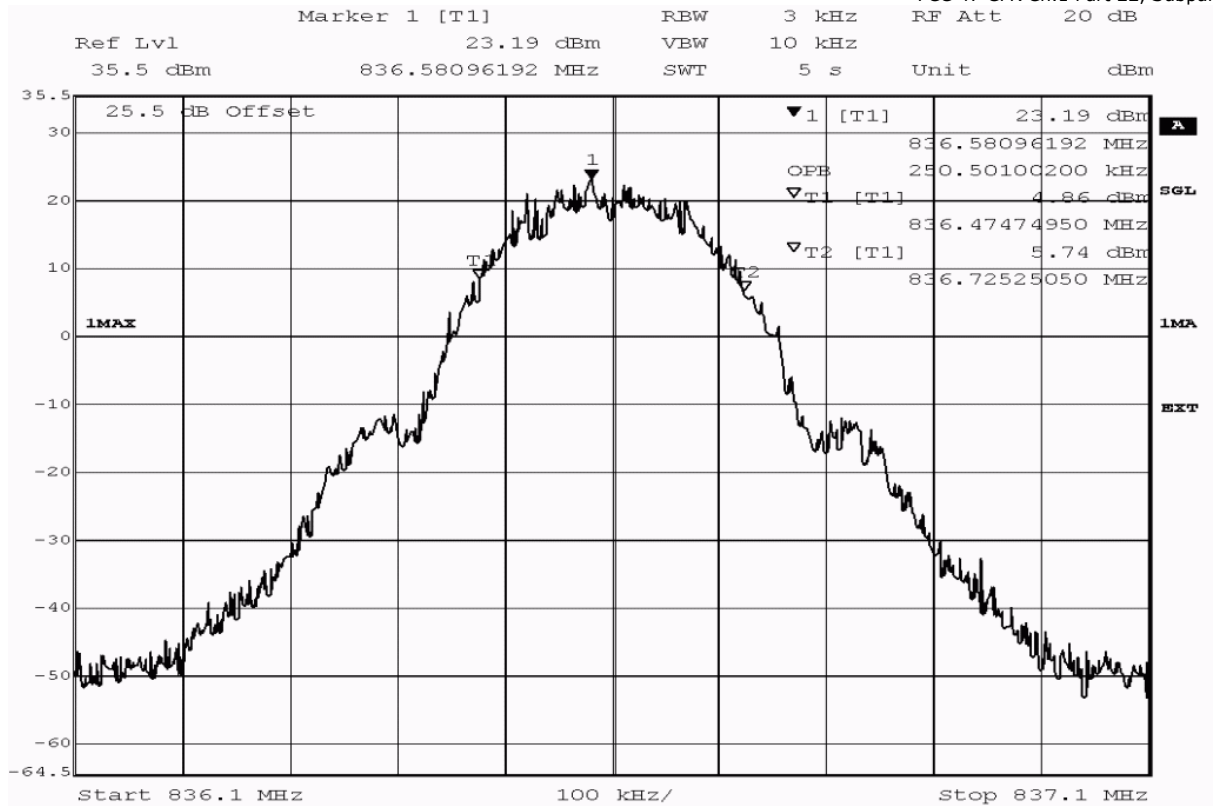

Title: bandwidth measurement  
 Comment A: CS020, GSM850, occupied bandwidth (99%),  
 channel 190 (836.6MHz)  
 Date: 5.JUN.2012 08:48:33

detector	trace	resolution bandwidth /kHz	type of measurement	measured value /kHz	verdict
peak	maxhold	3	-26dB bandwidth	318.6	passed
peak	maxhold	3	99% bandwidth	250.5	passed

**Test: 22.5; Frequency Band = 850, Mode = GSM, Channel = 251, Frequency = 848.8MHz**

*Result:* Passed

*Setup No.:* S01\_A01

*Date of Test:* 2012/06/05 8:50

*Body:* FCC47CFRChIPART22PUBLIC MOBILE SERVICES

*Test Specification:* FCC part 2 and 22

**Detailed Results:**

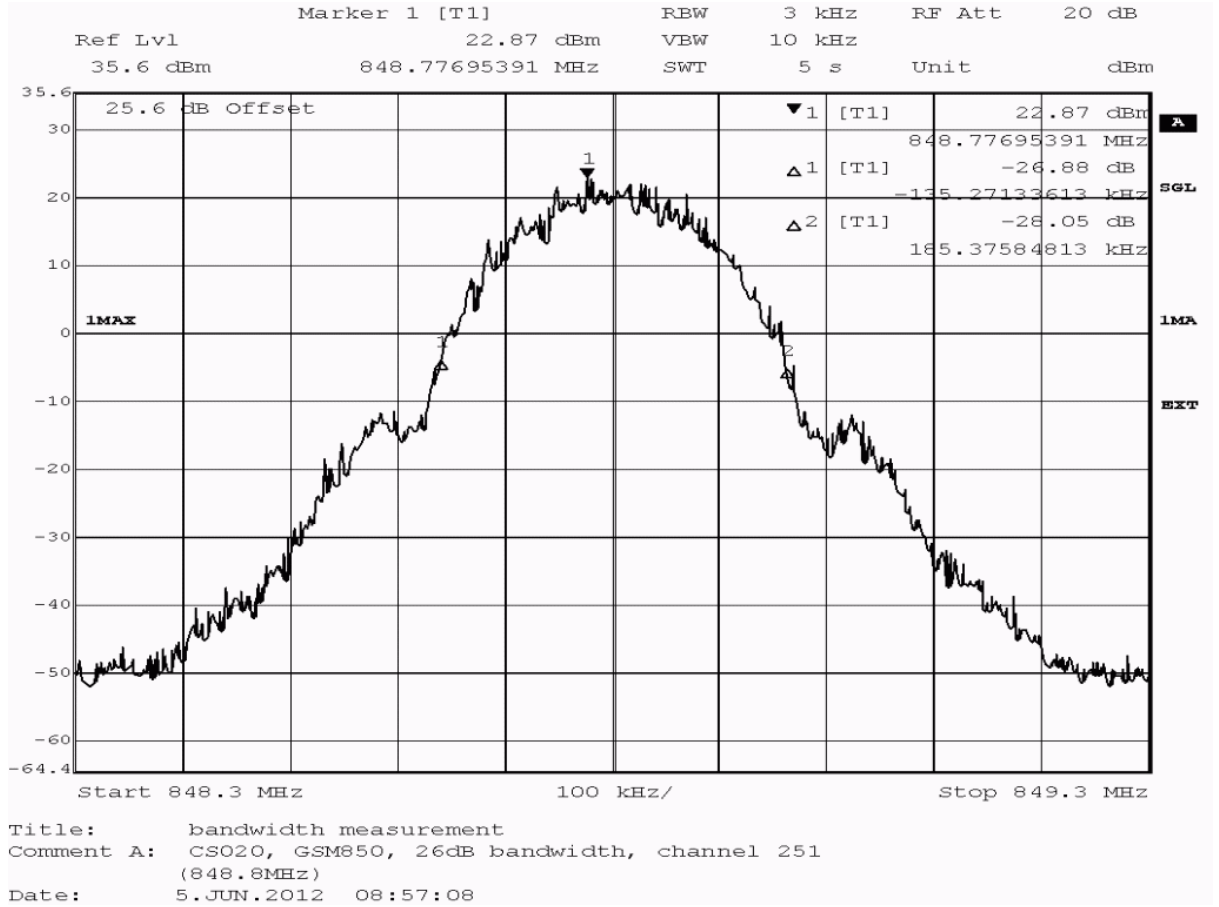

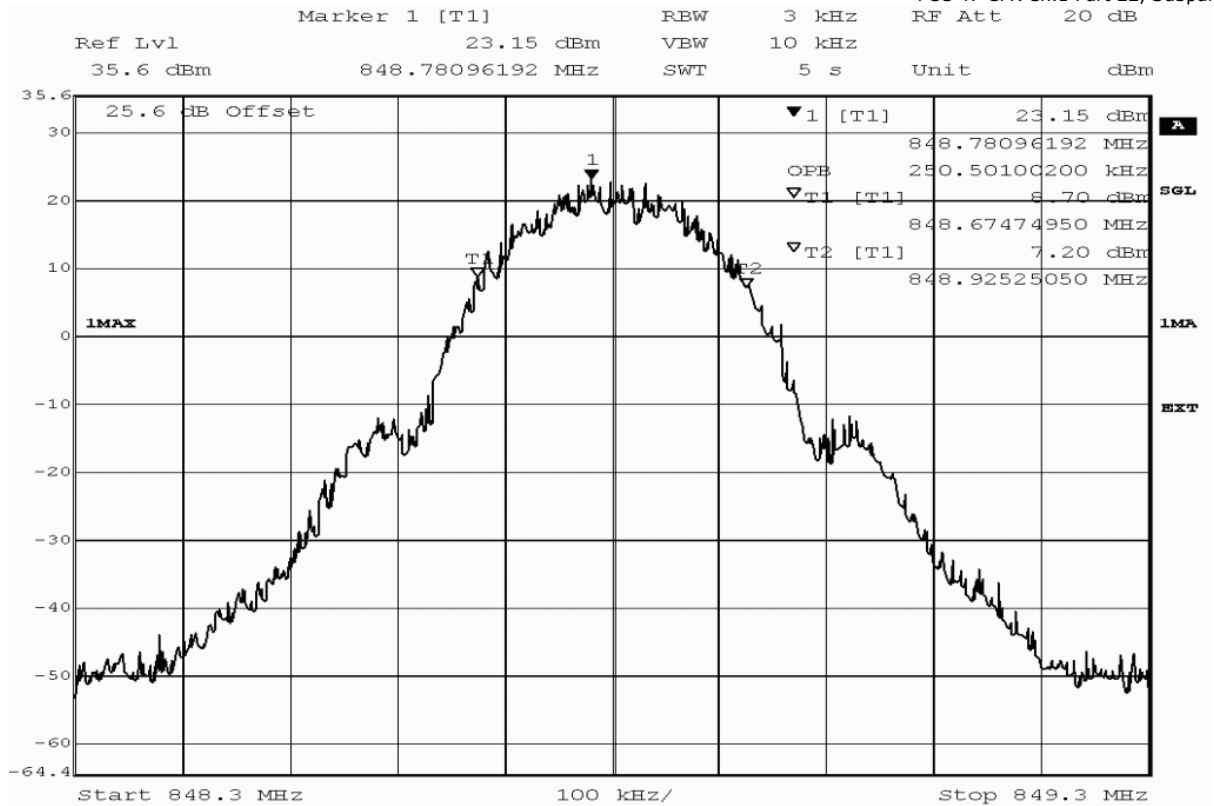

Title: bandwidth measurement  
 Comment A: CS020, GSM850, occupied bandwidth (99%),  
 channel 251 (848.8MHz)  
 Date: 5.JUN.2012 08:57:26



detector	trace	resolution bandwidth /kHz	type of measurement	measured value /kHz	verdict
peak	maxhold	3	-26dB bandwidth	320.6	passed
peak	maxhold	3	99% bandwidth	250.5	passed

**3.5.6      22.6      Band edge compliance §2.1053, §22.917**

**Test: 22.6; Frequency Band = 850, Mode = GSM, Channel = 128, Frequency = 824.2MHz**

<i>Result:</i>	Passed
<i>Setup No.:</i>	S01_A01
<i>Date of Test:</i>	2012/06/05 9:33
<i>Body:</i>	FCC47CFRChIPART22PUBLIC MOBILE SERVICES
<i>Test Specification:</i>	FCC part 2 and 22

**Detailed Results:**

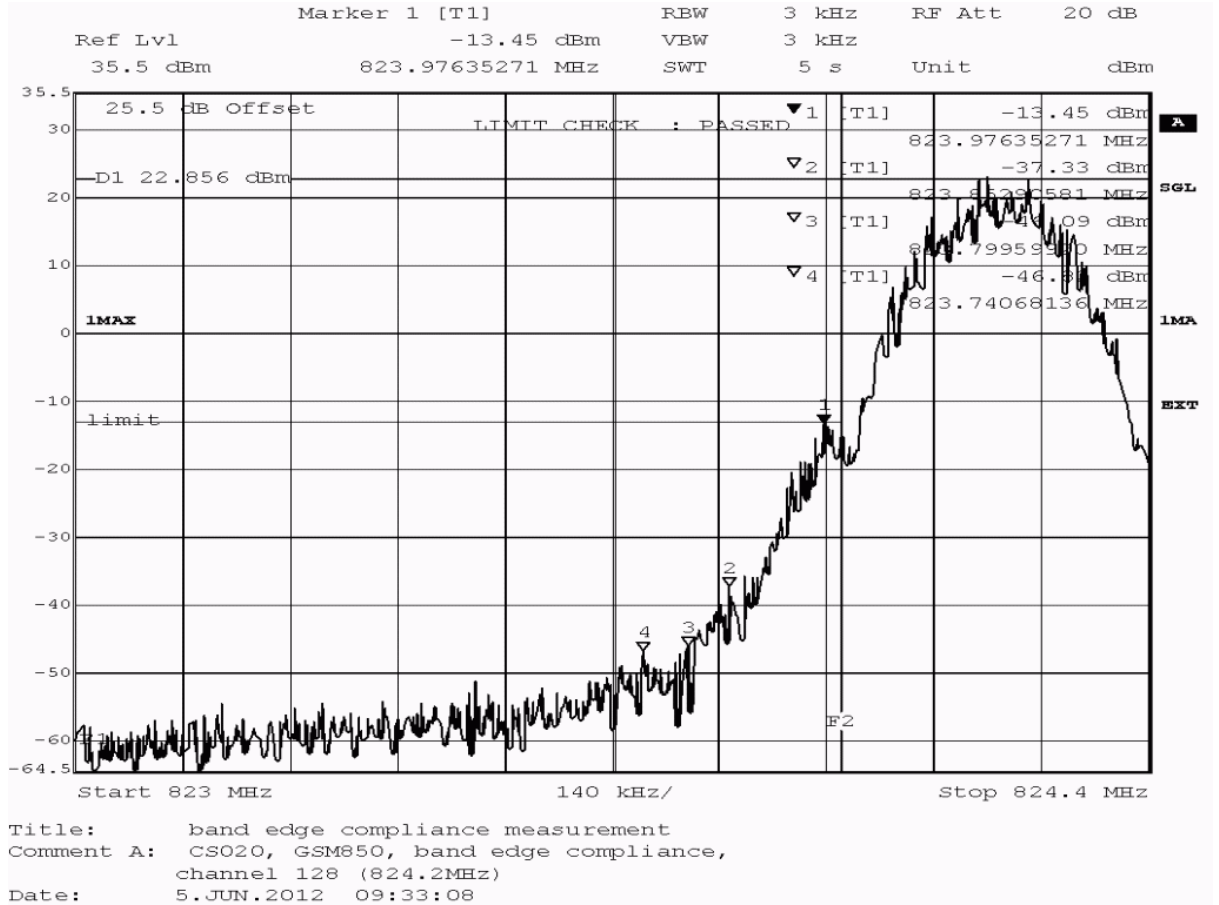

detector	trace	resolution bandwidth /kHz	frequency /MHz	peak value /dBm	margin to limit /dB	limit /dBm	verdict
peak	maxhold	3	823.976	-13.45	0.45	-13.0	passed
average	maxhold	3	823.996	-31.77	18.77	-13.0	passed

no further values have been found by test instrument with a margin of less than 20 dB

**Test: 22.6; Frequency Band = 850, Mode = GSM, Channel = 251, Frequency = 848.8MHz**

*Result:* Passed

*Setup No.:* S01\_A01

*Date of Test:* 2012/06/05 9:45

*Body:* FCC47CFRChIPART22PUBLIC MOBILE SERVICES

*Test Specification:* FCC part 2 and 22

**Detailed Results:**

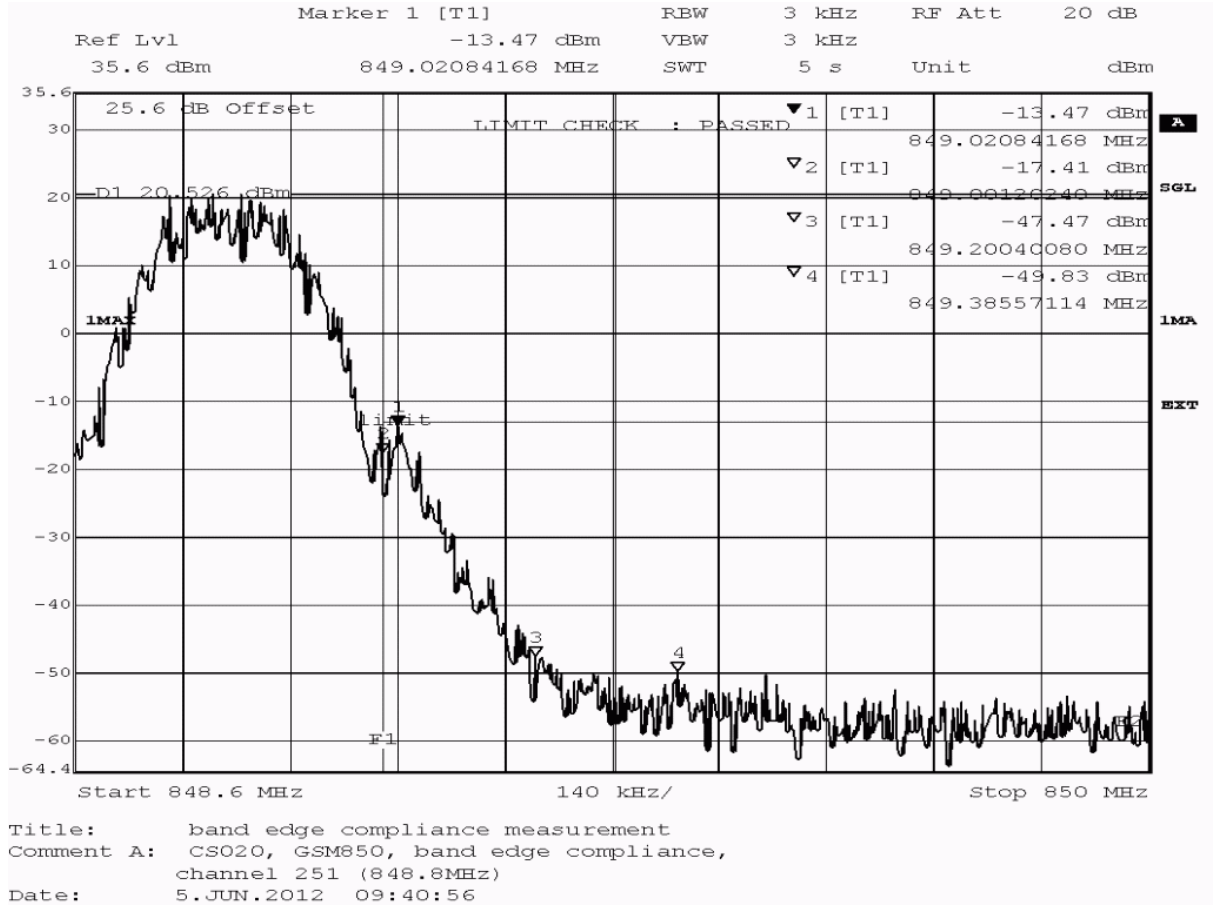

detector	trace	resolution bandwidth /kHz	frequency /MHz	peak value /dBm	margin to limit /dB	limit /dBm	verdict
peak	maxhold	3	849.001	-17.41	4.41	-13.0	passed
peak	maxhold	3	849.021	-13.47	0.47	-13.0	passed

no further values have been found by test instrument with a margin of less than 20 dB

## 4 Test Equipment Details

### 4.1 List of Used Test Equipment

The calibration, hardware and software states are shown for the testing period.

#### Test Equipment Anechoic Chamber

<b>Lab ID:</b>	<b>Lab 1</b>
<i>Manufacturer:</i>	Frankonia
<i>Description:</i>	Anechoic Chamber for radiated testing
<i>Type:</i>	10.58x6.38x6.00 m <sup>3</sup>

#### Single Devices for Anechoic Chamber

<i>Single Device Name</i>	<i>Type</i>	<i>Serial Number</i>	<i>Manufacturer</i>	
Air compressor	none	-	Atlas Copco	
Anechoic Chamber	10.58 x 6.38 x 6.00 m <sup>3</sup>	none	Frankonia	
	<i>Calibration Details</i>		<i>Last Execution</i>	<i>Next Exec.</i>
	FCC listing 96716 3m Part15/18		2011/01/11	2014/01/10
	IC listing 3699A-1 3m		2011/02/07	2014/02/06
Controller Maturo	MCU	961208	Maturo GmbH	
EMC camera	CE-CAM/1	-	CE-SYS	
EMC camera Nr.2	CCD-400E	0005033	Mitsubishi	
Filter ISDN	B84312-C110-E1		Siemens&Matsushita	
Filter Universal 1A	BB4312-C30-H3	-	Siemens&Matsushita	

#### Test Equipment Auxiliary Equipment for Radiated emissions

<b>Lab ID:</b>	<b>Lab 1</b>
<i>Description:</i>	Equipment for emission measurements
<i>Serial Number:</i>	see single devices

#### Single Devices for Auxiliary Equipment for Radiated emissions

<i>Single Device Name</i>	<i>Type</i>	<i>Serial Number</i>	<i>Manufacturer</i>	
Antenna mast	AS 620 P	620/37	HD GmbH	
Biconical dipole	VUBA 9117	9117-108	Schwarzbeck	
	<i>Calibration Details</i>		<i>Last Execution</i>	<i>Next Exec.</i>
	Standard Calibration		2008/10/27	2013/10/26
	Standard Calibration		2012/01/18	2015/01/17
Broadband Amplifier 18MHz-26GHz	JS4-18002600-32-5P	849785	Miteq	
Broadband Amplifier 1GHz-4GHz	AFS4-01000400-1Q-10P-4	-	Miteq	
Broadband Amplifier 30MHz-18GHz	JS4-00101800-35-5P	896037	Miteq	
Cable "ESI to EMI Antenna"	EcoFlex10	W18.01- 2+W38.01-2	Kabel Kusch	
Cable "ESI to Horn Antenna"	UFB311A+UFB293C	W18.02- 2+W38.02-2	Rosenberger Micro-Coax	
Double-ridged horn	HF 906	357357/001	Rohde & Schwarz GmbH & Co. KG	
	<i>Calibration Details</i>		<i>Last Execution</i>	<i>Next Exec.</i>
	Standard Calibration		2012/05/18	2015/05/17

**Single Devices for Auxiliary Equipment for Radiated emissions (continued)**

<i>Single Device Name</i>	<i>Type</i>	<i>Serial Number</i>	<i>Manufacturer</i>	
Double-ridged horn	HF 906	357357/002	Rohde & Schwarz GmbH & Co. KG	
High Pass Filter	4HC1600/12750-1.5-KK	9942011	Trilithic	
High Pass Filter	5HC2700/12750-1.5-KK	9942012	Trilithic	
High Pass Filter	5HC3500/12750-1.2-KK	200035008	Trilithic	
High Pass Filter	WHKX 7.0/18G-8SS	09	Wainwright	
Log.-per. Antenna	HL 562 Ultralog	830547/003	Rohde & Schwarz GmbH & Co. KG	
Loop Antenna	HFH2-Z2	829324/006	Rohde & Schwarz GmbH & Co. KG	
<i>Calibration Details</i>			<i>Last Execution</i>	<i>Next Exec.</i>
Standard calibration			2011/10/27	2014/10/26
Pyramidal Horn Antenna 26,5 GHz	3160-09	00083069	EMCO Elektronik GmbH	
Pyramidal Horn Antenna 40 GHz	3160-10	00086675	EMCO Elektronik GmbH	
Tilt device Maturo (Rohacell)	Antrieb TD1.5-10kg	TD1.5-10kg/024/3790709	Maturo GmbH	

**Test Equipment Auxiliary Test Equipment**

<b>Lab ID:</b>	<b>Lab 1, Lab 2</b>
<i>Manufacturer:</i>	see single devices
<i>Description:</i>	Single Devices for various Test Equipment
<i>Type:</i>	various
<i>Serial Number:</i>	none

**Single Devices for Auxiliary Test Equipment**

<i>Single Device Name</i>	<i>Type</i>	<i>Serial Number</i>	<i>Manufacturer</i>	
Broadband Power Divider N (Aux)	1506A / 93459	LM390	Weinschel Associates	
Broadband Power Divider SMA	WA1515	A855	Weinschel Associates	
Digital Multimeter 03 (Multimeter)	Fluke 177	86670383	Fluke Europe B.V.	
<i>Calibration Details</i>			<i>Last Execution</i>	<i>Next Exec.</i>
Customized calibration			2011/10/19	2013/10/18
Fibre optic link Satellite (Aux)	FO RS232 Link	181-018	Pontis	
Fibre optic link Transceiver (Aux)	FO RS232 Link	182-018	Pontis	
Isolating Transformer	LTS 604	1888	Thalheimer Transformatorenwerke GmbH	
Notch Filter Ultra Stable (Aux)	WRCA800/960-6EEK	24	Wainwright	
Vector Signal Generator	SMIQ 03B	832492/061	Rohde & Schwarz GmbH & Co.KG	



### Test Equipment Digital Signalling Devices

**Lab ID:** Lab 1, Lab 2  
**Description:** Signalling equipment for various wireless technologies.

#### Single Devices for Digital Signalling Devices

Single Device Name	Type	Serial Number	Manufacturer	
Bluetooth Signalling Unit CBT	CBT	100589	Rohde & Schwarz GmbH & Co. KG	
	<i>Calibration Details</i>		<i>Last Execution</i>	<i>Next Exec.</i>
	Standard calibration		2011/11/24	2014/11/23
CMW500	CMW500	107500	Rohde & Schwarz GmbH & Co. KG	
	<i>Calibration Details</i>		<i>Last Execution</i>	<i>Next Exec.</i>
	Initial factory calibration		2012/01/26	2014/01/25
	<i>HW/SW Status</i>		<i>Date of Start</i>	<i>Date of End</i>
	Firmware: V.2.01.25		2012/05/07	2012/07/03
	3G : KC42x 11.48.02			
	LTE: KC501 1.6.5 up to 1.9.8			
	KC503 1.6.5 up to 1.9.8			
	KC506 1.9.8			
	KC507 1.7.0			
	KC508 1.8.5 up to 1.9.8			
	KC551 1.4.1 up to 1.9.8			
	KC553 1.5.5 up to 1.9.8			
	KC571 1.8.5 up to 1.9.8			
	KC572 1.8.5 up to 1.9.8			
	---			
Universal Radio Communication Tester	CMU 200	102366	Rohde & Schwarz GmbH & Co. KG	
	<i>Calibration Details</i>		<i>Last Execution</i>	<i>Next Exec.</i>
	Standard calibration		2011/05/26	2013/05/25
	<i>HW/SW Status</i>		<i>Date of Start</i>	<i>Date of End</i>
	Hardware:		2007/07/16	
	B11, B21V14, B21-2, B41, B52V14, B52-2, B53-2, B56V14, B68 3v04, PCMCIA, U65V04			
	Software:			
	K21 4v21, K22 4v21, K23 4v21, K24 4v21, K42 4v21, K43 4v21, K53 4v21, K56 4v22, K57 4v22, K58 4v22, K59 4v22, K61 4v22, K62 4v22, K63 4v22, K64 4v22, K65 4v22, K66 4v22, K67 4v22, K68 4v22, K69 4v22			
	Firmware:			
	µP1 8v50 02.05.06			
	---			
Universal Radio Communication Tester	CMU 200	837983/052	Rohde & Schwarz GmbH & Co. KG	
	<i>Calibration Details</i>		<i>Last Execution</i>	<i>Next Exec.</i>
	Standard calibration		2011/12/07	2014/12/06
	<i>HW/SW Status</i>		<i>Date of Start</i>	<i>Date of End</i>
	HW options:		2007/01/02	
	B11, B21V14, B21-2, B41, B52V14, B52-2, B53-2, B54V14, B56V14, B68 3v04, B95, PCMCIA, U65V02			
	SW options:			
	K21 4v11, K22 4v11, K23 4v11, K24 4v11, K27 4v10, K28 4v10, K42 4v11, K43 4v11, K53 4v10, K65 4v10, K66 4v10, K68 4v10,			
	Firmware:			
	µP1 8v40 01.12.05			
	---			
	SW:		2008/11/03	
	K62, K69			

**Test Equipment Emission measurement devices**

**Lab ID:** **Lab 1**  
*Description:* Equipment for emission measurements  
*Serial Number:* see single devices

**Single Devices for Emission measurement devices**

<i>Single Device Name</i>	<i>Type</i>	<i>Serial Number</i>	<i>Manufacturer</i>	
Personal Computer	Dell	30304832059	Dell	
Power Meter	NRVD	828110/016	Rohde & Schwarz GmbH & Co.KG	
	<i>Calibration Details</i>		<i>Last Execution</i>	<i>Next Exec.</i>
	Standard calibration		2012/05/22	2013/05/21
Sensor Head A	NRV-Z1	827753/005	Rohde & Schwarz GmbH & Co.KG	
	<i>Calibration Details</i>		<i>Last Execution</i>	<i>Next Exec.</i>
	Standard calibration		2012/05/21	2013/05/20
Signal Generator	SMR 20	846834/008	Rohde & Schwarz GmbH & Co. KG	
	<i>Calibration Details</i>		<i>Last Execution</i>	<i>Next Exec.</i>
	standard calibration		2011/05/12	2014/05/11
Spectrum Analyzer	ESIB 26	830482/004	Rohde & Schwarz GmbH & Co. KG	
	<i>Calibration Details</i>		<i>Last Execution</i>	<i>Next Exec.</i>
	Standard Calibration		2011/12/05	2013/12/04
	<i>HW/SW Status</i>		<i>Date of Start</i>	<i>Date of End</i>
	Firmware-Update 4.34.4 from 3.45 during calibration		2009/12/03	

### Test Equipment Radio Lab Test Equipment

**Lab ID:** **Lab 2**  
*Description:* Radio Lab Test Equipment

#### Single Devices for Radio Lab Test Equipment

<i>Single Device Name</i>	<i>Type</i>	<i>Serial Number</i>	<i>Manufacturer</i>	
Broadband Power Divider SMA	WA1515	A856	Weinschel Associates	
Coax Attenuator 10dB SMA 2W	4T-10	F9401	Weinschel Associates	
Coax Attenuator 10dB SMA 2W	56-10	W3702	Weinschel Associates	
Coax Attenuator 10dB SMA 2W	56-10	W3711	Weinschel Associates	
Coax Cable Huber&Suhner	Sucotest 2,0m		Rosenberger Micro-Coax	
Coax Cable Rosenberger Micro Coax FA210A0010003030 SMA/SMA 1,0m	FA210A0010003030	54491-2	Rosenberger Micro-Coax	
Power Meter	NRVD	828110/016	Rohde & Schwarz GmbH & Co.KG	
	<i>Calibration Details</i>		<i>Last Execution</i>	<i>Next Exec.</i>
	Standard calibration		2012/05/22	2013/05/21
RF Step Attenuator RSP	RSP	833695/001	Rohde & Schwarz GmbH & Co.KG	
Rubidium Frequency Standard	Datum, Model: MFL	2689/001	Datum-Beverly	
	<i>Calibration Details</i>		<i>Last Execution</i>	<i>Next Exec.</i>
	Standard calibration		2011/06/17	2012/06/16
Sensor Head A	NRV-Z1	827753/005	Rohde & Schwarz GmbH & Co.KG	
	<i>Calibration Details</i>		<i>Last Execution</i>	<i>Next Exec.</i>
	Standard calibration		2012/05/21	2013/05/20
Signal Generator	SMY02	829309/018	Rohde & Schwarz GmbH & Co. KG	
	<i>Calibration Details</i>		<i>Last Execution</i>	<i>Next Exec.</i>
	Standard calibration		2011/11/04	2014/11/03
Signal Generator SME	SME03	827460/016	Rohde & Schwarz GmbH & Co.KG	
	<i>Calibration Details</i>		<i>Last Execution</i>	<i>Next Exec.</i>
	Standard calibration		2011/11/25	2014/11/24
Signal Generator SMP	SMP02	836402/008	Rohde & Schwarz GmbH & Co. KG	
Spectrum Analyser	FSIQ26	840061/005	Rohde & Schwarz GmbH & Co. KG	
	<i>Calibration Details</i>		<i>Last Execution</i>	<i>Next Exec.</i>
	Standard calibration		2011/02/10	2013/02/09
Temperature Chamber Vötsch 03	VT 4002	58566002150010	Vötsch	
	<i>Calibration Details</i>		<i>Last Execution</i>	<i>Next Exec.</i>
	Customized calibration		2012/03/12	2014/03/11



---

Reference: MDE\_NXP\_1201\_FCCc  
According to:  
FCC 47 CFR Ch.1 Part 22, Subpart H

**5 Annex**

**5.1 Additional Information for Report**

#### Summary of Test Results

---

---

The EUT complied with all performed tests as listed in the summary section of this report.

---

#### Technical Report Summary

---

---

#### Type of Authorization :

Certification for a GSM/WCDMA/CDMA2000 cellular radiotelephone device

#### Applicable FCC Rules

Prepared in accordance with the requirements of FCC Rules and Regulations as listed in 47 CFR Ch.1 Parts 0 to 69. The following subparts are applicable to the results in this test report.

#### Part 2, Subpart J - Equipment Authorization Procedures, Certification

- § 2.1046 Measurement required: RF power output
- § 2.1049 Measurement required: Occupied bandwidth
- § 2.1051 Measurement required: Spurious emissions at antenna terminals
- § 2.1053 Measurement required: Field strength of spurious radiation
- § 2.1055 Measurement required: Frequency stability
- § 2.1057 Frequency spectrum to be investigated

#### Part 22, Subpart C – Operational and Technical Requirements

- § 22.355 Frequency tolerance

#### Part 22, Subpart H – Cellular Radiotelephone Service

- § 22.913 Effective radiated power limits
- § 22.917 Emission limitations for cellular equipment

#### additional documents

ANSI TIA-603-C-2004

#### Description of Methods of Measurements

---

---

#### RF Power Output

---

Standard      FCC Part 22, Subpart H

The test was performed according to: FCC §2.1046

#### Test Description (conducted measurement procedure)

- 1) The EUT was coupled to a Spectrum Analyser and a Digital Communication Tester through a Power Divider. Refer to chapter "Setup Drawings".
  - 2) The total insertion losses for signal path 1 and signal path 2 were measured. The values were used to correct the readings from the Spectrum Analyser and the Digital Communication Tester.
  - 3) A call was established on a Traffic Channel between the EUT and the Digital Communication Tester.
- Important Settings:
- Channel (Frequency): please refer to the detailed results
- 4) The transmitted power of the EUT was recorded by using a spectrum analyser.

#### Test Description (radiated measurement procedure)

- 1) The EUT was placed inside an anechoic chamber. Refer to chapter "Setup Drawings". The EUT was coupled to a Digital Communication Tester which was located outside the chamber via a small signalling antenna.
  - 2) A call was established on a Traffic Channel between the EUT and the Digital Communication Tester.
- Important Settings:
- Output Power: Maximum
  - Channel: please refer to the detailed results
- 3) A substitution procedure is used so that the readings from the spectrum analyser are corrected and represent directly the equivalent radiated power (related to a  $\lambda/2$  dipole).
  - 4) The output power was measured in both vertical and horizontal antenna polarisation during the call is established on the lowest channel, mid channel and on the highest channel. To find the worst case power all orientations (X, Y, Z) of the EUT have been measured.
  - 5) The test procedure according to TIA-603-C-2004 has been considered.

#### Test Requirements / Limits

##### §2.1046 Measurements Required: RF Power Output

(a) For transmitters other than single sideband, independent sideband and controlled carrier radiotelephone, power output shall be measured at the RF output terminals when the transmitter is adjusted in accordance with the tune-up procedure to give the values of current and voltage on the circuit elements specified in § 2.1033(c)(8). The electrical characteristics of the output terminals when this test is made shall be stated.

##### §2.913 Effective radiated power limits

(a)(2) Maximum ERP. ... The ERP of mobile transmitters and auxiliary test transmitters must not exceed 7 Watts.

---

#### Emission and Occupied Bandwidth

---

Standard      FCC Part 22, Subpart H

The test was performed according to: FCC §2.1049

#### Test Description

- 1) The EUT was coupled to a Spectrum Analyser and a Digital Communication Tester through a Power Divider. Refer to chapter "Setup Drawings".
  - 2) The total insertion losses for signal path 1 and signal path 2 were measured. The values were used to correct the readings from the Spectrum Analyser and the Digital Communication Tester.
  - 3) A call was established on a Traffic Channel between the EUT and the Digital Communication Tester.
- Important Settings:
- Output Power: Maximum
  - Channel: please refer to the detailed results
- 4) Important Analyser Settings:
    - Resolution Bandwidth: >1% of the manufacturer's stated occupied bandwidth
  - 5) The maximum spectral level of the modulated signal was recorded as the reference.
  - 6) The emission bandwidth is measured as follows:  
the two furthest frequencies above and below the frequency of the maximum reference level where the spectrum is -26 dB down have to be found.
  - 7) The occupied bandwidth (99% Bandwidth) is measured as follows:  
the occupied bandwidth, that is the frequency bandwidth such that, below its lower and above its upper

frequency limits, the mean powers are each equal to 0.5 percent of the total mean power.

#### Test Requirements / Limits

##### § 2.1049 Measurements required: Occupied bandwidth

The occupied bandwidth, that is the frequency bandwidth such that, below its lower and above its upper frequency limits, the mean powers radiated are each equal to 0.5 percent of the total mean power radiated by a given emission shall be measured under the following conditions (as applicable):

(h) Transmitters employing digital modulation techniques - when modulated by an input signal such that its amplitude and symbol rate represent the maximum rated conditions under which the equipment will be operated. The signal shall be applied through any filter networks, pseudo-random generators or other devices required in normal service. Additionally, the occupied bandwidth shall be shown for operation with any devices used for modifying the spectrum when such devices are optional at the discretion of the user.

---

#### Spurious emissions at antenna terminals

---

Standard      FCC Part 22, Subpart H

The test was performed according to FCC §2.1051

#### Test Description

- 1) The EUT was coupled to a Spectrum Analyser and a Digital Communication Tester through a Power Divider. Refer to chapter "Setup Drawings".
- 2) The total insertion losses for signal path 1 and signal path 2 were measured. The values were used to correct the readings from the Spectrum Analyser and the Digital Communication Tester.
- 3) A call was established on a Traffic Channel between the EUT and the Digital Communication Tester.  
Important Settings:
  - Output Power: Maximum
  - Channel: please refer to the detailed results
- 4) Important Analyser Settings
  - [Resolution Bandwidth]:
    - a) [ $\geq 1\%$  of wanted signal bandwidth] in the Span of 1 MHz directly below and above the PCS-Band,
    - b) otherwise [100 kHz] (or [1 MHz] for accelerated sweep times)
    - c) [reduced resolution bandwidth] in case the curve of the analyser IF-Filter or the wanted EUT signal leads to an exceeding of the limit, in this case a correction factor was used
  - Sweep Time: depending on the transmitting signal, the span and the resolution bandwidth
- 5) The spurious emissions peaks were measured in the frequency range from 9 kHz to 10 GHz (up to the 10th harmonic) during the call was established

#### Test Requirements / Limits

##### § 2.1051 Spurious emissions at antenna terminals

The radio frequency voltage or power generated within the equipment and appearing on a spurious frequency shall be checked at the equipment output terminals when properly loaded with a suitable artificial antenna. Curves or equivalent data shall show the magnitude of each harmonic and other spurious emission that can be detected when the equipment is operated under the conditions specified in Sec. 2.1049 as appropriate. The magnitude of spurious emissions which are attenuated more than 20 dB below the permissible value need not be specified.

##### § 2.1057 Frequency spectrum to be investigated.

- (a) In all of the measurements set forth in Secs. 2.1051 and 2.1053, the spectrum shall be investigated from the lowest radio frequency signal generated in the equipment, without going below 9 kHz, up to at least the frequency shown below:
- (1) If the equipment operates below 10 GHz: to the tenth harmonic of the highest fundamental frequency or to 40 GHz, whichever is lower.
  - (b) Particular attention should be paid to harmonics and subharmonics of the carrier frequency as well as to those frequencies removed from the carrier by multiples of the oscillator frequency. Radiation at the

frequencies of multiplier stages should also be checked.

(c) The amplitude of spurious emissions which are attenuated more than 20 dB below the permissible value need not be reported.

(d) Unless otherwise specified, measurements above 40 GHz shall be performed using a minimum resolution bandwidth of 1 MHz.

#### § 22.917 Emission limitations for cellular equipment

(a) The power of any emission outside of the authorized operating frequency ranges must be attenuated below the transmitting power (P) by a factor of at least  $43 + 10 \log(P)$  dB.

Remark of the test laboratory: This is calculated to be -13 dBm.

(b) Compliance with these rules is based on the use of measurement instrumentation employing a resolution bandwidth of 100 kHz or greater. In the 1 MHz bands immediately outside and adjacent to the frequency block a resolution bandwidth of at least one percent of the emission bandwidth of the fundamental emission of the transmitter may be employed. A narrower resolution bandwidth is permitted in all cases to improve measurement accuracy provided the measured power is integrated over the full required measurement bandwidth (i.e. 100 kHz or 1 percent of emission bandwidth, as specified). The emission bandwidth is defined as the width of the signal between two points, one below the carrier center frequency and one above the carrier center frequency, outside of which all emissions are attenuated at least 26 dB below the transmitter power.

(c) Licensees in this service may establish an alternative out of band emission limit to be used at specified band edge(s) in specified geographical areas [...].

(d) If any emission from a transmitter operating in this service results in interference to users of another radio service, the FCC may require a greater attenuation of that emission than specified in this section.

For reporting only spurious emission levels reaching to the 20dB margin to limit were noted.

---

#### Field strength of spurious radiation

---

Standard      FCC Part 22, Subpart H

The test was performed according to: FCC §2.1053

#### Test Description

1) The EUT was placed inside an anechoic chamber. Refer to chapter "Setup Drawings". The EUT was coupled to a Digital Communication Tester which was located outside the chamber via a small signalling antenna.

2) A call was established on a Traffic Channel between the EUT and the Digital Communication Tester.

Important Settings:

- Output Power: Maximum

- Channel: please refer to the detailed results

3) A pre-calibration procedure is used so that the readings from the spectrum analyser are corrected and represent directly the equivalent radiated power (related to a  $\lambda/2$  dipole).

4) All spurious radiation measurements were made with spectrum analyser and the appropriate calibrated antennas for the frequency range of 30 MHz to 10 GHz (up to the 10th harmonic of the transmit frequency). The frequency range from 9 kHz to 30 MHz has been examined during the conducted spurious emission measurements.

5) Important Analyser Settings

- [Resolution Bandwidth / Video Bandwidth]:

a) [3 kHz / 10 kHz] in the Span of 1 MHz directly below and above the Band,

b) [10 kHz / 30 kHz] in case the curve of the analyser IF-Filter leads to an exceeding of the limit, in this case a worst case correction factor of 20 dB (1 MHz -> 10 kHz) was used

c) [1 MHz / 3 MHz] otherwise

- Sweep Time: depending on the transmitting signal, the span and the resolution bandwidth

6) The spurious emissions peaks were measured in both vertical and horizontal antenna polarization during the call is established on the lowest channel, mid channel and on the highest channel. To find the worst case peaks all orientations (X, Y, Z) of the EUT have been measured.

#### Test Requirements / Limits

§ 2.1053 Measurements required: Field strength of spurious radiation.

Measurements shall be made to detect spurious emissions that may be radiated directly from the cabinet,



control circuits, power leads, or intermediate circuit elements under normal conditions of installation and operation. Curves or equivalent data shall be supplied showing the magnitude of each harmonic and other spurious emission. For this test, single sideband, independent sideband, and controlled carrier transmitters shall be modulated under the conditions specified in paragraph (c) of Sec. 2.1049, as appropriate. For equipment operating on frequencies below 890 MHz, an open field test is normally required, with the measuring instrument antenna located in the far-field at all test frequencies. In the event it is either impractical or impossible to make open field measurements (e.g. a broadcast transmitter installed in a building) measurements will be accepted of the equipment as installed. Such measurements must be accompanied by a description of the site where the measurements were made showing the location of any possible source of reflections which might distort the field strength measurements. Information submitted shall include the relative radiated power of each spurious emission with reference to the rated power output of the transmitter, assuming all emissions are radiated from halfwave dipole antennas.

(b) The measurements specified in paragraph (a) of this section shall be made for the following equipment:  
(2) All equipment operating on frequencies higher than 25 MHz.

§ 2.1057 Frequency spectrum to be investigated.

(a) In all of the measurements set forth in Secs. 2.1051 and 2.1053, the spectrum shall be investigated from the lowest radio frequency signal generated in the equipment, without going below 9 kHz, up to at least the frequency shown below:

(1) If the equipment operates below 10 GHz: to the tenth harmonic of the highest fundamental frequency or to 40 GHz, whichever is lower.

(b) Particular attention should be paid to harmonics and subharmonics of the carrier frequency as well as to those frequencies removed from the carrier by multiples of the oscillator frequency. Radiation at the frequencies of multiplier stages should also be checked.

(c) The amplitude of spurious emissions which are attenuated more than 20 dB below the permissible value need not be reported.

(d) Unless otherwise specified, measurements above 40 GHz shall be performed using a minimum resolution bandwidth of 1 MHz.

§ 22.917 Emission limitations for cellular equipment

(a) The power of any emission outside of the authorized operating frequency ranges must be attenuated below the transmitting power (P) by a factor of at least  $43 + 10 \log(P)$  dB.

This is calculated to be -13 dBm (effective radiated power) which corresponds to 84.6 dBµV/m (field strength) in a distance of 3 m.

(b) Compliance with these rules is based on the use of measurement instrumentation employing a resolution bandwidth of 100 kHz or greater. In the 1 MHz bands immediately outside and adjacent to the frequency block a resolution bandwidth of at least one percent of the emission bandwidth of the fundamental emission of the transmitter may be employed. A narrower resolution bandwidth is permitted in all cases to improve measurement accuracy provided the measured power is integrated over the full required measurement bandwidth (i.e. 100 kHz or 1 percent of emission bandwidth, as specified). The emission bandwidth is defined as the width of the signal between two points, one below the carrier center frequency and one above the carrier center frequency, outside of which all emissions are attenuated at least 26 dB below the transmitter power.

(c) Licensees in this service may establish an alternative out of band emission limit to be used at specified band edge(s) in specified geographical areas [...].

(d) If any emission from a transmitter operating in this service results in interference to users of another radio service, the FCC may require a greater attenuation of that emission than specified in this section.

For reporting only spurious emission levels reaching to the 20dB margin to limit were noted.

---

Frequency stability

---

Standard      FCC Part 22, Subpart H

The test was performed according to FCC §2.1055

Test Description

- 1) The EUT was placed inside a temperature chamber.
- 2) The EUT was coupled to a Digital Communication Tester. Refer to chapter "Setup Drawings".
- 3) The climatic chamber was cycled down/up to a certain temperature, starting with the EUT minimum

temperature.

4) After the temperature was stabilized the EUT was switched on and a call was established on a Traffic Channel between the EUT and the Digital Communication Tester.

Important Settings:

- Output Power: Maximum
- Mid Channel

5) The frequency error of the EUT was recorded by using an internal measurement function of the Digital Communication Tester immediately after the call was established, five minutes after the call was established and ten minutes after the call was established.

6) This measurement procedure was performed for temperature variation from -30°C to +50°C in increments of 10°C, if not otherwise stated in the detailed results.

When the EUT did not operate at certain temperature levels, these measurements were left out.

#### Test Requirements / Limits

§2.1055 Measurements required: Frequency stability

(a) The frequency stability shall be measured with variation of ambient temperature as follows:

(1) From -30° to +50° centigrade for all equipment except that specified in paragraphs (a) (2) and (3) of this section.

(b) Frequency measurements shall be made at the extremes of the specified temperature range and at intervals of not more than 10° centigrade through the range. A period of time sufficient to stabilize all of the components of the oscillator circuit at each temperature level shall be allowed prior to frequency measurement. The short term transient effects on the frequency of the transmitter due to keying (except for broadcast transmitters) and any heating element cycling normally occurring at each ambient temperature level also shall be shown. Only the portion or portions of the transmitter containing the frequency determining and stabilizing circuitry need be subjected to the temperature variation test.

(d) The frequency stability shall be measured with variation of primary supply voltage as follows:

(1) Vary primary supply voltage from 85 to 115 percent of the nominal value for other than hand carried battery equipment.

(2) For hand carried, battery powered equipment, reduce primary supply voltage to the battery operating end point which shall be specified by the manufacturer.

(3) The supply voltage shall be measured at the input to the cable normally provided with the equipment, or at the power supply terminals if cables are not normally provided. Effects on frequency of transmitter keying (except for broadcast transmitters) and any heating element cycling at the nominal supply voltage and at each extreme also shall be shown.

§22.355 Frequency tolerance

...the carrier frequency of each transmitter in the Public Mobile Service must be maintained within the tolerances given in table C-1 of this section.

Table C-1.- Frequency Tolerance for Transmitters in the Public Mobile Services

Frequency range (MHz)	Base, fixed (ppm)	Mobile up to 3 watts (ppm)	Mobile above 3 watts (ppm)
25 to 50	20.0	20.0	50.0
50 to 450	5.0	5.0	50.0
450 to 512	2.5	5.0	5.0
821 to 896	1.5	2.5	2.5
928 to 929	5.0	n/a	n/a
929 to 960	1.5	n/a	n/a
2110 to 2220	10.0	n/a	n/a

For the mid channel (836.6 MHz) the frequency tolerance is 2.5 ppm (2091.5 Hz).

#### Band edge compliance

Standard FCC Part 22, Subpart H

The test was performed according to: FCC §22.913

#### Test Description

- 1) The EUT was coupled to a Spectrum Analyser and a Digital Communication Tester through a Power Divider. Refer to chapter "Setup Drawings".
  - 2) The total insertion losses for signal path 1 and signal path 2 were measured. The values were used to correct the readings from the Spectrum Analyser and the Digital Communication Tester.
  - 3) A call was established on a Traffic Channel between the EUT and the Digital Communication Tester.
- Important Settings:
- Output Power: Maximum
  - Channel: please refer to the detailed results
- 4) Important Analyser Settings:
- Resolution Bandwidth = Video Bandwidth: >1% of the manufacturer's stated occupied bandwidth

#### Test Requirements / Limits

§ 22.917 Emission limitations for cellular equipment

Refer to chapter "Field strength of spurious radiation".

#### Setup Drawings

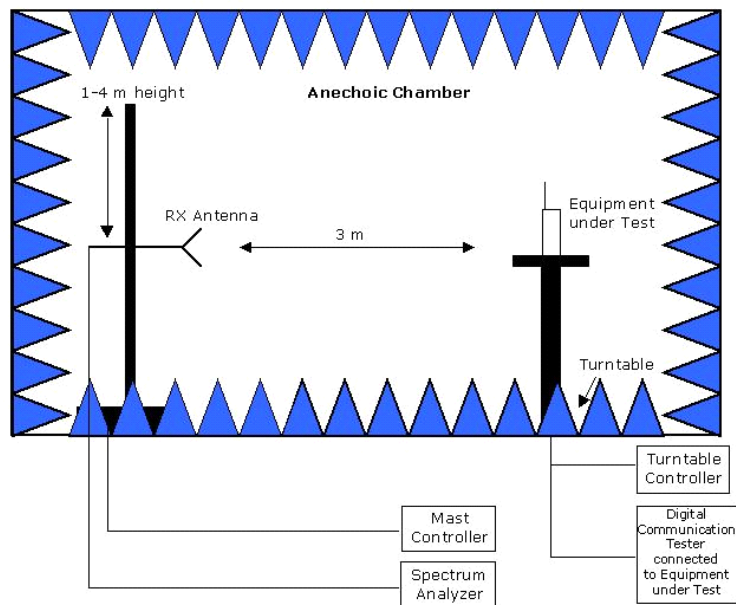

Remark: Depending on the frequency range suitable antenna types, attenuators or preamplifiers are used.

Principle set-up for radiated measurements

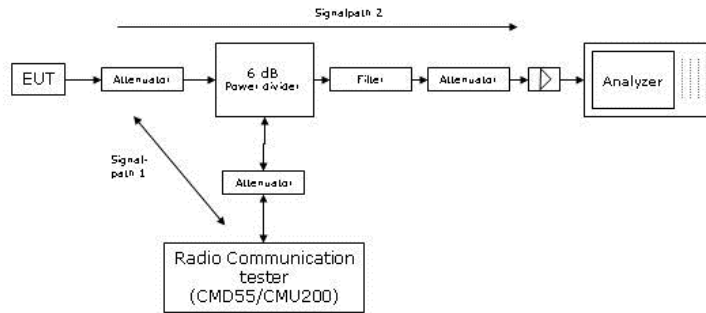

**Remark:** Depending on the frequency range suitable attenuators and/or filters and/or amplifiers are used.

Principle set-up for conducted measurements under nominal conditions

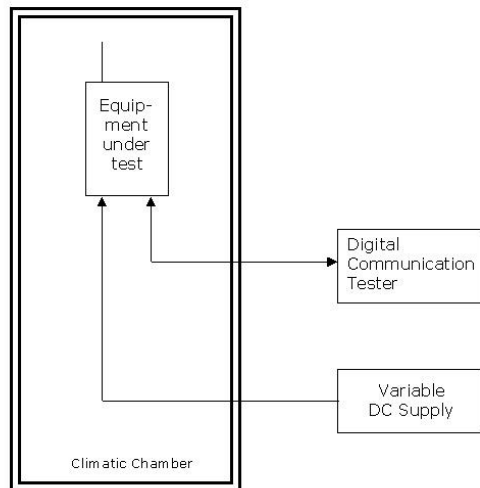

Principle set-up for tests under extreme test conditions

## 6 Index

1	Administrative Data	2
1.1	Project Data	2
1.2	Applicant Data	2
1.3	Test Laboratory Data	2
1.4	Signature of the Testing Responsible	3
1.5	Signature of the Accreditation Responsible	3
2	Test Object Data	3
2.1	General OUT Description	3
2.2	Detailed Description of OUT Samples	4
2.3	OUT Features	4
2.4	Auxiliary Equipment	5
2.5	Setups used for Testing	5
3	Results	5
3.1	General	5
3.2	List of the Applicable Body	5
3.3	List of Test Specification	5
3.4	Summary	6
3.5	Detailed Results	7
3.5.1	22.1 RF Power Output §2.1046, §22.913	7
3.5.2	22.2 Frequency stability §2.1055	16
3.5.3	22.3 Spurious emissions at antenna terminals §2.1051, §22.917	17
3.5.4	22.4 Field strength of spurious radiation §2.1053, §22.917	21
3.5.5	22.5 Emission and Occupied Bandwidth §2.1049, §22.917	24
3.5.6	22.6 Band edge compliance §2.1053, §22.917	34
4	Test Equipment Details	39
4.1	List of Used Test Equipment	39
5	Annex	44
5.1	Additional Information for Report	44



Reference: MDE\_NXP\_1201\_FCCc  
According to:  
FCC 47 CFR Ch.1 Part 22, Subpart H  
53

6 Index

.....