

User Guide

SCC3 colour console



Original Instructions: ENGLISH
Document Number: PD-UG-0008
Issue 8.0

Copyright

© Sepura Limited 2002–2020 All rights reserved.

No part of the information contained herein and the other referred documents may be copied, distributed or transmitted by any means to any other party without prior written permission of Sepura Limited. The distribution of this document may require a Non-Disclosure Agreement (NDA) between Sepura Limited and their agents or customers.

This document, the referred documents and the described product are considered protected by copyright according to the applicable laws.

Disclaimer

Although every reasonable effort has been made to ensure the accuracy of the information contained herein and any other referred document, this should not be construed as a commitment on the part of Sepura Limited and the liability of Sepura Limited for any errors and omissions shall be limited to the correction of such errors and omissions. Sepura Limited welcomes any comment and feedback as a way to improve any delivered documentation. The information contained herein has been prepared for the use of appropriately trained personnel, and it is intended for the purpose of the agreement under which the information is submitted. Any party using or relying upon this information assumes full responsibility for such use and in no event shall Sepura Limited be liable to anyone for especial, collateral, incidental, or consequential damages in connection with or arising out of the use of this information. The information or statements given in these documents regarding the suitability, capacity or performance of the mentioned hardware or software products cannot be considered binding but shall be defined in the agreement made between Sepura Limited and the customer. Sepura Limited reserves the right to revise these documents and to make changes to its content at any time, without prior notification.

Trademarks

The Sepura logo and some product branding logos and names are registered trademarks of Sepura Limited.

All other trademarks appearing in this document are the property of their respective owners.

Software license agreement

CAREFULLY READ THE LEGAL AGREEMENT CORRESPONDING TO THE LICENSE YOU PURCHASED, WHICH DESCRIBES THE GENERAL TERMS AND CONDITIONS FOR THE USE OF THE LICENSED SOFTWARE.

Contact Details

Sepura Limited
9000 Cambridge Research Park
Beach Drive
Waterbeach
Cambridge
CB25 9TL
United Kingdom

sepura.com

General information

This user guide describes the default operation and features of the SCC3 console. Your service provider or organisation may have customised your radio to optimise its performance to suit your individual needs. There may be differences between this guide and the way your product operates. Contact your service provider or organisation for information about the customisation of your radio.

The SCC3 is attached to the SRG3900/SCG22 or MDT-500-2 mobile radio and either installed within a vehicle or desk mounted. It is typically used with a handset or with a fist microphone. Audio is supplied from a loudspeaker attached to the mobile radio, or the loudspeaker in your handset or through the earpiece in a headset. Some instructions within this guide assume that the console is operated using one of these audio attachments.

The SCC3 emulates the user interface (UI) functionality of the attached handset. For example, with an HBC handset attached the SCC3 adapts to the UI of the HBC and does not display the Context key options. The instructions in this guide assume that an HBC3 handset is attached. You may need to refer to the **HBC User Guide** for instructions on using the console with the HBC.

Safety

Before operating the SCC3 colour console, read the safety instructions contained in the **Product Safety Guide (SPR-DOC-00170)** supplied with the product.

Regulatory

European regulations

 Sepura declares that its TETRA radio products are compliant with the essential requirements and other relevant provisions of the European Radio Equipment Directive 2014/53/EU on the harmonisation of the laws of the Member States relating to the making available on the market of radio equipment and repealing Directive 1999/5/EC. These products are also compliant with directive 2011/65/EU having been designed and manufactured to the RoHS requirements.

Simplified EU declaration of conformity

Sepura declares that the radio equipment types SC21, SC20 and STP9000 series hand-portable radios and SRG3900/SCG22 mobile radio are in compliance with Directive 2014/53/EU. The full text of the EU declaration of conformity is available at the following internet address:
www.sepura.com/support/compliance-documents.

Waste Electrical and Electronic Equipment disposal information



This symbol on the product or its packaging indicates that this product must not be disposed of as household or commercial waste. Some countries have set up collection and recycling systems for waste electrical and electronic products. By ensuring that this product is disposed of correctly, you will help prevent potentially negative consequences for the environment and human health, and help conserve natural resources. Please dispose of your waste product according to your national and local regulations. Contact your service provider or Sepura for information on how to return this product for waste disposal.

Disposing of waste batteries



Sepura radios are supplied with a rechargeable battery. This symbol on the battery and its packaging indicates that it must not be disposed of with household or commercial waste. Please dispose of your waste batteries according to your national and local regulations. Contact your service provider or Sepura for advice on disposing batteries in your area of the world.

Federal Communication Commission (FCC) Regulations

Sepura TETRA radios generate, use and radiate RF energy. Radios that comply with the limits for a Class A digital device, pursuant of part 15 of the FCC rules are identified by an FCC certification ID label (located under the battery). Changes or modifications not expressly approved by the party responsible for compliance could void the user's authority to operate the equipment (rule part 15.21). This device complies with Part 15 of the FCC rules. Operation is subject to the following two conditions: (1) This device may not cause harmful interference, and (2) this device must accept any interference received, including interference that may cause undesired operation.

US and Canada Markets

FCC radiation exposure statement

This radio is intended for use in occupational/controlled applications where users have been made aware of the potential risks for exposure and can exercise control over their exposure. This product is not authorised for general population, consumer or similar use. This transmitter must not be co-located or operated in conjunction with any other antenna or transmitter.

IC RSS warning

The term "IC:" before the certification/registration number only signifies that the ISED technical specifications were met.

IC radiation exposure statement

This radio is intended for use in occupational/controlled applications where users have been made aware of the potential risks for exposure and can exercise control over their exposure. This product is not authorised for general population, consumer or similar use. This transmitter must not be co-located or operating in conjunction with any other antenna or transmitter.

CONTENTS

Safety	i
Regulatory	i
Your console at a glance	1
Connection with the SRG3900/SCG22 mobile radio	2
Console and Application Interface Unit	2
Mobile radio audio control	2
Controls & indicators	4
Navi-knob	4
Navigation Keys	4
Soft keys	5
Context keys	5
Status icons	6
LED indicators	9
Emergency button	10
Getting Started	11
Power on	11
Power off	11
Locking and unlocking the keypad	11
Home screen	12
Shortcut Bar	13
Notifications	13
Menu	14
SmartMenus	15
Help	16
Emergency operation	17
Making an Alarm call	17
Receiving an Alarm call	18
Clearing an Alarm call	18
Power on Alarm call	19
Sound	20
Adjusting the volume	20
Muting audio	20
Loudspeaker high/low audio mode	21
Independent volume control feature	21
Whisper mode	22
Public/Private mode	23
Audible tone alerts	23
Personalising your radio	24
Adjusting the backlight	24

Day/Night mode	24
Adjusting text and icon size	25
Setting the display language	26
Menu style	26
Time and Date	27
Talkgroups and folders	28
Special folders	29
Talkgroup Selection Mode	30
Typical folder arrangement	31
Selecting a talkgroup	31
Folder Selection Mode	36
Contacts	44
Searching and filtering contacts	44
View contact details	45
Creating contacts	45
Editing contacts	46
Delete all contacts	47
Calls	48
Call types	48
Call History	49
Group calls	50
Individual calls	51
Broadcast calls	54
Quick Calls	54
Smart Calls	54
Modifying your call setup	55
Changing the behaviour of the PTT during TMO group calls	56
Text entry	58
Cursor movement	58
Character sets	59
Chinese character sets	59
Messages	60
Message Inbox	60
Opening messages	61
View message details	61
Reply to a message	62
Saved messages	63
SDS report request	66
Picture messages	67
Paging alerts	67
Networks	68
Authentication	68
Change Network	68

Transmit Inhibit	69
Adjusting the DMO power transmission level	70
Fallback Mode	70
Operating Modes	71
DMO Mode	71
DMO gateway operation	73
Repeater Mode	76
Callout alerts	80
Responding to Callouts	80
Callout display	84
Group calls to Callout group	86
Information Phase	86
Features	88
Privacy Screen	88
User profiles	88
WAP	90
Using WAP	90
Browser menu	90
Navigation menu	91
Settings	92
History menu	93
Using bookmarks	94
Call handling	95
Location Services	97
Position	97
Direction	98
Reporting options	98
GNSS selection	98
Security	99
End-to-End Encryption	99
Zeroising	100
Asset management	101
Labelling	101
Customising your radio	101
Revert radio settings to customisation settings	102

Your console at a glance

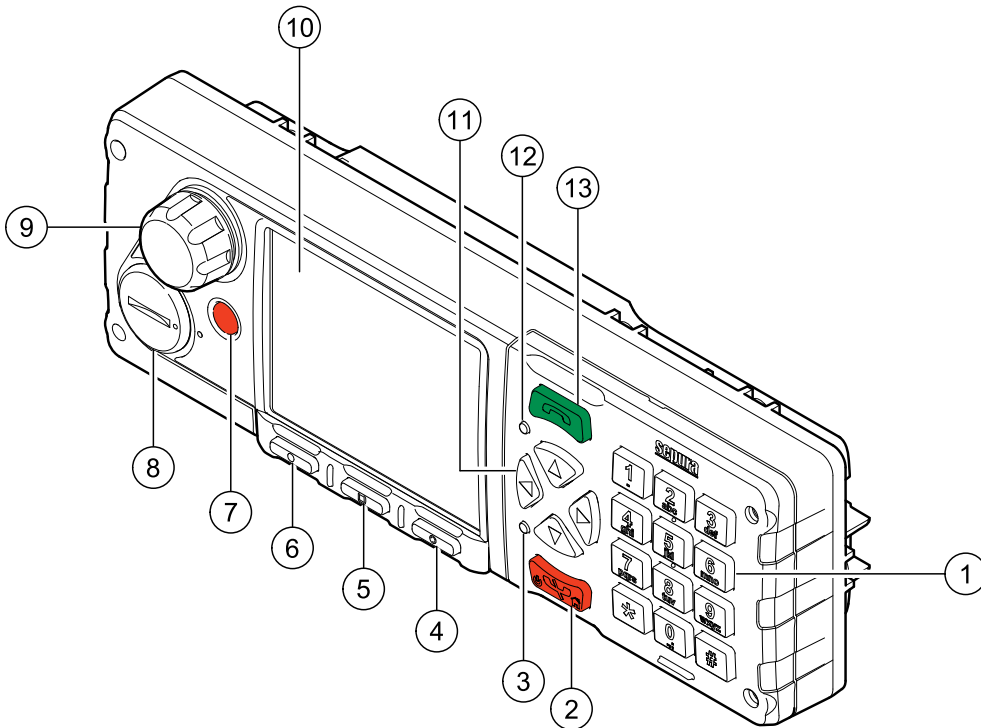

Item	Description
1	Alphanumeric keypad with backlight. Use the keypad to enter alphanumeric characters for text editing and dialling. Keys 0–9, # and * are programmable soft keys.
2	Red (Cancel/Home) key. Press and hold (2 seconds) to power on your radio. From the Home screen, press and hold (4 seconds) to power off. Press and hold (2 seconds) to return to the Home screen from any other screen.
3	Tri-colour LED (indicator). Indicates various operational states of the radio.
4	Right context key. Press to activate the feature or option that appears directly above the key.
5	Centre context key. Press to activate the feature or option that appears directly above the key.
6	Left context key. Press to activate the feature or option that appears directly above the key.
7	Emergency Button. Press and hold (2 seconds) to initiate an Alarm Call.
8	VAC connector.
9	Navi-knob. A continuously rotating knob used to adjust the volume of an independent loudspeaker or through an earpiece.
10	Colour display with backlight.
11	Navigation keys. Use to scroll through lists and move the cursor when writing text.
12	Blue LED. (indicator). Indicates a missed event such as a call, Callout or message.
13	Green (Select/Send) key. Press to initiate a half-duplex individual call or a full-duplex call. Press to select a menu item or action a function, or send a status or text (SDS) message.

Connection with the SRG3900/SCG22 mobile radio

Your console works using the SRG3900/SCG22 mobile radio, with the optional provision of the Applications Interface Unit (AIU).

Console and Application Interface Unit

The SRG3900 mobile radio supports the connection of up to two consoles, either a Standard Console, Colour Console or a Handset-based Console (via an Interface and Handsfree box), or an Applications Interface Unit, which is similar to a console but does not have a keypad and display. With the optional expansion board fitted, the SCG22 can also support two consoles. Through the use of a console, the SRG3900/SCG22 mobile radio can support the connection of up to 6 of the following audio accessories:

- up to two hands-free kits
- up to four standard handsets
- up to four standard fist microphones

If two consoles are fitted, they display the same information. This makes it possible to move from one console to another without having to take any special action. If two users are using the same mobile radio, operational procedures are required to ensure that the actions of the two users do not conflict.

On some configurations it is possible to have a hands-free kit attached to each console. If this is the case, only one of the remote microphones is live during a call. The remote microphone which is live is the one attached to the console which accepted or made the call or switched the call to hands-free.

Mobile radio audio control

The mobile radio supports the concept of a single controlling audio accessory for a call. The controlling audio accessory is the one in control of the call, and the only one on which the microphone becomes active.

When a fist microphone or hands-free kit is used, the received audio is directed to the loudspeaker connected to the mobile unit. When a handset is used, the received audio is directed to the handset earpiece.

The controlling audio accessory is normally the Remote Microphone used in conjunction with the loudspeaker, i.e. the hands-free kit or 'Public' mode. To make a different accessory become the controlling accessory, press the PTT button on that accessory or take it off hook. If the new controlling accessory has an earpiece then normally this is used for received audio instead of the Loudspeaker ('Private' mode).

When in 'Private' mode you can switch to 'Public' mode by pressing the hands free soft key (if configured). Taking a handset off hook, or using its PTT will return to 'Private' mode.

While the controlling accessory is not the Remote Microphone, you may switch to another accessory by pressing the PTT button on that accessory. Taking that accessory off-hook does not change the controlling accessory. This allows a second user to listen to received audio on another accessory.

If the controlling accessory is placed on-hook this clears the call unless customised differently. Other accessories can be put back on-hook without clearing the call in progress.

All earpiece audio is left on all the time in order that multiple users may listen to the received audio.

The audio presentation for duplex (telephone) calls depends on the capability of the controlling accessory. With a duplex controlling accessory, duplex calls have a duplex presentation. With a half-duplex accessory, half-duplex (Group) calls are controlled using the PTT button.

Controls & indicators

Your radio has a number of controls and indicators.

Navi-knob

The Navi-knob is a continuous rotating knob that in its normal mode is used to adjust the volume. The Navi-knob can also be used to perform various other functions.

To do this...	Do this...
Adjust loud speaker volume (or enable/disable Whisper Mode [customisable])	Rotate Navi-knob
Move cursor and select characters (in text entry mode)	Rotate Navi-knob in Text Entry Mode or Editing Mode
Scroll through available talkgroups	From the Home screen, press Groups + rotate the Navi-knob
Scroll through available Status Messages	From the Home screen, press Groups 2 times + rotate the Navi-knob
Scroll through available User Profiles	From the Home screen, press Groups 3 times + rotate the Navi-knob

Navigation Keys

Your mobile radio console has four navigation keys (left/right/up/down).

Key	Action
Up/Down	Use to move the scroll bar up and down to see more information. Scroll a list of options. To independently adjust the volume of accessories. See Independent volume control feature on page 21
Down	Open the top level menu from the Home screen.
Up	Repeated presses moves upwards through the options and menu levels until the top level menu is reached.
Left/Right	Moves between options on the top level menu. Moves through the text characters for selection when writing.

Soft keys

Some keys on your radio may be customised to provide one-touch access to regularly used features. These programmable keys are referred to as *soft keys*.

To activate the soft key function:

- assigned to a programmable soft key, press and release
- assigned to other keys (such as the keypad, **Cancel/Home** and **Select/Send** keys), press and hold for one second

The following keys can be customised as soft keys:

- the **Select/Send** key
- the **Cancel/Home** key
- the Emergency Button (if not assigned to Emergency operation)
- the left and right navigation keys
- all radio keypad keys (1–9, *, 0, #,)



NOTE: During full-duplex PSTN/PBX calls, take care when trying to activate soft keys (designated as 0–9, * and # keys) because they also generate DTMF tones.

There are many functions that can be assigned to a Soft key. Some functions are activated immediately, such as the keypad lock/unlock or loudspeaker on/off. There are some special functions that use a 'navigate to screen' function. This means that on activation, a screen displays and you need to take some additional action, such as activating a SmartMenu where you have to select an option.

Context keys

Your mobile radio console has a left, centre and right *context key* which you use to select options displayed adjacent to them.

On the Home screen the function assigned to each context key is defined during customisation. You can change the soft key function assigned to a context key on the Home screen (customisable), see **Set context key shortcut** on the next page.

Context labels appear at the bottom of the screen, directly above each context key. These labels show the action of the key when it is pressed; either activating a feature or performing a function such as clearing a call (Clear) or selecting an option (Select).

The labels and actions of the context keys in the Home screen are:

Context key	Label	Action
Left	Menu	Press to enter the main menu.

Context key	Label	Action
Centre	Groups	Press to change the talkgroup. See Selecting a talkgroup on page 31
	Status	Press 2 times to send a status message. See Messages on page 60.
	Profiles	Press 3 times to select a user profile. See User profiles on page 88
Right	Shortcut	Press to open the Shortcut Bar to quickly access regularly used features or clear a notification. See Notifications on page 13 and Shortcut Bar on page 13

Set context key shortcut

The shortcuts available for selection as shortcuts are set during the customisation of your radio.



NOTE: You can only use the left and right context keys and soft keys on the top level screen (Home Screen).

To set a context key Home Screen shortcut













1. Open the Home screen.
2. Press and hold the context key until the **Context Key Selection** box appears.
3. Navigate to the shortcut in the list and press **Select**.















The key is reconfigured and the new shortcut label appears in the Home screen.





Status icons

Icons appear on the status line (at the top of the display) when the radio is engaged in certain activities or when certain functions are active.

Icon	Description
Security and Emergency	
	Emergency Appears when emergency operation mode is active on your radio and an Alarm call is in progress.
	Air Interface Encryption disabled Calls and Callouts will not be encrypted.

Icon	Description
	<p>E2E Encryption enabled</p> <p>The Secure Communications icon indicates that the selected talkgroup is customised for End-to-End Encryption. In other words, calls you make by pressing the PTT button are End-to-End Encrypted.</p>
	<p>E2E Encryption disabled</p> <p>Indicates that the call is not encrypted.</p>
	<p>Key agreement</p> <p>Indicates that a cryptographic key agreement is in progress between the radio and the Key Management Centre (KMC) on the network. (See End-to-End Encryption on page 99.).</p>
Trunked Mode Operation (TMO)	
	<p>Outgoing TMO call in progress</p> <p>You are in a call that you initiated.</p>
	<p>Incoming TMO call in progress</p> <p>You are in a call that was initiated by another person or your dispatcher on the TMO network.</p>
	<p>Missed incoming TMO call</p> <p>You have missed an incoming TMO call. The blue LED flashes. A notification alerting you to the missed call appears in the Shortcut Bar.</p>
	<p>Scanning enabled</p> <p>Your radio is scanning (listening) to all available talkgroups within your scan list for activity.</p>
	<p>Broadcast Call</p> <p>A high-priority group call (point-to-multi-point) initiated by your Dispatcher to all network radio users. You cannot reply to the caller.</p>
Direct Mode Operation (DMO)	
	<p>Incoming DMO call</p> <p>You are in a DMO call that was initiated by another radio user.</p>
	<p>Outgoing DMO call in progress</p> <p>You are in a call to another radio user.</p>
	<p>Missed incoming DMO Call</p> <p>The blue LED flashes to notify you that you have missed an incoming DMO call. A notification alerting you to the missed call appears in the Shortcut Bar.</p>
	<p>DMO Gateway detected</p> <p>Appears when the radio has detected a DMO gateway. The icon disappears when the radio moves out of range of the gateway.</p>

Icon	Description
	DMO Gateway off
	DMO Repeater detected Appears when a DMO repeater is detected and the radio can communicate with any other radios in the selected DMO talkgroup which are also in range of the repeater.
	Repeater ignored
	Repeater mode off
	DMO transmission power. The radio has been set to a higher transmission power than the normal transmission power level.
	DMO transmission power. The radio has been set to a lower transmission power than the normal transmission power level.
General icons	
	Migrated Your radio is registered on a Visited Network.
	Signal Strength Shows the current signal strength. More bars indicate a stronger signal.
	Good radio coverage Indicates good radio coverage.
	No service Indicates poor signal or no radio coverage.
	Keypad locked
	Transmit Inhibit Indicates that you have activated transmit inhibit and the radio is unable to transmit (overridden when Emergency mode is activated).
	Privacy mode active during a call Appears for the duration of a call when Privacy mode has been activated to prevent any other calls interrupting an important individual call.
	Pre-emptive Call If pre-emptive priority calls have been customised on the radio. The icon is displayed if you or another user has initiated a pre-emptive call on the network.
	Covert operation mode enabled The radio turns off any visual and sound alerts, and displays this icon when covert operation mode is enabled.

Icon	Description
	<p>Group Focus</p> <p>Appears when Group Focus is enabled, preventing any calls from other talkgroups (other than the selected talkgroup) connecting to the radio.</p>
	<p>User Profile</p> <p>Appears when a user profile is activated. Your radio may be programmed for a number of user profiles. The number next to the icon indicates the chosen user profile.</p>
	<p>Communication Type Mismatch</p> <p>This icon appears when there is a mismatch in communications and is activated when:</p> <ul style="list-style-type: none"> the radio is out of range of a gateway when another radio within range of the gateway is in a group call, and you cannot participate in the call. and that you cannot take part in the call. a radio out of range of the gateway is attempting to respond to a group call, and the speech if not being routed using the gateway to TMO users. a radio within range of a DMO Repeater cannot make a call and attempts to set up a call in DMO instead, the icon appears on all radios within the talkgroup to indicate that there are members of the talkgroup who cannot take part in the call.
	<p>GPS tracking enabled</p> <p>Indicates that the GNSS (Global Navigation Satellite System) function has been enabled.</p>
	<p>GPS tracking not available</p>

LED indicators

Blue LED

The blue LED indicates either a missed event, such as a missed call or unread message, or your Bluetooth® status (if enabled). Notifications alerting you to the missed calls, Callouts or unread messages appear in the Shortcut Bar. See **Notifications** on page 13.

LED Indication	Description
Flashing on for 1 second, off for one second, on for another second, then off for seven seconds	Missed event
One flash every 10s	Bluetooth® function is enabled
Continuous rapid flashing	Radio is in Bluetooth® discoverable (visible) mode

Tri-colour LED

The tri-colour LED indicates the operational state of the radio.

LED Colour	Description
Solid green	Radio is powering on or in a call and receiving
Solid red	Radio is in a call and transmitting
Intermittent flashing red	Attempting to connect to the network or incoming telephone SDS/Status message
Flashing orange	Incoming telephone call or SDS/Status message
Intermittent four flashes orange	Transmit Inhibit mode or Fallback mode are active

Emergency button

The red button on your radio is typically programmed to activate an Alarm Call. See **Emergency operation** on page 17.

Press and hold (2 seconds) the Emergency button to initiate an Alarm Call.

If the radio is powered off, press and hold (3 seconds) to power on and initiate an Alarm Call. It may take several seconds for the radio to complete its power on process before initiating the Alarm call.

Getting Started

Power on

To power on, press and hold (2 seconds) the **Cancel/Home** key.

Your radio attaches to the last selected talkgroup when it is powered off (if it is 'in service'). This is customisable.

Depending on your radio's customisation any of the following may display:

- a company logo
- a splash screen
- a welcome screen
- a PIN entry screen



NOTE: A message may appear if your software licence has or is about to expire.

If your radio supports **Radio User Assignment (RUA)**, which authenticates your radio on the network, you may be prompted to log on to your network. See **Authentication** on page 68.

Power off

To power off, from the Home screen press and hold (4 seconds) the **Cancel/Home** key.

- Scroll to the **Shutdown** option, then press the **Select** key to power off your radio. Before powering down, alerts and messages may be sent.

If your radio is configured to provide an option to delete Callouts, navigate to **Shutdown** or **Delete Callouts** then press the **Select** key.

Locking and unlocking the keypad

To prevent accidental activity during operation, you can lock the keypad. This will also prevent access to the radio's functions if the radio is stolen. When the keypad is locked, the  Key icon appears in the status line.

The keypad can be locked manually or set to lock automatically after a period of inactivity.



NOTE: If customised, your radio's keypad can be locked when an accessory is attached.

Receiving calls with locked keypad

If you receive a telephone call when the keypad is locked your radio can be customised so that the **Select/Send** key can still be pressed to answer it. If the call is accepted the whole keypad is unlocked. Your radio can also be customised so that you can press the **Cancel/Home** key to reject the call and in this case the keypad remains locked.

Navi-knob with locked keypad

Your radio may be customised so that the Navi-knob is locked when the keypad is locked. In this case you cannot alter the volume by rotating the Navi-knob.

Your radio can also be customised so that the Navi-knob remains unlocked and in this case it can be used *for volume control only* while the keypad is locked.

To lock/unlock the keypad:

Press the * (star) key (or a designated soft key), then press the **OK** context key to lock/unlock the keypad.

To quickly lock and unlock the keypad, press and hold (2 seconds) the * (star) key.

If you press any other key while the keypad is locked no action is taken. The Navi-knob remains unlocked when the keypad lock is enabled. A message is displayed to remind you that the keypad is locked.

Alternatively, you can:

1. Select **Menu > Options > Settings > Keypad Lock**.
2. Press **Lock** to lock the keypad.

Setting the radio to automatically lock the keypad

You can set the radio to automatically lock the keypad after a period of inactivity.

1. Select **Menu > Options > Settings > Timed Keypad Lock**.
2. Press **Toggle** to enable/disable auto keypad lock.

Home screen

The top level screen, known as the **home screen**, appears when the radio powers on and when it is idle.

To quickly get back to the home Screen, press and hold (2 seconds) the Cancel/Home key.

The **status line**, at the top of the screen, displays various icons to indicate the state of operation or when certain functions such as keypad lock have been activated. It can also be configured to display the Network Name when the radio is idle.

The **context key labels** at the bottom of the screen indicate what the context key directly below the label is configured to do. These labels change according to where you are in the menu hierarchy.

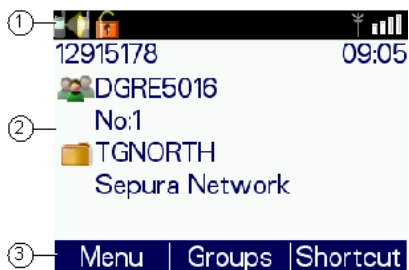

#	Description
1	Status line showing the radio coverage signal strength and operational status icons.
2	Information area containing information that only appears on the Home screen. This is customised by your service provider or organisation. It may show date and time, your selected talkgroup, folder and network name (Mobile Network Code Alias).
3	Context key options (available in the Home screen).

Shortcut Bar

You can easily access commonly used radio features such as your Inbox, and turn features on and off using the **Shortcut Bar**. The Shortcut Bar can contain up to 5 radio features and some of these can be paired with notifications to alert you to a missed call or a new message in your Inbox.

To open the Shortcut Bar, in the Home screen press the Shortcut context key or the Up navigation key.

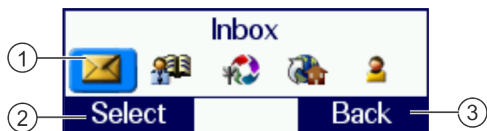



#	Description
1	Use the navigation keys to scroll through the notifications and features. Notifications always appear to the left of features. Press the Right navigation key to continue scrolling right to view more shortcuts (if available).
2	To open a notification or feature, highlight it and press the Select context key.
3	Press the Back context key to close the Shortcut Bar without opening a feature. The Shortcut Bar cannot be closed if there are notifications.

Notifications

Like a Smartphone, your radio can display notifications to indicate a missed call or new message. They also appear when certain functions are enabled such as mute and transmit inhibit. Your radio can display up to 5 notifications, and up to 5 shortcuts for commonly used radio features.

Some features can be paired with notifications, such as your Inbox so when a message is received a notification appears in the Shortcut Bar to alert you to the unread message. When paired with a feature, the feature icon appears with a notification badge . Notifications paired with features appear to the left of all other feature icons.

The following notifications can be paired with a feature:

Icon	Notification	Paired Feature
	Unread message	Inbox
	Missed call	Call History
	Missed Callout	Callout

To close a notification:

From the Home screen, press the **Shortcut** context key or the Up navigation key to open the Shortcut Bar, highlight the notification then press the **Select** context key. Use the feature in the usual way, for example, read an unread message or respond to a missed call. The notification automatically closes and disappears from the Shortcut Bar.



Menu







Your radio is customised by your service provider or organisation with a number of features that are accessed from the main menu.

- To open the main menu, in the Home screen press Menu.
- To open a sub-menu or menu option, scroll to the option (highlight it) and press Select.
- To return to a higher level menu, press Back.
- To return to the Home screen at any time within the menu hierarchy, press and hold (2 seconds) the Cancel/Home key.

Menu options

The following icons are used to identify the sub-menus that provide access to further options.

Icon	Menu option
	Phone Add, edit and delete your personal contacts within your personal folder. Search (or filter) your contacts to locate the contact you want and initiate a call. Review your call history.
	Messages Read, create, save and send text (SDS) messages. View picture messages (if customised). Select and send a status message. Clear your mailbox of unwanted messages.

Icon	Menu option
	Groups Search your talkgroup folders and select a talkgroup. Enable scanning of your selected talkgroups. Set up your speech call settings.
	GPS Manage your GPS location and position settings. View your current location, direction and speed.
	Applications Your radio may be customised with a number of applications. Your service provider or organisation may have installed specific applications (Short Data Applications) to help you in your role. Access WAP sites.
	Networks Manage your network connections and DMO options. Change your operating mode (TMO/DMO/Repeater). Enable/disable Transmit Inhibit mode when working in RF sensitive areas.
	Options Personalise your radio settings such as backlight, text size and language. Reset your radio to the last customisation, with options to keep personal data settings such as contacts in the phonebook.
	User Profiles Select customised profiles designed specifically for the way you work.
	Help View help, such as a list of customised soft keys on your radio.

SmartMenus

SmartMenus are designed to provide quick access to regularly used radio features, usually with a common theme. Your service provider or organisation may customise your radio with a number of SmartMenus, for example you may have a SmartMenu containing all your Quick Status messages, another for user profiles and another for selecting operational modes such as toggling on/off covert mode, Transmit Inhibit, loudspeaker mute and so on.

SmartMenus are assigned to a soft key, either a Side key or one of the keys on the keypad. To open a SmartMenu, press the Side key or press and hold (1 second) the assigned key on the keypad.

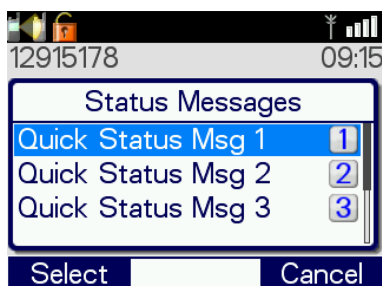

Use the navigation keys to scroll the list of options on the SmartMenu. Options are labelled with a number, shown to the right of the option. To select the option, press the key that corresponds to the number of the option, for example to select option 3, press the 3 key. Note that using this method only options numbered 1 to 12 can be selected using the keys on the keypad (press 0 for option 10, the Star (*) key for option 11 and the Hash (#) key for option 12). For options numbered 13 onwards, scroll to the option (highlight it), and press Select.

Help

The Help menu displays a free text area which is usually customised to indicate radio soft key assignments. It may also be used to record any required help text.

To access help

Use one of the following:

- Press the Up navigation key (or Shortcut) to open the Shortcut Bar, then select Help.
- Press a dedicated soft key (default is normally key '0' zero).
- Press **Menu > Help**.

Emergency operation

Emergency operation is available in TMO if the radio is in service. If your radio is operating in DMO when you make the emergency call, the radio switches to TMO before making the emergency call. If the radio cannot make the call in TMO, the radio automatically switches back to DMO to make the call. If your radio is customised for Gateway and Repeater mode, it will make an Alarm call in TMO.

The red button on the top of your console can be programmed to initiate an Alarm call at any time when your radio is in operation. This button is known as the **Emergency button**.

Your radio may be customised to perform one or more of the following:

- Initiate an Alarm call set up to one or more pre-defined users (typically to your dispatcher and other members of your talkgroup) and/or;
- Send an Emergency Status message to an individual, the dispatcher or a talkgroup and/or;
- Send a position report (GPS dependent).

If you are working in RF sensitive areas and have enabled Transmit Inhibit, prohibiting radio transmission, initiating an Alarm call will override the Transmit Inhibit feature and the Alarm call will be transmitted.

Your service provider or organisation can provide information on how your radio is customised for Alarm calls and how to operate your radio in emergency situations. If you are working in a sensitive environment your radio may be customised for Silent Alarm calls where audible and display alerts are disabled, or your radio may be customised for Live Microphone that allows you to call for assistance hands-free without pressing the PTT button.

Silent Alarm Call

If you are working in sensitive environments where the audible and display alerts associated with an Alarm call are inappropriate, your radio can be customised to make a Silent Alarm call (without acoustic or screen alerts).

When a Silent Alarm call is made, the radio displays the Home screen with the talkgroup associated with call. During the call you may navigate away from the Home screen.

Live Microphone feature

Your radio may be customised with the Live Microphone feature. This feature allows you to broadcast a call for assistance hands-free for a specified period of time and without having to press the PTT button. The radio automatically cycles between transmit and receive communication during a programmed period of time (seconds). Live Microphone is cancelled when the time expires or by pressing the PTT button.

Making an Alarm call

You can still make an Alarm call if the keypad is locked.

To make an Alarm call

1. Press and hold (2 seconds) the Emergency button; a confirmation beep sounds.
2. Release the button and speak into the microphone.

During an Alarm call:

- the microphone is 'live' for a programmed period (seconds) allowing you to speak hands-free without pressing the PTT button (customisable)
- the LED illuminates solid red
- your radio sounds audible tones
- a large emergency symbol appears on the screen
- your identity and talkgroup appears on the display of those receiving the Alarm call

Receiving an Alarm call

An Alarm call overrides any existing calls on the talkgroup.

You know you are receiving an Alarm call when:

- your radio sounds an audible tone
- the LED flashes red
- the emergency symbol appears on the screen
- your radio status changes to **Emergency**

Clearing an Alarm call

You can only clear an Alarm call that you have initiated.

To cancel the Alarm call, press the **Clear** context key.

To cancel the Alarm call, press the **Call Clear** key, the **Clear** context key or the **Cancel/Home** key. Alternatively, your radio may be customised to use the Emergency button to cancel the Alarm call.

Depending on which network is being used, if the TETRA Alarm call is a group call, then—although both of the TETRA Alarm call exit functions will clear the TETRA Alarm call on the call originator's radio—it will not remove the alarm from the system. Radios alerted to the emergency may, depending upon the infrastructure configuration, remain in the TETRA Alarm call condition until the dispatcher clears the call from the system.

When the Alarm call is cancelled, your radio returns to the talkgroup that was selected before the call was initiated.

Power on Alarm call

If your radio supports **Radio User Assignment (RUA)**, which authenticates your radio on the network, you may be prompted to log on to your network before the Alarm call is initiated. Contact your service provider for information. See **Authentication** on page 68.

Standard Operation

If your radio is powered off, press and hold (3 seconds) the Emergency button to power on and initiate an Alarm call. Any customised Welcome screen is not displayed during power on. It may take several seconds for the radio to complete its power on process before initiating the Alarm call.

Customised Operation (PIN entry bypass)

If your radio is powered off, press and hold (3 seconds) the Emergency button to power on and initiate an Alarm call. Any customised Welcome screen is not displayed during power on. It may take several seconds for the radio to complete its power on process before initiating the Alarm call.

If the radio is powered on and is at the PIN entry screen, pressing the Emergency button for 3 seconds will also initiate the Alarm call, without the need to enter your PIN.

Sound

You can adjust the volume of the speaker and increase the sensitivity of the microphone (see **Whisper mode** on page 22) so that you can speak more quietly. Your radio also uses sound to alert you to the various operational states.

Adjusting the volume

Rotate the Navi-knob to adjust the volume. A vertical volume meter displays to indicate the current volume level. The radio sounds an audible tone at the new volume level.

Muting audio







Soft keys may be customised to mute the audio output of loudspeakers and earpieces connected to the radio or consoles. In an installation with two consoles connected, audio devices can be muted on the local and remote console.

Individual soft keys may be customised specifically to:

- Mute the primary loudspeaker(s) connected to the radio
- Mute the secondary loudspeaker(s) connected to console(s)
- Mute all connected loudspeakers and earpieces, including Bluetooth devices

Pressing the same soft key again will cancel the mute and restore audio to the previous volume levels.



An icon is displayed on the status line to indicate the current audio mute mode:

Icon	Notification
	Primary Loudspeaker 1 (connected to the radio) muted
	Primary Loudspeaker 2 (connected to the radio) muted
	Primary Loudspeakers 1 and 2 muted
	Secondary Loudspeaker 1 (connected to the local console) muted
	Secondary Loudspeaker 2 (connected to the remote console) muted
	Secondary Loudspeaker 1 and 2 muted

Loudspeaker high/low audio mode

A soft key may be customised to toggle the audio output between the radio's speaker (high audio mode) and earpiece (low audio mode) as required.

An icon is displayed on the status line to indicate the current mode:

Icon	Notification
	High audio mode
	Low audio mode

When the radio is in the loudspeaker high/low audio mode:







- In normal operation, audio is routed to the primary loudspeaker in high audio mode and to the earpiece in low audio mode.
- If an earpiece accessory is connected, audio is routed to the accessory in both modes.
- During incoming or outgoing emergency calls, audio is always routed to the radio's speaker.
- A full duplex call is always routed to the radio's earpiece.

Independent volume control feature

When you switch to **Whisper mode** on the next page the sensitivity for all attached microphones is adjusted regardless of which speaker(s) volume is selected for adjustment.

To adjust the volume:

1. The volume level displays the volume for the **default accessory**. The default accessory, when the radio is in a call, is the controlling accessory and when not in a call is usually the loudspeaker attached to the SRG3900/SCG22 mobile radio.
2. Use the Up and Down navigation keys to scroll through all attached accessories. An icon displays in the volume bar, next to the volume level to indicate which accessory is selected, for example a handset icon displays when a headset (or similar) is being adjusted, and likewise a loudspeaker icon indicates that you are adjusting the loudspeaker.

Icon	Device
	Handset-base Console (HBC) #1 attached to Vehicle Accessory Connector (VAC)
	Handset-base Console (HBC) #2 attached to VAC
	Handset Loudspeaker attached to VAC
	Speaker Microphone Loudspeaker attached to VAC
	Loudspeaker attached to radio
	'All accessories' mode (volume of all speakers adjusted together)

For attached consoles the icon shows the number of the console for which the volume level is being adjusted. If more than one console is connected, you can only adjust the volume level for one console at a time. The icon number indicates which console is being adjusted.

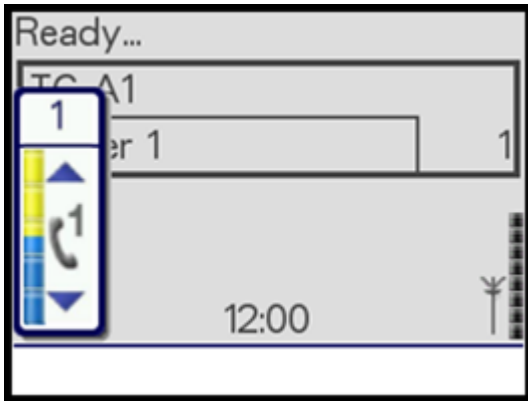

In 'all accessories' mode the volume level of all connected accessories is controlled simultaneously. The blue bar shows the volume range of the attached accessories, and is moved up and down within the volume bar as the volume level is adjusted.

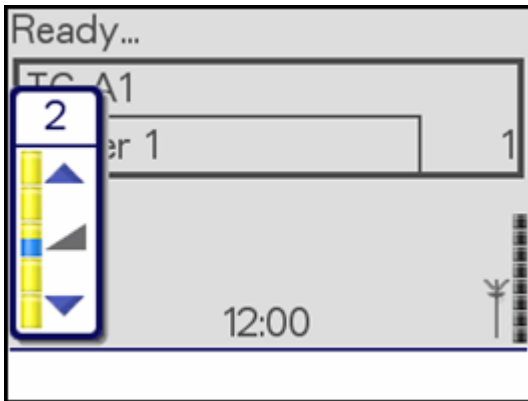

Whisper mode

Whisper mode allows you to talk more quietly than normal but still be heard and understood by the person you are calling. It can be useful to switch to Whisper mode when providing confidential information.

If you select a User Profile which already increases the sensitivity of the microphone, depending on your radio's customisation Whisper mode may not increase the sensitivity further.

To enable Whisper mode

Depending on customisation, to enable Whisper mode, you can:

- press a programmed soft key
- rotate the Navi-knob to decrease the volume to below its lowest level

The radio sounds a low-high level alert when Whisper mode is enabled.

To disable Whisper mode:

Depending on customisation, to disable Whisper mode, you can:

- press a programmed soft key
- increase the volume until the volume level meter displays at least the minimum level
- increase the volume to its loudest level then attempt to increase the volume further

The radio sounds a low-high level alert when Whisper mode is disabled.

Public/Private mode

When Public mode is enabled, audio output is via primary loudspeaker connected to the radio or an accessory secondary loudspeaker. When Private mode is enabled, audio output uses the connected accessory earpieces and mutes any loudspeakers. This provides the facility of completely discreet audio reception during calls.

To enable Private mode

Depending on customisation, to enable Private mode, you can:

- press a programmed soft key
- take an accessory off-hook during a call

The radio sounds a low-high level alert when Private mode is enabled.

To disable Private mode:

Depending on customisation, to disable Private mode, you can:

- press a programmed soft key
- place the accessory back on-hook
- release the PTT button on the accessory

Audible tone alerts

Certain events on your radio initiate audible tone alerts. These alerts are attenuated when you select a user profile which uses covert mode (see **User profiles** on page 88).

1. To toggle audible alerts
2. Select **Menu > Options > Alerts > Audio Alerts**.
3. Press **Toggle** (or the **Select/Send** key) to toggle alerts on/off.

If your radio is powered off with Audio Alerts disabled, they remain disabled when the radio is next powered on.

Personalising your radio

You can personalise your display settings (such as text size, backlight, inverting the screen and change languages) and create a personal phone book containing your own contacts.

Adjusting the backlight

When a call or message is received, and when you press any key, the backlight lights up the display and keypad. The length of time the backlight illuminates is set during customisation.

To adjust the backlight:

You can toggle the backlight on/off by using a soft key or from a **SmartMenus** on page 15 (if customised).

Alternatively:

1. Select **Menu > Options > Settings > Display Settings > Backlight**.
2. Press the **Toggle** context key.

To adjust brightness:

1. Select **Menu > Options > Settings > Display Settings > Day/Night Mode**.
2. Select **Backlight Level**.
3. Rotate the **Navi-knob** to adjust the intensity of the backlight and the keypad illumination on a scale of 1–7 (max.).

Day/Night mode

When a call or message is received, and when you press any key, the backlight lights up the display and keypad. A bright display can be a potential distraction, particularly when driving at night or in poor lighting conditions. Day/Night mode lets you adjust the intensity of the backlight and keypad illumination to suit your working conditions. Night mode reduces the glare from the display, making it ideally suited for night time use.

When the preferences for day and night mode have been set, switching between the modes automatically adjusts the backlight and display settings.

A soft key may be customised to switch between Day/Night mode.

To change Day/Night mode settings

1. Select **Menu > Options > Settings > Display Settings > Day/Night Mode**.
2. Scroll to each option (highlight it) to make your adjustments:
 - **Day Mode**—to toggle between Day Mode and Night Mode press the **Toggle** context key.
 - **Backlight Enabled**—to toggle the backlight on/off press the **Toggle** context key. When a tick appears in the box, the backlight is on, and when the box is empty, the backlight is off.
 - **Backlight Level**—to adjust the intensity of the backlight and the key pad illumination on a scale of 1 to 7 .

Adjusting text and icon size

Your radio uses the default size for the text and icons set during customisation, however it also supports a number of different size modes that control how text and icons are displayed, which can make them easier to see from a distance.



NOTE: When selecting larger modes, some prompts or icons may not appear on the radio display.

Your radio supports the following modes:

Normal Mode allows the maximum amount of information available to be displayed in a compact character size.

Large Mode displays screen information in a large character size.

Very Large Mode displays the talkgroup number or talkgroup name, as customised, in an extra large size on the Home screen with all other screens in Large mode.

Custom displays the Home screen, menu and WAP browser in predefined text sizes set during customisation. Only the Home screen supports Very Large mode, with other screens set to either Normal or Large mode.



NOTE: Depending on the customisation of the Home screen, if the date is shown on the Home screen it may be truncated in Very Large Mode. If the date format YYYY.MM.DD is used, then the day does not display.

To change text mode:

1. Select **Menu > Options > Settings > Display Settings > Text Size**.
2. Use the **Up and Down** Navigation keys to highlight the mode and then press the **Select** context key.

The radio displays the Home screen, with the text and icons appearing in the chosen mode.

Default text mode

Your radio may be customised with a pre-configured default text mode set. When the radio is powered on or restarted, the display reverts to the default text mode size.



NOTE: If the radio has been configured to change to large mode when fitted to a car kit, the display will not revert to the default text mode.

Setting the display language

Your radio operates in the language chosen during customisation and can support two display languages. The display uses the default language if the radio is only customised for a single language, or the currently selected language if two languages are programmed.

Your radio may be customised with a soft key or provide an option on a SmartMenu to change the display language. See **SmartMenus** on page 15.

To change the language:

1. Select **Menu > Options > Settings > Language**.
2. Scroll to the language option, and then press the **Select** context key.

The Home screen appears and the display shows the selected language.

Menu style

You can display the menu in **Grid**, **List** or **Compatibility** style.

1. Select **Menu > Options > Settings > Display Settings > Menu Style**.
2. Select one option:
 - **Grid**—set **Grid** menu style
 - **List**—set **List** menu style
 - **Card**—set **Card** (Compatibility) menu style

Grid style

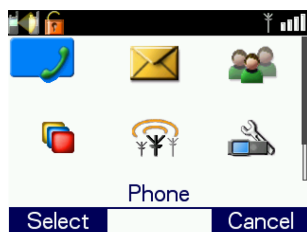

- highlight items using the four navigation keys
- to open an item press **Select**
- to return to the top level screen press **Cancel** or **Cancel/Home** key.

List style

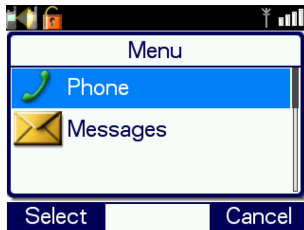

- highlight items using the **Down** and **Up** navigation keys.
- to open an item press **Select**
- to return to the top level screen press **Cancel** or the **Cancel/Home** key.

Compatibility style (card)

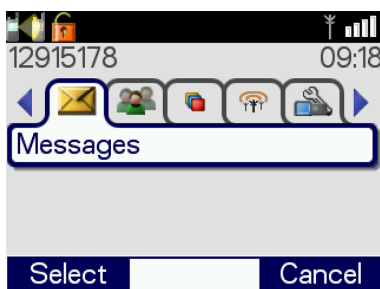

- highlight items using the Left and Right navigation keys
- to open an item press **Select**
- to return to the top level screen press **Cancel** or **Cancel/Home** key.

Time and Date

Your radio can be customised to display the current time and date on the Home screen. The time is shown in 24 hour format.

To view and edit the time and date

1. Select **Menu > Options > Settings > Time and Date**.
2. Press **Edit** or press the **Select/Send** key.
3. Enter the digits required (see **Text entry** on page 58).
4. Press **OK** or the **Select/Send** key to save your changes; press **Cancel** or the **Cancel/Home** key to abandon your changes.

Talkgroups and folders

Talkgroups are pre-programmed onto your radio. Each talkgroup typically contains users who have a similar role or who are within a distinct location or who provide a service that you would use. They are organised into folders to help you quickly select one that is applicable to your environment or situation.

A folder can contain both DMO and TMO talkgroups, but only those talkgroups applicable to the current operating mode, either DMO or TMO, appear when a folder is opened. In TMO, only those talkgroups available on the current network are displayed. The folders available depend on the customisation of your radio; various 'special' folders are also programmed into your radio (see **Special folders** on the facing page).



NOTE: If you want to change from a DMO talkgroup to a TMO one, you need to change the operating mode first (see **Operating Modes** on page 71).

A top level folder can have a number of sub-folders, similar to a folder structure on a computer, and a folder can contain both folders and talkgroups. If a folder contains sub-folders and talkgroups, two tabs appear—one for sub-folders and the other for  talkgroups. You can use the Left or Right navigation keys to switch between the tabs.

Your radio may be customised for [Talkgroup Selection Mode](#) or [Folder Selection Mode](#). How you select a talkgroup depends on which mode your radio is customised to use. When you select a talkgroup, the radio attaches to that talkgroup. Your radio can only participate in calls with talkgroups it is attached to via the network. When ongoing calls are detected on any talkgroup your radio is scanning you can join in by pressing the PTT.

Your radio may be customised so that folders can have a subscriber class attribute. The radio will then use cells with a matching subscriber class if a talkgroup is selected from the folder.

When the radio is attached to a talkgroup, the talkgroup and folder appear on the Home screen (see **Home screen** on page 12). If a talkgroup and folder are not shown:

- the radio may not have attached to the last used talkgroup at power on, or
- it was attached to a DGNA talkgroup which has been deassigned, or
- it may be attached to hidden background talkgroups, or
- a folder has not been selected (Folder Selection Mode only), or
- a change of network may have occurred and the last used talkgroup may not be usable on the current network.

When your radio is powered on, if possible it re-selects either the default talkgroup or connects to your last selected talkgroup.

Special folders

In addition to the 'standard' folders created to contain your talkgroups, your radio can be customised with Special folders. Special folders can only contain talkgroups (they cannot contain folders). Some Special folders are continuously scanned, and when ongoing calls are detected you can join in by pressing the PTT.

The following special folders may be programmed into your radio during customisation:

- Favourites—frequently used talkgroups that can be added to the folder during customisation or added by the user.
- All—contains every talkgroup programmed into your radio including those in special folders. Only available on radios customised for Talkgroup Selection mode.
- DGNA—contains up to 50 dynamically assigned groups. The contents are automatically maintained by the radio and are not customisable in Talkgroup Selection Mode. You can select a DGNA talkgroup. In Folder Selection Mode, the scan state (scanning enabled or disabled) of a talkgroup can be changed and the folder can be emptied using the **Folder Restore** option.
- UDSL—user-defined scan list(s), see **User Defined Scan Lists** on page 34. A list of talkgroups which you can modify yourself. If you select a UDSL **instead of a specific talkgroup** your radio scans all the talkgroups in that UDSL. Until a UDSL is selected its talkgroups are not scanned for activity. For more information see **User Defined Scan Lists** on page 34. Only available on radios customised for Talkgroup Selection mode.
- Always attached—talkgroups which the radio scans continuously for activity. A talkgroup in this folder can be selected as the requested talkgroup in Talkgroup Selection Mode.
- Background—talkgroups which the radio scans continuously for activity. You cannot select a background talkgroup in this folder as your requested talkgroup.

Talkgroup Selection Mode

When the radio is customised for Talkgroup Selection Mode, the selected talkgroup becomes the requested talkgroup to which you make calls.

You can insert frequently used talkgroups in the **Favourites** folder, making it quicker and easier to change your talkgroup. Additionally your radio may be customised for [Quick Groups](#) that allow you to change to a frequently used talkgroup using a soft key.

You can create your own **user defined scan lists** that are saved into the **UDSL** special folder. The UDSL folder 'greys out' (disables) talkgroups that are invalid for the current network. The scan list allows you to set scanning priorities on the talkgroups, so the radio can prioritise calls between the scanned talkgroups. See **User Defined Scan Lists** on page 34.

Typical folder arrangement

The following illustration shows how the folders can be used to organise talkgroups:

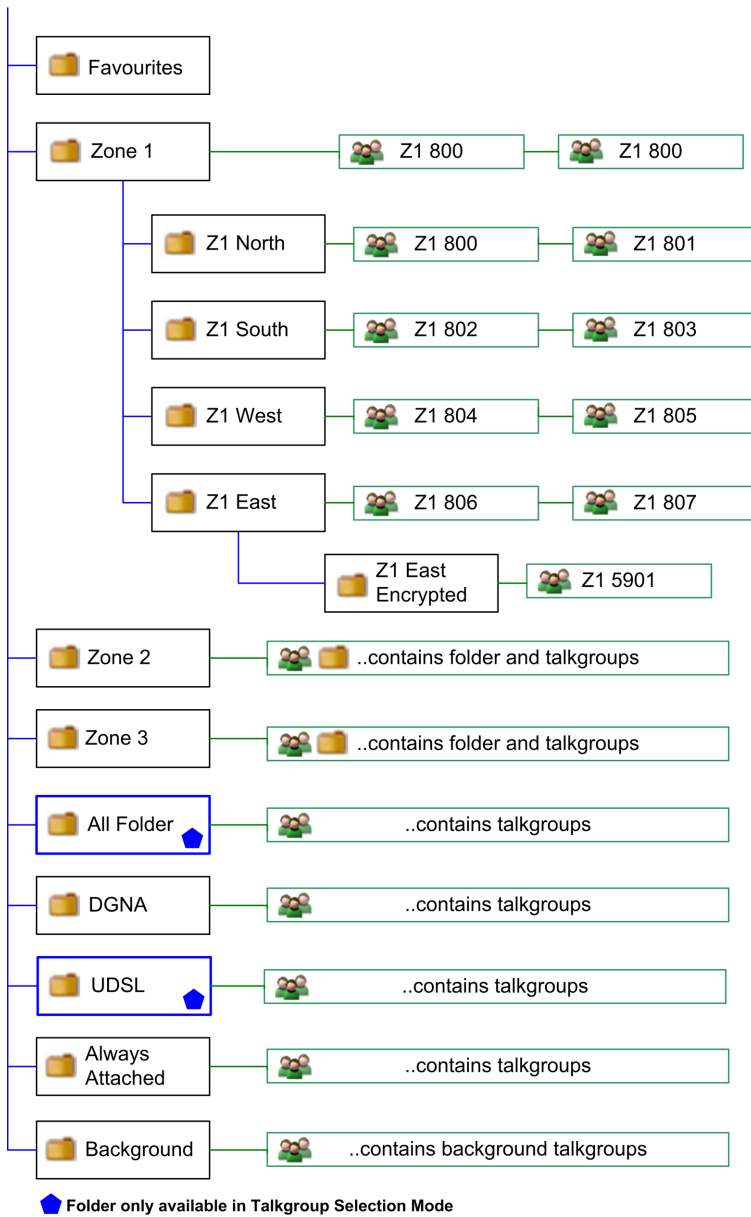

Selecting a talkgroup

You can use one of the following methods to select a talkgroup:

- From the Home screen, press **Groups**.
- From the **Menu** navigate to the **Groups** menu.
- Use a soft key to return to your Quick Group.



NOTE: Talkgroups in the **Smart Call Folder-1** or **Smart Call Folder-2** folders can only be accessed when the appropriate Smart Call mode has been selected from the Speech Call Settings screen or by using a soft key. (See **Smart Calls** on page 54.)

Standard talkgroup selection

1. From the Home Screen, press the **Groups** key. The current selected folder and talkgroup appear in the talkgroup selection box.



2. If you want to change to another talkgroup within the same folder, simply enter the number of the talkgroup, or select the All Folder which contains all the talkgroups and enter the number of the talkgroup.
3. Use the **Left and Right** navigation keys to move between folders at the same level. Use the **Up and Down** navigation keys to move between the folder levels (sub-folders).



4. Rotate the **Navi-knob** to scroll through the talkgroups within the currently selected folder. The directional arrows under the talkgroup name indicate the rotational direction of the **Navi-knob**.

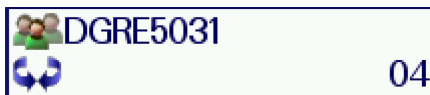

5. Press the **Select** context key to attach to the talkgroup.

Customised talkgroup selection

When the radio is customised to use the **Left and Right** navigation keys for talkgroup selection:

1. From the Home Screen, press the **Left or Right** navigation keys. The current selected folder and previous/next talkgroup folders appear in the talkgroup selection box. If customised you can scroll through the talkgroups continuously.



2. Use the **Navi-knob** to move between the folder levels (sub-folders).



3. Press the **Select** context key to attach to the talkgroup.

Opening a folder

1. Select **Menu > Groups > Folders**.
2. Highlight a folder and press **Open**.

To navigate back 'up' the folders list, press **Back**.

Searching for folders and talkgroups

You can search for talkgroups or folders by filtering on a text string. Items which do not match the string are temporarily 'filtered out' of the list.

You can use either:

- **Search card**—to filter the current talkgroup/folder folder.
- **Search all**—to filter across all talkgroups and folders

1. To search inside a specific folder, open that folder.
2. Press **Options** then select **Search card** or **Search all**.
3. Enter characters you wish to filter against (see **Text entry** on page 58).

The list of matching names is dynamically filtered as characters are entered. Only matching talkgroups or folders remain in the list.

4. To cancel the filter operation select the **Stop search** option.

Inserting a talkgroup into a folder

If a folder is editable you can use the **Insert** option to insert a talkgroup into it.

Deleting a talkgroup from a folder

If a folder is editable you can use the **Delete** option to remove a talkgroup from it. The talkgroup can still be selected from the All folder if customised, or by entering the talkgroup number directly in the Talkgroup Selection box.

Create a 'favourite' talkgroup folder

To quickly access frequently used talkgroups, you can add them to the **Favourites** folder.

1. Select **Menu > Groups > Folders > Favourites**.
2. Press **Options**, then select **Open**.
3. Navigate to the **New Group** option then press **Options**.
4. Press **Insert**.
5. Select the talkgroup you want to add (from any folder).
6. Press **Select** to insert the talkgroup into the Favourites folder.

If the **New Group** option is not available, you do not have 'edit' permissions on the Favourites folder. The Favourites folder must be set to 'Edit' at customisation.

Quick Groups

You can quickly change to a different talkgroup by pressing a customised **Quick Group** soft key specified for that talkgroup.

To select the Quick Group talkgroup

Press the customised **Quick Group** soft key. Alternatively, view the Quick Group using the menu then press **Select**.

To view your Quick Groups

You can view the talkgroups and folders associated with your assigned Quick Groups.

1. Select **Menu > Groups > Quick Groups**.
2. Use the **Up and Down** navigation keys to highlight a Quick Group then press **Select**.

To change the talkgroup associated with a Quick Group

Your radio can be customised to allow you to change the talkgroup associated with a Quick Group.

These changes may be overwritten when your radio is reprogrammed.

Select and view a Quick Group (described in **To view your Quick Groups** above) then:

- Select **Options > Change > Current**.

Your current talkgroup is now associated with the selected Quick Group.

User Defined Scan Lists

A User Defined Scan List (UDSL) is a list of talkgroups which are either fixed, or user-definable. Any talkgroups in the UDSL that are invalid for the current network are disabled and are shown 'greyed out' in the talkgroup list.

Until a UDSL is selected the talkgroups it contains are not scanned and your radio cannot receive calls from them. Your radio can have a maximum of 20 UDSLs, and up to 10 talkgroups can reside within each UDSL.

If you select a UDSL (in the same way as you select a talkgroup):

- the talkgroups it contains are scanned, allowing your radio to receive calls from any of the talkgroups in the UDSL
- the  UDSL icon is displayed in the right hand corner of the radio display
- calls are made to the talkgroup designated as the 'selected talkgroup'. If there is no selected talkgroup in the UDSL, calls are made to the talkgroup with the highest priority.

Each talkgroup in a UDSL can have up to three different levels of user-definable group **scan priorities** which are used by your radio when deciding which call to follow when a call on one talkgroup is active and a call on another talkgroup is received. The scan priority of each talkgroup in a UDSL is shown at the right hand side of the screen as ▲ (High), ► (Normal) or ▼ (Low). You can designate a selected talkgroup in each UDSL. You can add and remove talkgroups from a UDSL.

View and edit scan list

1. Select **Menu > Groups > Scan Lists**.
2. Use the **Up and Down** navigation keys to select one of the UDSLs and press **Open**.
3. Press **Edit**.



Change default (selected) talkgroup

1. Use the **Up and Down** navigation keys to select one of the talkgroups in the UDSL.
2. Select **Edit > Options > Select**.
3. Select **Edit > Options > Save**.

Add a talkgroup

1. Press **Options > Add**.
2. The talkgroup selection box is activated. Select a talkgroup as described in **Selecting a talkgroup** on page 31 then press **Select**.
3. Select **Edit > Options > Save**.

Remove a talkgroup

Select the talkgroup you wish to remove then:

1. Select **Edit > Options > Delete**.
2. Select **Edit > Options > Save**.

Changing group scanning priority

1. Select **Edit > Options > Change Priority**.
2. Select scan priority ▲ (High), ► (Normal) or ▼ (Low) then press **Select**.
3. Select **Edit > Options > Save**.

Scanning ON/OFF

Scanning of talkgroups can be enabled and disabled. If scanning is disabled, the radio will ignore incoming calls on these talkgroups. Your current talkgroup is always scanned.

Background talkgroups are always scanned and will continue to be scanned when scanning is disabled.

1. Select **Menu > Groups > Scanning ON/OFF**.
2. Press **Toggle** (or the **Select/Send** key) to enable/disable scanning.

Folder Selection Mode

If your radio is customised for **Folder Selection Mode**, you will need to select a folder, which is typically configured with zero or one selected TMO talkgroup and/or one selected DMO talkgroup, which the radio uses to make calls.

When a folder is selected and a talkgroup within that folder is selected as the requested talkgroup, they appear on the Home screen. If a folder is not selected when the radio powers on, the message **'No Folder'** appears on the Home screen. When a folder is selected that does not have a selected talkgroup, the message **'No Selected Group'** appears.

Depending on the customisation of your radio, when you press the Groups key from the Home screen, one of the following is activated:

- **Folder list.** The current selected folder opens. You can change the talkgroup within the selected folder or use the Back key to display the Folder list (a list of selectable and non-selectable programmed into your radio) and choose a new folder. The selected folder within the Folder list and the selected talkgroup within a folder are indicated by the  icon.
- **Talkgroup Selection box.** The selected talkgroup (appears in bold typeface) and the selected folder are displayed within a selection box. Only those talkgroups that are selectable within the selected folder appear in the selection box and you can scroll through the talkgroups using the Navi-knob. An icon appears to the left of a TMO talkgroup, indicating the scanning priority and whether or not the talkgroup is scan-enabled. You can select another folder by scrolling through the folders at the same level as the current folder or those at a higher level or sub-folders within the hierarchy.



NOTE: Only those talkgroups and folders that are selectable appear in the Talkgroup Selection box. Non-selectable folders and talkgroups, such as the Always Attached and the Background folders, do not appear for selection. The exception is the DGNA folder where a talkgroup from the folder can be selected, but the selected folder remains unchanged.

All the TMO talkgroups within the selected folder that are scan-enabled¹ and valid for the current network contribute to the scan list that the radio uses to prioritise calls. If a talkgroup is editable² you can change its scan state (to enable or disable scanning), change its scanning priority (see **Scanning talkgroups** on page 40) and select or deselect it.

A talkgroup can be copied from a folder to another editable folder³, for example you can copy talkgroups from Special folders such as the **Always Attached** folder into a generic folder and copy frequently used talkgroups to the **Favourites** folder, making it quicker and easier to change your talkgroup.

Your radio may be customised for [Quick Folders](#), which allow you to quickly change to a frequently used folder using a soft key.

Opening the current folder

Use one of the following methods to open the current folder:

- From the Home screen, press **Groups** and depending on the customisation of your radio, either the current selected folder opens displaying all talkgroups within the folder, or the Talkgroup Selection box opens displaying the selected talkgroup and folder.
- From the **Menu** select **Groups > Folders** to open the current selected folder.

Selecting a folder

Use one of the following methods to select the current folder:

- From the Home screen, press **Menu** then select **Groups > Folders** to display the current selected folder containing the selected talkgroup.
- From the Home screen, press **Groups**. Depending on the customisation of your radio, either the current selected folder opens displaying all talkgroups within the folder, or the Talkgroup Selection box opens displaying the selected talkgroup and folder.

Additionally, you can select a folder by pressing a soft key to select a Quick Folder or select a folder by entering its Folder ID (see **Selecting a folder using the folder ID** on the next page) if customised.

You cannot select the **DGNA**, **Always Attached**, **Background** or **Smart Call** folder as your selected folder.

A talkgroup within the folder must be selected before you can make calls. See **Selecting a talkgroup** on the next page.

To select a folder using the folder list:

1. From the Home screen, press **Menu**, then select **Groups > Folders** to open the current folder.
2. Press **Back** to navigate back 'up' the folders list.

¹In Radio Manager folder properties, the talkgroup option In Scan List is selected.

²In Radio Manager folder properties, the talkgroup option Editable is selected.

³In Radio Manager folder properties, the Subject Content option is set to Edit.

3. Scroll to the folder (highlight it) and press **Options**, then scroll to the **Select** option and press **Select**.

Only talkgroups which are valid for the current network are listed in the folder.

To select a folder and talkgroup using the Talkgroup Selection box:

1. From the Home screen, press **Groups**. The current selected folder and talkgroup are displayed in the Talkgroup Selection box. Note that the selected talkgroup appears in bold typeface and an icon indicating the scanning priority and whether or not the talkgroup is scan-enabled (no icon appears for DMO talkgroups).



If you want to change to another talkgroup within the same folder, simply enter the number of the talkgroup.

2. Use the **Left and Right** navigation keys to move between folders at the same level. Use the **Up and Down** navigation keys to move between the folder levels (sub-folders).
3. Rotate the **Navi-knob** to scroll through the talkgroups within the currently selected folder. The directional arrows under the talkgroup name indicate the rotational direction of the **Navi-knob**.



4. Press **Select** to select the folder and attach to the talkgroup.

Selecting a folder using the folder ID

Every folder has a unique identification number (ID) and you can use this ID to quickly select the folder.

Press the assigned soft key to open the Folder ID box. Enter the number of the folder (the name of the folder appears) and press Select. The folder is now your selected folder and the selected talkgroup within the folder is your requested talkgroup.

If the folder name does not appear when you entered the folder ID, the folder ID is incorrect.

Selecting a talkgroup

The selected talkgroup within each folder only becomes your requested talkgroup when the folder is selected. Depending on the customisation of your radio, you will use one of the following methods to change the talkgroup.

You can only select a talkgroup that is editable.

To select a talkgroup from the folder:

1. From the **Home** screen, press **Groups** to open the current folder. The selected talkgroup within the folder is indicated by the  icon.



2. Scroll to the talkgroup you want as your requested talkgroup and press **Select**. Selection is indicated by the .

To select a talkgroup using the Talkgroup Selection box:

1. From the **Home** screen, press **Groups**. The selected talkgroup and folder appear in the Talkgroup Selection box. The current talkgroup appears in bold typeface.
2. Rotate the **Navi-knob** to scroll through the talkgroups within the currently selected folder. The directional arrows under the talkgroup name indicate the rotational direction of the **Navi-knob**.



3. Press **Select** to attach to the talkgroup. The talkgroup appears in bold typeface. If you have selected a TMO talkgroup, an icon appears to the left of the talkgroup name indicating the scanning priority and whether or not the talkgroup is scan-enabled (no icon appears for DMO talkgroups).

Copy a talkgroup to another folder

Sometimes you may want to copy a talkgroup to another folder, for example you may want to copy your frequently used talkgroups into the **Favourites** folder. You can copy talkgroups from any folder but only place them into a folder that is editable.

You cannot copy a talkgroup from the **Background** or **DGNA** folder, or background/always scanned talkgroups within any folder. If all editable folders contain the maximum number of talkgroups, the **Copy** option is disabled because all of the destination folders are full. A talkgroup cannot be copied into a folder that already contains that talkgroup.

When a talkgroup is copied, it does not retain its properties (scan state, scan priority and selection). For example, if you copied a talkgroup that has scanning enabled, a scanning priority of High and it is the selected talkgroup, when it is copied into the destination folder the scan state is disabled (not scanned), the scanning priority remains the same and it is not the selected talkgroup.



NOTE: You can copy a talkgroup from the **Always Attached** folder for the purpose of making it your selected talkgroup. Any changes to the talkgroup's properties, such as the scanning priority and scan state, will be overridden by the properties set in the **Always Attached** folder.

To copy a talkgroup:

1. From the Home screen, press **Menu** then select **Groups > Folders** to open the current folder. If you want to open another folder press **Back** to navigate 'up' the folder list, select the folder and then press **Open**.
2. Select (highlight) the talkgroup you want to copy.
3. Press **Options**, scroll to the **Copy** option and press **Select**.
4. A list of available folders appears. Scroll to the folder you want to insert the talkgroup in to, and press **Select**. A green tick is displayed if the talkgroup has successfully been copied to the folder.

Delete a talkgroup

You can only delete a talkgroup from a folder if the folder is editable.

1. Select the talkgroup (highlight it) and press **Options**.
2. Scroll to the **Delete** option and press **Select**.
3. Press **OK** to delete the talkgroup from the folder.

Scanning talkgroups



The talkgroups that are scanned and the priority scanning order within a folder are set during customisation. If the talkgroup is editable, you can change the scan priority and the scan state (enable or disable scanning).

There are three scan priorities which are used by the radio when deciding which call to follow when in a call and another call is received.



NOTE: You cannot edit the properties (scan state and scan priority) of the talkgroups in the **Always Attached**, **Background** or **Smart Call** folders.

The scan priority appears on the left of the talkgroup as a series of bars (more bars indicate higher priority). If the scan state is enabled the  icon appears in the right-hand corner of the scan priority icon.

Symbol	Priority
	Low priority scanned
	Low priority not scanned

Symbol	Priority
	Medium priority scanned
	Medium priority not scanned
	High priority scanned
	High priority not scanned
	Background talkgroup not scanned
	Background talkgroup scanned

To scan a talkgroup:

1. From the Home screen, press **Menu** then select **Groups > Folders** to open the current folder. If you want to open another folder, press **Back** to navigate 'up' the folder list, select the folder and press **Open**.
2. Select the talkgroup you want to scan and press **Options**, then select the **Scanned** option and press **Select**. The scanning  icon appears in the right-hand corner of the scan priority icon.

To stop scanning a talkgroup, select the talkgroup and press **Options**, scroll to the **Not Scanned** option and press **Select**.

To change the priority of a talkgroup:

1. From the Home screen, press **Menu** then select **Groups > Folders** to open the current folder. If you want to open another folder, press **Back** to navigate 'up' the folder list, select the folder and press **Open**.
2. Select the talkgroup and press **Options**. Scroll to the **Set Priority** option and press **Select**.
3. Scroll to the priority setting (High, Medium or low) and press **Select**. The scan priority icon to the left of the talkgroup changes to the new priority.

Restore folders

The selected folder or all folders can be restored to their original settings. Only editable generic folders, the Favourites and DGNA folders can be restored.

When you restore a folder or all the folders, the following occurs:

- any talkgroups added to a folder will be removed,
- any deleted talkgroups will be restored,
- talkgroup properties (scan state and scan priority) are restored, and
- the selected talkgroup for each mode (TMO and DMO) is reset.

You cannot restore the **Always Attached**, **Background** or **Smart Call** folders.

To restore a folder:

1. Select the folder and press **Options**.
2. Scroll to the **Restore Defaults** option and press **Select** and then select the **Restore Folder Defs.** and press **Select**.

To restore all folders:

When all the folders are restored, the **DGNA** folder is emptied of talkgroups, and the radio will reboot on completion of restoring the folders.

1. From the folder list press **Options**, then scroll to the **Restore Defaults** option and press **Select**.
2. Scroll to the **Restore All Defaults** option and press **Select**. Press **Select** to confirm the request to reset all folders.

Viewing attached groups

You can quickly view all the talkgroups that the radio is currently attached to (scanning). Only those talkgroups in the generic, **Background**, **DGNA**, **Always Attached** and **Smart Call** folders are displayed.

1. From the Home screen, press **Menu** then select **Groups > Folders** to open the current folder. Press **Back** to navigate back 'up' the folder list.
2. With the folder selected (highlighted) press **Options**, then select the **Attached Groups** option and press **Select**.

Use the **Up and Down** navigation keys to scroll through the list of attached talkgroups.

Quick Folders

You can quickly change to a different folder by pressing a customised **Quick Folder** soft key. Your radio may be customised for up to 5 Quick Folders (Folders 1-5) for each operating mode (TMO and DMO). Each Quick Folder is assigned to a soft key on the keypad.

You can choose which frequently used folders to assign to your Quick Folders (if customised). You can view the folders that are assigned as Quick Folders, however no talkgroup information is displayed (you will need to open the folder to view the talkgroup information).

To assign a folder as a Quick Folder:

1. From the Home screen, press **Menu** then select **Groups > Folders** to open the current folder, then press **Back** to navigate back 'up' the folders list.
2. Select the folder you want to assign to a Quick Folder. Press **Options**, scroll to the **Set Quick Folder** option and press **Select**.
3. Scroll to the Quick Folder (Folders 1 to 5) you want to assign this folder to and press **Select**.

To view your Quick Folders:

1. Select **Menu > Groups > Quick Folders**. Select the Folder (1 to 5 depending on customisation) and press **Select** to view the folder assigned as this Quick Folder.

Scanning ON/OFF



Scanning of talkgroups (those that are always scanned or are background talkgroups) in the current selected folder and the **Background** folder can be enabled and disabled. If scanning is disabled, the radio will ignore incoming calls on these talkgroups. Your current talkgroup is always scanned.

1. Select **Menu > Groups > Scanning ON/OFF**.
2. Press **Toggle** (or the **Select/Send** key) to enable/disable scanning.

Contacts

Details of regularly used contacts are stored in a phone book. The phone book has a series of folders labelled **Menu**, **Search**, **All** and **Personal**. Your radio may have additional folders containing contacts programmed into your radio during customisation.

The **Personal** folder contains contacts you create (personal contacts). This folder only appears when you create your first personal contact. The **All** folder contains both personal contacts and contacts programmed into your radio.

Each contact can have up to six associated numbers. A maximum of 6000 numbers can be held in the phone book. The icon next to each contact indicates the dial mode, a radio  or to a  telephone, of the first number associated with it.

Contacts are arranged in a series of up to 64 folders including the following:

- **All** — contains all contacts in the Phone book
- **Menu** — contains options to create and delete contacts in your Personal folder
- **Search** — allows you to search the entire Phone book for contacts and numbers. Initially lists the names of all the folders in the phone book and the number of contacts in each folder.
- **Personal** — contains contacts you create. This is the only folder you can edit.



NOTE: The **Personal** folder is hidden until you create your first personal contact.



NOTE: If customised you can also press the **>Shortcut** context key in the Home screen to open the Shortcut Bar, then select the **>Phone book**.

To open the Phone book, from the Home screen, press the **Menu** context key, then select **Phone > Contacts**.

Searching and filtering contacts

You can search the entire phone book for contact names and numbers, or filter the contacts within a folder by entering a search string into the **Search Bar** at the top of any folder (except Menu):

When the search is complete:

- the **Search** folder lists folders containing at least one entry containing the search string, and the number of entries in those folders. You can open any of the listed folders.
- all other folders are filtered to show their matching entries above a dotted line. All non-matching entries are listed below the dotted line.

Spaces in a search string 'split' it into separate strings. Search attempts to match each string in sequence.

To search for contacts and numbers within the phone book:



1. Select **Menu > Phone > Contacts**. Navigate to the **Search** folder.
2. Press the **Up** navigation key to open the Search Bar.
3. Enter a search string (see **Text entry** on page 58) and press the **Search** context key.
4. When the search is complete, any folder containing a possible match to your search (and the number of possible matches within that folder) appear in the **Search** folder. To open a folder, select it and then press the **Open** context key.
5. To clear the search string, press the **Delete** context key to delete each character in the search string, then press the **Cancel** context key, then the **OK** context key.

To filter contacts within a folder:

1. Open the folder.
2. Press the **Up** navigation key to open the Search Bar.
3. Enter a search string (see **Text entry** on page 58), then press the **Filter** context key.
4. Any contact in the folder that is a possible match to your search criteria appears at the top of the contact list. To view the contact's details, select the contact and press the **Open** context key.
5. To clear the search string, press the **Delete** context key to delete each character in the search string, then press the **Cancel** context key, then the **OK** context key.

View contact details

1. Select **Menu > Phone > Contacts**.
2. Navigate to the contact you want to view details of then press the **>>Open** key.

The contact numbers associated with the selected name are displayed. The icon next to each number indicates its dial mode (for example, to a radio  or to a  telephone).

To return to the original folder, press **Cancel** or the **Cancel/Home** key.

Creating contacts

Contacts you create are added to your **Personal** folder.

To create a contact:

1. Select **Menu > Phone > Contacts**.
2. Navigate to the **Menu** card and select **Create Contact**.
3. Enter the contact name (see **Text entry** on page 58) then press the **Save** context key.
4. Select a dial mode for this contact, either TETRA Network (default) or telephone/mobile

network.

To change the dial mode, press the **Up** navigation key to select the dial mode line then use the **Left** or **Right** navigation keys to switch dial modes. Press the **Down** navigation key to continue entering the number.

If the message **Wrong number type** appears, change the dial mode or check that the length of the number is between 5 and 8 numbers.

5. Enter the number (see **Text entry** on page 58) then press the **Save** context key.
6. To add more phone numbers for the contact select **Add Next Number** and repeat the previous step.

To add further contact numbers to a saved contact, open the contact and select **Add New Number** at the end of its numbers list.

7. To return to the Personal folder press the **Cancel** context key or press the **Cancel/Home** key.

Editing contacts

You can edit (and delete) contacts in the **Personal** folder of the Phone book.

To edit personal contacts:

1. Select **Menu > Phone > Contacts** and then select the **Personal** folder.
2. Navigate to the contact you want to edit, then press **Open**.

To edit the name:

1. Select the name and then press **Edit**.
2. Make changes as required, then press **Save**.

To edit a number:

1. Select the number and then press **Options**. Select **Edit** and press **Select**.
2. Make changes: to add additional digits press the number keys; to delete digits press the **Left** navigation key.
3. After making changes press **Save**.

To delete a contact:

1. Select the contact and press **Open**.
2. Press **Options**.
3. Select **Edit > Delete contact**, then press **Select**.

Delete all contacts

You can delete all contacts in your Personal folder.

You can also delete individual contacts or numbers associated with them, see **Editing contacts** on the previous page.

To delete all contacts

1. Select **Menu > Phone > Contacts**.
2. Navigate to the **Menu** card then select **Delete User Contacts**.

Calls

The various types of voice and data calls that are supported by your radio, and the acoustic and visual alerts that accompany a call, depend on your radio's customisation.

Call types

Sepura radios support the following voice- and data call types:

Voice call types

Voice call type	Description
Group	A call between you and a group of other radio users in your attached talkgroup. A group call is always a half-duplex call. Users can join and leave the call at any time. Group calls are initiated by pressing the PTT button. See Talkgroups and folders on page 28.
Individual	A call to another user or dispatcher in the TETRA network, or to an external telephone subscriber via the Gateway. Full-duplex and half-duplex calls are supported. Individual calls to outside the TETRA network can be made between a terminal or a dispatcher and a telephone subscriber in a network to which the TETRA network has a gateway interface. These calls are always full-duplex. A full-duplex call is one in which both parties can speak at the same time. The Select/Send and Cancel/Home keys are used to initiate and end calls. In a half-duplex call only one person can speak at a time and needs to press the PTT button.
PBX	A call to a user on a private branch exchange (PBX). This call needs to be set up by your service provider and allows you to call a person by dialling their extension number (preceded by a programmed digit used to dial the exchange).
PSTN	A call to a user on a the public switched telephone network (PSTN).
Broadcast	A special type of group call, which is received by all terminals in the system (system-wide broadcast call) or by a specific group. The originator of a Broadcast call is usually a dispatcher. The receiving members cannot talk.
Transmit Only	A customised type of group call, where a call you make on a transmit-only talk group can only be received by an authorised dispatcher. Other users in the group cannot listen to the call.



Voice call type	Description
Quick Call	A special individual call configured on a soft key to request help or information from a pre-configured individual or talkgroup destination in a non-emergency situation. Quick calls can also send status and position reports. They can have a call priority that is different from the calls normally set up using the PTT or the Select/Send key.
Smart Call	A special individual call made in Smart Call mode which allows you to make group or broadcast calls to specific talkgroups without the need to notify the network about the talkgroup change. Smart Call mode is initiated from a configured soft key. Smart call priority can have a call priority value from 0 (undefined) to 15 (pre-emptive priority 4, emergency) in TMO and to a value from 0 (undefined) to 3 (Emergency pre-emptive priority call) in DMO.
Alarm Call	The Alarm Call has the highest call priority in TETRA. Usually initiated by pressing the Emergency Button. Alerts all other radio users on the talkgroup of the emergency situation.

Data call types





Data call type	Description
Individual full-duplex Circuit Mode Data	Circuit Mode data calls have a very short transit delay and so are suitable real-time services
Status Message	A Status message may have 65536 possible status values. Of these, value 0 is defined to mean 'Emergency,' values 1–32767 are reserved, and values 32768–65535 are available for network or user-specific definition.
SDS Message	A user-defined message that can be sent by individuals and received by individuals and talkgroups.
Packet Data	TETRA Packet Data extends TETRA to act as an IP subnet. This enables application programmers to build their applications in a well-standardised environment.

Call History

The Call History records up to 20 recent individual calls. It can be customised to display Incoming Calls or Outgoing Calls or both sets of call types in a list.

The following icons are used to distinguish different types of  TETRA and  PBX/PSTN call events:

Icon	Description
	Received TMO call

Icon	Description
	Sent TMO call
	Missed call. Call was not answered or cleared.
	TETRA Alarm Call
	Received TETRA DMO Call
	Sent TETRA DMO Call

The call history is deleted if you do not switch off your radio correctly (using the **Cancel/Home** key).

To display the call history

Select **Menu > Phone > Call History**.

To display the call information

Select a call in the call history list then press **Open**.

To make a call from call history

See **Individual calls** on the facing page.

Group calls

Group (**point-to-multipoint**) calls are calls where you talk to other users within a nominated group of radio users (a talkgroup). In a group call only one person can talk at any one time (known as **half-duplex** mode).

During group calls the microphone at the top of your radio is active and all received audio is routed to the loudspeaker.

Making a group call

1. Press and hold the **PTT** button and speak into the top microphone.

The LED changes to solid red to indicate that your radio is transmitting, and an audible tone is heard and your radio status text changes to 'Talk'.

2. When you have finished talking, release the **PTT** button and listen to audio received, through the loudspeaker.

The LED changes to solid green whilst the group call is active and your radio status text changes to 'Group Call'.

3. You can also clear the group call by pressing:

- Clear Call soft key (if customised)
- Cancel/Home key

Receiving a group call

When a group call is received, your radio status changes to 'Group Call'. The name of the talkgroup, talkgroup folder and the caller's ID are displayed.

Individual calls

Individual calls (**point-to-point**) are private calls between you and one other person. You can make individual calls in two modes:

- individual calls (half-duplex mode)—where only one person can talk at a time using the PTT button.
- individual 'phone' calls (full-duplex mode)—where both parties can talk simultaneously. Use the Select/Send and Cancel/Home keys to initiate and end the call.

When an individual call is received, your radio sounds an audible alert and displays the identity of the caller (if the contact is stored in your phone book) or the ISSI of the caller.

Privacy mode

You can press a customised Privacy Mode soft key before dialling or during a call to prevent interruptions from other calls during important or sensitive call. When you have Privacy Mode enabled, calls made to your radio are marked as missed calls (see **Call History** on page 49).

Making individual calls (half-duplex mode)

Calling a contact:

1. Select **Menu > Phone > Contacts** to open the contacts menu.
2. Navigate to a contacts folder (such as the *All* folder) and select your contact. Press the **Open** context key, then choose the phone number.
3. Press the **PTT** button to initiate the call (or press **Options**, select **Dial** then press **Select**.
When the call is connected (the tri-colour LED illuminates green and a confirmation tone sounds).
4. To speak, press the **PTT** button; release the PTT button to listen.
5. To end the call, press the **Clear** context key or the **Cancel/Home** key.

If your radio has been customised with a single dial mode for TETRA, PBX and PSTN numbers, the dial mode icon cannot be changed.

Calling by dialling:

1. From the Home Screen, dial the number of the person you are calling.
2. Press the **PTT** button to initiate the call (or press the **Call** context key).
3. To speak press the **PTT** button; release the PTT button to listen to the other radio users.
4. To end the call, press the **Clear** context or the **Cancel/Home** key.

Calling a contact directly:

When the radio is customised with this feature, a call can be made to a contact without having to select a specific number, by pressing the PTT button.

1. Navigate to a contacts folder (such as the *All* folder) and select your contact as normal.
2. Press the **PTT** button to initiate the call:
 - The radio uses the first valid TETRA ID for the contact to make the call.
 - If no TETRA ID exists for the contact, an error message will be displayed.
3. To speak press the **PTT** button; release the **PTT** button to listen to the other radio users.
4. To end the call, press the **Clear** context or the **Cancel/Home** key.

Receiving individual calls (half-duplex)

1. Press the **PTT** button to answer the call or the **Clear** context key to reject the call.

Making individual phone calls (full-duplex mode)

Calling a contact:

1. Select **Menu > Phone > Contacts** to open the contacts menu.
2. Navigate to a contacts folder (such as the *All* folder) and select your contact. Press the **Open** context key, then choose the phone number.
3. To initiate the 'phone' call press the **Dial** context key.
4. To end the call, press the **Clear** context key or the **Cancel/Home** key.

If your radio has been customised with a single dial mode for TETRA, PBX and PSTN numbers, the dial mode icon cannot be changed.

Calling by dialling:

1. From Home Screen, dial the number of the person you are calling.
2. Press **Send** or press the **Select/Send** key to initiate the call.
3. To end the call, press **Clear**.

If your radio has been customised with a single dial mode for TETRA, PBX and PSTN numbers, the dial mode icon cannot be changed.

Calling a contact directly:

When the radio is customised with this feature, a call can be made to a contact without having to select a specific number, by pressing the **Select/Send** key.

1. Navigate to a contacts folder (such as the *All* folder) and select your contact as normal.
2. Press the **Select/Send** key to initiate the call:
 - The radio uses the first valid TETRA ID for the contact to make the call.
 - If the TETRA call is not successful, the radio uses the first valid PSTN ID to make the call.
 - If no TETRA ID exists for the contact, an error message will be displayed.
3. To end the call, press the **Clear** context or the **Cancel/Home** key.

Hands-free mode

If you are using a full-duplex audio accessory, simply press the **Select/Send** key and continue fully hands free.

Receiving a phone call

When an incoming phone call is received, your radio sounds an audible alert and displays the identity of the caller (if the contact or number is stored in your phone book).

1. Press the **Accept** context key or the **Select/Send** key to answer the call. Press the **Reject** context key or the **Cancel/Home** key to reject the call.
2. To end the call, press the **Clear** context key or the **Cancel/Home** key.

Your radio can be customised to answer calls automatically after a set time period, exactly as if the **Accept** context key or the **Select/Send** key had been pressed. If the time period is set to zero the call may be answered before any alerts are audible.

Answering phone calls in half-duplex mode

You can answer an incoming full-duplex (phone) call as a half-duplex call. This is useful, for example, where a full-duplex call could pick up too much background noise for clear communications.

1. Press the **PTT** button to answer the call in half-duplex mode.
2. Continue as for Group calls and individual half-duplex calls:
 - To speak press and hold the **PTT** button and speak into the microphone.
 - To listen release the **PTT** button and listen to audio received through the speaker.
3. To end the call, press the **Clear** context key or the **Cancel/Home** key.

Broadcast calls

Sometimes it may be necessary for your Dispatcher to make a high-priority broadcast (also known as a Site Wide Call) to all network users. These calls take priority over any lower priority on-going calls, and you cannot respond to them: pressing the PTT key has no effect during a broadcast call.

During a broadcast call the display changes to 'Broadcast Call' and the  Broadcast Call icon is displayed.

Quick Calls

A Quick Call allows you to request help or information in a non-emergency situation.

To initiate a Quick Call

1. Press a pre-configured soft key.
2. Press the PTT to transmit.

Depending on the configuration this causes all or some of the following to happen:

- if your radio is in Smart Call Mode it reverts to Group or Individual Mode (see **Smart Calls** below).
- your radio sets up a voice call to a programmed recipient which can be individual or talkgroup
- your radio sends up to two Status messages
- your radio sends a position report

Quick Calls cannot be made from a radio in Gateway Mode. Switch your radio to TMO or DMO before making a Quick Call.

Quick Calls cannot be made from a radio which is making or receiving an emergency call or if your radio is in Transmit Inhibit mode. See **Emergency operation** on page 17 and **Transmit Inhibit** on page 69.

Smart Calls

A **Smart Call** is a high priority group or broadcast call to a specific talkgroup. This can be useful, for example, where you need to make an announcement to everyone in the vicinity of an incident, not just those in your selected talkgroup.

The radio supports two separate **Smart Call Modes** (A and B) associated special folders **Smart Call 1** and **Smart Call 2** respectively. Each Smart Call Folder can be pre-configured with up to 75 talkgroups.

You initiate a Smart Call by switching to Smart Call mode, then you press the **PTT** to transmit to a chosen talkgroup in the Smart Call Folder.

Broadcast calls cannot be made from a radio which is in DMO. Attempting to make a Smart Call in DMO initiates a group call to the attached talkgroup.

It is not possible to make a Smart Call from a SRG3900/SCG22 radio operating in Gateway Mode and the Speech Call Settings option is not displayed.

Make a Smart Call

1. Open the Smart Call menu either of the following:
 - Press a preconfigured soft key.
 - Use the **Speech Call Settings** menu (see **Speech call settings** below).
2. Select mode **Smart Call A** or **Smart Call B**.

Your radio goes into Smart Call Mode. The tri-colour LED flashes amber and the active Smart Call folder is displayed.
3. Select the required talkgroup in the current Smart Group Folder by .
4. Use the **PTT** (or press the **Select** context key or the **Select/Send** key) to transmit to the chosen talkgroup.

To leave Smart Call Mode

1. Open the Smart Call menu either of the following:
 - Press a preconfigured soft key.
 - Use the **Speech Call Settings** menu (see **Speech call settings** below).
2. Select **Group** or **Individual**:
 - **Group**—returns you to your previous talkgroup
 - **Individual**—allow you to make an individual call by dialling

Speech call settings

The Speech Call Settings option is not available if your radio is operating in Gateway Mode.

The Speech Call Settings option is not available if your radio is in **Transmit Inhibit** on page 69.

1. Select **Menu > Groups > Speech Call Settings**.
2. Select one of the options.

Modifying your call setup

Under certain circumstances, the type of a call which is being initiated by your radio may be modified by the network or by the recipient of the call. For example, you might make a group call, but the actual call being established might be converted to an individual call to a dispatcher.

This feature is typically used by network administrators to provide centralised control over certain services (e.g. customising all the radios so that Alarm Calls are all the same type and destination, allowing the network to decide what type of call is made and the destination whenever an Alarm Call is initiated).

When your call is modified you are alerted with specific visual and acoustic alert indications, to make you aware that a new type of call is being connected. The call continues as per any normal call of the new type, and the icons and information elements displayed inform you about the type of the ongoing call.

Once the call is established, the characteristics of the new call are the same as those of any call of that type. For example, if the new call is half-duplex, you need to press PTT before starting to speak, releasing the PTT allows other parties to take the speech item, and the top microphone and half-duplex loudspeakers are used.

Changing the behaviour of the PTT during TMO group calls

Your radio may be customised to allow you to talk back on your TMO selected group even if you are currently receiving a group call from another talkgroup being scanned by your radio.

When enabled, pressing the PTT when in a received group call will start a new call on the radio's selected talkgroup, allowing you to participate in that call whilst monitoring your current scanlist activity.

There are two options:

- **To selected group**—when the PTT is pressed in a received group call to a scanned group (not the selected talkgroup), the radio leaves the existing call and starts a new call to the scanned talkgroup.
- **To received group**—when the PTT is pressed during a received group call, the radio transmits in the current call.

If the PTT behaviour is set to the '**to selected group**' option, and the radio is in a group call from a scanned talkgroup that is not the currently selected talkgroup, an icon  appears in the Call Information Box. When the radio leaves the scanned group, to start a call to the selected talkgroup, the icon is not displayed.

The behaviour of the PTT button can be set for all group calls using the **PTT Behaviour** option available from the **Options** menu. Alternatively, you can override the default setting during a group call by pressing the **PTT** context key (which toggles the two options) and select the PTT behaviour that allows you to respond to the call. Your radio provides a notification message to show the change of PTT behaviour (either '**to selected group**' or '**to received group**'). When the call is terminated, the behaviour of the PTT button reverts to that selected using the menu option.

If your radio is operating in Gateway mode, the radio can only respond to group calls in the selected talkgroup (**to selected group**).

To set the PTT behaviour using the menu:

1. Select **Menu > Options > Settings > PTT Behaviour**.
2. Select the PTT behaviour (**To received group** or **To selected group**), then press the **Select** context key.

To change the PTT behaviour during a group call:

1. When the group call is in progress, press the **PTT** context key. Select the PTT behaviour and press the **Select** context key.

Alternatively, you can change the PTT behaviour during a group call by pressing the **Options** context key, then selecting the **PTT Behaviour** option. Press the **Select** context key to change the behaviour of the PTT, for example if your default behaviour is set to the '**to selected group**' option, the option to change to the received group appears for selection.

Text entry

Writing and editing text on your radio is similar to most Smartphones. **Text edit** mode is automatically activated when you select certain functions, such as creating a message or adding a contact to your phone book.

To enter characters:

Press a key repeatedly to highlight a character in its Character Selection Box at the bottom of the screen, then press the **Select** context key (or wait for the character to be auto-inserted).

To delete a character:

To delete the character to the left of the cursor press the **Delete** context key.

To enter special characters:

To insert punctuation (**full stop**, comma, or **semi-colon**) press zero (**0**) repeatedly until the symbol is highlighted in the Character Selection Box, then press the **Select** context key (or wait for the character to be auto-inserted).

To insert a **space** press **1** (on the keypad).

To insert symbols press the hash(**#**) key repeatedly until the symbol is highlighted in the Character Selection Box, then press the **Select** context key (or wait for the character to be auto-inserted).

To change the character set:

Press the Star (*****) key during text entry.

Cursor movement

When you enter text the cursor advances automatically. You can also move the cursor character by character or to the start or end of a sentence using the navigation keys.

Cursor Movement	Description
Move one character at a time	Press the Right or Left navigation key.
Move to the start of a sentence	Press the Up navigation key.
Move to the end of a sentence	Press the Down navigation key.
Add a space	Press the 1 key.

Character sets

You can use character sets to change the style of the text, and to enter numbers and special characters. The character set can be changed as often as required when entering text. The following character sets are supported:

Character set	Description
Auto-capitalisation (Abc)	The first letter is entered in upper-case, with all following characters in lower-case. New sentences start with a capital letter and end with a full stop (.), question mark (?) or exclamation mark (!) followed by one or more spaces.
Upper case (ABC)	All characters are entered in upper-case.
Lower case (abc)	All characters are entered in lower-case.
Numeric (123)	All characters are numbers.
Special characters(!.@)	You can select special characters such as full stops (.), semi-colon (;) and commas (,) by pressing the 0 key. Further special characters # @ ! " £ \$ % & ' () * + - are available on the # key.
Chinese characters	Simplified and Zhiyan. See Chinese character sets below.

The selected character set is indicated on the status line at the top of the display.

Chinese character sets

Simplified Chinese

You can build up Simplified Chinese characters by pressing the appropriate keys on the keypad to input strokes. As strokes are entered they display in the top left of the character selection box and the set of possible matching characters is displayed above the Context keys.

You can also use pinyin to enter a phonetic version of a Simplified Chinese character (e.g. 'Lu') which is displayed in the top left of the character selection box—in the same place as the strokes described above—and the set of possible matching characters is displayed above the Context keys.

When the right and/or left arrow icons are displayed in the character selection box, use the **Left** and **Right** navigation keys to select from the characters displayed. To see further characters press the **Down** navigation key, and press the **Up** navigation key to return to characters already viewed. The characters are displayed in sets of seven.

To enter the highlighted character—press **Insert** or press the **Select/Send** key.

Zhiyan Chinese

Zhiyan Chinese characters are composed and entered in a similar way to Simplified Chinese characters, however when the keys are pressed to input the strokes that build up the character you must then press the **Select/Send** key to display the set of possible matching characters.

Messages

Your radio supports  **status** messages,  **text** (SDS) messages and  **picture** messages. All message types are available from the **Messages** menu.

Message Inbox

Incoming messages are displayed in the **Inbox** with the most recently received messages at the top. Unread messages appear in **Bold**. The Inbox can store up to 50 messages. When the Inbox is full, unsaved older messages are automatically deleted when new messages are received. If you want to keep a message, you must save it.

If your radio is configured to show messages in tabs, the most recent message appears on the last numbered tab, for example if there are 5 messages in your Inbox a new message will appear on tab number 6. If you want to read older messages use the navigation keys to scroll through the message tabs. Unread message appear on black labelled tabs.

To keep the Inbox to a manageable size it is recommended that messages are deleted or saved after reading them. See **Saved messages** on page 63.

When a new message arrives

- the  **New Message** icon appears to show there is a new message in the Inbox.
- the radio vibrates
- the tri-colour LED flashes amber
- the blue LED flashes periodically ('missed event')
- the display flashes periodically ('missed event')
- if specified in the message, the text of the message (SDS message) or image (Picture message) is displayed on the screen as soon as it is received









To open the Inbox:

Choose one of the following methods:

- Press a customised soft key
- Open the Shortcut Bar (in the Home screen press the **Shortcut** context key or the **Up** navigation key) then navigate to the **Inbox** shortcut and press the **Select** context key.

Message icons

Various icons are used to identify the type of message received:

Icon	Description
	Status message
	SDS message (unread)
	SDS message
	Broken message: there was a problem receiving the message. Its contents are lost or damaged.
	Saved Messages is nearly full to capacity [customisable]
	SDS message with Paging Alert (unread)
	SDS message with Paging Alert
	Picture message (unread)
	Picture message

Inbox operations

You can perform a number of functions from the Inbox. With a message selected, press the **Options** context key to perform one of the following functions:

- Open the message
- View the message details (See **View message details** below.)
- Reply to the message (not picture messages)
- Forward the message to a contact (not picture messages)
- Save the message (See **Saved messages** on page 63.)
- Delete the message

Opening messages

To open a message:

1. Open your Inbox (see **To open the Inbox:** on the previous page).
2. Scroll to the message and then press the **Open** context key.

View message details

You can view the details of received messages.

To view message details:

1. Open your Inbox (see **To open the Inbox:** on page 60).
2. Select a message then use **Options > Details**.
3. To exit the Details screen press **Cancel**.

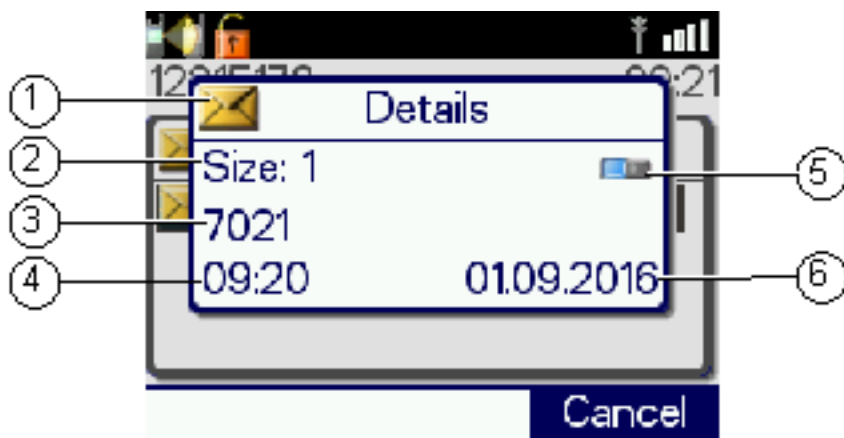

Item	Description
1	Message location (Inbox)
2	Size. Note: this is a relative measure of the message size (not number of characters). You can use Size to decide which message(s) to delete if Saved Messages becomes full (see Message Inbox on page 60)
3	Sender
4	Time received
5	Dial mode
6	Date received

Reply to a message

To reply to a message:

1. From an open message, select **Reply**.
2. From Inbox, select a message then select **Options > Reply**.
3. Create your response (see **Text entry** on page 58.)
4. When you have finished, press **Send**.
5. Select a recipient:
 - a. **Send to Default**—send to message sender
 - b. **Send to Group**—send to your current talkgroup

- c. **Phonebook**—send to a contact in your phonebook
 - d. **Dial**—send to a number you dial
6. Press **Send**.

Open a URL in a message

Open the message then select **Options > Open URL**.

A text message may contain a URL which you can open in the WAP Browser.

If your radio has been customised to do so, URLs in text messages can open automatically in the WAP Browser when they are received.

Saved messages

You can save up to 50 messages in your Saved messages folder. When the remaining space is insufficient to save a particular message, an error is displayed which indicates the amount of space required to store the current message. Delete one or more messages to clear some space for new ones to be saved.

Saved Messages can be lost if the radio is not correctly switched off when powering down (see **Power off** on page 11).

To save a message:

1. Open the message (or select it in the Inbox).
2. Select **Options > Save**.

A message indicating that the message has been stored is displayed.

To view saved messages:

Select **Menu > Messages > Saved Messages**. Use the navigation keys to scroll through the list of messages.

To delete saved messages:

1. View Saved Messages (see **To view saved messages:** above).
2. Select **Options > Delete**.
3. Select a delete option:
 - To delete the selected saved message select **Delete Message**
 - To delete all saved messages select **Delete All**

Create a text message

1. Select **Menu > Messages > Create Message**. An empty message box appears.
2. Enter your message text (see **Text entry** on page 58).

3. EITHER:

- send the message immediately
- save the updated message

To return to the top level menu screen, either wait for the inactivity timer to expire, or press and hold the **Cancel/Home** key, or press and hold the 'clear' soft key.

To send the message immediately

See *Sending messages* below.

You can set an option to confirm that the message has been delivered, see **SDS report request** on page 66.

To save the message

Select **Options > Save**.

To edit a saved text message

1. View Saved Messages and select the saved message.
2. Select **Options > Edit**.
3. Edit the message as required. (See **Text entry** on page 58.)
4. EITHER:
 - send the message immediately
 - save the updated message

To send the message immediately

See *Sending messages* below.

To save the updated message

Select **Options > Save**.

Sending messages

You can send text (SDS) and status messages to:

- the currently selected talkgroup
- the default destination customised in your radio (for example, the message sender)
- a Phonebook entry
- a destination you key in

For setting default destination see **Set default destination** on page 70.

1. Choose one of the following methods:
 - Select a saved text message
 - Select a status message from the Send Status List
 - Create a text message
2. Select **Send** or **Options > Send**.
3. Select a destination (see below):

Send to default destination

Select **Send to Default** then select **Send**. The message is sent and the radio returns to the message screen.

Send to current talkgroup

1. Select **Send to Group**. The current talkgroup is shown.
2. Select **Send**.

Send to a Phonebook entry

1. Select **Phonebook**. Your Phonebook opens.
2. Select your contact and press **Open**.
3. Select the phone number. (Contacts can have multiple phone numbers).
4. Press **Send** to send the message.

While you are selecting the address for a message you cannot make outgoing calls to Phonebook.

Send to a dialled destination

1. Select **Dial**.
2. Key in an individual address (ISSI, Individual Short Subscriber Identity) in the dial box.
3. Press **Send** to send the message.

Send a status message

To send a status message, choose one of the following methods:

Shortcut Bar

Press **Shortcut** to open the Shortcut Bar, then select **Quick Status** (if customised).

From the Home screen

1. In the Home screen, double-press the **Groups** key.
2. Press the **Left and Right** navigation keys to scroll through the status messages.
3. To send the message, press **Send**, then select **Send to default** (or choose another destination such as your talkgroup, contact in your phone book or dial the number).

Soft key (Quick Status message)

Press a soft key. Messages sent from soft keys are called **Quick Status messages**.

During a Group Call with the call dialogue screen displayed, you cannot send Quick Status messages using the **Select/Send** key or the **Cancel/Home** key. Instead, first press the **Down** navigation key to clear the call dialogue screen, or exit the call.

Menu

1. Select **Menu > Messages > Send Status**.
2. Use the **Up and Down** navigation keys to highlight the status and then select **Options > Send**.
3. **Select** a destination.

Edit status messages before sending

You can edit the text label of a status message prior to sending it. When the message is edited, it is sent as a text message, rather than as a status message code.

With the status message selected, press **Options** and then select **Edit**. Enter your text before sending the message.

The **Edit** option is only available when you open a status message from the menu.

SDS report request

You can request a Delivery Report and/or a Read Report when you send an SDS (text) message. These cause a pop-up box to open when sent messages are successfully delivered and read respectively.

1. Select **Menu > Messages > SDS Report Status**.
2. Navigate to a report type and press **Toggle** to toggle the report on (ticked) and off.

Set default destination

You can enter and update the default destination address that your radio offers when you send a status or SDS message. This can be either a talkgroup or an individual.

1. Select **Menu > Messages > Status Destination**.
2. Select **Options** (or press the **Select/Send** key) then select **Edit**.
3. Select Dial or Phonebook:
 - select **Phonebook** to open the Phonebook and choose a contact (**Contacts** on page 44)
 - select **Dial** to enter the required number directly from the radio keypad.

4. Press **Save** or the **Select/Send** key to save the number (or press **Cancel** or the Cancel/Home key to cancel it and return to the previous number).

Picture messages

Picture messages

Your radio can receive picture messages which may have accompanying text. You may also be alerted by an alarm (if specified in the message) and vibration and LED alerts (if customised). (You cannot reply to or forward a picture messages.)

You can press any key to stop the audible alarm.

Open picture message

1. Select a  picture message then click **Open**.
2. To view the image full screen, use **Options > View Image**.

The image and any text associated with it are displayed.

If the image data has been corrupted the  Broken Picture icon is displayed.

Paging alerts

The Paging Alerts feature allows the radio to act as a pager when it is in normal operating mode or when you select a **user profile** which results in the radio appearing to be switched off. (See **User profiles** on page 88.) The Paging Alerts feature is triggered by receipt of a Status message which is automatically displayed.

If there is also an associated SDS message to explain the reason for the Paging Alert this is automatically displayed on the radio. If a call is in progress the Paging Alert interrupts it. The SDS message is marked with an icon  to indicate that it is associated with a Paging Alert.

When the Paging Alert is triggered you hear a discordant two tone alarm and the tri-colour LED flashes amber to indicate that a Status message has been received. To stop the two tone alert press any key.

Your radio can be customised so that a Paging Alert automatically makes it fully operational on receipt of the Status message which triggered the Paging Alert.

Networks

Authentication

Remote User Assignment (aliasing)

If your radio supports Remote User Assignment (RUA) using TETRA Interoperability Profile (TIP) defined procedures and transactions, your presence on the network requires authentication.

RUA allows you to be authenticated onto the network by entering a user identity and optionally a PIN (maximum 7 digit). Once accepted by the system, you can be addressed by your user identity, if aliasing is supported by the system.

At the start of a shift, you can take a pool radio and, after you log in, other radio users on the network can identify you by your user name. TETRA services including individual voice and data (Status and SDS) communication can be set up using your user name (provided your user name and your corresponding user ISSI are in the Phonebook).

If you power on your radio using the Emergency button you must log on to the network before an Alarm call can be initiated.

Network log on/off may be initiated by your dispatcher.

To log on/off:

Your radio may be customised to request PIN entry log on to the network when powered on. Alternatively select **Menu > Networks > Log ON/OFF**.

A screen appears:

Log On—enter your user ID and password then press **Confirm**.

Log Off—press **Confirm**.

Details—indicates the current log on state of the radio, and displays the user's network identity.

Change Network

If your radio is customised to use other networks, you can manually select a network from a list of configured networks, or allow your radio to automatically use a suitable network when you move into its coverage area.

If your radio is customised for End to End Encryption, the radio may change the End-to-End Encryption status when the selected network is changed. It may also provide a selection of talkgroups on other networks. If a talkgroup is selected that does not belong to the current network, your radio will change network accordingly.

After switching to a different network, make sure that your selected talkgroup is valid for that network. For details of talkgroup selection see **Talkgroups and folders** on page 28.

Your radio can be configured to display the Network Name continuously on the Radio Status Line (RSL), subject to space, when it is idle.

If your radio registers on a **Visited Network** network the  **Migrated** icon is displayed in the Radio Status Line (RSL).

To manually change network

1. Select **Menu > Networks > Change Network**.
2. Navigate to the required network then press **Select** or the **Select/Send** key.

When you manually select a network it remains selected regardless of whether your radio is able to obtain service on that network.

To automatically change network

1. Select **Menu > Networks > Change Network**.
2. Navigate to **Automatic** then press **Select** or the **Select/Send** key.

The Network Name of the automatically selected network is displayed below the **Automatic** option in the list when the radio is able to obtain service.

Transmit Inhibit

Sometimes you may be working in areas that are sensitive to Radio Frequency (RF) signals such as healthcare facilities. To continue operating your radio in these areas, you can set your radio to Transmit Inhibit mode to prevent any RF transmission.

When Transmit Inhibit is activated or deactivated, a status message can be sent confirming the operational state of your radio. You cannot activate Transmit Inhibit when you are in a call.

Alarm Calls initiated in Transmit Inhibit mode are still transmitted.

You cannot select Transmit Inhibit if user profile **Do Not Disturb** is selected. See **User profiles** on page 88.

Your radio automatically leaves Transmit Inhibit mode when you power it off; when powered on again Transmit Inhibit is not activated.

To activate or deactivate Transmit Inhibit mode

1. Select **Menu > Networks > Transmit Inhibit**.
2. Select **Toggle** to toggle Transmit Inhibit on/off.



When Transmit Inhibit mode is activated:

- The Transmit Inhibit icon appears in the Shortcut Bar as a notification or the status line on the Home screen
- The Tri-colour LED flashes orange four times approximately every 2 seconds.

There may be a soft key programmed to toggle Transmit Inhibit on/off. For a list of programmed soft keys refer to the radio's Help (**Menu > Help**).

Adjusting the DMO power transmission level

When you are operating in DMO, Repeater or Gateway modes, you can change the transmission power level that your radio operates at on the network.

The radio operates at a normal transmission level which is predefined. If you change the power level to a setting that is higher than the normal operating transmission level, the icon  appears on the status line. Likewise if you change the power level to a lower transmission level, the icon  appears on the status line.

To change the transmission power level:

1. Select **Menu > Networks > DMO Options** then select either the **DMO Tx Power** option if you are working in DMO on the network or the **Rep/GW Tx Power** option if you are working in Repeater or Gateway modes.
2. Select the power level option, and press the key.

Fallback Mode

If a base station is customised to operate in fallback mode, when network communication is lost any radios using the base station will continue to operate, but with a reduced service. This is known as **Fallback Mode**. The base station broadcasts the loss of communication to all radios which are using it.

In Fallback Mode your radio can only communicate with other radios that are registered on the same site: no inter-site communication is available.

When your radio enters Fallback Mode:

- the radio status bar indicates Fallback Mode and the warning triangle is displayed momentarily
- the Fallback Mode text box pops up in the centre of the screen for a few seconds showing a customisable text message
- the  RSSI antenna icon flashes continuously
- the tri-colour LED flashes amber intermittently (indicating limited service mode)
- the radio generates a warning tone

When your radio leaves Fallback Mode:

- the radio status bar returns to normal (Ready... or similar)
- the  RSSI antenna icon stops flashing
- the tri-colour LED stops flashing
- a text box pops up indicating normal operation.
- the radio generates a warning tone.

Operating Modes

Your radio supports the following operating modes:

- In **Trunked Mode Operation** (TMO Mode) your radio operates on the network infrastructure supplied by your service provider.
- In **Direct Mode Operation** (DMO Mode) your radio can transmit directly to another radio (antenna to antenna). In DMO mode radio coverage depends on the position of the caller and the receiving radio. When you switch to DMO your radio leaves the network and tunes to the selected DMO talkgroup. See also **DMO Mode** below.
- In **Gateway** mode your radio acts as a **DMO gateway** (or gateway) which allows users working in DMO to communicate with users operating on a Trunked Mode (TMO) Network. This extends the coverage of the network, allowing users in DMO mode to communicate with those operating in TMO. See also **DMO gateway operation** on page 73.
- In **Repeater** mode your radio enables two or more radios operating in DMO mode to communicate over an extended range, automatically relaying voice and messages by operating as a repeater. See also **Repeater Mode** on page 76.

To change operating mode from the Home screen

Press the **Menu** context key, then select **Networks > Operating Mode**. Scroll to the mode (highlight it) and press **Select**.

Alternatively, a soft key may be programmed as a shortcut to this function or a shortcut may be added to the Shortcut Bar. Open the Shortcut Bar (in the Home screen press the **Shortcut** context key), scroll to the **Operating Modes** shortcut and then press the **Select** context key. You can then select the operating mode.

DMO Mode

In Direct Mode Operation (DMO), radios communicate directly with other TETRA radios without using a network. The radios must all switch to DMO and select the same talkgroup, and that talkgroup must use the same channel (frequency). Communications to other users on the network are impossible unless they also switch to DMO and select the same talkgroup.

This means that in DMO, communications to the dispatcher is impossible unless they also switch to DMO and select the same talkgroup, or if they communicate through a **DMO gateway** (see *DMO gateway operation*).

Group calls

DMO supports group calls (see **Group calls** on page 50) which are made and received in the same way as radios operating in TMO. In DMO TETRA Alarm Calls are either sent to the currently selected DMO talkgroup or (if customised) may switch to TMO to make the call. If TMO is unavailable Alarm Calls are made using DMO. See **Emergency operation** on page 17.

Individual calls

Your radio can be customised to allow you to make individual calls to other radios working in DMO which are attached to the same talkgroup. In this case individual calls are initiated by pressing the PTT key.

Your radio can also be customised to allow you to select a **channel only** talkgroup. If you select a channel only talkgroup **your radio cannot make or receive group calls**: it can only make or receive individual calls.

You can enable **Presence Checking** so that your radio checks whether the receiving radio is available to receive when you attempt an Individual call. See **DMO options** on the facing page.

Using a DMO gateway

A DMO gateway (or gateway) is a device which allows users working in Direct Mode to communicate with users in Trunked Mode effectively extending the working range of a radio. When your radio is in DMO Mode and it is in range of a DMO gateway the  gateway icon appears and, if customised, an audible alert is generated. You can now make and receive group calls to TMO radios (and to the dispatcher) via the gateway. See **DMO gateway operation** on the facing page.

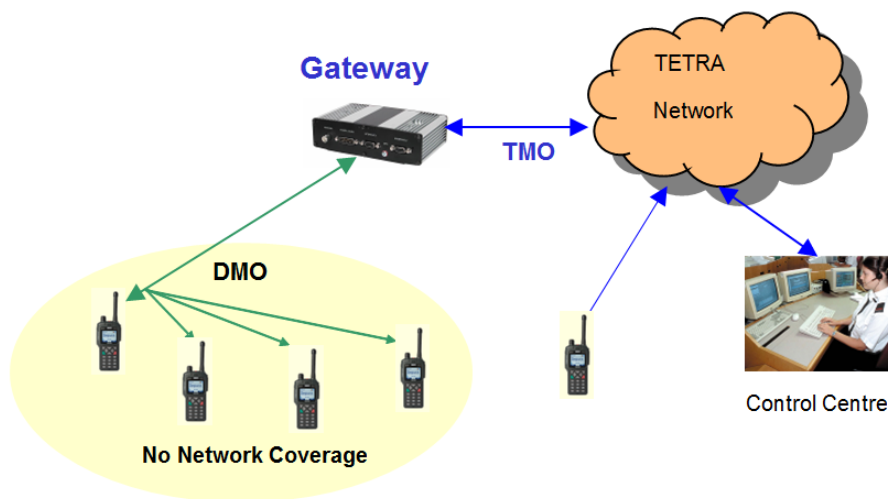

If your radio is outside the range of a gateway, you may still be able to hear the speech of another user who is in range of a gateway and who is involved in a group call via the gateway. In this case the  **Communication Mismatch** icon is displayed to indicate that you cannot take part fully in the call. If you attempt to respond to the overheard speech, any radios within gateway range which can hear you also display a Communication Mismatch icon to tell them that the speech is not being routed via the gateway to TMO users.

Using a DMO repeater

You can extend DMO Mode range by using a DMO repeater (repeater). If your radio detects a repeater the  **DMO Repeater** icon is displayed and your radio can communicate with any other radios in the selected DMO talkgroup which are also within the range of the repeater. See **Repeater Mode** on page 76.

If a radio is within range of a repeater but for some reason a call cannot be set up through it your radio attempts to set up the call in DMO Mode and the  Communication Mismatch icon is displayed to all members of the talkgroup to indicate that there may be members of the talkgroup who cannot take part in the call.

DMO options

You can select the following DMO options:

GW DMO Ind Address

Set the default individual address to which a TMO Individual call is routed by a radio operating in DMO gateway mode.

Press **Select** then **Options**.

Edit—enter a new address as described in **Text entry** on page 58. The dial mode may be changed by pressing the **Up** and **Down** Navigation keys. When the number and dial mode are as required press **Save**.

Phonebook—enter a new address from the phonebook. Navigate to the required phonebook contact then press **Details** see all numbers associated with the chosen contact. Select a number and press **Save**.

Use Default—reverts changes to the default value.

Presence Check

Specify whether Presence Checking is performed before DMO Individual calls are made. When Presence Checking is On your radio checks whether the intended receiving radio is available and in radio contact before it attempts to set up the call.

GW/Rep Filter

Specify whether your radio uses or ignores any gateway and/or repeater it detects.

In the Gateway/Repeater Filter screen select one of the following options:

No GW/Rep—do not use any gateways and repeaters detected by your radio

Use Repeater—Use repeaters detected

Use Gateway—Use gateways detected

Use GW/Rep—Use a gateway or a repeater detected by your radio.

When option **Use GW/Rep** is selected, your radio selects the first gateway or repeater that it detects.

If the radio selects a gateway, a  gateway icon is displayed on the status line. If the gateway stops sending a presence signal it will no longer be detected by your radio.

DMO gateway operation

A DMO gateway (or **gateway**) is a device which allows users working in **Direct Mode Operation** (DMO) to communicate with users operating on a Trunked Mode Operation (TMO) network (see

DMO Mode on page 71). The gateway re-transmits information received on the DMO Interface onto the TMO interface, hence extending the working range of the DMO radios. Therefore if your radio is in DMO and is within range of a gateway you can make and receive Group calls to and from TMO radios, including your dispatcher.

When you switch to Gateway mode, your radio connects your currently (or last selected) selected DMO and TMO talkgroups.

Gateway connecting DMO radios to TMO network

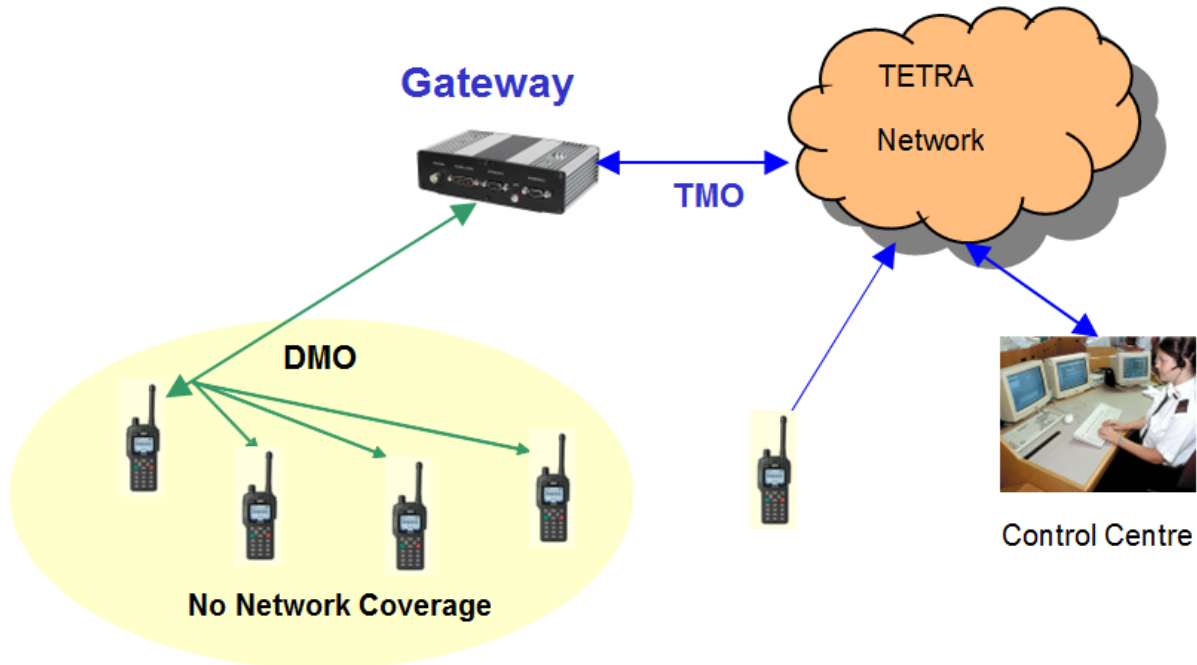

When in Gateway mode, with the exception of **Emergency operation** on page 17 and **Smart Calls** on page 54, no calls (voice or data) can be made or received on the radio being used as a gateway. The radio is acting only as a relay between Direct mode and Trunked mode.

If you activate the Emergency Button when the radio is operating in Gateway mode, any calls that are currently active through the gateway cease. The radio reverts to Trunked Mode Operation and initiates an Alarm Call to the attached Trunked mode talkgroup. When the Alarm Call ends the radio remains in Trunked mode.

If you are going to leave a gateway unattended for long periods of time, or as a permanent installation in a remote location, we recommend that you configure it as required (select and attach the required Trunked mode talkgroup and the required Direct mode talkgroup) and then power the radio off. This will save the configuration; each time the radio is powered on again, it will re-start with the saved configuration. This will ensure that the radio is always running with the correct gateway configuration even if it turns on unexpectedly after circumstances such as power failures.

Switching to Gateway mode

When you switch to Gateway mode, your radio connects your currently (or last selected) selected DMO and TMO talkgroups. If your radio has been reprogrammed, you may need to switch to DMO mode (see **Operating Modes** on page 71) and select a DMO talkgroup before Gateway mode can be enabled.

To switch to Gateway mode

Press a customised soft key.

Alternatively follow these steps:

1. Press **Menu** then select **Networks > Operating Mode**.
2. Scroll to **Gateway Mode** and press **Select**.
3. A large tick graphic is displayed and the  gateway icon is displayed on the status line. After various checks the top level screen message 'Ready: Gateway' appears. (If this does not happen see the Tip above.)

If you do not see message 'Ready: Gateway', select a DMO talkgroup to connect to (described in **Selecting a talkgroup** on page 31). The radio remembers the last Direct mode talkgroup selected for use in Gateway mode, and uses it automatically the next time the radio is switched into Gateway mode.

When the radio is configured as a Gateway, the top level screen shows the TMO and DMO talkgroups selected:



#	Description
1	TMO talkgroup
2	DMO talkgroup

When in Gateway mode the radio makes no differentiation if the DMO talkgroup is a 'Channel Only' talkgroup. Please see **DMO Mode** on page 71 for more information on DMO 'Channel Only' talkgroups.

Gateway states

A gateway can enter several states of operation, depending upon the status of calls through the gateway, whether it has detected other gateways present or other users of the direct mode channel. These states are reported as top level screen messages including the following:

Message	Description
Monitoring Gateways	Displayed when the radio is first switched to Gateway mode, or when the DMO frequency is changed by requesting a new talkgroup or a previously Occupied or Reserved channel is detected as free.
Busy DMO Channel	This screen is displayed if the DMO frequency is detected as being Occupied or Reserved.
Other gateway found	Another gateway offering the same or an overlapping DMO service has been detected.
Ready: Gateway	The gateway is ready and has no calls in progress.
In Call: Gateway	A call is in progress through the gateway.

Changing talkgroups in Gateway mode

When a talkgroup is changed in Gateway mode, only the DMO talkgroup changes; the TMO talkgroup remains unchanged unless the radio has been configured with fixed pairs of DMO and TMO talkgroups. (The radio can be programmed with up to 100 pre-set pairs of TMO and DMO talkgroups.) In this case, if the selected DMO talkgroup is paired with a TMO talkgroup then the radio also automatically selects the paired TMO talkgroup.

Changing TMO talkgroup

1. Select Trunked mode operation:
 - a. Press **Menu** then select **Networks > Operating Mode**.
 - b. Scroll to **Trunked Mode** and press **Select**.
 - c. Select the TMO talkgroup to connect to (see **Selecting a talkgroup** on page 31).
2. Select Gateway mode operation:
 - a. Press **Menu** then select **Networks > Operating Mode**.
 - b. Scroll to **Gateway Mode** and press **Select**.

Changing DMO talkgroup

Select the DMO talkgroup to connect to (see **Selecting a talkgroup** on page 31)

Repeater Mode

A radio acting as a **repeater** provides a service to other radio users. It extends the range and enhances the reliability of Direct Mode communication compared with basic direct communication between radios.

You can use a repeater to enable communication between radios which are out of range of each other. The following diagram shows radios A, B and C and a repeater which are on the same DMO talkgroup. A, B and C are in range of the repeater. Because of its location, the repeater can pass communications between A, B and C even though they are out of range of each other.

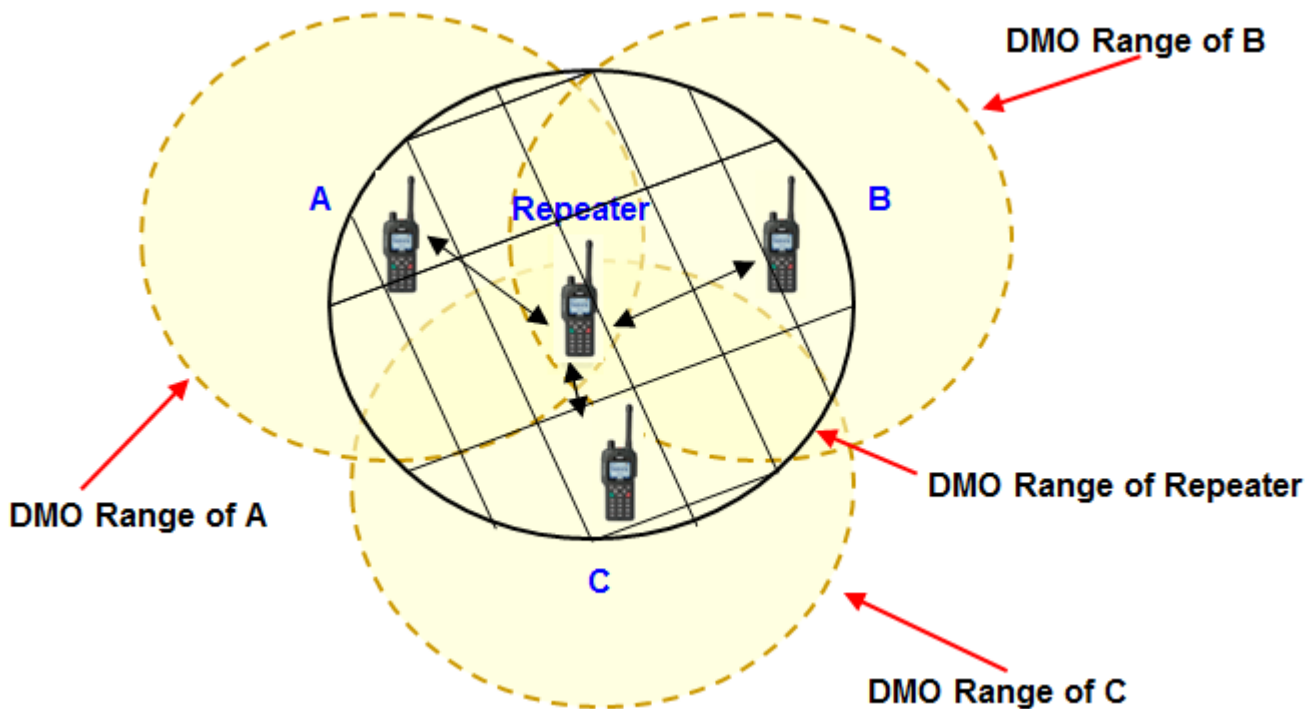

You can also use a repeater to enable communication between two radios which cannot communicate directly, perhaps because their users do not have line of sight with each other.

The following diagram shows radios A and B and a repeater which are on the same DMO talkgroup. A and B are in range of the repeater. Because of its location, the repeater can pass communications between A and B even though they cannot communicate directly.

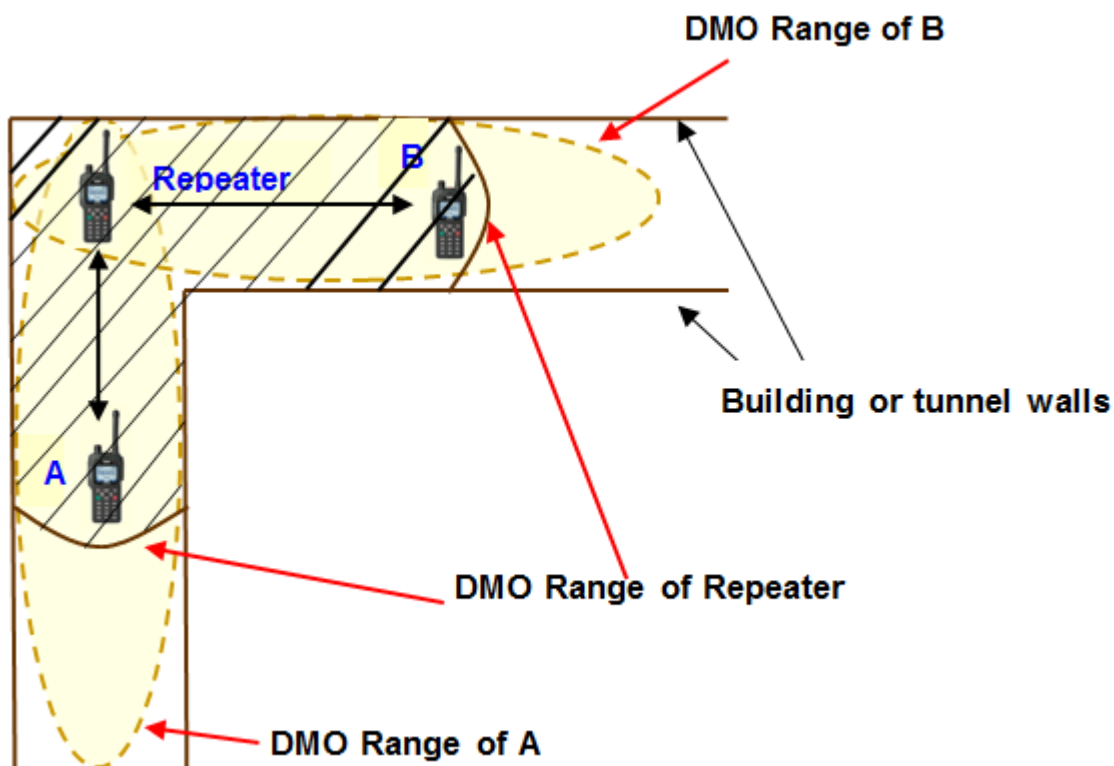

What repeaters cannot do

In Repeater Mode the radio cannot:

- make individual calls
- take part in another group call
- send status or SDS messages
- use the Quick Status feature
- edit text
- use the phonebook
- view the library of pre-defined Status messages

Participating in repeated calls

A radio in Repeater Mode may (depending on its customisation) operate either as a **Standard Repeater** or as a **Repeater with Call Participation**.

Standard Repeater

If your radio is configured to operate as a Standard Repeater you cannot take part in calls which are being relayed through it.

Repeater with call participation

If your radio is configured to operate in Repeater Mode with Call Participation you can take part in the calls which are being relayed through it if the call participants are on the same DMO talkgroup as you. To stop participating in a call, press the **Clear** context key; your radio continues to act as a Repeater.

You cannot switch to Repeater Mode if the radio is in **Transmit Inhibit** on page 69 or if the radio has initiated an alarm call (see **Emergency operation** on page 17) which has not been cleared.

If you select Transmit Inhibit Mode while your radio is operating in Repeater Mode, the radio leaves Repeater Mode and it stops functioning as a Repeater.

If you are going to leave a repeater unattended for long periods of time, or as a permanent installation in a remote location, we recommend that you configure it as required (select and attach the required Direct Mode talkgroup) and then power the radio off. This will save the configuration; each time the radio is powered on again, it will re-start with the saved configuration. This will ensure that the radio is always running with the correct repeater configuration even if it turns on unexpectedly after circumstances such as power failures.

Switching to Repeater Mode

To switch to Repeater Mode see **Operating Modes** on page 71.

Before you can use the radio as a repeater you must select a Direct Mode talkgroup.

Changing talkgroups in Repeater Mode

You can change talkgroups while your radio is operating in Repeater Mode in the usual way (see **Talkgroups and folders** on page 28.)

If you change to a different DMO talkgroup it may (depending on the customisation) terminate any calls active through the repeater.

Using the Emergency Button in Repeater Mode

If you use the Emergency Button when your radio is operating in Repeater Mode, any calls that are currently active through the repeater will cease. When the Alarm Call is subsequently cleared, the radio may not necessarily remain in Repeater Mode.

Repeater states

A radio acting as a repeater can enter several states of operation, depending upon the status of calls through the repeater and whether it has detected other users of the direct mode channel. These states are reported as the following top level screen messages:

Message	Description
Ready: Repeater	The repeater is ready and has no calls in progress
Busy DMO Channel	The repeater has detected that the DMO channel is being used. In this case repeater operation is suspended.
In Call: Repeater	A call is in progress through the repeater.
Talk Repeater	Participating in a call and transmitting

Callout alerts

Your radio can receive Callout Alerts sent over the network to inform you of incidents. When a Callout Alert arrives the radio sounds an audible alarm and a Callout message is displayed on the screen. To silence this alarm press any key. A voice call may also be initiated. Your radio may also be customised to alert you of Callouts in other ways (such as vibrator alert and/or a flashing LED alerts).

When it receives a Callout Alert your radio goes into **Protected Callout Mode** (in which many features are disabled) for a set time period or until you respond to or acknowledge the Callout message. This mode is designed to stop you getting distracted and to focus your attention on an incident.

To view Callout messages

Press **Menu** then select **Phone > Callout**.

Alternatively, press the **Up** navigation key (or **Shortcut**) to open the Shortcut Bar, then select **Callout**.

If Callout messages have been received they are listed with **Callout icons**.

To see the options for a Callout

- Highlight a Callout and press **Options** OR
- press the **Select/Send** key to activate the first option in the Options menu. (The  Select/Send Key Shortcut icon between the Context keys indicates that this shortcut is available.)

Open – view the Callout message plus more information associated with the message dialogue

Accept – indicate you are accepting the Callout

Reject – indicate you are rejecting the Callout

User Response – compose a free-form text message to send to the Callout originator
[customisable]

Delete – delete one or more Callouts

Details – view the details of the Callout message

Status – send or update your current Availability status. The Callout screen indicates that an Availability Status message has been sent. [customisable]

Responding to Callouts

When you respond to a Callout your radio may automatically send a message (if programmed in the radio) or you can select a message from a list or select **User Response** (if customised) to compose and send a free-form text message.

Callouts requiring a response

Some Callouts require a response. The following responses are possible:

Accept

Press **Accept** to indicate that you intend to act on the Callout (or select **Accept** from the pop-up menu displayed from the Left or Right navigation key. If only one acceptance message is programmed in your radio an informative message is displayed to show that it has been sent to the originator of the Callout. If multiple messages have been programmed, select one of them and press **Select** to send it. Alternatively (if customised) you can compose and send a free-form text message.

Depending how the Callout has been configured it may either exit once the acceptance message has been sent or it enter an Information Phase during which information may be sent to and received from the originator of the Callout. This could include a pre-set message, a free-form text message or a Callout group call.

Reject

Press **Reject** to indicate you do not intend to act on the Callout (or select **Reject** from the pop-up menu displayed from the Left or Right navigation key. Your radio exits from the Callout and Protected Callout Mode and the top level screen is displayed.

Standby

Select **Standby** to acknowledge receipt of the Callout and to indicate that you are “standing by” for further information before accepting or rejecting. During standby the Callout goes into its Information Phase during which information may be sent to and received from the originator of the Callout. During standby you can also accept or reject the Callout and—if use of the PTT is permitted—make group calls to the Callout group.

During Standby you can view the following Callout message details :

- the ‘Response required’ icon
- the Callout group
- time and date when the message was received
- the severity of the Callout Alert
- the Callout ID
- icons to show:
 - whether the Callout is to a group or an individual
 - whether the Callout is incoming or outgoing
 - whether or not the Callout is End-to-End Encrypted

User Response

Allows you to compose and send a free-form text message to the originator of the Callout.
[customisable]

Callouts not requiring a response

Some Callouts do not require a response. You can respond to or ignore them as follows:

Exit

Press the **Exit** context key to exit the Callout and return to the top level screen. No response message is sent.

Respond

Press the **Respond** context key to display the Information screen offering the various pre-set messages to send from the radio to the originator of the Callout and vice versa. To send one of the pre-set messages select it and press the **Select** context key.

User Response

You can compose and send a free-form text message to the originator of the Callout. When your message is ready to send press the **Confirm** context key. You can continue to respond and send messages as described here until the Callout ends and the top level screen is displayed.
[customisable]

Details

You can view the following Callout message details:

- the 'Response required' icon
- the Callout group
- time and date when the message was received
- the severity of the Callout Alert
- the Callout ID
- icons to show:
 - whether the Callout is to a group or an individual
 - whether the Callout is incoming or outgoing
 - whether or not the Callout is End-to-End Encrypted

Callout Test alert

If you receive a Callout Test Message either respond or cancel the alert:

- to cancel the Callout Test alert press the **Cancel** context key. The Callout exits and the radio displays the top level screen. You can still view the details from **Messages > Callouts**.
- to indicate that you are ready to respond to Callout alerts press **Respond** (or the Left or Right navigation key). The following response options are displayed:

Respond

Press the **Respond** context key to display the Response screen. Press the Right or Left navigation key to view additional options. To send a Test OK message to the Callout originator select it and press the **Select** context key. The Callout Test exits and the top level screen is displayed.

User Response

(If customised) allows you to compose and send a free-form text message to the originator of the Callout. When the message has been sent the Callout Test exits and the top level screen is displayed.

Details

The Details screen is displayed showing:

- the Callout Test icon
- an indication that the Callout Test has been sent to an individual
- the originator of the Callout Test message
- time and date when the message was received
- the severity of the Alert
- the Message ID
- icons to show :
 - whether the Callout is to a group or an individual
 - whether the Callout is incoming or outgoing
 - whether or not the Callout is encrypted

Press the **Back** context key to display the previous screen.

When a Callout ends

When a Callout times out or is cleared by the Callout originator the Callout ends, your radio displays the top level screen and the functionality which had been suspended is restored.

Protected Callout Mode

When it receives a Callout alert your radio goes into **Protected Callout Mode** (and many features are disabled) for a set time period or until you respond to or acknowledge the Callout message. This mode is designed to stop you getting distracted and to focus your attention on an incident.

During Protected Callout Mode you can only do the following:

- Read the current alerting message
- Acknowledge the Callout alert
- Make an Alarm Call

- Switch Transmit Inhibit on/off
- Make a Quick Call (if customised as a higher priority than Callout)

No calls—apart from group calls allowed by some Callouts—received while your radio is in Protected Callout Mode are connected but their details are saved. To view them after the Callout has ended select the Missed Event menu.

If you receive a new Callout while your radio is already in Protected Callout Mode, the new Callout takes priority and is displayed immediately. The existing Callout is treated as a missed Callout: to view its details after the Callout has ended select **Messages > Callout**. The Missed Call and/or Missed Callout icons display after the new Callout has ended.

Missed Callouts

To view information about the missed Callout select **Menu > Messages > Callout**.

Your radio ignores Callouts received when any of the following functions are active:

- Ongoing Alarm Call (a highest priority call)
- Alarm Call
- Quick Call (when customised as a higher priority than Callout)
- Smart Call 1 (when customised as a higher priority than Callout)
- Smart Call 2 (when customised as a higher priority than Callout)
- Group Focus
- Privacy Mode

When the higher priority function ends, the radio notifies you of the missed Callout by sounding an audible alert and displaying a  Missed Callout icon.

Callout display



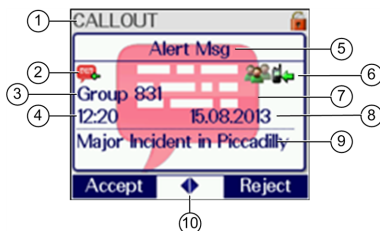









A typical Callout screen looks as follows:



Item	Description
1	Message location (Inbox)
2	Callout type, see <i>Callout icons</i> .

Item	Description
3	Callout group or Callout originator
4	Time received
5	Callout message header text (customisable)
6	Information icons
7	Backdrop image (customisable, radios with colour display only). Indicates severity of the Callout.
8	Date received
9	Explanatory text about the Callout
10	Left/Right Navigational keys available for more options

Callout icons

Icon	Description
	Callout Alert message, response required.
	Missed Callout
	Callout Alert message, user response has been sent.
	Callout Alert message, response not required.
	Callout Availability message.
	An information message has been received by the radio.
	An information message has been sent from the radio.
	Standby Message has been sent from the radio.
	Callout Test message, user response is required. The identity of the sender is displayed instead of the Callout group.
	Callout Test message, user response has been sent.
	The receiving radio and the Callout originator both have End-to-End Encryption active.
	Either the Callout originator or the receiving radio has End-to-End Encryption switched off.
	The Callout is addressed to an individual.

Icon	Description
	The Callout is addressed to a group.

Left and Right navigation keys

The  left and right arrow icons are displayed between the Context keys during Protected Callout Mode when there are more options than are shown on the Context keys.

EITHER:

- Press the Left or Right navigational keys to display a menu of the additional options available OR
- press the **Select/Send** key to action the first item in the menu of options. The  Select/Send Key Shortcut icon is displayed between the context keys to indicate that this shortcut is available.

Group calls to Callout group



While your radio is in Protected Callout Mode the only calls you can make are TETRA Alarm Calls, Quick Calls (if customised as a higher priority than Callout), and, if allowed, group calls to the Callout group. You can only make group calls if PTT use is permitted during the Callout.

For some Callouts your radio can make and/or receive group calls to a specially configured **Callout group** when it is in Protected Callout Mode. This group may be the group the radio is attached to when the Callout is received, or a different group which the radio is configured to connect to on receipt of the Callout or when an acceptance message is sent.

While the PTT is pressed and the radio is transmitting the text “Talk” is displayed in place of “CALLOUT” on the Radio Status Line at the top left of the screen and no backdrop is displayed. When the radio is receiving a group call the ISSI (or shortened ISSI) or identity of the transmitting party is displayed in place of “CALLOUT” on the Radio Status Line at the top left of the screen.

When the Callout has exited, depending on the customisation, the radio either reattaches to the group it was attached to before receiving the Callout, or remains attached to the new group.

Information Phase

Some Callouts do not exit after the initial acknowledgement is sent, but enter an Information Phase when information may be  sent to and  received from the originator of the Callout. Information can include a pre-set message, a free-form text message or a Callout group call. Your radio can also be customised to display a backdrop graphic to indicate it is in Information Phase.

When information is sent (for example “Will Respond”) it is displayed and the  information sent icon displays.

Press the **Exit** context key to exit from the Callout or the **Respond** context key to use an option on the Information screen or press a Left or Right navigational key to display a menu of further options.

For some Callouts, group calls can be made by the radio to the Callout group during the Information Phase if use of the PTT is permitted during the Callout.

The options available during the Information Phase are Information, Accept, Reject, User Response and Details.

Information

Send a pre-set information message. If only one Information message is programmed in the radio you are notified by an informative message confirming that the pre-programmed Information message has been sent to the originator of the Callout.

Alternatively you can select from a list of preconfigured messages. Select **View Response** to check the complete message text before sending it.

Accept

Sends an acceptance message to the originator of the Callout.

Reject

Send a rejection message. You are notified by an informative message confirming that the rejection message has been sent to the originator of the Callout, and your radio exits from the Callout and Protected Callout Mode and the top level screen is displayed.

User Response

Send a free-form text message.

Details

See the following Callout details:

- the 'Response required' icon
- the Callout group
- time and date when the message was received
- the severity of the Callout Alert
- the Callout ID
- icons to show:
 - whether the Callout is to a group or an individual
 - whether the Callout is incoming or outgoing
 - whether or not the Callout is End-to-End Encrypted

Features

Your radio can be customised for various advanced features and can have various soft keys assigned to frequently used features.

Privacy Screen

Your radio can be customised to display a picture when the screen is inactive for a specified period of time. This helps protect the privacy of any displayed information. This **Privacy Screen** feature is particularly useful if you are wearing your radio at shoulder level. The normal display reappears as soon as any activity occurs which turns on the back light.

User profiles 1

User profiles are pre-set combinations of alerts and settings on your radio. They allow you to switch settings easily to match your circumstances or environment. An icon  1 showing the number of the profile selected, appears on the status line or the Shortcut Bar. Up to ten pre-defined user profiles may be configured for your radio. Example user profiles could be *Normal*, **Lone Worker** and *Covert*.

To change the user profile:

1. From the Home screen, press the **Groups** context key 3 times (**User Profiles**).
2. Use the navigation keys or the **Navi-knob** to scroll through the user profiles.
3. Press the **Select** context key to activate the selected user profile.

Menu selection

1. Select **Menu > User Profiles**.
2. Navigate to a profile and press **Select**.

Example user profiles

Typical profiles could include:

Covert Mode operation

Covert Mode turns off all visual alerts. It deactivates the backlight and adjusts the microphone sensitivity to allow Whisper mode. It also reduces the level of the loudspeaker if an earpiece is not being used. If your radio has a vibrator alert enabled then this is deactivated. See **Whisper mode** on page 22.



Group Focus

This user profile allows you to prevent any individual calls or group calls from any talkgroup other than the selected talkgroup from being connected to your radio.

Any calls made to a radio which has Group Focus selected are not recorded as Missed Calls.



Do Not Disturb

This user profile allows you to focus on an important task. It assumes you do not want to be distracted by a call or alert on your radio. The profile sets your radio so that no incoming calls are allowed except calls from the current talkgroup (Group Focus above). Covert Mode operation is active. Audible alerts are disabled. If this profile is selected you cannot select Transmit Inhibit (see **Transmit Inhibit** on page 69

WAP



NOTE: WAP pages are not accessible when Wi-Fi is enabled on the radio.

Your radio may be configured to browse WAP pages. The browser options are customised using Radio Manager.

Starting the WAP browser

To open activate the WAP browser:

- select the **WAP** option from the **Applications** menu OR
- press a programmed soft key [customisable] OR
- open a WAP URL contained within a received SDS message (or your radio may be customised to open the WAP URL automatically). **Open a URL in a message** on page 63

Using WAP

Exiting the browser

Exit at any time by pressing **Back** or the Cancel/Home key (if customised).

Navigation

Press the Left navigation key to display the previous screen/page and the Right navigation key to display the next screen/page.

Entering text

If customised, your radio supports the entering of text to specify a URL and entering of data into a form, and so on. See **Text entry** on page 58.

Saving check box or radio button selections

Sometimes you may need to select an option which has a check box or radio button. When setting an option that uses a check box or radio button, toggle the left context key to select the appropriate option (radio button or check box). To save the selection either scroll to the bottom of the screen and highlight the Save button or press the Left context key (either a tick icon or labelled Save depending on customisation).

Browser menu

Home Page

Select to activate the WAP browser and display the browser's homepage contents. If customised, you can change the Home Page (**Settings > Settings > Homepage**).

Browse

Select to enter a URL to start browsing the internet for the site matching your URL.

You do not have to enter the URL specific input words (http://), they are already entered in the URL box.

Resume Browsing

Select after browsing has been suspended or when you have exited from the browser. The browser displays the last page viewed.

Bookmarks

Select to view all the available bookmarks, some of which may be collated into bookmark folders. If customised, you can create, edit and delete bookmarks and bookmark folders, and organise the bookmarks into different folders. If there are no saved bookmarks, the browser displays the bookmarks page and a warning message.

Settings

Select to view and edit your browser options. You can set the URL of the home page, enable/disable downloading of image files, change the scrolling method and the network connection timeout. There are also options to change security settings.

Help

Select when the browser is active to view any customisable help stored on your radio.

Navigation menu

Press **Homepage > Menu** from the WAP browser screen to access the Navigate options:

Home

Returns to the Home page on the WAP browser.

Open Page

Displays the 'Go to URL' screen (if customised).

Mark Page

Only visible if the radio is customised to allow the creation and/or editing of bookmarks. Creates a bookmark for future reference so that the web page may be downloaded quickly.

Forward/Back

Use these options to move to the next or previous page in the History (if more than one page is stored in History).

Reload

Reloads the current page.

Settings

Selecting **Settings** from the Browser menu provides access to the Advanced settings.

Advanced Settings

Homepage

Select this option to set the Home page. You can enter a new Home page URL and set it as the current and default home page.

Downloads

You can disable or enable the downloading of images, background sounds and objects when downloading information from a website. Disable this option to download the text content of an item quickly (a box containing a cross is displayed where the image would have been). If the downloading of images is enabled the boxes may be shown with a temporary display of a paper clip while the image is downloaded. Scroll to the **Save** option and press **Pick** to save the setting.

Scroll Mode

You can change the Scroll Mode to be Block or Smooth so that when scrolling through text, the display will either jump from one block of text to the next, or scroll smoothly. The scroll speed may also be set to Fast, Medium or Slow.

Key Press Timeout

This option allows you to set the Key Press Timeout to one of Fast, Medium, Slow or Off.

Connection Timeout

This options allows you to set the timer that specifies how long the browser will wait before cancelling idle network requests.

Resend Data Prompt

This option allows you to set (on/off) whether the browser confirms whether to resend data to the radio. This could be used for forms which are not stored locally in the browser cache and must be re-requested from the server.

Security settings

Secure Prompt

Select this option to set (on/off) whether the radio displays a warning message when it is changing from a secure connection to a non-secure connection and vice versa.

Current Certificate

If this option is selected, information about the digital certificate associated with the server which delivered the current document is displayed.

CA certificates

A certificate is a digital ID that is issued by a trusted third party known as a certificate authority (CA). The radio uses CA certificates to authenticate web sites which send information to the radio. To view information on a CA, select it and press View. You can choose which CAs are used by the radio by selecting on or off.

Send Referrer

If this option is used to set whether the browser sends the HTTP Referrer header as part of the HTTP requests.

Authentication

This option is used to set (on/off) whether the browser caches HTTP authentication credentials.

Certificate Info

If this option is selected, information about the root digital certificates installed in the browser is displayed.

Clear

Select this option to clear any or all of History, Cache or Cookies.

Restart Browser

Select this option to restart your browser.

About

Select this option to view information about the browser.

History menu

The History page displays a list of up to nine of the most recently viewed Browser pages. The currently viewed page is highlighted. To revisit a page listed in the History, select it and then press the Left context key.

If more than nine pages have been viewed, the list of all pages in the History is stored and may be accessed by selecting the 'More...' option. Press the Left context key, or the star (*) or hash (#) key, to open the 'More' page(s).

Exit history

Select this option to exit History and resume browsing at the page which was selected when the History Menu was chosen.

Show URL

Select this option to display the currently selected URL.

Delete

Select this option to delete the history.

Using bookmarks

A bookmark consists an internet address, the book mark title, and access point (and a user name and password if required by the web page). Bookmarks can be organised into folders to make it easier for you to find your favourite bookmarks or those of similar topics.

Any saved bookmarks and bookmark folders are listed and can be opened by either pressing the keypad key corresponding to the number of the bookmark or folder, or by selecting it and pressing **Go**.

New bookmarks and folders

If you have no saved bookmarks or folders, the screen displays the message '**No saved bookmarks**'. You can create up to 100 bookmarks and up to 10 folders (a single folder can contain 100 bookmarks).

Press **Bookmarks > Menu** to create your bookmarks.

New Bookmark

Select this option to create a new bookmark. Press the Edit key and enter the title of the bookmark, URL and select the folder. Select Save when done.

If you want to create a new folder for this bookmark, select the Bookmark option and press **Select**. Select the **New Folder** option and enter the details of the new folder.

New Folder

Select this option to create a new folder. Enter the name of the folder and press Save. The folder appears on the Bookmark menu and as an selectable option when creating a new bookmark.

Bookmark and folder options

You can perform the following functions on a selected bookmark or folder:

- **Details** - shows the details of the selected bookmark or folder.
- **Delete** - allows you to delete the current bookmark or folder.

- **New Bookmark** - creates a new bookmark.
- **New Folder** - creates a new bookmark folder within the list of bookmarks and folders.
- **Move** - Move the bookmark or folder within the list of folders and bookmarks. Select the bookmark or folder, then enter the number corresponding to the position in the numbered list where you want the bookmark or folder.
- **Delete All** - deletes all bookmarks and/or folders that are displayed in the same list as the selected folder.
- **Hotkeys** - allows you to create Hotkeys, but if any soft keys have been customised on the radio which are not related to the WAP browser the Hotkeys function will not function.

Additionally, the following options are available for bookmarks:

Move to folder -allows you to move the bookmark into a folder, and name the folder.

Set as Homepage - allows you to set the page as your Home page in the browser. This page is displayed when you select the 'Go to Homepage' card.

Call handling

Outgoing

While the browser is active it is possible to make a group call to the attached talkgroup by pressing the PTT. If a talkgroup has not been attached, the user may select a talkgroup (see section on Group Calls). During an outgoing call the browser remains active but you will only be able to view the current page and pages which have already been viewed.

When a call is in progress and the browser page is displayed, pressing and holding the Right navigation key allows you to view the call information box. If the call information box is displayed while the call continues, the browser page may again be displayed by pressing and holding the Left navigation key, or simply pressing either of the Left and Right navigation keys.

It is not possible to make an individual voice call while the browser is active. In order to do this, close the browser by pressing and holding the Cancel/Home key, if customised. When the call is set up and is ongoing it is possible to return to the browser either by selecting a card which allows this (Resume Browsing) and pressing the Down navigation key or by using a soft key (if customised). When the browser has been re-activated and the call is ongoing it is possible to switch between displaying the call information box and the browser using the Left and Right navigation keys as described above.

During an outgoing individual call the browser remains active but the user is only able to view the current page and pages that have already been viewed.

If the user makes a Alarm Call while the browser is active, the browser will automatically be closed and the radio will display the top level screen in Call Mode.

Incoming

When an individual call is received while the browser is active, the call information box is visible on top of the browser and you can answer the call. If an Alarm Call is received the browser closes and

the radio displays the Home screen, allowing you to respond to the call. You can still make a group call attached to a talkgroup but not a telephone type call whilst the browser is open.

SDS messages

If an incoming SDS message is received while the browser is active and the message is marked for immediate display then the browser will close and the SDS message is displayed. If the received SDS message is not marked for immediate display the browser will remain active and a warning triangle appears and the LED will flash. It is not possible to send an SDS message while the browser is active.

Mode change (TMO, DMO AND GMO)

If the radio is switched to Direct Mode Operation (DMO) while the browser is active, the browser remains active and you may view any stored pages. A warning message is displayed because the browser is off line.

Keypad lock

If a keypad lock soft key has been customised so that the keypad lock may be selected by pressing and holding the soft key, the browser will close and the radio will display the top level screen.

Transmit Inhibit

If the radio is operating in Transmit Inhibit mode, you can still view any pages in the browser that have been stored locally but it is not possible to browse pages online. If an attempt is made to browse pages online, the browser active icon flashes and a warning message appears.

Location Services

Your radio may be customised and enabled for location services, such as GPS or other regional Global Navigation Satellite Systems (GNSS), that allows the radio to determine your location (longitude, latitude and altitude) and provides both timed- and distance-based reporting.

The generic location services function on the radio is called 'GPS' and it provides support for multiple regional GNSS including BeiDou2.

The behaviour of the GNSS function is highly customisable, both by customisation of the radio and over the air from a control room application. Your radio may also be customised to send position data automatically alongside TETRA Alarm Calls or Status messages. The destination to which any reports are sent may be changed over the air. If your radio accepts a change of destination command it sounds a customisable tone and sends you an SDS message to inform you.

If customised, you can enable/disable the GNSS function, see **Reporting options** on the next page.

GLONASS is only supported on SRG3900 radios with serial numbers whose 4th digit is 'C' or above (that is, beginning with '2PNC'.)

For the best performance, your radio needs an uninterrupted view of the sky.

Position

To locate your position

1. Select **Menu > GPS > Position > Locate**.

While the position is being calculated the  icon flashes.

Position information

When the position has been determined the following information is displayed:

- **Latitude and Longitude** values.
- **Fix** indicates how accurate the reading is:
 - 2D** indicates that less than four satellites were used to determine the position
 - 3D** indicates that at least four satellites were used.The number in brackets indicates how many satellites were used.
- **Age** shows how long ago the position was first displayed; to refresh the reading press **Locate** again.
- **GPS/BeiDou2** shows the number of satellites used in the selected system. Note that the name of the selected GNSS is customisable.

Direction

To read the direction in which your radio is travelling

1. Select **Menu >GPS > Direction**.

The Direction screen gives information about the current direction and speed of travel. If the radio is stationary no information is displayed. However if the radio becomes stationary after a period of movement the direction information is displayed for five seconds to give you time to view it.

- **Direction** is reported in degrees from North.
- **Speed** is reported in either km/h or miles/h depending on the customisation.

Reporting options

To control reporting from your radio

1. Press **Menu > GPS > GPS Report**.
2. Select one of the following options:
 - **Never Send** – reporting is disabled regardless of any instructions sent over the air. The  warning icon is displayed on the top line of the screen as a reminder that reporting has been explicitly disabled.
 - **Always Send** – reporting is enabled regardless of any instructions sent over the air.
 - **No Override** – your radio will respond to instructions sent over the air. Reports are sent if requested and is switched off if requested.

GNSS selection

The radio may be customised to support a number of satellite systems such as GPS and BeiDou2.

To change your GNSS selection:

When the radio has rebooted, check your satellite connections using the GPS **Locate** function (**Menu >GPS > Position > Locate**) to view the type and number of satellites available in the selected system.

Security

Sometimes when you are working, you may need to secure your radio from unauthorised use. The easiest way to secure your radio is to lock the keypad when your radio is not in use. Your radio may be customised with other security features such as PIN entry and a remote user network log on (to authenticate network users).

End-to-End Encryption

If your radio shows the  Secure Comms icon when it is idle, the selected talkgroup is customised for **End-to-End Encryption (E2EE)**. In other words, calls you make by pressing PTT are end-to-end encrypted.

It is not possible to accidentally make a non end-to-end encrypted call. Every talkgroup or individual subscriber that can be exempt from End-to-End Encryption must be explicitly customised into the radio.

End-to-End Encryption is designed to provide maximum security for voice and SDS communications, whether operating in Direct Mode or Trunked Mode, irrespective of the security level provided by the network. Depending on customisation, the radio may change the End-to-End Encryption status when the selected network is changed. It may also provide a selection of talkgroups on other networks. If a talkgroup is selected that does not belong to the current network, your radio will change network accordingly.

A radio that supports End-to-End Encryption may nevertheless be required to make calls that are not end-to-end encrypted. For example, calls to certain talkgroups and individual subscribers may be customised to be exempt from End-to-End Encryption. All telephone calls are also not end-to-end encrypted.

When dialling, a separate  Secure Comms icon is displayed in the dial box if the call or SDS will be End-to-End encrypted. During voice calls only (not SDS calls) your radio may allow you to toggle End-to-End Encryption on/off with a soft key.

When you are in a voice call, the Secure Comms icon indicates whether End-to-End Encryption is operational. When the radio participates in a call that is not end-to-end encrypted, a periodic non intrusive audible alert is generated (if customised).

When you receive an SDS (text) message or picture messages, if you see the Secure Comms icon in the message details that the message was end-to-end encrypted.

If the message 'Security Check Fail' is displayed while making or receiving calls, it indicates that the radio has not been customised properly. In such cases, please contact technical support in your organisation.

Updating E2EE keys

End-to-End Encryption keys are automatically updated when the radio registers on the network when it powers on, and whenever the Key Management Centre (KMC) on the network broadcasts

them.

If E2EE traffic keys become outdated—which can happen in poor network coverage conditions—you can manually update them as described here.

Manual key update is not supported on radios which rely on a Smartcard for E2EE.

During a manual update any active ongoing non-emergency call or ambience listening calls are cleared.(Any active emergency calls are maintained.)

Manual update requires good network conditions.

To manually update E2EE keys

Your radio must be in TMO mode to update E2EE keys.

Either press a suitably customised soft key or use the following procedure:

1. Press **Menu** then select **Security > Crypto Settings**.
2. Scroll to **New Key** and press **Send**.

When the key update is in progress the  **Key agreement** status icon appears.

Zeroising

Radios that support End-to-End Encryption are loaded with sensitive cryptographic keys. To avoid a potential security compromise, you may be able to delete (zeroise) these cryptographic keys if permitted by your operational procedures.

Please refer to your Security Officer for details on how to zeroise your radio as well as related operational procedures.

Asset management

Handsets, consoles, radios and accessories are assets that need to be effectively managed throughout their life cycle. In some organisations it is a requirement to track assets and this can be done by labelling them.

Asset management refers to the periodic maintenance of your radios. Maintenance includes software upgrades and reprogramming of the radio to ensure that it continues to meet your requirements.

Labelling

The simplest form of asset management is to attach labels to your radios. Self adhesive labels (those with an adhesive backing) are recommended as they are easy to apply and commercially available, such as 3M™ Thermal Transfer Polyester label material 7815.

Do not use solvent based adhesives. Always check the adhesive used with the self-adhesives label.

Do not engrave any part of the radio. Engraving the radio's casing may affect the compliance ratings and may invalidate the product warranty.

Do not use paint, correction fluid or other forms of liquid or aerosol to write or mark the radio or an accessory. Chemicals may affect the radio's casing and invalidate the compliance ratings and product warranty.

Customising your radio

Your radio has a large number of parameters that can be customised using the programming software tool, Radio Manager 2. These parameters are grouped into a series of templates that can be easily modified to suit the end user's preferences. A complete set of parameters for your radio is called a **customisation**.

Your radio is customised by directly connecting it to a computer running Radio Manager 2 software using a Sepura Data/Programming Cable.

To program a single radio

A data/programming cable, with either an RS232 (D-type) connector or a USB connector, is available from Sepura for customising a single radio.

A data/programming cable, with either an RS232 (D-type) connector or a USB connector, is available from Sepura for customising a single radio.

To program your radio

To program the radio you need to connect it to the computer with a programming cable. If the radio is disconnected from the vehicle a power lead is also required. If the radio cannot be easily accessed, customisation can be performed through the console or an Applications Interface Unit (AIU).

Connect the radio (or console or AIU) to a computer running Radio Manager and start your customisation. Contact Sepura for more information on programming your radio.

Revert radio settings to customisation settings

Users have the ability to add personal data to the radio, such as adding contacts to the phonebook, changing the talkgroups and sending and receiving SDS/Status messages. Such changes may be undesirable on fleet radios that have been specifically customised for fleet users—where radios are not personal possessions. Using the **Revert All Changes** option, the radio settings can be reset back to the last customisation settings.

There is also a **Revert Non-Personal Changes** option that allows users to reset the radio settings back to the last customisation, but keep their personal changes to the phonebook, talkgroups and messages.

To revert the radio settings:

1. Select **Menu>Options>Settings**, then select the **Revert User Changes** option.
2. Select the option you require. Press the Select key.
3. Confirm the request to revert the radio settings to the last customisation. Press the Select key.

On completion of the revert process, the radio will reboot.

www.linkedin.com/sepurapl



www.facebook.com/sepurapl



[@sepurapl](https://twitter.com/sepurapl)



www.instagram.com/sepurapl



www.youtube.com/sepurapl



Contact Details

Sepura Limited

9000 Cambridge Research Park

Beach Drive, Waterbeach

Cambridge, CB25 9TL

United Kingdom

www.sepura.com