

# FCC and ISED Test Report

Sepura Ltd  
Handheld TETRA radio, Model: SC2124

In accordance with FCC 47 CFR Part 15C,  
FCC 47 CFR Part 90, ISED RSS-247 and  
ISED RSS-119 (Simultaneous Transmission)  
(TETRA and 2.4 GHz WLAN)

Prepared for: Sepura Ltd  
9000 Cambridge Research Park  
Beach Drive, Waterbeach, Cambridge  
CB25 9TL  
United Kingdom



Add value.  
Inspire trust.

FCC ID: XX6SC2124W

IC: 8739A-SC2124

## COMMERCIAL-IN-CONFIDENCE

Document 75952740-02 Issue 01

### SIGNATURE

NAME	JOB TITLE	RESPONSIBLE FOR	ISSUE DATE
Steve Marshall	Senior Engineer	Authorised Signatory	04 August 2021

Signatures in this approval box have checked this document in line with the requirements of TUV SUD document control rules.

### ENGINEERING STATEMENT

The measurements shown in this report were made in accordance with the procedures described on test pages. All reported testing was carried out on a sample equipment to demonstrate limited compliance with FCC 47 CFR Part 15C, FCC 47 CFR Part 90, ISED RSS-247 and ISED RSS-119. The sample tested was found to comply with the requirements defined in the applied rules.

RESPONSIBLE FOR	NAME	DATE	SIGNATURE
Testing	Graeme Lawler	04 August 2021	

FCC Accreditation

90987 Octagon House, Fareham Test Laboratory

ISED Accreditation

12669A Octagon House, Fareham Test Laboratory

### EXECUTIVE SUMMARY

A sample of this product was tested and found to be compliant with FCC 47 CFR Part 15C: 2019, FCC 47 CFR Part 90: 2019, ISED RSS-247: Issue 2 (2017-02) and ISED RSS-119: Issue 12 (2015-05) for the tests detailed in section 1.3.



### DISCLAIMER AND COPYRIGHT

This non-binding report has been prepared by TÜV SÜD with all reasonable skill and care. The document is confidential to the potential Client and TÜV SÜD. No part of this document may be reproduced without the prior written approval of TÜV SÜD. © 2021 TÜV SÜD. This report relates only to the actual item/items tested.

### ACCREDITATION

Our UKAS Accreditation does not cover opinions and interpretations and any expressed are outside the scope of our UKAS Accreditation. Results of tests not covered by our UKAS Accreditation Schedule are marked NUA (Not UKAS Accredited).

TÜV SÜD  
is a trading name of TÜV SÜD Ltd  
Registered in Scotland at East Kilbride,  
Glasgow G75 0QF, United Kingdom  
Registered number: SC215164

TÜV SÜD Ltd is a  
TÜV SÜD Group Company

Phone: +44 (0) 1489 558100  
Fax: +44 (0) 1489 558101  
[www.tuvsud.com/en](http://www.tuvsud.com/en)

TÜV SÜD  
Octagon House  
Concorde Way  
Fareham  
Hampshire PO15 5RL  
United Kingdom



## Contents

<b>1</b>	<b>Report Summary .....</b>	<b>2</b>
1.1	Report Modification Record.....	2
1.2	Introduction.....	2
1.3	Brief Summary of Results .....	3
1.4	Application Form .....	4
1.5	Product Information .....	7
1.6	Deviations from the Standard.....	7
1.7	EUT Modification Record .....	7
1.8	Test Location .....	7
<b>2</b>	<b>Test Details .....</b>	<b>8</b>
2.1	Radiated Spurious Emissions (Simultaneous Transmission) .....	8
2.2	ERP/EIRP Verification.....	28
<b>3</b>	<b>Measurement Uncertainty .....</b>	<b>30</b>



# 1 Report Summary

## 1.1 Report Modification Record

Alterations and additions to this report will be issued to the holders of each copy in the form of a complete document.

Issue	Description of Change	Date of Issue
1	First Issue	04-August-2021

**Table 1**

## 1.2 Introduction

Applicant	Sepura Ltd
Manufacturer	Sepura Ltd
Model Number(s)	SC2124
Serial Number(s)	1PR002110GMS80T
Hardware Version(s)	Production
Software Version(s)	2001 833 07367
Number of Samples Tested	1
Test Specification/Issue/Date	FCC 47 CFR Part 15C: 2019 FCC 47 CFR Part 90: 2019 ISED RSS-247: Issue 2 (2017-02) ISED RSS-119: Issue 12 (2015-05)
Order Number	PLC-PO019693-1
Date	07-July-2021
Date of Receipt of EUT	05-July-2021
Start of Test	06-July-2021
Finish of Test	28-July-2021
Name of Engineer(s)	Graeme Lawler
Related Document(s)	ANSI C63.26: 2015 ANSI C63.10: 2013



### 1.3 Brief Summary of Results

A brief summary of the tests carried out in accordance with FCC 47 CFR Part 15C, FCC 47 CFR Part 90, ISED RSS-247 and ISED RSS-119 is shown below.

Section	Specification Clause				Test Description	Result	Comments/Base Standard
	Part 15C	Part 90	RSS-247	RSS-119			
Configuration and Mode: TETRA and 2.4 GHz WLAN							
2.1	15.247 (d) and 15.209	90.210 (b)	5.5	5.8	Radiated Spurious Emissions (Simultaneous Transmission)	Pass	
2.2	-	90.205 (h)	-	5.4	ERP/EIRP Verification	Pass	TETRA only.

**Table 2**



## 1.4 Application Form

### Equipment Description

Technical Description: <i>(Please provide a brief description of the intended use of the equipment including the technologies the product supports)</i>	SC2124 handheld portable TETRA radio with GNSS, Bluetooth and WLAN functionality	
Manufacturer:	Sepura	
Model:	SC2124	
Part Number:	SC2124, 330-00016	
Hardware Version:	Production	
Software Version:	2001 833 07367	
FCC ID of the product under test – <a href="#">see guidance here</a>	XX6SC2124W	
IC ID of the product under test – <a href="#">see guidance here</a>	8739A-SC2124	

**Table 3**

### Intentional Radiators

Technology	TETRA	WLAN	Bluetooth			
Frequency Range (MHz to MHz)	420-470	2412-2462	2402-2480			
Conducted Declared Output Power (dBm)	35	17.08	7			
Antenna Gain (dBi)	>-1	1.3	1.3			
Supported Bandwidth(s) (MHz) (e.g 1 MHz, 20 MHz, 40 MHz)	0.025 0.022	20 40	1			
Modulation Scheme(s) (e.g GFSK, QPSK etc)	$\pi/4$ DQPSK	CCK DBPSK DQPSK QPSK BPSK 16QAM 64QAM	$\pi/4$ DQPSK GFSK 8DPSK			
ITU Emission Designator <a href="#">(see guidance here)</a> (not mandatory for Part 15 devices)	22K0DXW 20K0DXW	19M7G1D 19M7D1D 36M8D1D	1M81F1D 1M01F1D 1M01G1D			
Bottom Frequency (MHz)	420	2412	2402			
Middle Frequency (MHz)	445	2437	2441			
Top Frequency (MHz)	470	2462	2480			

**Table 4**



Un-intentional Radiators

Highest frequency generated or used in the device or on which the device operates or tunes	2480 MHz
Lowest frequency generated or used in the device or on which the device operates or tunes	32.768 kHz
Class A Digital Device (Use in commercial, industrial or business environment) <input checked="" type="checkbox"/>	
Class B Digital Device (Use in residential environment only) <input type="checkbox"/>	

**Table 5**

Battery Power Source

Voltage:	7.4	V
End-point voltage:	6.29	V (Point at which the battery will terminate)
Alkaline <input type="checkbox"/> Leclanche <input type="checkbox"/> Lithium <input checked="" type="checkbox"/> Nickel Cadmium <input type="checkbox"/> Lead Acid* <input type="checkbox"/> *(Vehicle regulated)		
Other <input type="checkbox"/>	Please detail:	

**Table 6**

Charging

Can the EUT transmit whilst being charged	Yes <input checked="" type="checkbox"/> No <input type="checkbox"/>
---	---

**Table 7**

Temperature

Minimum temperature:	-20	°C
Maximum temperature:	60	°C

**Table 8**

Cable Loss

Adapter Cable Loss (Conducted sample)	N/A	dB
---------------------------------------	-----	----

**Table 9**

Antenna Characteristics

Antenna connector <input checked="" type="checkbox"/>	State impedance		Ohm
Temporary antenna connector <input type="checkbox"/>	State impedance		Ohm
Integral antenna <input checked="" type="checkbox"/>	Type: Integral	Gain	1.3 dBi
External antenna <input checked="" type="checkbox"/>	Type: Extended Helical	Gain	>-1 dBi
For external antenna only: Standard Antenna Jack <input checked="" type="checkbox"/> If yes, describe how user is prohibited from changing antenna (if not professional installed): Equipment is only ever professionally installed <input checked="" type="checkbox"/> Non-standard Antenna Jack <input type="checkbox"/>			

**Table 10**



Ancillaries (if applicable)

Manufacturer:		Part Number:	
Model:		Country of Origin:	

**Table 11**

I hereby declare that the information supplied is correct and complete.

Name: Chris Beecham

Position held: Conformance Engineer

Date: 04 July 2021



## 1.5 Product Information

### 1.5.1 Technical Description

SC2124 handheld portable TETRA radio with GNSS, Bluetooth and WLAN functionality.

### 1.6 Deviations from the Standard

No deviations from the applicable test standard were made during testing.

### 1.7 EUT Modification Record

The table below details modifications made to the EUT during the test programme.

The modifications incorporated during each test are recorded on the appropriate test pages.

Modification State	Description of Modification still fitted to EUT	Modification Fitted By	Date Modification Fitted
Model: SC2124, Serial Number: 1PR002110GMS80T			
0	As supplied by the customer	Not Applicable	Not Applicable

**Table 12**

### 1.8 Test Location

TÜV SÜD conducted the following tests at our Fareham Test Laboratory.

Test Name	Name of Engineer(s)	Accreditation
Configuration and Mode: TETRA and 2.4 GHz WLAN		
Radiated Spurious Emissions (Simultaneous Transmission)	Graeme Lawler	UKAS
ERP/EIRP Verification	Graeme Lawler	UKAS

**Table 13**

Office Address:

TÜV SÜD  
Octagon House  
Concorde Way  
Fareham  
Hampshire  
PO15 5RL  
United Kingdom





## 2 Test Details

### 2.1 Radiated Spurious Emissions (Simultaneous Transmission)

#### 2.1.1 Specification Reference

FCC 47 CFR Part 15C, Clause 15.247(d) and 15.209  
FCC 47 CFR Part 90, Clause 90.210 (b)  
ISED RSS-247. Clause 5.5  
ISED RSS-119: Clause 5.8

#### 2.1.2 Equipment Under Test and Modification State

SC2124, S/N: 1PR002110GMS80T - Modification State 0

#### 2.1.3 Date of Test

06-July-2021 to 28-July-2021

#### 2.1.4 Test Method

A preliminary profile of the Radiated Spurious Emissions was obtained up to the 5th harmonic by operating the EUT on a remotely controlled turntable within a semi-anechoic chamber.

Measurements of emissions from the EUT were obtained with the Measurement Antenna in both Horizontal and Vertical Polarisations. The profiling produced a list of the worst-case emissions together with the EUT azimuth and antenna polarisation.

Testing was performed in accordance with ANSI C63.26, Clause 5.5.

Prescans and final measurements were performed using the direct field strength method. Field strength measurements were performed and then converted to Equivalent Power Measurements in accordance with ANSI C63.26, Clause 5.2.7 equation c)

Example calculation:

$E \text{ (dBuV/m)} + 20\log(d) - 104.8 = \text{EIRP (dBm)}$  where (d) is the measurement distance.

$82.2 \text{ (dBuV/m)} + 20\log(3) - 104.8 = \text{EIRP (dBm)}$

$-13.0 = \text{EIRP (dBm)}$

### 2.1.1 Example Test Setup Diagram

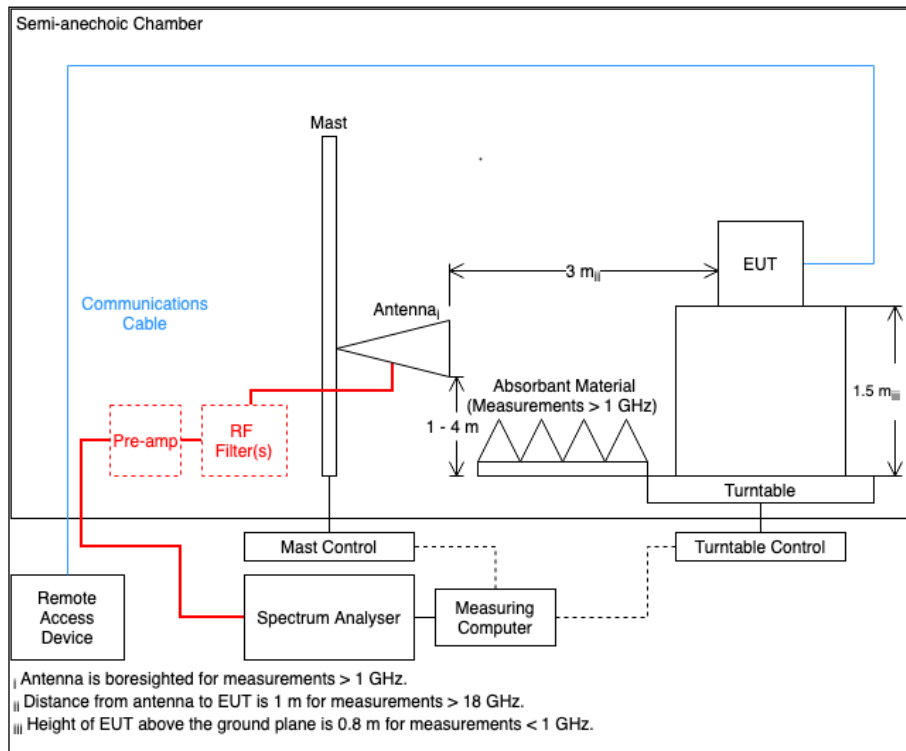


Figure 1

### 2.1.2 Environmental Conditions

Ambient Temperature 19.2 - 22.7 °C  
Relative Humidity 52.8 - 67.4 %



**2.1.3 Test Results**

TETRA and 2.4 GHz WLAN

The EUT was configured for simultaneous transmission in the following mode of operation:

Technology	Frequency Band (MHz)	Channel Frequency (MHz)
802.11b	2400 to 2483.5	2437
TETRA - FCC	450 to 470	460.025
TETRA - RSS	406 to 430	418.050

**Table 14 - Modes of Operation**

Frequency (MHz)	Level (dBm)	Limit (dBm)	Margin (dB)	Detector	Angle (°)	Height (cm)	Polarisation
*							

**Table 15 - 30 MHz to 25 GHz - FCC - X Orientation**

\* No emissions were detected within 10 dB of the limit.

Frequency (MHz)	Level (dBm)	Limit (dBm)	Margin (dB)	Detector	Angle (°)	Height (cm)	Polarisation
*							

**Table 16 - 30 MHz to 25 GHz – FCC - Y Orientation**

\* No emissions were detected within 10 dB of the limit.

Frequency (MHz)	Level (dBm)	Limit (dBm)	Margin (dB)	Detector	Angle (°)	Height (cm)	Polarisation
*							

**Table 17 - 30 MHz to 25 GHz - FCC - Z Orientation**

\* No emissions were detected within 10 dB of the limit.



Frequency (MHz)	Level (dBm)	Limit (dBm)	Margin (dB)	Detector	Angle (°)	Height (cm)	Polarisation
*							

**Table 18 - 30 MHz to 25 GHz - RSS - X Orientation**

\* No emissions were detected within 10 dB of the limit.

Frequency (MHz)	Level (dBm)	Limit (dBm)	Margin (dB)	Detector	Angle (°)	Height (cm)	Polarisation
*							

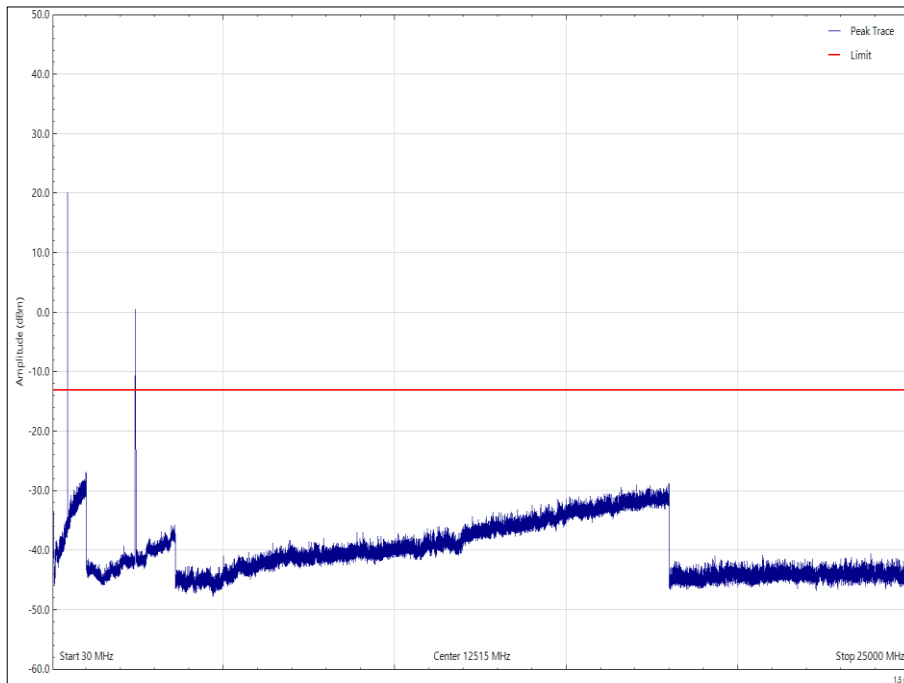
**Table 19 - 30 MHz to 25 GHz - RSS - Y Orientation**

\* No emissions were detected within 10 dB of the limit.

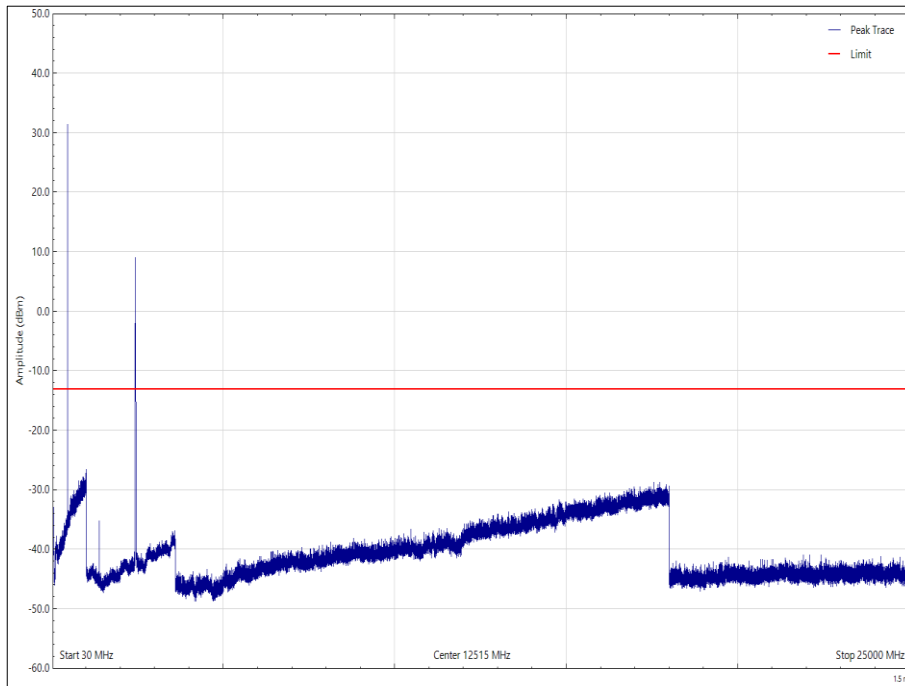
Frequency (MHz)	Level (dBm)	Limit (dBm)	Margin (dB)	Detector	Angle (°)	Height (cm)	Polarisation
*							

**Table 20 - 30 MHz to 25 GHz - RSS - Z Orientation**

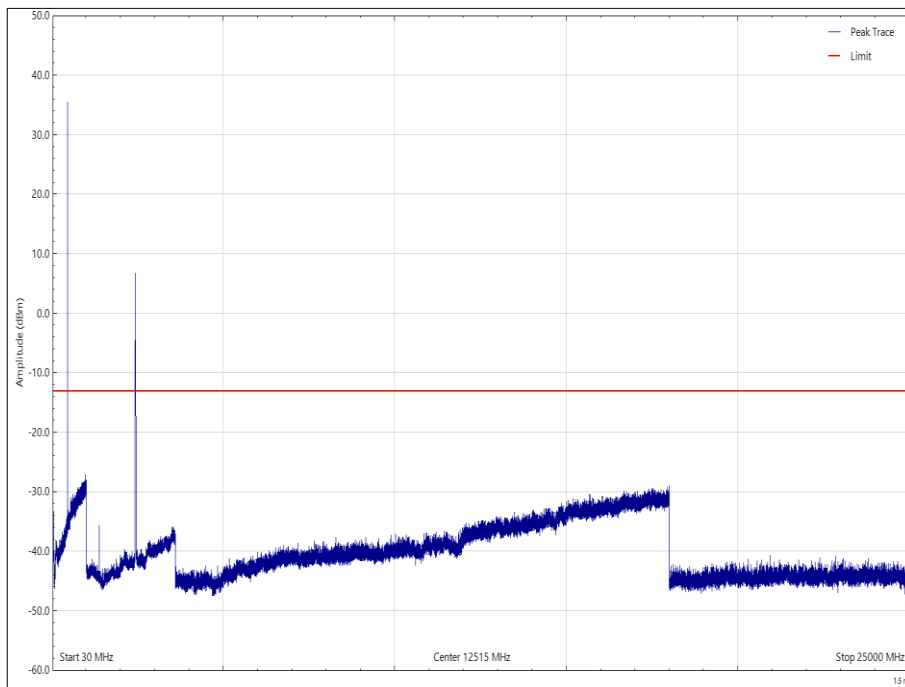
\* No emissions were detected within 10 dB of the limit.



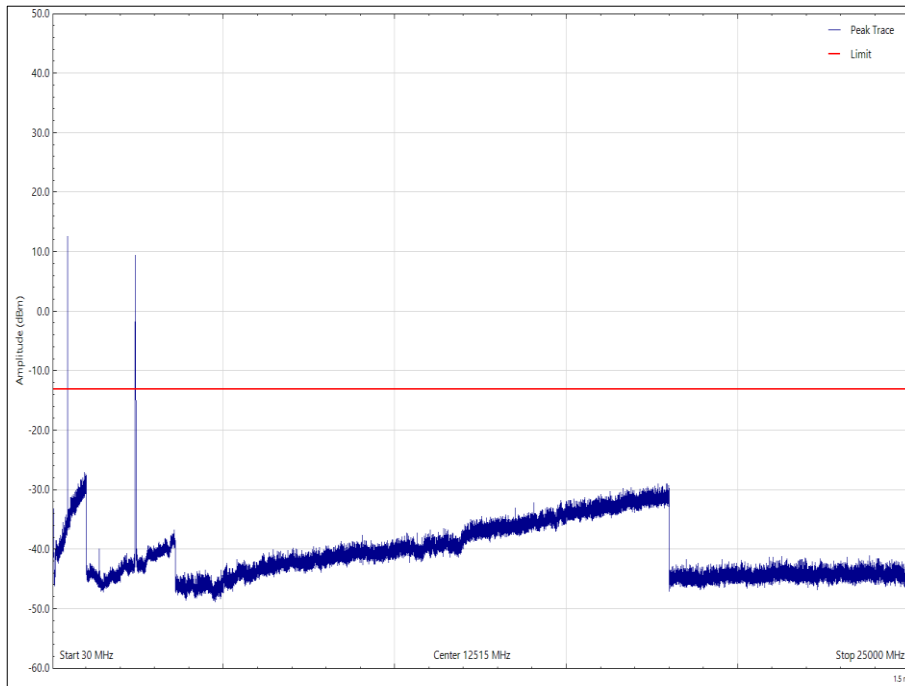
**Figure 2 - 30 MHz to 25 GHz - FCC - X Orientation, Peak, Vertical**



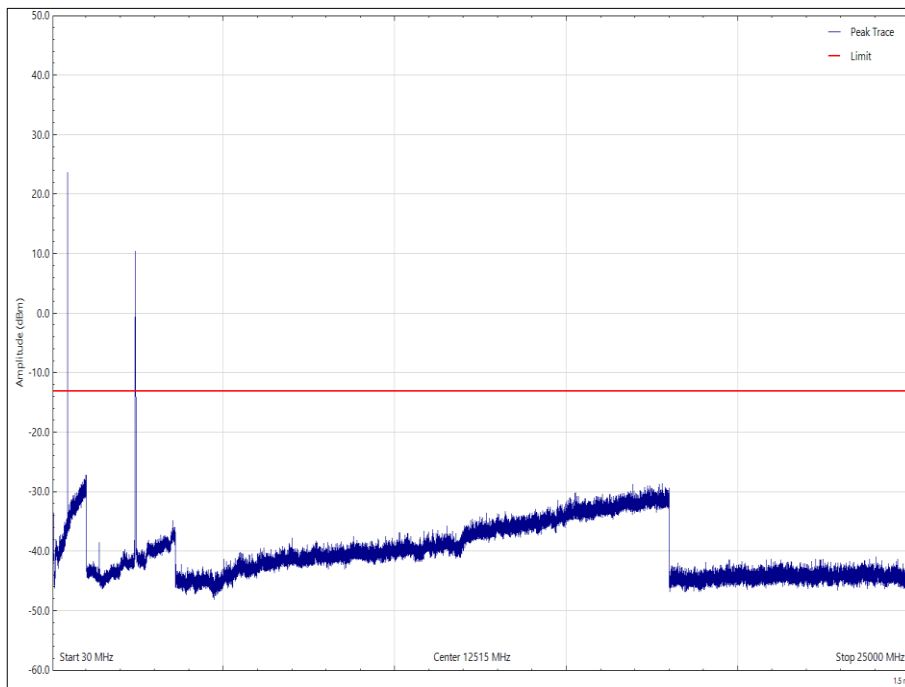
**Figure 3 - 30 MHz to 25 GHz - FCC - X Orientation, Peak, Horizontal**



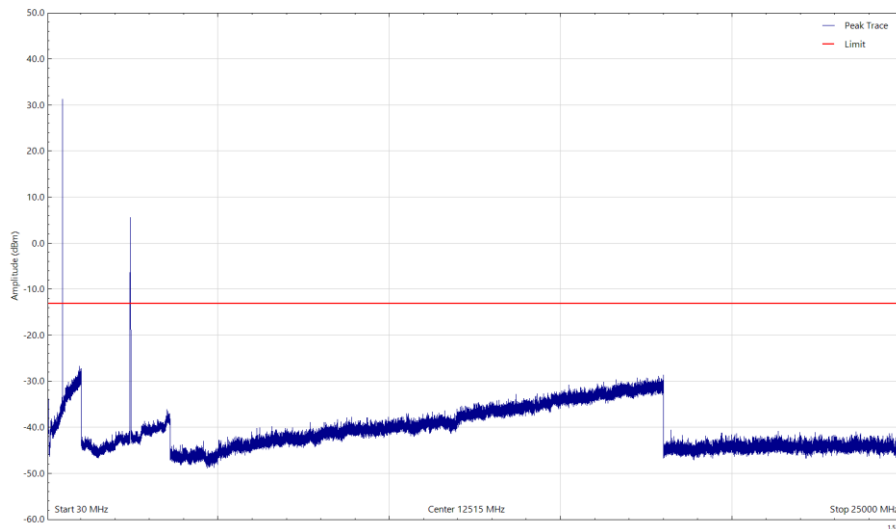
**Figure 4 - 30 MHz to 25 GHz - FCC - Y Orientation, Peak, Vertical**



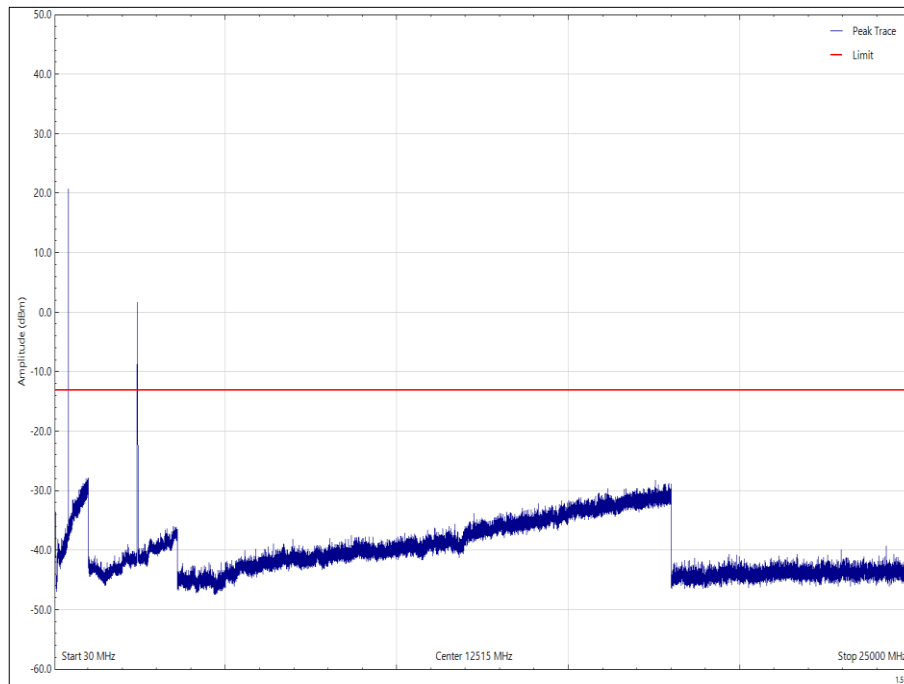
**Figure 5 - 30 MHz to 25 GHz - FCC - Y Orientation, Peak, Horizontal**



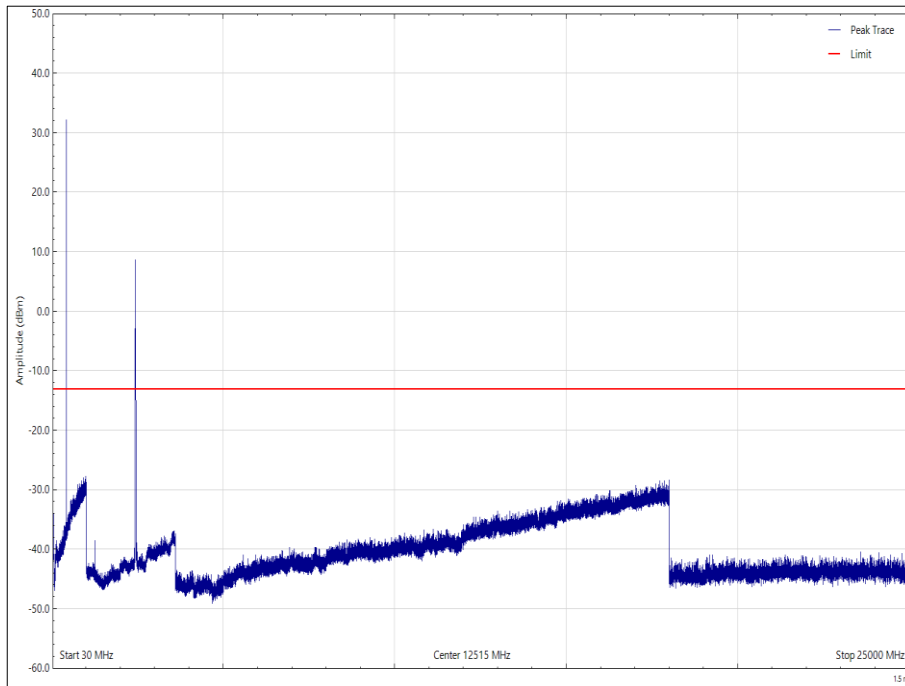
**Figure 6 - 30 MHz to 25 GHz - FCC - Z Orientation, Peak, Vertical**



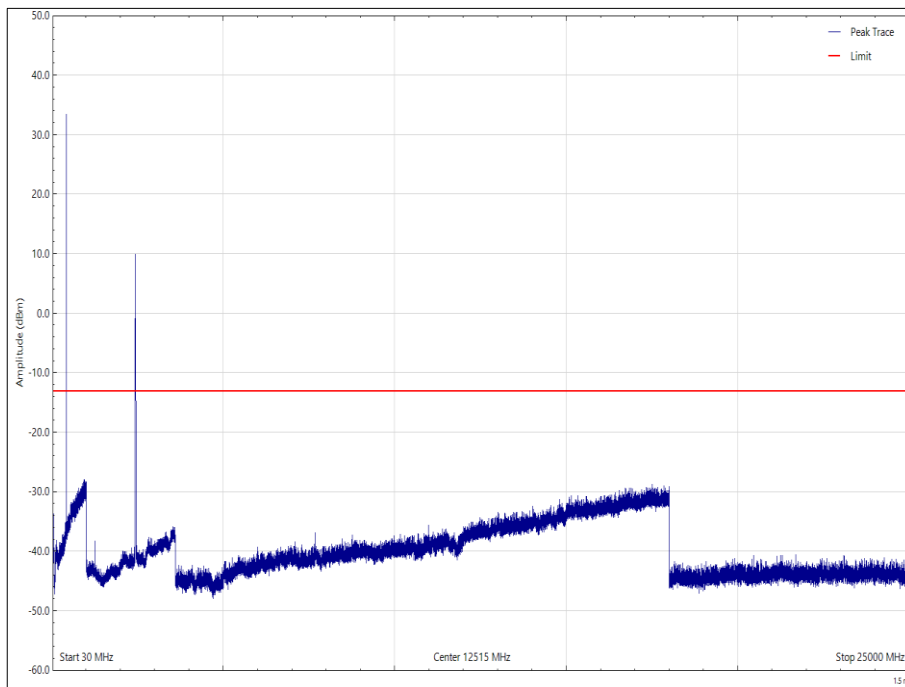
**Figure 7 - 30 MHz to 25 GHz - FCC - Z Orientation, Peak, Horizontal**



**Figure 8 - 30 MHz to 25 GHz - RSS - X Orientation, Peak, Vertical**

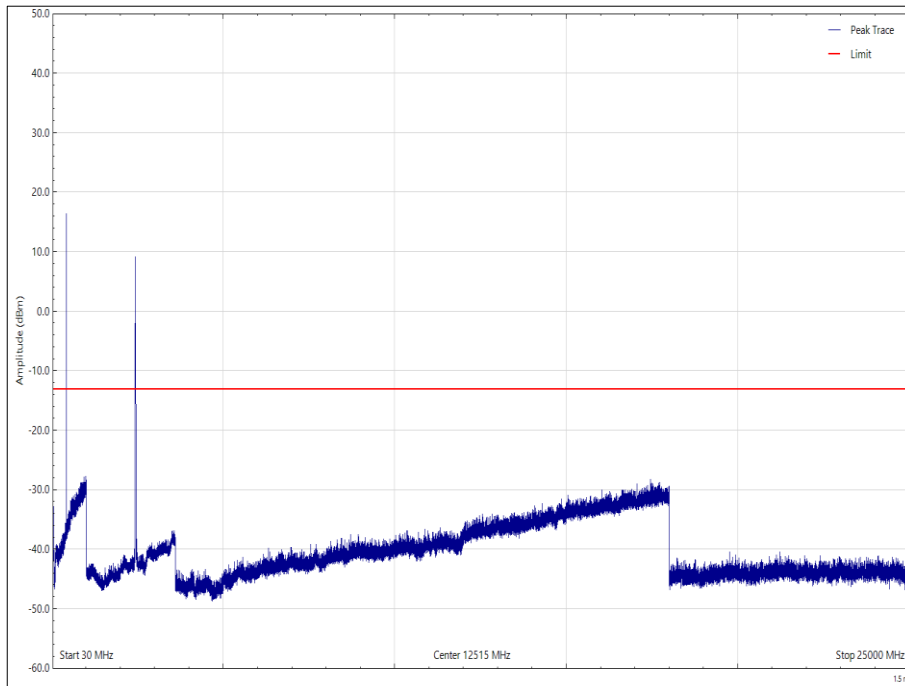


**Figure 9 - 30 MHz to 25 GHz - RSS - X Orientation, Peak, Horizontal**

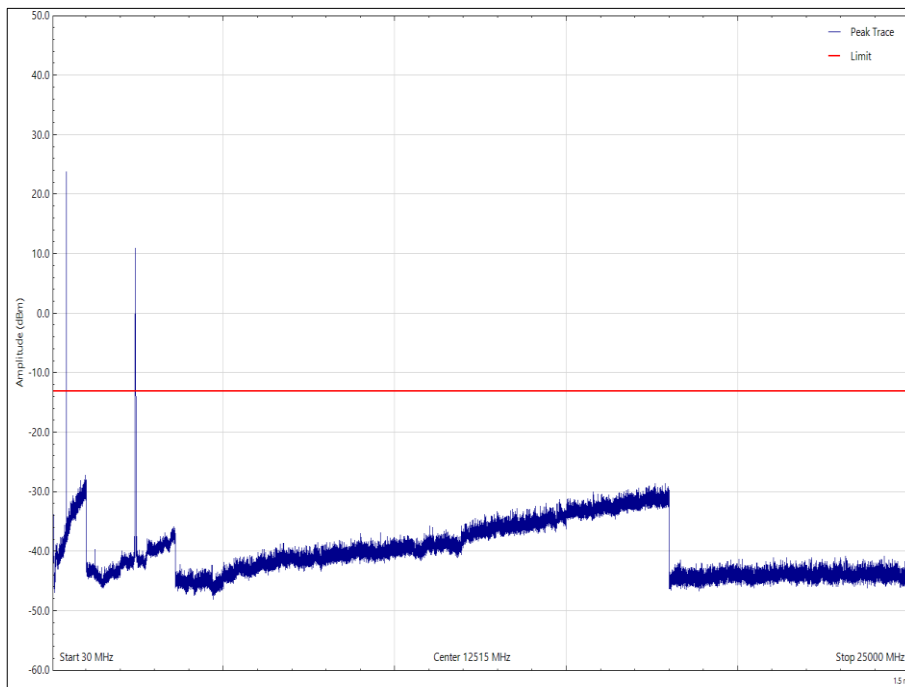


**Figure 10 - 30 MHz to 25 GHz - RSS - Y Orientation, Peak, Vertical**

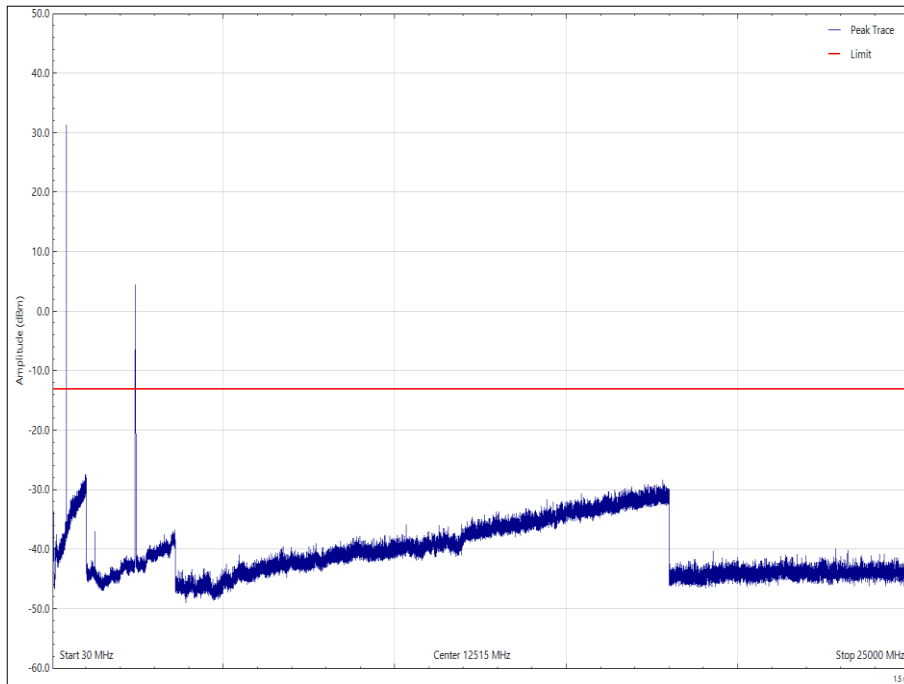




**Figure 11 - 30 MHz to 25 GHz - RSS - Y Orientation, Peak, Horizontal**



**Figure 12 - 30 MHz to 25 GHz - RSS - Z Orientation, Peak, Vertical**



**Figure 13 - 30 MHz to 25 GHz - RSS - Z Orientation, Peak, Horizontal**

FCC 47 CFR Parts 15.247(d), 15.209 and 90.210(b)

The least stringent limit from the applicable rule parts was used to determine compliance for Radiated Emissions testing of multiple transmission sources.

The least stringent applicable limit was:

Clause	Limit
Part 90.210 (b)	Attenuated by $43 + 10 \log(P)$ -13 dBm (EIRP) / 82 dB $\mu$ V/m at 3m.

**Table 21 – FCC Limit**

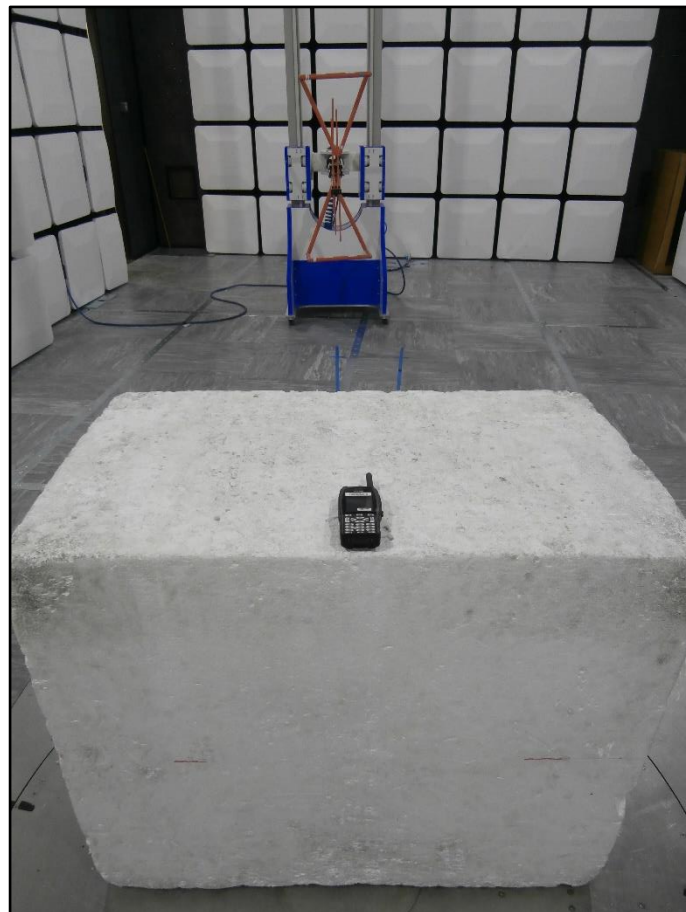
ISED RSS-247 Clause 5.5 and RSS-119 Clause 5.8

The least stringent limit from the applicable clauses was used to determine compliance for Radiated Emissions testing of multiple transmission sources.

The least stringent applicable limit was:

Clause	Limit
RSS-119 Clause 5.8	Attenuated by $43 + 10 \log(P)$ -13 dBm (EIRP) / 82 dB $\mu$ V/m at 3m.

**Table 22 – RSS Limit**



**Figure 14 - Test Setup - 30 MHz to 1 GHz - X Orientation**



**Figure 15 - Test Setup - 30 MHz to 1 GHz - Y Orientation**



**Figure 16 - Test Setup - 30 MHz to 1 GHz - Z Orientation**



**Figure 17 - Test Setup - 1 GHz to 18 GHz - X Orientation**



**Figure 18 - Test Setup - 1 GHz to 18 GHz - Y Orientation**



**Figure 19 - Test Setup - 1 GHz to 18 GHz - Z Orientation**





**Figure 20 - Test Setup - 18 GHz to 25 GHz - X Orientation**



**Figure 21 - Test Setup - 18 GHz to 25 GHz - Y Orientation**



**Figure 22 - Test Setup - 18 GHz to 25 GHz - Z Orientation**



### 2.1.4 Test Location and Test Equipment Used

This test was carried out in EMC Chamber 12.

Instrument	Manufacturer	Type No	TE No	Calibration Period (months)	Calibration Expires
Antenna 18-40GHz (Double Ridge Guide)	Link Microtek Ltd	AM180HA-K-TU2	230	24	27-Jul-2022
Antenna with permanent attenuator (Bilog)	Schaffner	CBL6143	287	24	14-Oct-2022
18GHz - 40GHz Pre-Amplifier	Phase One	PSO4-0087	1534	12	18-Feb-2022
Comb Generator	Schaffner	RSG1000	3034	-	TU
EMI Test Receiver	Rohde & Schwarz	ESU40	3506	12	18-Mar-2022
3.5 mm 2m Cable	Junkosha	MWX221-02000DMS	5428	12	15-Oct-2021
Thermo-Hygro-Barometer	PCE Instruments	PCE-THB-40	5481	12	31-Mar-2022
2 m K Type Cable	Junkosha	MWX241-02000KMSKMS/A	5523	12	09-Apr-2022
2m K Type Cable	Junkosha	MWX241-02000KMSKMS/A	5524	12	24-Mar-2022
DRG Horn Antenna (7.5-18GHz)	Schwarzbeck	HWRD750	5610	12	22-Sep-2021
Broadband Horn Antenna (1-10 GHz)	Schwarzbeck	BBHA 9120 B	5611	12	22-Sep-2021
Turntable & Mast Controller	Maturo Gmbh	NCD/498/2799.01	5612	-	TU
Tilt Antenna Mast TAM 4.0-P	Maturo Gmbh	TAM 4.0-P	5613	-	TU
Turntable	Maturo Gmbh	Turntable 1.5 SI-2t	5614	-	TU
3m Semi Anechoic Chamber	MVG	EMC-3	5621	36	11-Aug-2023
Cable Assembly - 18GHz 8m	Junkosha	MWX221-08000NMSNMS/B	5732	6	05-Aug-2021

**Table 23**

TU - Traceability Unscheduled



**2.2 ERP/EIRP Verification**

**2.2.1 Specification Reference**

FCC 47 CFR Part 90, Clause 90.205 (h)  
ISED RSS-119: Clause 5.4

**2.2.2 Equipment Under Test and Modification State**

SC2124, S/N: 1PR002110GMS80T - Modification State 0

**2.2.3 Date of Test**

06-July-2021

**2.2.4 Test Method**

The following test was performed to check the fundamental of the integrated module was not adversely affected when integrated into the host device as required by KDB 996369 D04, clause 3.4.

This test was performed in accordance with ANSI C63.26, clauses 5.2.3.1 and 5.2.3.3

**2.2.5 Environmental Conditions**

Ambient Temperature 22.7 °C  
Relative Humidity 52.8 %

**2.2.6 Test Results**

TETRA and 2.4 GHz WLAN

Frequency (MHz)	Result	Limit	Unit
418.050 (RSS)	2.73	60.0	W
460.025 (FCC)	33.95	Refer to 90.205 (h) of the specification	dBm

**Table 24 - ERP Verification Results**



**2.2.7 Test Location and Test Equipment Used**

This test was carried out in EMC Chamber 12.

Instrument	Manufacturer	Type No	TE No	Calibration Period (months)	Calibration Expires
EMI Test Receiver	Rohde & Schwarz	ESU40	3506	12	18-Mar-2022
8 Meter Cable	Teledyne	PR90-088-8MTR	5212	12	03-Sep-2021
Thermo-Hygro-Barometer	PCE Instruments	PCE-THB-40	5481	12	31-Mar-2022
Turntable & Mast Controller	Maturo Gmbh	NCD/498/2799.01	5612	-	TU
Tilt Antenna Mast TAM 4.0-P	Maturo Gmbh	TAM 4.0-P	5613	-	TU
Turntable	Maturo Gmbh	Turntable 1.5 SI-2t	5614	-	TU
3m Semi Anechoic Chamber	MVG	EMC-3	5621	36	11-Aug-2023
Cable Assembly - 18GHz 8m	Junkosha	MWX221-08000NMSNMS/B	5732	6	05-Aug-2021

**Table 25**

TU - Traceability Unscheduled



### 3 Measurement Uncertainty

For a 95% confidence level, the measurement uncertainties for defined systems are:

Test Name	Measurement Uncertainty
Radiated Spurious Emissions (Simultaneous Transmission)	30 MHz to 1 GHz: $\pm 5.2$ dB 1 GHz to 40 GHz: $\pm 6.3$ dB
ERP/EIRP Verification	$\pm 3.2$ dB

**Table 26**

#### Measurement Uncertainty Decision Rule

Determination of conformity with the specification limits is based on the decision rule according to IEC Guide 115: 2007, clause 4.4.3 and 4.5.1.