

Quick Reference Guide

SC21 series hand-portable radio

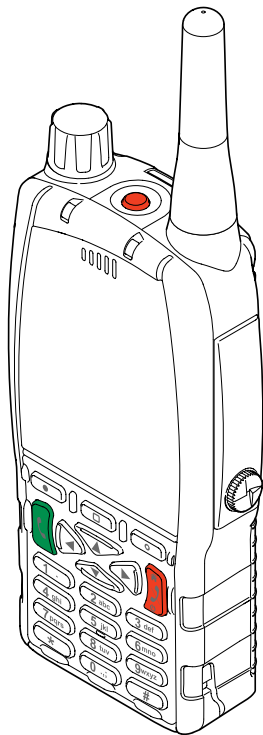

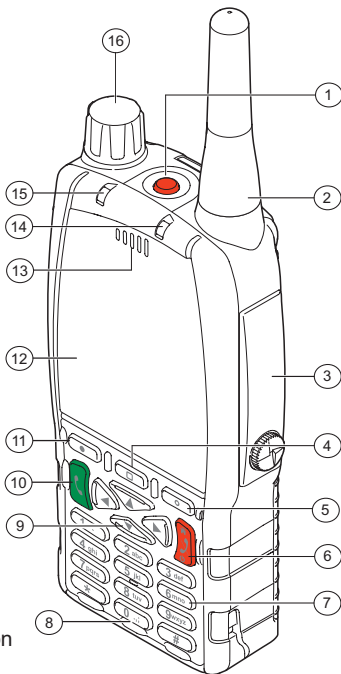



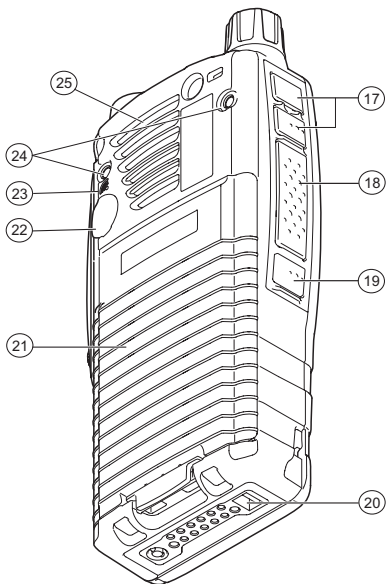



- | | | | |
|---|--|----|--|
| 1 | Emergency button | 9 | Navigation keys |
| 2 | Antenna | 10 | Green key (Select/Send) |
| 3 | Rugged Accessory Connector (sRAC) | 11 | Left Context key |
| 4 | Centre Context key (Groups, Status, Profiles) | 12 | Colour display with backlight |
| 5 | Right Context key | 13 | Earpiece for full-duplex calls. Microphone for half-duplex calls |
| 6 | Red key (Cancel/Home) | 14 | Blue LED |
| 7 | Alphanumeric keypad with backlight and Loudspeaker behind used for half-duplex calls | 15 | Tri-Coloured LED |
| 8 | Microphone for full-duplex calls | 16 | Navi-knob |



- | | | | |
|----|------------------------------------|----|--|
| 17 | Side buttons A/B (soft keys) | 22 | External Antenna Connector |
| 18 | PTT button | 23 | RFID tag |
| 19 | Side button C (soft key) | 24 | Accessory attachment mounting points |
| 20 | Digital Accessory Connector (sDAC) | 25 | Loudspeaker used for half-duplex calls |
| 21 | Battery | | |

- Power on** Press and hold (2 seconds) the **Red**  key.
- Power off** From the Home screen, press and hold (2 seconds) the **Red**  key, then follow the instructions to power off.
- Home screen** The Home screen displays when the radio powers on and when it is idle. To quickly get back to the Home screen, press and hold (2 seconds) the **Red**  key.
- Menu** To enter the menu, from the Home screen press the **Menu**  context key. Use the navigation keys to scroll through the menus and options. To open a sub-menu or menu option, select it (highlight it) and press the **Green**  key. To return to a higher level menu, press the **Back** context key.
- Activating a soft key** Special features such as SmartMenus can be assigned to a soft key. To activate a soft key function, press and release a programmable side button. Press and hold (1 second) any one of the 0-9, * and # keys to activate a soft key function.
- Adjust the volume** Rotate the **Navi-knob**.
- Clear notifications** From the Home screen press the **Shortcut** context key to open the Shortcut Bar. Use the navigation keys to scroll to the notification, highlight it and then press the **Green**  key. Use the feature in the usual way to close the notification, for example, read an unread message or disable a function.
- Lock keypad** From the Home screen, press the * Star key, then press the **OK** context key. To unlock the keypad, press the * Star key, then press the **OK** context key.



Alarm Call

WARNING! Do not hold the radio close to your ear. Press and hold (2 seconds) the **Emergency** button. Press the **PTT** button and speak into the top microphone. If your radio is customised for 'live microphone' you can speak with out holding the **PTT** button for a period of time.





Make a Group call

WARNING! Do not hold the radio close to your ear. Press and hold the **PTT** button and speak into the top microphone. When you have finished speaking, release the **PTT** button to listen to the other radio users through the loudspeaker. To end the call, press the **Red**  key.

Make an individual half-duplex call

WARNING! Do not hold the radio close to your ear. From the Home screen, press the **Menu**  context key. Select **Phone > Contacts** to open the contacts menu. Use the navigation keys to scroll to the folder containing the contact details and select your contact. Press the **Open** context key, and select the contact's phone number. Press the **PTT** button to make the call and speak into the top microphone. To end the call, press the **Red**  key.



Make an individual full-duplex call

From the Home screen, press any of the alphanumeric keys to launch the dial box, then enter the number required and press the **Green**  key to initiate the call. Alternatively press the **Menu** context key or the **Down** navigation key, then select **Phone > Contacts** to open the contacts menu. Use the navigation keys to scroll to the **All Folder** and select your contact. Press the **Open** context key or the **Green**  key, then choose the phone number. Press the **Dial** context key or the **Green**  key to initiate the call. To end the call, press the **Clear** context key or the **Red**  key.



Change the talkgroup

From the Home screen, press the **Groups**  context key. The Talkgroup Selection box appears showing the current selected talkgroup and folder. Directional arrows displayed under the talkgroup name indicate that there are more talkgroups available in the current folder. Rotate the **Navi-knob** to scroll through the talkgroups. To attach to a talkgroup, press the **Select** context key.

Change the talkgroup folder

From the Home screen, press the **Groups**  context key. The Talkgroup Selection box appears showing the current selected talkgroup and folder. Use the **Up** and **Down** navigation keys to scroll through the folder levels (sub-folders). Use the **Right** and **Left** navigation keys to scroll through more folders at the same level. Press the **Green**  key to select the new folder. You must choose a talkgroup from that folder as your selected talkgroup.

Send a text message



From the Home screen, press the **Menu**  context key. Select **Messages > Create Message**. An empty message box appears. You can now start typing your message. To change between the text entry modes press the * key. Press the # key for special characters, 0 for punctuation and 1 to insert a space. To send your message, press the **Green**  key, select the **Send to Default** option (or choose another destination such as your talkgroup, a contact in your phone book or dial the number) and then press the **Green**  key.

Send a Status message

From the Home screen, press the **Groups**  context key 2 times. Use the navigation keys to scroll through the status messages.

To send the message, press the **Send** context key, select the **Send to Default** option (or choose another destination such as your talkgroup, a contact in your phone book or dial the number) and press the **Green**  key.

Switch between Day & Night modes

From the Home screen, press the **Menu**  context key. Select **Options > Settings > Display Settings > Day/Night Mode**. Press the **Toggle** context key to switch between Day and Night mode. To return to the Home screen, press and hold (2 seconds) the **Red**  key.

Invert the display

From the Home screen, press the **Menu**  context key. Select **Options > Settings > Display Settings > Invert Display**. Press the **Toggle** context key to switch between normal and inverted display. A tick appears in the check box when the display is inverted.

LED indicators

Green:	The radio is in a call and receiving.
Red:	The radio is in a call and transmitting.
Red (flashing):	You are receiving an Alarm call from another radio user or the radio is attempting to connect to the network or the battery charge level is low.
Orange (flashing):	Incoming telephone call or SDS/Status message.
Orange (intermittent four flashes):	Transmit Inhibit mode is active. The radio cannot transmit.
Blue (flashing):	You have missed a call or there are unread messages in your Inbox or Bluetooth™ is enabled.

Status Icons

 Alarm call is in progress

 Outgoing TMO call in progress

 Incoming TMO call in progress

 Incoming DMO call in progress

 Outgoing DMO call in progress

 Signal Strength (more bars indicate stronger signal)

 Black icon indicates good radio coverage. Red icon indicates no signal.

 Battery charge level. Indicates the charge in the battery. Full icon is full charge.

 Keypad lock

 Connector Protector enabled

 Connector Protector disabled

Notification icons

 Missed incoming call

 Missed incoming message

 Transmit Inhibit