

Report on the FCC and ISEDC Testing of:

Sepura Ltd
Portable TETRA Handset, Model: SC2124

In accordance with FCC 47 CFR Part 15C,
ISEDC RSS-247 and ISEDC RSS-GEN

Prepared for: Sepura Ltd
9000 Cambridge Research Park
Beach Drive, Waterbeach, Cambridge
CB25 9TL, United Kingdom

FCC ID: XX6SC2124 IC: 8739A-SC2124



Add value.
Inspire trust.

COMMERCIAL-IN-CONFIDENCE

Document Number: 75944487-11 | Issue: 01

SIGNATURE

NAME	JOB TITLE	RESPONSIBLE FOR	ISSUE DATE
Simon Bennett	Chief Engineer	Authorised Signatory	16 July 2019

Signatures in this approval box have checked this document in line with the requirements of TÜV SÜD document control rules.

ENGINEERING STATEMENT

The measurements shown in this report were made in accordance with the procedures described on test pages. All reported testing was carried out on a sample equipment to demonstrate limited compliance with FCC 47 CFR Part 15C, ISEDC RSS-247 and ISEDC RSS-GEN. The sample tested was found to comply with the requirements defined in the applied rules.

SIGNATURE

NAME	JOB TITLE	RESPONSIBLE FOR	ISSUE DATE
Graeme Lawler	Test Engineer	Testing	16 July 2019
Mehadi Choudhury	Test Engineer	Testing	16 July 2019

FCC Accreditation

90987 Octagon House, Fareham Test Laboratory

ISEDC Accreditation

IC2932B-1 Octagon House, Fareham Test Laboratory

EXECUTIVE SUMMARY

A sample of this product was tested and found to be compliant with FCC 47 CFR Part 15C (2018), ISEDC RSS-247 Issue 2 (2017-02) and ISEDC RSS-GEN Issue 5 (2018-04).



DISCLAIMER AND COPYRIGHT

This non-binding report has been prepared by TÜV SÜD with all reasonable skill and care. The document is confidential to the potential Client and TÜV SÜD. No part of this document may be reproduced without the prior written approval of TÜV SÜD. © 2019 TÜV SÜD. This report relates only to the actual item/items tested.

ACCREDITATION

Our UKAS Accreditation does not cover opinions and interpretations and any expressed are outside the scope of our UKAS Accreditation. Results of tests not covered by our UKAS Accreditation Schedule are marked NUA (Not UKAS Accredited).

TÜV SÜD
is a trading name of TÜV SÜD Ltd
Registered in Scotland at East Kilbride,
Glasgow G75 0QF, United Kingdom
Registered number: SC215164

TÜV SÜD Ltd is a
TÜV SÜD Group Company

Phone: +44 (0) 1489 558100
Fax: +44 (0) 1489 558101
www.tuv-sud.co.uk

TÜV SÜD
Octagon House
Concorde Way
Fareham
Hampshire PO15 5RL
United Kingdom



Contents

1	Report Summary	2
1.1	Report Modification Record.....	2
1.2	Introduction.....	2
1.3	Brief Summary of Results	3
1.4	Application Form	4
1.5	Product Information	6
1.6	Deviations from the Standard.....	8
1.7	EUT Modification Record	8
1.8	Test Location	9
2	Test Details	10
2.1	AC Power Line Conducted Emissions	10
2.2	Maximum Conducted Output Power	14
2.3	Power Spectral Density	16
2.4	Emission Bandwidth	20
2.5	Authorised Band Edges	24
2.6	Restricted Band Edges.....	27
2.7	Spurious Radiated Emissions	31
3	Photographs	65
3.1	Test Setup Photographs	65
4	Measurement Uncertainty	70



1 Report Summary

1.1 Report Modification Record

Alterations and additions to this report will be issued to the holders of each copy in the form of a complete document.

Issue	Description of Change	Date of Issue
1	First Issue	16 July 2019

Table 1

1.2 Introduction

Applicant	Sepura Ltd
Manufacturer	Sepura Ltd
Model Number(s)	SC2124
Serial Number(s)	Radio 2B – 2PS001845GM55XT Radio 5B – 2PS001845GM55YP
Hardware Version(s)	Production
Software Version(s)	Radio 2B - 1754 006 07366 (boot) 1754 006 07367 (kernel) Radio 5B – 2001 684 07366 (boot) 2001 684 07367 (kernel)
Number of Samples Tested	2
Test Specification/Issue/Date	FCC 47 CFR Part 15C (2018) ISED RSS-247 Issue 2 (2017-02) ISED RSS-GEN Issue 5 (2018-04)
Order Number	PLC-PO011393-1
Date	07-December-2018
Date of Receipt of EUT	18-March-2019
Start of Test	25-March-2019
Finish of Test	10-May-2019
Name of Engineer(s)	Graeme Lawler and Mehadi Choudhury
Related Document(s)	ANSI C63.10: 2013



1.3 Brief Summary of Results

A brief summary of the tests carried out in accordance with FCC 47 CFR Part 15C and ISED RSS-247 and ISED RSS-GEN is shown below.

Section	Specification Clause			Test Description	Result	Comments/Base Standard
	Part 15C	RSS-247	RSS-GEN			
2.1	15.207	-	8.8	AC Power Line Conducted Emission	Pass	ANSI C63.10: 2013
2.2	15.247(b)	5.4	6.12	Maximum Conducted Output Power	Pass	
2.3	15.247(e)	5.2	6.12	Power Spectral Density	Pass	
2.4	15.247(a)(2)	5.2	6.7	Emission Bandwidth	Pass	
2.5	15.247(d)	5.5	-	Authorised Band Edge	Pass	
2.6	15.205	-	8.10	Restricted Band Edge	Pass	
2.7	15.247(d)	5.5	6.13	Spurious Radiated Emissions	Pass	

Table 2



1.4 Application Form

EQUIPMENT DESCRIPTION	
Model Name/Number	SC2124 Radio 2B – 2PS001845GM55XT Radio 5B – 2PS001845GM55YP
Part Number	N/A
Hardware Version	Production
Software Version	Radio 2B - 1754 006 07366 (boot), 1754 006 07367 (kernel) Radio 5B – 2001 684 07366 (boot), 2001 684 07367 (kernel)
FCC ID (if applicable)	XX6SC2124
Industry Canada ID (if applicable)	8739A-SC2124
Technical Description (Please provide a brief description of the intended use of the equipment)	Portable TETRA Radio for use by the emergency services etc.

INTENTIONAL RADIATORS									
Technology	Frequency Band (MHz)	Conducted Declared Output Power (dBm)	Antenna Gain (dBi)	Supported Bandwidth (s) (MHz)	Modulation Scheme(s)	ITU Emission Designator	Test Channels (MHz)		
							Bottom	Middle	Top
TETRA	403-470	34	>-1	25 kHz	π/4DQPS K	22K0DXW	403	436.5	470
TETRA	403-470	34	>-1	22 kHz	π/4DQPS K	20K0DXW	403	436.5	470
Bluetooth	2402-2480	7.382	2.5	1.0	8PSK, DQPSK, GFSK	1M00F1D	2402	2441	2480

UN-INTENTIONAL RADIATOR	
Highest frequency generated or used in the device or on which the device operates or tunes	
Lowest frequency generated or used in the device or on which the device operates or tunes	
Class A Digital Device (Use in commercial, industrial or business environment) <input checked="" type="checkbox"/>	
Class B Digital Device (Use in residential environment only) <input type="checkbox"/>	

Power Source			
AC	Single Phase	Three Phase	Nominal Voltage
External DC	Nominal Voltage		Maximum Current
	7.4V DC		2A
Battery	Nominal Voltage		Battery Operating End Point Voltage
	7.4V DC		6.2V DC
Can EUT transmit whilst being charged?			Yes <input checked="" type="checkbox"/> No <input type="checkbox"/>



EXTREME CONDITIONS					
Maximum temperature	65	°C	Minimum temperature	-30	°C

Ancillaries
Please list all ancillaries which will be used with the device.
Remote speaker microphone, leasther cases, pocket clips, earpieces

ANTENNA CHARACTERISTICS				
<input type="checkbox"/>	Antenna connector		State impedance	Ohm
<input checked="" type="checkbox"/>	Temporary antenna connector		State impedance	50 Ohm
<input checked="" type="checkbox"/>	Integral antenna	Type	Bluetooth	
<input type="checkbox"/>	External antenna	Type		

I hereby declare that the information supplied is correct and complete.
Name: Chris Beecham
Position held: Conformance Engineer Date: 30/1/2019

1.5 Product Information

1.5.1 Technical Description

Portable TETRA Radio for use by the emergency services etc.

1.5.2 Test Setup Diagram(s)

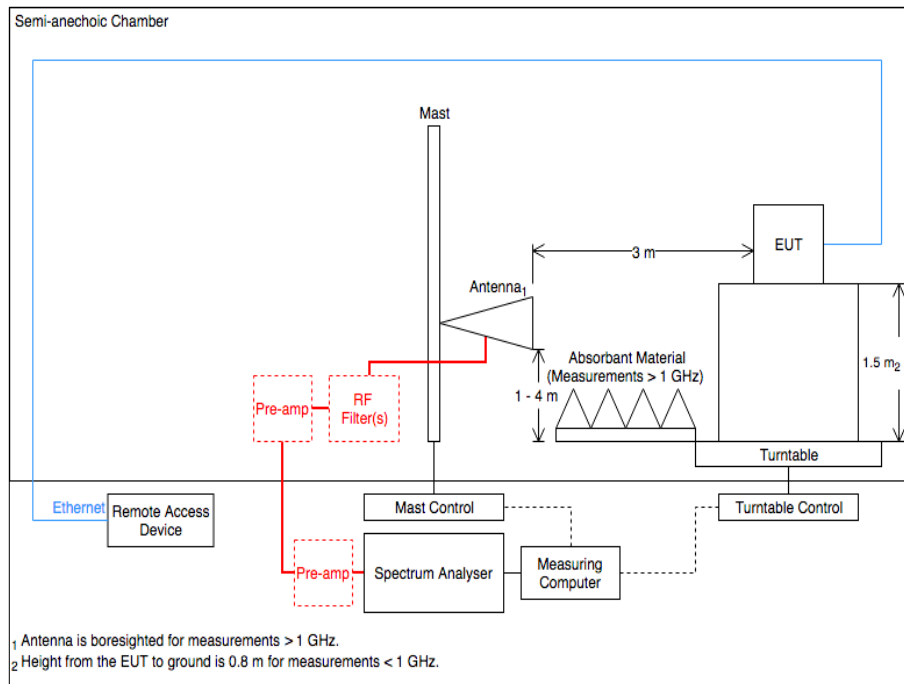

Figure 1 - Radiated Emissions

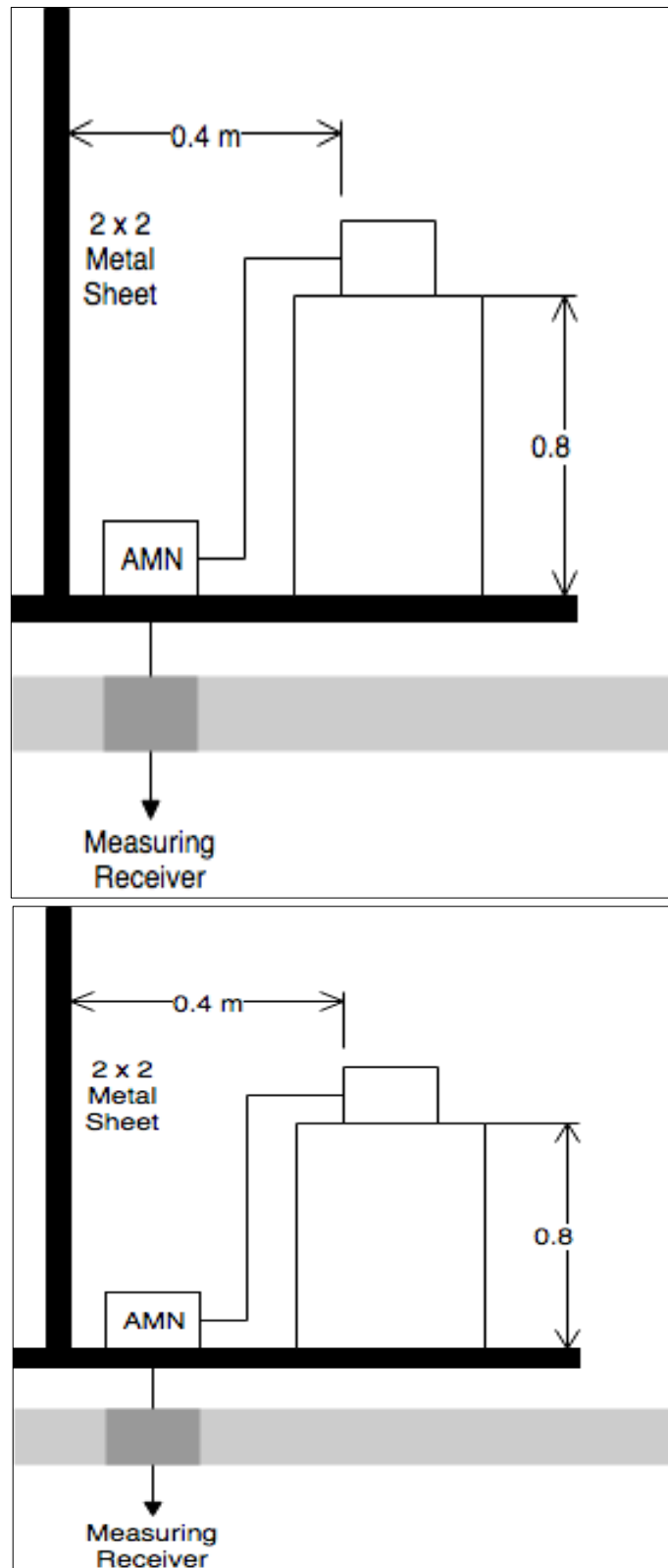

Figure 2 - AC Line Conducted Emissions

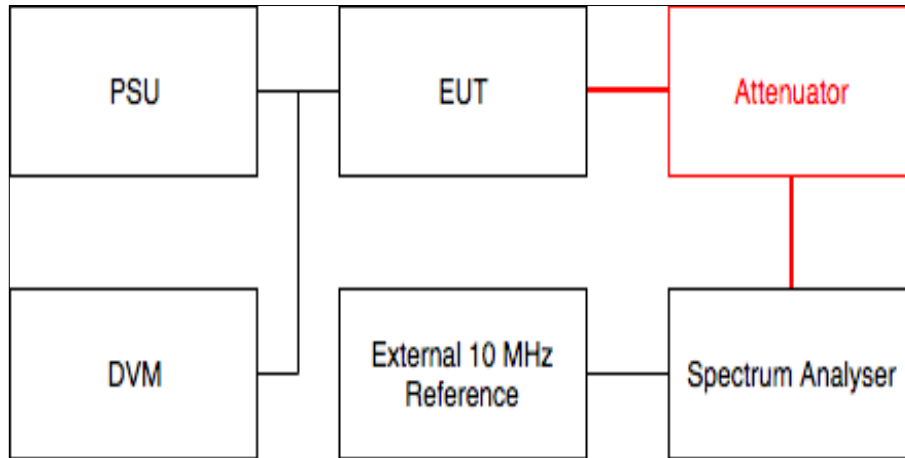

Figure 3 - Conducted Tests

1.5.3 EUT Configuration and Rationale for Radiated Spurious Emissions

The EUT was placed on the non-conducting platform in a manner typical of a normal installation.

For an EUT which could reasonably be used in multiple planes, pre-scans were performed with the EUT orientated in X, Y and Z planes with reference to the ground plane.

1.6 Deviations from the Standard

No deviations from the applicable test standard were made during testing.

1.7 EUT Modification Record

The table below details modifications made to the EUT during the test programme.

The modifications incorporated during each test are recorded on the appropriate test pages.

Modification State	Description of Modification still fitted to EUT	Modification Fitted By	Date Modification Fitted
Serial Number: Radio 2B – 2PS001845GM55XT			
0	As supplied by the customer	Not Applicable	Not Applicable
Serial Number: Radio 5B – 2PS001845GM55YP			
0	As supplied by the customer	Not Applicable	Not Applicable

Table 3



1.8 Test Location

TÜV SÜD conducted the following tests at our Fareham Test Laboratory.

Test Name	Name of Engineer(s)	Accreditation
Configuration and Mode: Bluetooth Low Energy - Transmit		
AC Power Line Conducted Emissions	Graeme Lawler	UKAS
Maximum Conducted Output Power	Mehadi Choudhury	UKAS
Power Spectral Density	Mehadi Choudhury	UKAS
Emission Bandwidth	Mehadi Choudhury	UKAS
Authorised Band Edges	Graeme Lawler	UKAS
Restricted Band Edges	Graeme Lawler	UKAS
Spurious Radiated Emissions	Graeme Lawler	UKAS

Table 4

Office Address:

Octagon House
Concorde Way
Segensworth North
Fareham
Hampshire
PO15 5RL
United Kingdom



2 Test Details

2.1 AC Power Line Conducted Emissions

2.1.1 Specification Reference

FCC 47 CFR Part 15C, Clause 15.207
ISED RSS-GEN, Clause 8.8

2.1.2 Equipment Under Test and Modification State

SC2124, S/N: 2PS001845GM55XT - Modification State 0

2.1.3 Date of Test

31-March-2019

2.1.4 Test Method

The test was performed in accordance with ANSI C63.10, clause 6.2.

2.1.5 Environmental Conditions

Ambient Temperature	17.9 °C
Relative Humidity	44.4 %



2.1.6 Test Results

Bluetooth Low Energy - Transmit

Applied supply Voltage: 60 Hz
 Applied supply frequency: 120 V AC

Frequency (MHz)	QP Level (dBuV)	QP Limit (dBuV)	QP Margin (dB)	AV Level (dBuV)	AV Limit (dBuV)	AV Margin (dB)
0.252	44.5	61.7	-17.2	32.2	51.7	-19.5
0.306	40.1	60.1	-20.0	26.9	50.1	-23.2

Table 5 - Neutral Line Emissions Results

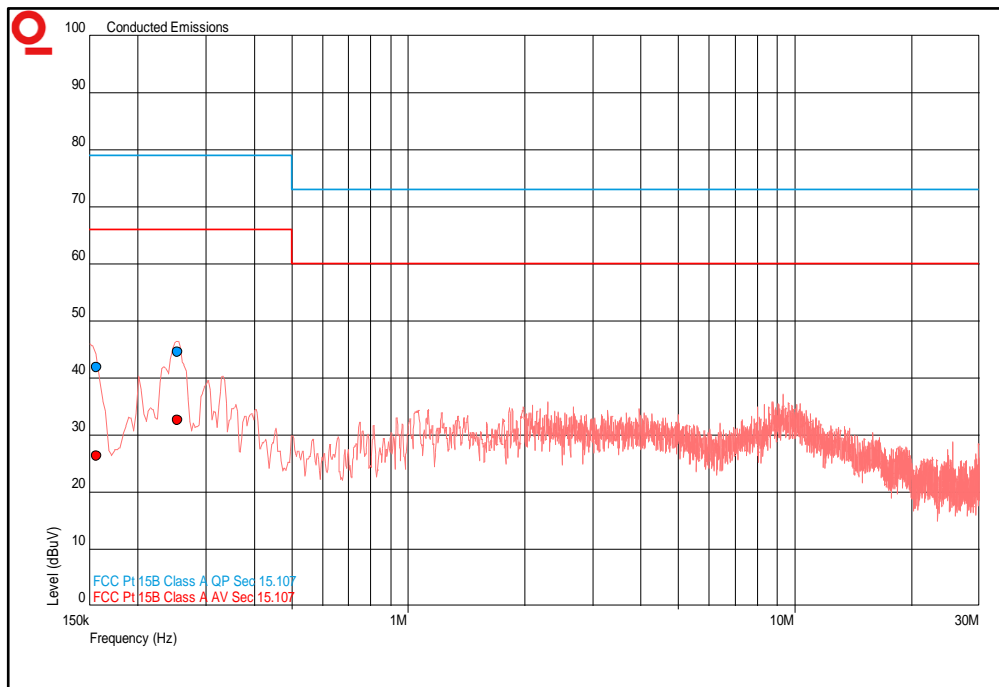

Figure 4 - Neutral Line - 150 kHz to 30 MHz



Frequency (MHz)	QP Level (dBuV)	QP Limit (dBuV)	QP Margin (dB)	AV Level (dBuV)	AV Limit (dBuV)	AV Margin (dB)
0.150	42.5	66.0	-23.5	28.6	56.0	-27.4
0.252	42.7	61.7	-19.0	33.2	51.7	-18.5
0.303	36.9	60.2	-23.3	26.3	50.2	-23.9

Table 6 - Live Line Emissions Results

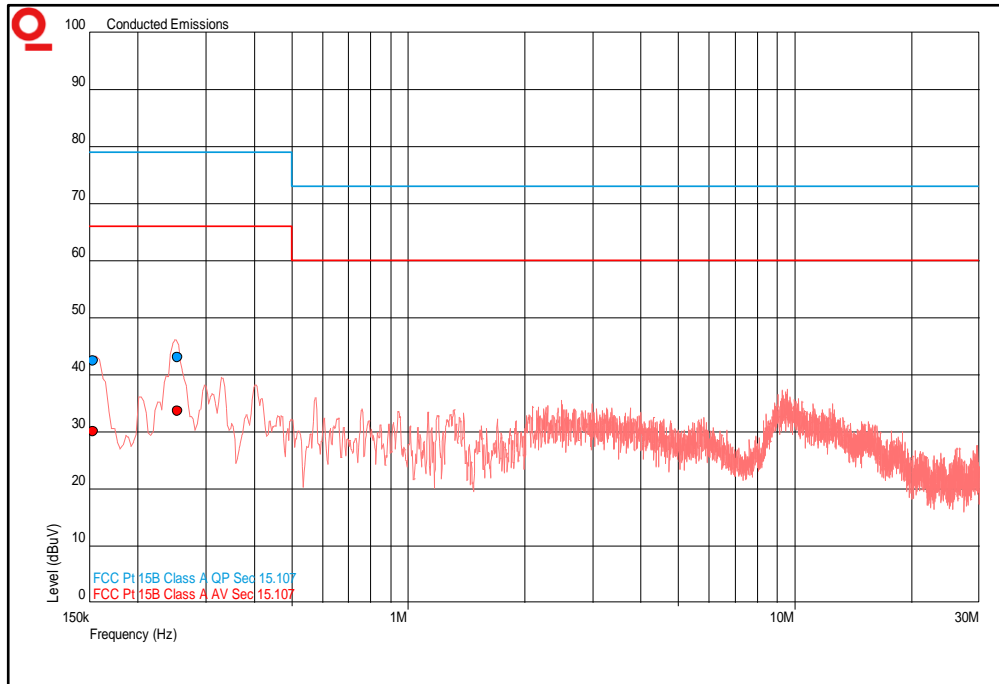

Figure 5 - Live Line - 150 kHz to 30 MHz

FCC 47 CFR Part 15, Limit Clause 15.207 and ISEDC RSS-GEN, Limit Clause 8.8

Frequency of Emission (MHz)	Conducted Limit (dBμV)	
	Quasi-Peak	Average
0.15 to 0.5	66 to 56*	56 to 46*
0.5 to 5	56	46
5 to 30	60	50

Table 7

*Decreases with the logarithm of the frequency.



2.1.7 Test Location and Test Equipment Used

This test was carried out in EMC Chamber 5.

Instrument	Manufacturer	Type No.	TE No.	Calibration Period (months)	Calibration Due
Transient Limiter	Hewlett Packard	11947A	15	12	26-Jul-2019
LISN	Rohde & Schwarz	ESH3-Z5	1390	12	20-Nov-2019
Screened Room (5)	Rainford	Rainford	1545	36	23-Jan-2021
Hygromer	Rotronic	A1	2677	12	20-Feb-2020
Compliance 5 Emissions	Teseq	V5.26.51 V.5.00.00	3275	-	Software
EMI Test Receiver	Rohde & Schwarz	ESU40	3506	12	17-Dec-2019
8 Meter Cable	Teledyne	PR90-088-8MTR	5212	6	28-Jul-2019

Table 8



2.2 Maximum Conducted Output Power

2.2.1 Specification Reference

FCC 47 CFR Part 15C Clause 15.247(b)
ISED RSS-247 Clause 5.4
ISED RSS-GEN Clause 6.12

2.2.2 Equipment Under Test and Modification State

SC2124, S/N: 2PS001845GM55YP - Modification State 0

2.2.3 Date of Test

10-May-2019

2.2.4 Test Method

The test was performed in accordance with ANSI C63.10, clause 11.9.1.1.

2.2.5 Environmental Conditions

Ambient Temperature 23.1 °C
Relative Humidity 38.9 %

2.2.6 Test Results

Bluetooth Low Energy - Transmit

Frequency (MHz)	Output Power	
	dBm	mW
2402	6.91	4.91
2440	7.27	5.33
2480	7.78	6.00

Table 9

FCC 47 CFR Part 15, Limit Clause 15.247 (b)(3)

For systems using digital modulation in the 902–928 MHz, 2400–2483.5 MHz, and 5725–5850 MHz bands: 1 Watt.

ISED RSS-247, Limit Clause 5.4 (d)

For DTSS employing digital modulation techniques operating in the bands 902-928 MHz and 2400-2483.5 MHz, the maximum peak conducted output power shall not exceed 1 W. The e.i.r.p. shall not exceed 4 W, except as provided in section 5.4(e) of the specification.



2.2.7 Test Location and Test Equipment Used

This test was carried out in RF Laboratory 1.

Instrument	Manufacturer	Type No.	TE No.	Calibration Period (months)	Calibration Due
Attenuator (10dB/250W)	Weinschel	45-10-43	383	12	23-Oct-2019
50dB/2W Attenuator	Narda	4772-50	458	-	O/P Mon
Multimeter	Fluke	79 Series III	611	12	07-Sep-2019
Hygrometer	Rotronic	I-1000	3220	12	13-Sep-2019
Signal Generator, 9kHz - 3GHz	Rohde & Schwarz	SMA 100A	3504	12	22-Aug-2019
Signal Analyser	Rohde & Schwarz	FSQ 26	3545	12	18-Mar-2020
Network Analyser	Rohde & Schwarz	ZVA 40	3548	12	17-Oct-2019
'N' - 'N' RF Cable (1m)	Rhophase	NPS-1803-1000-NPS	3701	-	O/P Mon
Calibration Unit	Rohde & Schwarz	ZV-Z54	4368	12	22-Oct-2019
Frequency Standard	Spectracom	SecureSync 1200-0408-0601	4393	6	15-Oct-2019
1 metre N-Type Cable	Florida Labs	NMS-235SP-39.4-NMS	4510	12	10-Jul-2019
Attenuator (20dB, 100W)	Weinschel	48-20-43	4870	12	17-Jul-2019
EXA	Keysight Technologies	N9010B	4968	24	21-Dec-2019
Cable (18 GHz)	Rosenberger	LU7-071-1000	5099	12	04-Oct-2019
Programmable Power Supply	Rohde & Schwarz	HMP2020	-	-	O/P Mon

Table 10

O/P Mon – Output Monitored Using Calibrated Test Equipment.



2.3 Power Spectral Density

2.3.1 Specification Reference

FCC 47 CFR Part 15C, Clause 15.247(e)
ISED RSS-247, Clause 5.2
ISED RSS-GEN, Clause 6.12

2.3.2 Equipment Under Test and Modification State

SC2124, S/N: 2PS001845GM55YP - Modification State 0

2.3.3 Date of Test

10-May-2019

2.3.4 Test Method

This test was performed in accordance with ANSI C63.10, clause 11.10.2.

2.3.5 Environmental Conditions

Ambient Temperature 23.1 °C
Relative Humidity 38.9 %

2.3.6 Test Results

Bluetooth Low Energy - Transmit

Frequency (MHz)	Power Spectral Density (dBm)
2402	3.83
2440	3.25
2480	4.51

Table 11 - Power Spectral Density

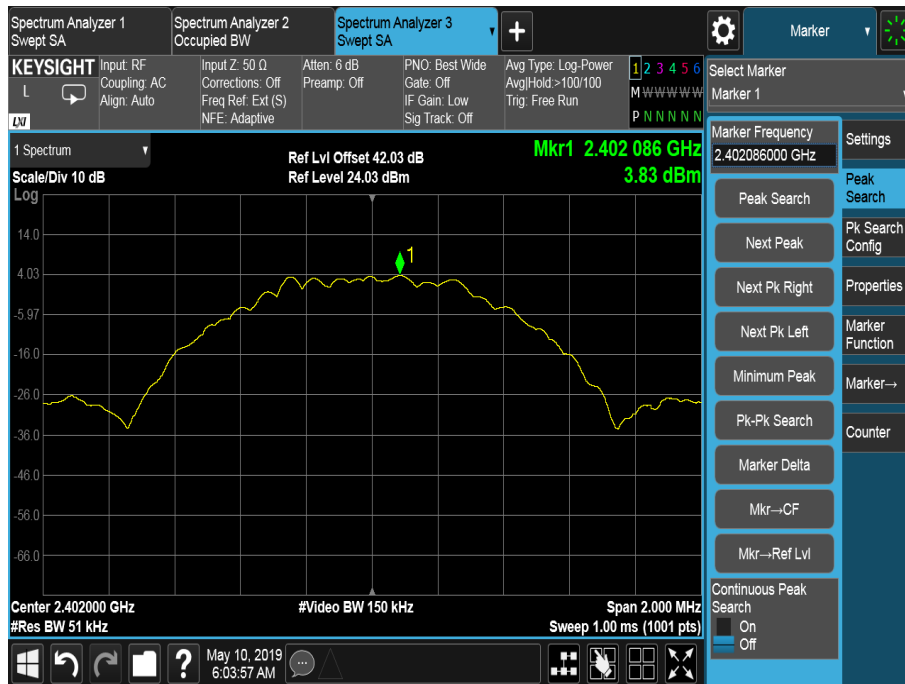

Figure 6 - 2402 MHz, Power Spectral Density

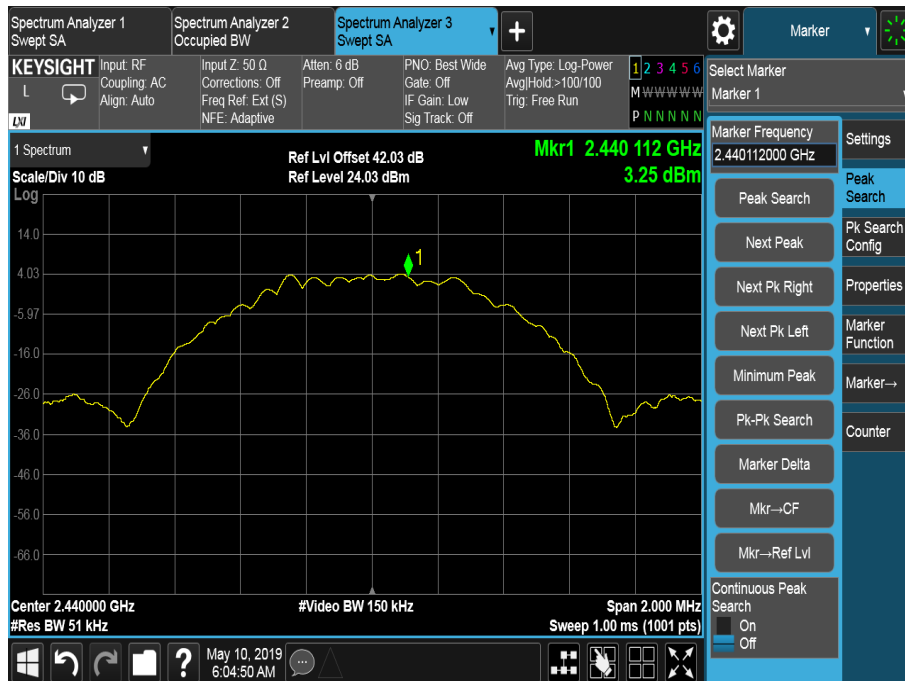

Figure 7 - 2440 MHz, Power Spectral Density



Figure 8 - 2480 MHz, Power Spectral Density

FCC 47 CFR Part 15, Limit Clause 15.247 (e)

The power spectral density conducted from the intentional radiator to the antenna shall not be greater than 8 dBm in any 3 kHz band during any time interval of continuous transmission.

ISED RSS-247, Limit Clause 5.2(b)

The transmitter power spectral density conducted from the transmitter to the antenna shall not be greater than 8 dBm in any 3 kHz band during any time interval of continuous transmission.



2.3.7 Test Location and Test Equipment Used

This test was carried out in RF Laboratory 1.

Instrument	Manufacturer	Type No.	TE No.	Calibration Period (months)	Calibration Due
Attenuator (10dB/250W)	Weinschel	45-10-43	383	12	23-Oct-2019
50dB/2W Attenuator	Narda	4772-50	458	-	O/P Mon
Multimeter	Fluke	79 Series III	611	12	07-Sep-2019
Hygrometer	Rotronic	I-1000	3220	12	13-Sep-2019
Signal Generator, 9kHz - 3GHz	Rohde & Schwarz	SMA 100A	3504	12	22-Aug-2019
Signal Analyser	Rohde & Schwarz	FSQ 26	3545	12	18-Mar-2020
Network Analyser	Rohde & Schwarz	ZVA 40	3548	12	17-Oct-2019
'N' - 'N' RF Cable (1m)	Rhophase	NPS-1803-1000-NPS	3701	-	O/P Mon
Calibration Unit	Rohde & Schwarz	ZV-Z54	4368	12	22-Oct-2019
Frequency Standard	Spectracom	SecureSync 1200-0408-0601	4393	6	15-Oct-2019
1 metre N-Type Cable	Florida Labs	NMS-235SP-39.4-NMS	4510	12	10-Jul-2019
Attenuator (20dB, 100W)	Weinschel	48-20-43	4870	12	17-Jul-2019
EXA	Keysight Technologies	N9010B	4968	24	21-Dec-2019
Cable (18 GHz)	Rosenberger	LU7-071-1000	5099	12	04-Oct-2019
Programmable Power Supply	Rohde & Schwarz	HMP2020	-	-	O/P Mon

Table 12

O/P Mon – Output Monitored Using Calibrated Test Equipment.



2.4 Emission Bandwidth

2.4.1 Specification Reference

FCC 47 CFR Part 15C, Clause 15.247(a)(2)
ISED RSS-247, Clause 5.2
ISED RSS-GEN, Clause 6.7

2.4.2 Equipment Under Test and Modification State

SC2124, S/N: 2PS001845GM55YP - Modification State 0

2.4.3 Date of Test

10-May-2019

2.4.4 Test Method

The test was performed in accordance with ANSI C63.10, clause 11.8.2.

2.4.5 Environmental Conditions

Ambient Temperature 23.1 °C
Relative Humidity 38.9 %

2.4.6 Test Results

Bluetooth Low Energy - Transmit

Modulation/Packet Type: GFSK/DH1

Frequency (MHz)	6 dB Bandwidth (MHz)	99% Occupied Bandwidth (MHz)
2402	0.709	1.039
2440	0.710	1.039
2480	0.714	1.041

Table 13



Figure 9 - 2402 MHz – 6 dB Bandwidth & 99% Occupied Bandwidth

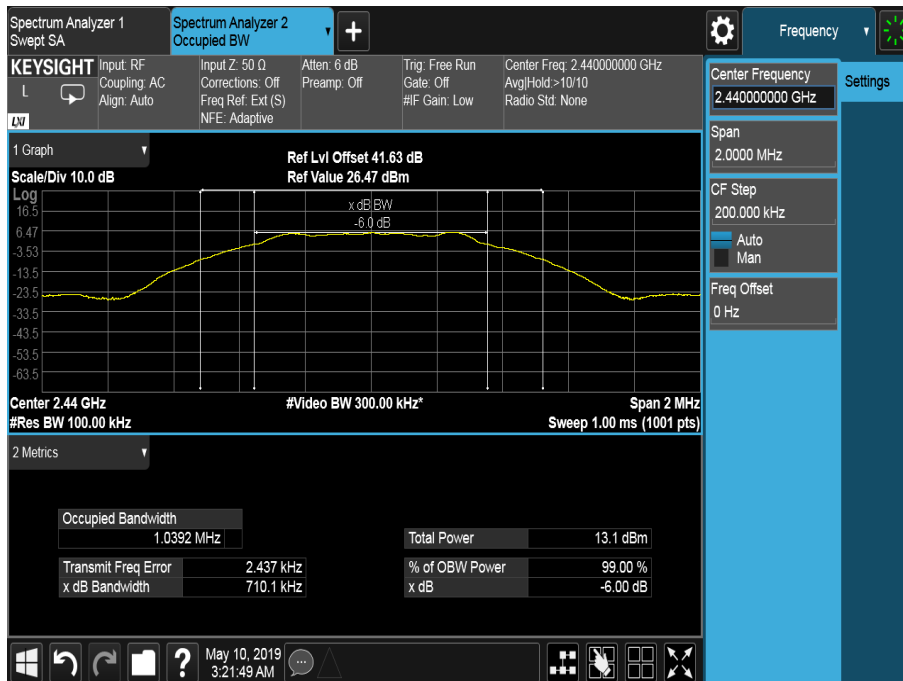

Figure 10 – 2440 MHz – 6 dB Bandwidth & 99% Occupied Bandwidth

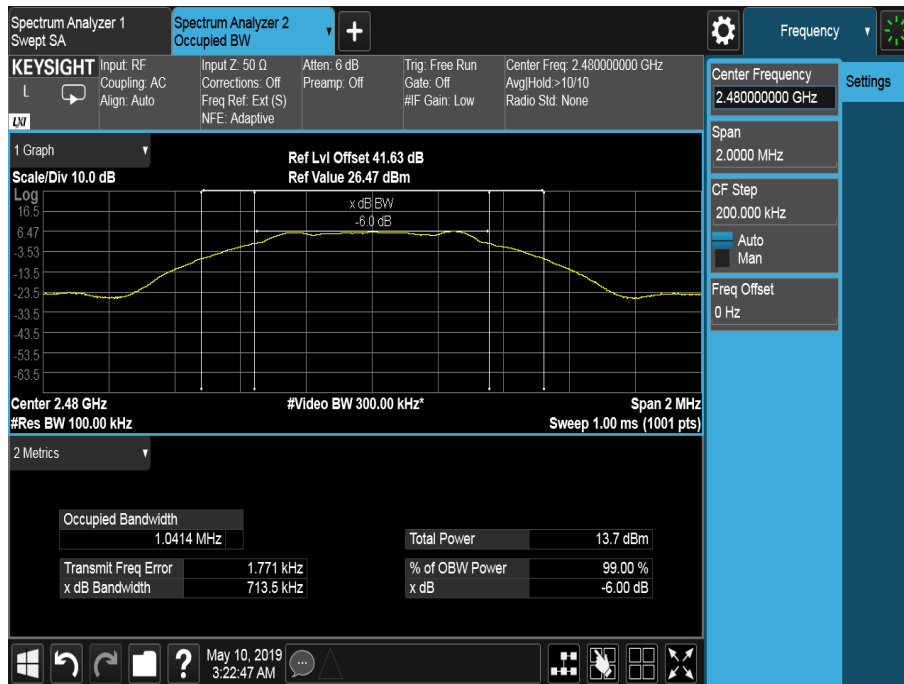

Figure 11- 2480 MHz – 6 dB Bandwidth & 99% Occupied Bandwidth

FCC 47 CFR Part 15, Limit Clause 15.247(a)(2) and ISEDC RSS-247, Clause 5.2(a)

The minimum 6 dB Bandwidth shall be at least 500 kHz.



2.4.7 Test Location and Test Equipment Used

This test was carried out in RF Laboratory 1.

Instrument	Manufacturer	Type No.	TE No.	Calibration Period (months)	Calibration Due
Attenuator (10dB/250W)	Weinschel	45-10-43	383	12	23-Oct-2019
50dB/2W Attenuator	Narda	4772-50	458	-	O/P Mon
Multimeter	Fluke	79 Series III	611	12	07-Sep-2019
Hygrometer	Rotronic	I-1000	3220	12	13-Sep-2019
Signal Generator, 9kHz - 3GHz	Rohde & Schwarz	SMA 100A	3504	12	22-Aug-2019
Signal Analyser	Rohde & Schwarz	FSQ 26	3545	12	18-Mar-2020
Network Analyser	Rohde & Schwarz	ZVA 40	3548	12	17-Oct-2019
'N' - 'N' RF Cable (1m)	Rhophase	NPS-1803-1000-NPS	3701	-	O/P Mon
Calibration Unit	Rohde & Schwarz	ZV-Z54	4368	12	22-Oct-2019
Frequency Standard	Spectracom	SecureSync 1200-0408-0601	4393	6	15-Oct-2019
1 metre N-Type Cable	Florida Labs	NMS-235SP-39.4-NMS	4510	12	10-Jul-2019
Attenuator (20dB, 100W)	Weinschel	48-20-43	4870	12	17-Jul-2019
EXA	Keysight Technologies	N9010B	4968	24	21-Dec-2019
Cable (18 GHz)	Rosenberger	LU7-071-1000	5099	12	04-Oct-2019
Programmable Power Supply	Rohde & Schwarz	HMP2020	-	-	O/P Mon

Table 14

O/P Mon – Output Monitored Using Calibrated Test Equipment.



2.5 Authorised Band Edges

2.5.1 Specification Reference

FCC 47 CFR Part 15C, Clause 15.247(d)
ISED RSS-247, Clause 5.5

2.5.2 Equipment Under Test and Modification State

SC2124, S/N: 2PS001845GM55XT - Modification State 0

2.5.3 Date of Test

25-March-2019

2.5.4 Test Method

The test was performed in accordance with ANSI C63.10, clause 6.10.4.

2.5.5 Environmental Conditions

Ambient Temperature 20.6 °C
Relative Humidity 31.5 %

2.5.6 Test Results

Bluetooth Low Energy - Transmit

Modulation	Packet Type	Frequency (MHz)	Measured Frequency (MHz)	Level (dBc)
GFSK	DH1	2402	2400.0	-54.17
GFSK	DH1	2480	2483.5	-52.36

Table 15

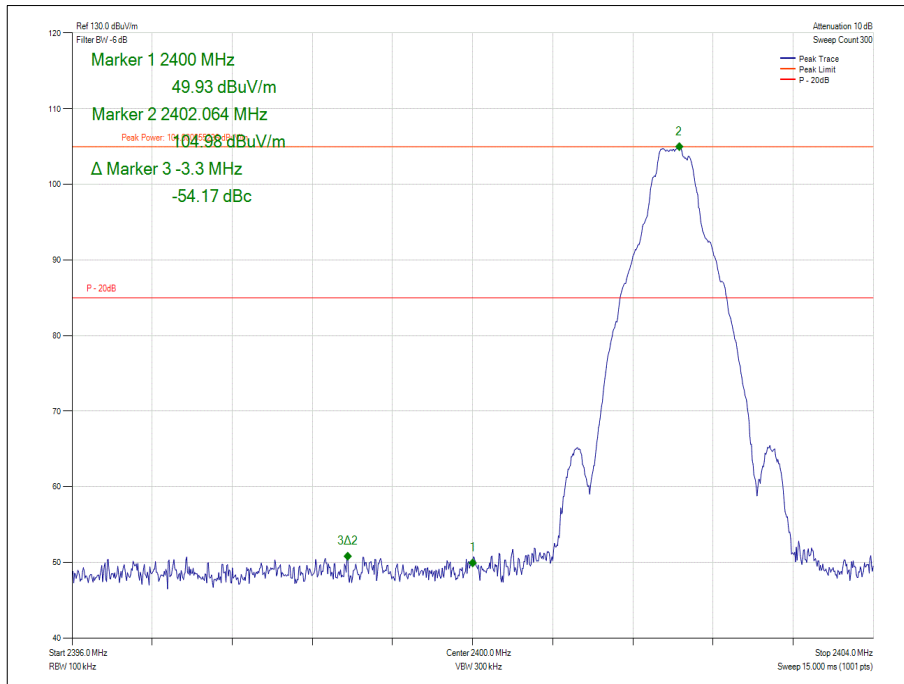

Figure 12 - GFSK/DH1 - 2402 MHz - Measured Frequency 2400.0 MHz

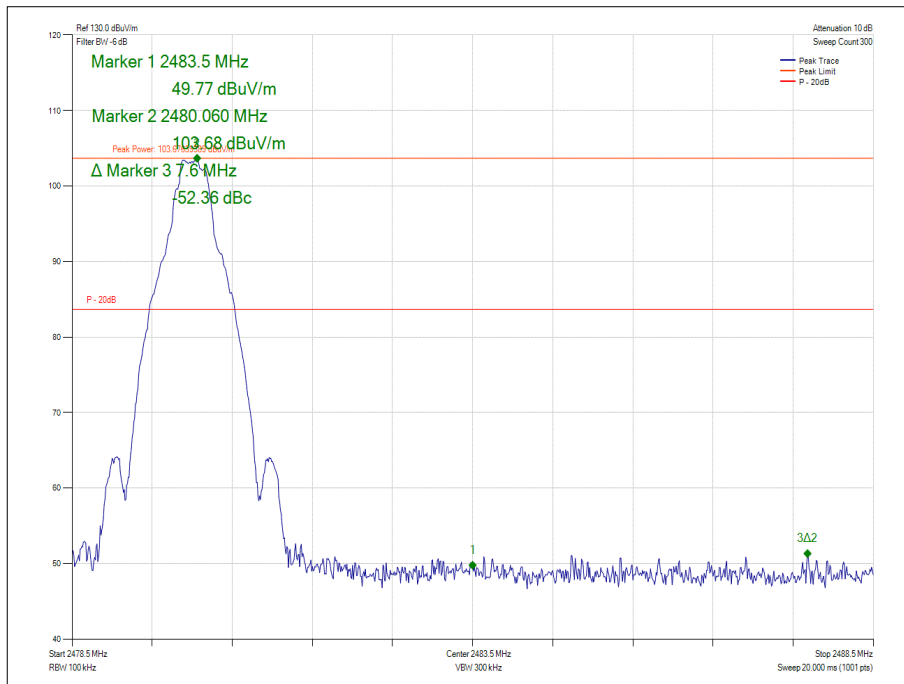

Figure 13 - GFSK/DH1 - 2480 MHz - Measured Frequency 2483.5 MHz



FCC 47 CFR Part 15, Limit Clause 15.247 (d)

20 dB below the fundamental measured in a 100 kHz bandwidth using a peak detector. If the transmitter complies with the conducted power limits, based on the use of RMS averaging over a time interval, the attenuation required shall be 30 dB below the fundamental instead of 20 dB.

ISED RSS-247, Limit Clause 5.5

In any 100 kHz bandwidth outside the frequency band in which the spread spectrum or digitally modulated device is operating, the RF power that is produced shall be at least 20 dB below that in the 100 kHz bandwidth within the band that contains the highest level of the desired power, based on either an RF conducted or a radiated measurement, provided that the transmitter demonstrates compliance with the peak conducted power limits. If the transmitter complies with the conducted power limits based on the use of root-mean-square averaging over a time interval, as permitted under Section 5.4(4), the attenuation required shall be 30 dB instead of 20 dB. Attenuation below the general field strength limits specified in RSS-Gen is not required.

2.5.7 Test Location and Test Equipment Used

This test was carried out in EMC Chamber 5.

Instrument	Manufacturer	Type No.	TE No.	Calibration Period (months)	Calibration Due
Screened Room (5)	Rainford	Rainford	1545	36	23-Jan-2021
Turntable Controller	Inn-Co GmbH	CO 1000	1606	-	TU
Hygrometer	Rotronic	HYGROPALM 1	2338	12	15-Nov-2019
EMI Test Receiver	Rohde & Schwarz	ESU40	3506	12	17-Dec-2019
Cable (Rx, Km-Km 2m)	Scott Cables	KPS-1501-2000-KPS	4526	6	26-Apr-2019
1 - 18GHz DRG Antenna	ETS-Lindgren	3117	4738	12	05-Mar-2020
Mast Controller	Maturo GmbH	NCD	4810	-	TU
Tilt Antenna Mast	Maturo GmbH	TAM 4.0-P	4811	-	TU
8m N-Type RF Cable	Teledyne	PR90-088-8MTR	5093	12	04-Oct-2019
EmX Software	TUV SUD	EmX V.1.4.6	5125	-	Software
Screened Room (5)	Rainford	Rainford	1545	36	23-Jan-2021

Table 16

TU – Traceability Unscheduled



2.6 Restricted Band Edges

2.6.1 Specification Reference

FCC 47 CFR Part 15C, Clause 15.205
ISED RSS-GEN, Clause 8.10

2.6.2 Equipment Under Test and Modification State

SC2124, S/N: 2PS001845GM55XT - Modification State 0

2.6.3 Date of Test

25-March-2019

2.6.4 Test Method

This test was performed in accordance with ANSI C63.10, clause 6.10.5.

Plots for average measurements were taken in accordance with ANSI C63.10 clause 4.1.4.2.3. These are shown for information purposes and were used to determine the worst-case measurement point. Final average measurements were then taken in accordance with ANSI C63.10 clause 4.1.4.2.2. to obtain the measurement result recorded in the test results tables.

The following conversion can be applied to convert from dBµV/m to µV/m:
 $10^{(\text{Field Strength in dB}\mu\text{V/m}/20)}$.

2.6.5 Environmental Conditions

Ambient Temperature 20.6 °C
Relative Humidity 31.5 %

2.6.6 Test Results

Bluetooth Low Energy - Transmit

Modulation	Packet Type	Frequency (MHz)	Measured Frequency (MHz)	Peak Level (dBµV/m)	Average Level (dBµV/m)
GFSK	DH1	2402	2390.0	55.09	45.32
GFSK	DH1	2480	2483.5	57.98	47.08

Table 17

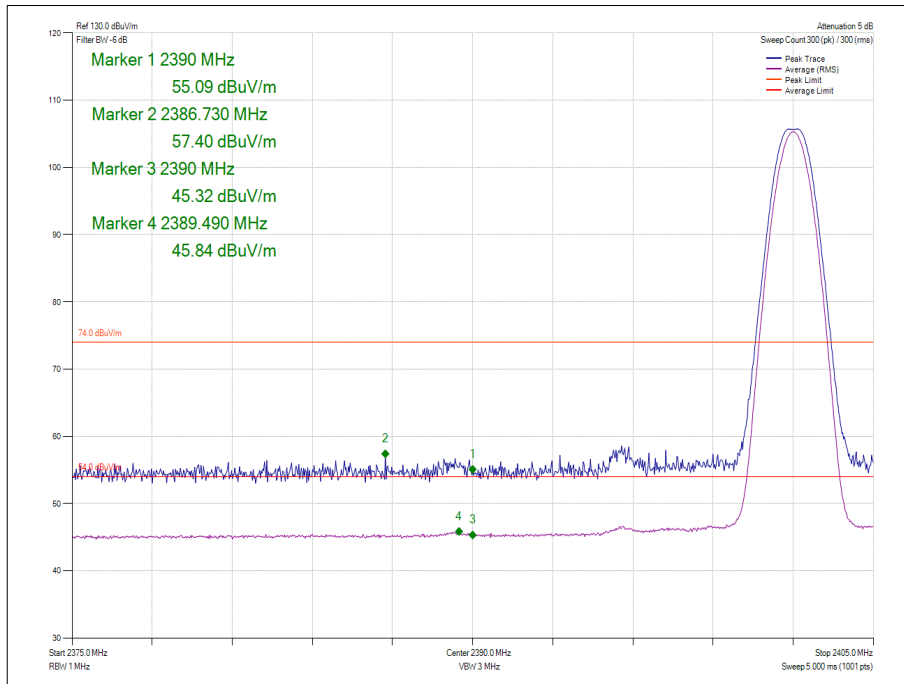

Figure 14 - GFSK/DH1 - 2402 MHz - Measured Frequency 2390.0 MHz

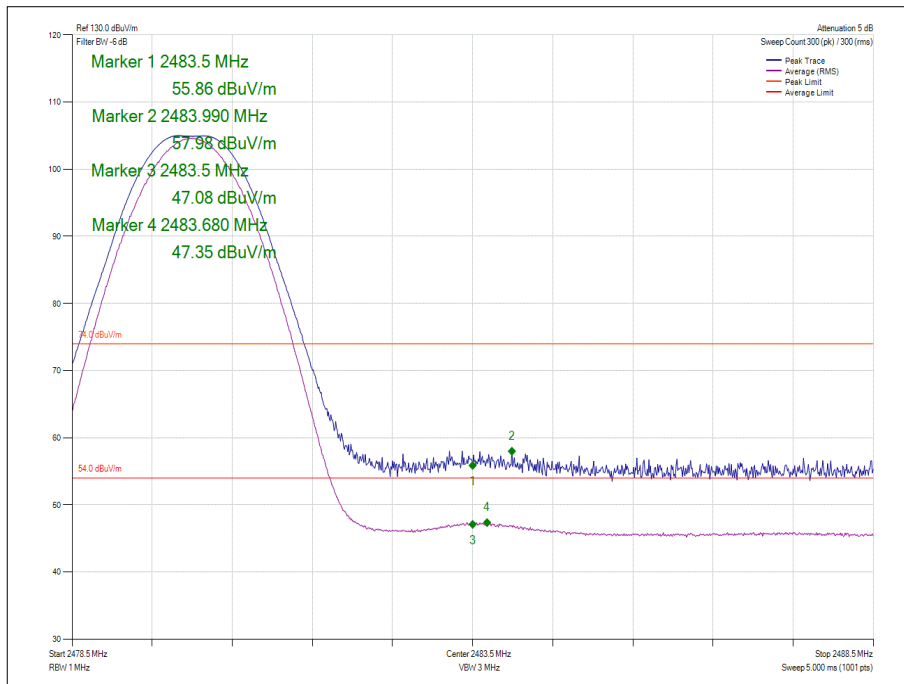

Figure 15 - GFSK/DH1 - 2480 MHz - Measured Frequency 2483.5 MHz



FCC 47 CFR Part 15, Limit Clause 15.209

Frequency (MHz)	Field Strength ($\mu\text{V}/\text{m}$ at 3 m)
30 to 88	100
88 to 216	150
216 to 960	200
Above 960	500

Table 18

ISED RSS-GEN, Limit Clause 8.9

Frequency (MHz)	Field Strength ($\mu\text{V}/\text{m}$ at 3 metres)
30-88	100
88-216	150
216-960	200
Above 960*	500

Table 19

*Unless otherwise specified, for all frequencies greater than 1 GHz, the radiated emission limits for licence-exempt radio apparatus stated in applicable RSSs (including RSS-Gen) are based on measurements using a linear average detector function having a minimum resolution bandwidth of 1 MHz. If an average limit is specified for the EUT, then the peak emission shall also be measured with instrumentation properly adjusted for such factors as pulse desensitization to ensure the peak emission is less than 20 dB above the average limit.



2.6.7 Test Location and Test Equipment Used

This test was carried out in EMC Chamber 5.

Instrument	Manufacturer	Type No.	TE No.	Calibration Period (months)	Calibration Due
Screened Room (5)	Rainford	Rainford	1545	36	23-Jan-2021
Turntable Controller	Inn-Co GmbH	CO 1000	1606	-	TU
Hygrometer	Rotronic	HYGROPALM 1	2338	12	15-Nov-2019
EMI Test Receiver	Rohde & Schwarz	ESU40	3506	12	17-Dec-2019
Cable (Rx, Km-Km 2m)	Scott Cables	KPS-1501-2000-KPS	4526	6	26-Apr-2019
1 - 18GHz DRG Antenna	ETS-Lindgren	3117	4738	12	05-Mar-2020
Mast Controller	Maturo GmbH	NCD	4810	-	TU
Tilt Antenna Mast	Maturo GmbH	TAM 4.0-P	4811	-	TU
8m N-Type RF Cable	Teledyne	PR90-088-8MTR	5093	12	04-Oct-2019
EmX Software	TUV SUD	EmX V.1.4.6	5125	-	Software
Screened Room (5)	Rainford	Rainford	1545	36	23-Jan-2021

Table 20

TU – Traceability Unscheduled



2.7 Spurious Radiated Emissions

2.7.1 Specification Reference

FCC 47 CFR Part 15C, Clause 15.247 (d) and 15.205
 ISEDC RSS-247, Clause 5.5
 ISEDC RSS-GEN Clause 6.13

2.7.2 Equipment Under Test and Modification State

SC2124, S/N: 2PS001845GM55XT - Modification State 0

2.7.3 Date of Test

25-March-2019 to 26-March-2019

2.7.4 Test Method

This test was performed in accordance with ANSI C63.10-2013 clause 6.3, 6.5 and 6.6. The plots show the characterization of the EUT. The limits on the plots represent the most stringent case for restricted bands, (74/54 dBuV/m) when compared to 20 dBc outside restricted bands. The limits shown have been used as a threshold to determine where further measurements are necessary. Where results are within 10 dB of the limits shown on the plots, further investigation was carried out and reported in results tables.

For frequencies greater than 1 GHz, plots for average measurements were taken with an RMS detector and a max hold trace to characterize the EUT. Where emissions were detected, final average measurements were taken in accordance with ANSI C63.10 clause 4.1.4.2.2.

If emissions were found to be pulsed, final measurements were taken in accordance with ANSI C63.10 clause 7.5. A peak measurement is performed. A duty cycle correction factor is then determined by the expression $duty\ (dB) = 20\log(\text{On Time}/(\text{On Time} + \text{Off Time}))$. This factor is then added to the peak value to determine the average value.

The following conversion can be applied to convert from dBuV/m to uV/m: $10^{(\text{Field Strength in dBuV/m}/20)}$.

For frequencies greater than 18 GHz, the measurement distance was reduced to 1 meter and the limit line was increased by $20 * \text{LOG}(3/1) = 9.54\ \text{dB}$.

2.7.5 Environmental Conditions

Ambient Temperature 20.6 °C
 Relative Humidity 31.5 %

2.7.6 Test Results

Bluetooth Low Energy - Transmit

Frequency (MHz)	Result (dBuV/m)		Limit (dBuV/m)		Margin (dBuV/m)		Polarisation	EUT Orientation
	Peak	Average	Peak	Average	Peak	Average		
*								

Table 21 - 2402 MHz - 30 MHz to 1 GHz Emissions Results

*No emissions were detected within 10 dB of the limit.

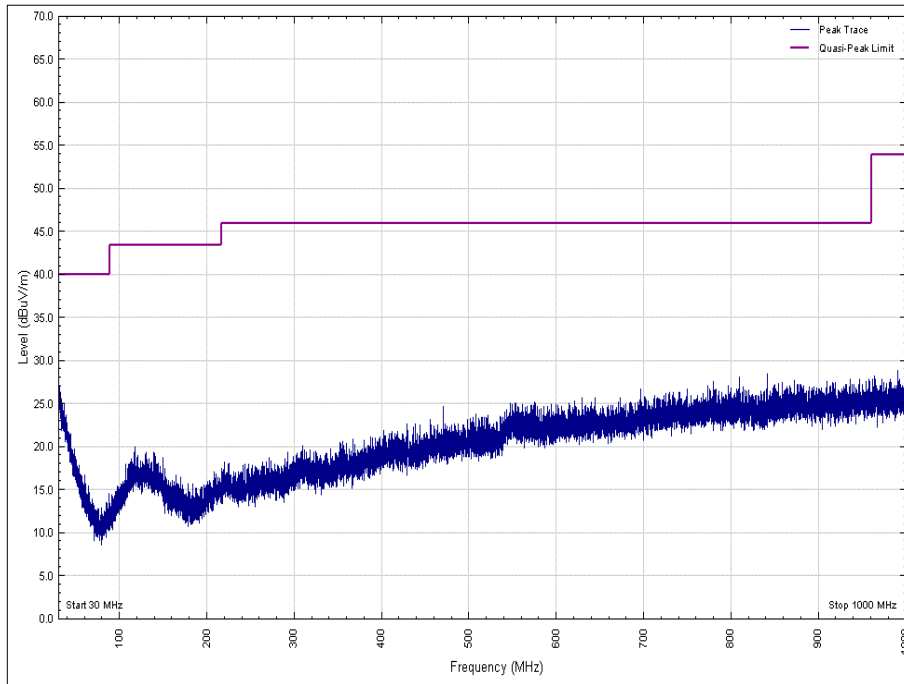

Figure 16 - 2402 MHz - 30 MHz to 1 GHz, Polarity: Vertical, EUT Orientation: X

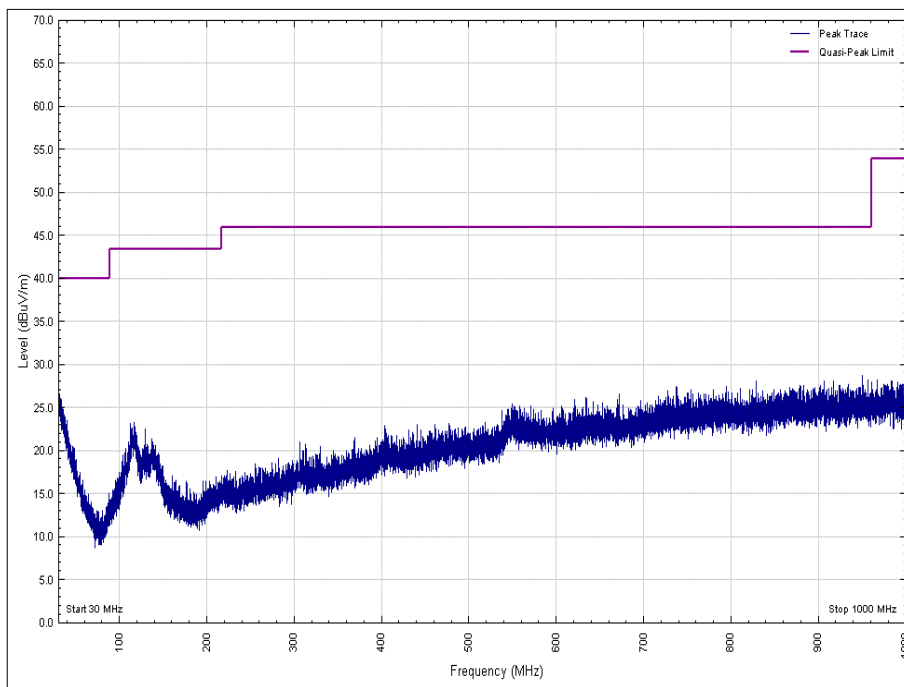

Figure 17 - 2402 MHz - 30 MHz to 1 GHz, Polarity: Horizontal, EUT Orientation: X

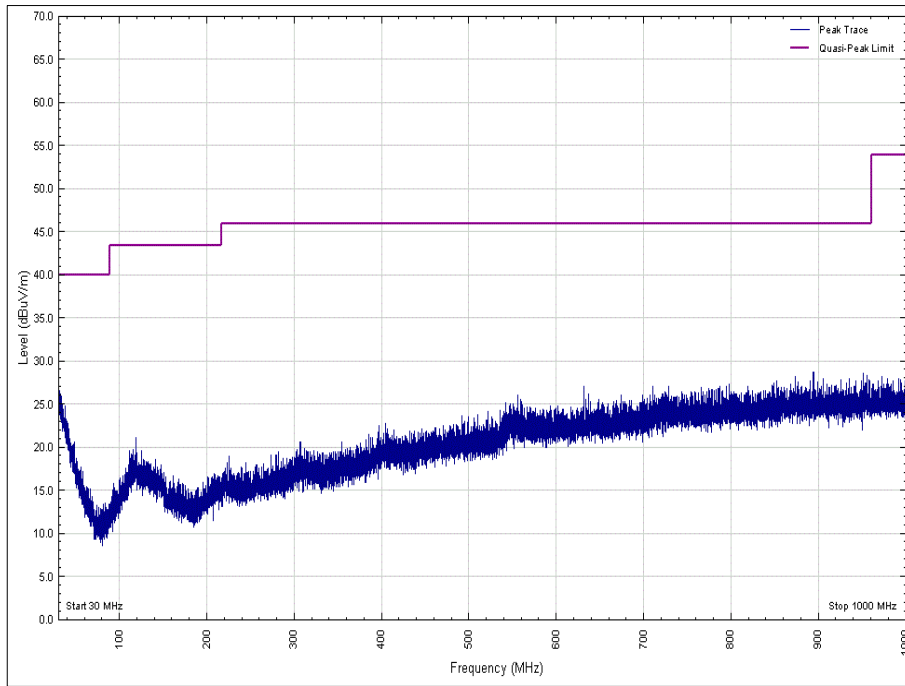

Figure 18 - 2402 MHz - 30 MHz to 1 GHz, Polarity: Vertical, EUT Orientation: Y

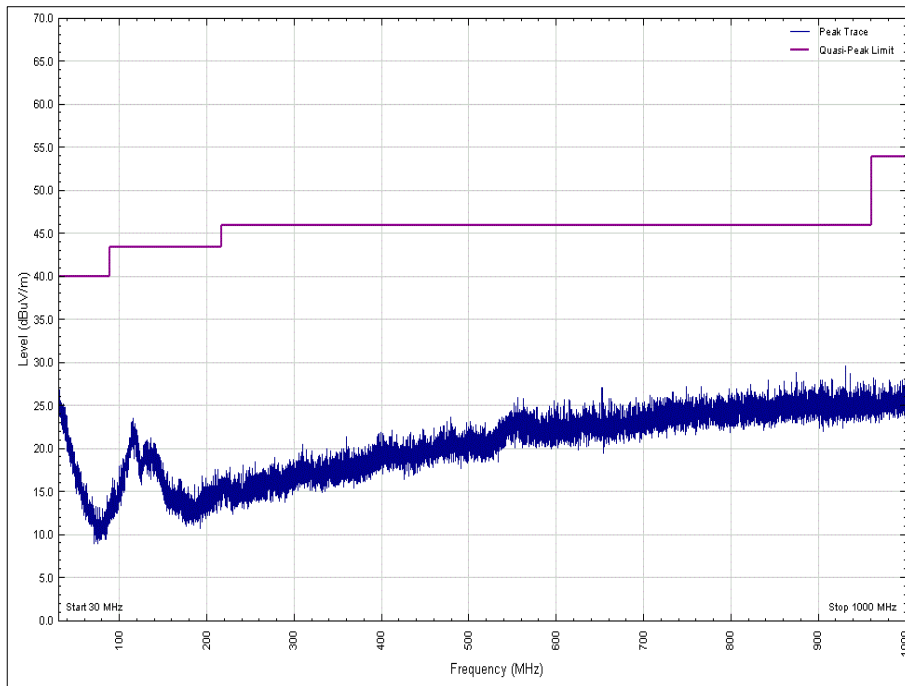

Figure 19 - 2402 MHz - 30 MHz to 1 GHz, Polarity: Horizontal, EUT Orientation: Y

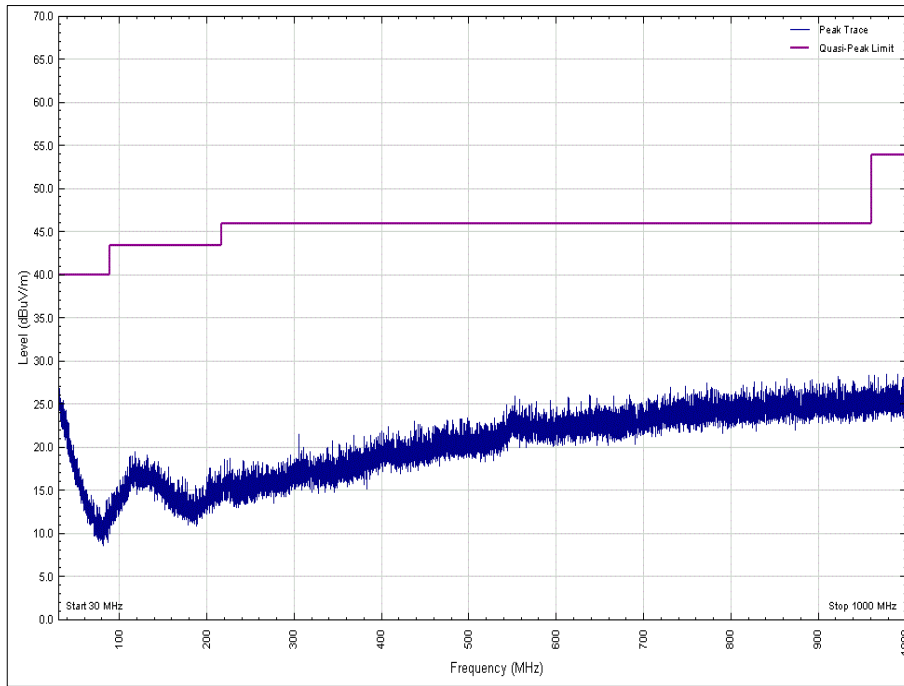

Figure 20 - 2402 MHz - 30 MHz to 1 GHz, Polarity: Vertical, EUT Orientation: Z

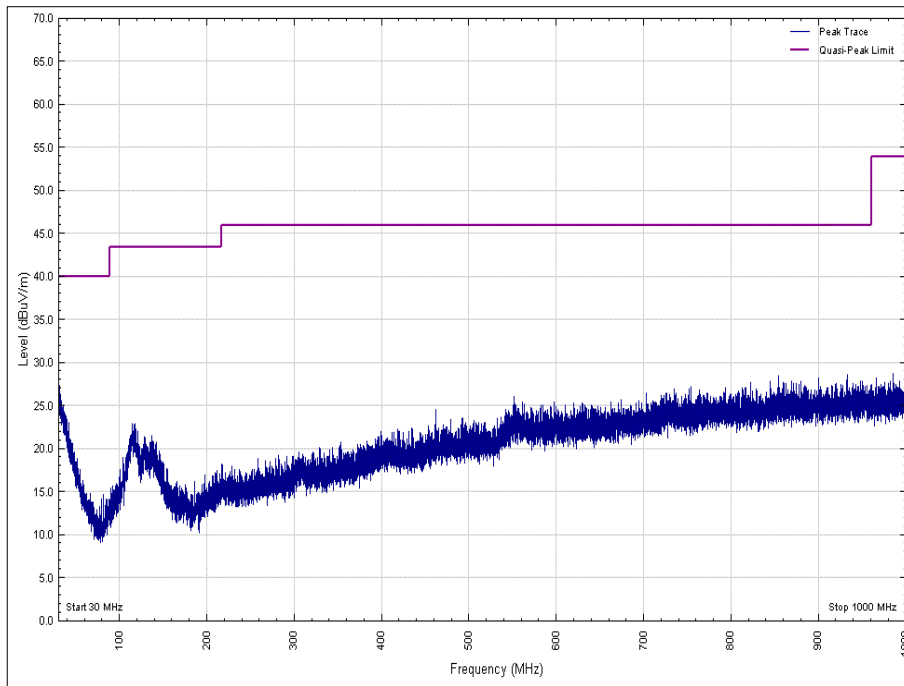

Figure 21 - 2402 MHz - 30 MHz to 1 GHz, Polarity: Horizontal, EUT Orientation: Z



Frequency (GHz)	Result (dB μ V/m)		Limit (dB μ V/m)		Margin (dB μ V/m)	
	Peak	Average	Peak	Average	Peak	Average
*						

Table 22 - 2402 MHz - 1 GHz to 25 GHz Emissions Results

*No emissions were detected within 10 dB of the limit.

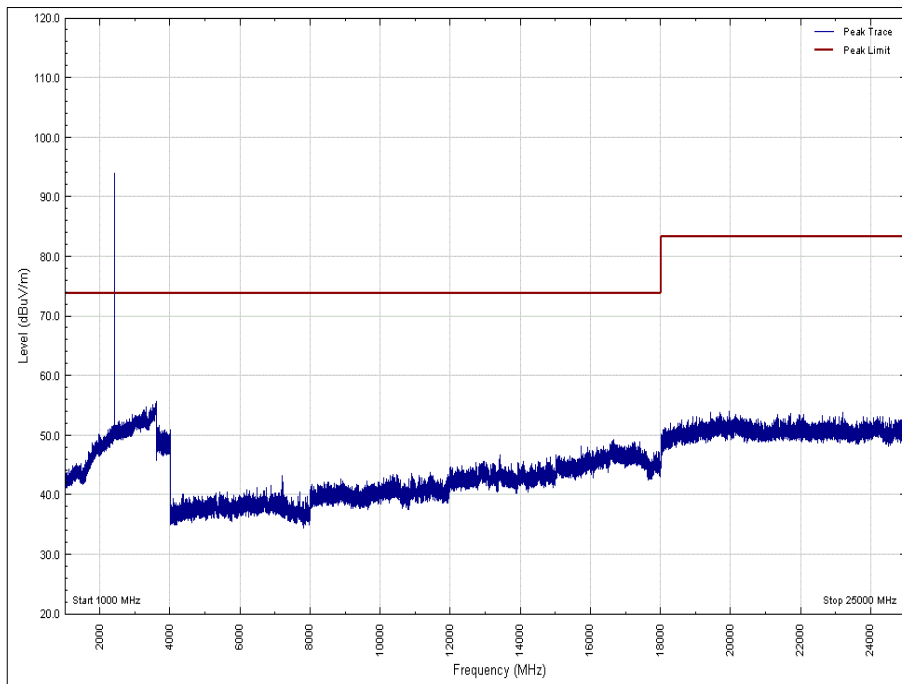

**Figure 22 - 2402 MHz - 1 GHz to 25 GHz - Peak
 Polarity: Vertical, EUT Orientation: X**

Note - The emission seen at 2402 MHz is the EUT's intentional transmitter frequency and is therefore not subject to this test.

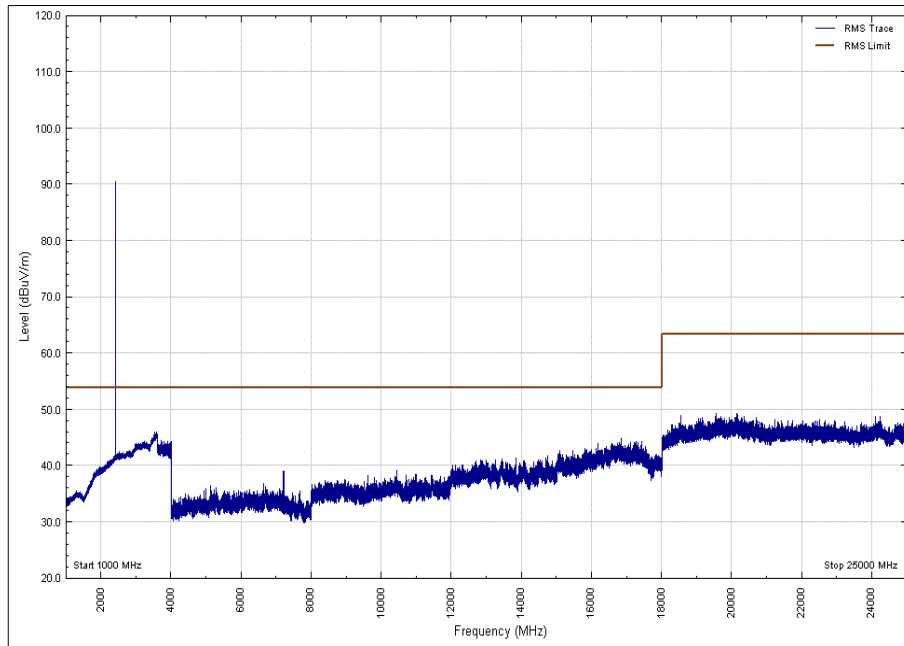

**Figure 23 - 2402 MHz - 1 GHz to 25 GHz - Average
Polarity: Vertical, EUT Orientation: X**

Note - The emission seen at 2402 MHz is the EUT's intentional transmitter frequency and is therefore not subject to this test.

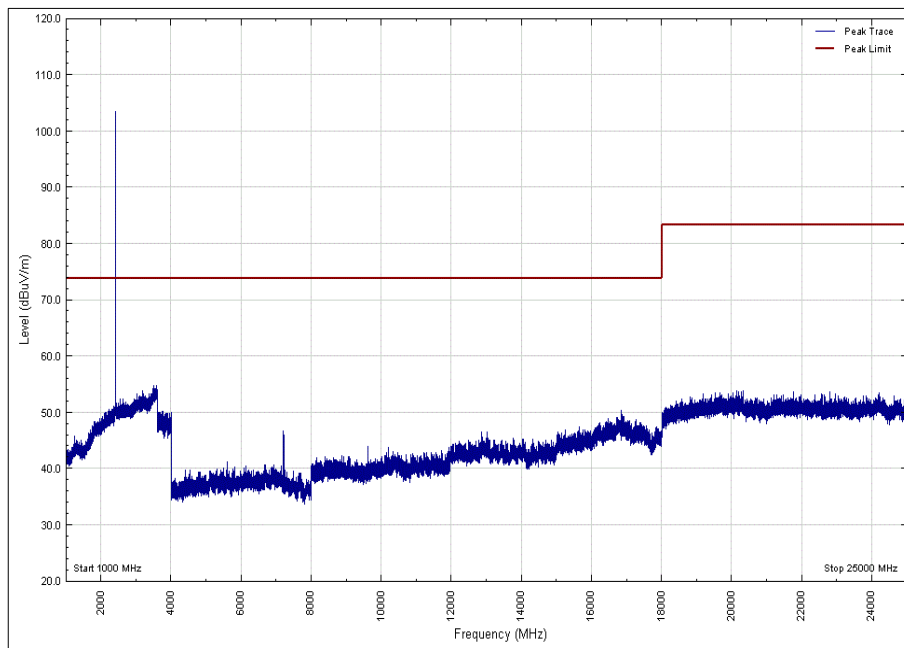

**Figure 24 - 2402 MHz - 1 GHz to 25 GHz - Peak
Polarity: Horizontal, EUT Orientation: X**

Note - The emission seen at 2402 MHz is the EUT's intentional transmitter frequency and is therefore not subject to this test.

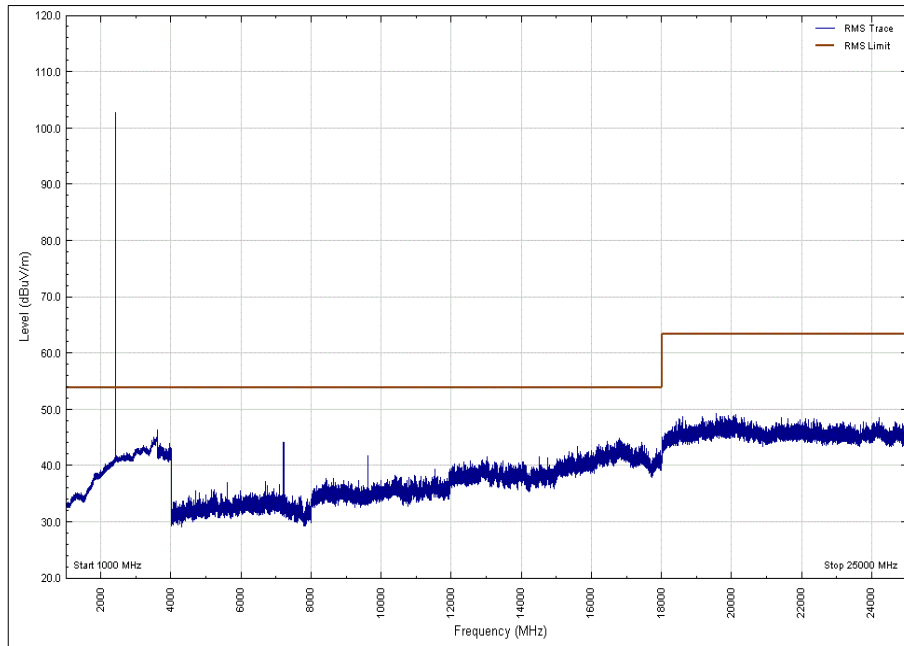

**Figure 25 - 2402 MHz - 1 GHz to 25 GHz - Average
Polarity: Horizontal, EUT Orientation: X**

Note - The emission seen at 2402 MHz is the EUT's intentional transmitter frequency and is therefore not subject to this test.

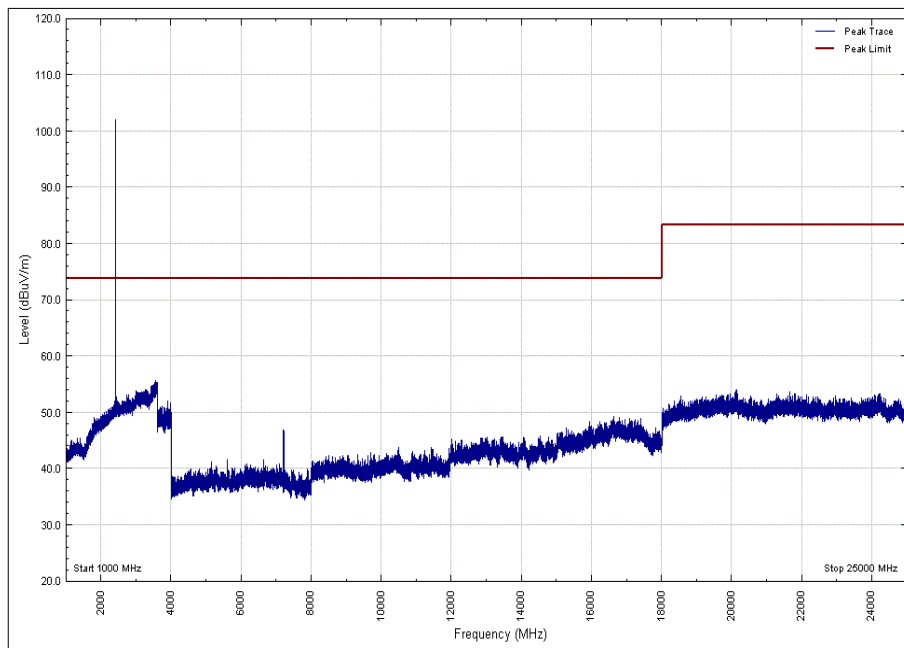

**Figure 26 - 2402 MHz - 1 GHz to 25 GHz - Peak
Polarity: Vertical, EUT Orientation: Y**

Note - The emission seen at 2402 MHz is the EUT's intentional transmitter frequency and is therefore not subject to this test.

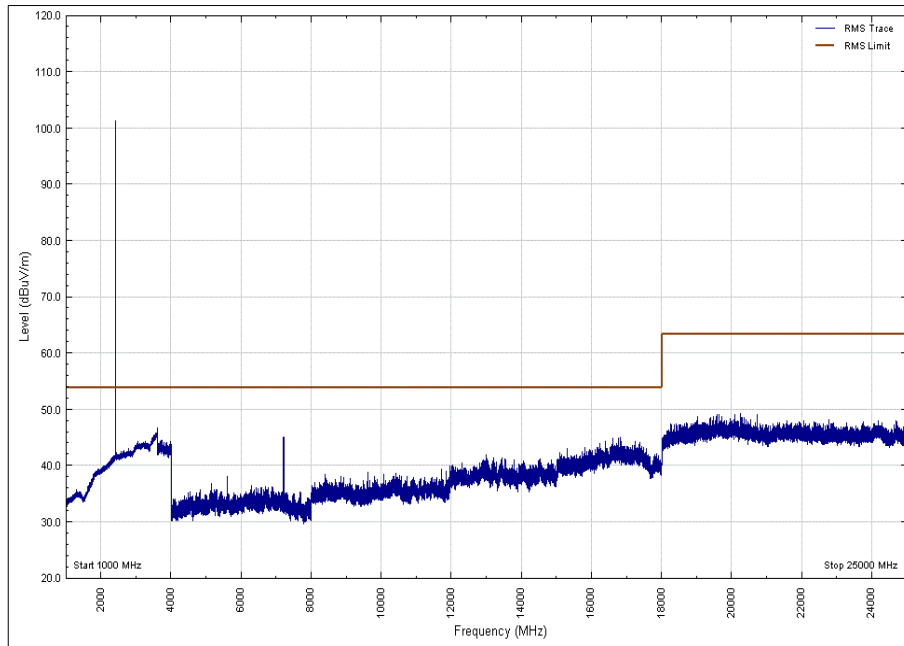

**Figure 27 - 2402 MHz - 1 GHz to 25 GHz - Average
Polarity: Vertical, EUT Orientation: Y**

Note - The emission seen at 2402 MHz is the EUT's intentional transmitter frequency and is therefore not subject to this test.

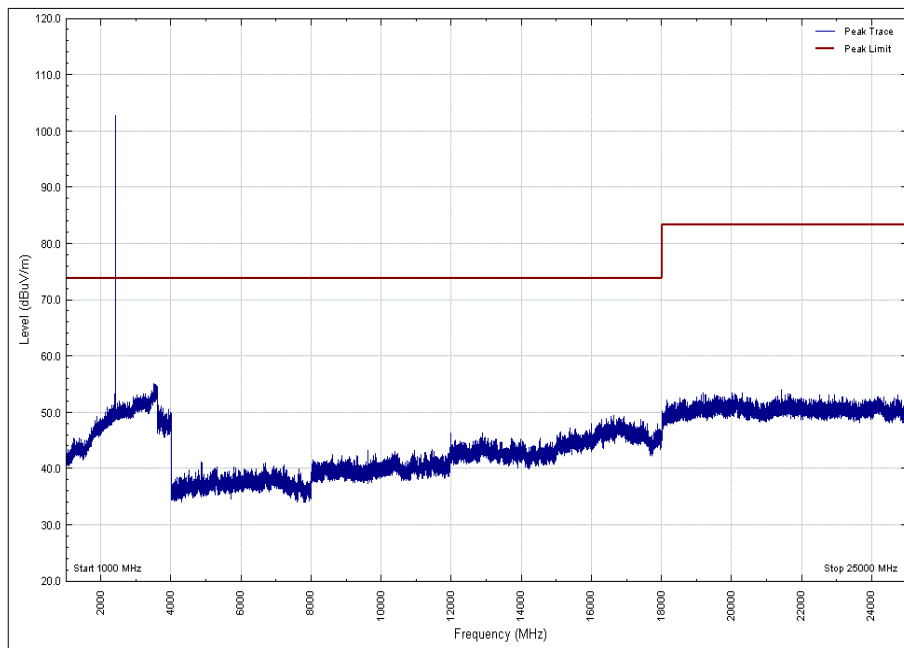

**Figure 28 - 2402 MHz - 1 GHz to 25 GHz - Peak
Polarity: Horizontal, EUT Orientation: Y**

Note - The emission seen at 2402 MHz is the EUT's intentional transmitter frequency and is therefore not subject to this test.

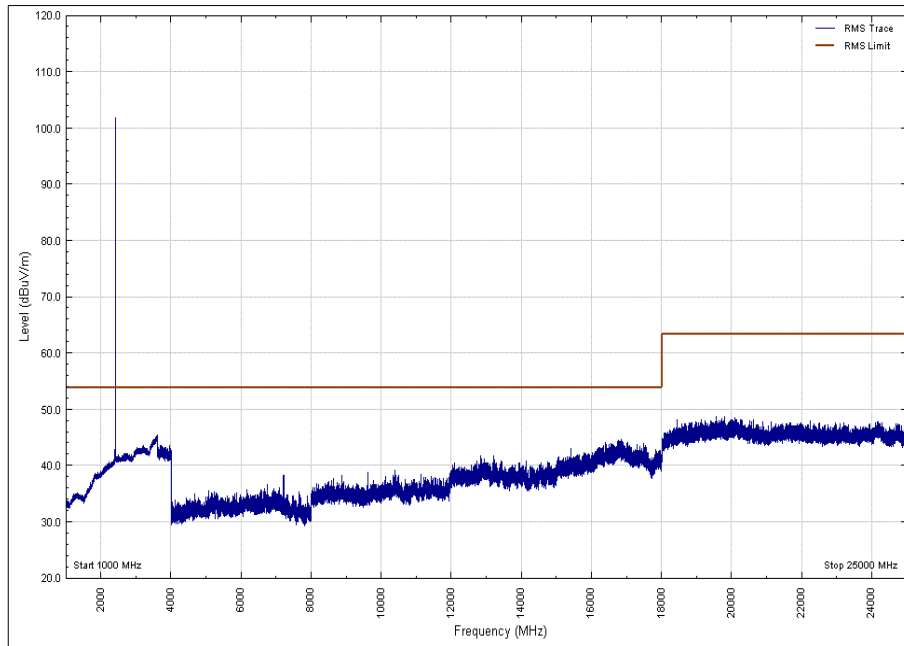

**Figure 29 - 2402 MHz - 1 GHz to 25 GHz - Average
Polarity: Horizontal, EUT Orientation: Y**

Note - The emission seen at 2402 MHz is the EUT's intentional transmitter frequency and is therefore not subject to this test.

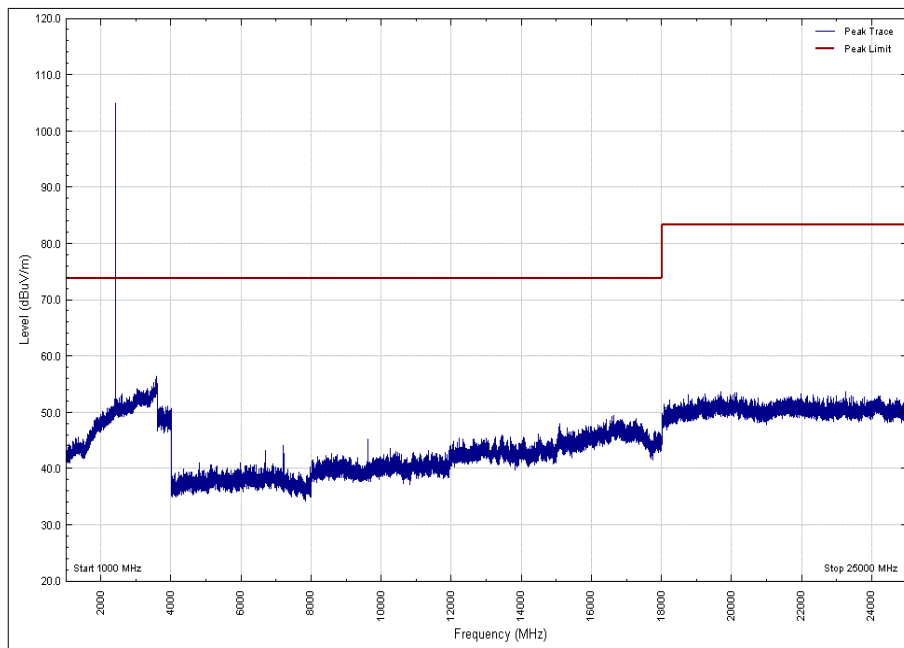

**Figure 30 - 2402 MHz - 1 GHz to 25 GHz - Peak
Polarity: Vertical, EUT Orientation: Z**

Note - The emission seen at 2402 MHz is the EUT's intentional transmitter frequency and is therefore not subject to this test.

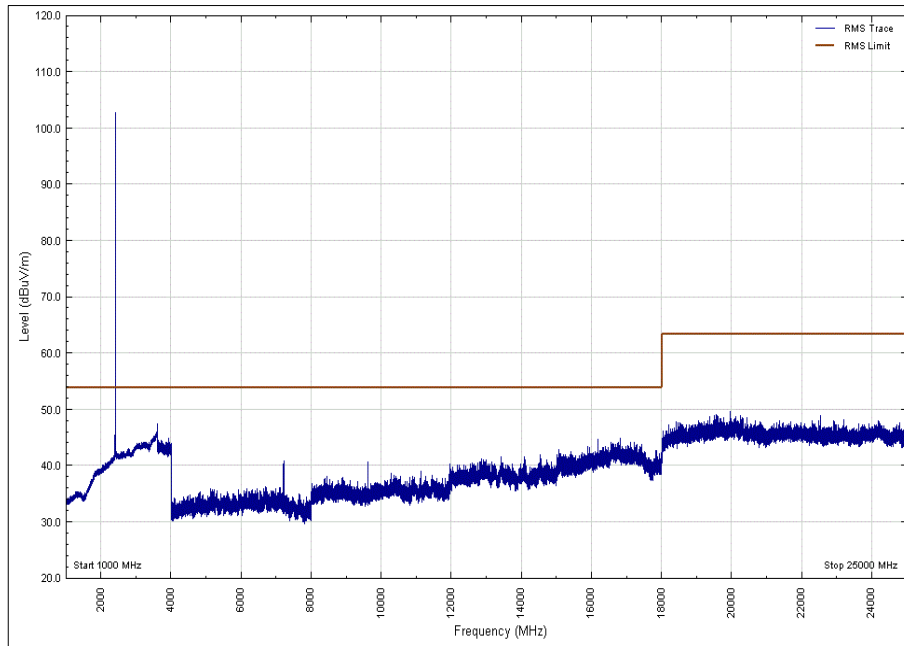

**Figure 31 - 2402 MHz - 1 GHz to 25 GHz - Average
Polarity: Vertical, EUT Orientation: Z**

Note - The emission seen at 2402 MHz is the EUT's intentional transmitter frequency and is therefore not subject to this test.

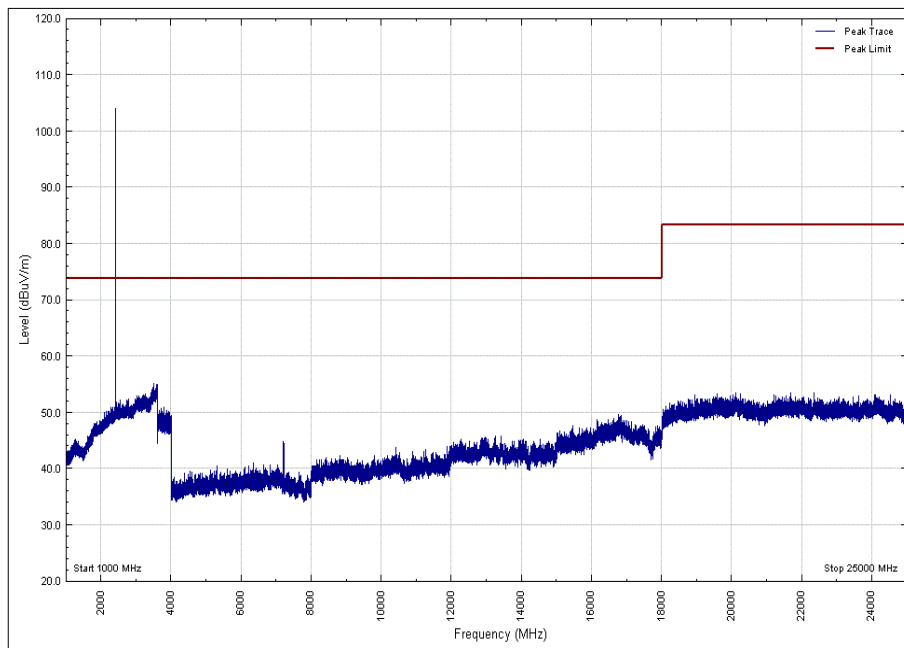

**Figure 32 - 2402 MHz - 1 GHz to 25 GHz - Peak
Polarity: Horizontal, EUT Orientation: Z**

Note - The emission seen at 2402 MHz is the EUT's intentional transmitter frequency and is therefore not subject to this test.

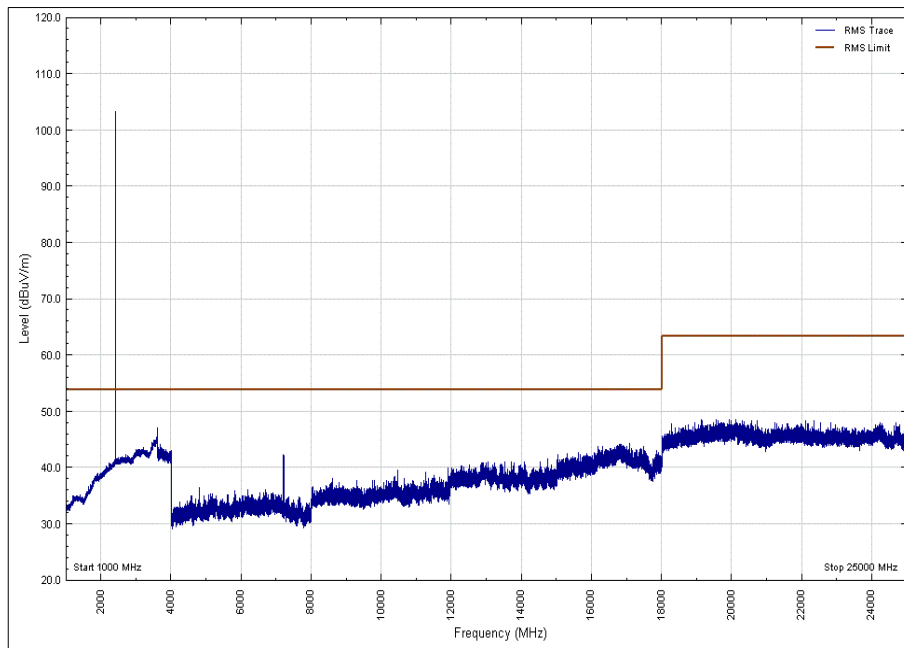

**Figure 33 - 2402 MHz - 1 GHz to 25 GHz - Average
Polarity: Horizontal, EUT Orientation: Z**

Note - The emission seen at 2402 MHz is the EUT's intentional transmitter frequency and is therefore not subject to this test.



Frequency (MHz)	Result (dBµV/m)		Limit (dBµV/m)		Margin (dBµV/m)		Polarisation	EUT Orientation
	Peak	Average	Peak	Average	Peak	Average		
*								

Table 23 - 2440 MHz - 30 MHz to 1 GHz Emissions Results

*No emissions were detected within 10 dB of the limit.

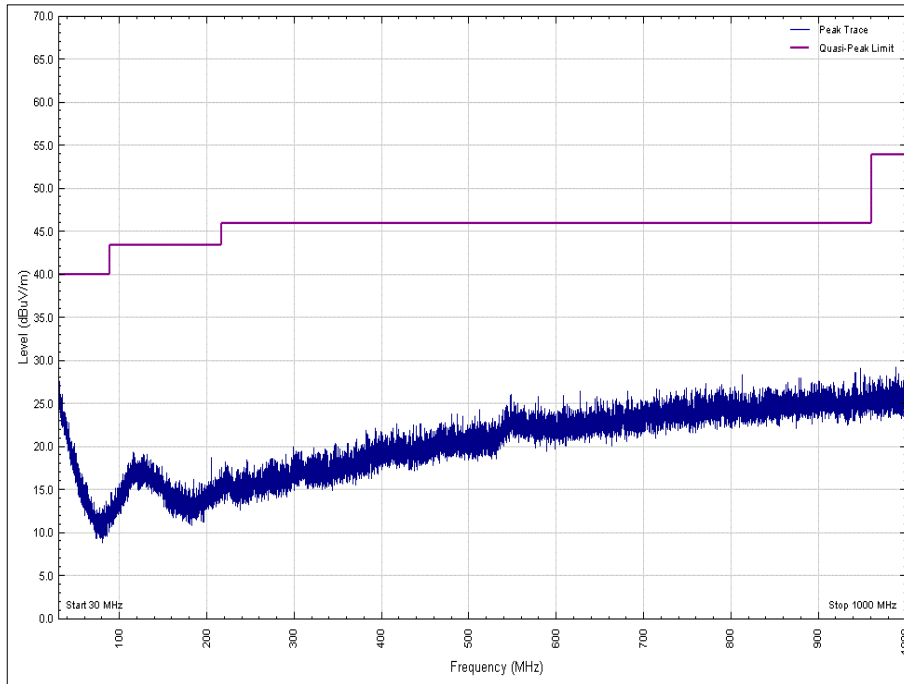

Figure 34 - 2440 MHz - 30 MHz to 1 GHz, Polarity: Vertical, EUT Orientation: X

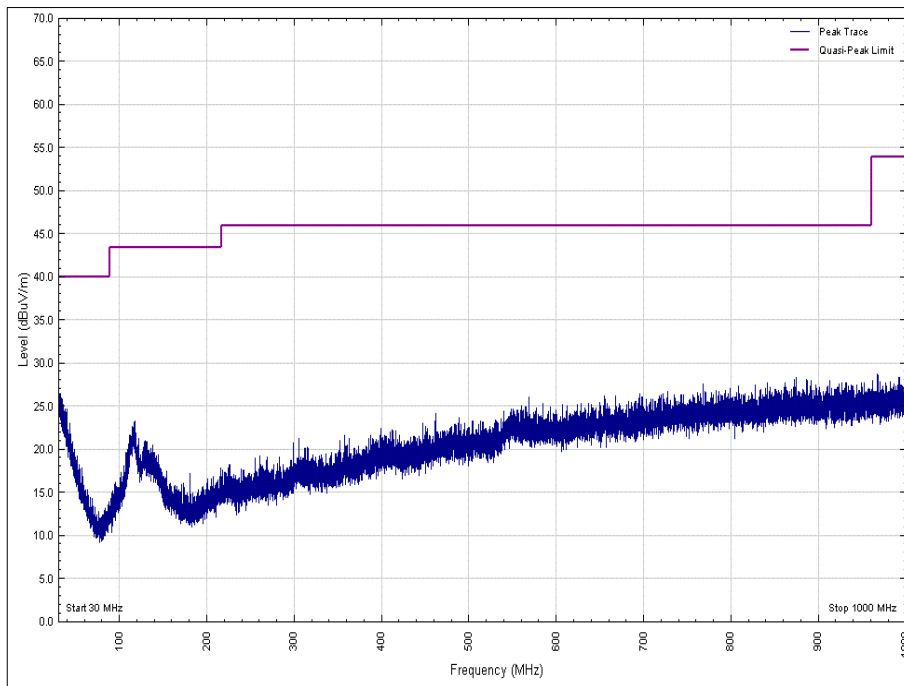

Figure 35 - 2440 MHz - 30 MHz to 1 GHz, Polarity: Horizontal, EUT Orientation: X

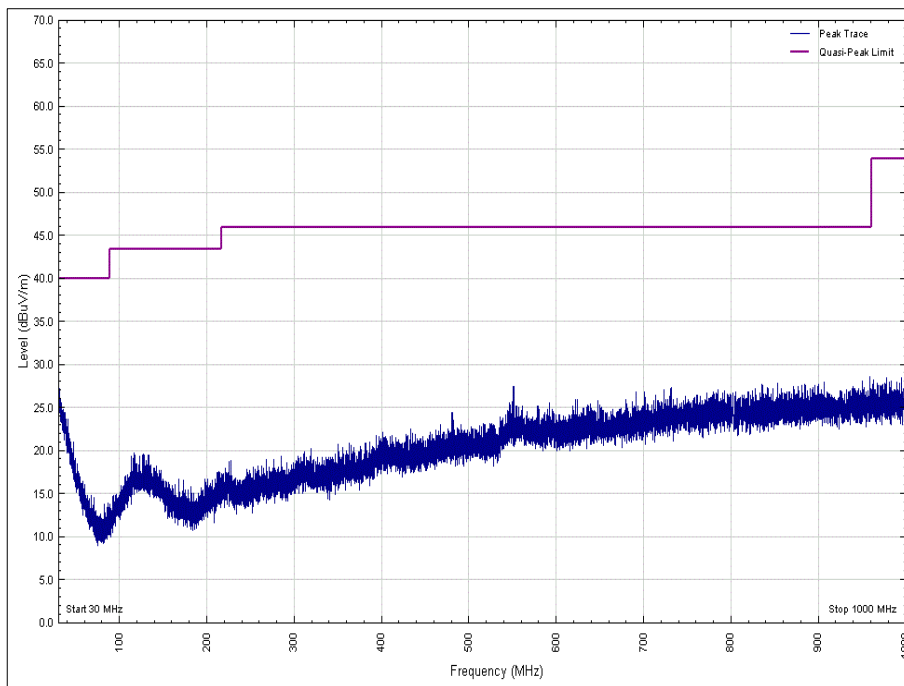

Figure 36 - 2440 MHz - 30 MHz to 1 GHz, Polarity: Vertical, EUT Orientation: Y

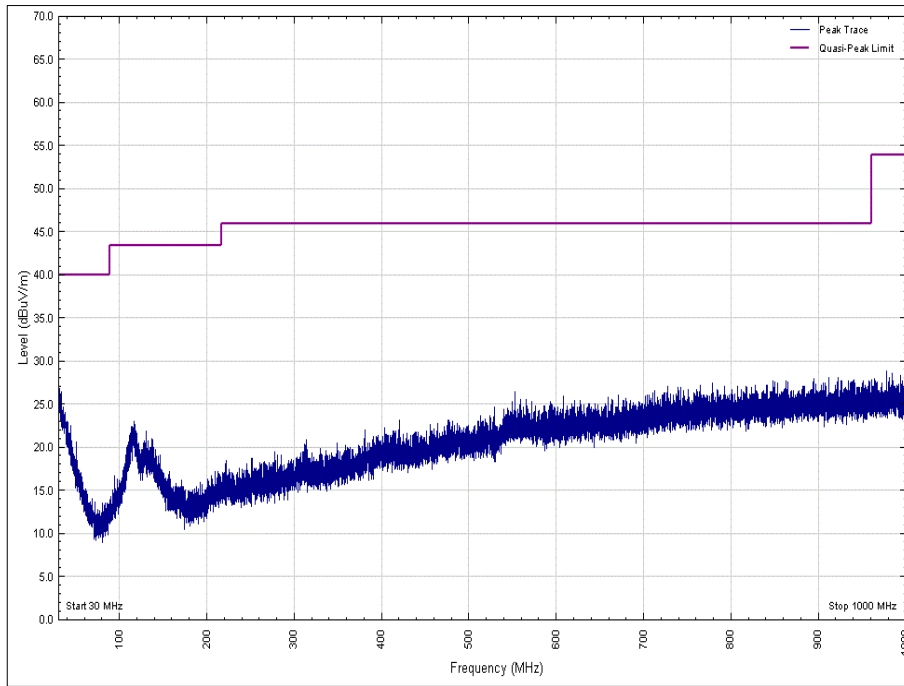

Figure 37 - 2440 MHz - 30 MHz to 1 GHz, Polarity: Horizontal, EUT Orientation: Y

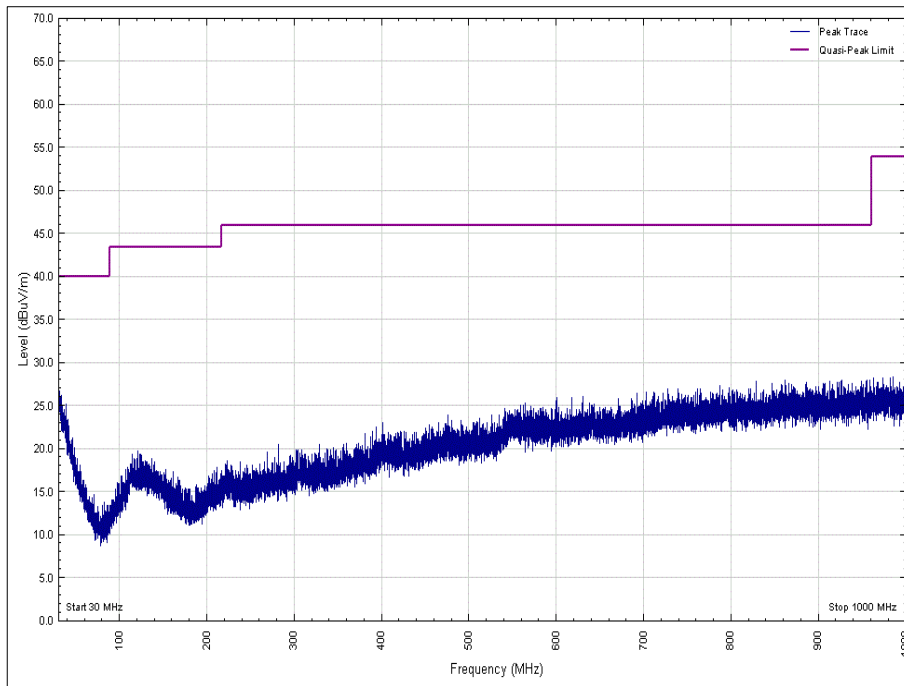

Figure 38 - 2440 MHz - 30 MHz to 1 GHz, Polarity: Vertical, EUT Orientation: Z

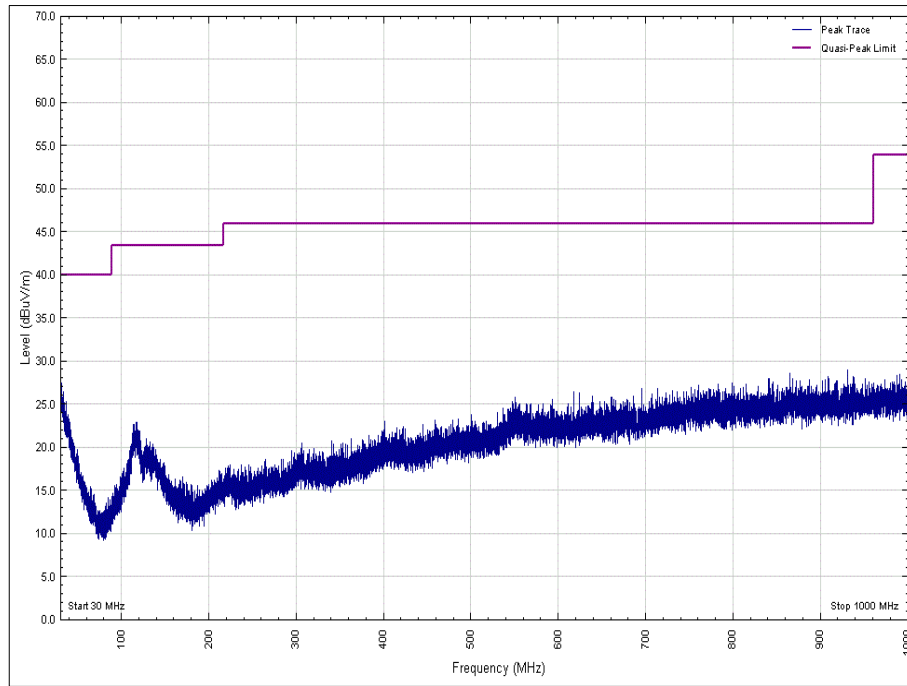

Figure 39 - 2440 MHz - 30 MHz to 1 GHz, Polarity: Horizontal, EUT Orientation: Z



Frequency (GHz)	Result (dB μ V/m)		Limit (dB μ V/m)		Margin (dB μ V/m)	
	Peak	Average	Peak	Average	Peak	Average
*						

Table 24 - 2440 MHz - 1 GHz to 25 GHz Emissions Results

*No emissions were detected within 10 dB of the limit.

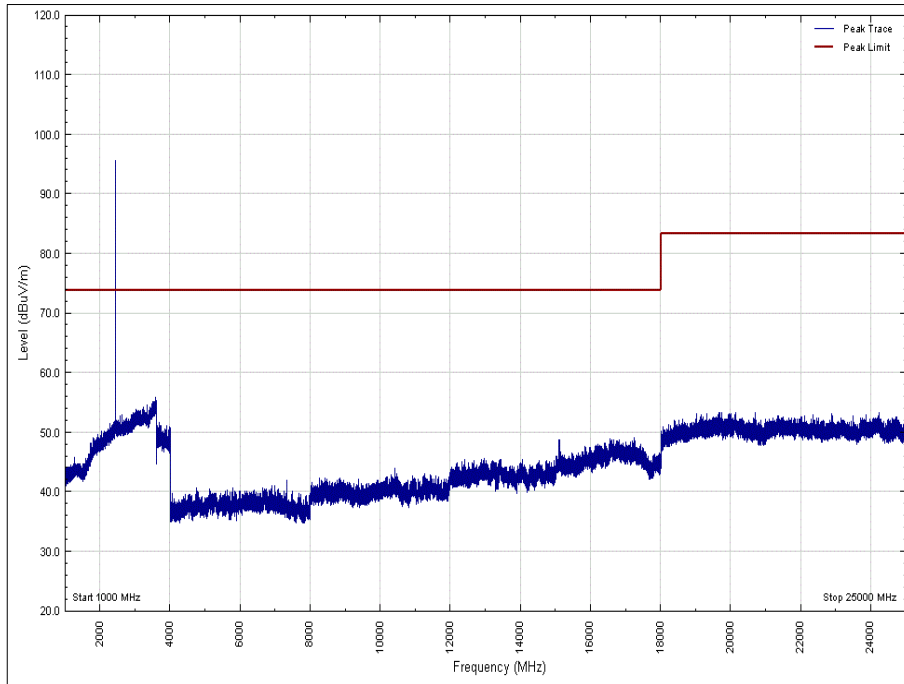

**Figure 40 - 2440 MHz - 1 GHz to 25 GHz - Peak
 Polarity: Vertical, EUT Orientation: X**

Note - The emission seen at 2440 MHz is the EUT's intentional transmitter frequency and is therefore not subject to this test.

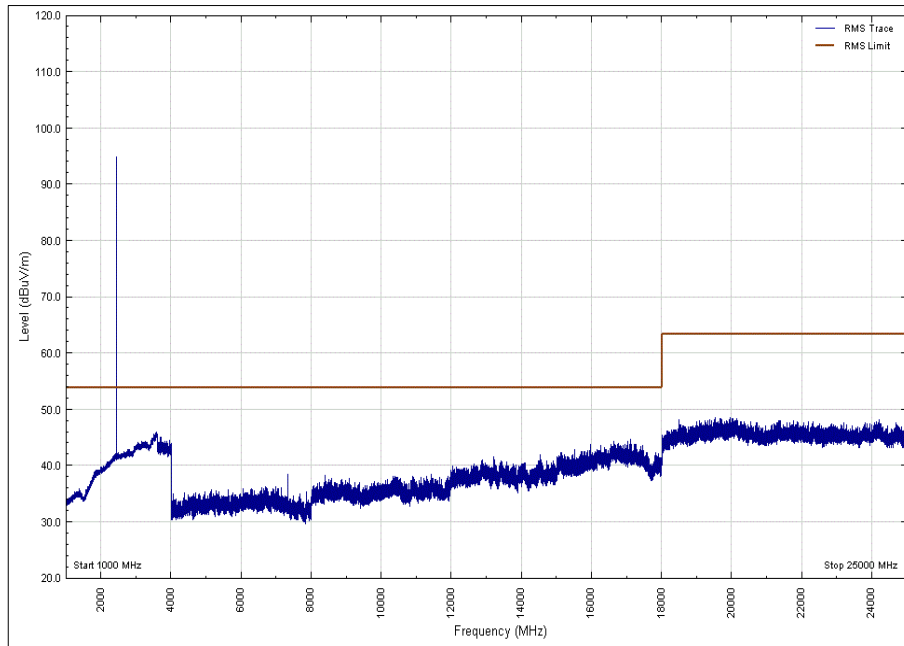

**Figure 41 - 2440 MHz - 1 GHz to 25 GHz - Average
Polarity: Vertical, EUT Orientation: X**

Note - The emission seen at 2440 MHz is the EUT's intentional transmitter frequency and is therefore not subject to this test.

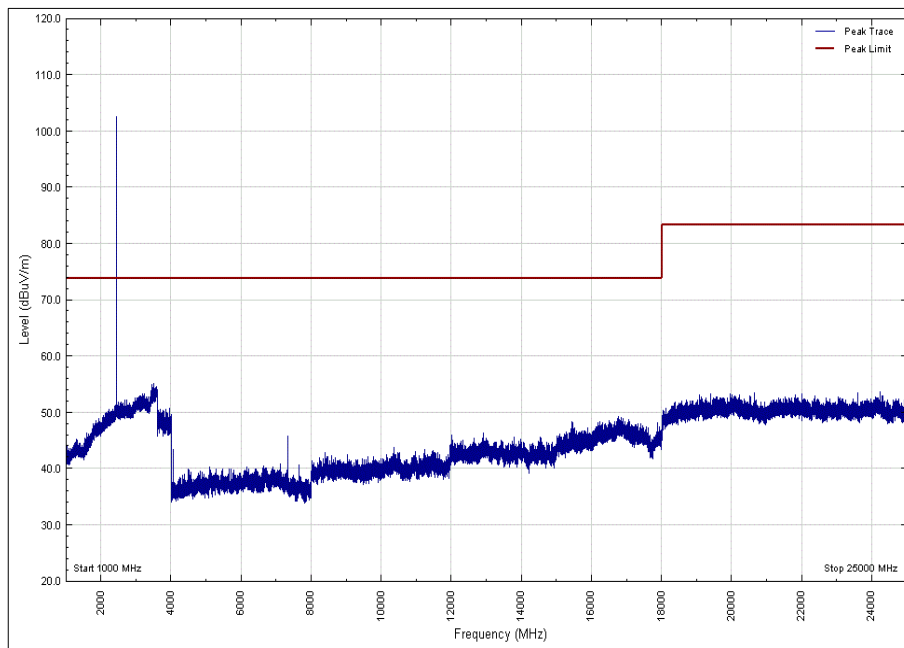

**Figure 42 - 2440 MHz - 1 GHz to 25 GHz - Peak
Polarity: Horizontal, EUT Orientation: X**

Note - The emission seen at 2440 MHz is the EUT's intentional transmitter frequency and is therefore not subject to this test.

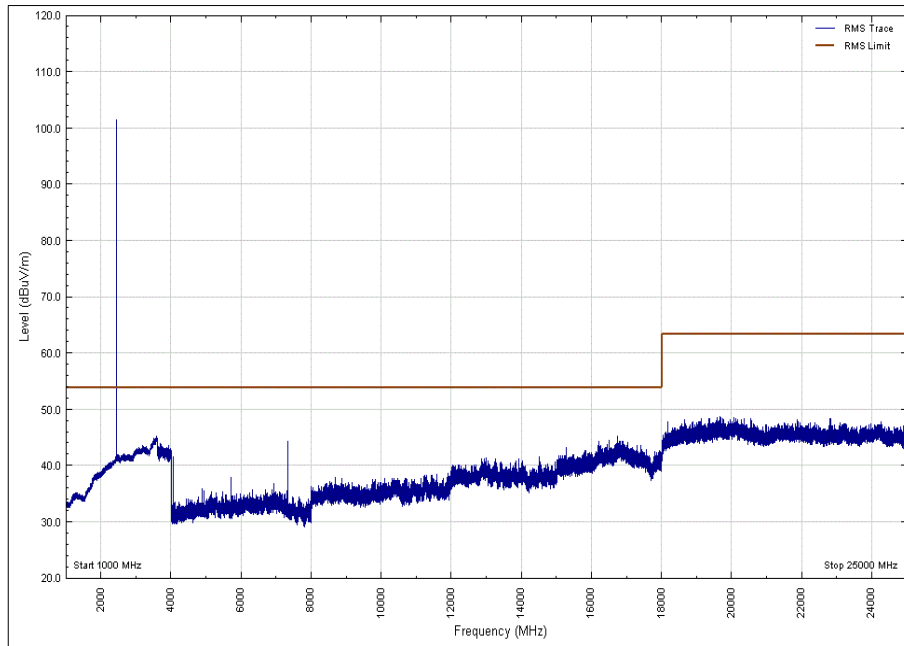

**Figure 43 - 2440 MHz - 1 GHz to 25 GHz - Average
Polarity: Horizontal, EUT Orientation: X**

Note - The emission seen at 2440 MHz is the EUT's intentional transmitter frequency and is therefore not subject to this test.

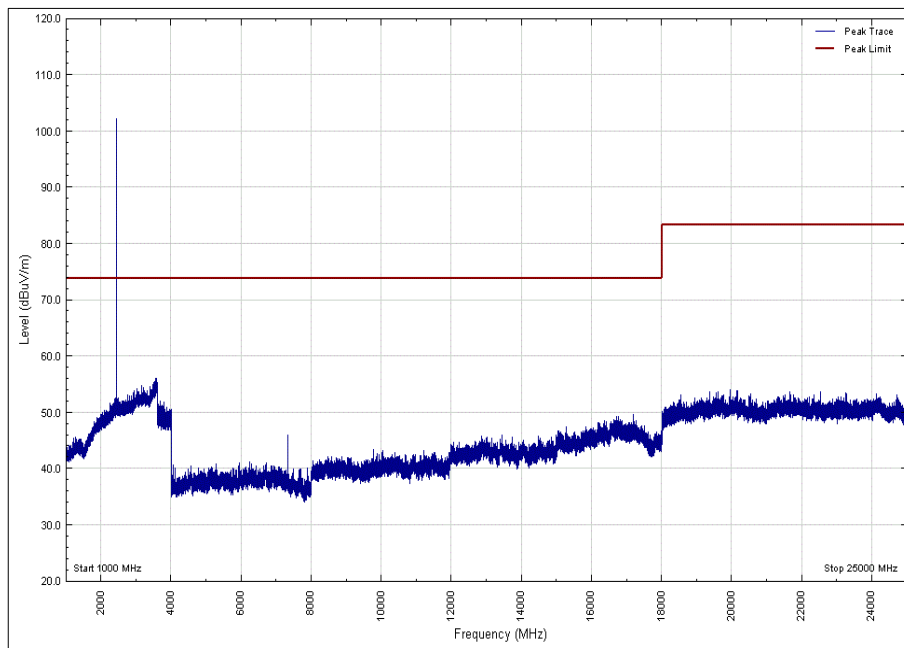

**Figure 44 - 2440 MHz - 1 GHz to 25 GHz - Peak
Polarity: Vertical, EUT Orientation: Y**

Note - The emission seen at 2440 MHz is the EUT's intentional transmitter frequency and is therefore not subject to this test.

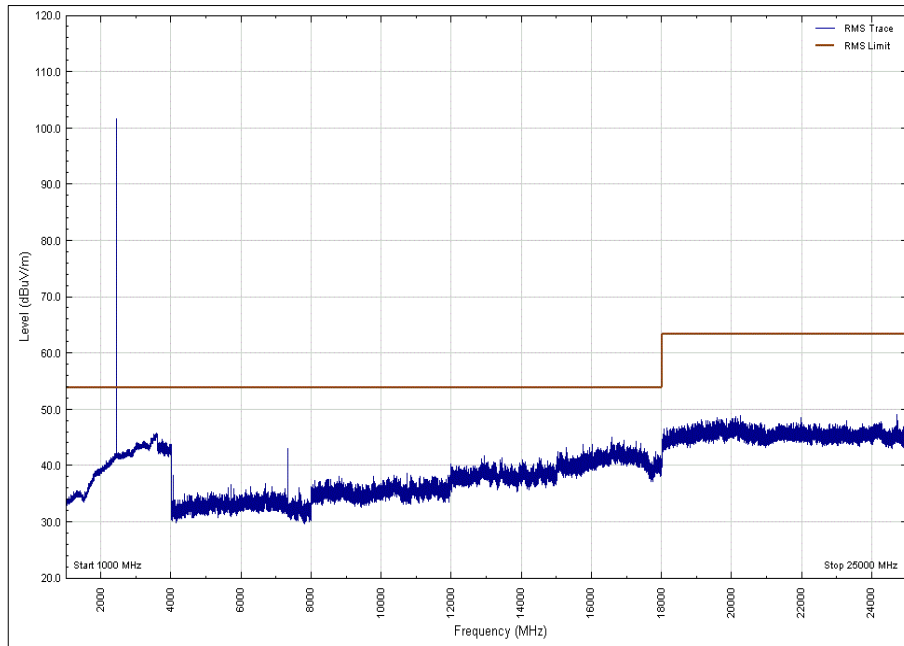

**Figure 45 - 2440 MHz - 1 GHz to 25 GHz - Average
Polarity: Vertical, EUT Orientation: Y**

Note - The emission seen at 2440 MHz is the EUT's intentional transmitter frequency and is therefore not subject to this test.

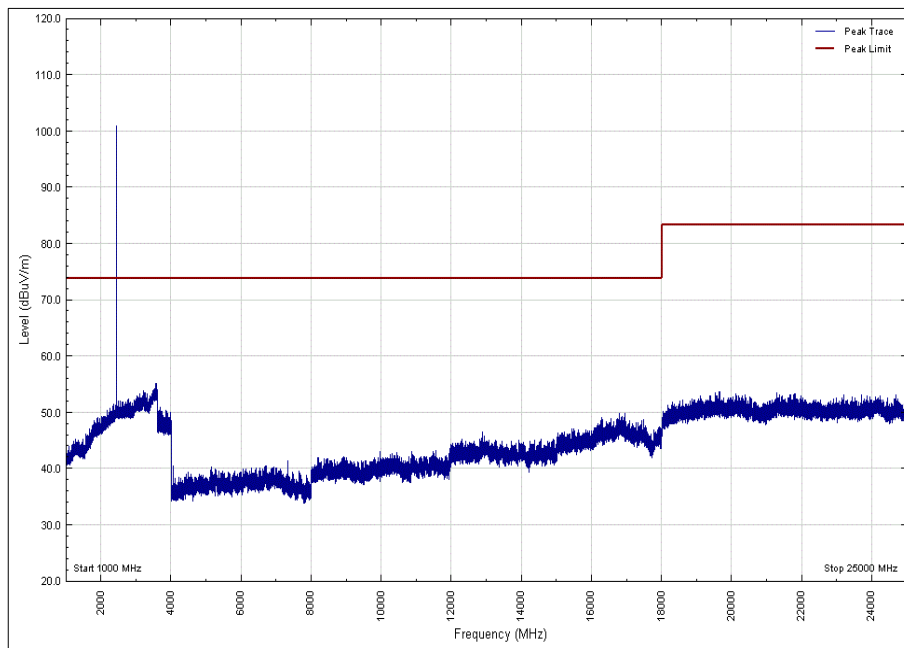

**Figure 46 - 2440 MHz - 1 GHz to 25 GHz - Peak
Polarity: Horizontal, EUT Orientation: Y**

Note - The emission seen at 2440 MHz is the EUT's intentional transmitter frequency and is therefore not subject to this test.

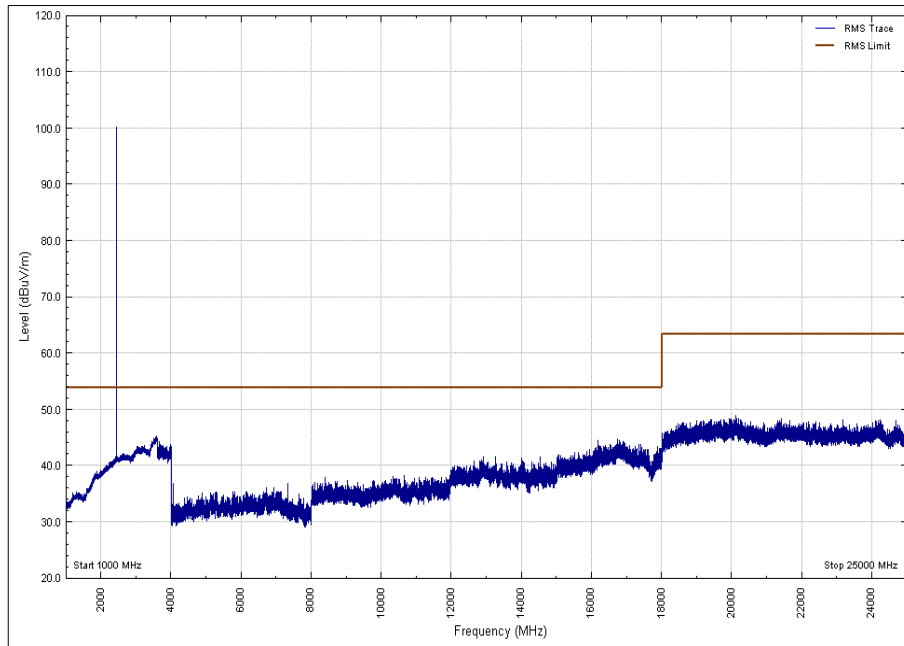

**Figure 47 - 2440 MHz - 1 GHz to 25 GHz - Average
Polarity: Horizontal, EUT Orientation: Y**

Note - The emission seen at 2440 MHz is the EUT's intentional transmitter frequency and is therefore not subject to this test.

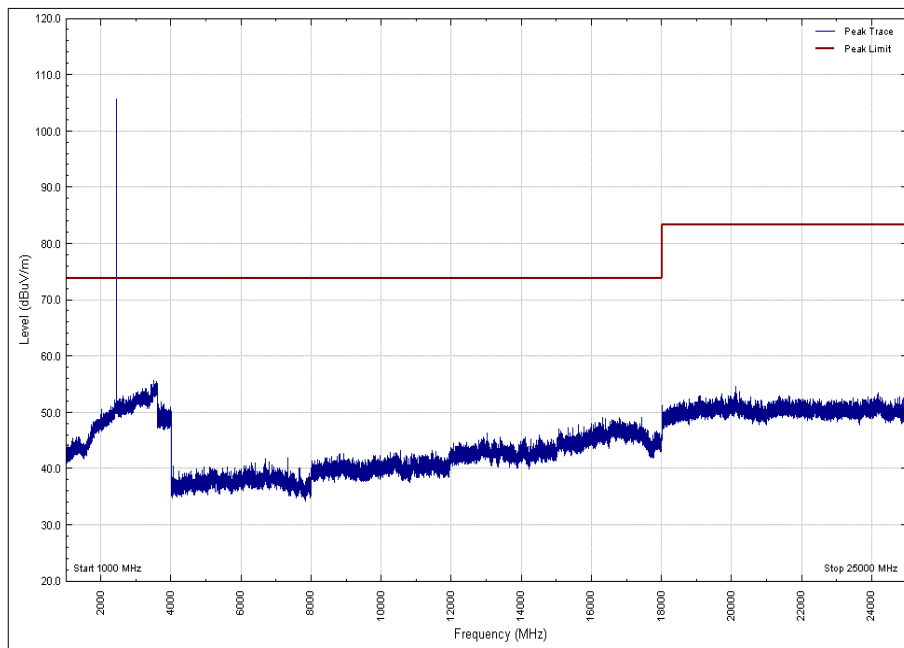

**Figure 48 - 2440 MHz - 1 GHz to 25 GHz - Peak
Polarity: Vertical, EUT Orientation: Z**

Note - The emission seen at 2440 MHz is the EUT's intentional transmitter frequency and is therefore not subject to this test.

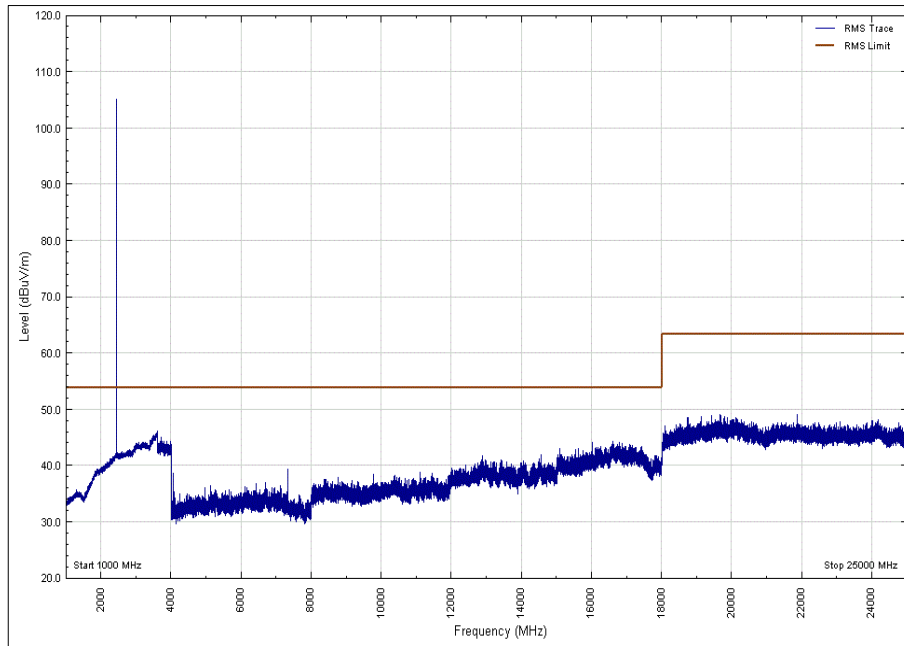

**Figure 49 - 2440 MHz - 1 GHz to 25 GHz - Average
Polarity: Vertical, EUT Orientation: Z**

Note - The emission seen at 2440 MHz is the EUT's intentional transmitter frequency and is therefore not subject to this test.

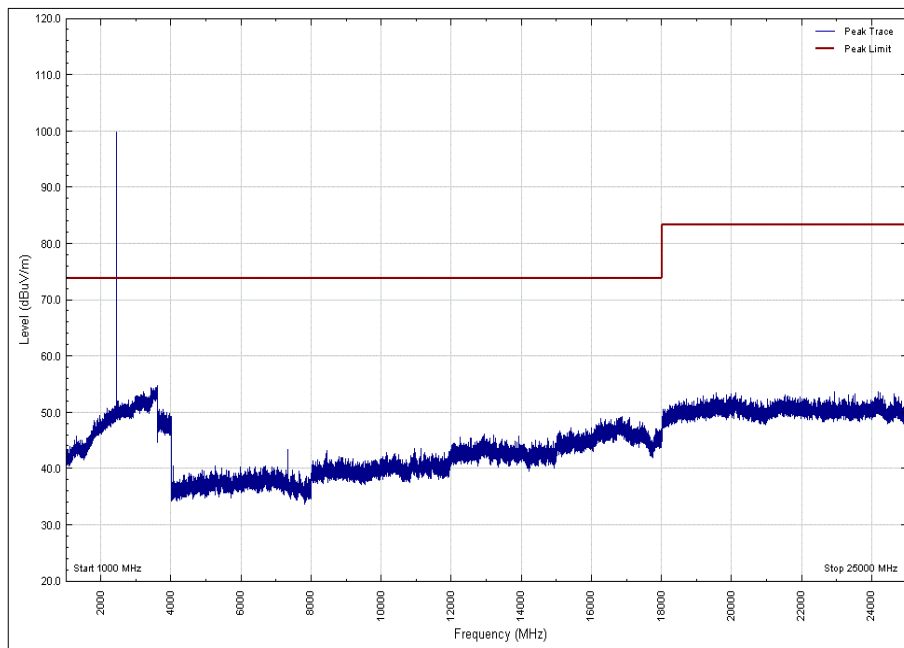

**Figure 50 - 2440 MHz - 1 GHz to 25 GHz - Peak
Polarity: Horizontal, EUT Orientation: Z**

Note - The emission seen at 2440 MHz is the EUT's intentional transmitter frequency and is therefore not subject to this test.

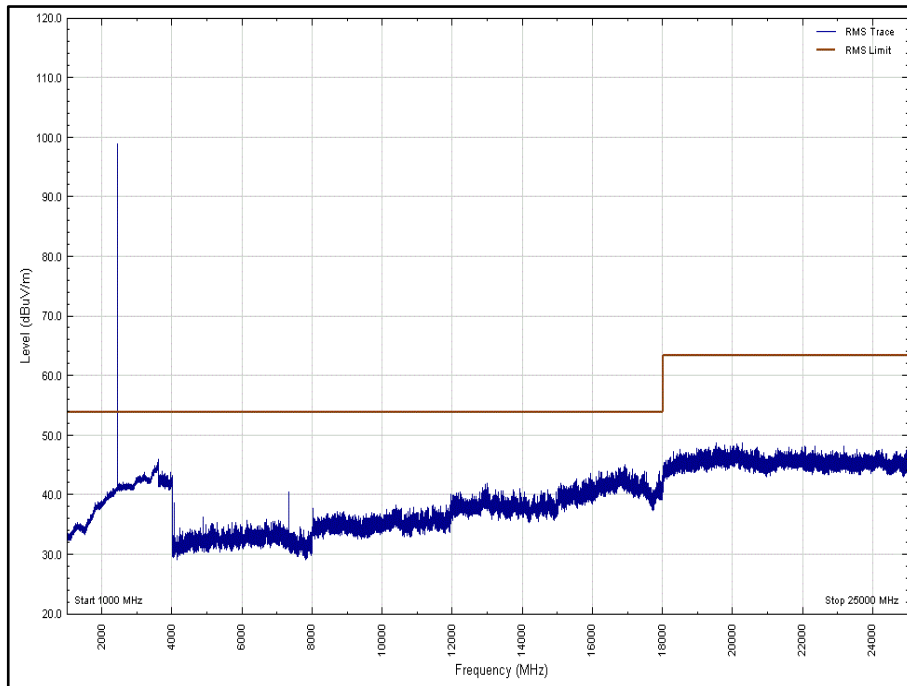

**Figure 51 - 2440 MHz - 1 GHz to 25 GHz - Average
Polarity: Horizontal, EUT Orientation: Z**

Note - The emission seen at 2440 MHz is the EUT's intentional transmitter frequency and is therefore not subject to this test.



Frequency (MHz)	Result (dBµV/m)		Limit (dBµV/m)		Margin (dBµV/m)		Polarisation	EUT Orientation
	Peak	Average	Peak	Average	Peak	Average		
*								

Table 25 - 2480 MHz - 30 MHz to 1 GHz Emissions Results

*No emissions were detected within 10 dB of the limit.

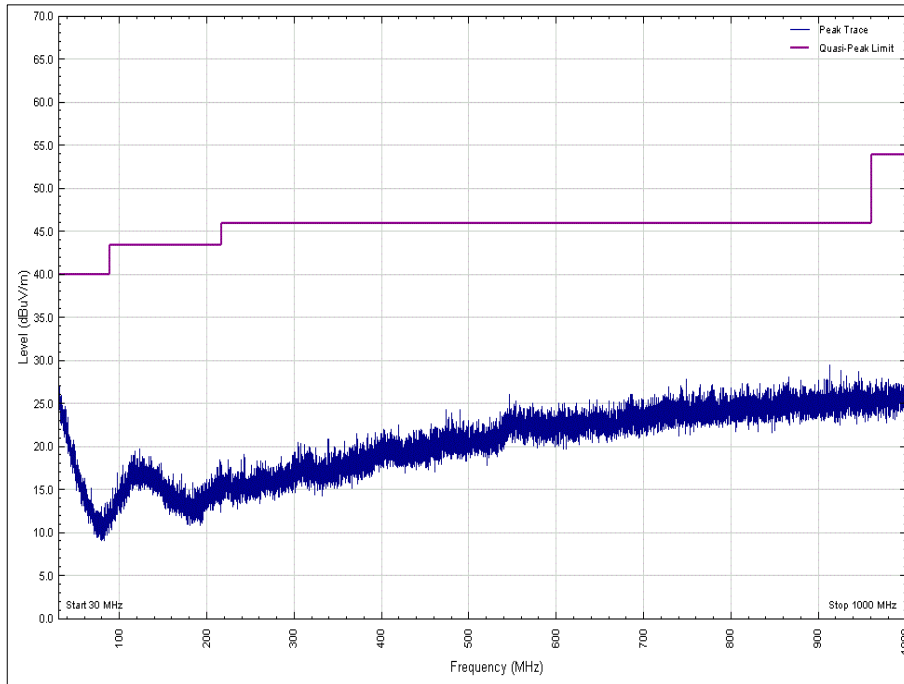

Figure 52 - 2480 MHz - 30 MHz to 1 GHz, Polarity: Vertical, EUT Orientation: X

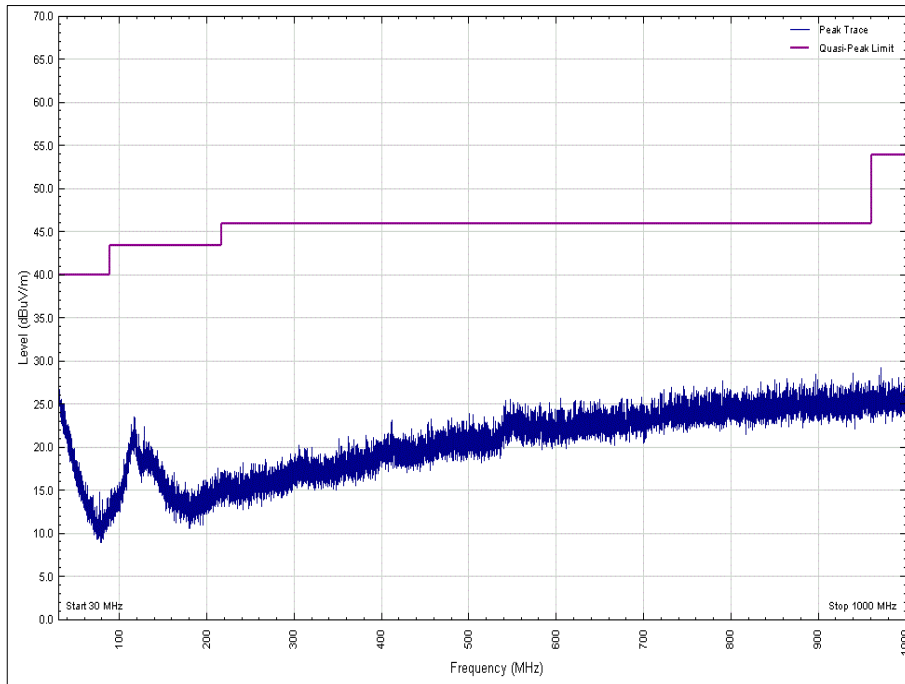

Figure 53 - 2480 MHz - 30 MHz to 1 GHz, Polarity: Horizontal, EUT Orientation: X

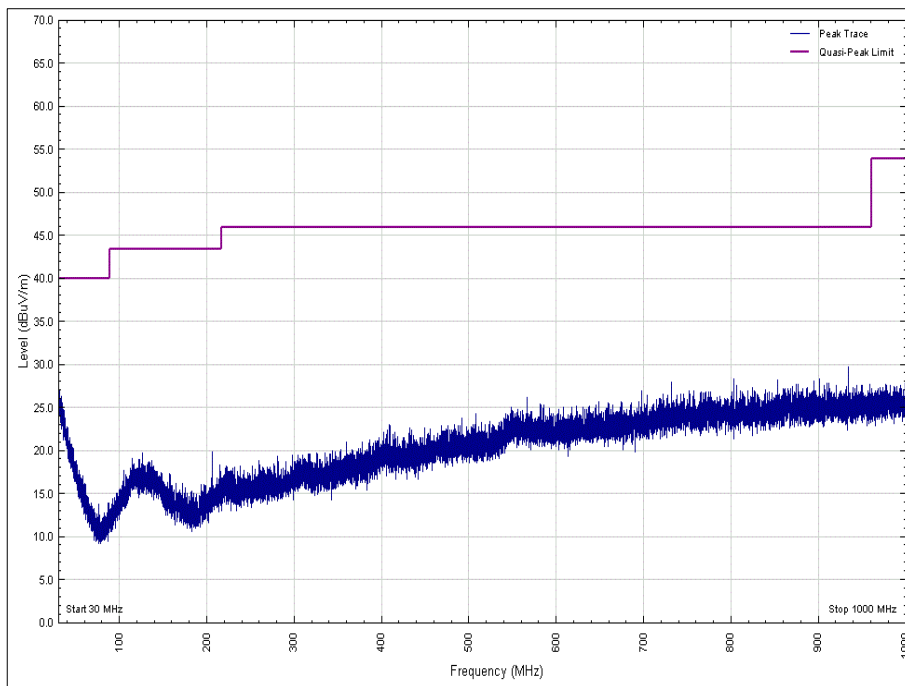

Figure 54 - 2480 MHz - 30 MHz to 1 GHz, Polarity: Vertical, EUT Orientation: Y

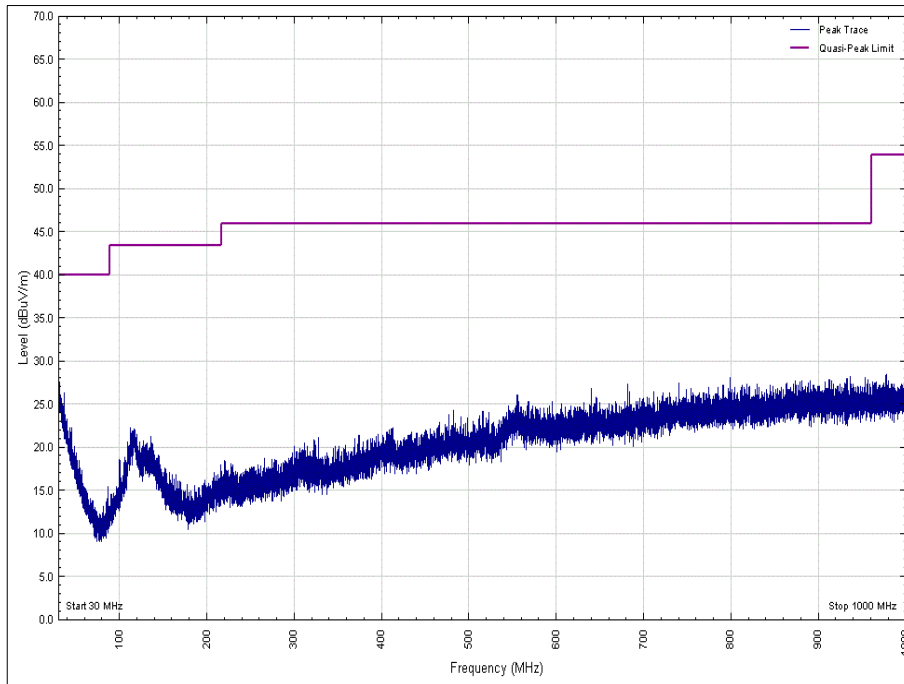

Figure 55 - 2480 MHz - 30 MHz to 1 GHz, Polarity: Horizontal, EUT Orientation: Y

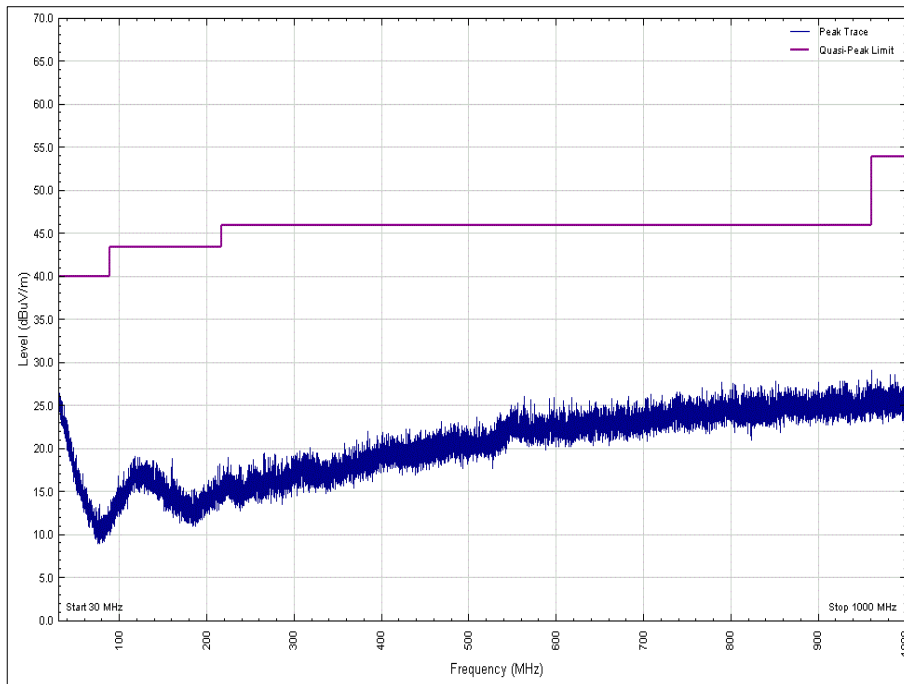

Figure 56 - 2480 MHz - 30 MHz to 1 GHz, Polarity: Vertical, EUT Orientation: Z

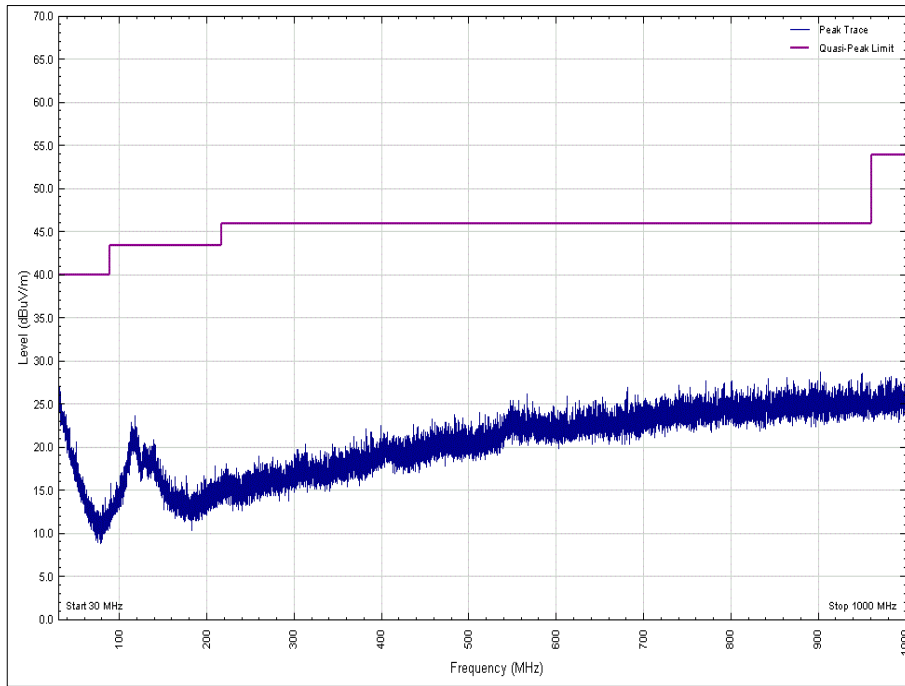

Figure 57 - 2480 MHz - 30 MHz to 1 GHz, Polarity: Horizontal, EUT Orientation: Z



Frequency (GHz)	Result (dB μ V/m)		Limit (dB μ V/m)		Margin (dB μ V/m)	
	Peak	Average	Peak	Average	Peak	Average
*						

Table 26 - 2440 MHz - 1 GHz to 25 GHz Emissions Results

*No emissions were detected within 10 dB of the limit.

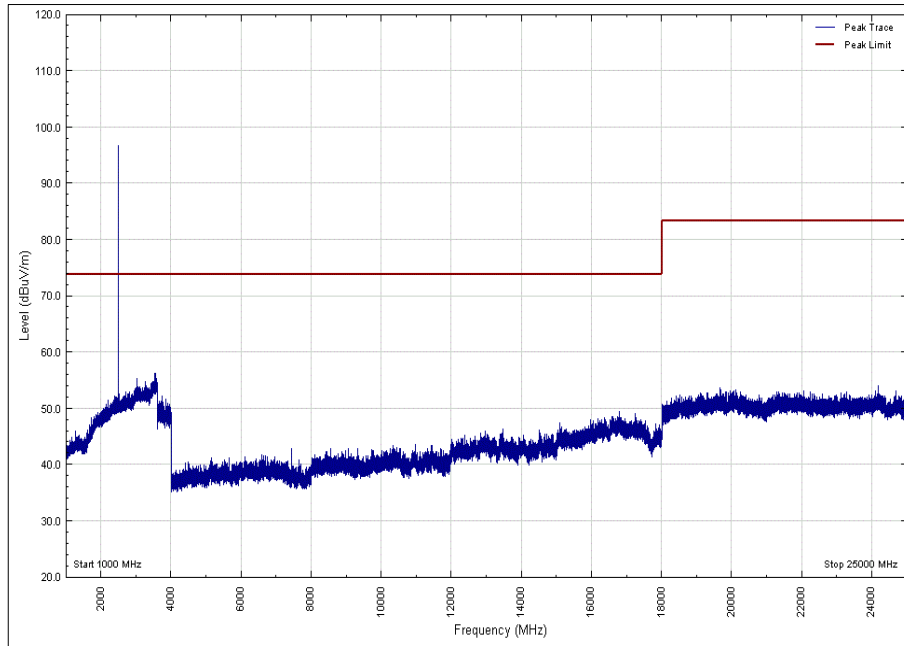

**Figure 58 - 2480 MHz - 1 GHz to 25 GHz - Peak
 Polarity: Vertical, EUT Orientation: X**

Note - The emission seen at 2480 MHz is the EUT's intentional transmitter frequency and is therefore not subject to this test.

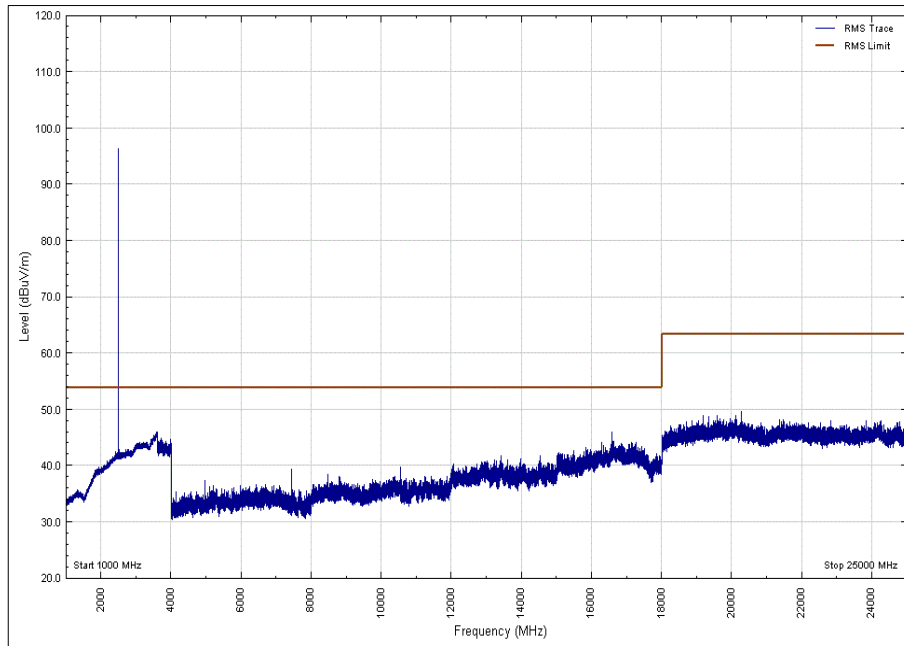

**Figure 59 - 2480 MHz - 1 GHz to 25 GHz - Average
Polarity: Vertical, EUT Orientation: X**

Note - The emission seen at 2480 MHz is the EUT's intentional transmitter frequency and is therefore not subject to this test.

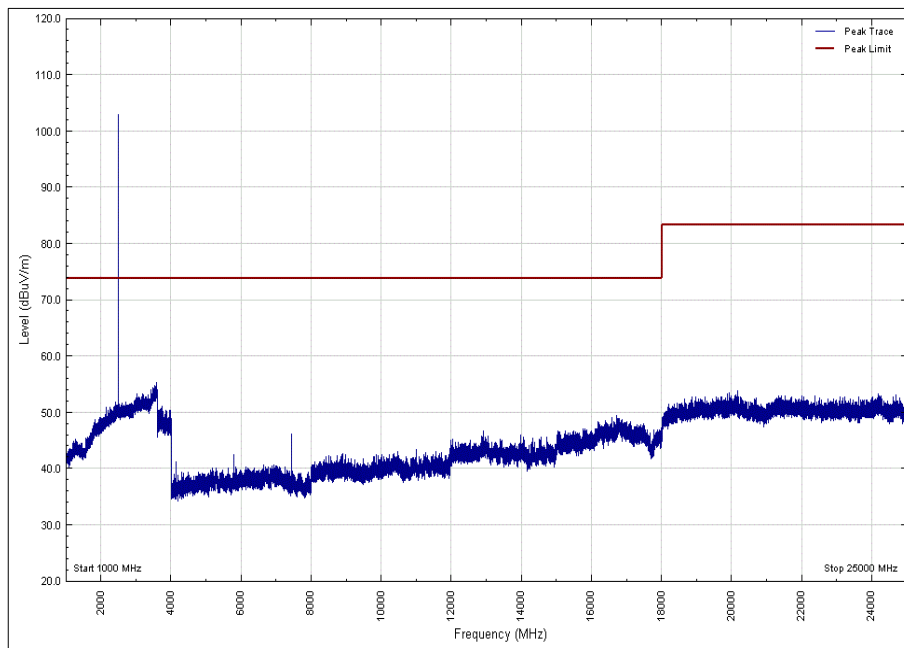

**Figure 60 - 2480 MHz - 1 GHz to 25 GHz - Peak
Polarity: Horizontal, EUT Orientation: X**

Note - The emission seen at 2480 MHz is the EUT's intentional transmitter frequency and is therefore not subject to this test.

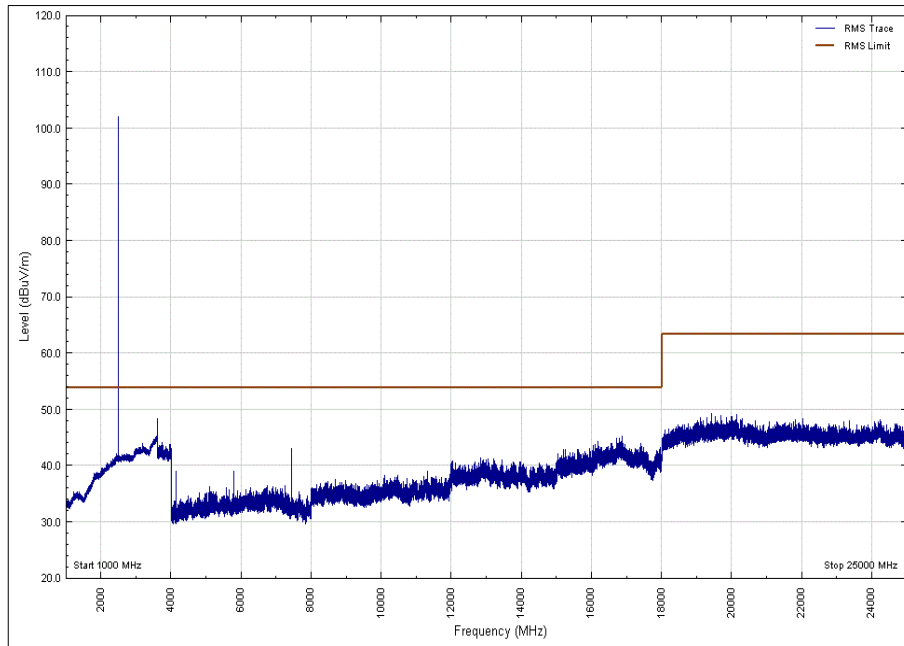

**Figure 61 - 2480 MHz - 1 GHz to 25 GHz - Average
Polarity: Horizontal, EUT Orientation: X**

Note - The emission seen at 2480 MHz is the EUT's intentional transmitter frequency and is therefore not subject to this test.

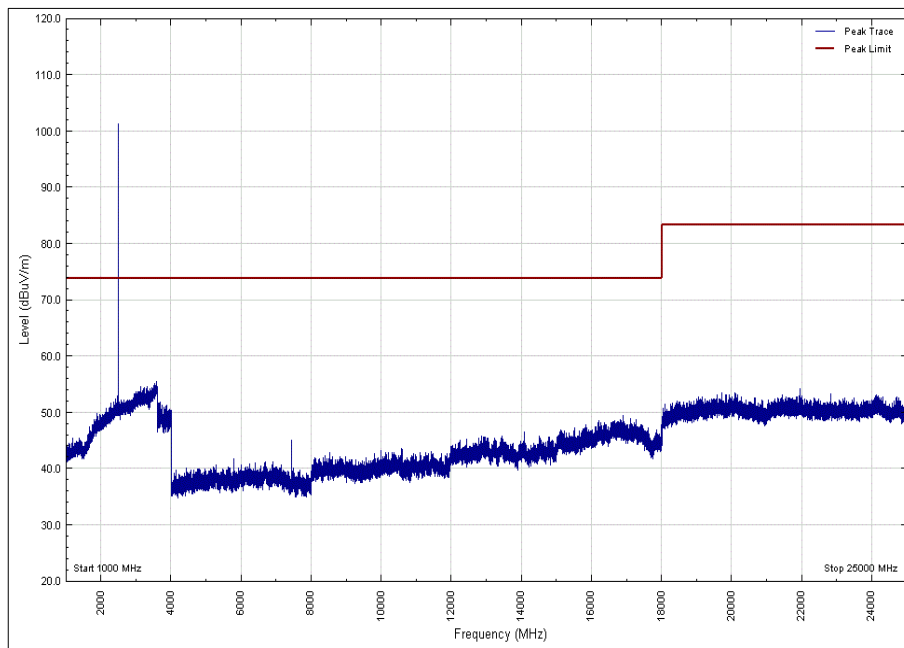

**Figure 62 - 2480 MHz - 1 GHz to 25 GHz - Peak
Polarity: Vertical, EUT Orientation: Y**

Note - The emission seen at 2480 MHz is the EUT's intentional transmitter frequency and is therefore not subject to this test.

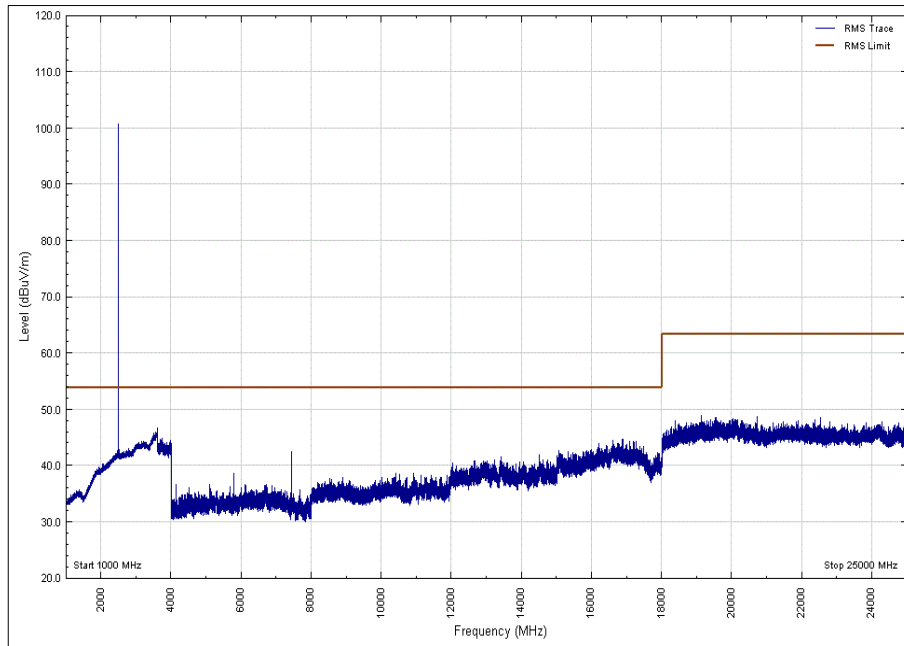

**Figure 63 - 2480 MHz - 1 GHz to 25 GHz - Average
Polarity: Vertical, EUT Orientation: Y**

Note - The emission seen at 2480 MHz is the EUT's intentional transmitter frequency and is therefore not subject to this test.

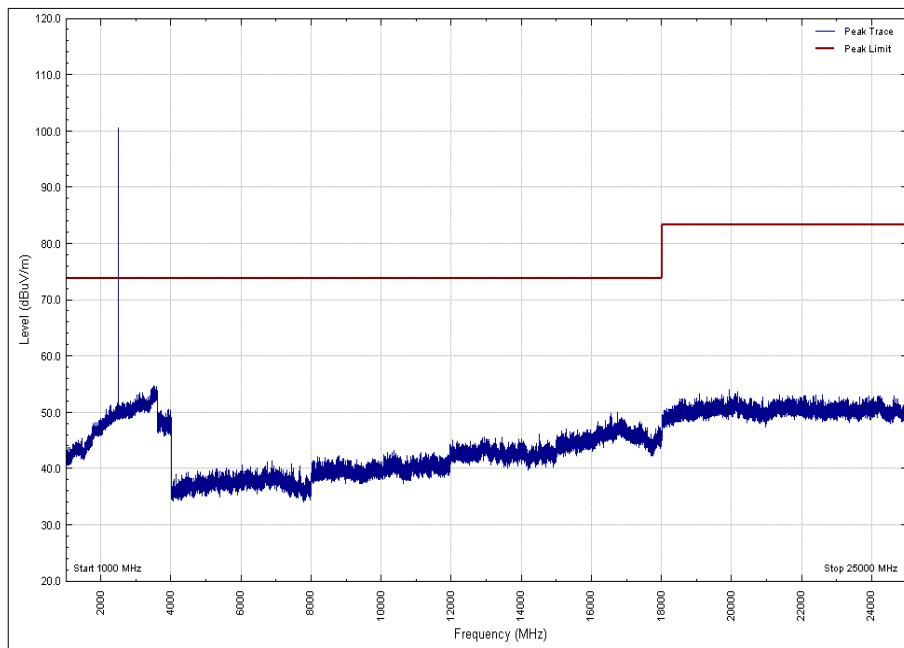

**Figure 64 - 2480 MHz - 1 GHz to 25 GHz - Peak
Polarity: Horizontal, EUT Orientation: Y**

Note - The emission seen at 2480 MHz is the EUT's intentional transmitter frequency and is therefore not subject to this test.

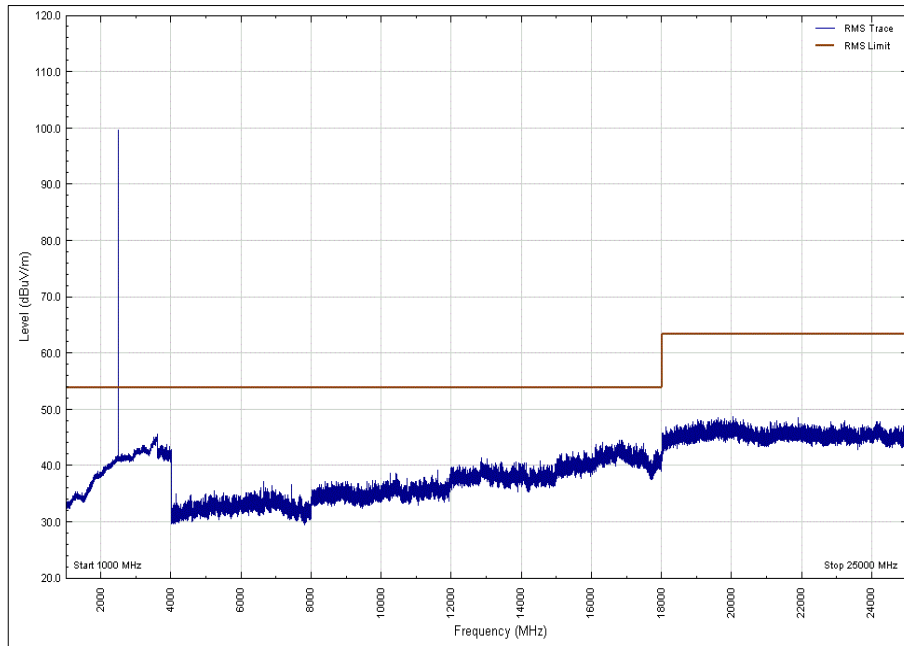

**Figure 65 - 2480 MHz - 1 GHz to 25 GHz - Average
Polarity: Horizontal, EUT Orientation: Y**

Note - The emission seen at 2480 MHz is the EUT's intentional transmitter frequency and is therefore not subject to this test.

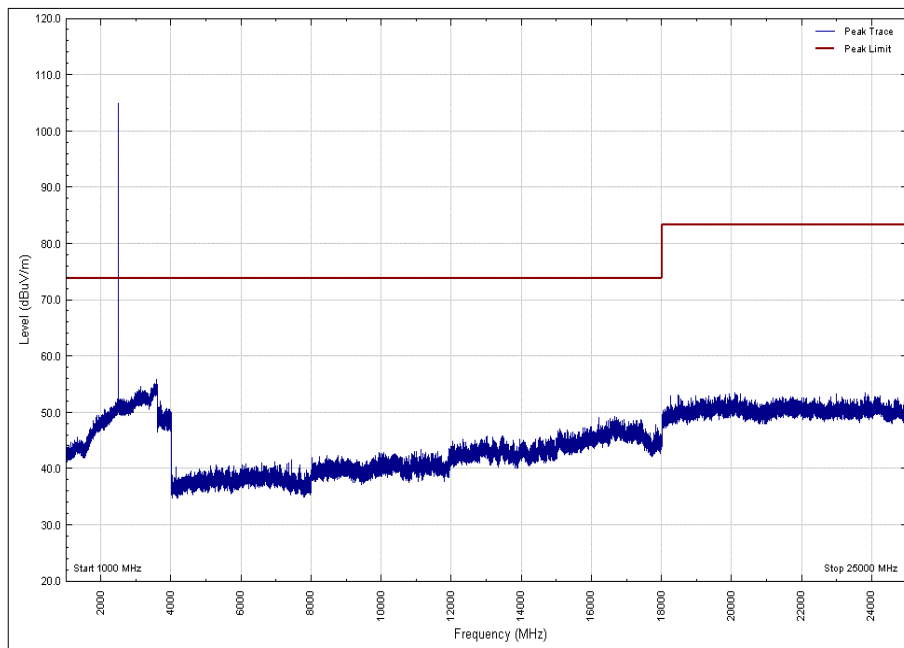

**Figure 66 - 2480 MHz - 1 GHz to 25 GHz - Peak
Polarity: Vertical, EUT Orientation: Z**

Note - The emission seen at 2480 MHz is the EUT's intentional transmitter frequency and is therefore not subject to this test.

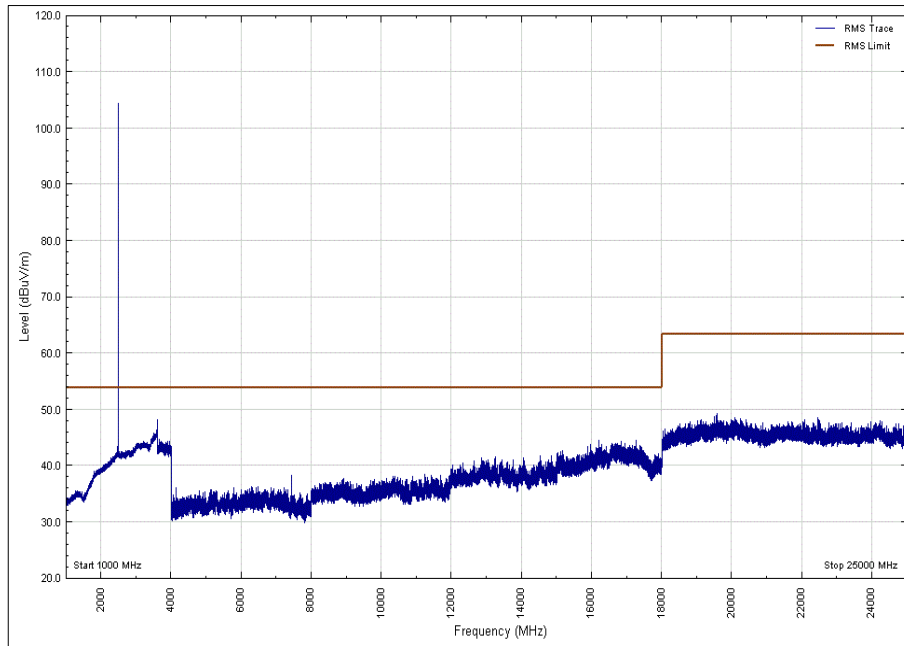

**Figure 67 - 2480 MHz - 1 GHz to 25 GHz - Average
Polarity: Vertical, EUT Orientation: Z**

Note - The emission seen at 2480 MHz is the EUT's intentional transmitter frequency and is therefore not subject to this test.

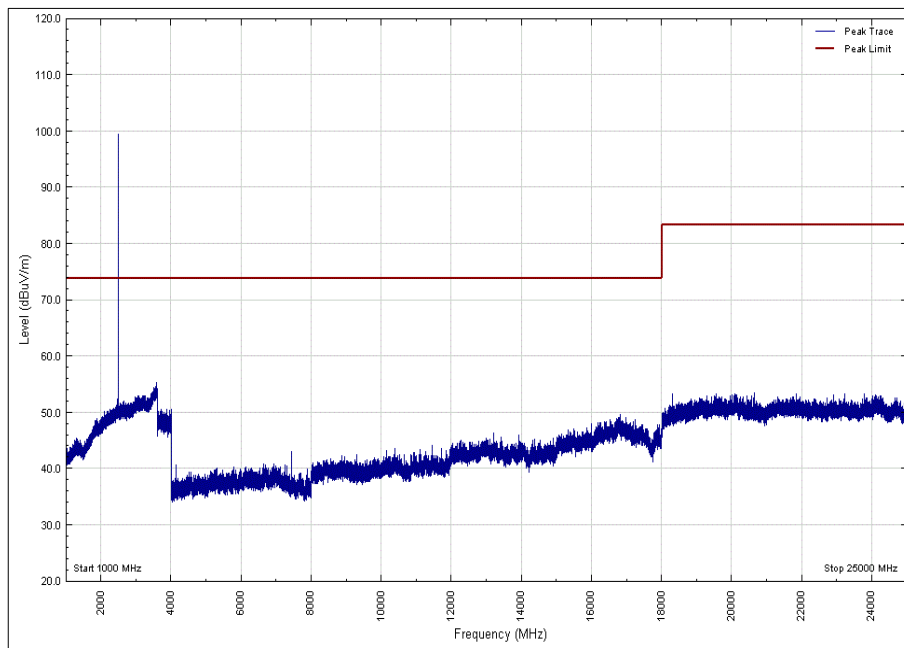

**Figure 68 - 2480 MHz - 1 GHz to 25 GHz - Peak
Polarity: Horizontal, EUT Orientation: Z**

Note - The emission seen at 2480 MHz is the EUT's intentional transmitter frequency and is therefore not subject to this test.

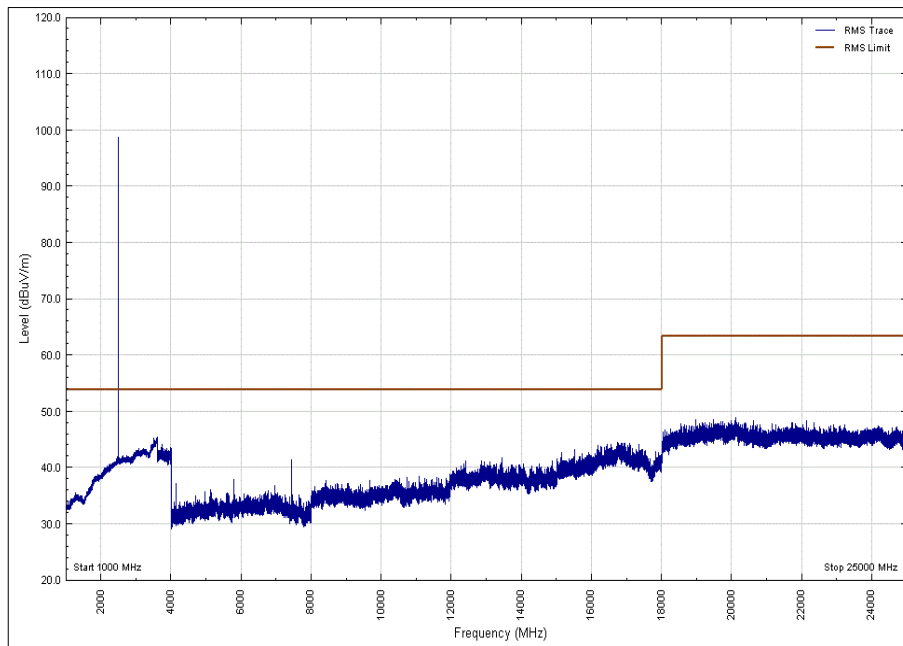

**Figure 69 - 2480 MHz - 1 GHz to 25 GHz - Average
Polarity: Horizontal, EUT Orientation: Z**

Note - The emission seen at 2480 MHz is the EUT's intentional transmitter frequency and is therefore not subject to this test.

FCC 47 CFR Part 15, Limit Clause 15.247 (d)

In any 100 kHz bandwidth outside the frequency band in which the spread spectrum or digitally modulated intentional radiator is operating, the radio frequency power that is produced by the intentional radiator shall be at least 20 dB below that in the 100 kHz bandwidth within the band that contains the highest level of the desired power, based on either an RF conducted or a radiated measurement, provided the transmitter demonstrates compliance with the peak conducted power limits. If the transmitter complies with the conducted power limits based on the use of RMS averaging over a time interval, as permitted under paragraph (b)(3) of this section, the attenuation required under this paragraph shall be 30 dB instead of 20 dB.

Attenuation below the general limits specified in § 15.209(a) is not required. In addition, radiated emissions which fall in the restricted bands, as defined in § 15.205(a), must also comply with the radiated emission limits specified in 15.209(a)

ISED RSS-247, Limit Clause 5.5

In any 100 kHz bandwidth outside the frequency band in which the spread spectrum or digitally modulated device is operating, the RF power that is produced shall be at least 20 dB below that in the 100 kHz bandwidth within the band that contains the highest level of the desired power, based on either an RF conducted or a radiated measurement, provided that the transmitter demonstrates compliance with the peak conducted power limits. If the transmitter complies with the conducted power limits based on the use of root-mean-square averaging over a time interval, as permitted under Section 5.4(4), the attenuation required shall be 30 dB instead of 20 dB. Attenuation below the general field strength limits specified in RSS-Gen is not required.



2.7.7 Test Location and Test Equipment Used

This test was carried out in EMC Chamber 5.

Instrument	Manufacturer	Type No.	TE No.	Calibration Period (months)	Calibration Due
Antenna 18-40GHz (Double Ridge Guide)	Link Microtek Ltd	AM180HA-K-TU2	230	24	02-May-2020
Pre-Amplifier	Phase One	PS04-0086	1533	12	08-Feb-2020
18GHz - 40GHz Pre-Amplifier	Phase One	PSO4-0087	1534	12	05-Feb-2020
Screened Room (5)	Rainford	Rainford	1545	36	23-Jan-2021
Turntable Controller	Inn-Co GmbH	CO 1000	1606	-	TU
Hygrometer	Rotronic	HYGROPALM 1	2338	12	15-Nov-2019
Antenna with permanent attenuator (Bilog)	Chase	CBL6143	2904	24	08-Aug-2019
Comb Generator	Schaffner	RSG1000	3034	-	TU
EMI Test Receiver	Rohde & Schwarz	ESU40	3506	12	17-Dec-2019
Cable 1503 2M 2.92(P)m 2.92(P)m	Rhophase	KPS-1503A-2000-KPS	4293	12	26-Oct-2019
1GHz to 8GHz Low Noise Amplifier	Wright Technologies	APS04-0085	4365	12	25-Oct-2019
Cable (Rx, Km-Km 2m)	Scott Cables	KPS-1501-2000-KPS	4526	6	26-Apr-2019
Cable (Rx, SMAM-SMAM 0.5m)	Scott Cables	SLSLL18-SMSM-00.50M	4528	6	26-Apr-2019
High Pass Filter (4GHz)	K&L Microwave	11SH10-4000/X18000-0/0	4599	12	04-Sep-2019
1 - 18GHz DRG Antenna	ETS-Lindgren	3117	4738	12	05-Mar-2020
Mast Controller	Maturo GmbH	NCD	4810	-	TU
Tilt Antenna Mast	Maturo GmbH	TAM 4.0-P	4811	-	TU
4dB Attenuator	Pasternack	PE7047-4	4935	24	28-Nov-2019
8m N-Type RF Cable	Teledyne	PR90-088-8MTR	5093	12	04-Oct-2019
EmX Software	TUV SUD	EmX V.1.4.6	5125	-	Software
1.5m 40GHz RF Cable	Scott Cables	KPS-1501-2000-KPS	5126	6	26-Apr-2019

Table 27

TU – Traceability Unscheduled

3 Photographs

3.1 Test Setup Photographs



Figure 70 - Orientation X



Figure 71 - Orientation Y



Figure 72 - Orientation Z



Figure 73 - 30 MHz to 1 GHz



Figure 74 - 1 GHz to 18 GHz



Figure 75 - 18 GHz to 25 GHz



4 Measurement Uncertainty

For a 95% confidence level, the measurement uncertainties for defined systems are:

Test Name	Measurement Uncertainty
Maximum Conducted Output Power	± 3.2 dB
Power Spectral Density	± 3.2 dB
Emission Bandwidth	± 33.079 kHz
Authorised Band Edges	30 MHz to 1 GHz: ± 5.2 dB 1 GHz to 40 GHz: ± 6.3 dB
Restricted Band Edges	30 MHz to 1 GHz: ± 5.2 dB 1 GHz to 40 GHz: ± 6.3 dB
Spurious Radiated Emissions	30 MHz to 1 GHz: ± 5.2 dB 1 GHz to 40 GHz: ± 6.3 dB

Table 28