

FCC and ISEDC Test Report

Sepura Ltd
Tetra Handset, Model: SC2028

In accordance with FCC 47 CFR Part 15C,
ISEDC RSS-247 and ISEDC RSS-GEN

Prepared for: Sepura Ltd
9000 Cambridge Research Park
Beach Drive, Waterbeach
Cambridge, CB25 9TL
United Kingdom



Add value.
Inspire trust.

FCC ID: XX6SC2028

IC: 8739A-SC2028

COMMERCIAL-IN-CONFIDENCE

Document 75947270-03 Issue 01

SIGNATURE

NAME	JOB TITLE	RESPONSIBLE FOR	ISSUE DATE
Jon Kenny	Senior Engineer	Authorised Signatory	10 February 2020

Signatures in this approval box have checked this document in line with the requirements of TÜV SÜD document control rules.

ENGINEERING STATEMENT

The measurements shown in this report were made in accordance with the procedures described on test pages. All reported testing was carried out on a sample equipment to demonstrate limited compliance with FCC 47 CFR Part 15C, ISEDC RSS-247 and ISEDC RSS-GEN. The sample tested was found to comply with the requirements defined in the applied rules.

RESPONSIBLE FOR	NAME	DATE	SIGNATURE
Testing	Connor Lee	10 February 2020	

FCC Accreditation

90987 Octagon House, Fareham Test Laboratory

ISEDC Accreditation

12669A Octagon House, Fareham Test Laboratory

EXECUTIVE SUMMARY

A sample of this product was tested and found to be compliant with FCC 47 CFR Part 15C, ISEDC RSS-247 and ISEDC RSS-GEN: 2018, Issue 2 (2017-02) and Issue 5 A1 (2019-03) for the tests detailed in section 1.3.



DISCLAIMER AND COPYRIGHT

This non-binding report has been prepared by TÜV SÜD with all reasonable skill and care. The document is confidential to the potential Client and TÜV SÜD. No part of this document may be reproduced without the prior written approval of TÜV SÜD. © 2020 TÜV SÜD. This report relates only to the actual item/items tested.

ACCREDITATION

Our UKAS Accreditation does not cover opinions and interpretations and any expressed are outside the scope of our UKAS Accreditation. Results of tests not covered by our UKAS Accreditation Schedule are marked NUA (Not UKAS Accredited).

TÜV SÜD
is a trading name of TÜV SÜD Ltd
Registered in Scotland at East Kilbride,
Glasgow G75 0QF, United Kingdom
Registered number: SC215164

TÜV SÜD Ltd is a
TÜV SÜD Group Company

Phone: +44 (0) 1489 558100
Fax: +44 (0) 1489 558101
www.tuv-sud.co.uk

TÜV SÜD
Octagon House
Concorde Way
Fareham
Hampshire PO15 5RL
United Kingdom



Contents

1	Report Summary	2
1.1	Report Modification Record.....	2
1.2	Introduction.....	2
1.3	Brief Summary of Results	3
1.4	Application Form	4
1.5	Product Information	6
1.6	Deviations from the Standard.....	6
1.7	EUT Modification Record	6
1.8	Test Location	6
2	Test Details	7
2.1	Authorised Band Edges	7
2.2	Restricted Band Edges.....	12
2.3	Spurious Radiated Emissions	21
3	Photographs	56
3.1	Test Setup Photographs	56
4	Measurement Uncertainty	58



1 Report Summary

1.1 Report Modification Record

Alterations and additions to this report will be issued to the holders of each copy in the form of a complete document.

Issue	Description of Change	Date of Issue
1	First Issue	10 February 2020

Table 1

1.2 Introduction

Applicant	Sepura Ltd
Manufacturer	Sepura Ltd
Model Number(s)	SC2028
Serial Number(s)	1PR001925GK63ZJ
Hardware Version(s)	Pre-Production
Software Version(s)	2001 730 07367
Number of Samples Tested	1
Test Specification/Issue/Date	FCC 47 CFR Part 15C: 2018 ISED RSS-247: Issue 2 (2017-02) ISED RSS-GEN: Issue 5 (2018-04) + A1 (2019-03)
Order Number	PLC-PO014257-2
Date	11-October-2019
Date of Receipt of EUT	22-October-2019 and 06-December-2019
Start of Test	06-December-2019
Finish of Test	20-December-2019
Name of Engineer(s)	Connor Lee
Related Document(s)	ANSI C63.10 (2013)



1.3 Brief Summary of Results

A brief summary of the tests carried out in accordance with FCC 47 CFR Part 15C, ISEDC RSS-247 and ISEDC RSS-GEN is shown below.

Section	Specification Clause			Test Description	Result	Comments/Base Standard
	Part 15C	RSS-247	RSS-GEN			
Configuration and Mode: 2.4 GHz Bluetooth - BDR/EDR						
-	15.247 (a)(1)	-	5.1	Frequency Hopping Systems - Average Time of Occupancy	N/T	Refer to Document 75944487-04*
-	15.247 (a)(1)	-	5.1	Frequency Hopping Systems - Channel Separation	N/T	Refer to Document 75944487-04*
-	15.247 (a)(1)	-	5.1	Frequency Hopping Systems - Number of Hopping Channels	N/T	Refer to Document 75944487-04*
-	15.247 (a)(1)	-	5.1	Frequency Hopping Systems - 20 dB Bandwidth	N/T	Refer to Document 75944487-04*
-	15.247 (b)	5.4	6.12	Maximum Conducted Output Power	N/T	Refer to Document 75944487-04*
-	15.207	-	8.8	AC Power Line Conducted Emissions	N/T	Only needs to be performed in the mode with the highest output power which was Bluetooth Low Energy. This has been tested and reported in document 75947270-04.
2.1	15.247 (d)	5.5	-	Authorised Band Edges	Pass	ANSI C63.10 (2013)
2.2	15.205	-	8.10	Restricted Band Edges	Pass	ANSI C63.10 (2013)
2.3	15.247 (d) and 15.205	5.5	6.13	Spurious Radiated Emissions	Pass	ANSI C63.10 (2013)

Table 2

N/T – Not Tested

* EUT contains the same pre-approved module



1.4 Application Form

Equipment Description

Technical Description: <i>(Please provide a brief description of the intended use of the equipment)</i>	The SC2028 hand-portable terminal is a TETRA enabled radio with Bluetooth and Wi-Fi capability
Manufacturer:	Sepura Limited
Model:	SC2028
Part Number:	N/A
Hardware Version:	Pre-Production
Software Version:	2001 730 07367
FCC ID (if applicable)	XX6SC2028
IC ID (if applicable)	8739A-SC2028

Intentional Radiators

Technology	TETRA	TETRA	BT Classic/EDR	BLE	WLAN
Frequency Band (MHz)	806-824	851-869	2402-2480	2402-2480	2412-2462
Conducted Declared Output Power (dBm)	34	34	7.382	7.382	16.5
Antenna Gain (dBi)	> 0	> 0	2.5	2.5	2.5
Supported Bandwidth(s) (MHz)	25 kHz	25 kHz	1	2	16.5 22
Modulation Scheme(s)	$\pi/4$ DQPSK	$\pi/4$ DQPSK	8-DPSK, $\pi/4$ DQPSK, GFSK	8PSK, DQPSK, GFSK	BPSK, 16-QAM, 64-QAM
ITU Emission Designator	22K0DXW	22K0DXW	1M00F1D	2M00F1D	16M5G1D 22M0G1D
Bottom Frequency (MHz)	806	851	2402	2402	2412
Middle Frequency (MHz)	815	860	2441	2441	2437
Top Frequency (MHz)	824	869	2480	2480	2462

Un-intentional Radiators

Highest frequency generated or used in the device or on which the device operates or tunes	2480 MHz
Lowest frequency generated or used in the device or on which the device operates or tunes	32.768 kHz
Class A Digital Device (Use in commercial, industrial or business environment) <input checked="" type="checkbox"/>	
Class B Digital Device (Use in residential environment only) <input type="checkbox"/>	



DC Power Source

Nominal voltage:	7.4	V
Extreme upper voltage:	7.4	V
Extreme lower voltage:	6.2	V
Max current:	2	A

Battery Power Source

Voltage:	7.4	V
End-point voltage:	6.2	V (Point at which the battery will terminate)
Alkaline <input type="checkbox"/> Leclanche <input checked="" type="checkbox"/> Lithium <input type="checkbox"/> Nickel Cadmium <input type="checkbox"/> Lead Acid* <input type="checkbox"/> *(Vehicle regulated)		
Other <input type="checkbox"/>	Please detail:	

Charging

Can the EUT transmit whilst being charged	Yes <input checked="" type="checkbox"/> No <input type="checkbox"/>
---	---

Temperature

Minimum temperature:	-30	°C
Maximum temperature:	+65	°C

Antenna Characteristics

Antenna connector <input checked="" type="checkbox"/> TETRA	State impedance	50	Ohm
Temporary antenna connector <input type="checkbox"/>	State impedance		Ohm
Integral antenna <input checked="" type="checkbox"/>	Type:	PCB	State impedance 50 Ohm
External antenna <input type="checkbox"/>	Type:		State impedance dBI

Ancillaries (if applicable)

Manufacturer:		Part Number:	
Model:		Country of Origin:	

The SC2028 may be used with standard SC20 accessories, batteries, chargers, belt clips, holsters, remote speaker and microphones, earpieces etc

I hereby declare that the information supplied is correct and complete.

Name: Chris Beecham
 Position held: Conformance Engineer
 Date: 21 October 2019



1.5 Product Information

1.5.1 Technical Description

The SC2028 hand-portable terminal is a TETRA enabled radio with Bluetooth and Wi-Fi capability.

1.6 Deviations from the Standard

No deviations from the applicable test standard were made during testing.

1.7 EUT Modification Record

The table below details modifications made to the EUT during the test programme.

The modifications incorporated during each test are recorded on the appropriate test pages.

Modification State	Description of Modification still fitted to EUT	Modification Fitted By	Date Modification Fitted
Model: SC2028, Serial Number: 1PR001925GK63ZJ			
0	As supplied by the customer	Not Applicable	Not Applicable

Table 3

1.8 Test Location

TÜV SÜD conducted the following tests at our Fareham Test Laboratory.

Test Name	Name of Engineer(s)	Accreditation
Configuration and Mode: 2.4 GHz Bluetooth - BDR/EDR		
Authorised Band Edges	Connor Lee	UKAS
Restricted Band Edges	Connor Lee	UKAS
Spurious Radiated Emissions	Connor Lee	UKAS

Table 4

Office Address:

Octagon House
Concorde Way
Segensworth North
Fareham
Hampshire
PO15 5RL
United Kingdom



2 Test Details

2.1 Authorised Band Edges

2.1.1 Specification Reference

FCC 47 CFR Part 15C, Clause 15.247 (d)
ISED RSS-247, Clause 5.5

2.1.2 Equipment Under Test and Modification State

SC2028, S/N: 1PR001925GK63ZJ - Modification State 0

2.1.3 Date of Test

06-December-2019

2.1.4 Test Method

The test was performed in accordance with ANSI C63.10, clause 6.10.4.

2.1.5 Environmental Conditions

Ambient Temperature 17.7 °C
Relative Humidity 46.0 %

2.1.6 Test Results

2.4 GHz Bluetooth - BDR/EDR

Mode	Modulation	Packet Type	Channel Frequency (MHz)	Band Edge Frequency (MHz)	Level (dBc)
Static	GFSK	DH5	2402.0	2400.0	-52.19
Hopping	GFSK	DH5	-	2400.0	-50.51
Static	$\pi/4$ DQPSK	2DH5	2402.0	2400.0	-46.67
Hopping	$\pi/4$ DQPSK	2DH5	-	2400.0	-48.83
Static	8-DPSK	3DH5	2402.0	2400.0	-45.26
Hopping	8-DPSK	3DH5	-	2400.0	-47.62

Table 5 - Authorised Band Edge Results

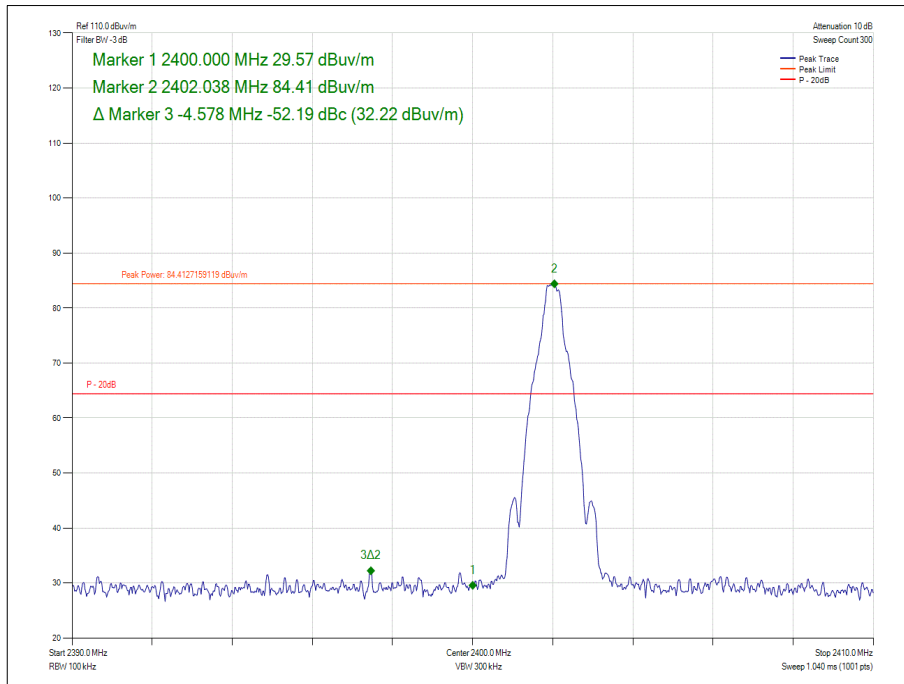

Figure 1 - Static - GFSK/DH5 – 2402.0 MHz - Measured Frequency 2400.0 MHz

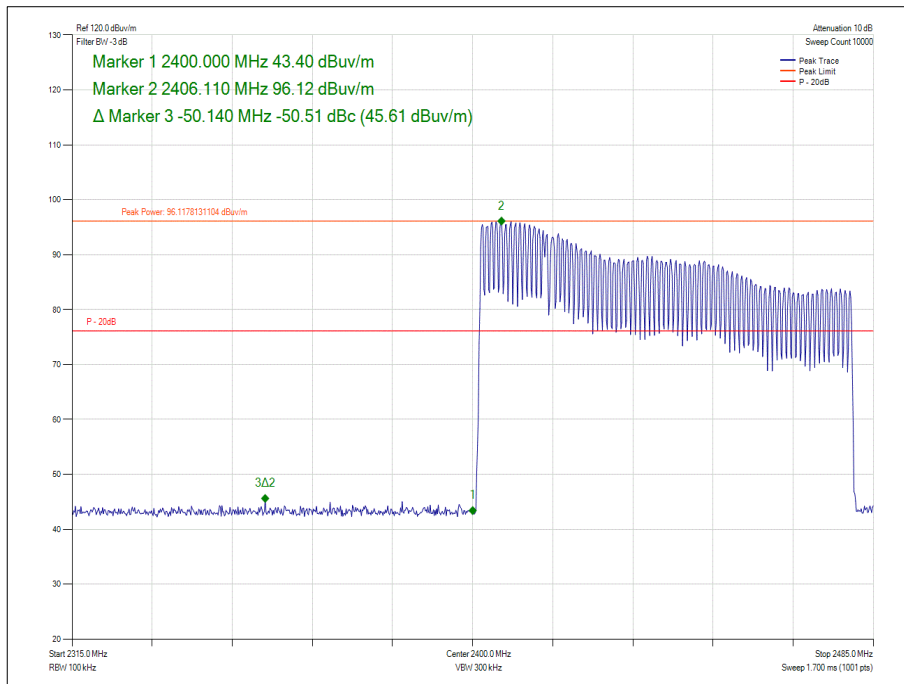

Figure 2 - Hopping - GFSK/DH5 - Measured Frequency 2400.0 MHz

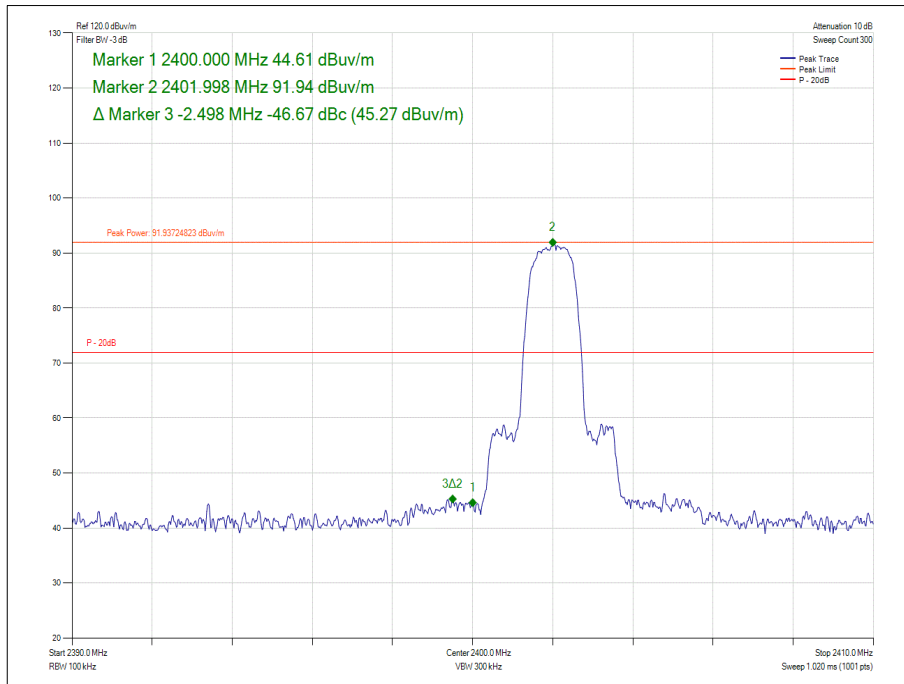

Figure 3 - Static - $\pi/4$ DQPSK/2DH5 – 2402.0 MHz - Measured Frequency 2400.0 MHz

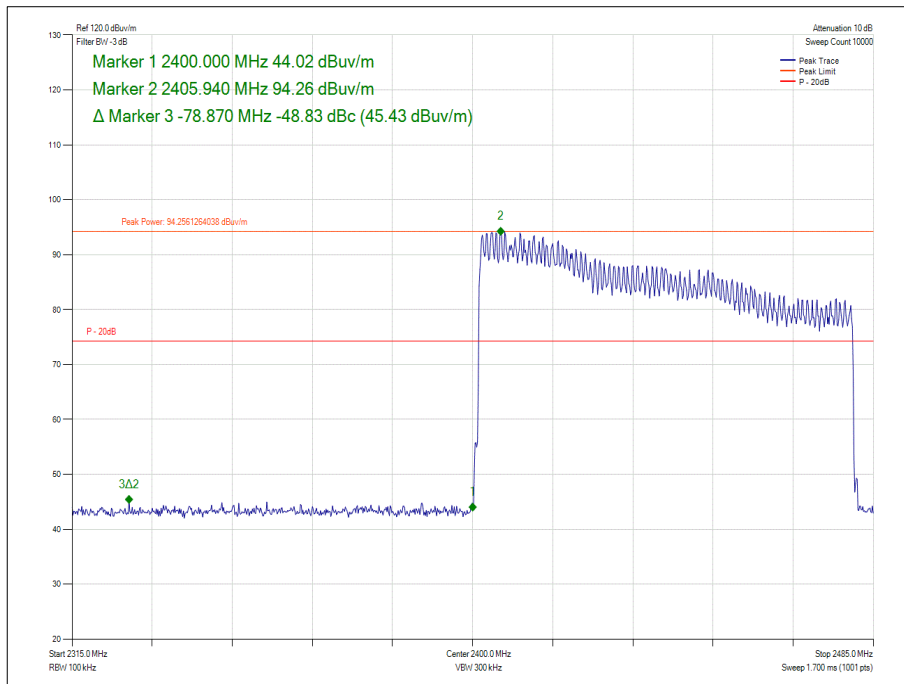

Figure 4 - Hopping - $\pi/4$ DQPSK/2DH5 - Measured Frequency 2400.0 MHz

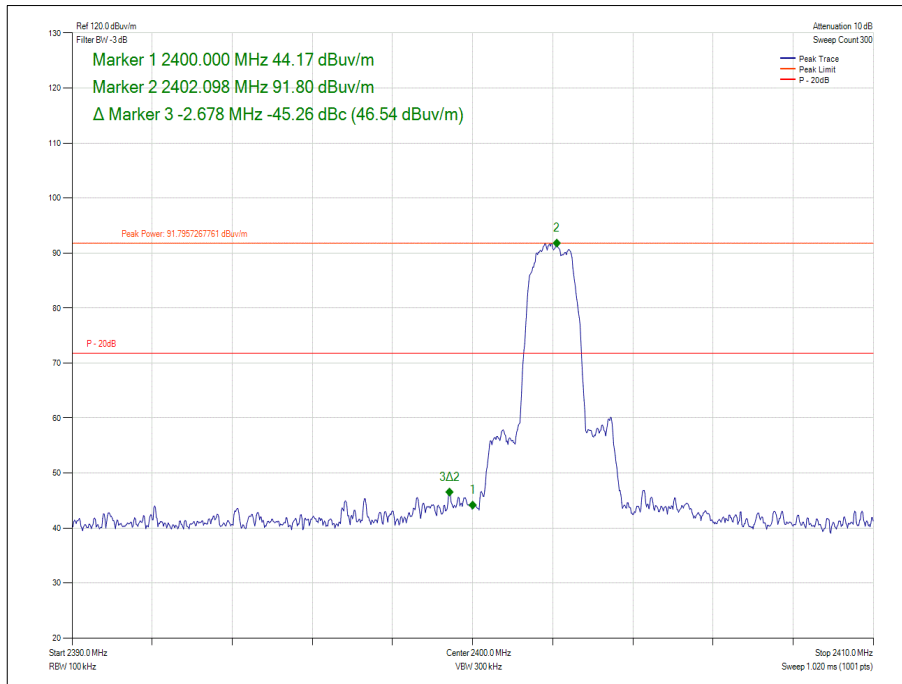

Figure 5 - Static - 8-DPSK/3DH5 – 2402.0 MHz - Measured Frequency 2400.0 MHz

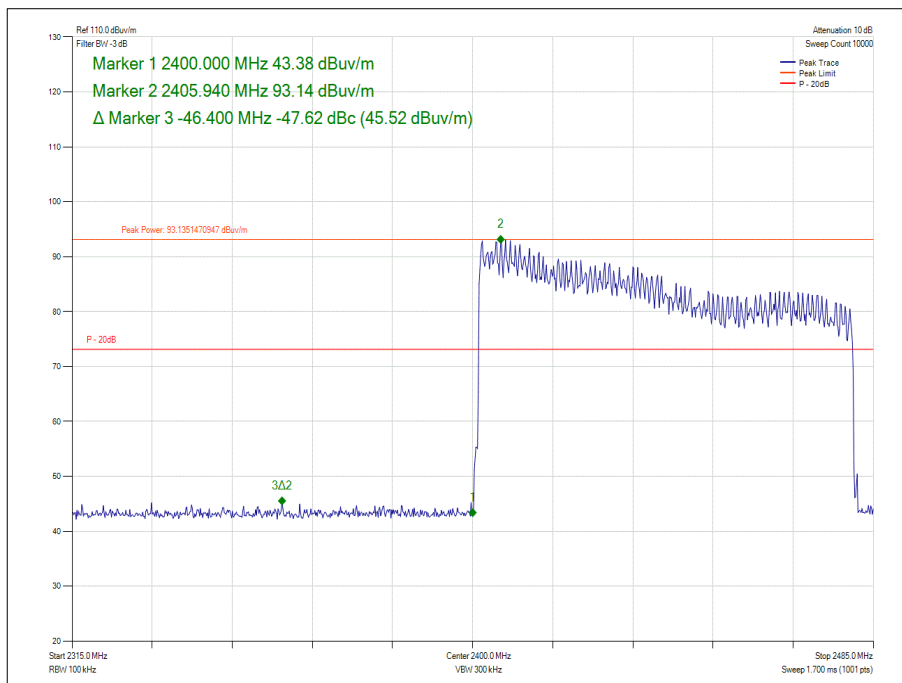

Figure 6 - Hopping - 8-DPSK/3DH5 - Measured Frequency 2400.0 MHz



FCC 47 CFR Part 15, Limit Clause 15.247 (d)

20 dB below the fundamental measured in a 100 kHz bandwidth using a peak detector. If the transmitter complies with the conducted power limits, based on the use of RMS averaging over a time interval, the attenuation required shall be 30 dB below the fundamental instead of 20 dB.

ISED RSS-247, Limit Clause 5.5

In any 100 kHz bandwidth outside the frequency band in which the spread spectrum or digitally modulated device is operating, the RF power that is produced shall be at least 20 dB below that in the 100 kHz bandwidth within the band that contains the highest level of the desired power, based on either an RF conducted or a radiated measurement, provided that the transmitter demonstrates compliance with the peak conducted power limits. If the transmitter complies with the conducted power limits based on the use of root-mean-square averaging over a time interval, as permitted under Section 5.4(4), the attenuation required shall be 30 dB instead of 20 dB. Attenuation below the general field strength limits specified in RSS-Gen is not required.

2.1.7 Test Location and Test Equipment Used

This test was carried out in EMC Chamber 5.

Instrument	Manufacturer	Type No	TE No	Calibration Period (months)	Calibration Due
Screened Room (5)	Rainford	Rainford	1545	36	23-Jan-2021
Turntable Controller	Inn-Co GmbH	CO 1000	1606	-	TU
Hygrometer	Rotronic	A1	2677	12	20-Feb-2020
'2.92mm' - '2.92mm' RF Cable (2m)	Rhophase	KPS-1503-2000-KPS	3695	12	11-Jun-2020
Mast Controller	Maturo GmbH	NCD	4810	-	TU
Tilt Antenna Mast	Maturo GmbH	TAM 4.0-P	4811	-	TU
Double Ridge Broadband Horn Antenna	Schwarzbeck	BBHA 9120 B	4848	12	11-Mar-2020
EmX Emissions Software	TUV SUD	EmX V.V1.5.3	5125	-	Software
8 Meter Cable	Teledyne	PR90-088-8MTR	5212	12	30-Aug-2020
EMI Test Receiver	Rohde & Schwarz	ESW44	5382	12	8-Oct-2020

Table 6

TU – Traceability Unscheduled



2.2 Restricted Band Edges

2.2.1 Specification Reference

FCC 47 CFR Part 15C, Clause 15.205
ISED RSS-GEN, Clause 8.10

2.2.2 Equipment Under Test and Modification State

SC2028, S/N: 1PR001925GK63ZJ - Modification State 0

2.2.3 Date of Test

20-December-2019

2.2.4 Test Method

This test was performed in accordance with ANSI C63.10, clause 6.10.5 in a semi-anechoic chamber at a test distance of 3 m.

Plots for average measurements were taken in accordance with ANSI C63.10, clause 4.1.4.2.5.

The following conversion can be applied to convert from dB μ V/m to μ V/m:
 $10^{(\text{Field Strength in dB}\mu\text{V/m}/20)}$.

2.2.5 Environmental Conditions

Ambient Temperature	17.7 °C
Relative Humidity	44.0 - 47.0 %



2.2.6 Test Results

2.4 GHz Bluetooth - BDR/EDR

Mode	Modulation	Packet Type	Channel Frequency (MHz)	Measured Frequency (MHz)	Peak Level (dBμV/m)	Average Level (dBμV/m)
Static	GFSK	DH5	2402.0	2390.0	41.50	29.70
Static	π/4 DQPSK	2DH5	2402.0	2390.0	54.43	40.21
Static	8-DPSK	3DH5	2402.0	2390.0	53.81	40.28
Static	GFSK	DH5	2402.0	2483.5	52.45	40.67
Static	π/4 DQPSK	2DH5	2402.0	2483.5	53.16	41.03
Static	8-DPSK	3DH5	2402.0	2483.5	52.82	41.07
Hopping	GFSK	DH5	-	2390.0	54.95	40.13
Hopping	π/4 DQPSK	2DH5	-	2390.0	55.16	40.12
Hopping	8-DPSK	3DH5	-	2390.0	55.57	40.11
Hopping	GFSK	DH5	-	2483.5	54.16	40.65
Hopping	π/4 DQPSK	2DH5	-	2483.5	54.23	40.64
Hopping	8-DPSK	3DH5	-	2483.5	53.93	40.64

Table 7 - Restricted Band Edge Results

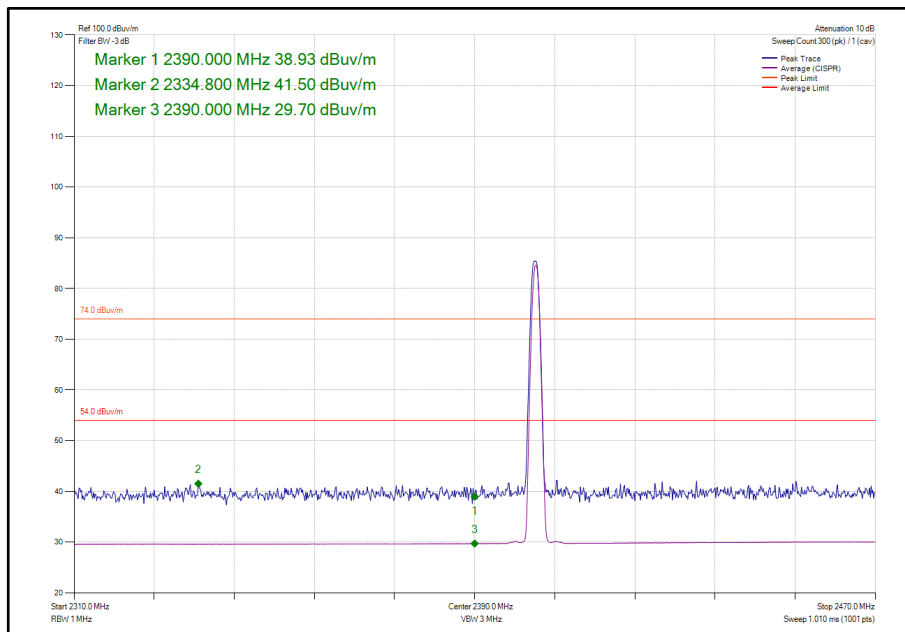

Figure 7 - Static - GFSK/DH5 - 2402.0 MHz - Measured Frequency 2390.0 MHz

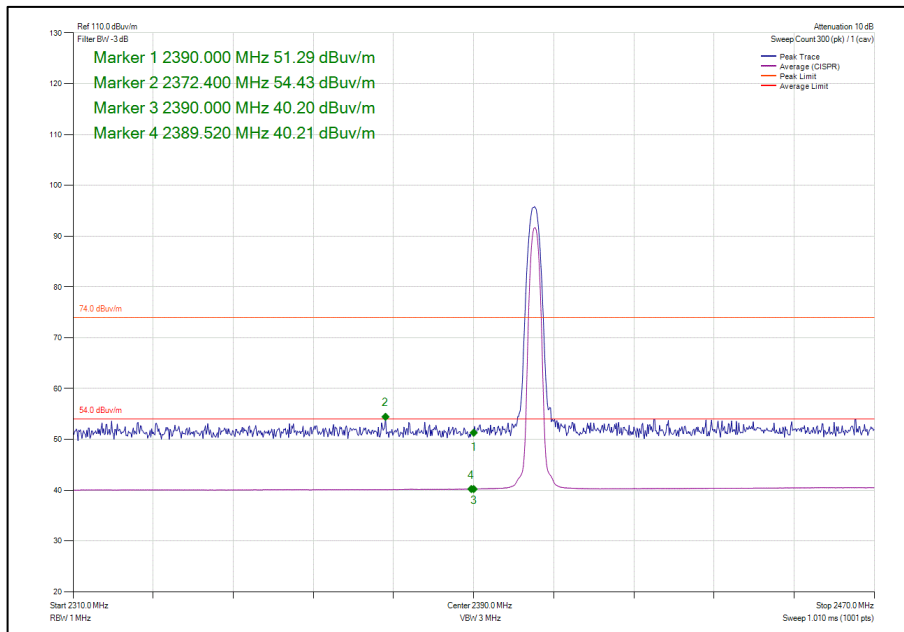

Figure 8 - Static - $\pi/4$ DQPSK/2DH5 - 2402.0 MHz - Measured Frequency 2390.0 MHz

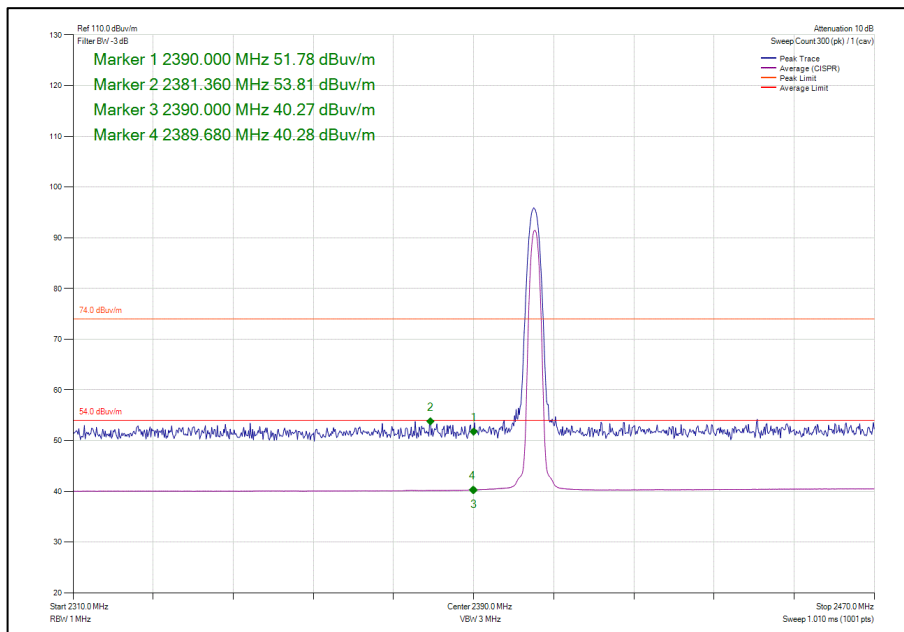

Figure 9 - Static - 8-DPSK/3DH5 - 2402.0 MHz - Measured Frequency 2390.0 MHz

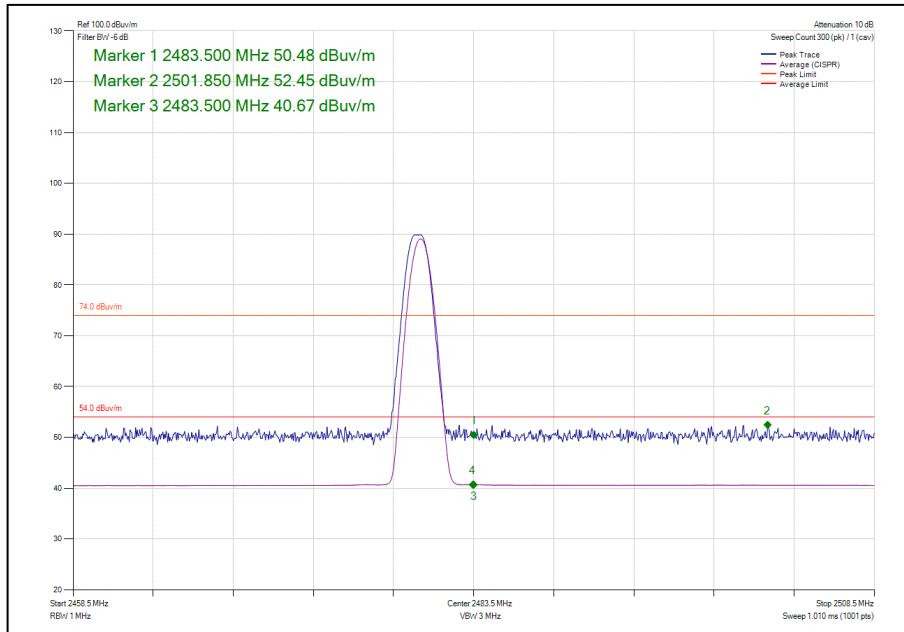

Figure 10 - Static - GFSK/DH5 - 2402.0 MHz - Measured Frequency 2483.5 MHz

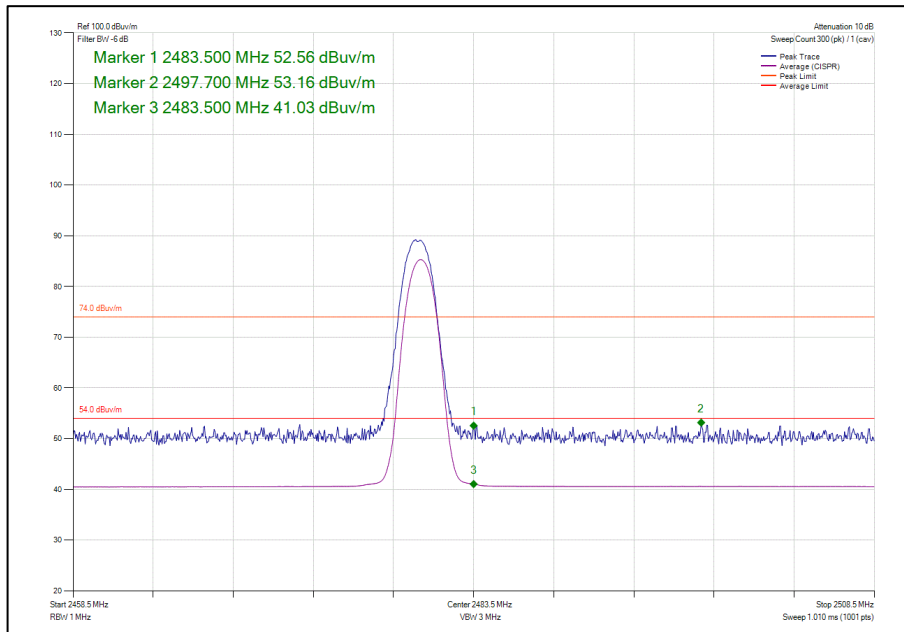

Figure 11 - Static - $\pi/4$ DQPSK/2DH5 - 2402.0 MHz - Measured Frequency 2483.5 MHz

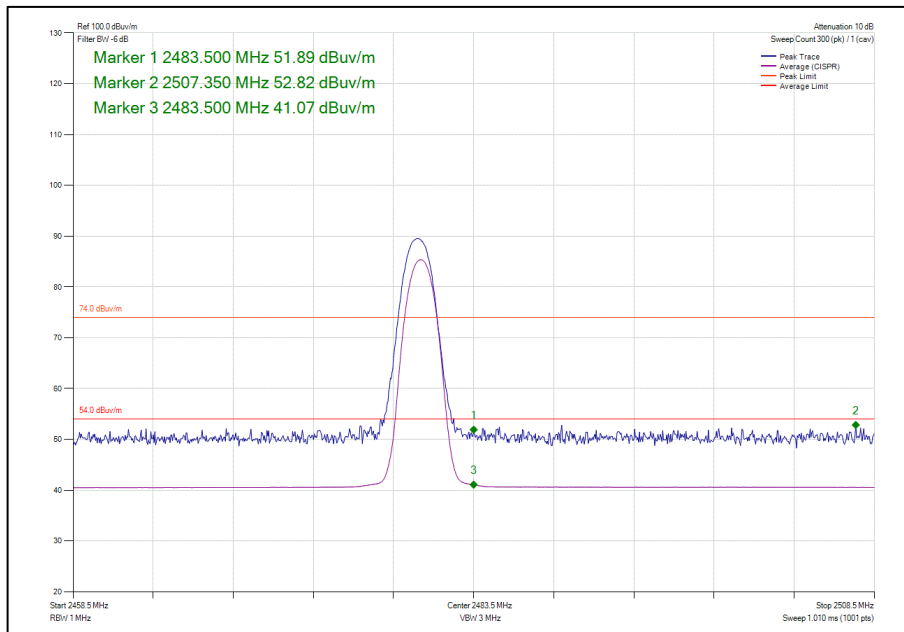

Figure 12 - Static - 8-DPSK/3DH5 - 2402.0 MHz - Measured Frequency 2483.5 MHz

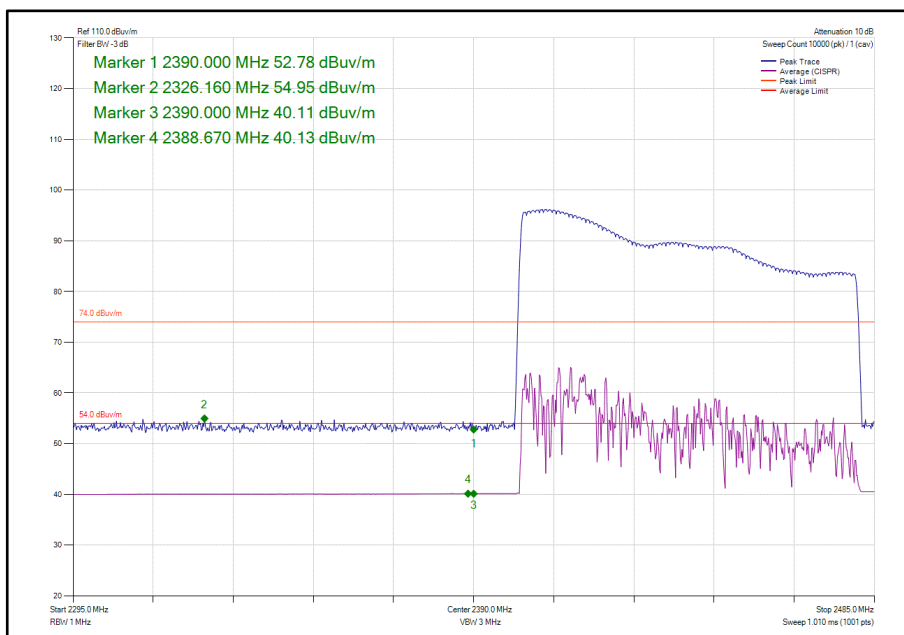

Figure 13 - Hopping - GFSK/DH5 - Measured Frequency 2390.0 MHz

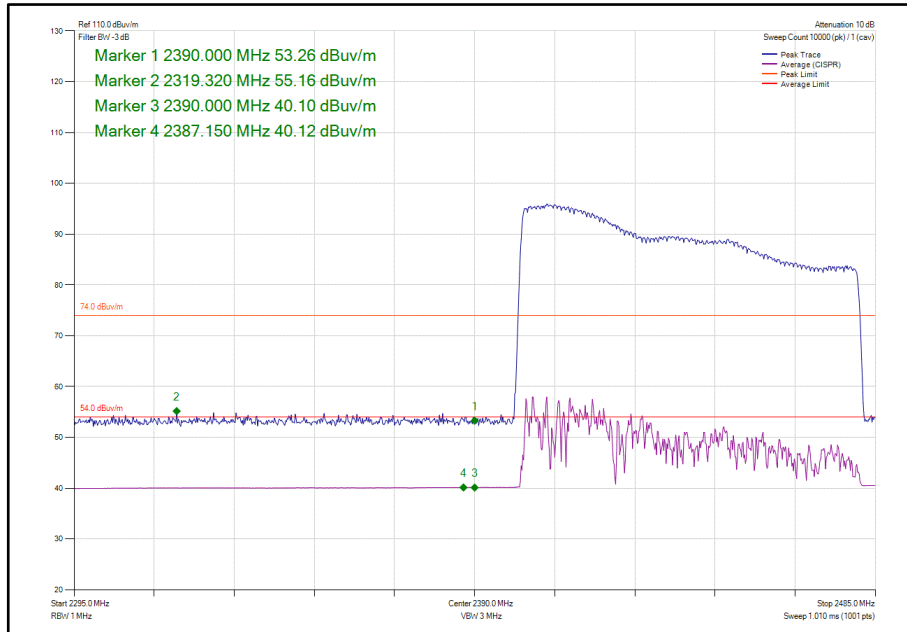

Figure 14 - Hopping - $\pi/4$ DQPSK/2DH5 - Measured Frequency 2390.0 MHz

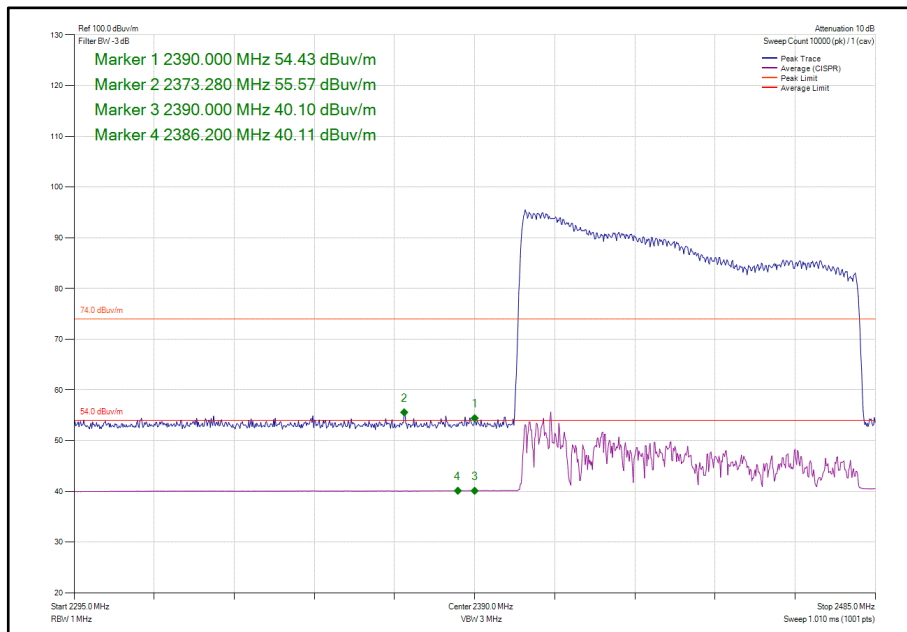

Figure 15 - Hopping - 8-DPSK/3DH5 - Measured Frequency 2390.0 MHz

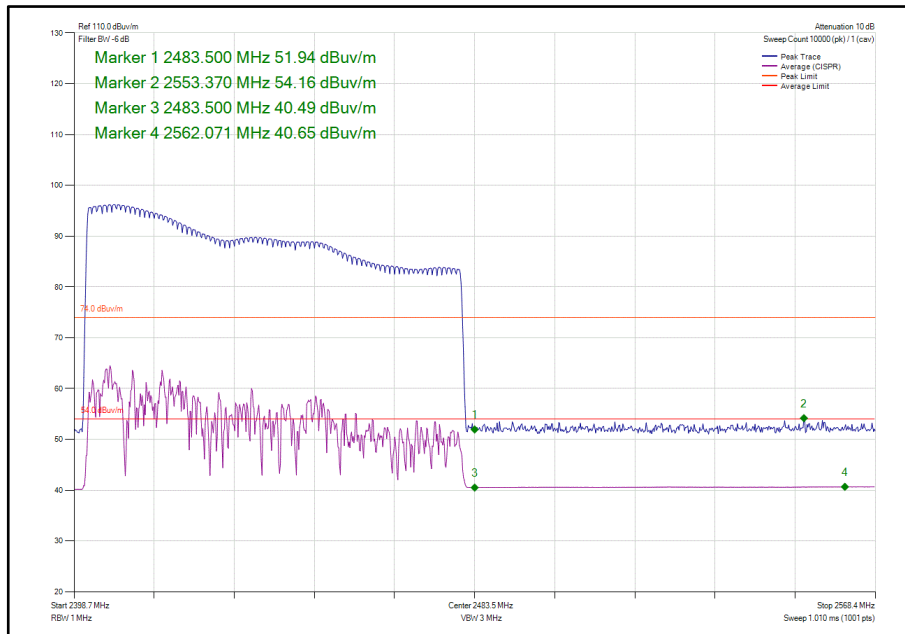

Figure 16 - Hopping - GFSK/DH5 - Measured Frequency 2483.5 MHz

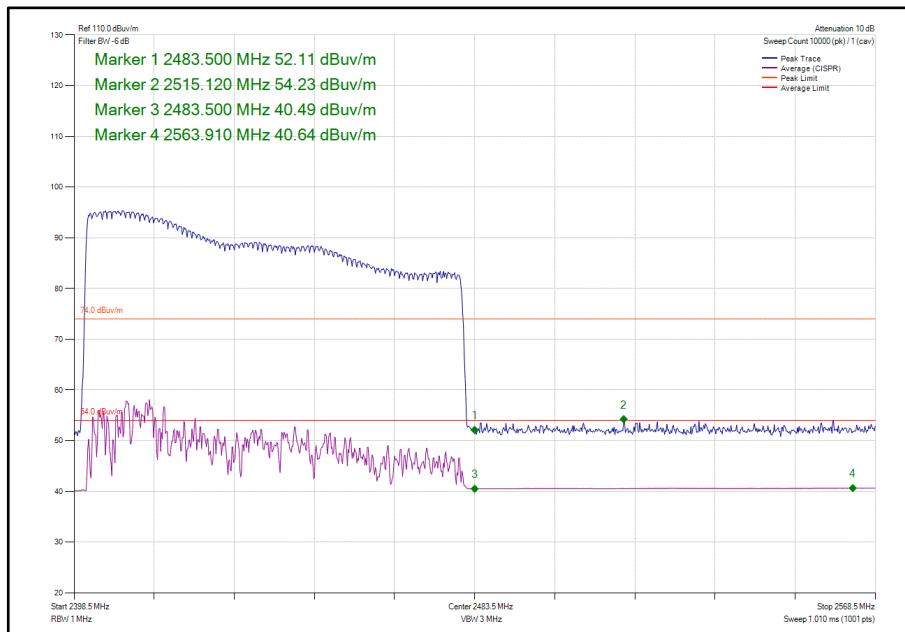

Figure 17 - Hopping - $\pi/4$ DQPSK/2DH5 - Measured Frequency 2483.5 MHz

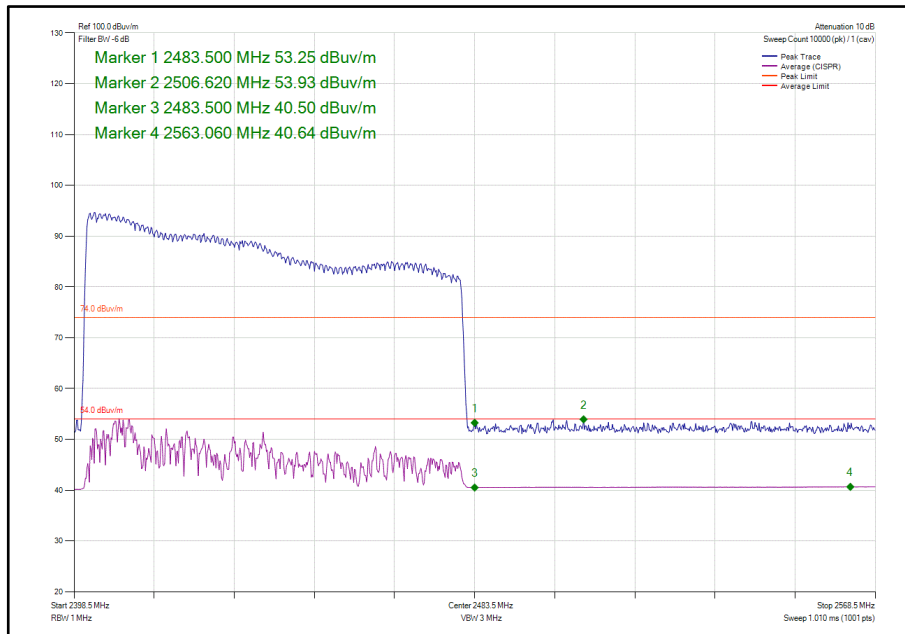

Figure 18 - Hopping - 8-DPSK/3DH5 - Measured Frequency 2483.5 MHz

FCC 47 CFR Part 15, Limit Clause 15.209

Frequency (MHz)	Field Strength ($\mu\text{V}/\text{m}$ at 3 m)
30 to 88	100
88 to 216	150
216 to 960	200
Above 960	500

Table 8

ISED RSS-GEN, Limit Clause 8.9

Frequency (MHz)	Field Strength ($\mu\text{V}/\text{m}$ at 3 metres)
30-88	100
88-216	150
216-960	200
Above 960*	500

Table 9

*Unless otherwise specified, for all frequencies greater than 1 GHz, the radiated emission limits for licence-exempt radio apparatus stated in applicable RSSs (including RSS-Gen) are based on measurements using a linear average detector function having a minimum resolution bandwidth of 1 MHz. If an average limit is specified for the EUT, then the peak emission shall also be measured with instrumentation properly adjusted for such factors as pulse desensitization to ensure the peak emission is less than 20 dB above the average limit.



2.2.7 Test Location and Test Equipment Used

This test was carried out in EMC Chamber 5.

Instrument	Manufacturer	Type No	TE No	Calibration Period (months)	Calibration Due
Screened Room (5)	Rainford	Rainford	1545	36	23-Jan-2021
Turntable Controller	Inn-Co GmbH	CO 1000	1606	-	TU
Hygrometer	Rotronic	A1	2677	12	20-Feb-2020
'2.92mm' - '2.92mm' RF Cable (2m)	Rhophase	KPS-1503-2000-KPS	3695	12	11-Jun-2020
Mast Controller	Maturo GmbH	NCD	4810	-	TU
Tilt Antenna Mast	Maturo GmbH	TAM 4.0-P	4811	-	TU
Double Ridge Broadband Horn Antenna	Schwarzbeck	BBHA 9120 B	4848	12	11-Mar-2020
EmX Emissions Software	TUV SUD	EmX V.V1.5.3	5125	-	Software
8 Meter Cable	Teledyne	PR90-088-8MTR	5212	12	30-Aug-2020
EMI Test Receiver	Rohde & Schwarz	ESW44	5382	12	8-Oct-2020

Table 10

TU – Traceability Unscheduled



2.3 Spurious Radiated Emissions

2.3.1 Specification Reference

FCC 47 CFR Part 15C, Clause 15.247 (d) and 15.205
ISED RSS-247, Clause 5.5
ISED RSS-GEN, Clause 6.13

2.3.2 Equipment Under Test and Modification State

SC2028, S/N: 1PR001925GK63ZJ - Modification State 0

2.3.3 Date of Test

12-December-2019

2.3.4 Test Method

This test was performed in accordance with ANSI C63.10, clause 6.3, 6.5 and 6.6.

The EUT was placed on the non-conducting platform in a manner typical of a normal installation. For an EUT which could reasonable be used in multiple planes, pre-scans were performed with the EUT orientated in X, Y and Z planes with reference to the ground plane.

Ports on the EUT were terminated with loads as described in ANSI C63.4 clause 6.2.4. For EUT's with multiple connectors of the same type, additional interconnecting cables were connected, and pre-scans performed to determine whether the level of the emissions were increased by >2 dB.

For frequencies > 1 GHz, plots for average measurements were taken in accordance with ANSI C63.10 clause 4.1.4.2.5 to characterize the EUT. Where emissions were detected, final average measurements were taken in accordance with ANSI C63.10, clause 4.1.4.2.2.

The plots shown are the characterization of the EUT. The limits on the plots represent the most stringent case for restricted bands, (74/54 dBuV/m) when compared to -20 dBc outside restricted bands. The limits shown have been used as a threshold to determine where further measurements are necessary. Where results are within 10 dB of the limits shown on the plots, further investigation was carried out and reported in results tables.

The following conversion can be applied to convert from dB μ V/m to μ V/m:
 $10^{(\text{Field Strength in dB}\mu\text{V/m}/20)}$.

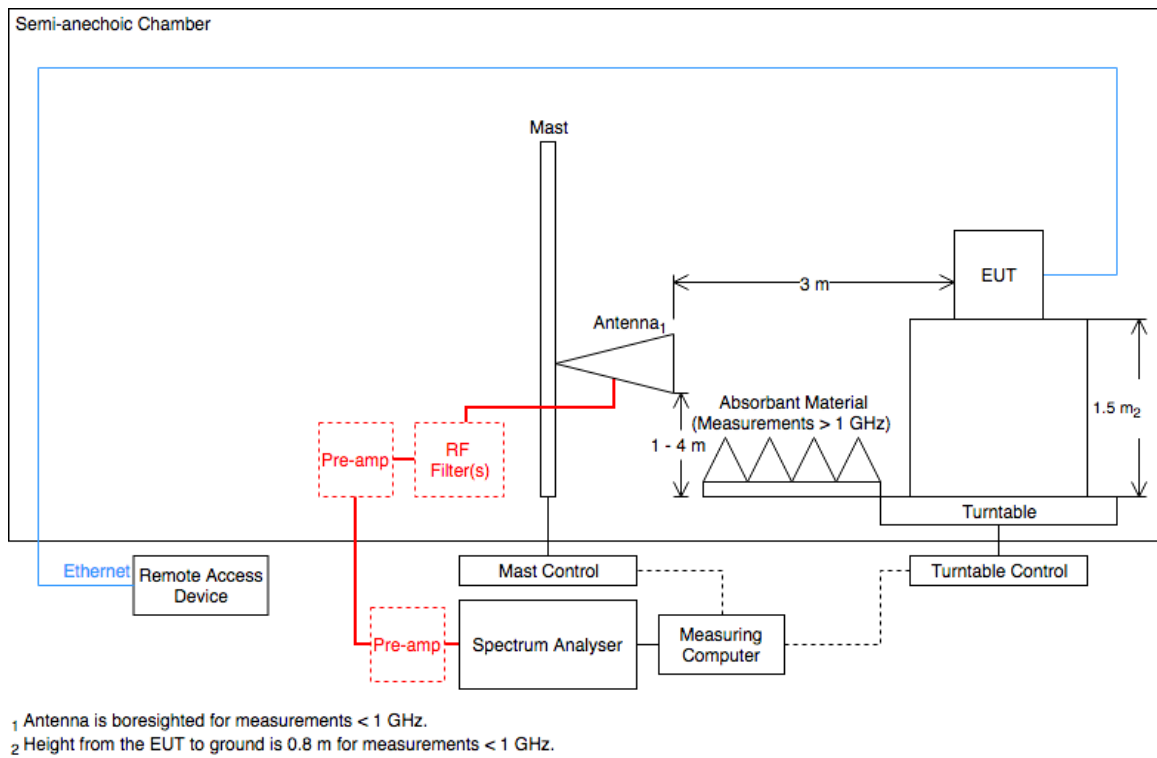

Figure 19 - Radiated Emissions Test Setup Diagram

2.3.5 Environmental Conditions

Ambient Temperature	17.0 °C
Relative Humidity	37.0 %



2.3.6 Test Results

2.4 GHz Bluetooth - BDR/EDR

Testing was performed on the modulation and packet type which resulted in the highest conducted output power. The Modulation/Packet type was GFSK/DH5.

Frequency (MHz)	Level (dBµV/m)	Limit (dBµV/m)	Margin (dB)	Detector	Angle (°)	Height (cm)	Polarisation	Orientation
923.941	26.5	46.0	-19.5	Peak	83	138	Vertical	X
937.456	37.0	46.0	-9.0	Peak	45	169	Horizontal	X
924.994	28.0	46.0	-18.0	Peak	17	149	Vertical	Y
938.279	33.4	46.0	-12.6	Peak	8	105	Horizontal	Y
924.828	31.7	46.0	-14.3	Peak	344	314	Vertical	Z
922.698	27.3	46.0	-18.7	Peak	282	275	Horizontal	Z

Table 11 - Radiated Emissions Results, 30 MHz to 1 GHz - 2402 MHz

No other emissions were detected within 10 dB of the limit.

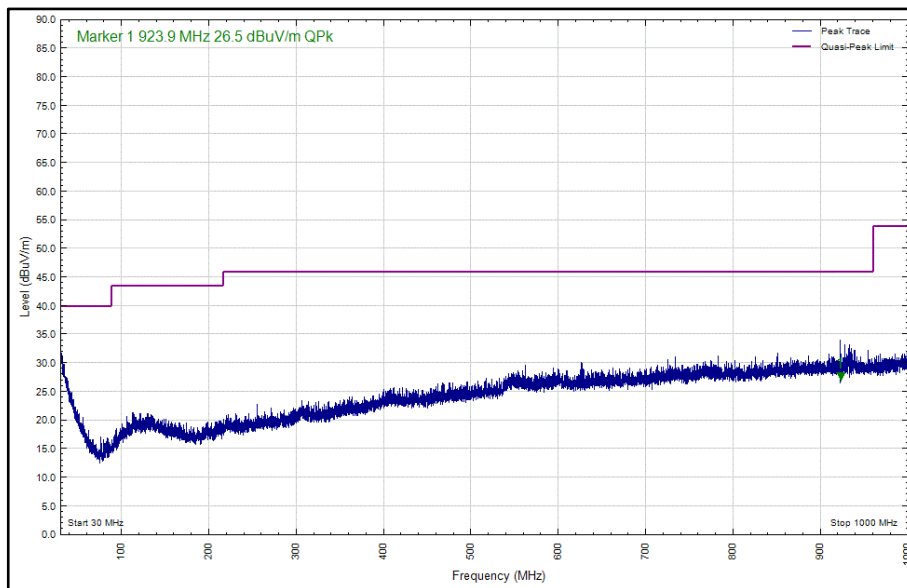

Figure 20 - 30 MHz to 1 GHz, 2402 MHz, Polarity: Vertical, EUT Orientation X

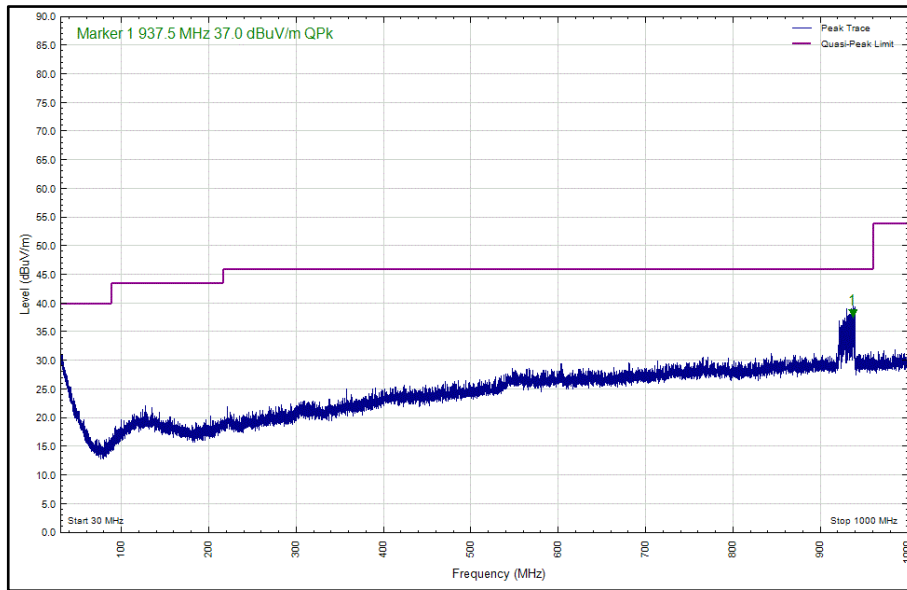

Figure 21 - 30 MHz to 1 GHz, 2402 MHz, Polarity: Horizontal, EUT Orientation X

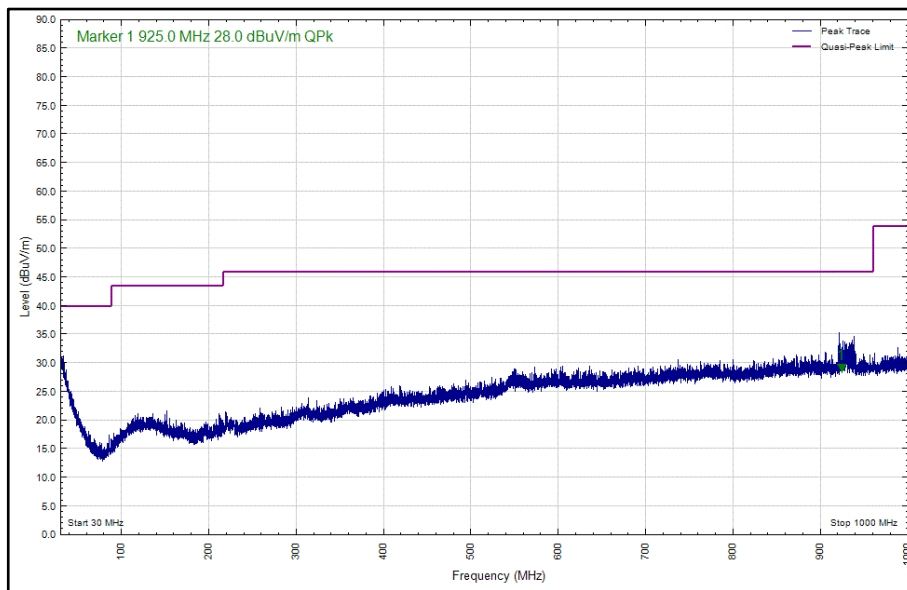

Figure 22 - 30 MHz to 1 GHz, 2402 MHz, Polarity: Vertical, EUT Orientation Y

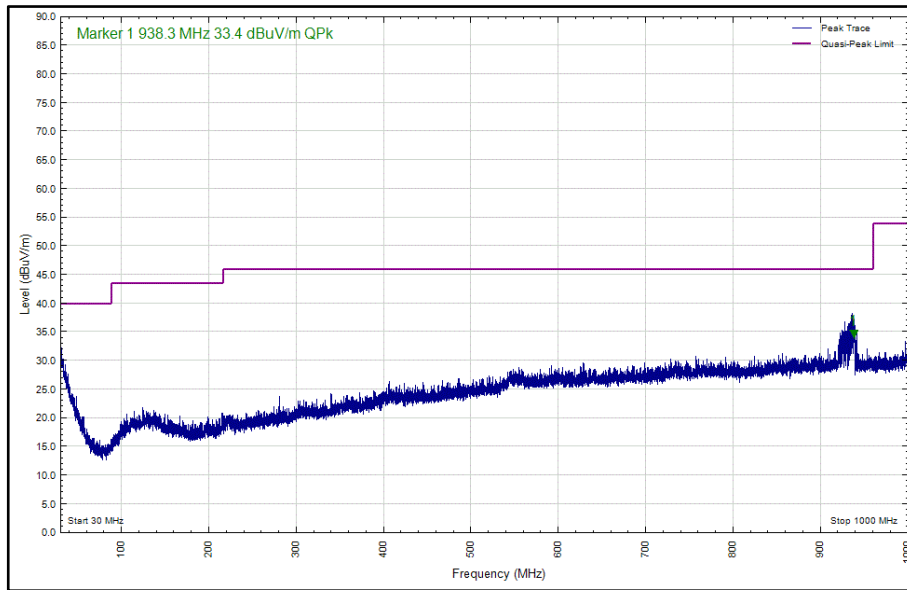

Figure 23 - 30 MHz to 1 GHz, 2402 MHz, Polarity: Horizontal, EUT Orientation Y

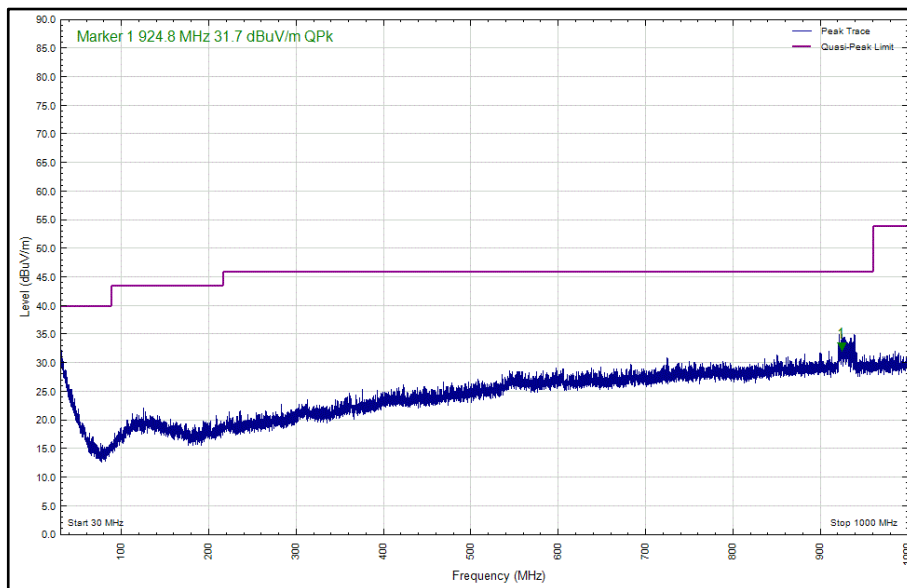

Figure 24 - 30 MHz to 1 GHz, 2402 MHz, Polarity: Vertical, EUT Orientation Z

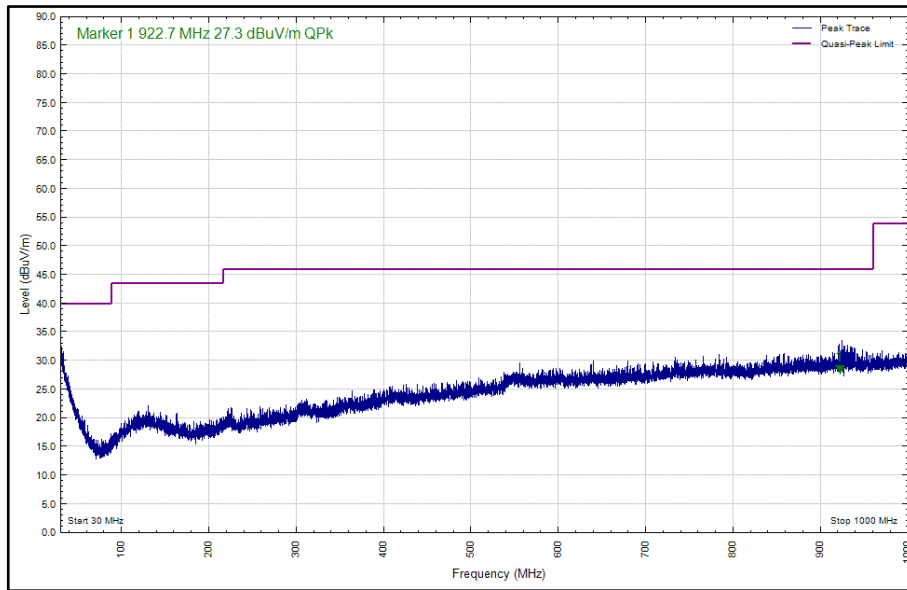

Figure 25 - 30 MHz to 1 GHz, 2402 MHz, Polarity: Horizontal, EUT Orientation Z



Frequency (MHz)	Level (dBµV/m)	Limit (dBµV/m)	Margin (dB)	Detector	Angle (°)	Height (cm)	Polarisation	Orientation
4804.246	34.5	54.0	-19.5	Average	61	101	Vertical	X
4638.837	35.7	54.0	-18.3	Average	204	100	Horizontal	X
4804.191	39.2	54.0	-14.9	Average	151	297	Horizontal	X
4653.929	36.3	54.0	-17.7	Average	55	102	Vertical	Y
4803.806	36.6	54.0	-17.4	Average	52	103	Horizontal	Y
4678.968	37.6	74.0	-16.4	Peak	8	296	Vertical	Z
3202.748	35.9	54.0	-18.1	Average	316	110	Horizontal	Z

Table 12 - 2402 MHz - 1 GHz to 26 GHz Emissions Results

No other emissions were detected within 10 dB of the limit.

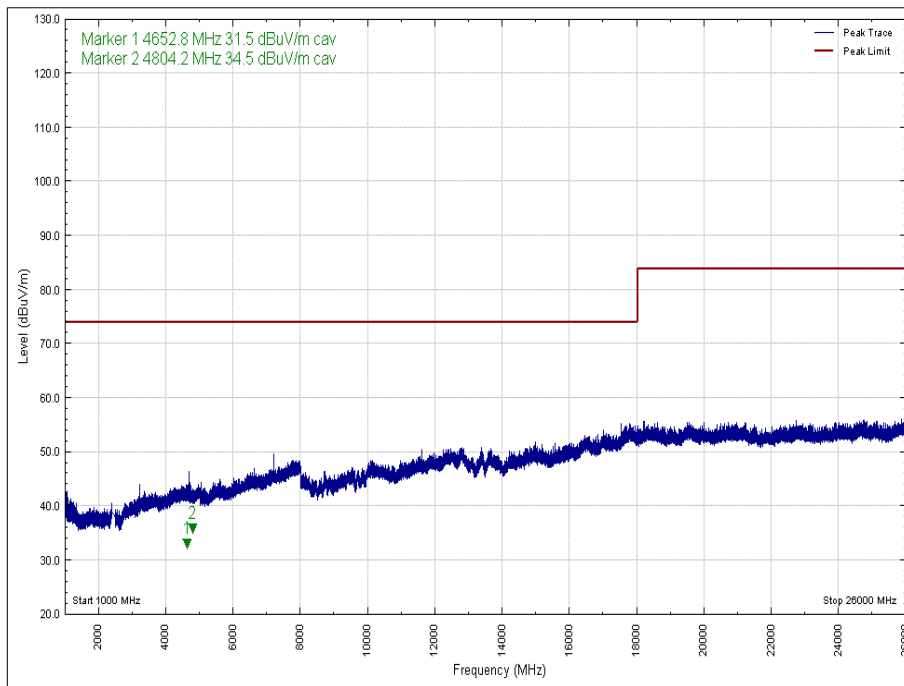

Figure 26 - 2402 MHz - 1 GHz to 26 GHz, Polarity: Vertical, EUT Orientation: X, Peak

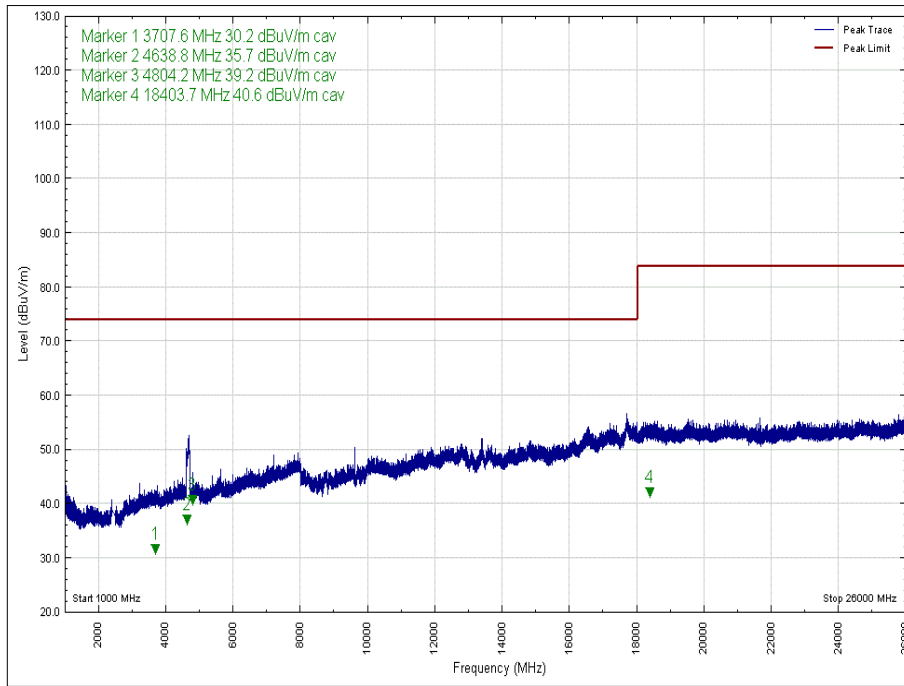

Figure 27 - 2402 MHz - 1 GHz to 26 GHz, Polarity: Horizontal, EUT Orientation: X, Peak

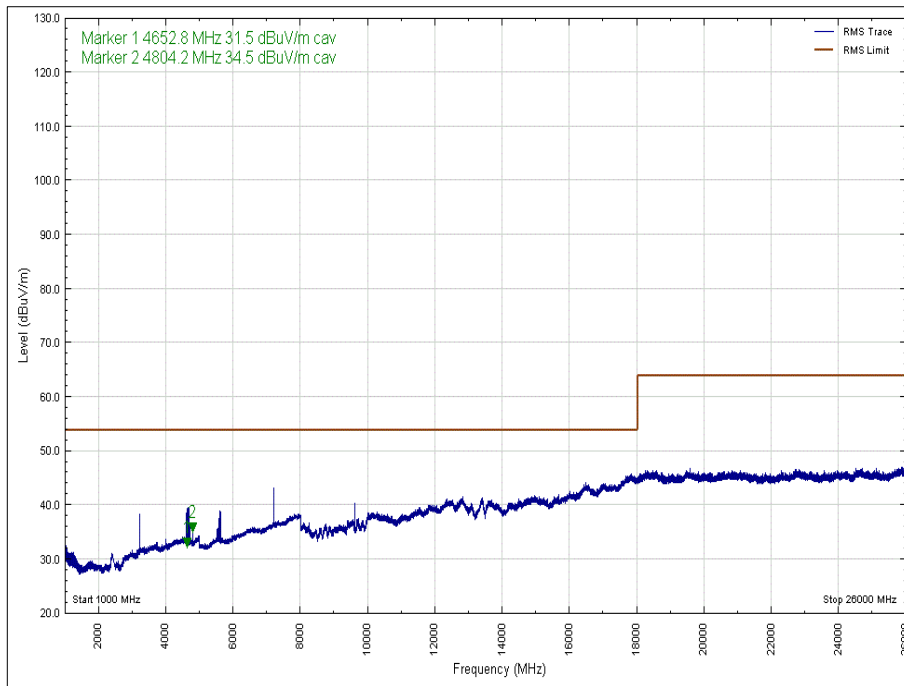

Figure 28 - 2402 MHz - 1 GHz to 26 GHz, Polarity: Vertical, EUT Orientation: X, Average

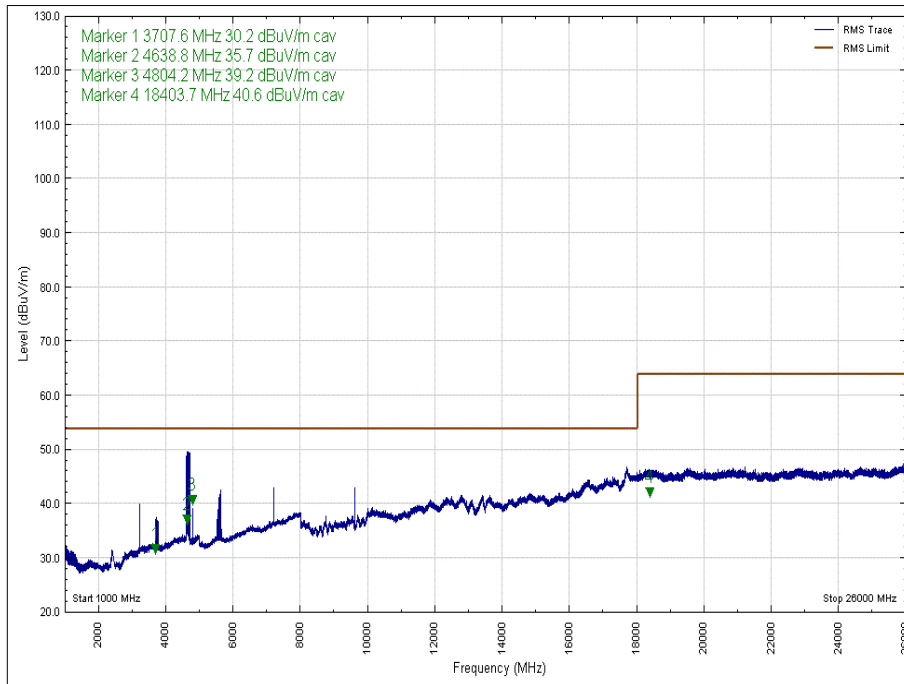

Figure 29 - 2402 MHz - 1 GHz to 26 GHz, Polarity: Horizontal, EUT Orientation: X, Average

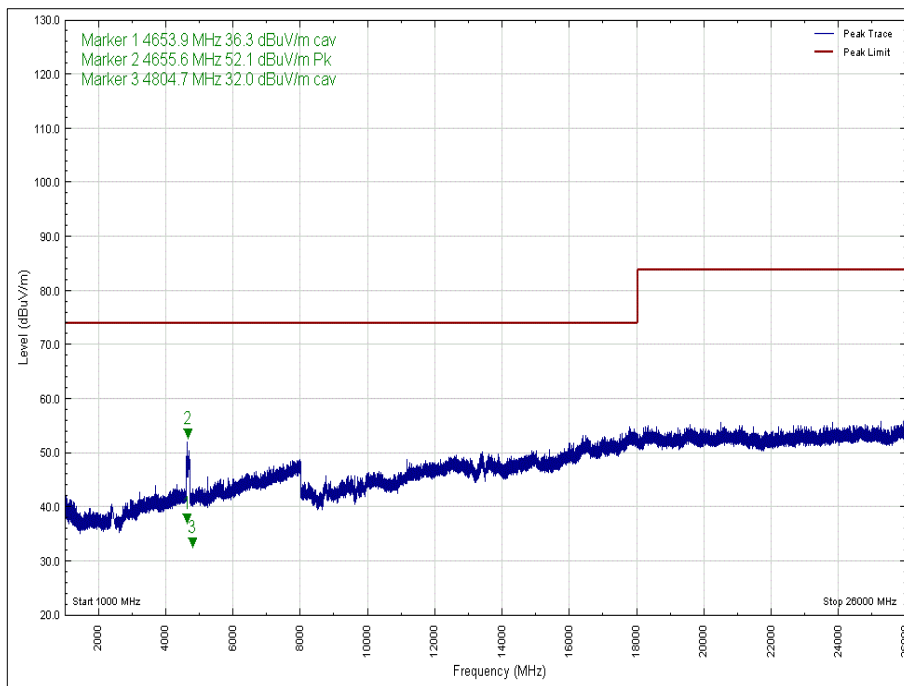

Figure 30 - 2402 MHz - 1 GHz to 26 GHz, Polarity: Vertical, EUT Orientation: Y, Peak

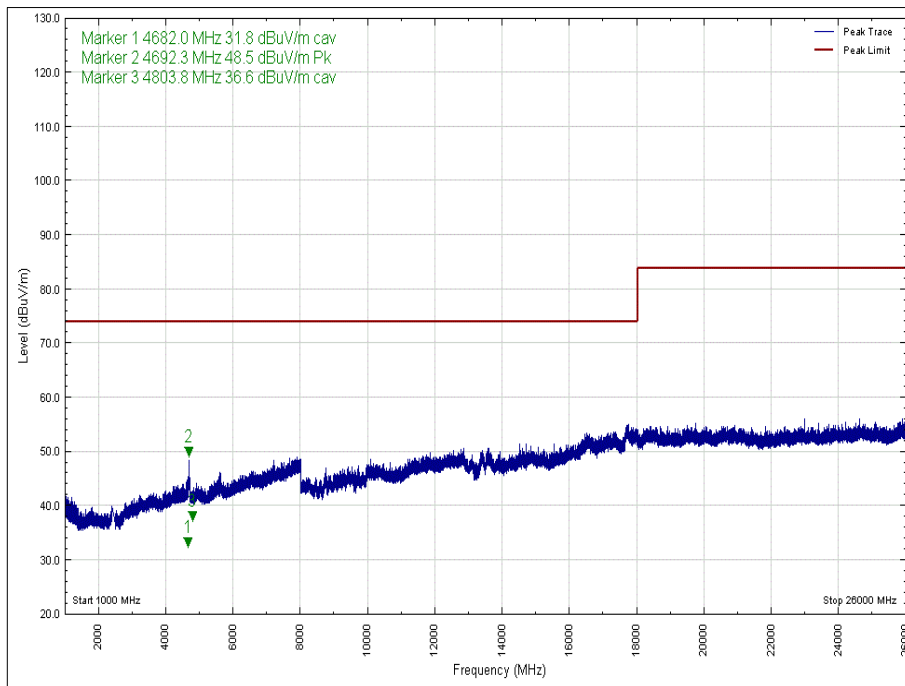

Figure 31 - 2402 MHz - 1 GHz to 26 GHz, Polarity: Horizontal, EUT Orientation: Y, Peak

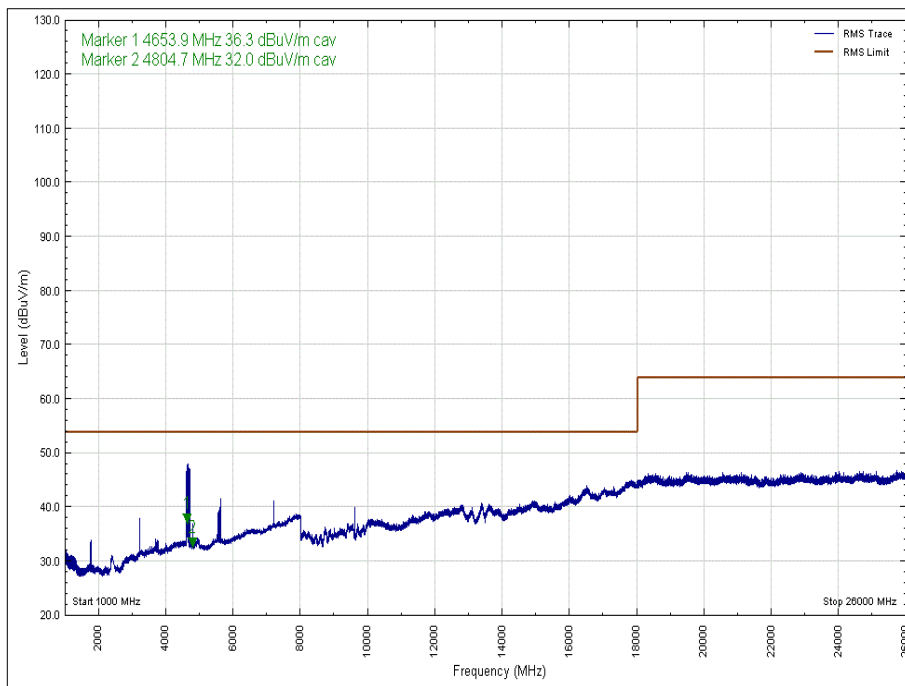

Figure 32 - 2402 MHz - 1 GHz to 26 GHz, Polarity: Vertical, EUT Orientation: Y, Average

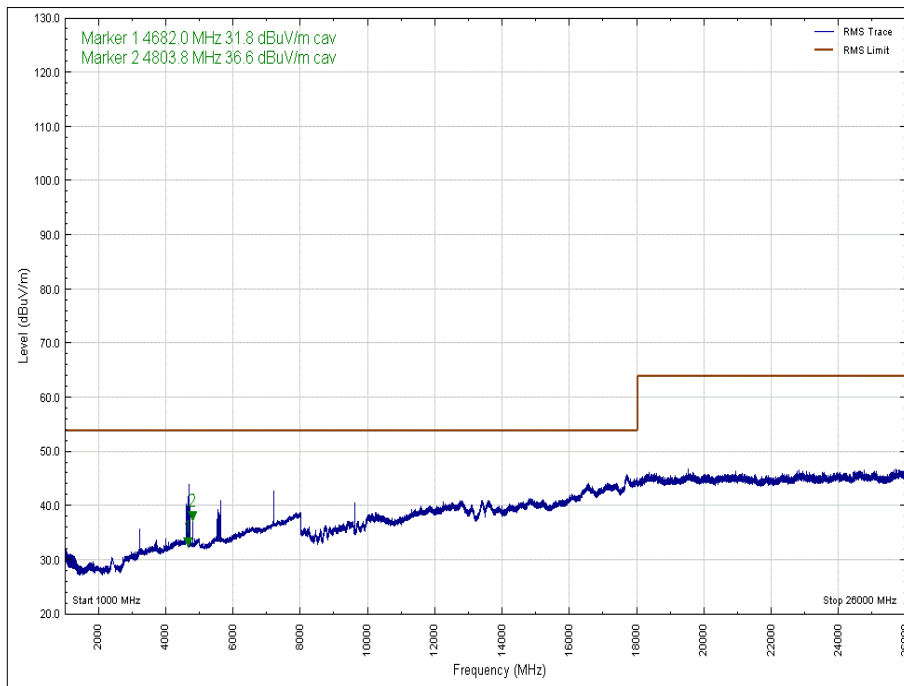

Figure 33 - 2402 MHz - 1 GHz to 26 GHz, Polarity: Horizontal, EUT Orientation: Y, Average

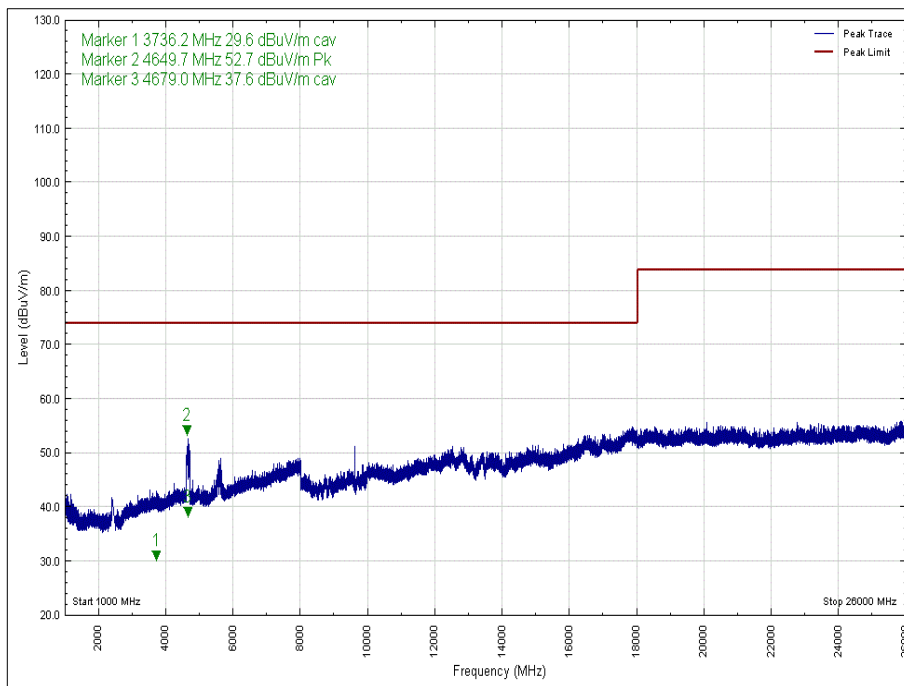

Figure 34 - 2402 MHz - 1 GHz to 26 GHz, Polarity: Vertical, EUT Orientation: Z, Peak

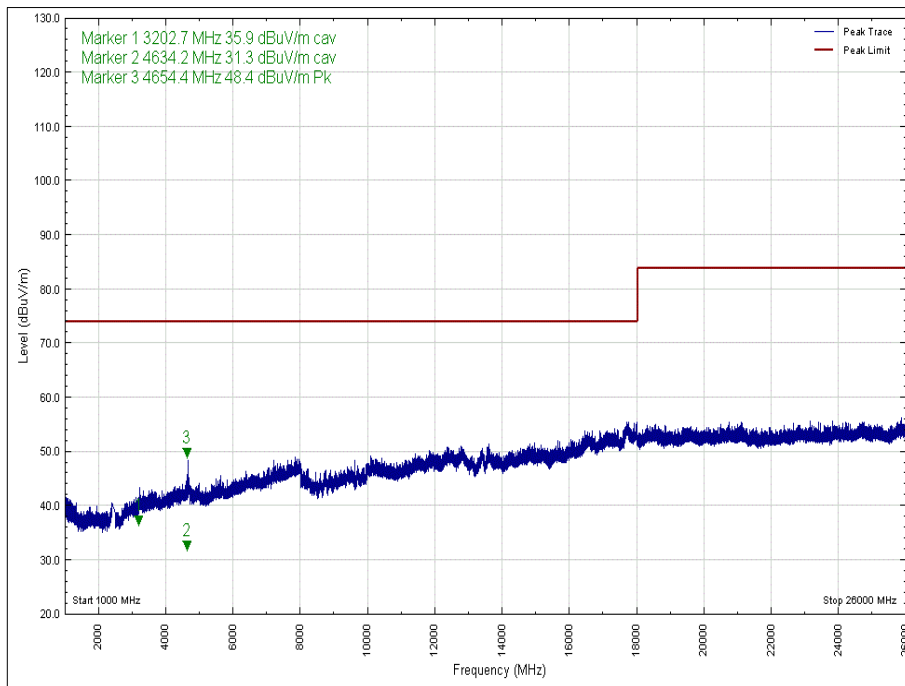

Figure 35 - 2402 MHz - 1 GHz to 26 GHz, Polarity: Horizontal, EUT Orientation: Z, Peak

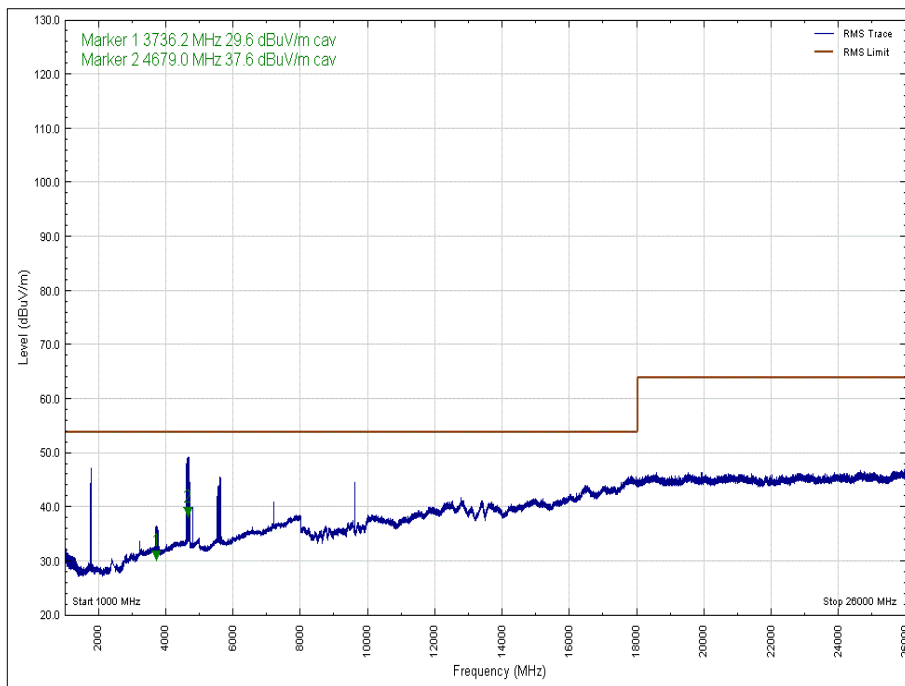

Figure 36 - 2402 MHz - 1 GHz to 26 GHz, Polarity: Vertical, EUT Orientation: Z, Average

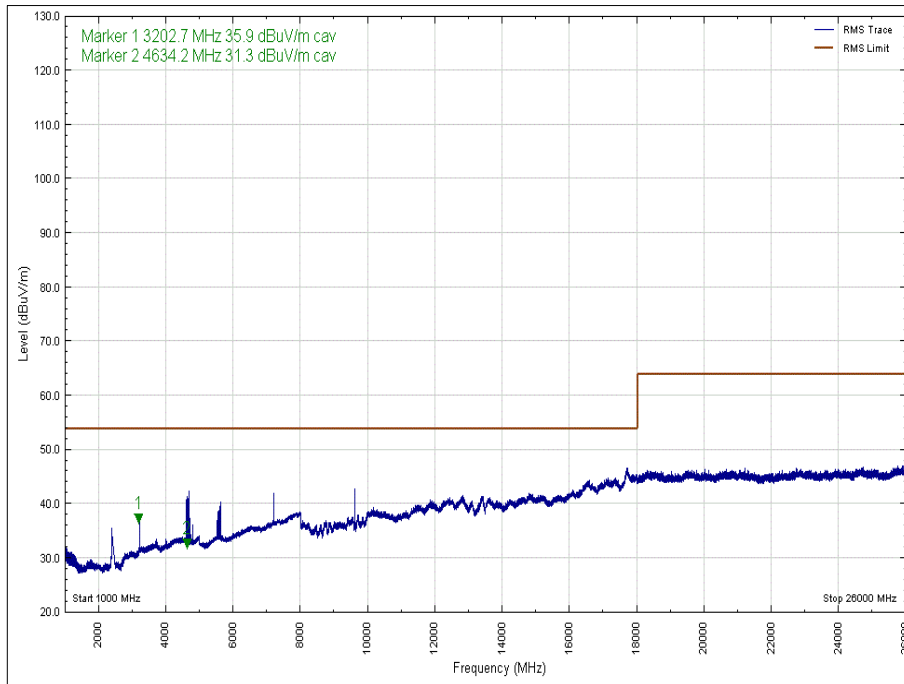

Figure 37 - 2402 MHz - 1 GHz to 26 GHz, Polarity: Horizontal, EUT Orientation: Z, Average



Frequency (MHz)	Level (dB μ V/m)	Limit (dB μ V/m)	Margin (dB)	Detector	Angle (°)	Height (cm)	Polarisation	Orientation
937.172	36.4	46.0	-9.6	Peak	59	173	Horizontal	X
928.944	28.4	46.0	-17.6	Peak	53	213	Vertical	Y
938.794	33.6	46.0	-12.4	Peak	36	170	Horizontal	Y
935.334	31.6	46.0	-14.4	Peak	154	390	Vertical	Z
928.312	25.4	46.0	-20.6	Peak	126	102	Horizontal	Z

Table 13 - Radiated Emissions Results, 30 MHz to 1 GHz - 2441 MHz

No other emissions were detected within 10 dB of the limit.

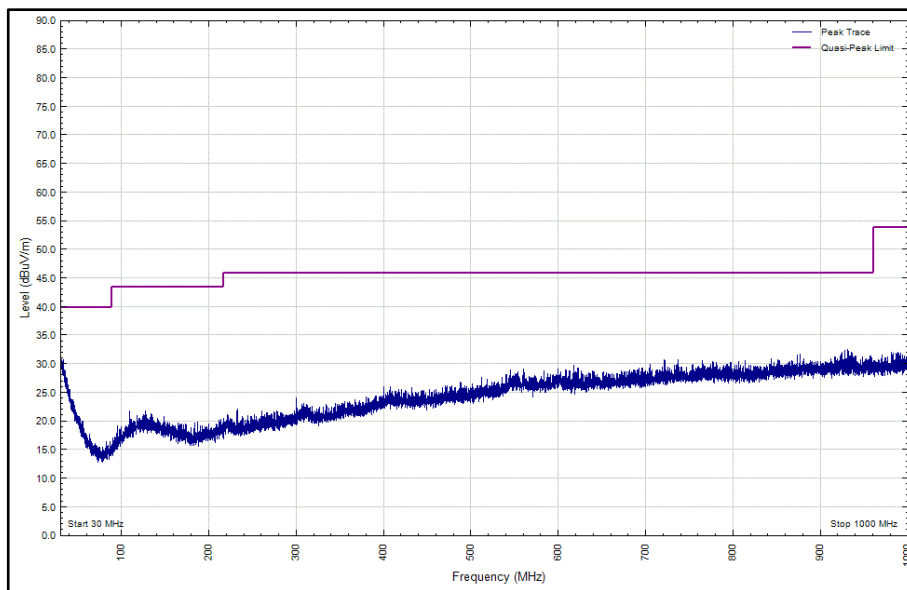

Figure 38 - 30 MHz to 1 GHz, 2441 MHz, Polarity: Vertical, EUT Orientation X

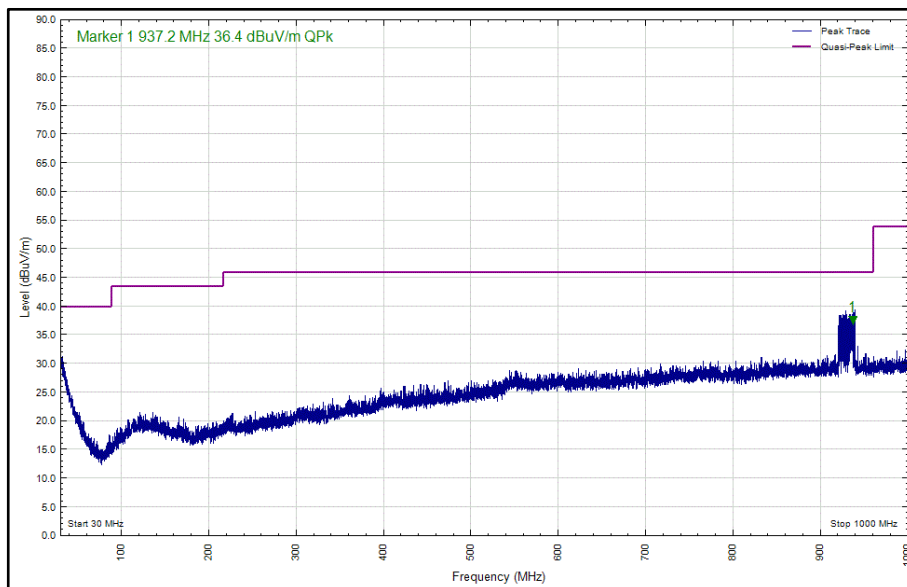

Figure 39 - 30 MHz to 1 GHz, 2441 MHz, Polarity: Horizontal, EUT Orientation X

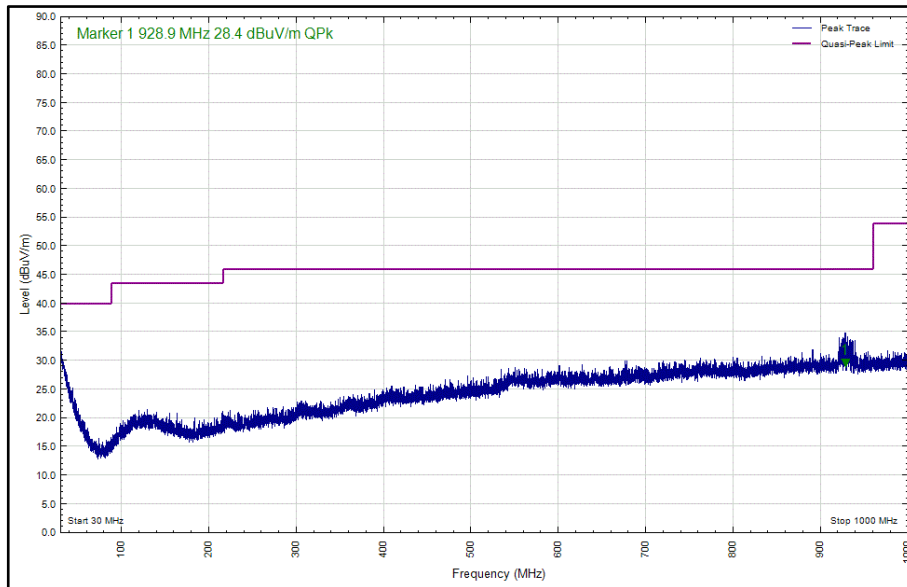

Figure 40 - 30 MHz to 1 GHz, 2441 MHz, Polarity: Vertical, EUT Orientation Y

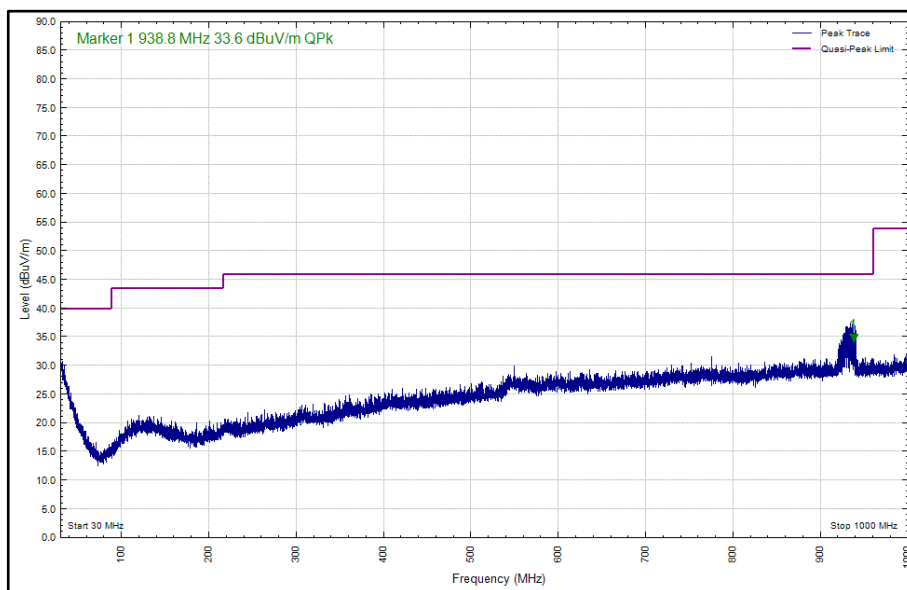

Figure 41 - 30 MHz to 1 GHz, 2441 MHz, Polarity: Horizontal, EUT Orientation Y

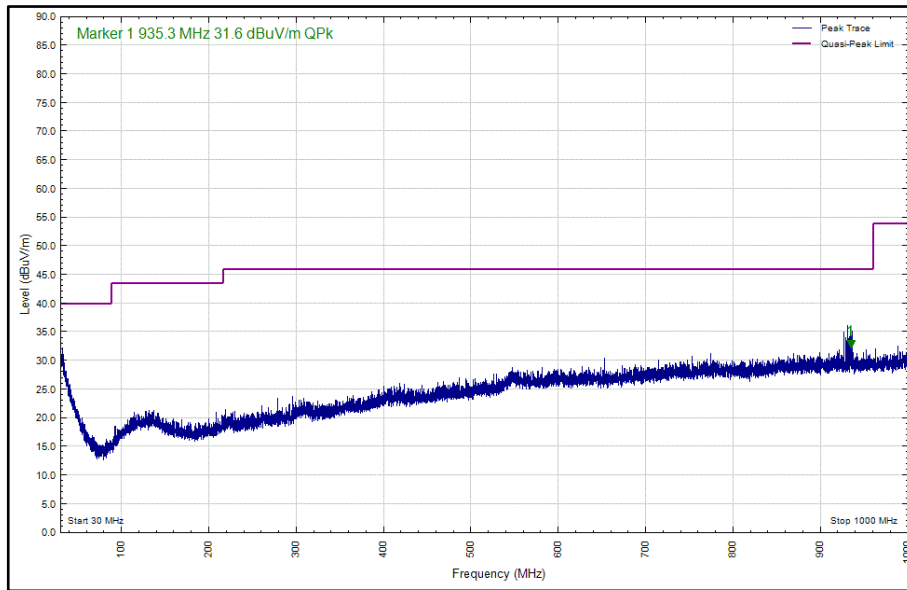

Figure 42 - 30 MHz to 1 GHz, 2441 MHz, Polarity: Vertical, EUT Orientation Z

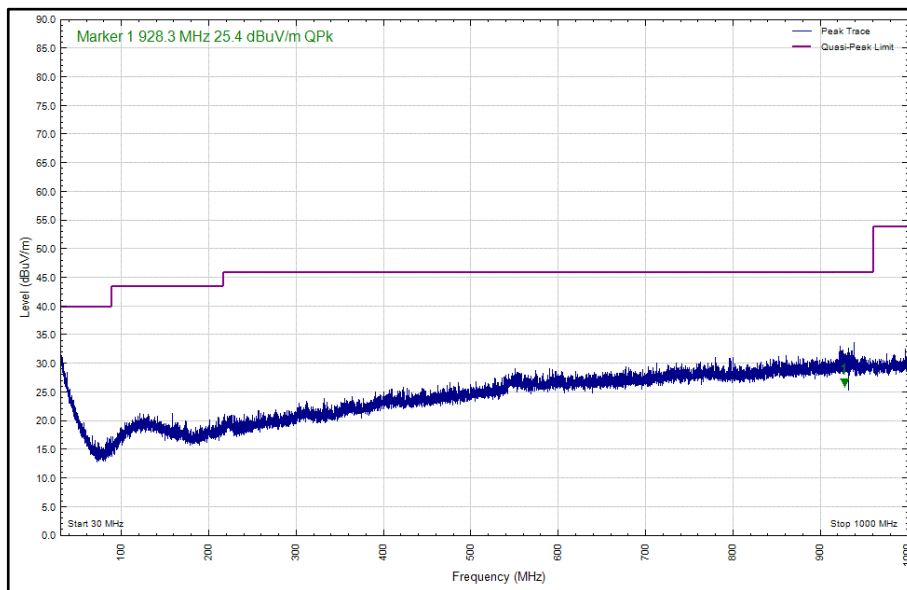

Figure 43 - 30 MHz to 1 GHz, 2441 MHz, Polarity: Horizontal, EUT Orientation Z



Frequency (MHz)	Level (dB μ V/m)	Limit (dB μ V/m)	Margin (dB)	Detector	Angle (°)	Height (cm)	Polarisation	Orientation
4690.753	32.4	54.0	-21.6	Average	174	175	Vertical	X
4880.051	37.2	54.0	-16.8	Average	67	104	Vertical	X
7319.534	38.3	54.0	-15.8	Average	278	130	Vertical	X
4678.478	38.0	54.0	-16.0	Average	162	100	Horizontal	X
3749.166	30.4	54.0	-23.6	Average	251	103	Horizontal	X
4880.301	36.6	54.0	-17.4	Average	152	233	Horizontal	X
7320.064	38.8	54.0	-15.2	Average	179	238	Horizontal	X
4635.393	36.1	54.0	-17.9	Average	41	108	Vertical	Y
7319.549	37.4	54.0	-16.6	Average	263	292	Vertical	Y
4685.030	49.3	74.0	-24.7	Peak	83	190	Horizontal	Y
4696.250	31.7	54.0	-22.3	Average	88	146	Horizontal	Y
4880.151	37.2	54.0	-16.8	Average	54	107	Horizontal	Y
7319.649	39.3	54.0	-14.7	Average	244	100	Horizontal	Y
3728.201	29.4	54.0	-24.7	Average	351	104	Vertical	Z
4666.431	53.0	74.0	-21.0	Peak	353	199	Vertical	Z
4680.644	37.3	54.0	-16.8	Average	350	274	Vertical	Z
4678.669	33.0	54.0	-21.0	Average	275	193	Horizontal	Z
7319.569	38.0	54.0	-16.0	Average	11	100	Horizontal	Z
7320.354	38.5	54.0	-15.5	Average	3256	137	Horizontal	Z

Table 14 - 2441 MHz - 1 GHz to 26 GHz Emissions Results

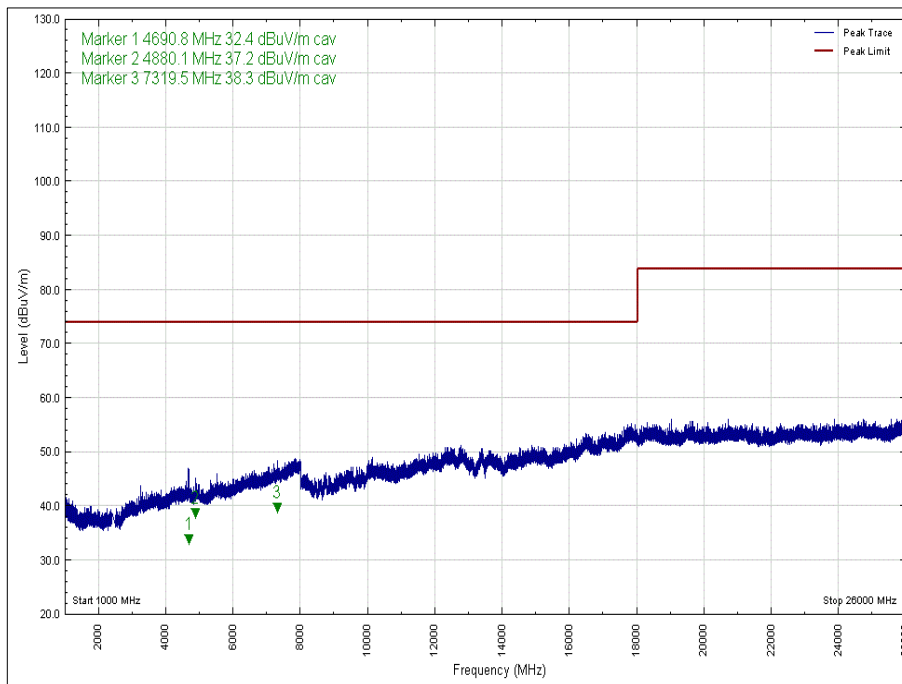

Figure 44 - 2441 MHz - 1 GHz to 26 GHz, Polarity: Vertical, EUT Orientation: X, Peak

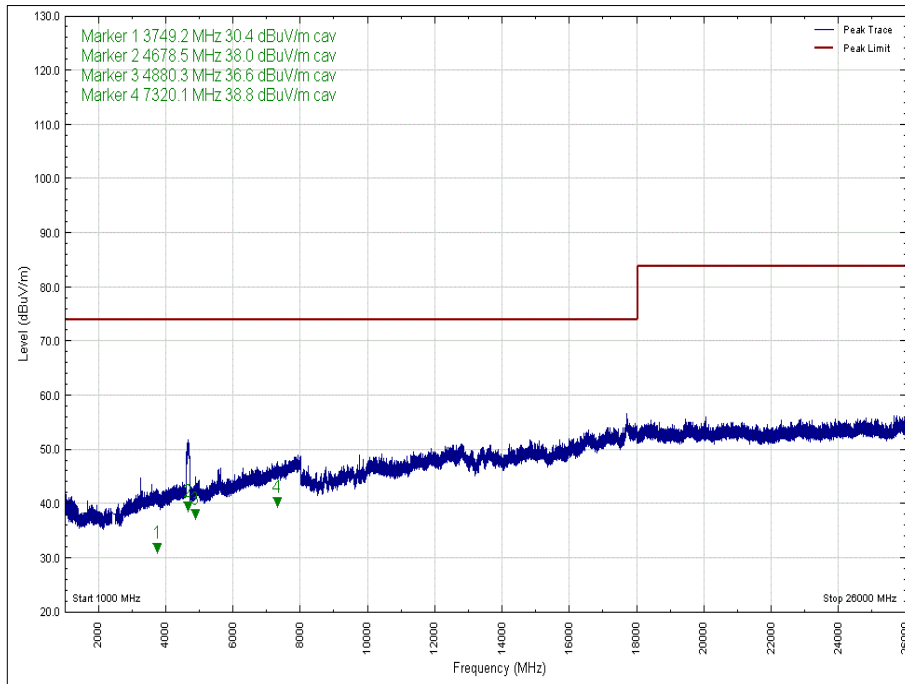

Figure 45 - 2441 MHz - 1 GHz to 26 GHz, Polarity: Horizontal, EUT Orientation: X, Peak

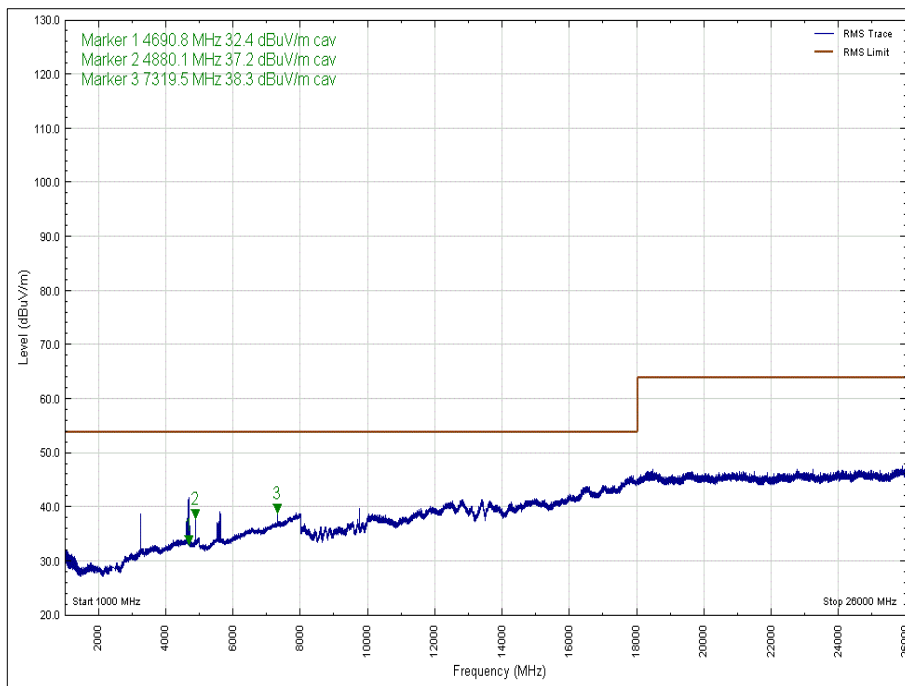

Figure 46 - 2441 MHz - 1 GHz to 26 GHz, Polarity: Vertical, EUT Orientation: X, Average

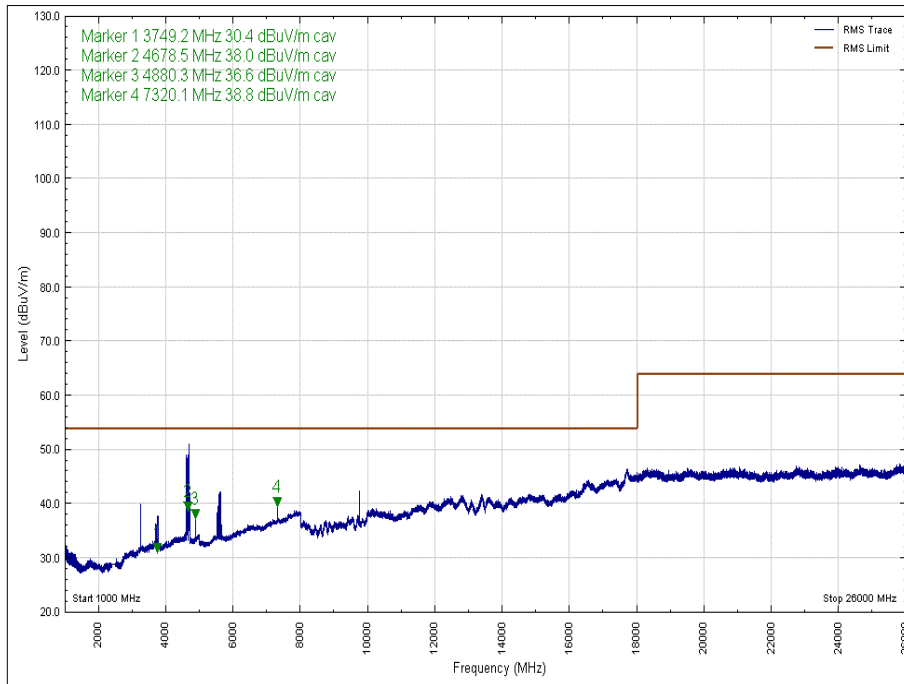

Figure 47 - 2441 MHz - 1 GHz to 26 GHz, Polarity: Horizontal, EUT Orientation: X, Average

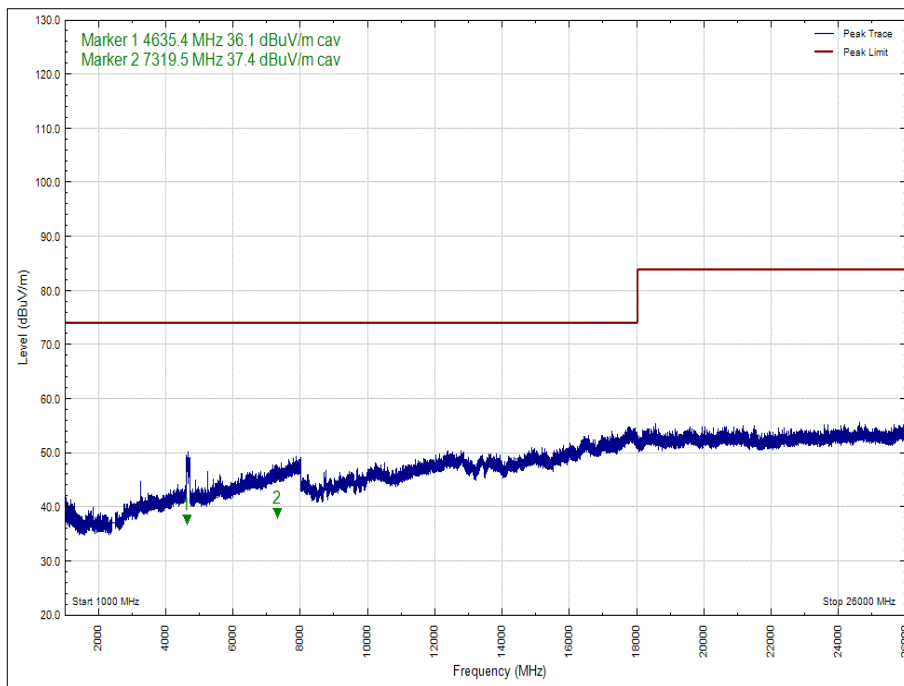

Figure 48 - 2441 MHz - 1 GHz to 26 GHz, Polarity: Vertical, EUT Orientation: Y, Peak

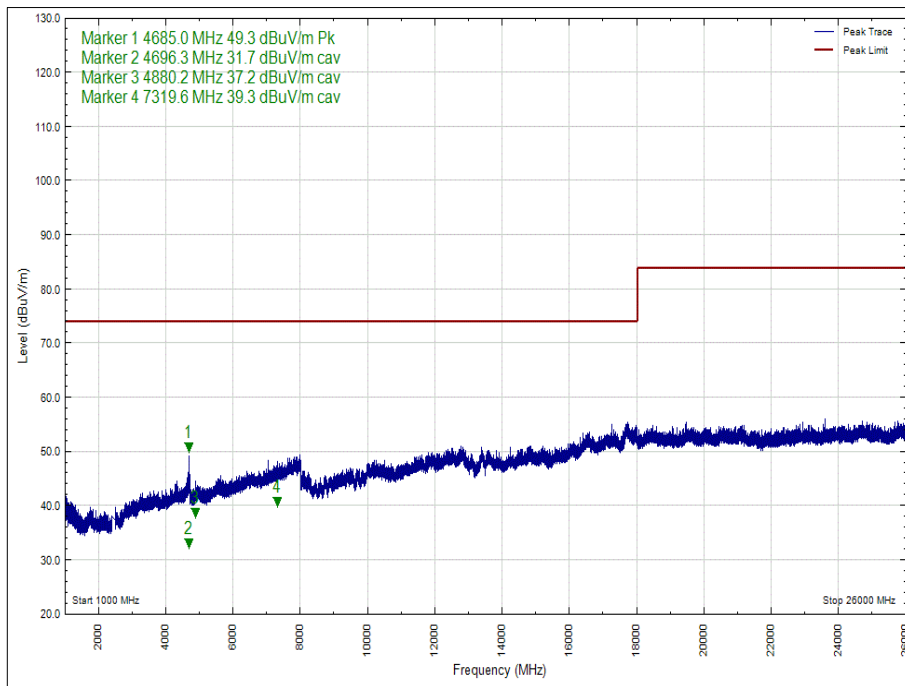

Figure 49 - 2441 MHz - 1 GHz to 26 GHz, Polarity: Horizontal, EUT Orientation: Y, Peak

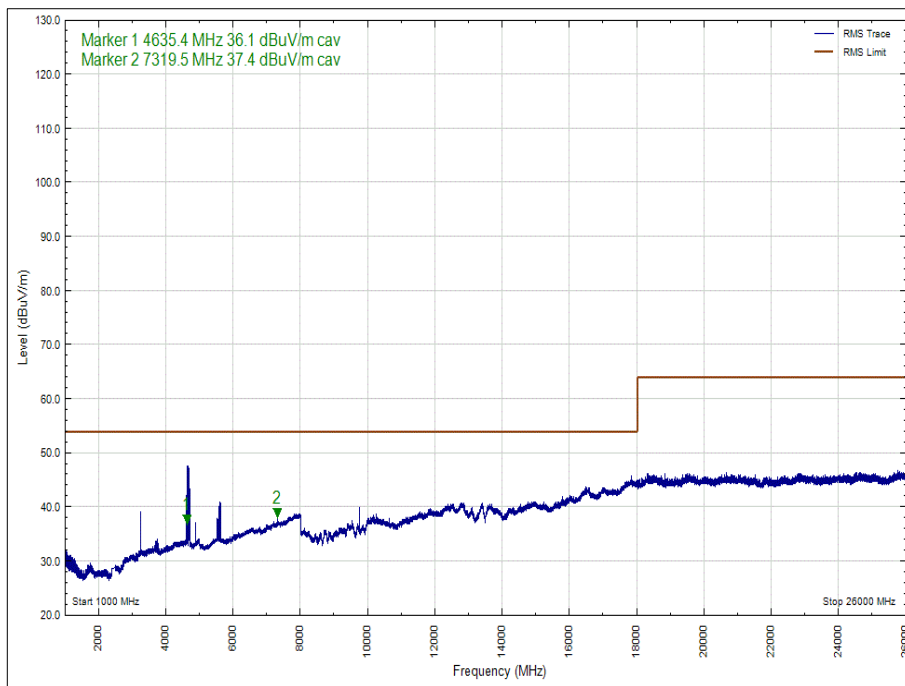

Figure 50 - 2441 MHz - 1 GHz to 26 GHz, Polarity: Vertical, EUT Orientation: Y, Average

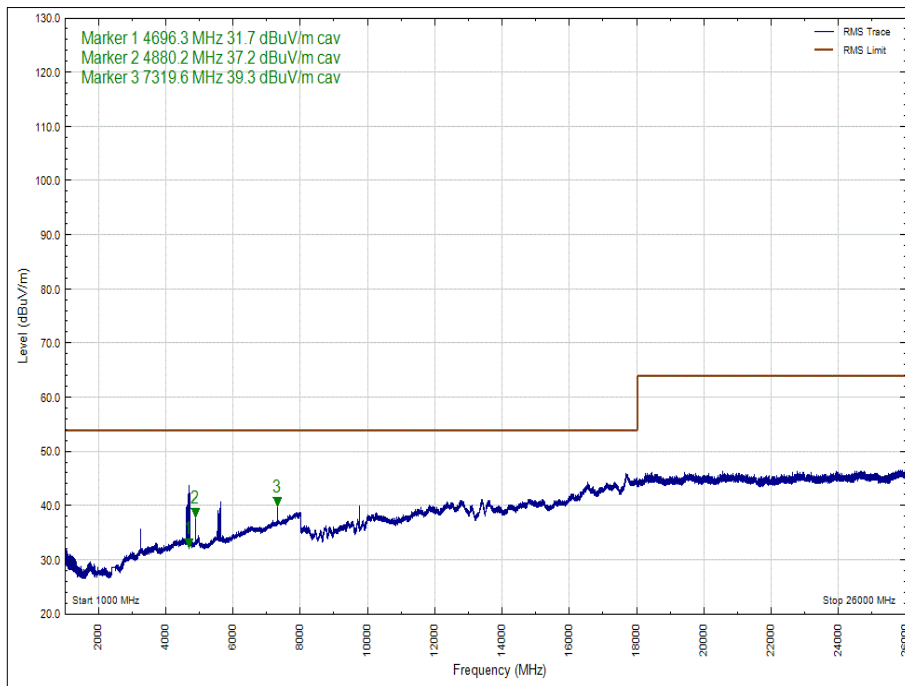

Figure 51 - 2441 MHz - 1 GHz to 26 GHz, Polarity: Horizontal, EUT Orientation: Y, Average

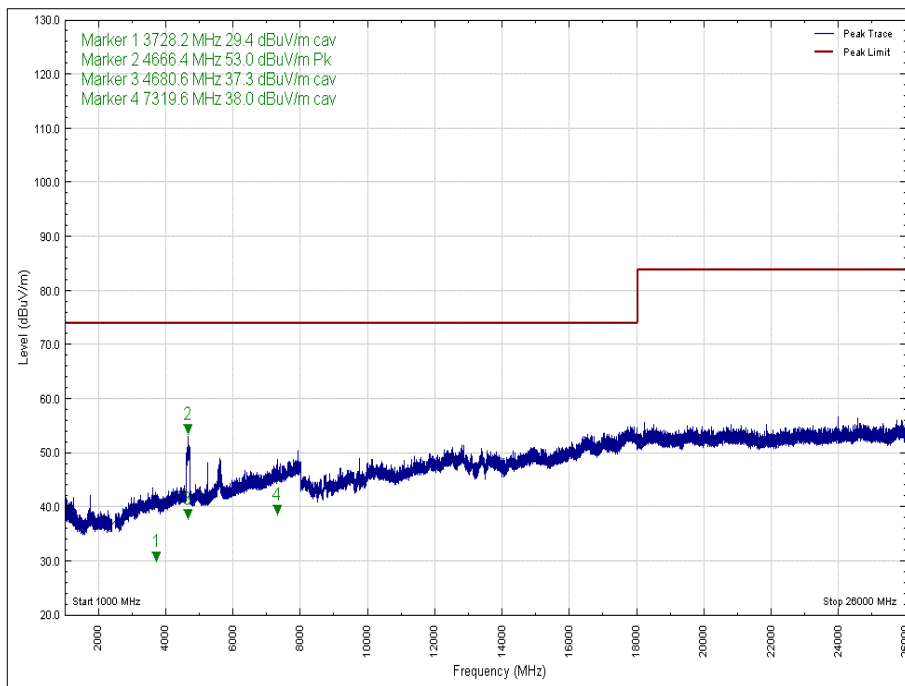

Figure 52 - 2441 MHz - 1 GHz to 26 GHz, Polarity: Vertical, EUT Orientation: Z, Peak

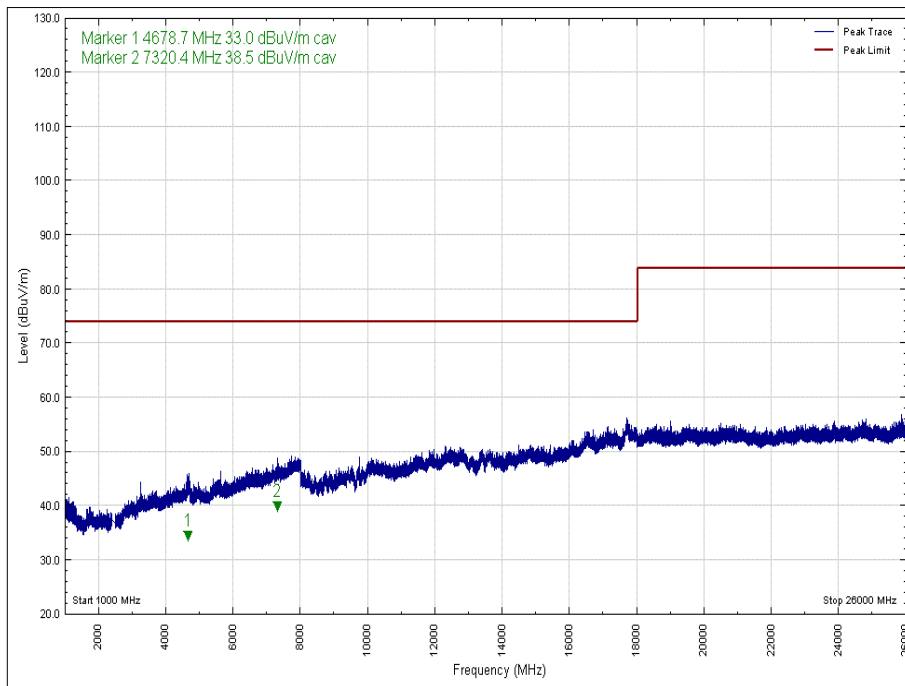

Figure 53 - 2441 MHz - 1 GHz to 26 GHz, Polarity: Horizontal, EUT Orientation: Z, Peak

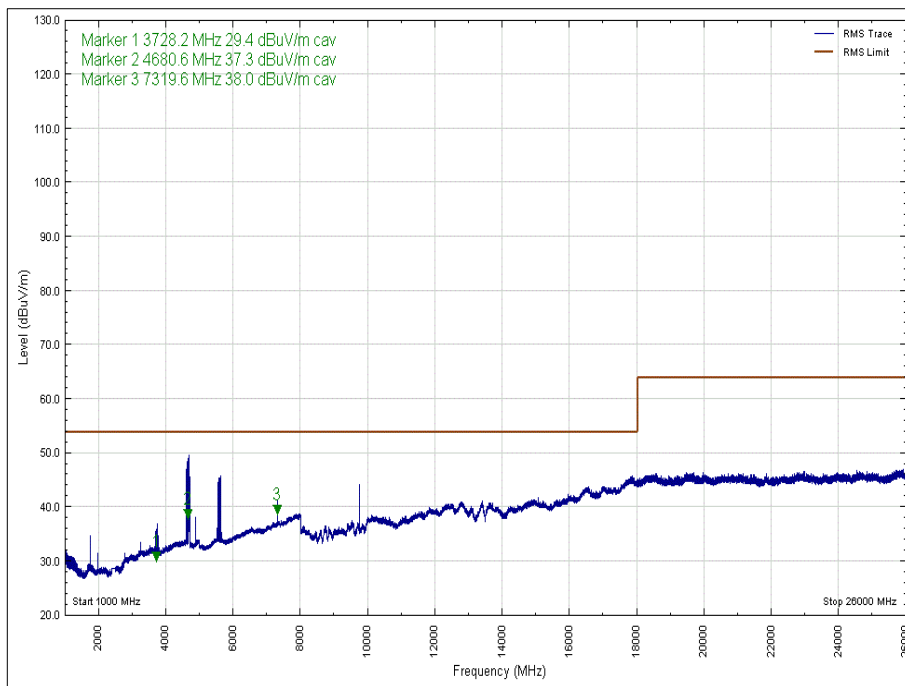

Figure 54 - 2441 MHz - 1 GHz to 26 GHz, Polarity: Vertical, EUT Orientation: Z, Average

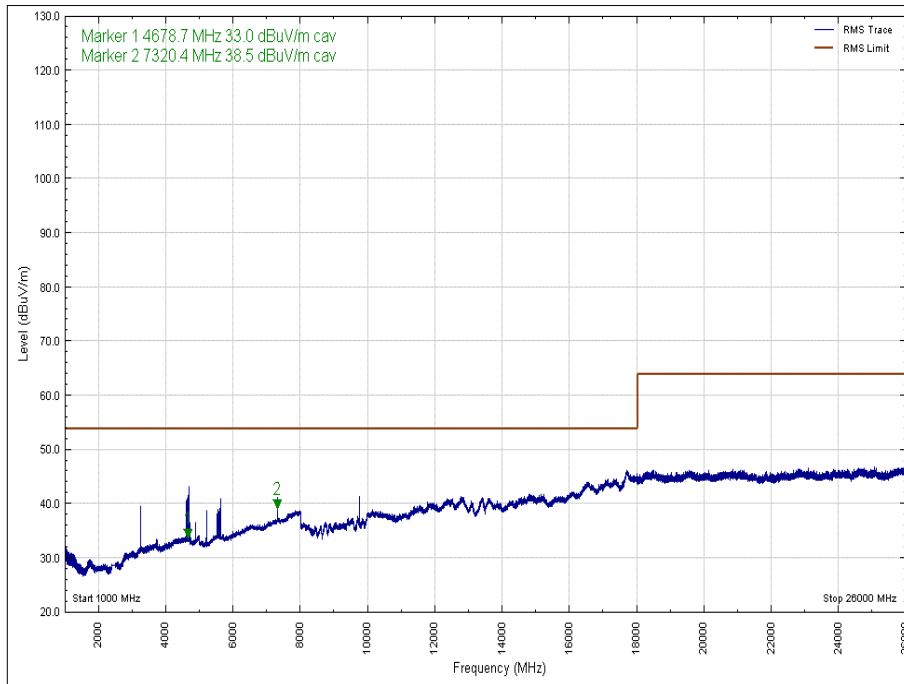

Figure 55 - 2441 MHz - 1 GHz to 26 GHz, Polarity: Horizontal, EUT Orientation: Z, Average



Frequency (MHz)	Level (dB μ V/m)	Limit (dB μ V/m)	Margin (dB)	Detector	Angle (°)	Height (cm)	Polarisation	Orientation
932.000	29.3	46.0	-16.7	Peak	285	124	Vertical	X
938.050	32.9	46.0	-13.1	Peak	301	110	Horizontal	X
924.651	24.7	46.0	-17.2	Peak	65	101	Vertical	Y
934.152	32.9	46.0	-18.1	Peak	4	158	Horizontal	Y
929.523	30.1	46.0	-15.0	Peak	85	339	Vertical	Z
936.810	28.9	46.0	-19.4	Peak	93	294	Horizontal	Z

Table 15 - Radiated Emissions Results, 30 MHz to 1 GHz - 2480 MHz

No other emissions were detected within 10 dB of the limit.

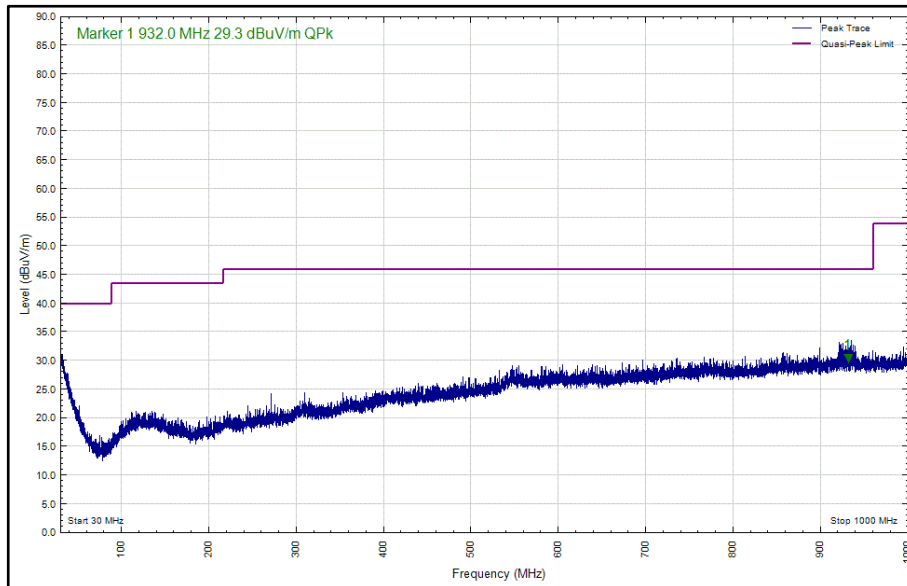

Figure 56 - 30 MHz to 1 GHz, 2480 MHz, Polarity: Vertical, EUT Orientation X

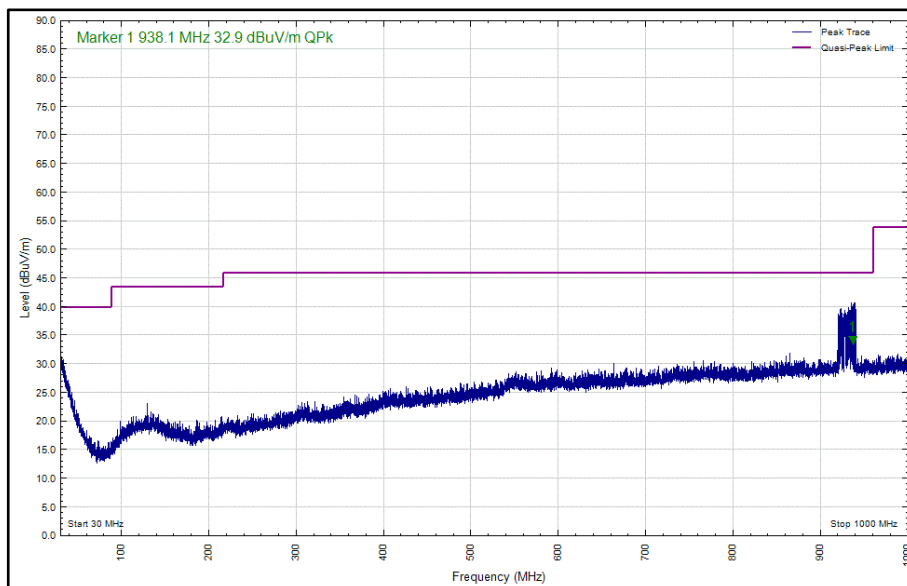

Figure 57 - 30 MHz to 1 GHz, 2480 MHz, Polarity: Horizontal, EUT Orientation X

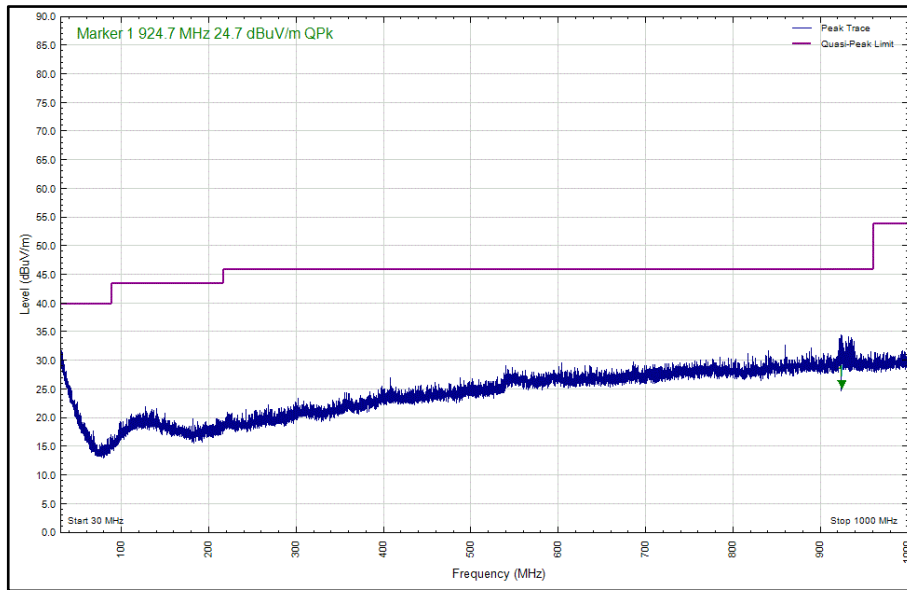

Figure 58 - 30 MHz to 1 GHz, 2480 MHz, Polarity: Vertical, EUT Orientation Y

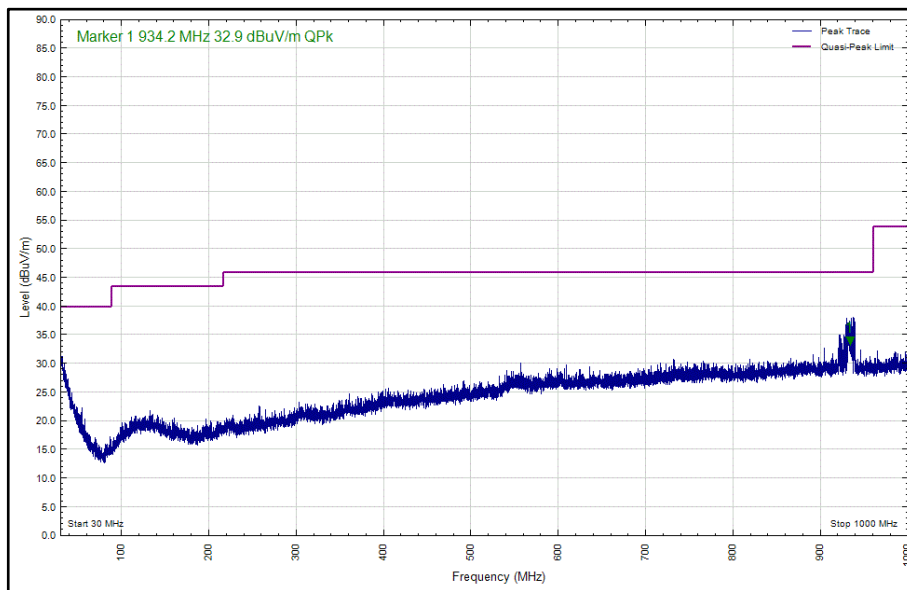

Figure 59 - 30 MHz to 1 GHz, 2480 MHz, Polarity: Horizontal, EUT Orientation Y

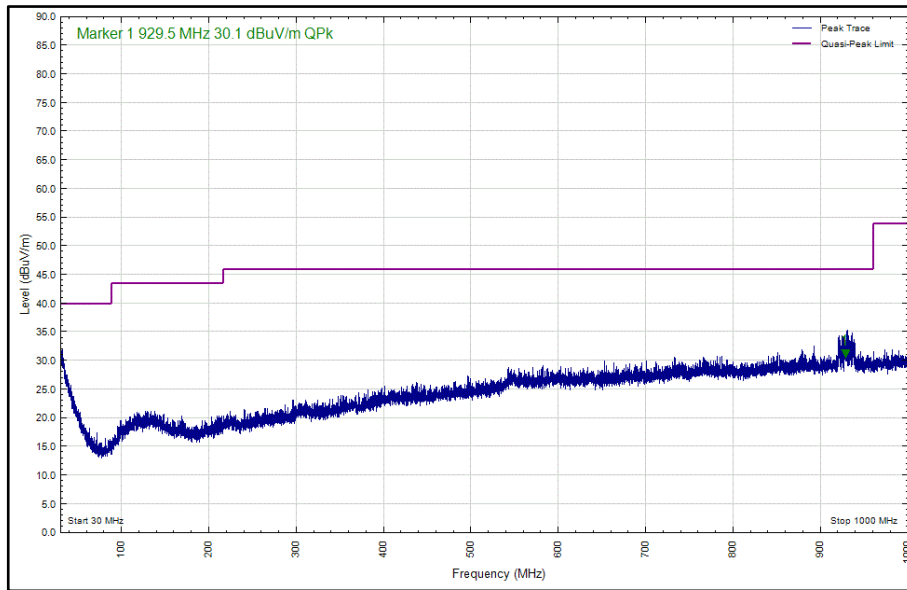

Figure 60 - 30 MHz to 1 GHz, 2480 MHz, Polarity: Vertical, EUT Orientation Z

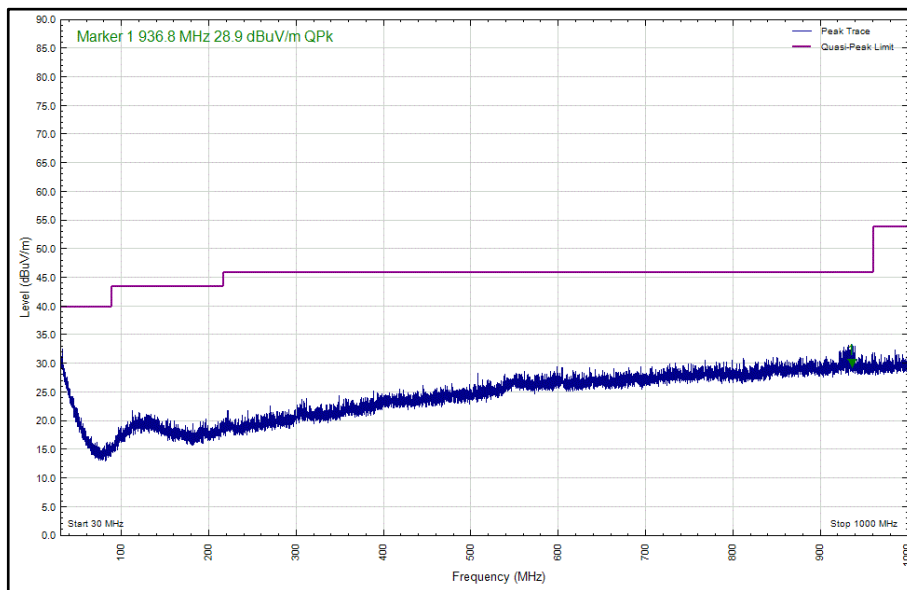

Figure 61 - 30 MHz to 1 GHz, 2480 MHz, Polarity: Horizontal, EUT Orientation Z



Frequency (MHz)	Level (dB μ V/m)	Limit (dB μ V/m)	Margin (dB)	Detector	Angle (°)	Height (cm)	Polarisation	Orientation
4960.247	44.3	54.0	-9.7	Average	58	143	Vertical	X
7439.834	40.9	54.0	-13.1	Average	76	127	Vertical	X
4677.260	37.6	54.0	-16.4	Average	162	113	Horizontal	X
4960.202	45.1	54.0	-9.0	Average	229	108	Horizontal	X
7440.739	37.6	54.0	-16.4	Average	176	102	Horizontal	X
7439.864	35.9	54.0	-18.1	Average	24	210	Vertical	Y
4633.172	36.4	54.0	-17.6	Average	350	100	Vertical	Y
7440.629	39.8	54.0	-14.2	Average	68	130	Horizontal	Y
3306.769	35.2	54.0	-18.8	Average	206	127	Horizontal	Y
4653.484	37.0	54.0	-17.0	Average	10	188	Vertical	Z
7439.654	42.4	54.0	-11.6	Average	64	162	Vertical	Z
7440.449	39.4	54.0	-14.6	Average	335	107	Horizontal	Z

Table 16 - 2480 MHz - 1 GHz to 26 GHz Emissions Results

*No other emissions were detected within 10 dB of the limit.

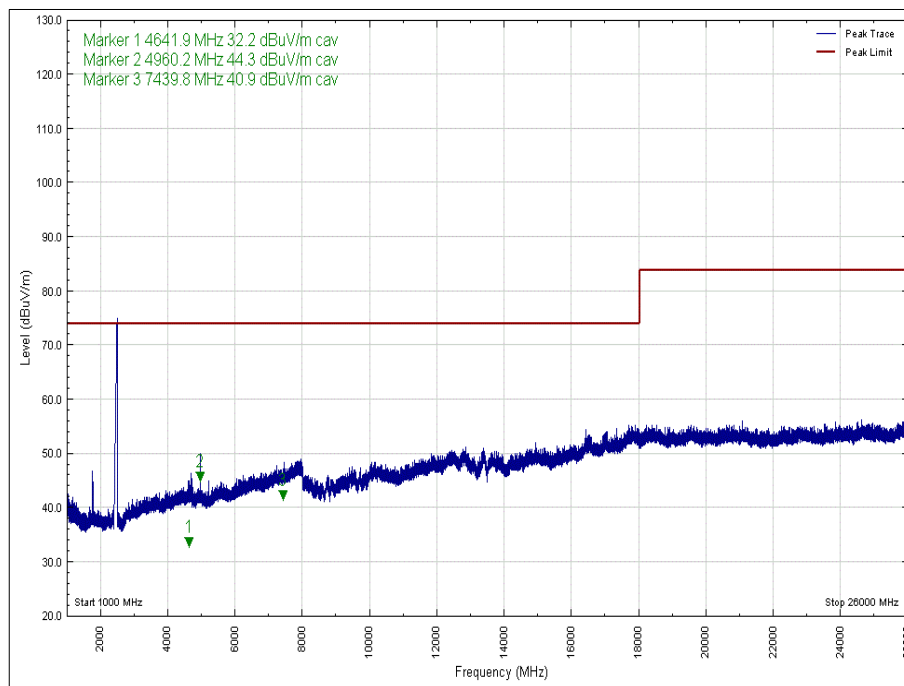

Figure 62 - 2480 MHz - 1 GHz to 26 GHz, Polarity: Vertical, EUT Orientation: X, Peak

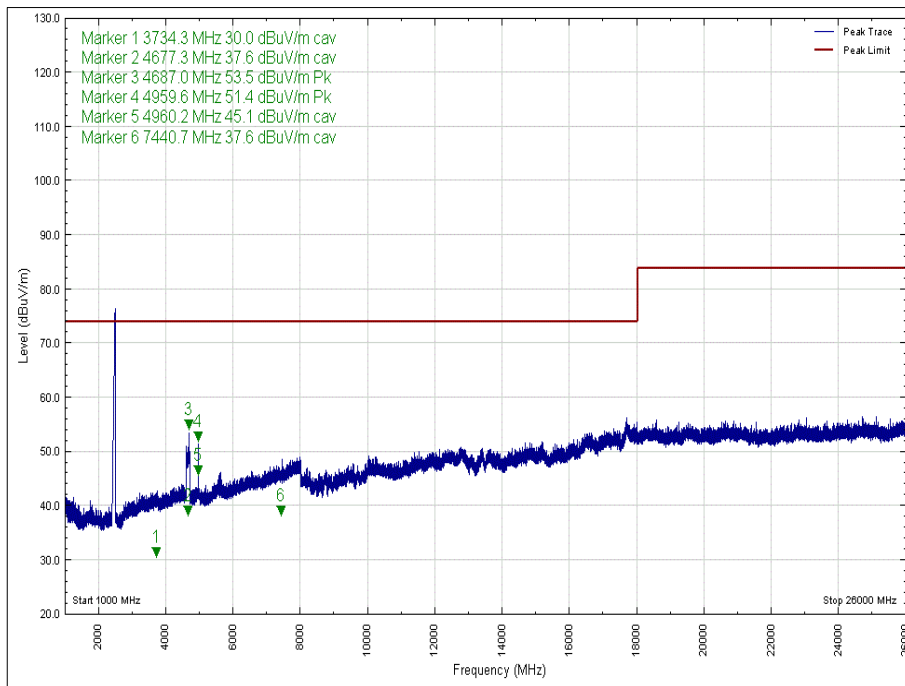

Figure 63 - 2480 MHz - 1 GHz to 26 GHz, Polarity: Horizontal, EUT Orientation: X, Peak

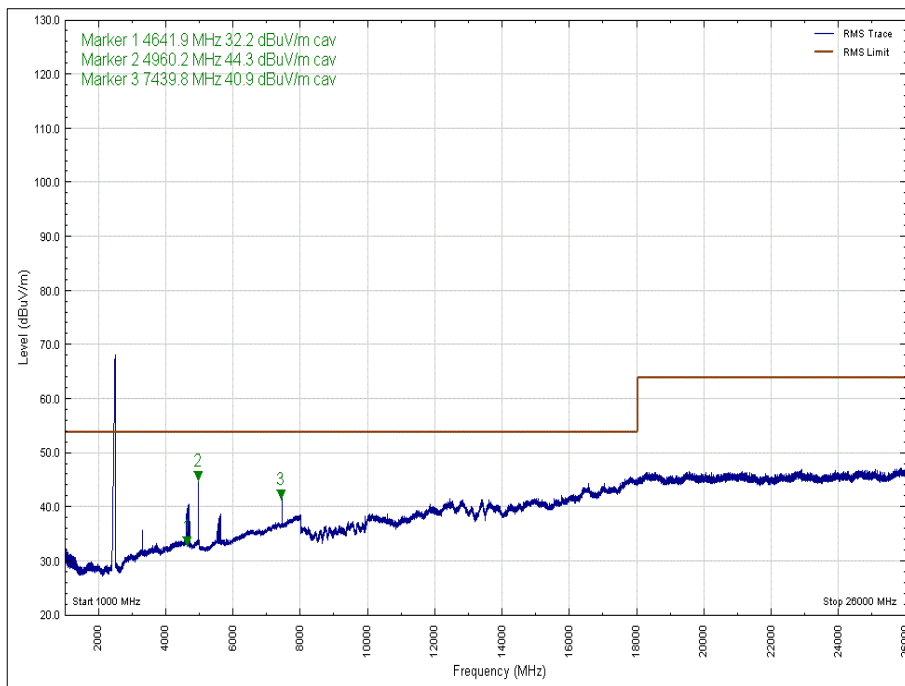

Figure 64 - 2480 MHz - 1 GHz to 26 GHz, Polarity: Vertical, EUT Orientation: X, Average

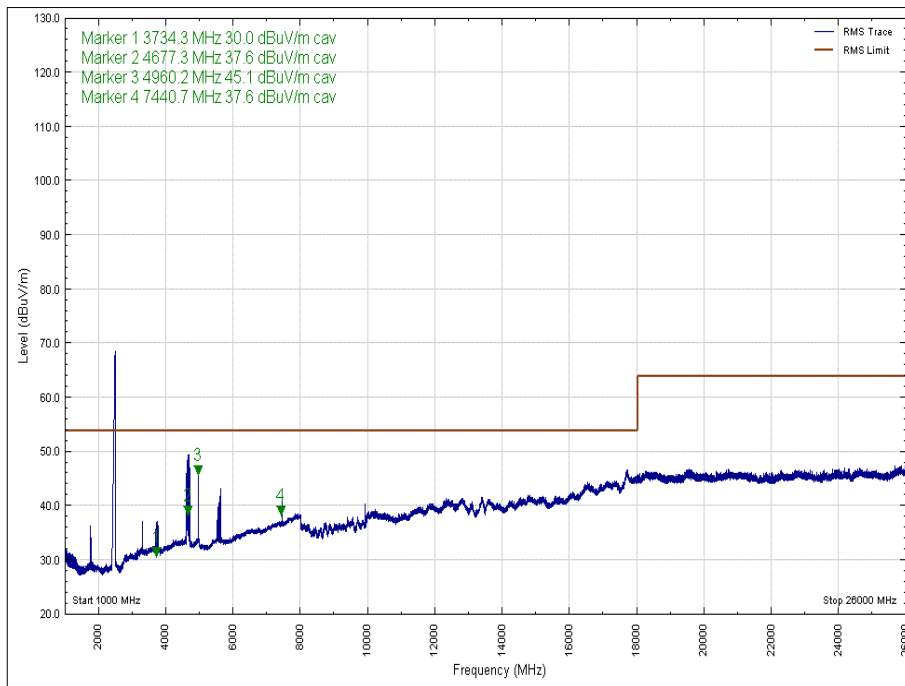

Figure 65 - 2480 MHz - 1 GHz to 26 GHz, Polarity: Horizontal, EUT Orientation: X, Average

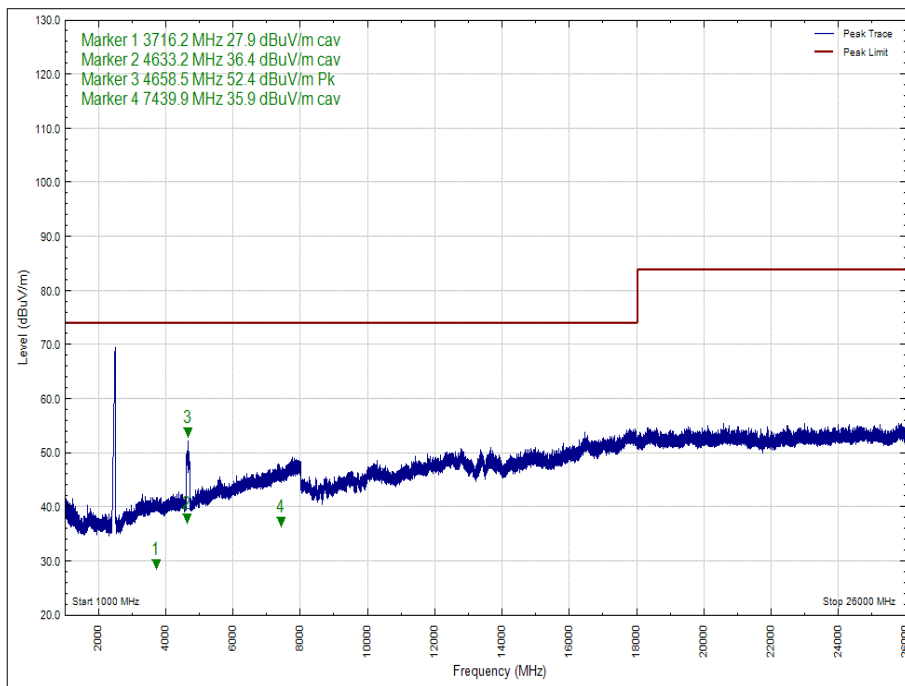

Figure 66 - 2480 MHz - 1 GHz to 26 GHz, Polarity: Vertical, EUT Orientation: Y, Peak

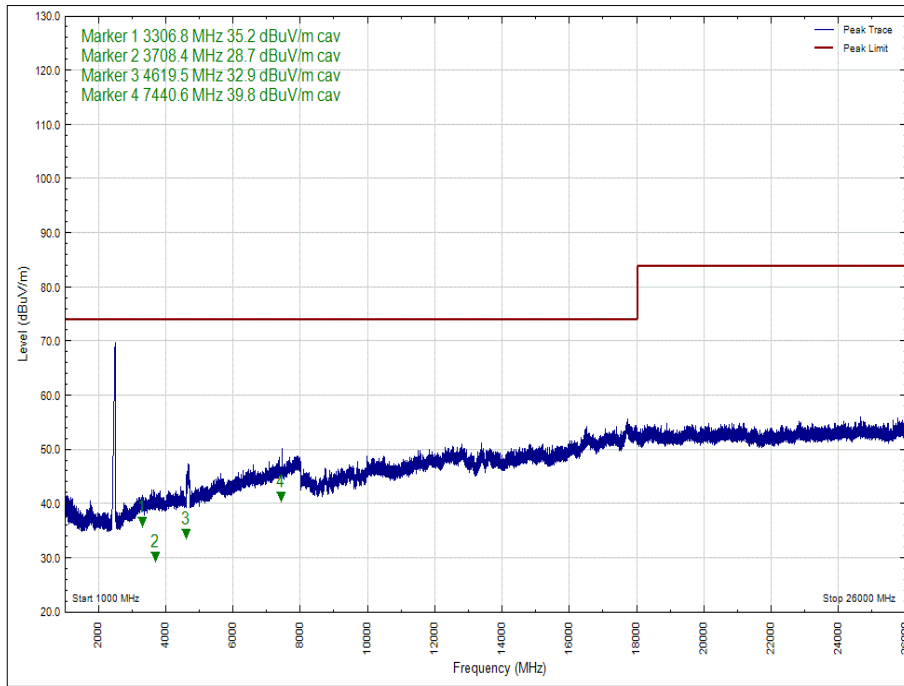

Figure 67 - 2480 MHz - 1 GHz to 26 GHz, Polarity: Horizontal, EUT Orientation: Y, Peak

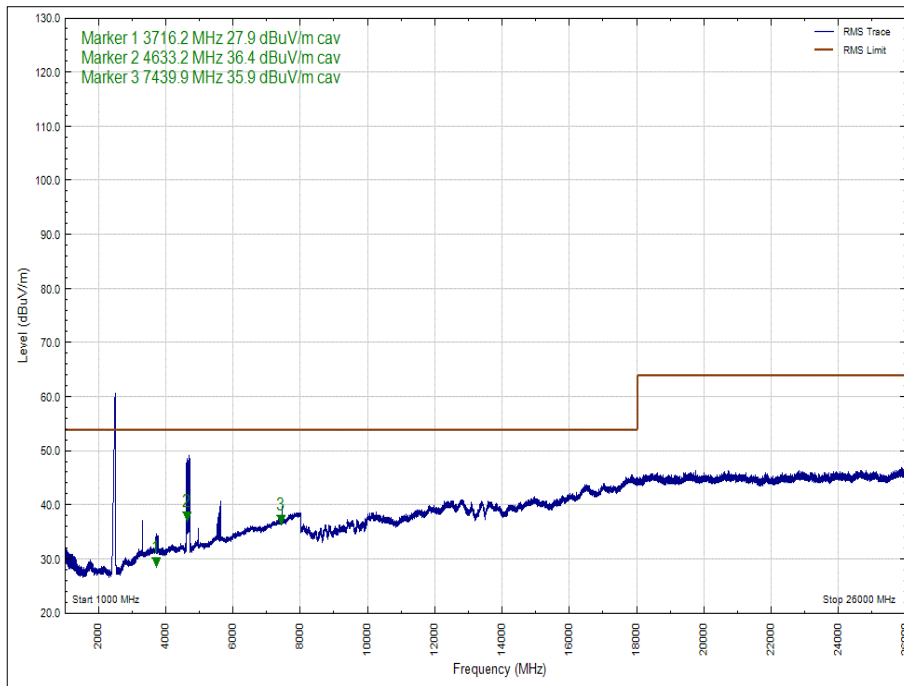

Figure 68 - 2480 MHz - 1 GHz to 26 GHz, Polarity: Vertical, EUT Orientation: Y, Average

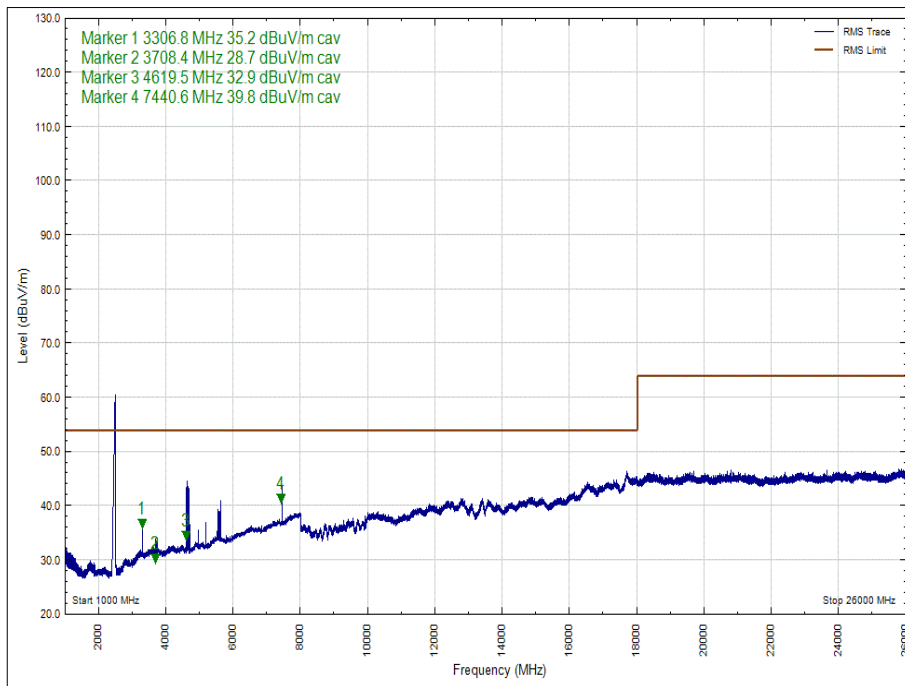

Figure 69 - 2480 MHz - 1 GHz to 26 GHz, Polarity: Horizontal, EUT Orientation: Y, Average

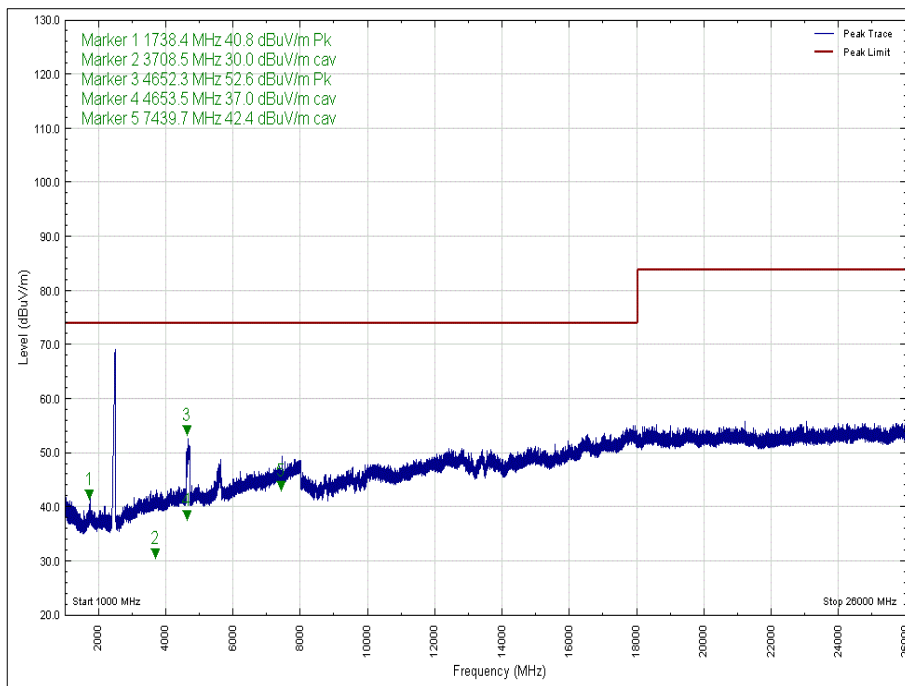

Figure 70 - 2480 MHz - 1 GHz to 26 GHz, Polarity: Vertical, EUT Orientation: Z, Peak

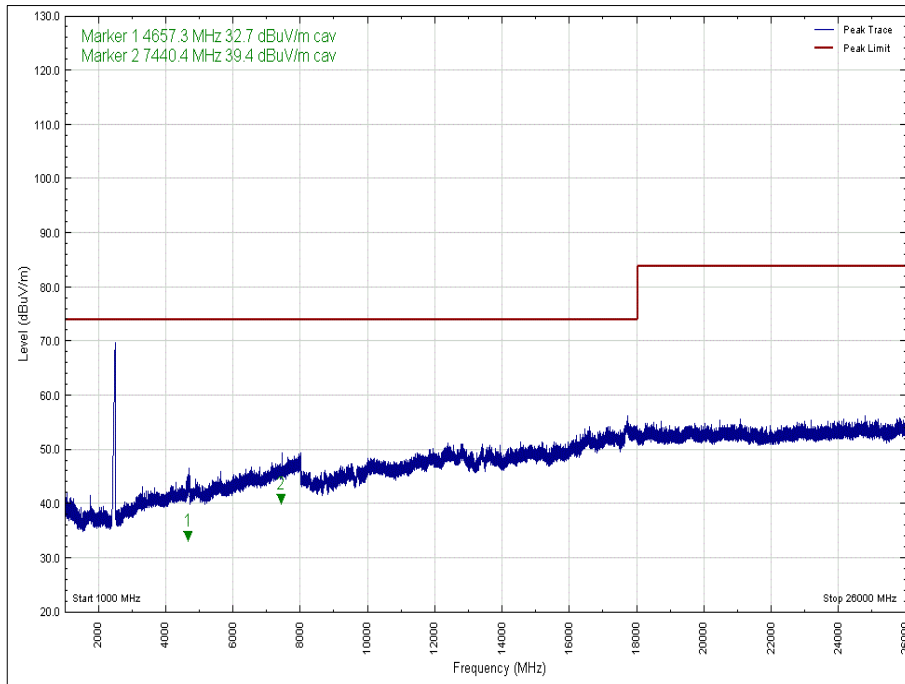

Figure 71 - 2480 MHz - 1 GHz to 26 GHz, Polarity: Horizontal, EUT Orientation: Z, Peak

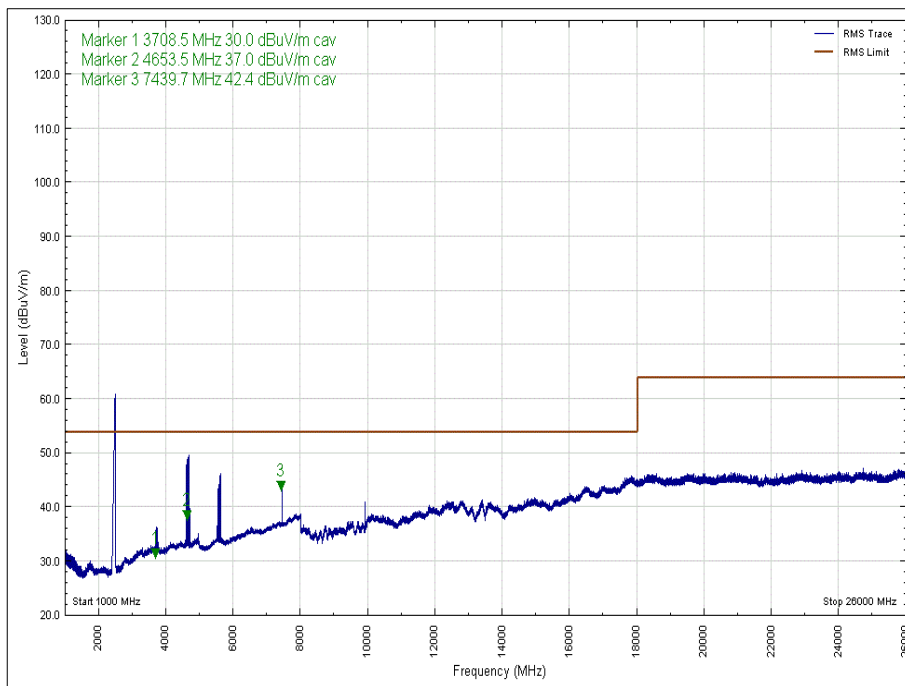

Figure 72 - 2480 MHz - 1 GHz to 26 GHz, Polarity: Vertical, EUT Orientation: Z, Average

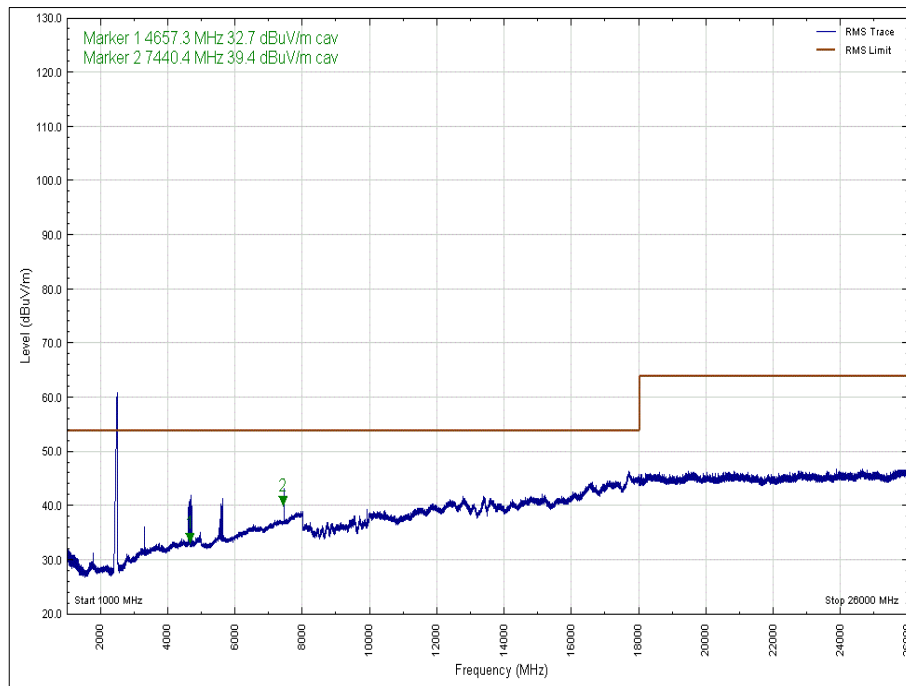

Figure 73 - 2480 MHz - 1 GHz to 26 GHz, Polarity: Horizontal, EUT Orientation: Z, Average



FCC 47 CFR Part 15, Limit Clause 15.247 (d)

In any 100 kHz bandwidth outside the frequency band in which the spread spectrum or digitally modulated intentional radiator is operating, the radio frequency power that is produced by the intentional radiator shall be at least 20 dB below that in the 100 kHz bandwidth within the band that contains the highest level of the desired power, based on either an RF conducted or a radiated measurement, provided the transmitter demonstrates compliance with the peak conducted power limits. If the transmitter complies with the conducted power limits based on the use of RMS averaging over a time interval, as permitted under paragraph (b)(3) of this section, the attenuation required under this paragraph shall be 30 dB instead of 20 dB.

Attenuation below the general limits specified in § 15.209(a) is not required. In addition, radiated emissions which fall in the restricted bands, as defined in § 15.205(a), must also comply with the radiated emission limits specified in 15.209(a)

ISED RSS-247, Limit Clause 5.5

In any 100 kHz bandwidth outside the frequency band in which the spread spectrum or digitally modulated device is operating, the RF power that is produced shall be at least 20 dB below that in the 100 kHz bandwidth within the band that contains the highest level of the desired power, based on either an RF conducted or a radiated measurement, provided that the transmitter demonstrates compliance with the peak conducted power limits. If the transmitter complies with the conducted power limits based on the use of root-mean-square averaging over a time interval, as permitted under Section 5.4(4), the attenuation required shall be 30 dB instead of 20 dB. Attenuation below the general field strength limits specified in RSS-Gen is not required.



2.3.7 Test Location and Test Equipment Used

This test was carried out in EMC Chamber 5.

Instrument	Manufacturer	Type No	TE No	Calibration Period (months)	Calibration Due
Antenna 18-40GHz (Double Ridge Guide)	Link Microtek Ltd	AM180HA-K-TU2	230	24	2-May-2020
Filter (High Pass)	Lorch	SHP7-7000-SR	566	12	06-Jun-2020
Pre-Amplifier	Phase One	PS04-0086	1533	12	08-Feb-2020
18GHz - 40GHz Pre-Amplifier	Phase One	PSO4-0087	1534	12	05-Feb-2020
Turntable Controller	Inn-Co GmbH	CO 1000	1606	-	TU
Hygrometer	Rotronic	A1	2677	12	20-Feb-2020
'2.92mm' - '2.92mm' RF Cable (2m)	Rhophase	KPS-1503-2000-KPS	3695	12	11-Jun-2020
High Pass Filter (4GHz)	K&L Microwave	11SH10-4000/X18000-0/0	4599	12	05-Sep-2020
Double Ridged Waveguide Horn Antenna	ETS-Lindgren	3117	4722	12	05-Mar-2020
Mast Controller	Maturo GmbH	NCD	4810	-	TU
Double Ridge Broadband Horn Antenna	Schwarzbeck	BBHA 9120 B	4848	12	11-Mar-2020
Band Reject Filter - 2.425 GHz	Wainwright	WRCGV14-2390-2400-2450-2460-50SS	5067	12	01-Oct-2020
Band Reject Filter - 2.4585 GHz	Wainwright	WRCGV14-2423.5-2433.5-2483.5-2493.5-50SS	5069	12	01-Oct-2020
1.5m 40GHz RF Cable	Scott Cables	KPS-1501-2000-KPS	5127	6	20-Jan-2020
8 Meter Cable	Teledyne	PR90-088-8MTR	5212	12	30-Aug-2020
Preamplifier (30dB 1GHz to 18GHz)	Schwarzbeck	BBV 9718 C	5261	12	26-Mar-2020
EMI Test Receiver	Rohde & Schwarz	ESW44	5382	12	08-Oct-2020

Table 17

TU – Traceability Unscheduled

3 Photographs

3.1 Test Setup Photographs

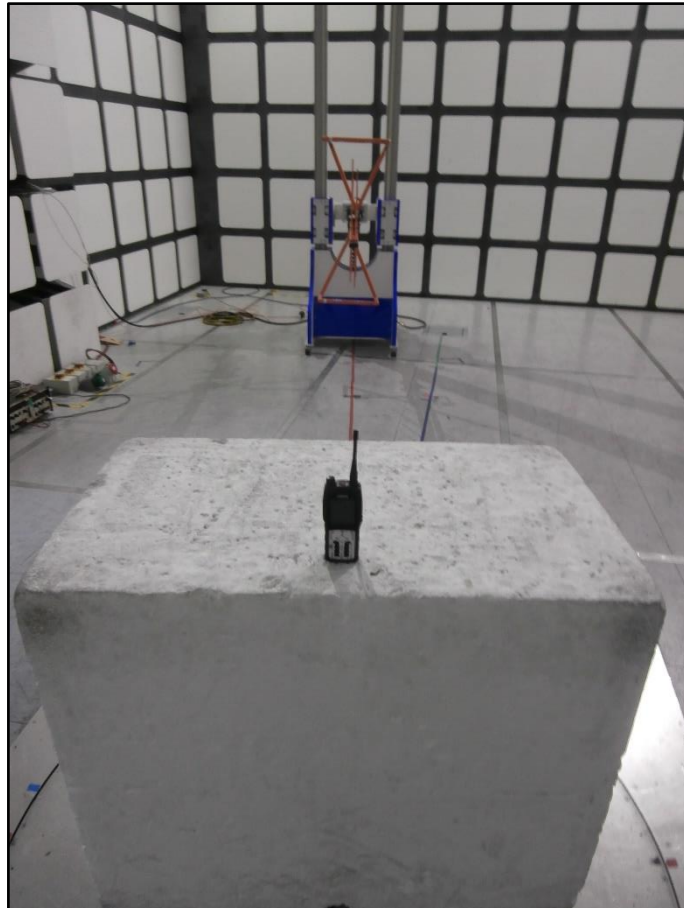

Figure 74 – 30 MHz to 1 GHz

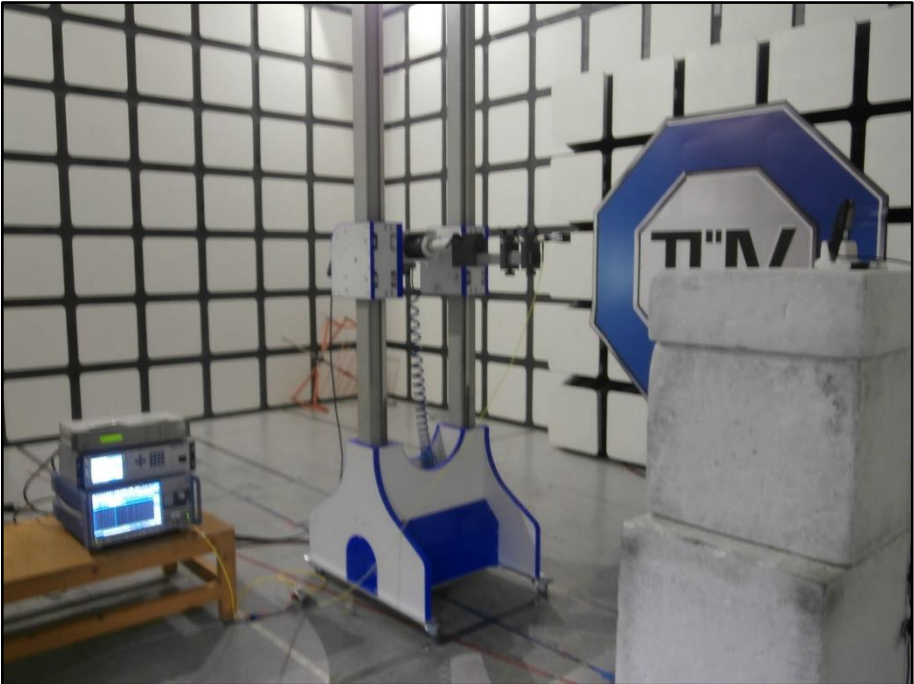

Figure 75 – 1 GHz to 26 GHz



4 Measurement Uncertainty

For a 95% confidence level, the measurement uncertainties for defined systems are:

Test Name	Measurement Uncertainty
Spurious Radiated Emissions	30 MHz to 1 GHz: ± 5.2 dB 1 GHz to 40 GHz: ± 6.3 dB
Restricted Band Edges	30 MHz to 1 GHz: ± 5.2 dB 1 GHz to 40 GHz: ± 6.3 dB
Authorised Band Edges	30 MHz to 1 GHz: ± 5.2 dB 1 GHz to 40 GHz: ± 6.3 dB

Table 18

Measurement Uncertainty Decision Rule

Determination of conformity with the specification limits is based on the decision rule according to IEC Guide 115: 2007, clause 4.4.3 and 4.5.1.