





Test Report

Test Report No.:	KTI13EF02003		
Registration No.:	99058		
Applicant:	UNION COMMUNITY Co.,Ltd.		
Applicant Address:	5F, Hyundai Topics bldg., 44-3, Bangi-dong, Songpa-gu, Seoul, 138-050, Korea		
Product:	Card Reader		
FCC ID:	XX2-VS-R20RF	Model No.	VS-R20 RF
Receipt No.:	13-0103	Date of receipt:	January 21, 2013
Date of Issue:	February 15, 2013		
Testing location	Korea Technology Institute Co., Ltd. 51-19, Sanglim3-Ri, Docheok-Myeun, Gwangju-Shi, Gyeongki-Do, Korea		
Test Standards:	FCC/ANSI. C63.4: 2003		
Rule Parts: FCC	Part 15, Class B		
Equipment Class:	Digital device		
Test Result:	The above-mentioned product has been tested with compliance.		
Tested by: T.J. Kim / Engineer  Signature Date February 18, 2013		Approved by: G. C. Min /President  Signature Date February 18, 2013	
Other Aspects:			
Abbreviations:	* OK, Pass=passed * Fail=failed * N/A=not applicable		
- This test report is not permitted to copy partly without our permission. - This test result is dependent on only equipment to be used. - This test result is based on a single evaluation of one sample of the above mentioned. - This test report must not be used by the client to claim product endorsement by NVLAP or any agency of the U.S Government. - We certify this test report has been based on the measurement standards that is traceable to the national or international standards.			



>> Contents <<

Contents	2
List of Tables	2
List of Figures	2
List of Photographs	2
1. General	4
2. Test Site	4
2.1 Location	4
2.2 List of Test and Measurement Instruments	4
2.3 Test Date	5
2.4 Test Environment	5
3. Description of the tested samples	6
3.1 Rating and Physical characteristics	6
3.2 Submitted documents	6
4. Measurement conditions	7
4.1 Modes of operation	7
4.2 Additional Equipment	7
4.3 Uncertainty	7
4.4 Test Setup	8
5. TEST AND MEASUREMENTS	9
5.1 Antenna Requirement	9
5.1.1 Regulation	9
5.1.2 Results	9
5.2 Emission Test	10
5.2.1 Conducted Emissions	10
5.2.2 Radiated Emissions	14
5.2.2.1 Regulation	14
5.2.2.2 Measurement Procedure	14
5.2.2.3 Calculation of the field strength limits below 30 MHz	15
5.2.2.4 Test Results	16
5.2.2.5 Calculation of the field strength limits above 30 MHz	18
5.2.2.6 Test Results	18



»» **Contents** ««

5.	5.3 Occupied bandwidth	19
	5.3.1 Measurement Procedure	19
	5.3.2 Test Results	19
6.	Photograph of the Test Set-Up	20

>> List of Tables

Table 1	List of test and measurement equipment	5
Table 2	Test Data. Conducted Emissions	13,
Table 3	Test Data, Fundamental Frequency (Ver / Hor)	16
Table 4	Test Data, Radiated Emission below 30 MHz	16
Table 5	Test Data, Radiated Emission above 30 MHz	18

>> List of Figures

Figure 1	Test Setup_Adaptor Mode	8
Figure 2	Spectral Diagram, LINE-PE	11
Figure 3	Spectral Diagram, NEUTRAL-PE	12
Figure 4	Radiated spurious emissions below 30 MHz	17
Figure 5	Occupied Bandwidth	19

>> List of Photographs

Photograph 1	Setup for conducted Emissions	20
Photograph 2	Setup for radiated Emissions	21



1. General

This equipment has been shown to be capable of compliance with the applicable technical standards and was tested in accordance with the measurement procedures as indicated in this report.

We attest to the accuracy of data. Korea Technology Institute Co., Ltd. performed all measurements reported herein. And were made under Chief Engineer's supervisor.

We assume full responsibility for the completeness of these measurements and vouch for the qualifications of all persons taking them.

2. Test Site

Korea Technology Institute Co., Ltd.

Location

51-19, Sanglim3-Ri, Docheok-Myeun, Gwangju-Shi, Gyeongki-Do, Korea

The Test Site is in compliance with ANSI C63.4/2003 for measurement of radio Interference.



List of Test and Measurement Instruments

Table 1: List of Test and Measurement Equipment

- Conducted Emissions

Kind of Equipment	Type	S/N	Calibrated until
Field Strength Meter	ESIB40	100093	05.2013
LISN	KNW407	8-1157-2	03.2013
LISN	EM-7823	115019	03.2013
Conducted Cable	N/A	N/A	11.2013

- Radiated Emissions

Kind of Equipment	Type	S/N	Calibrated until
Field Strength Meter	ESIB40	100093	05.2013
Loop Antenna	6502	3434	03.2014
Biconic Logarithmic Periodic Antenna	VULB9163	9163-281	10.2014
Horn Antenna	3115	6443	10.2014
Open Site Cable	N/A	N/A	11.2013
Antenna Master	DETT-03	N/A	N / A
Antenna & Turntable controller	DETT-04	91X519	N / A

Test Date

Date of Application: January 21, 2013

Date of Test: January 25, 2012

Test Environment

Indoor: 18°C/42%/1000mbar

Outdoor: -7°C/48%/1000mbar



3. Description of the tested samples

The EUT is Card Reader.

3.1 Rating and Physical Characteristics

Item	Spec	Description
CPU	32bit RISC 72MHz	ST Micro
Pin Pad	4key	F1~F4
LED	3 LED (Red, White, Blue), 4 LED (key_Led)	
Flash	Internal 256k Byte , External 8Mbyte	Nor Flash
Number of enrolled users	10,000 users 50,000 Log	
Voice Message	Various languages supported (Possible to download from PC) Possible to control volume	
Buzzer Sound	Possible to control volume	
Card Module	125KHz RF 13.56MHz Smart (1 Sam Card Socket Support) 125KHz HID Card	
Authentication Method	Card	
RTC	Internal RTC Support	
I/O	6 Dip Switch (485 ID Setting : 3pole, 485<->Wiegand In/Out change 1pole BLC015/BLC020/CP040 Select 2pole)	
Lock Control	- If POE is supported, separate lock Controller is used - If POE is supported, EM, Strike, Motor Lock are possible to use	
RS-485	1 Port	Interworking with 485 Controller
Wiegand-In	1 Port	Interworking with Wiegand-Type card reader
Wiegand-Out	1 Port	Display Wiegand signal output or success/fail
RS-232	3 Port	Debug
Power	12 VDC	

3.2 Submitted Documents

- User's Guide
- Block Diagram



4. Measurement Conditions

Testing Input Voltage: AC 110V/60Hz

Modes of Operation

The EUT was in the following operation mode during all testing;

Prior to a measurement, the Instruments of education shall be operated until stabilization has been reached.

4.2 Additional Equipment

DEVICE TYPE	Manufacturer	M/N	S/N	FCC ID
Lock Controller	UNION COMMUNITY Co.,Ltd.	ViRDI LC010	UNF00158701	DOC

4.3 Uncertainty

1) Radiated disturbance

U_c (Combined standard Uncertainty) = $\pm 1.8dB$

Expanded uncertainty $U=KU_c$

$K = 2$

$\therefore U = \pm 3.6dB$

2) Conducted disturbance

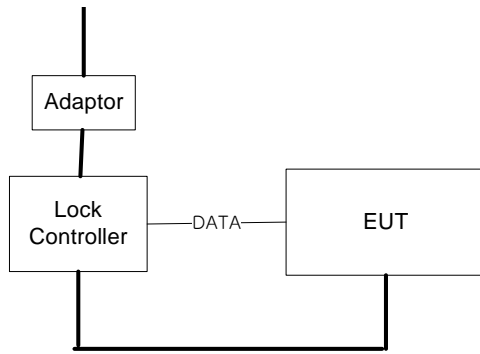
$U_c = \pm 0.88dB$

$U = KU_c=2 \times U_c = \pm 1.8dB$



4.4 Test Setup

Figure 1: Test Setup



— SIGNAL
— AC
— POWER



5. TEST AND MEASUREMENTS

Summary of Test Results

Requirement	FCC, 47CFR15	Report Section	Test Result
Antenna Requirement	15.203	5.1	PASS
Conducted Emissions Radiated Emissions Field strength 9 kHz to 30 MHz Field strength 30 MHz to 1000 MHz	15.209 & 15.205	5.2	PASS
Occupied bandwidth	-	5.3	-

* According to the Section 15.33(b)(1)&(c), Radiated Emissions & Conducted Emissions were reported in Report No. KTI13EF02007.

5.1 ANTENNA REQUIREMENT

5.1.1 Regulation

FCC 47CFR15 – 15.203

An intentional radiator shall be designed to ensure that no antenna other than that furnished by the responsible party shall be used with the device. The use of a permanently attached antenna or of an antenna that uses a unique coupling to the intentional radiator shall be considered sufficient to comply with the provisions of this Section. The manufacturer may design the unit so that a broken antenna can be replaced by the user, but the use of a standard antenna jack or electrical connector is prohibited. This requirement does not apply to carrier current devices or to devices operated under the provisions of Sections 15.211, 15.213, 15.217, 15.219, or 15.221. Further, this requirement does not apply to intentional radiators that must be professionally installed, such as perimeter protection systems and some field disturbance sensors, or to other intentional radiators which, in accordance with Section 15.31(d), must be measured at the installation site. However, the installer shall be responsible for ensuring that the proper antenna is employed so that the limits in this Part are not exceeded.

5.1.2 Result:

PASS

The transmitter has an integral loop coil antenna that is enclosed within the housing of the EUT, and meets the requirements of this section.



5.2 EMISSION TEST

5.2.1. Conducted Emissions

Result:

Pass

The line-conducted facility is located inside a 2.3M x 3.5M x 5.5M shielded closure.

The shielding effectiveness of the shielded room is in accordance with MIL-Std-285 or NSA 605-05. A 1m x 1.5m wooden table 80cm high is placed 80cm away from the conducting ground plane and 40cm away from the sidewall of the shielded room. Electro-Metroics Model EM-7823 (9kHz-30MHz) 50ohm/50 uH Line-Impedance Stabilization Networks (LISN) are bonded to the shielded room.

The EUT is powered from the Electro-Metroics LISN and the support equipment is powered from the Kyoritsu LISN. Power to the LISN are filtered by a high-current high-insertion loss shield enclosures power line filters (100dB 14kHz-1GHz).

The purpose of the filter is to attenuate ambient signal interference and this filter is also bonded to the shielded enclosure.

All electrical cables are shielded by copper pipe with inner diameter of 1".

If the EUT is a DC-Powered device, power will be derived from the source power supply it normally will be powered from and this supply lines will be connected to the Rohde & Schwarz LISN.

All interconnecting cables more than 1 meter were shortened by non-inductive bundling (serpentine fashion) to a 1-meter length.

Sufficient time for the EUT, Support equipment, and test equipment was allowed in order for them to warm up to their normal operating condition. The RF output of the LISN was connected to the spectrum analyzer to determine the frequency producing the maximum EME from the EUT. The frequency producing the maximum level was reexamined using EMI field Intensity meter (ESIB40). The detector function was set to CISPR quasi-peak mode.

The bandwidth of the receiver was set to 10kHz. The EUT, support equipment, and interconnecting cables were arranged and manipulated to maximize each emission. Each emission was maximized by: switching power lines; varying the mode of operation or resolution; clock or data exchange speed; if applicable; whichever determined the worst-case emission.

Photographs of the worst-case emission can be seen in photograph of conducted test.

Each EME reported was calibrated using self-calibrating mode.



Figure 2: Spectral Diagram_LINE-PE

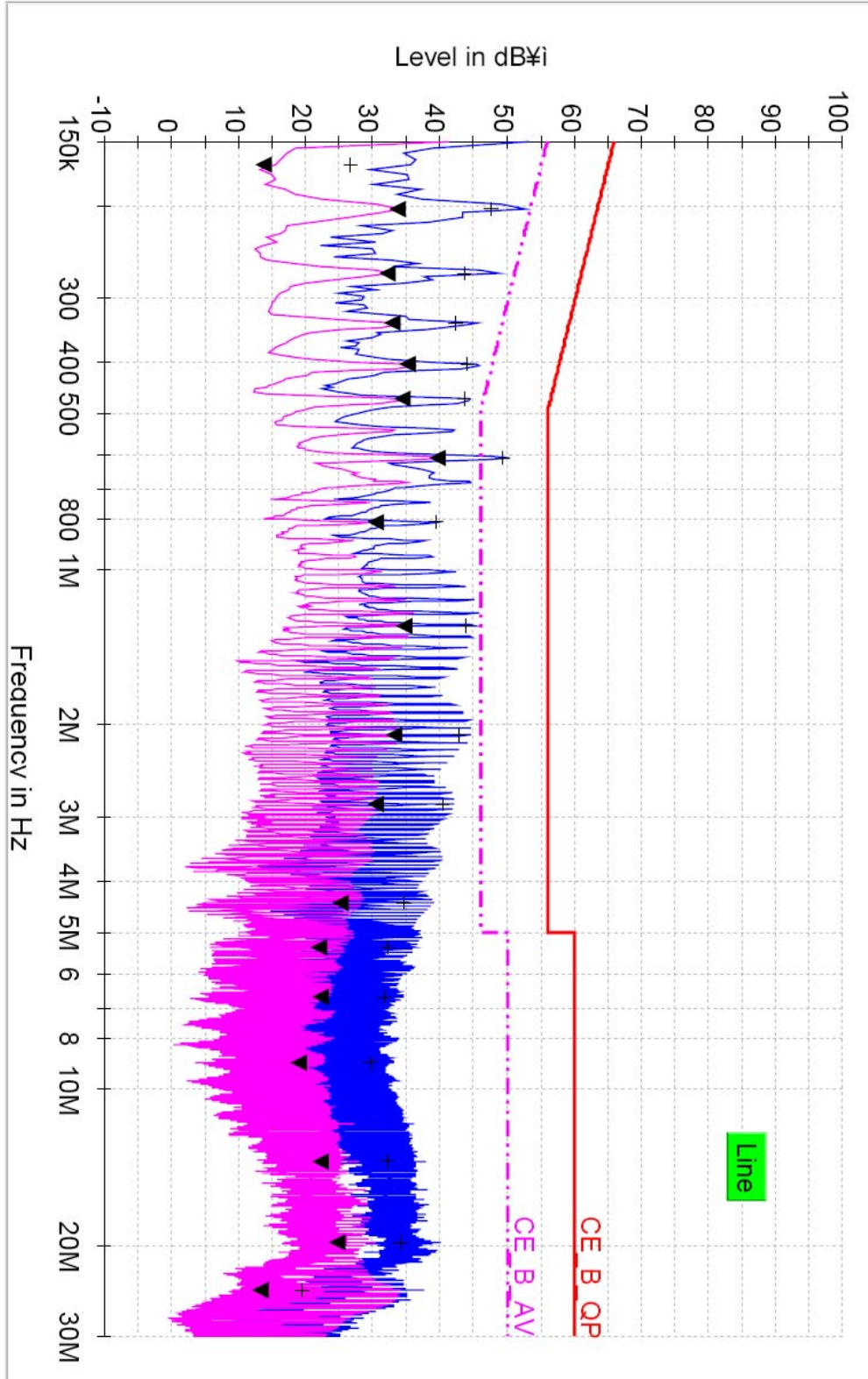




Figure 3: Spectral Diagram_NEUTRAL-PE

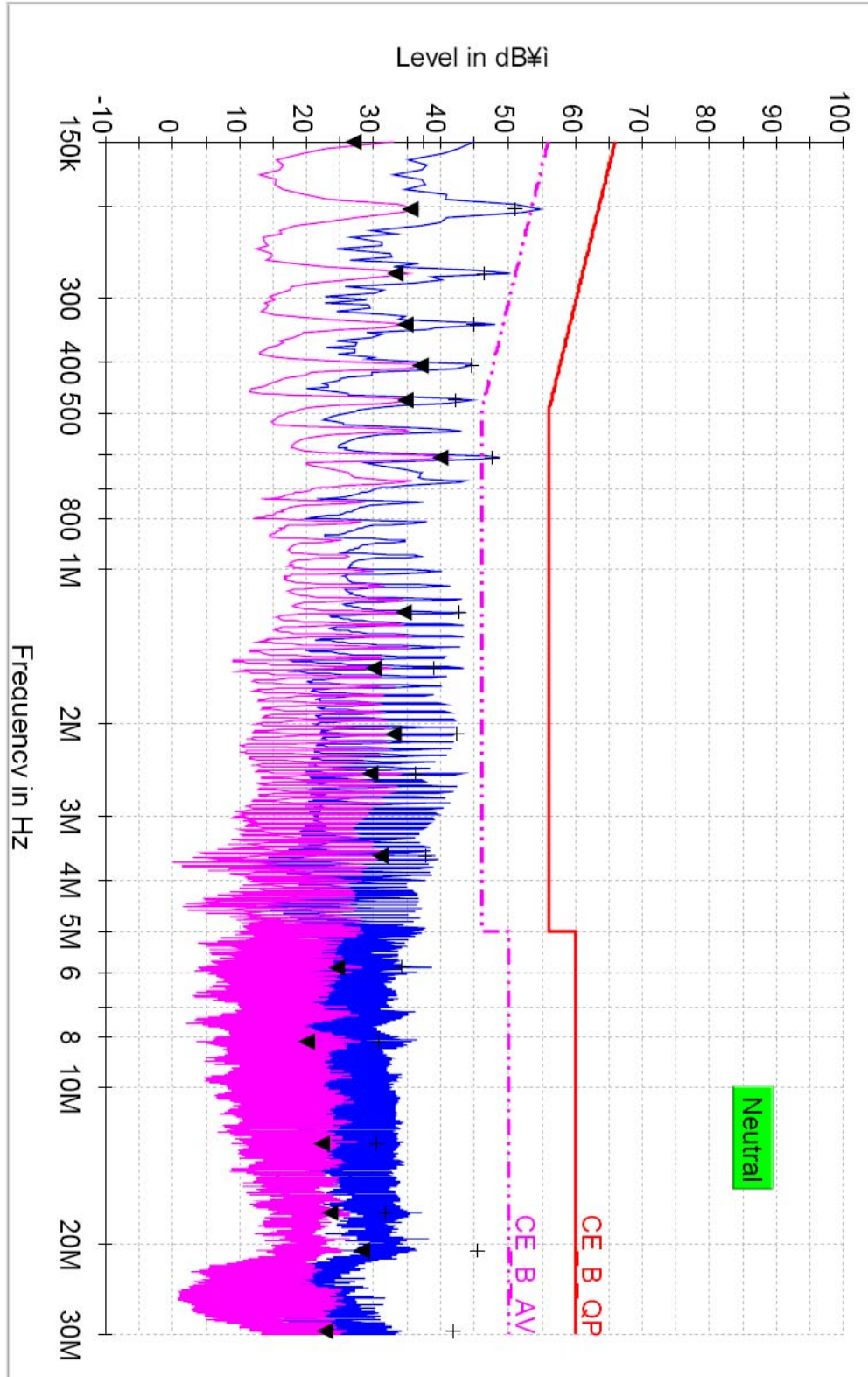




Table 2: Test Data, Conducted Emissions

Frequency (MHz)	(1) Reading (dB μ V)		Line	(2) Limit (dB μ V)		(3) Margin (dB)	
	QP	AV		QP	AV	QP	AV
0.20	51.1	35.4	L2	63.5	53.5	12.4	18.1
0.27	46.5	33.2	L2	61.1	51.1	14.6	17.9
0.61	49.4	39.7	L1	56.0	46.0	16.6	6.3
1.28	43.9	34.7	L1	56.0	46.0	12.1	11.3
20.60	45.3	28.2	L2	60.0	50.0	14.7	21.8
29.47	41.9	22.7	L2	60.0	50.0	18.1	27.3

NOTES:

1. All modes of operation were investigated
And the worst-case emissions are reported.
2. All other emissions are non-significant.
3. All readings are calibrated by self-mode in receiver.
4. Measurements using CISPR quasi-peak mode.
5. L1 = LINE-PE, L2 = NEUTRAL-PE
6. The limit for Class B digital device is 66dBuV to 56dBuV from 150KHz to 500KHz, 56dBuV from 500KHz to 5MHz, 60dBuV Above 5MHz.

◆ Margin Calculation

(3) Margin = (2) Limit – (1) Reading



5.2.2 Radiated Emissions

5.2.2.1 Regulation

FCC 47CFR15 – 15.209

(a) Except as provided elsewhere in this Subpart, the emissions from an intentional radiator shall not exceed the field strength levels specified in the following table:

Frequency (MHz)	Field strength limit (uV/m)	Field strength limit (dBuV/m)	Measurement Distance (m)
0.009 – 0.490	2400/F(kHz)	48.5-13.8	300
0.490 – 1.705	24000/F(kHz)	33.8-23.0	30
1.705 – 30.0	30	29.5	30
30 – 88	100	40.0	3
88 – 216	150	43.5	3
216 – 960	200	46.0	3
Above 960	500	54.0	3

5.2.2.2 Measurement Procedure

Radiated Emissions Test, 9kHz to 30MHz (Magnetic Field Test)

1. The preliminary radiated measurements were performed to determine the frequency producing the maximum emissions at a distance of 3 meters according to Section 15.31(f)(2).
2. The EUT was placed on the top of the 0.8-meter height, 1 x 1.5 meter non-metallic table.
3. Emissions from the EUT are maximized by adjusting the orientation of the Loop antenna and rotating the EUT on the turntable. Manipulating the system cables also maximizes EUT emissions if applicable.
4. To obtain the final measurement data, each frequency found during preliminary measurements was re-examined and investigated. The test-receiver system was set up to average, peak, and quasi-peak detector with specified bandwidth.



Radiated Emissions Test, 30 MHz to 1000 MHz

1. The preliminary radiated measurements were performed to determine the frequency producing the maximum emissions in an anechoic chamber at a distance of 3 meters.
2. The EUT was placed on the top of the 0.8-meter height, 1 x 1.5 meter non-metallic table. To find the maximum emission levels, the height of a measuring antenna was changed and the turntable was rotated 360
3. The antenna polarization was also changed from vertical to horizontal. The spectrum was scanned from 30 to 1000 MHz using the Biconical and Logperiodue broadband antenna,
4. To obtain the final measurement data, the EUT was arranged on a turntable situated on a 4 x 4 meter at the Open Area Test Site. The EUT was tested at a distance 3 meters.
5. Each frequency found during preliminary measurements was re-examined and investigated. The test-receiver system was set up to average, peak, and quasi-peak detector function with specified bandwidth.
6. The presence of ambient signals was verified by turning the EUT off. In case an ambient signal was detected, the measurement bandwidth was reduced temporarily and verification was made that an additional adjacent peak did not exist. This ensures that the ambient signal does not hide any emissions from the EUT

5.2.2.3 Calculation of the field strength limits below 30 MHz

1. No special calculation for obtaining the field strength in dBuV/m is necessary, because the EMI receiver and the active loop antenna operate as a system, where the reading gives directly the field strength result (dBuV/m). The antenna factors and cable losses are already taken into consideration.
2. For test distance other than what is specified, but fulfilling the requirements of section 15.31 (f)(2) the field strength is calculated by adding additionally an extrapolation factor of 40dB/decade (inverse linear distance for field strength measurements).
3. All following emission measurements were performed using the test receiver's average, peak, and quasi-peak detector function with specified bandwidth.



5.2.2.4 Test Results (Test mode : TX on)

PASS

Table 3: Test Data, Fundamental Frequency (Ver / Hor)

Frequency (MHz)	Pol.	Reading (dB μ V)	AFCL (dB/m)	Actual (dB μ V/m)	Limit (dB μ V/m)	Margin (dB)	Detector
0.126	V	49.54	11.96	61.5	105.7	44.2	QP

Frequency (MHz)	Pol.	Reading (dB μ V)	AFCL (dB/m)	Actual (dB μ V/m)	Limit (dB μ V/m)	Margin (dB)	Detector
0.126	H	21.74	11.96	33.7	105.7	72.0	QP

FCC 47CFR15 – 15.209 (9 kHz - 30 MHz)

Table 4: Test Data, Radiated Emission below 30 MHz

Frequency (MHz)	Pol.	Height [m]	Angle [°]	(1) Reading (dB μ V)	(2) AFCL (dB/m)	(3) Actual (dB μ V/m)	(4) Limit (dB μ V/m)	(5) Margin (dB)
0.027	V	1.30	180	35.4	11.7	47.1	118.25	71.15
0.211	V	1.28	178	9.0	10.5	29.5	100.09	70.59
0.686	V	1.28	178	28.3	10.2	38.5	70.34	31.84
0.786	H	1.15	180	27.1	10.1	37.2	69.46	41.50
1.206	V	1.20	181	26.5	10.1	36.6	67.02	30.42
1.234	H	1.20	181	24.0	10.0	34.0	66.96	48.60

Margin (dB) = Limit – Actual
[Actual = FS + AF + CL]

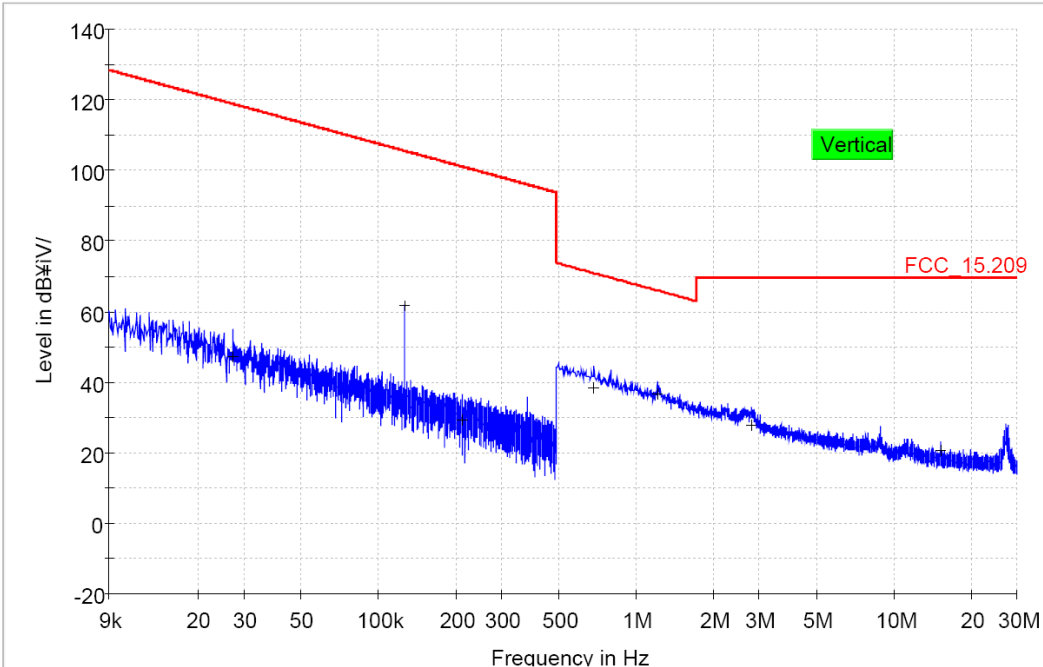
- 1.H = Horizontal, V = Vertical Polarization
- 2.AF/CL = Antenna Factor and Cable Loss
- 3.FS = RA + DF

Where FS = Field strength in dB μ V/m
 RA = Receiver Amplitude in dB μ V/m
 DF = Distance Extrapolation Factor in dB

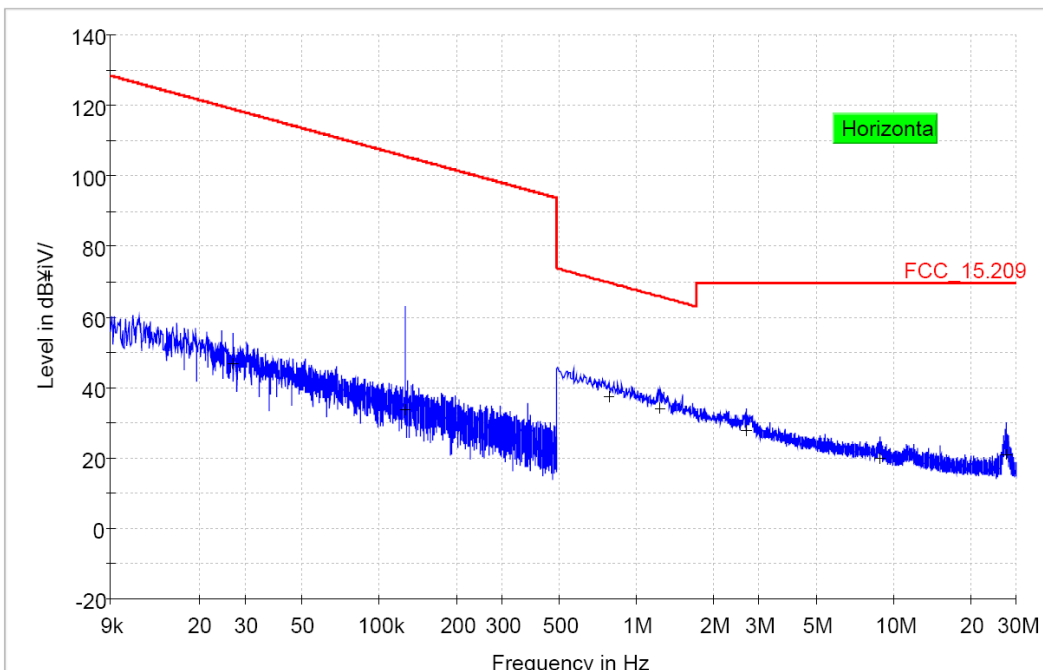


Figure 4: Radiated spurious emissions below 30 MHz

Spurious Emissions from 9 kHz to 30 MHz – Vertical



Spurious Emissions from 9 kHz to 30 MHz – Horizontal





5.2.2.5 Calculation of the field strength limits above 30 MHz

1. No special calculation for obtaining the field strength in dBuV/m is necessary, because the EMI receiver and the active loop antenna operate as a system, where the reading gives directly the field strength result (dBuV/m). The antenna factors and cable losses are already taken into consideration.
2. For test distance other than what is specified, but fulfilling the requirements of section 15.31 (f)(2) the field strength is calculated by adding additionally an extrapolation factor of 40dB/decade (inverse linear distance for field strength measurements).
3. All following emission measurements were performed using the test receiver's average, peak, and quasi-peak detector function with specified bandwidth.

5.2.2.6 Test Results (Test mode : TX on)

PASS

FCC 47CFR15 – 15.209

Table 5: Test Data, Radiated Emission above 30 MHz

Frequency (MHz)	Pol.	Height [m]	Angle [°]	Reading (dBμV)	AFCL (dB/m)	Actual (dBμV/m)	Limit (dBμV/m)	Margin (dB)
44.04	V	1.04	181	12.99	16.21	29.2	40.0	10.8
62.04	V	1.06	182	11.27	15.03	26.3	40.0	13.7
112.00	V	1.14	182	8.88	12.92	21.8	43.5	21.7
144.04	V	1.27	179	15.64	11.86	27.5	43.5	16.0
360.00	H	3.20	179	10.24	21.06	31.3	46.0	14.7
720.00	V	1.85	178	1.94	26.46	28.4	46.0	17.6

FCC 47CFR15-15.205 Restricted Band

Frequency (MHz)	Pol.	Height [m]	Angle [°]	Reading (dBμV)	AFCL (dB/m)	Actual (dBμV/m)	Limit (dBμV/m)	Margin (dB)
38.04	V	1.03	181	9.68	15.42	25.1	40.0	14.9
73.80	V	1.08	180	8.95	12.35	21.3	40.0	18.7
156.84	V	1.25	180	10.95	12.55	23.5	43.5	20.0
168.04	V	1.28	178	12.25	12.55	24.8	43.5	18.7
400.08	H	3.00	178	2.80	21.40	24.2	46.0	21.8
612.00	H	1.95	180	1.42	25.58	27.0	46.0	19.0

Margin (dB) = Limit – Actual

[Actual = Reading + AF + CL]

1.H = Horizontal, V = Vertical Polarization

2.AF/CL = Antenna Factor and Cable Loss



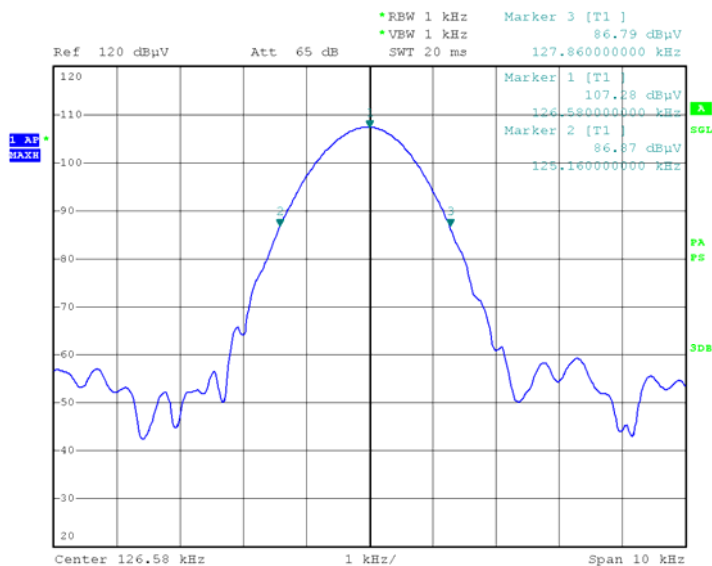
5.3 Occupied bandwidth

5.3.1 Measurement Procedure

1. Place the EUT in the test fixture and switch it on.
2. Use the following spectrum analyzer settings: RBW = VBW =1 kHz, Span = wide enough to capture the 20 dB bandwidth, Trace mode = Max Hold.
3. After trace stabilization, set the first marker and the first display line to the signal peak. Set the second display line 20 dB below the first display line. The Second marker and its delta marker shall be set to cross point of the spectrum line and the second display line and note these frequencies.
4. Alternatively the 20 dB down function of the analyzer could be used, if this function will be applicable to the displayed spectrum.

Figure 5: Occupied bandwidth

Occupied Bandwidth = 2.7 kHz



Date: 21.FEB.2013 10:59:37

F_L	F_H	Bandwidth ($F_H - F_L$)
125.16 (kHz)	127.86 (kHz)	2.7 (kHz)