





# Test Report

|   |  |  |                  |
|---|--|--|------------------|
| Test Report No.:  | KTI13EF02002   |  |                  |
| Registration No.:   | 99058  |  |                  |
| Applicant:  | UNION COMMUNITY Co.,Ltd.   |  |                  |
| Applicant Address:  | 5F, Hyundai Topics bldg., 44-3, Bangi-dong, Songpa-gu, Seoul, 138-050, Korea                               |  |                  |
| Product:  | Fingerprint Terminal   |  |                  |
| FCC ID:   | XX2-VS-R20DSC  | Model No.  | VS-R20D SC       |
| Receipt No.:  | 13-0102  | Date of receipt:   | January 21, 2012 |
| Date of Issue:  | February 15, 2013  |  |                  |
| Testing location  | Korea Technology Institute Co., Ltd.<br>51-19, Sanglim3-Ri, Docheok-Myeun, Gwangju-Shi, Gyeongki-Do, Korea |  |                  |
| Test Standards:   | FCC/ANSI. C63.4: 2003  |  |                  |
| Rule Parts: FCC   | Part 15, Class B   |  |                  |
| Equipment Class:  | Digital device   |  |                  |
| Test Result:  | The above-mentioned product has been tested with compliance.   |  |                  |
| Tested by: T. J. Kim<br>/ Engineer<br><br>Signature, Date February 18, 2013  |  | Approved by: G. C. Min<br>/President<br><br>Signature, Date February 18, 2013 |                  |
| Other Aspects:  |  |  |                  |
| Abbreviations:  | * OK, Pass=passed * Fail=failed * N/A=not applicable   |  |                  |
| <p>☞ - This test report is not permitted to copy partly without our permission.</p> <p>- This test result is dependent on only equipment to be used.</p> <p>- This test result is based on a single evaluation of one sample of the above mentioned.</p> <p>- This test report must not be used by the client to claim product endorsement by NVLAP or any agency of the U.S Government.</p> <p>- We certify this test report has been based on the measurement standards that is traceable to the national or international standards.</p> |  |  |                  |



## &gt;&gt; Contents &lt;&lt;

|   |    |
|---|----|
| Contents  | 2  |
| List of Tables  | 2  |
| List of Figures   | 2  |
| List of Photographs   | 2  |
| 1. General  | 4  |
| 2. Test Site  | 4  |
| 2.1 Location  | 4  |
| 2.2 List of Test and Measurement Instruments                  | 4  |
| 2.3 Test Date   | 5  |
| 2.4 Test Environment  | 5  |
| 3. Description of the tested samples                          | 6  |
| 3.1 Rating and Physical characteristics                       | 6  |
| 3.2 Submitted documents                                       | 6  |
| 4. Measurement conditions                                     | 7  |
| 4.1 Modes of operation  | 7  |
| 4.2 Additional Equipment                                      | 7  |
| 4.3 Uncertainty   | 7  |
| 4.4 Test Setup  | 8  |
| 5. TEST AND MEASUREMENTS                                      | 9  |
| 5.1 Antenna Requirement                                       | 9  |
| 5.1.1 Regulation  | 9  |
| 5.1.2 Results   | 9  |
| 5.2 Emission Test   | 10 |
| 5.2.1 Conducted Emissions                                     | 10 |
| 5.2.2 Radiated Emissions                                      | 14 |
| 5.2.2.1 Regulation  | 14 |
| 5.2.2.2 Measurement Procedure                                 | 14 |
| 5.2.2.3 Calculation of the field strength limits below 30 MHz | 15 |
| 5.2.2.4 Test Results  | 16 |
| 5.2.2.5 Calculation of the field strength limits above 30 MHz | 17 |
| 5.2.2.6 Test Results  | 17 |



»» **Contents** ««

|  |           |
|--|-----------|
| <b>5. 5.3 Spectrum mask and Occupied bandwidth</b> | <b>18</b> |
| 5.3.1 Regulation                                   | 18        |
| 5.3.2 Measurement Procedure                        | 18        |
| 5.3.3 Test Results                                 | 19        |
| <b>5.4 Frequency Tolerance of Carrier Signal</b>   | <b>21</b> |
| 5.4.1 Regulation                                   | 21        |
| 5.4.2 Measurement Procedure                        | 21        |
| 5.4.3 Test Results                                 | 22        |
| <b>6. Photograph of the Test Set-Up</b>            | <b>23</b> |

>> **List of Tables**

|                |   |           |
|----------------|---|-----------|
| <b>Table 1</b> | <b>List of test and measurement equipment</b>           | <b>5</b>  |
| <b>Table 2</b> | <b>Test Data. Conducted Emissions</b>                   | <b>13</b> |
| <b>Table 3</b> | <b>Test Data, Fundamental Frequency (Ver / Hor)</b>     | <b>16</b> |
| <b>Table 4</b> | <b>Test Data, Radiated Emission below 30 MHz</b>        | <b>16</b> |
| <b>Table 5</b> | <b>Test Data, Radiated Emission above 30 MHz</b>        | <b>18</b> |
| <b>Table 6</b> | <b>Test Data, Frequency Tolerance of carrier signal</b> | <b>22</b> |

>> **List of Figures**

|                 |                                     |           |
|-----------------|-------------------------------------|-----------|
| <b>Figure 1</b> | <b>Test Setup_Adaptor Mode</b>      | <b>8</b>  |
| <b>Figure 2</b> | <b>Spectral Diagram, LINE-PE</b>    | <b>11</b> |
| <b>Figure 3</b> | <b>Spectral Diagram, NEUTRAL-PE</b> | <b>12</b> |
| <b>Figure 5</b> | <b>Spectrum Mask</b>                | <b>20</b> |
| <b>Figure 6</b> | <b>Occupied Bandwidth</b>           | <b>21</b> |

>> **List of Photographs**

|                     |  |           |
|---------------------|--|-----------|
| <b>Photograph 1</b> | <b>Setup for radiated Emissions (below 30 MHz)</b> | <b>23</b> |
| <b>Photograph 2</b> | <b>Setup for radiated Emissions (above 30MHz)</b>  | <b>24</b> |
| <b>Photograph 3</b> | <b>Setup for conducted Emissions</b>               | <b>25</b> |



## **1. General**

This equipment has been shown to be capable of compliance with the applicable technical standards and was tested in accordance with the measurement procedures as indicated in this report.

We attest to the accuracy of data. Korea Technology Institute Co., Ltd. performed all measurements reported herein. And were made under Chief Engineer's supervisor.

We assume full responsibility for the completeness of these measurements and vouch for the qualifications of all persons taking them.

## **2. Test Site**

Korea Technology Institute Co., Ltd.

### **2.1 Location**

51-19, Sanglim3-Ri, Docheok-Myeun, Gwangju-Shi, Gyeongki-Do, Korea

The Test Site is in compliance with ANSI C63.4/2003 for measurement of radio Interference.



## 2.2 List of Test and Measurement Instruments

Table 1: List of Test and Measurement Equipment

### - Conducted Emissions

| Kind of Equipment    | Type    | S/N      | Calibrated until |
|----------------------|---------|----------|------------------|
| Field Strength Meter | ESIB40  | 100093   | 05.2013          |
| LISN                 | KNW407  | 8-1157-2 | 03.2013          |
| LISN                 | EM-7823 | 115019   | 03.2013          |
| Conducted Cable      | N/A     | N/A      | 11.2013          |

### - Radiated Emissions

| Kind of Equipment                       | Type     | S/N      | Calibrated until |
|---|----------|----------|------------------|
| Field Strength Meter                    | ESIB40   | 100093   | 05.2013          |
| Loop Antenna                            | 6502     | 3434     | 03.2014          |
| Biconic Logarithmic<br>Periodic Antenna | VULB9163 | 9163-281 | 10.2014          |
| Horn Antenna                            | 3115     | 6443     | 10.2014          |
| Open Site Cable                         | N/A      | N/A      | 11.2013          |
| Antenna Master                          | DETT-03  | N/A      | N / A            |
| Antenna & Turntable<br>controller       | DETT-04  | 91X519   | N / A            |

## 2.3 Test Date

Date of Application: January 21, 2013

Date of Test: January 25, 2013

## 2.4 Test Environment

Indoor: 18°C/42%/1000mbar

Outdoor: -7°C/48%/1000mbar



### 3. Description of the tested samples

The EUT is Card Reader.

#### 3.1 Rating and Physical Characteristics

| Item                  | Spec  | Description                                   |
|-----------------------|---|---|
| CPU                   | 32bit RISC 72MHz  | ST Micro                                      |
| LED                   | 3 LED (Red, White, Blue),   |   |
| Flash                 | Internal 256k Byte  | Nor Flash                                     |
| Buzzer Sound          | Possible to control volume  |   |
| Card Module           | 125KHz RF<br>13.56MHz Smart (1 Sam Card Socket Support)<br>125KHz HID Card  |   |
| Authentication Method | Card  |   |
| I/O                   | 4 Dip Switch<br>(485 ID Setting : 3pole, Changing 485<->Wiegand In/Out  |   |
| Lock Control          | - If POE is supported, separate lock Controller is used<br>- If POE is supported, EM, Strike, Motor Lock are possible<br>to use |   |
| RS-485                | 1 Port  | Interworking with 485 Controller              |
| Wiegand-Out           | 1 Port  | Display Wiegand signal output or success/fail |
| RS-232                | 3 Port  | Debug   |
| Power                 | 12 VDC  |   |

#### 3.2 Submitted Documents

- User's Guide
- Block Diagram



## 4. Measurement Conditions

Testing Input Voltage: AC 110V / 60Hz

### 4.1 Modes of Operation

The EUT was in the following operation mode during all testing;

Prior to a measurement, the Instruments of education shall be operated until stabilization has been reached.

### 4.2 Additional Equipment

| DEVICE TYPE     | Manufacturer             | M/N         | S/N         | FCC ID |
|-----------------|--------------------------|-------------|-------------|--------|
| Lock Controller | UNION COMMUNITY Co.,Ltd. | ViRDI LC010 | UNF00158701 | DOC    |
|                 |                          |             |             |        |
|                 |                          |             |             |        |
|                 |                          |             |             |        |
|                 |                          |             |             |        |
|                 |                          |             |             |        |
|                 |                          |             |             |        |

### 4.3 Uncertainty

#### 1) Radiated disturbance

$U_c$  (Combined standard Uncertainty) =  $\pm 1.8dB$

Expanded uncertainty  $U=KU_c$

$K = 2$

$\therefore U = \pm 3.6dB$

#### 2) Conducted disturbance

$U_c = \pm 0.88dB$

$U = KU_c=2 \times U_c = \pm 1.8dB$



### 4.4 Test Setup

Figure 1: Test Setup

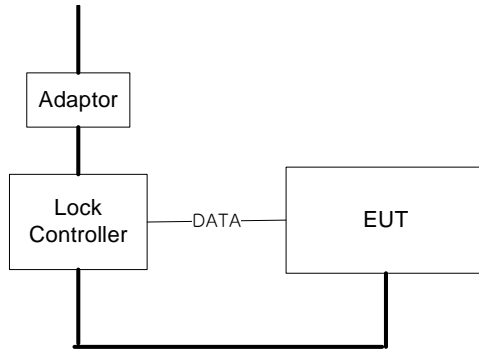

— SIGNAL  
— AC  
— POWER





## 5. TEST AND MEASUREMENTS

### Summary of Test Results

| Requirement  | FCC, 47CFR15               | Report Section | Test Result |
|--|----------------------------|----------------|-------------|
| Antenna Requirement  | 15.203                     | 5.1            | PASS        |
| Conducted Emissions<br>Radiated Emissions<br>Field strength 9 kHz to 30 MHz<br>Field strength 30 MHz to 1000 MHz | 15.209 & 15.205            | 5.2            | PASS        |
| Spectrum mask and Occupied bandwidth   | 15.225(a),(b),(c)<br>& (d) | 5.3            | PASS        |
| Frequency Tolerance of the Carrier Signal  | 15.225(e)                  | 5.4            | PASS        |

\*According to the Section 15.33(b)(1)&(c), Radiated Emissions & Conducted Emissions were reported in Report No. KTI13EF02006.

### 5.1 ANTENNA REQUIREMENT

#### 5.1.1 Regulation

##### FCC 47CFR15 – 15.203

An intentional radiator shall be designed to ensure that no antenna other than that furnished by the responsible party shall be used with the device. The use of a permanently attached antenna or of an antenna that uses a unique coupling to the intentional radiator shall be considered sufficient to comply with the provisions of this Section. The manufacturer may design the unit so that a broken antenna can be replaced by the user, but the use of a standard antenna jack or electrical connector is prohibited. This requirement does not apply to carrier current devices or to devices operated under the provisions of Sections 15.211, 15.213, 15.217, 15.219, or 15.221. Further, this requirement does not apply to intentional radiators that must be professionally installed, such as perimeter protection systems and some field disturbance sensors, or to other intentional radiators which, in accordance with Section 15.31(d), must be measured at the installation site. However, the installer shall be responsible for ensuring that the proper antenna is employed so that the limits in this Part are not exceeded.

#### 5.1.2 Result:

**PASS**

The transmitter has an integral PCB loop antenna that is enclosed within the housing of the EUT, and meets the requirements of this section.



## 5.2 EMISSION TEST

### 5.2.1. Conducted Emissions

**Result:****Pass**

The line-conducted facility is located inside a 2.3M x 3.5M x 5.5M shielded closure.

The shielding effectiveness of the shielded room is in accordance with MIL-Std-285 or NSA 605-05. A 1m x 1.5m wooden table 80cm high is placed 80cm away from the conducting ground plane and 40cm away from the sidewall of the shielded room. Electro-Metroics Model EM-7823 (9kHz-30MHz) 50ohm/50 uH Line-Impedance Stabilization Networks (LISN) are bonded to the shielded room.

The EUT is powered from the Electro-Metroics LISN and the support equipment is powered from the Kyoritsu LISN. Power to the LISN are filtered by a high-current high-insertion loss shield enclosures power line filters (100dB 14kHz-1GHz).

The purpose of the filter is to attenuate ambient signal interference and this filter is also bonded to the shielded enclosure.

All electrical cables are shielded by copper pipe with inner diameter of 1".

If the EUT is a DC-Powered device, power will be derived from the source power supply it normally will be powered from and this supply lines will be connected to the Rohde & Schwarz LISN.

All interconnecting cables more than 1 meter were shortened by non-inductive bundling (serpentine fashion) to a 1-meter length.

Sufficient time for the EUT, Support equipment, and test equipment was allowed in order for them to warm up to their normal operating condition. The RF output of the LISN was connected to the spectrum analyzer to determine the frequency producing the maximum EME from the EUT. The frequency producing the maximum level was reexamined using EMI field Intensity meter (ESIB40 ). The detector function was set to CISPR quasi-peak mode.

The bandwidth of the receiver was set to 10kHz. The EUT, support equipment, and interconnecting cables were arranged and manipulated to maximize each emission. Each emission was maximized by: switching power lines; varying the mode of operation or resolution; clock or data exchange speed; if applicable; whichever determined the worst-case emission.

Photographs of the worst-case emission can be seen in photograph of conducted test.

Each EME reported was calibrated using self-calibrating mode.



Figure 2: Spectral Diagram\_LINE-PE

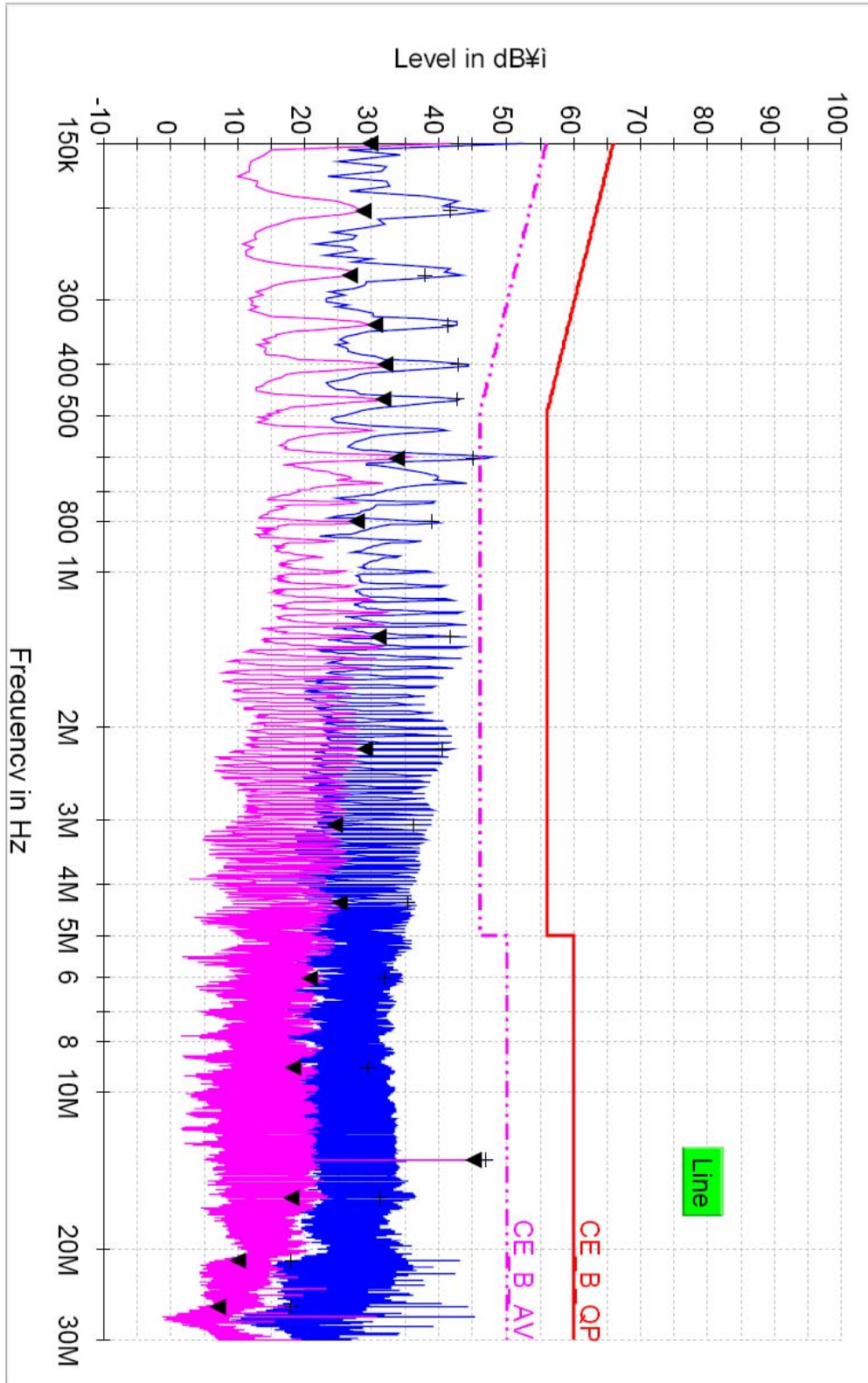



Figure 3: Spectral Diagram\_NEUTRAL-PE

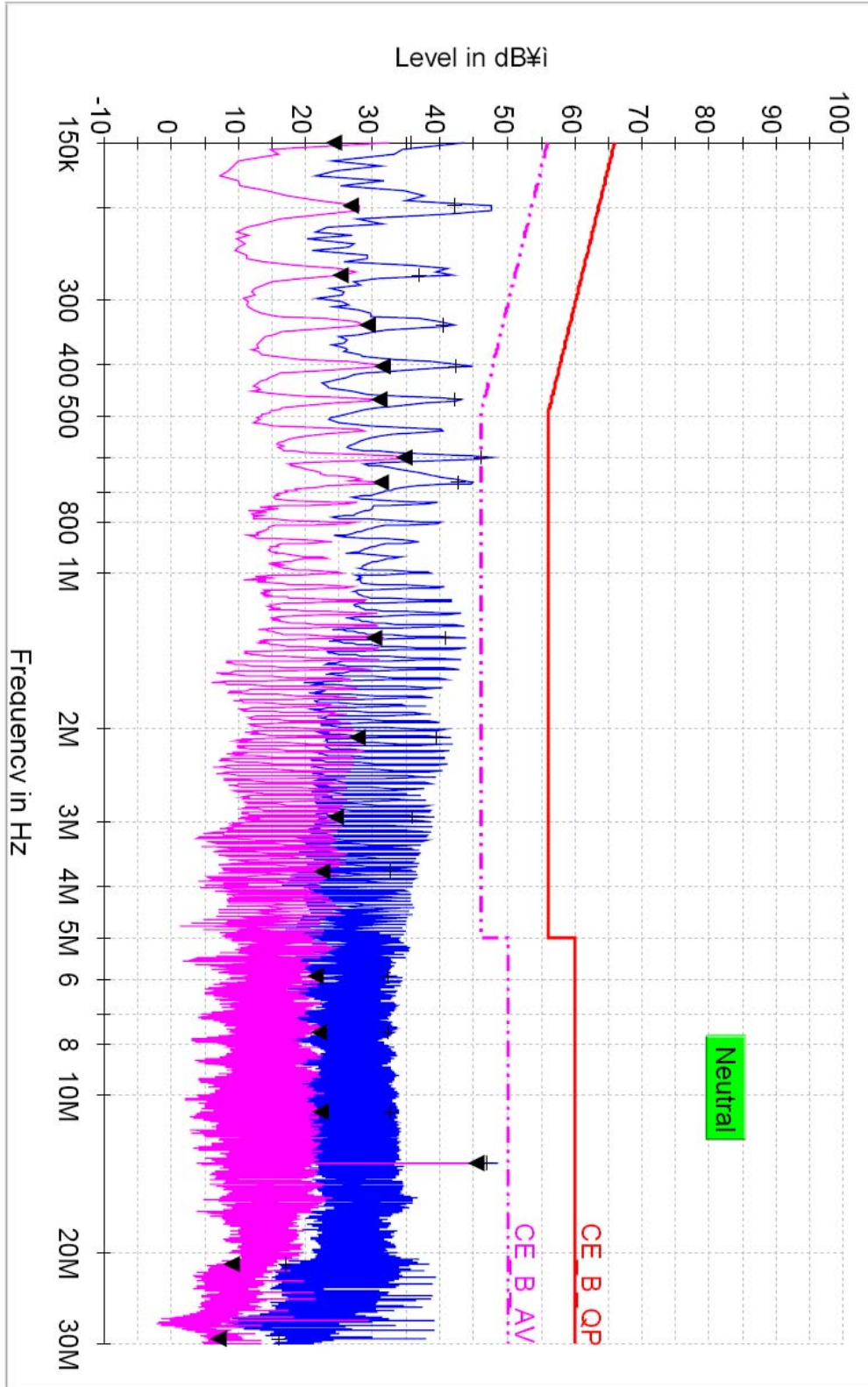



Table 2: Test Data, Conducted Emissions

| Frequency<br>(MHz) | (1) Reading<br>(dB $\mu$ V) |      | Line | (2) Limit<br>(dB $\mu$ V) |      | (3) Margin<br>(dB) |      |
|--------------------|-----------------------------|------|------|---------------------------|------|--------------------|------|
|                    | QP                          | AV   |      | QP                        | AV   | QP                 | AV   |
| 0.20               | 42.2                        | 26.7 | L2   | 63.7                      | 53.7 | 21.5               | 27.0 |
| 0.46               | 42.7                        | 31.7 | L1   | 56.6                      | 46.6 | 13.9               | 14.9 |
| 0.60               | 46.0                        | 34.6 | L2   | 56.0                      | 46.0 | 10.0               | 11.4 |
| 1.33               | 41.8                        | 30.9 | L1   | 56.0                      | 46.0 | 14.2               | 15.1 |
| 13.56              | 46.8                        | 45.0 | L2   | 60.0                      | 50.0 | 13.2               | 5.0  |
| 16.02              | 31.2                        | 18.0 | L2   | 60.0                      | 50.0 | 28.8               | 32.0 |

## NOTES:

1. All modes of operation were investigated  
And the worst-case emissions are reported.
2. All other emissions are non-significant.
3. All readings are calibrated by self-mode in receiver.
4. Measurements using CISPR quasi-peak mode.
5. L1 = LINE-PE, L2 = NEUTRAL-PE
6. The limit for Class B digital device is 66dBuV to 56dBuV from 150KHz to 500KHz, 56dBuV from 500KHz to 5MHz, 60dBuV Above 5MHz.

## ♣ Margin Calculation

$$(3) \text{ Margin} = (2) \text{ Limit} - (1) \text{ Reading}$$



**5.2.2 Radiated Emissions**

**5.2.2.1 Regulation**

**FCC 47CFR15 – 15.209**

(a) Except as provided elsewhere in this Subpart, the emissions from an intentional radiator shall not exceed the field strength levels specified in the following table:

| Frequency (MHz) | Field strength limit (uV/m) | Field strength limit (dBuV/m) | Measurement Distance (m) |
|-----------------|-----------------------------|-------------------------------|--------------------------|
| 0.009 – 0.490   | 2400/F(kHz)                 | 48.5-13.8                     | 300                      |
| 0.490 – 1.705   | 24000/F(kHz)                | 33.8-23.0                     | 30                       |
| 1.705 – 30.0    | 30                          | 29.5                          | 30                       |
| 30 – 88         | 100                         | 40.0                          | 3                        |
| 88 – 216        | 150                         | 43.5                          | 3                        |
| 216 – 960       | 200                         | 46.0                          | 3                        |
| Above 960       | 500                         | 54.0                          | 3                        |

**5.2.2.2 Measurement Procedure**

**Radiated Emissions Test, 9kHz to 30MHz (Magnetic Field Test)**

1. The preliminary radiated measurements were performed to determine the frequency producing the maximum emissions at a distance of 3 meters according to Section 15.31(f)(2).
2. The EUT was placed on the top of the 0.8-meter height, 1 x 1.5 meter non-metallic table.
3. Emissions from the EUT are maximized by adjusting the orientation of the Loop antenna and rotating the EUT on the turntable. Manipulating the system cables also maximizes EUT emissions if applicable.
4. To obtain the final measurement data, each frequency found during preliminary measurements was re-examined and investigated. The test-receiver system was set up to average, peak, and quasi-peak detector with specified bandwidth.

**Radiated Emissions Test, 30 MHz to 1000 MHz**

1. The preliminary radiated measurements were performed to determine the frequency producing the maximum emissions in an anechoic chamber at a distance of 3 meters.
2. The EUT was placed on the top of the 0.8-meter height, 1 x 1.5 meter non-metallic table. To find the maximum emission levels, the height of a measuring antenna was changed and the turntable was rotated 360
3. The antenna polarization was also changed from vertical to horizontal. The spectrum was scanned from 30 to 1000 MHz using the Biconical and Logperiodue broadband antenna,
4. To obtain the final measurement data, the EUT was arranged on a turntable situated on a 4 x 4 meter at the Open Area Test Site. The EUT was tested at a distance 3 meters.
5. Each frequency found during preliminary measurements was re-examined and investigated. The test-receiver system was set up to average, peak, and quasi-peak detector function with specified bandwidth.
6. The presence of ambient signals was verified by turning the EUT off. In case an ambient signal was detected, the measurement bandwidth was reduced temporarily and verification was made that an additional adjacent peak did not exist. This ensures that the ambient signal does not hide any emissions from the EUT

**5.2.2.3 Calculation of the field strength limits below 30 MHz**

1. No special calculation for obtaining the field strength in dBuV/m is necessary, because the EMI receiver and the active loop antenna operate as a system, where the reading gives directly the field strength result (dBuV/m). The antenna factors and cable losses are already taken into consideration.
2. For test distance other than what is specified, but fulfilling the requirements of section 15.31 (f)(2) the field strength is calculated by adding additionally an extrapolation factor of 40dB/decade (inverse linear distance for field strength measurements).
3. All following emission measurements were performed using the test receiver's average, peak, and quasi-peak detector function with specified bandwidth.



**5.2.2.4 Test Results (Test mode : TX on)**

**PASS**

**Table 3: Test Data, Fundamental Frequency (Ver / Hor)**

| Frequency (MHz) | Pol. | Reading (dB $\mu$ V) | AFCL (dB/m) | Actual (dB $\mu$ V/m) | Limit (dB $\mu$ V/m) | Margin (dB) | Detector |
|-----------------|------|----------------------|-------------|-----------------------|----------------------|-------------|----------|
| 13.561          | V    | 25.8                 | 8.7         | 54.5                  | 69.50                | 15.0        | QP       |

| Frequency (MHz) | Pol. | Reading (dB $\mu$ V) | AFCL (dB/m) | Actual (dB $\mu$ V/m) | Limit (dB $\mu$ V/m) | Margin (dB) | Detector |
|-----------------|------|----------------------|-------------|-----------------------|----------------------|-------------|----------|
| 13.561          | H    | 36.7                 | 8.7         | 55.4                  | 69.50                | 14.1        | QP       |

**FCC 47CFR15 – 15.209 (9 kHz - 30 MHz)**

**Table 4: Test Data, Radiated Emission below 30 MHz**

| Frequency (MHz) | Pol. | Height [m] | Angle [°] | (1) Reading (dB $\mu$ V) | (2) AFCL (dB/m) | (3) Actual (dB $\mu$ V/m) | (4) Limit (dB $\mu$ V/m) | (5) Margin (dB) |
|-----------------|------|------------|-----------|--------------------------|-----------------|---------------------------|--------------------------|-----------------|
| 0.02            | V    | 1.65       | 179       | 36.0                     | 14.9            | 50.9                      | 121.71                   | 70.81           |
| 0.10            | V    | 1.24       | 180       | 25.0                     | 10.6            | 35.6                      | 109.14                   | 73.54           |
| 0.60            | V    | 1.30       | 184       | 29.6                     | 10.2            | 39.8                      | 71.89                    | 32.09           |
| 1.21            | V    | 1.20       | 181       | 35.7                     | 10.0            | 45.7                      | 67.26                    | 21.56           |
| 2.72            | H    | 1.35       | 185       | 21.4                     | 9.7             | 31.1                      | 69.50                    | 38.40           |
| 5.50            | V    | 1.44       | 183       | 19.6                     | 9.5             | 29.1                      | 69.50                    | 40.40           |

**Margin (dB) = Limit – Actual**  
**[Actual = FS + AF + CL ]**

1. H = Horizontal, V = Vertical Polarization
2. AF/CL = Antenna Factor and Cable Loss
3. FS = RA + DF

Where FS = Field strength in dB $\mu$ V/m

RA = Receiver Amplitude in dB $\mu$ V/m

DF = Distance Extrapolation Factor in dB





**5.2.2.5 Calculation of the field strength limits above 30 MHz**

1. No special calculation for obtaining the field strength in dBuV/m is necessary, because the EMI receiver and the active loop antenna operate as a system, where the reading gives directly the field strength result (dBuV/m). The antenna factors and cable losses are already taken into consideration.
2. For test distance other than what is specified, but fulfilling the requirements of section 15.31 (f)(2) the field strength is calculated by adding additionally an extrapolation factor of 40dB/decade (inverse linear distance for field strength measurements).
3. All following emission measurements were performed using the test receiver's average, peak, and quasi-peak detector function with specified bandwidth.

**5.2.2.6 Test Results (Test mode : TX on)**

**FCC 47CFR15 – 15.209**

**PASS**

Table 5: Test Data, Radiated Emission above 30 MHz

| Frequency (MHz) | Pol. | Height [m] | Angle [° ] | Reading (dBµV) | AFCL (dB/m) | Actual (dBµV/m) | Limit (dBµV/m) | Margin (dB) |
|-----------------|------|------------|------------|----------------|-------------|-----------------|----------------|-------------|
| 32.20           | H    | 1.42       | 182        | 13.3           | 12.7        | 26.0            | 40.0           | 14.0        |
| 61.32           | H    | 1.96       | 180        | 13.9           | 13.1        | 27.0            | 40.0           | 13.0        |
| 122.36          | V    | 1.63       | 181        | 13.7           | 10.5        | 24.2            | 43.5           | 21.3        |
| 161.24          | V    | 1.87       | 183        | 5.5            | 9.9         | 15.4            | 43.5           | 28.1        |
| 542.48          | H    | 1.60       | 184        | 11.0           | 18.9        | 29.9            | 46.0           | 16.1        |
| 678.08          | H    | 1.54       | 183        | 17.7           | 20.2        | 37.9            | 46.0           | 8.1         |

**FCC 47CFR15-15.205 Restricted Band**

| Frequency (MHz) | Pol. | Height [m] | Angle [° ] | Reading (dBµV) | AFCL (dB/m) | Actual (dBµV/m) | Limit (dBµV/m) | Margin (dB) |
|-----------------|------|------------|------------|----------------|-------------|-----------------|----------------|-------------|
| 38.23           | V    | 1.46       | 185        | 11.7           | 13.9        | 25.6            | 40.0           | 14.4        |
| 110.04          | V    | 1.72       | 143        | 5.5            | 11.7        | 17.2            | 43.5           | 26.3        |
| 168.72          | H    | 1.61       | 174        | 17.6           | 10.1        | 27.7            | 43.5           | 15.8        |
| 325.48          | H    | 1.66       | 170        | 24.5           | 15.3        | 39.8            | 46.0           | 6.2         |
| 409.12          | H    | 1.44       | 162        | 7.8            | 16.6        | 24.4            | 46.0           | 21.6        |
| 611.23          | V    | 1.71       | 187        | 5.3            | 19.8        | 25.1            | 46.0           | 20.9        |

Margin (dB) = Limit – Actual

[Actual = Reading + AF + CL ]

1. H = Horizontal, V = Vertical Polarization

2. AF/CL = Antenna Factor and Cable Loss



**5.3 Spectrum mask and Occupied bandwidth**

**5.3.1 Regulation**

**FCC 47CFR15 – 15.225**

- (a) The field strength of any emissions within the band 13.553-13.567 MHz shall not exceed 15,848 microvolts/meter at 30 meters.
- (b) Within the bands 13.410-13.553 MHz and 13.567-13.710 MHz, the field strength of any emissions shall not exceed 334 microvolts/meter at 30 meters.
- (c) Within the bands 13.110-13.410 MHz and 13.710-14.010 MHz the field strength of any emissions shall not exceed 106 microvolts/meter at 30 meters.
- (d) The field strength of any emissions appearing outside of the 13.110-14.010 MHz band shall not exceed the general radiated emission limits in § 15.209.

| Frequency (MHz) | Field strength limit (uV/m) @ 30m | Field strength limit (dBuV/m) @ 30m | Field strength limit (dBuV/m) @ 3m |
|-----------------|-----------------------------------|-------------------------------------|------------------------------------|
| 13.110 – 13.410 | 106                               | 40.5                                | 80.5                               |
| 13.410 – 13.553 | 334                               | 50.5                                | 90.5                               |
| 13.553 – 13.567 | 15,848                            | 84.0                                | 124.0                              |
| 13.567 – 13.710 | 334                               | 50.5                                | 90.5                               |
| 13.710 – 14.010 | 106                               | 40.5                                | 80.5                               |

**5.3.2 Measurement Procedure**

**Spectrum Mask**

1. Place the EUT in the test fixture and switch it on
2. Use the following spectrum analyzer settings: RBW = VBW =1 kHz, Span = wide enough to capture the whole 13 MHz band including the frequency ranges where the 15.209 limit applies, Trace mode = Max Hold, select the limit line 15.225(a),(b),(c)
3. After trace stabilization, set the marker to the single peak.
4. The reference level will be calculated by the amount of the margin of the wanted signal to its 30 m emission limit plus marker value.
5. The whole signal trace has to be below the limit line.



**Occupied Bandwidth**

1. Place the EUT in the test fixture and switch it on.
2. Use the following spectrum analyzer settings: RBW = VBW =1 kHz, Span = wide enough to capture the 20 dB bandwidth, Trace mode = Max Hold.
3. After trace stabilization, set the first marker and the first display line to the signal peak. Set the second display line 20 dB below the first display line. The Second marker and its delta marker shall be set to cross point of the spectrum line and the second display line and note these frequencies.
4. Alternatively the 20 dB down function of the analyzer could be used, if this function will be applicable to the displayed spectrum.

**5.3.3 Test Results (Test mode : Modulated)**

**PASS**

**Figure 5: Spectrum Mask**

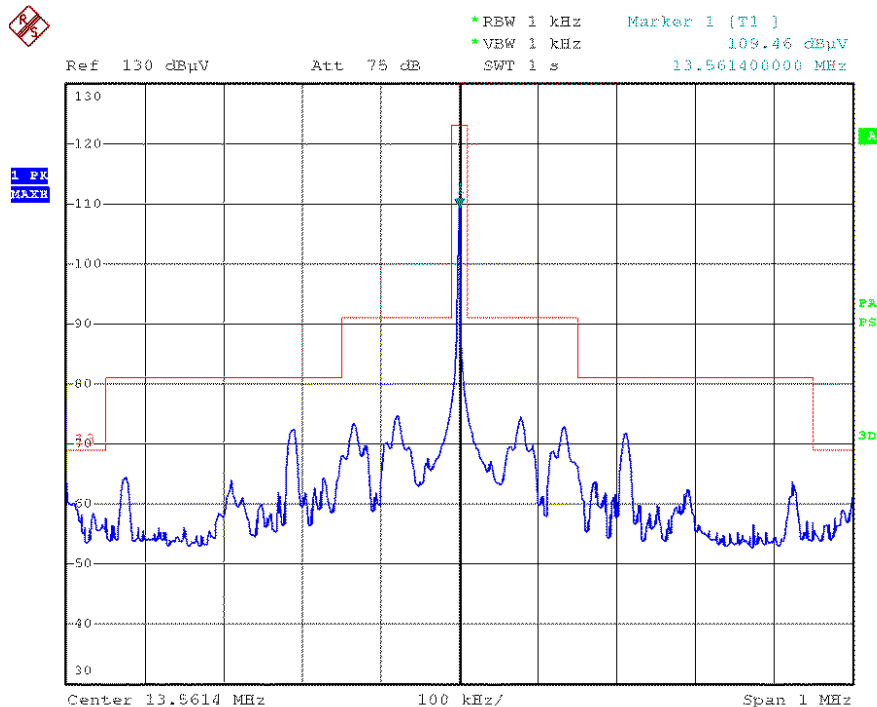



**Figure 6: Occupied bandwidth**

**Occupied Bandwidth = 4.86 kHz**

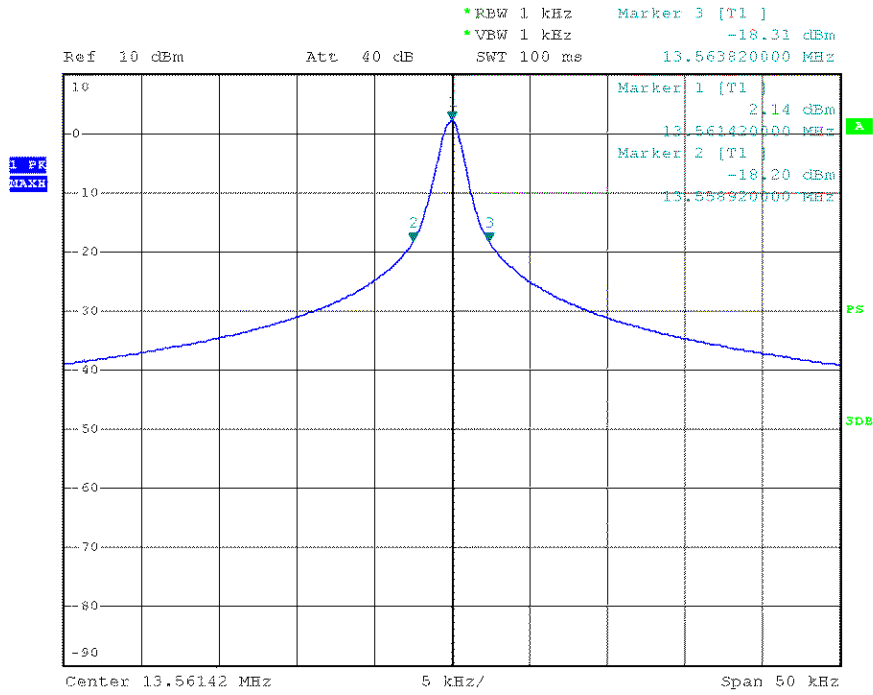

| $F_L$           | $F_H$           | Bandwidth ( $F_H - F_L$ ) |
|-----------------|-----------------|---------------------------|
| 13.558920 (MHz) | 13.563820 (MHz) | 4.9 (kHz)                 |



## **5.4 FREQUENCY TOLERANCE OF CARRIER SIGNAL**

### **5.4.1 Regulation**

#### **FCC 47CFR15 – 15.225(e)**

The frequency tolerance of the carrier signal shall be maintained within +/- 0.01% of the operating frequency over a temperature variation of -20 degrees to +50 degrees C at normal supply voltage, and for a variation in the primary supply voltage from 85% to 115% of the rated supply voltage at a temperature of 20 degrees C. For battery-operated equipment, the equipment tests shall be performed using a new battery.

### **5.4.2 Measurement Procedure**

#### **Frequency stability versus environmental temperature**

1. Supply the EUT with nominal DC voltage.
2. Turn the EUT off, and place it inside an environmental temperature chamber. For devices that are normally operated continuously, the EUT may be energized while inside the test chamber. For devices that have oscillator heaters, energize only the heater circuit while the EUT is inside the chamber.
3. RF output was connected to a frequency counter or other frequency-measuring instrument via feed through attenuators.
4. Set the temperature control on the chamber to the highest specified EUT operating temperature, and allow the temperature inside the chamber to stabilize at the set temperature before starting frequency measurements.
5. While maintaining a constant temperature inside the environmental chamber, turn the EUT on and record the operating frequency at startup and two, five, and ten minutes after the EUT is energized.
6. After all measurements have been made at the highest specified temperature turn the EUT off.
7. Repeat the above measurement process for the EUT with the test chamber set at the appropriate temperature.

#### **Frequency Stability versus Input Voltage**

1. At temperature ( $20 \pm 5^{\circ}\text{C}$ ), supply the EUT with nominal DC voltage.
2. Couple RF output to a frequency counter or other frequency-measuring instrument.
3. Turn the EUT on, and measure the EUT operating frequency at startup and two, five, and ten minutes after startup.
4. Supply it with 85% of the nominal DC voltage and repeat above procedure.
5. Supply it with 115% of the nominal DC voltage and repeat above procedure.



**5.4.3 Test Results :**

**PASS**

**TEST MODE : TX on**

**Table 6: Test Data, Frequency Tolerance of carrier signal**

**Operating Frequency : 13.5614 MHz, LIMIT : within ±1356 Hz**

| Environment Temperature<br>[°C] | Power Supplied<br>[V <sub>AC</sub> ] | Carrier Frequency Measured with Time Elapsed |         |           |         |           |         |            |         |
|---------------------------------|--------------------------------------|--|---------|-----------|---------|-----------|---------|------------|---------|
|                                 |                                      | STARTUP                                      |         | 2 minutes |         | 5 minutes |         | 10 minutes |         |
|                                 |                                      | [MHz]  | Err[Hz] | [MHz]     | Err[Hz] | [MHz]     | Err[Hz] | [MHz]      | Err[Hz] |
| +50                             | 110                                  | 13.561426                                    | 26      | 13.561426 | 26      | 13.561426 | 26      | 13.561426  | 26      |
| +40                             | 110                                  | 13.561427                                    | 27      | 13.561426 | 26      | 13.561426 | 26      | 13.561426  | 26      |
| +30                             | 110                                  | 13.561428                                    | 28      | 13.561428 | 28      | 13.561428 | 28      | 13.561428  | 28      |
| +20                             | 110                                  | 13.561430                                    | 30      | 13.561431 | 31      | 13.561431 | 31      | 13.561431  | 31      |
| +10                             | 110                                  | 13.561429                                    | 29      | 13.561432 | 32      | 13.561432 | 32      | 13.561432  | 32      |
| 0                               | 110                                  | 13.561456                                    | 56      | 13.561456 | 56      | 13.561456 | 56      | 13.561456  | 56      |
| -10                             | 110                                  | 13.561475                                    | 75      | 13.561475 | 75      | 13.561475 | 75      | 13.561477  | 77      |
| -20                             | 110                                  | 13.561460                                    | 60      | 13.561458 | 58      | 13.561458 | 58      | 13.561458  | 58      |

**Operating Frequency : 13.5614 MHz, LIMIT : within ±1356 Hz**

| Power Supplied<br>[V <sub>AC</sub> ] | Carrier Frequency Measured with Time Elapsed |         |           |         |           |         |            |         |
|--------------------------------------|--|---------|-----------|---------|-----------|---------|------------|---------|
|                                      | STARTUP                                      |         | 2 minutes |         | 5 minutes |         | 10 minutes |         |
|                                      | [MHz]  | Err[Hz] | [MHz]     | Err[Hz] | [MHz]     | Err[Hz] | [MHz]      | Err[Hz] |
| 85 %                                 | 13.561427                                    | 27      | 13.561427 | 27      | 13.561427 | 27      | 13.561427  | 27      |
| 100 %                                | 13.561428                                    | 28      | 13.561428 | 28      | 13.561428 | 28      | 13.561428  | 28      |
| 115 %                                | 13.561426                                    | 26      | 13.561426 | 26      | 13.561426 | 26      | 13.561426  | 26      |

**Err[Hz] = Measured carrier frequency (MHz) – Operating Frequency (13.5614 MHz)**