

UBio-X Slim User Guide

Version Eng-0.3



UNION
COMMUNITY

<Revision History>

Version	Date	Description	Firmware Version
0.1	2019-03-15	Initial Release	
0.2	2019-03-25	Modify some words	
0.3	2019-04-25	Modify the Menu titles according to Terminal's Menu modes.	



<Glossary>

- Admin, Administrator
 - A user who can enter into the terminal menu mode, he/she can register/modify/delete terminal users and change the operating environment by changing settings.
 - If there is no administrator for a terminal, anyone can change the settings. In this regard, it is recommended to register at least one administrator.
 - Caution is required with registration and operation because an administrator has the right to change critical environmental settings of the terminal.

- 1 to 1 Verification
 - Authenticate the user's fingerprint after inserting his user ID or swiping his registered Card.
 - It is called 1 to 1 Verification because only the fingerprint registered in the user's ID or card is used for comparison.

- 1 to N Identification
 - The terminal performs matches against multiple fingerprints (templates) based solely on fingerprint information.
 - Without the user's ID or card, the user's fingerprint is compared to fingerprints previously registered.

- Authentication level
 - Depending on the fingerprint match rate, it is displayed from 1 to 9. Authentication is successful only if the match rate is higher than the set level.
 - The higher the Authentication level, the higher the security. However, it requires a relatively high match rate, so Authentication is vulnerable to failure.
 - 1:1 Level: Authentication level used for 1:1 verification
 - 1:N Level: Authentication level used for 1:N identification

- LFD (Live Finger Detection)
 - This function allows the input of only real fingerprints and blocks the input of imitation fingerprints produced using rubber, paper, film, and silicone.

UNIONCOMMUNITY Co., Ltd.

**Addr : 12F, Munjeong Daemyeong Valeon bldg, 127 Beobwon-ro Songpa-gu,
Seoul, Korea (zip code : 05836)**

Tel : +82-2-6488-3000 , Fax : +82-2-6488-3099,

E-Mail : sales@unioncomm.co.kr; <http://www.unioncomm.co.kr>

UNION
COMMUNITY

Contents

<Revision History>	2
<Glossary>	3
1. Before use	6
1.1. Safety Precautions	6
1.2. Specific names of the terminal	7
1.3. LCD Display Composition	8
1.3.1 Status Icons	8
1.4. Voice and Beep sounds in operation	9
1.4.1 Beep or Sound effect in operation	9
1.5. Proper fingerprint registration and input methods	9
2. Product introduction	11
2.1. Product characteristics	11
2.2. Product components	12
2.2.1. Standalone use (Access)	12
2.3. Product specification	13
3. Environment setting	14
3.1. Checks before setting the environment	14
3.1.1. Entering the menu by Administrator	14
3.2. Menu composition	15
3.3. User	17
3.3.1. Register	18
3.3.2. Modify	18
3.3.3. Delete	19
3.3.4. List	19
3.3.5. Card Only	20
3.4. Auth	20
3.4.1. Normal	21
3.4.2. TnA	22
3.4.3. Timezone	23
3.4.4. Log	23
3.5. System	24
3.5.1. Sensor	25
3.5.2. Card	25
3.5.3. Door	26
3.5.4. RS485	26
3.5.5. Option	27
3.5.6. Information	27
3.6. Network	28
3.6.1. Normal	28
3.7. UI	29
3.7.1. Sound	30
3.7.2. Display	30
3.8. USB	31
3.8.1. F/W Update	31
3.9. Connect your BT module with your app	32
3.9.1. BT module activation	32
3.9.2. BT module connection wait status	32
3.9.3. Search and access your app's BT module	32
3.9.4. Connected app and BT module	33

UNIONCOMMUNITY Co., Ltd.

**Addr : 12F, Munjeong Daemyeong Valeon bldg, 127 Beobwon-ro Songpa-gu,
Seoul, Korea (zip code : 05836)**

Tel : +82-2-6488-3000 , Fax : +82-2-6488-3099,

E-Mail : sales@unioncomm.co.kr; <http://www.unioncomm.co.kr>



3.9.5. Disconnect from app and BT module in recognizer..... 33
3.10. Initialize..... 34
4. How to use terminal 35
4.1. How to open the door 35
4.2. How to punch for TnA..... 37

UNIONCOMMUNITY Co., Ltd.

**Addr : 12F, Munjeong Daemyeong Valeon bldg, 127 Beobwon-ro Songpa-gu,
Seoul, Korea (zip code : 05836)**

Tel : +82-2-6488-3000 , Fax : +82-2-6488-3099,





E-Mail : sales@unioncomm.co.kr; <http://www.unioncomm.co.kr>



1. Before use







1.1. Safety Precautions

● Warning

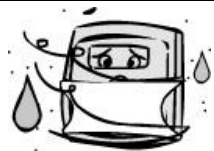
<p>Handling with wet hands or allowing liquid to flow into it is prohibited. -> It may cause an electric shock or damage.</p>		<p>Do not place a fire source near the terminal. -> It may cause a fire.</p>	
<p>Do not disassemble, repair, or modify the terminal at discretion. -> It may cause an electric shock, fire or damage.</p>		<p>Keep out of reach of children. -> It may cause an accident or damage.</p>	

- If the above warning is ignored, it may result in death or serious injury.

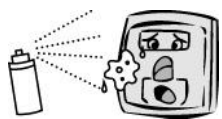
● Cautions

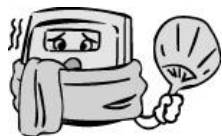
<p>Keep away from direct sunlight -> It may cause deformation or color change.</p>		<p>Avoid high humidity or dust -> The terminal may be damaged.</p>	
<p>Avoid using water, benzene, thinner, or alcohol for cleaning -> It may cause an electric shock or fire.</p>		<p>Do not place a magnet close to the terminal. -> The terminal may break down or malfunction.</p>	
<p>Do not contaminate the fingerprint input area. -> Fingerprints may not be well recognized.</p>		<p>Avoid using insecticide or flammable spray near the terminal. -> It may result in deformation or color change.</p>	
<p>Avoid impacts or using sharp objects on the terminal. -> The terminal may be damaged and broken.</p>		<p>Avoid severe temperature changes -> The terminal may be broken.</p>	

- If the above cautions are ignored, it may result in property loss or human injury.

※ Under no circumstances will UNION COMMUNITY be responsible for accidents or damages caused by inappropriate use of the product without referring to the user manual.

UNIONCOMMUNITY Co., Ltd.

Addr : 12F, Munjeong Daemyeong Valeon bldg, 127 Beobwon-ro Songpa-gu, Seoul, Korea (zip code : 05836)

Tel : +82-2-6488-3000 , Fax : +82-2-6488-3099,

E-Mail : sales@unioncomm.co.kr; <http://www.unioncomm.co.kr>



1.2. Specific names of the terminal



UNIONCOMMUNITY Co., Ltd.

Addr : 12F, Munjeong Daemyeong Valeon bldg, 127 Beobwon-ro Songpa-gu, Seoul, Korea (zip code : 05836)

Tel : +82-2-6488-3000 , Fax : +82-2-6488-3099,







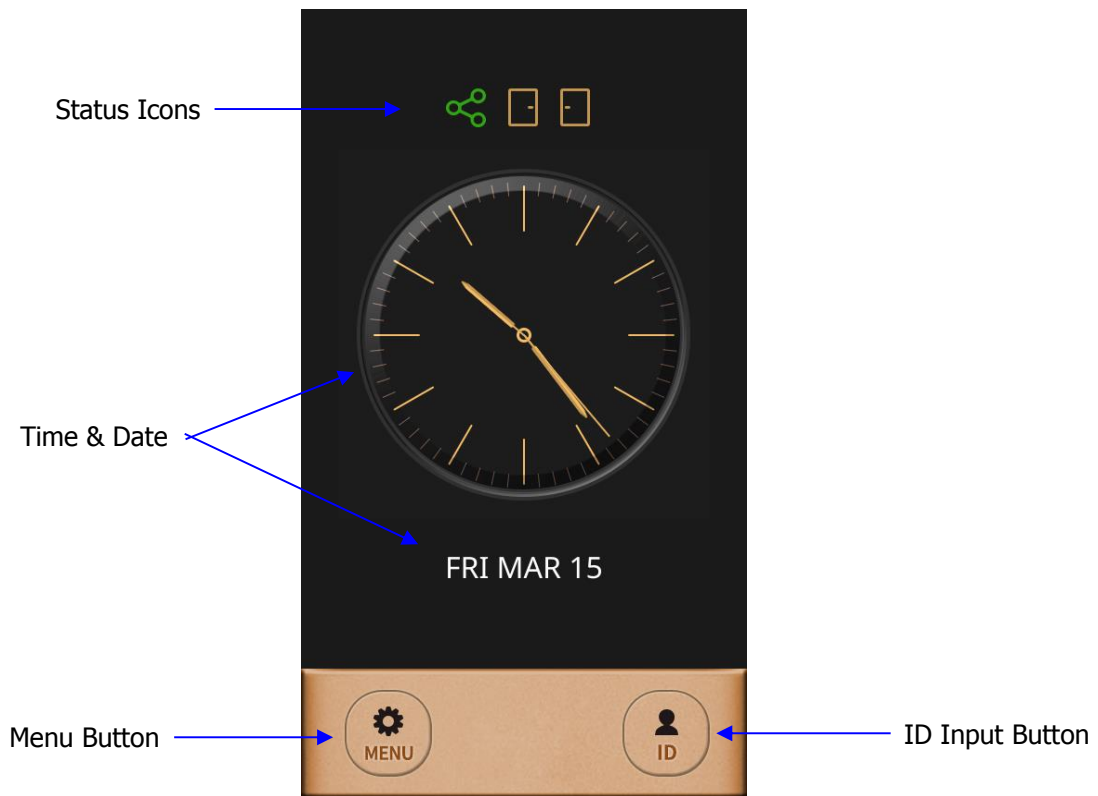

E-Mail : sales@unioncomm.co.kr; <http://www.unioncomm.co.kr>



1.3. LCD Display Composition



1.3.1 Status Icons

Network Status		: Standalone Mode (Non-networking Mode)
		: Connected to the server (On line)
		: Disconnected to the server (Off line)
Fire Alarm	None	: Normal Status
		: Fire Alarm is activated (by the Fire switch or by Server program)
Tamper	None	: Normal Status
		: Abnormal Status (Tamper switch is activated)
Door Status		: Door is closed
		: Door is opened
		: Door is opened abnormally

1.4. Voice and Beep sounds in operation

Operation type	Voice sound
Success to authorize	You are authorized
Fail to authorize	Please try again
Waiting for input FP	Please place your finger
Waiting for input Card	Please place your card
Touch the ID Input button	Please insert your ID

1.4.1 Beep or Sound effect in operation

Pi-pick	Notice for fail	When the authorization was failed (at Voice off)
Peek & Ding-dong	Notice for Success	When the authorization was successful (at Voice off)

1.5. Proper fingerprint registration and input methods

- Correct fingerprint registration methods

Place your index finger on the window just as you do with a finger stamp.
 Do not use the tip of the finger.
 Make sure the center of your finger touches the window.

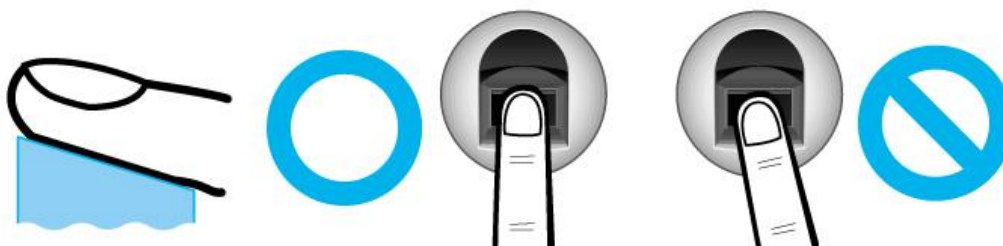

- Use your index finger if possible, it is the easiest for orientation and guarantees a stable input method.
- Check if your fingerprint is unclear or damaged. It is tricky to recognize fingerprints on dry, wet, unclear, or injured fingers. Use another finger in this case.



- Be aware of certain fingerprint conditions

Depending on the user's fingerprint condition, some fingerprints may not be used or may cause an inconvenience.

- If the fingerprint is damaged or very unclear, then it cannot be recognized. Please use the RF Card instead in this case.
- **When a finger is dry, breathe on the finger for smooth operation.**
- For kids, it may be tricky or impossible to use the terminal because their fingerprints are too small or very unclear. It is recommended to register their fingerprints every six months.
- For the elderly, it may not be possible to register their fingerprints if there are too many fine lines on the fingerprints.
- It is recommended that you register more than 2 fingerprints.
- In order to increase the fingerprint authentication rate, it is recommended to use six of the ten fingers as illustrated above. (Both thumbs, forefingers, middle fingers).

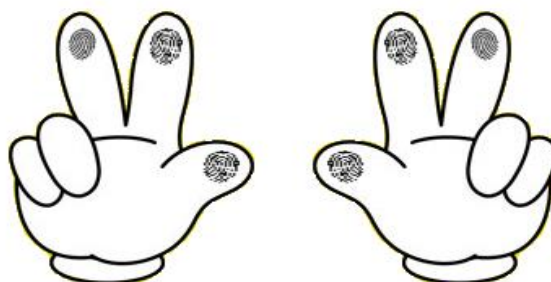

UNIONCOMMUNITY Co., Ltd.

Addr : 12F, Munjeong Daemyeong Valeon bldg, 127 Beobwon-ro Songpa-gu,
Seoul, Korea (zip code : 05836)

Tel : +82-2-6488-3000 , Fax : +82-2-6488-3099,

E-Mail : sales@unioncomm.co.kr; <http://www.unioncomm.co.kr>

UNION
COMMUNITY

2. Product introduction

2.1. Product characteristics

- Multi-Modal product with which the user can use fingerprint, Card or Password authorization functions together.
- Built-in Camera Flash can detect the real human face or a picture.
- Camera Flash can be activated automatically by the Daylighting sensor.
- RF Card (125 kHz)
- Various registration and authorization methods

Fingerprint	Fingerprint registration Fingerprint authorization
Card	Card registration Card authorization
Password	Password registration Password authorization
'OR' Combination Authentication	To be authorized successfully, one method among the registered should be authorized.
'AND' Combination Authentication	To be authorized successfully, all registered Auth methods should be authorized.

UNIONCOMMUNITY Co., Ltd.

**Addr : 12F, Munjeong Daemyeong Valeon bldg, 127 Beobwon-ro Songpa-gu,
Seoul, Korea (zip code : 05836)**

Tel : +82-2-6488-3000 , Fax : +82-2-6488-3099,

E-Mail : sales@unioncomm.co.kr; <http://www.unioncomm.co.kr>



2.2. Product components

2.2.1. Standalone use (Access)

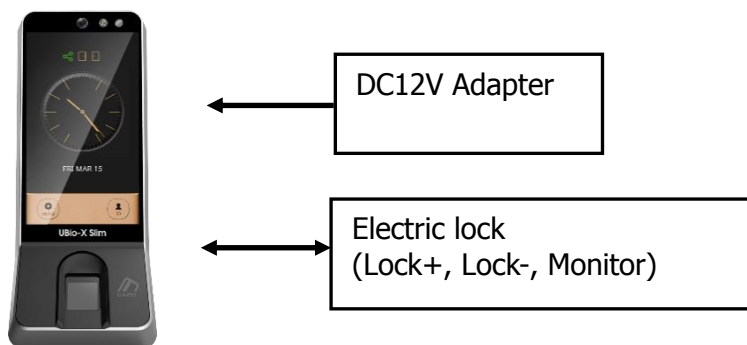

UNIONCOMMUNITY Co., Ltd.

**Addr : 12F, Munjeong Daemyeong Valeon bldg, 127 Beobwon-ro Songpa-gu,
Seoul, Korea (zip code : 05836)**

Tel : +82-2-6488-3000 , Fax : +82-2-6488-3099,

E-Mail : sales@unioncomm.co.kr; <http://www.unioncomm.co.kr>



2.3. Product specification

Types	SPEC	Remarks
CPU	1.4GHz Quad Core CPU	
LCD	4.95 inches Touch LCD(480*854)	
Memory	eMMC 8G Bytes Flash	
	2GByte RAM	
External USB support	Backup data / Upgrade firmware	
Camera	Still Capture Image Color (1600x1200)	
Camera Flash Sensor	Daylighting Flash Control	
Capacity	500,000 Users / 500,000 Cards 10,000,000 Logs / 50,000 Image logs	
Temperature / Humidity	-20 ~60°C / Lower than 90% RH	
AC / DC Adapter	INPUT : Universal AC100 ~ 250V	
	OUTPUT : DC 12V 3.5A	
	UL, CSA, CE Approved	
Lock Control	EM, Strike, Motor Lock, Auto Door	
I/O	4 In(1 Exit, 3 Monitors) 2 Out (2 Locks)	
Communication Port	RS-485	Communication with Controller
Card Reader	125KHz RF	
Dimension (mm)	80 X 195.6 X 23.5(Normal) / 54.67(Max)	Including Bracket

UNIONCOMMUNITY Co., Ltd.

**Addr : 12F, Munjeong Daemyeong Valeon bldg, 127 Beobwon-ro Songpa-gu,
Seoul, Korea (zip code : 05836)**

Tel : +82-2-6488-3000 , Fax : +82-2-6488-3099,

E-Mail : sales@unioncomm.co.kr; <http://www.unioncomm.co.kr>



3. Environment setting

3.1. Checks before setting the environment

3.1.1. Entering the menu by Administrator

Terminal users include general users and administrators. General users are only allowed to open the door while the administrator can use the Administrator menu to control the door as well as the terminal's functions.

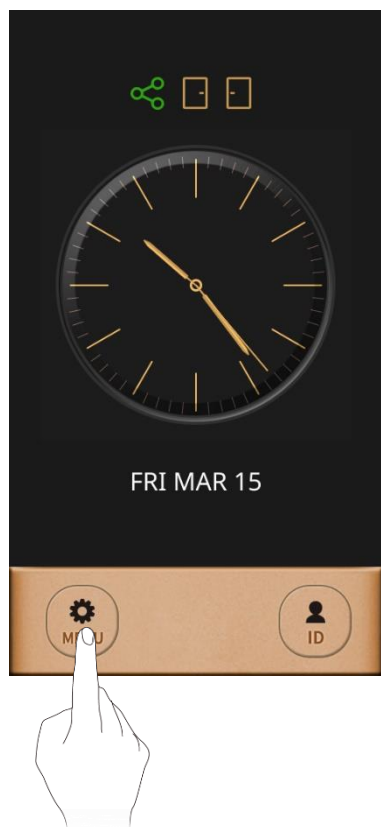

1. To enter the menu, touch the "MENU" button at the lower of the touch pad.
2. Input the administrator ID and follow the authentication process. The Administrator menu will be displayed. Because no users have yet been registered, any user can enter the Administrator menu. At least one administrator for should be registered for security purposes.



1. If no administrator was designated and only general users were registered in network mode, all users will be allowed to enter the Management menu.
2. If 1:N authentication is used, an administrator with a registered fingerprint can enter the Administrator menu using fingerprint authentication without entering his ID

UNIONCOMMUNITY Co., Ltd.

**Addr : 12F, Munjeong Daemyeong Valeon bldg, 127 Beobwon-ro Songpa-gu,
Seoul, Korea (zip code : 05836)**

Tel : +82-2-6488-3000 , Fax : +82-2-6488-3099,

E-Mail : sales@unioncomm.co.kr; <http://www.unioncomm.co.kr>

**UNION
COMMUNITY**

3.2. Menu composition

The Administrator menu has seven submenus as shown below.
The following describes each sub menu:

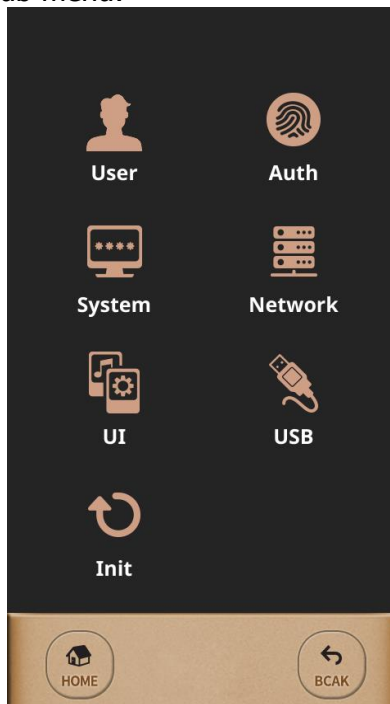

1. User	1. Register 2. Modify 3. Delete 4. List 5. Card Only	
2. Auth	1. Normal	<ul style="list-style-type: none"> ▶ 1:1 Auth Level (Default : 5) ▶ 1:N Auth Level (Default : 8) ▶ Auth Type (Default : Use Identify (1:N Auth)) ▶ Auth Order (Default : Terminal → Server)
	2. TnA	<ul style="list-style-type: none"> ▶ TnA Type (Default : Not Use) ▶ Auto TnA (Default : Not Use) ▶ TnA only (Default : Not Use)
	3. Timezone	
	4. Log	

UNIONCOMMUNITY Co., Ltd.

Addr : 12F, Munjeong Daemyeong Valeon bldg, 127 Beobwon-ro Songpa-gu, Seoul, Korea (zip code : 05836)

Tel : +82-2-6488-3000 , Fax : +82-2-6488-3099,

E-Mail : sales@unioncomm.co.kr; <http://www.unioncomm.co.kr>



3. System	1. Sensor	<ul style="list-style-type: none"> ▶ Capture Time Out (Default : 5 seconds) ▶ LFD Accuracy (Default : Not Use) ▶ Use Camera (Default : Not Use)
	2. Card	<ul style="list-style-type: none"> ▶ Card Type (Default : Not Use) ▶ Wiegand Type (Default : Not Use) ▶ Transfer Data (Default : Card Number) ▶ Site Code
	3. Door	<ul style="list-style-type: none"> ▶ Door Select (Default : Door1) ▶ Door Function (Default : Door) ▶ Lock Control Type (Default : Normal Close) ▶ Lock Open Time (Default : 5 seconds) ▶ Door Warning Time (Default : 20 seconds) ▶ Door Control Type (Default : Normal Close)
	4. RS485	<ul style="list-style-type: none"> ▶ RS485 Type (Default : Not Use) ▶ RS485 ID (Default : 0)
	5. Option	<ul style="list-style-type: none"> ▶ FP Template Count (Default : 2) ▶ ID length (Default : 4) ▶ Saving Log (Default : Yes) ▶ User Name Display (Default : Yes) ▶ Message Display Time (Default : 1 second) ▶ Tamper Alarm (Default : Mute)
	6. Information	<ul style="list-style-type: none"> ▶ Terminal ID (Default : 1) ▶ User / Template ▶ Admin ▶ TnA mode ▶ Card Type ▶ Network Type ▶ IP Address ▶ Version (Firmware – Kernel \ File System)

UNIONCOMMUNITY Co., Ltd.

Addr : 12F, Munjeong Daemyeong Valeon bldg, 127 Beobwon-ro Songpa-gu, Seoul, Korea (zip code : 05836)

Tel : +82-2-6488-3000 , Fax : +82-2-6488-3099,

E-Mail : sales@unioncomm.co.kr; <http://www.unioncomm.co.kr>



4. Network	1. Normal	<ul style="list-style-type: none"> ▶ Network Type (Default : Wireline) ▶ Terminal ID (Default : 1) ▶ Server IP (Default : 192.168.0.2) ▶ Port Number (Default : 7332) ▶ Encryption (Default : DES) ▶ Ping Time (Default : 10 seconds)
5. UI	1. Sound	<ul style="list-style-type: none"> ▶ Sound Type (Default : Effect Only) ▶ Volume (Default : 1)
	2. Display	<ul style="list-style-type: none"> ▶ Language (Default : English) ▶ LCD Brightness (Default : 3) ▶ Main Display (Default : Analog Clock) ▶ Waiting Time (Default : 3 minutes) ▶ Screen Saver ▶ Date (Default : System Date) ▶ Time (Default : System Time)
6. USB	1. User Download	
	2. User Upload	
	3. Log Download	
	4. F/W Update	
7. Initialize	1. Delete User	
	2. Delete Log	
	3. Initialize Option	
	4. Restart	

3.3. User

When you select the **[User]** at the main menu, the following window appears.



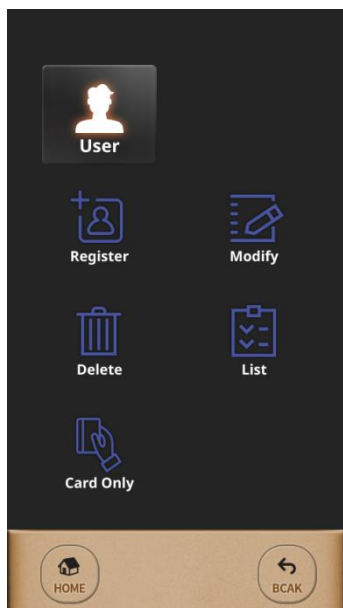

Administrator can do register, delete, modify, search for the user by using the 'User' menu.

3.3.1. Register

The maximum number of users to enroll to the terminal are 200,000 templates for FP users but Card users or PW user can be enrolled up to 500,000 users. For example, when 10,000 users have 200,000 FP templates totally stored on the terminal, 490,000 users have the Card or PW can be registered on the terminal additionally.

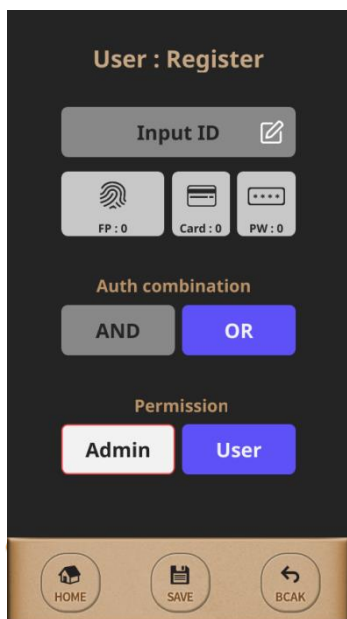

1. To register a new user to the terminal, select [Menu] → [User] → [Register] in order.
2. Insert the User ID you want to give after pressing the button "Input ID".
3. When selecting the button [Admin] from 'Permission', this user's privilege will be changed. Basically there are two buttons to select the user's privilege between administrator and normal user.

The first registered user from terminal will be an administrator automatically.

Administrator and normal user have the different privilege as below.

- User : Access door only
- Admin : Access door + Enter the menu mode of terminal

To finish registration of user from the terminal, at least more than one Auth method should be registered among 'FP', 'Card', 'PW'. And then the user will be registered when pressing the button [SAVE] after selecting 'Auth combination'.

3.3.2. Modify

When modifying the registered user from the terminal, 'Group', 'Permission', 'FP', 'Card', 'PW', 'Auth combination' can be modified freely except 'User ID' because it is an unique identifying number so that it couldn't be modified after registration. And also it is possible on Standalone mode which the network type is 'Not Use'. So you have to modify the registered user from the Server software on Network mode.

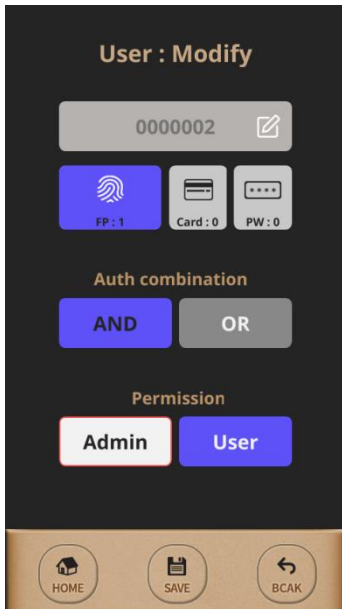

1. To modify the registered user from the terminal, select [Menu] → [User] → [Modify] in order. And then the user information will be shown as left picture after inserting the User ID whose want to be modified.
2. To finish modification of user info from the terminal, press the button [SAVE] after modifying the user info which is wanted.

3.3.3. Delete

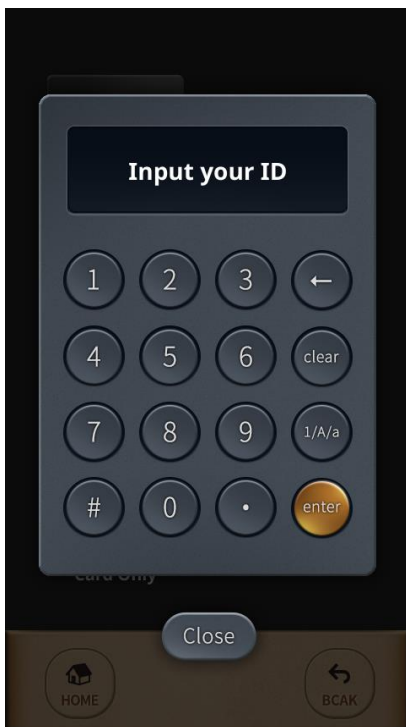

To delete the registered user from the terminal, select [Menu] → [User] → [Delete] in order. And then press the button [enter] after inserting the User ID whose want to be deleted. When pressing the button [Close], the deletion will be cancelled.

If inserting invalid User ID or an unregistered User ID, Error message will be displayed but if inserting valid User ID or registered User ID, the below window will be shown.

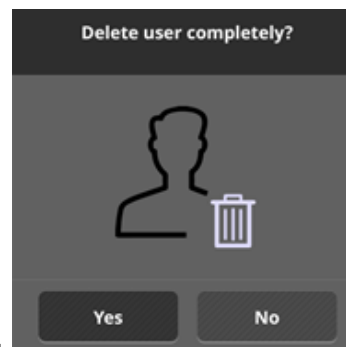

To query the registered user list from the terminal, select [Menu] → [User] → [List] in order.

3.3.5. Card Only

The model "UBio-X Slim" realizes more convenient to control the door by Card only without using fingerprint or password. The button [Card Only] is used easier to enroll the Card users seamlessly but this feature should be worked under network mode.

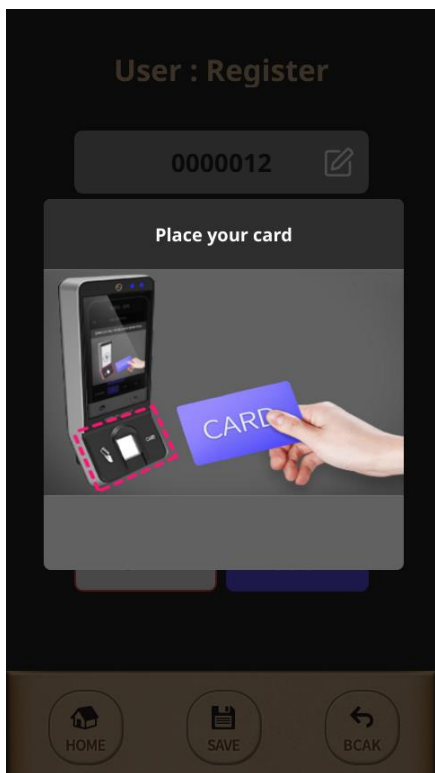

To enroll the card users seamlessly from the terminal, select [Menu] → [User] → [Card Only] in order.

And then the message "Place your card" will be shown as left picture.

If swiping new card to the terminal, the card user can be enrolled easily as creating a new User ID automatically.

For authorizing the registered card, you can swipe the card from the terminal without inserting User ID.

3.4. Auth

Select [Menu] → [Auth] in order from the terminal, the below picture will be shown.

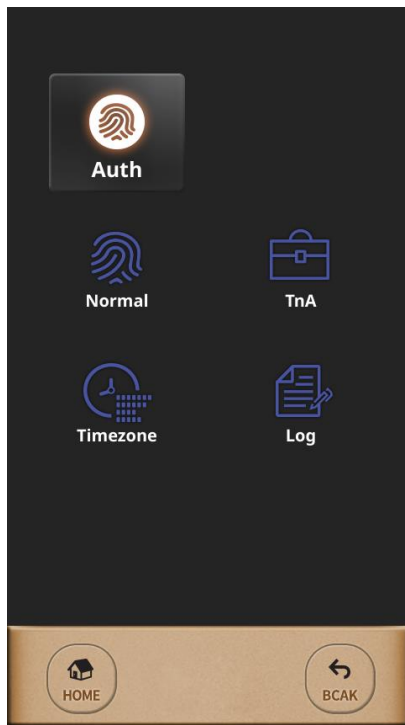

This menu is to configure the Authentication option, TnA mode, Timezone and to search the log information.

3.4.1. Normal

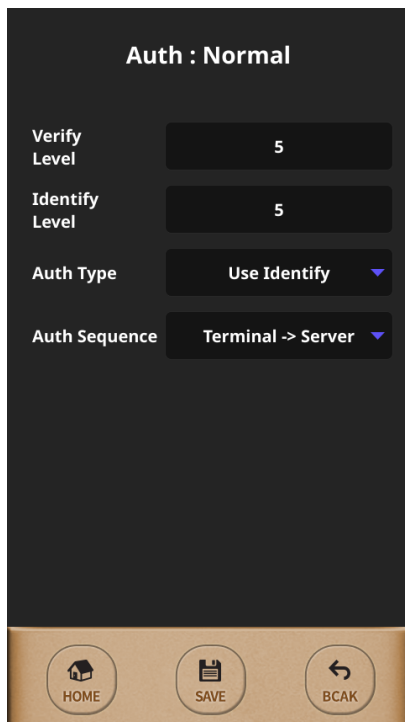

To set the 'Verify Level(1:1)', 'Identify Level(1:N)', 'Auth Type' and 'Auth Sequence' from the terminal, select [Menu] → [Auth] → [Normal] in order.

Verify Level / Identify Level

Security Level for FP is adjustable per each Auth Type. For Verify Level(1:1), default is 5 but it can be selected from 1 to 9. For Identify Level(1:N), default is 8 but it can be selected from 5 to 9. Security Level is too higher, FRR(False Rejection Rate) is more increasingly but it is too lower, FAR(False Acceptance Rate) is more increasingly. So please use the default value if not special case. These are applied to all users except the user has the individual setting on registration.

Auth Type

The model "UBio-X Slim" supports both 1:1 and 1:N Auth Types. When using 1:1, insert the User ID or swipe his registered Card before placing his registered finger. But using 1:N, place your finger without input User ID or swipe the Card

UNIONCOMMUNITY Co., Ltd.

Addr : 12F, Munjeong Daemyeong Valeon bldg, 127 Beobwon-ro Songpa-gu, Seoul, Korea (zip code : 05836)

Tel : +82-2-6488-3000 , Fax : +82-2-6488-3099,

E-Mail : sales@unioncomm.co.kr; <http://www.unioncomm.co.kr>



because matching the fingerprint against all user data.

However, if you want to be authenticated faster, to use 1:1 is better than to use 1:N even 1:N is more convenient than 1:1.

Auth Sequence

There are 4 Auth Sequence modes in "UBio-X Slim". And these are operated with Server software.

- Server → Terminal : Authentication starts by Server and if it was not searched, authentication will be started by Terminal automatically.
- Server Only : Authentication should be done by Server only.
- Terminal → Server : Authentication starts by Terminal and if it was not searched, authentication will be started by Server automatically..
- Terminal Only : Authentication should be done by Terminal only.

3.4.2. TnA

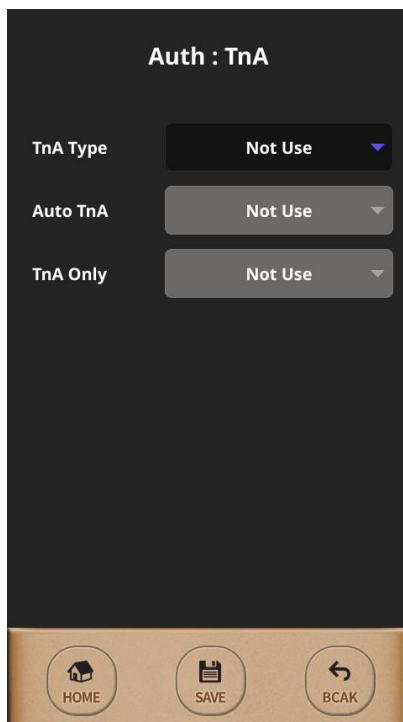

When using TnA mode, the user should press the Function key before authentication, and then the authentication log will be transferred with the pressed function key number.

It makes manage the TnA efficiently when pressing each Function key for employee's situation. (F1(Attend), F2(Leave), F3(Out), F4(In))

There are three TnA types in "UBio-X Slim" and it is selectable among 'Simple', 'Normal', 'Expand'.

'Simple' type has 2 Function keys and 'Normal' type has 4 Function keys, 'Expand' type supports the multiple Function keys up to 63keys.

'Simple' & 'Normal' types have the fixed function keys as below.

(F1 : Attend / F2 : Leave / F3 : Out / F4 : In)

In case 'Expand' type, the Function keys are editable freely by software administrator.

UNIONCOMMUNITY Co., Ltd.

Addr : 12F, Munjeong Daemyeong Valeon bldg, 127 Beobwon-ro Songpa-gu, Seoul, Korea (zip code : 05836)

Tel : +82-2-6488-3000 , Fax : +82-2-6488-3099,

E-Mail : sales@unioncomm.co.kr; <http://www.unioncomm.co.kr>



3.4.3. Timezone

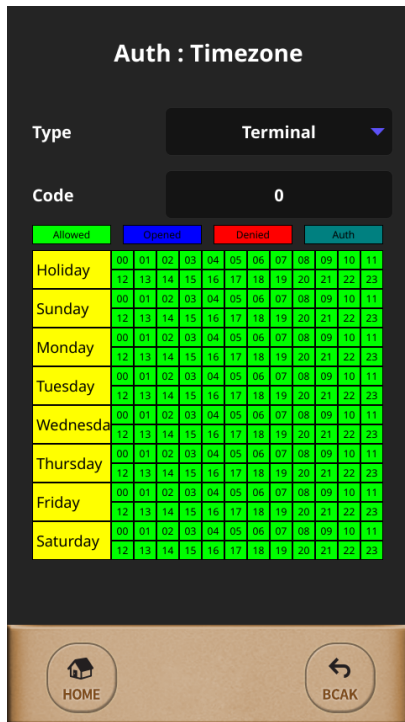

If using the feature terminal's timezone, it is possible to grant to access or deny to access per each period or per each time. But this feature can be used to set the door access on Network mode only.

It is possible to set the timezone for each terminal or for each user with selecting the button 'Type'.

The time table consists Day and Time as the left picture and it can be checked the terminal's timezone or a configured user's timezone.

 **Caution for setting the timezone**
 The timezone is set the server management software only so that it is not possible to set it on the terminal.

3.4.4. Log

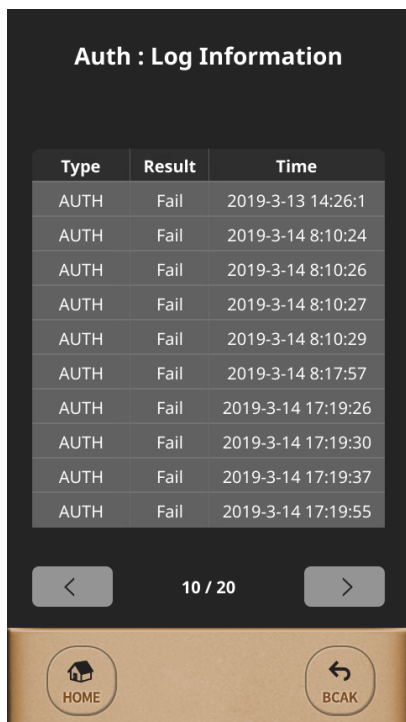

This is the feature to check the authentication logs for the terminal's user.

3.5. System

Select [Menu] → [System] in order from the terminal, the below picture will be shown.

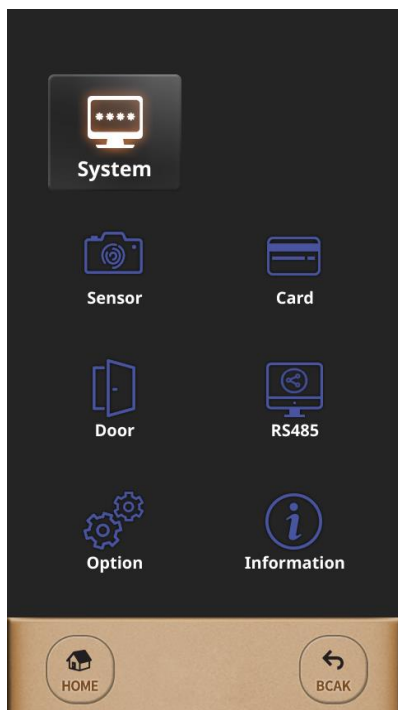

This menu is to configure Sensor, Card, Door, Option for Door and check the terminal's information.

3.5.1. Sensor

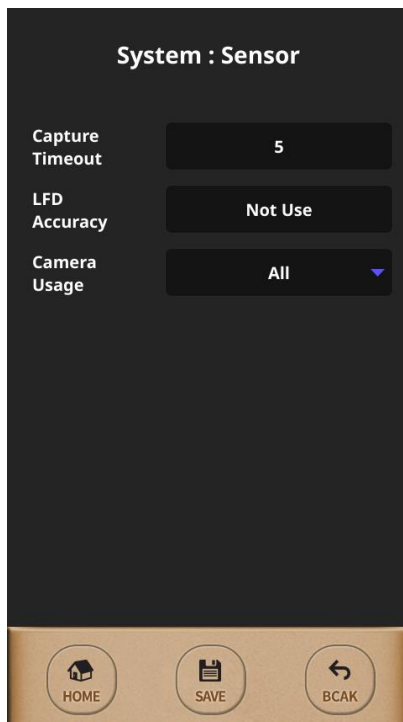

This menu is used to set the Sensor Mode, Capture Timeout, LFD Accuracy, Sensor Brightness for the fingerprint sensor. And when selecting the terminal basic sensor setting, this setting will be applied to all users who are registered as selecting not individual sensor setting.

Capture Timeout

This is the standby time for capturing fingerprint and it is adjustable from 3 to 9 seconds. (Default : 5 seconds)

LFD(Live Finger Detection) Accuracy

This menu is used to set the level to inspect the fake finger and to use it. This is graded from 0 to 3 as below.

'Not use'(0), 'Low'(1), 'Middle'(2), 'High'(3)

Camera Usage

This menu is set the camera using condition. For example, the camera will be operated for authentication success when selecting "Success". And when selecting "All", the camera will be operated regardless of authentication success.

When selecting 'Not Use', the fingerprint image or other suitable image will be displayed.

3.5.2. Card

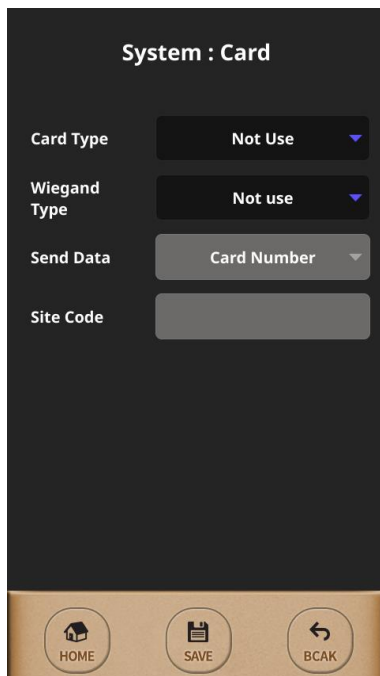

This menu is used to set the Card authentication for terminal's user.

Card Type

It is selectable among 'Not Use', 'EM', 'MIFARE', 'HID26Bit', 'HID35Bit', 'HID37Bit', 'iClass26bit', 'iClass35bit', 'iClass37bit'.

Send Data

It is used to select the Wiegand Out data between 'Card Number' to 'User ID'. When selecting 'User ID', 4 digits User ID will be out after authentication success via Wiegand Out but when selecting 'Card Number', the card serial number(CSN) will be out.

Site Code

This option is used only on selecting 'User ID' and it can be out differently per each Wiegand bit between 26bit and 34bit as below.

- Site Code for Wiegand 26bit : 0 ~ 255
- Site Code for Wigand 34bit : 0 ~ 32767

UNIONCOMMUNITY Co., Ltd.

**Addr : 12F, Munjeong Daemyeong Valeon bldg, 127 Beobwon-ro Songpa-gu,
Seoul, Korea (zip code : 05836)**

Tel : +82-2-6488-3000 , Fax : +82-2-6488-3099,

E-Mail : sales@unioncomm.co.kr; <http://www.unioncomm.co.kr>

**UNION
COMMUNITY**

3.5.3. Door

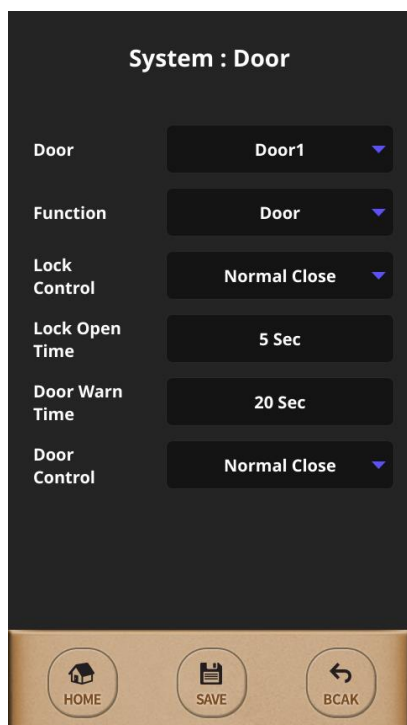

There are two functions on this menu. one is able to control two doors and the other is able to support the Fire alarm or lighting lamp after connecting each external device.

Function

It is selectable among 'Not Use', 'Door', 'Fire Alarm', 'Light Alarm'.

Lock Control

It is selectable between 'Normal Close', 'Normal Open' for lock control type.

Lock Open Time

It can be set the door open time.

Door Warn Time

It can be set the time for door open too long.

Door Control

It is selectable for door monitoring sensor type between 'Normal Close', 'Normal Open'.

3.5.4 RS485

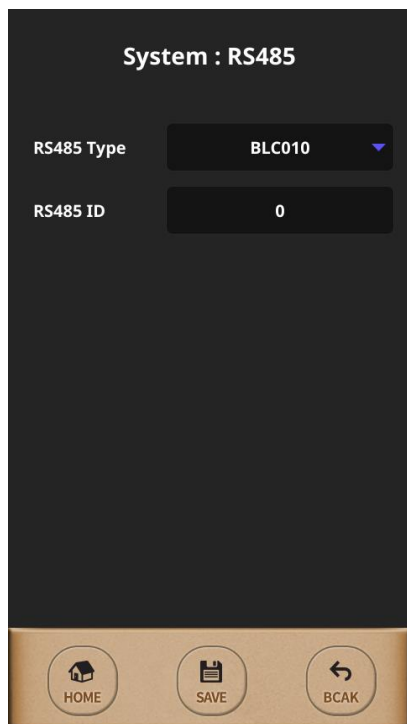

This menu is used to set the external device is communicated to "UBio-X Slim" via RS485.

RS485 Type

It is selectable between 'Not Use' and 'BLC010'.

RS485 ID

When using RS485 communication with the external controller, "UBio-X Slim" device should be given the RS485 ID differently from 0 to 7 as a reader.

3.5.5 Option

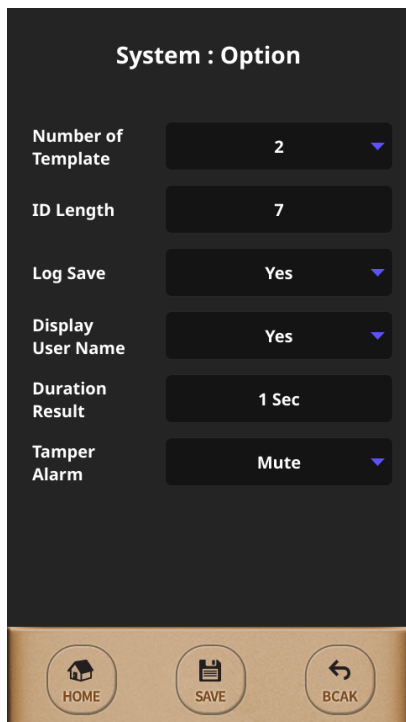

This menu is used to set other terminal options as the left picture. The option 'Number of Template' decides the fingerprint count and the option 'ID Length' on user enrollment.

So all registered users on terminal must be deleted before changing these two options.

Number of Template

It is selectable between 1 to 2. (Default : 2)

ID Length

It is selectable from 4 to 20. (Default : 4)

Log Save

It decides to save the log for authentication result.

Display User Name

It decides to display the user name when authentication success.

Duration Result

It decides the displaying time for the authentication result.

Tamper Alarm

It decides to mute for Tamper Alarm.

3.5.6 Information

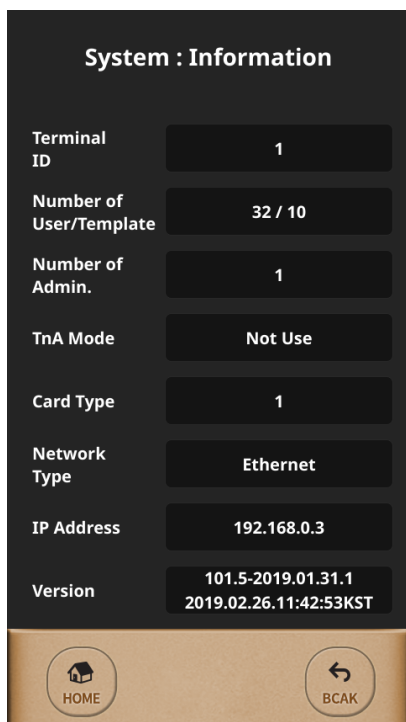

This menu gives information about the terminal as the left picture. this is not editable but the read only menu for 'Terminal ID', 'Stored user & template counts', 'Number of admin', 'TnA mode', 'Network Type' 'Terminal IP address', 'Firmware version', etc.

UNIONCOMMUNITY Co., Ltd.

Addr : 12F, Munjeong Daemyeong Valeon bldg, 127 Beobwon-ro Songpa-gu, Seoul, Korea (zip code : 05836)

Tel : +82-2-6488-3000 , Fax : +82-2-6488-3099,

E-Mail : sales@unioncomm.co.kr; <http://www.unioncomm.co.kr>



3.6. Network

Select [Menu] → [Network] in order from the terminal, the below picture will be shown.

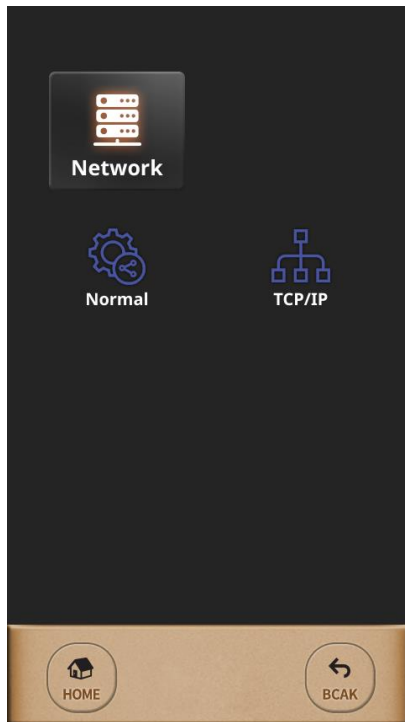

There are two sub menus 'Normal' and 'TCP/IP' under [Network] as the left picture.

3.6.1. Normal

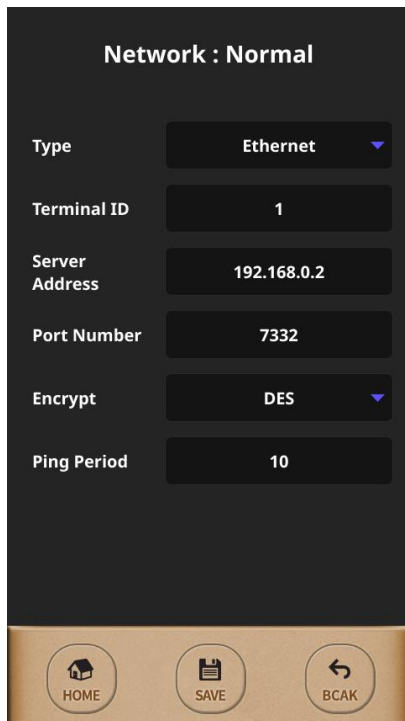

There are two modes 'Network mode' and 'Standalone mode' on "UBio-X Slim" model. And the 'Network mode' divided by 'Wireline' and 'Wireless'.

Type

It is selectable among 'Not Use', 'Ethernet', 'WIFI'.

If selecting 'Not Use', terminal is worked as a Standalone mode which is operated independently without connecting network. In this case, authentication is proceeded on the internal database of the terminal only.

But if selecting 'Ethernet' or 'WIFI', terminal is worked as a Network mode is cooperated with the Server software.

Meanwhile, the mode 'WIFI' is not serviced currently but it will be added on next.

Terminal ID

Terminal ID should be given differently from 1 to 2000 because it is the unique ID. It is not duplicable.

Server Address

UNIONCOMMUNITY Co., Ltd.

Addr : 12F, Munjeong Daemyeong Valeon bldg, 127 Beobwon-ro Songpa-gu, Seoul, Korea (zip code : 05836)

Tel : +82-2-6488-3000 , Fax : +82-2-6488-3099,

E-Mail : sales@unioncomm.co.kr; <http://www.unioncomm.co.kr>



It should be inserted for IP address of the Server PC which is installed the Server software.

Port Number

It should be inserted for the communication port number between server to terminal.

Ping Period

It decides the polling duration to check the communication status between server to terminal. It is given from 2 to 20. (Default : 10 seconds)

3.7. UI

Select [Menu] → [UI] in order from the terminal, the below picture will be shown.

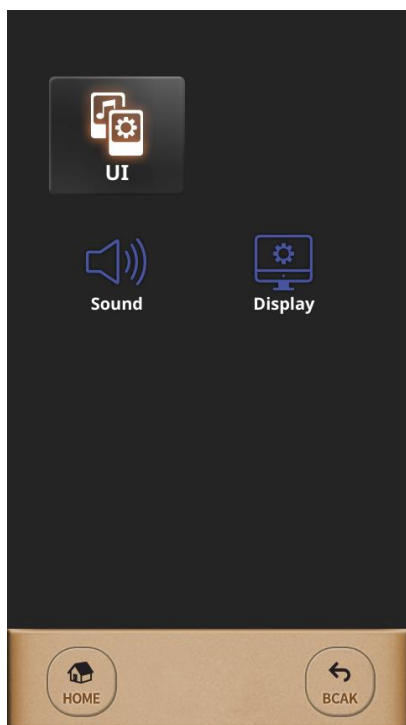

This menu is used to set the terminal display option and sound option as the left picture. And it makes to change freely as customer wants for the terminal's main display, language, date & time, sound, etc.

UNIONCOMMUNITY Co., Ltd.

Addr : 12F, Munjeong Daemyeong Valeon bldg, 127 Beobwon-ro Songpa-gu, Seoul, Korea (zip code : 05836)

Tel : +82-2-6488-3000 , Fax : +82-2-6488-3099,

E-Mail : sales@unioncomm.co.kr; <http://www.unioncomm.co.kr>



3.7.1. Sound

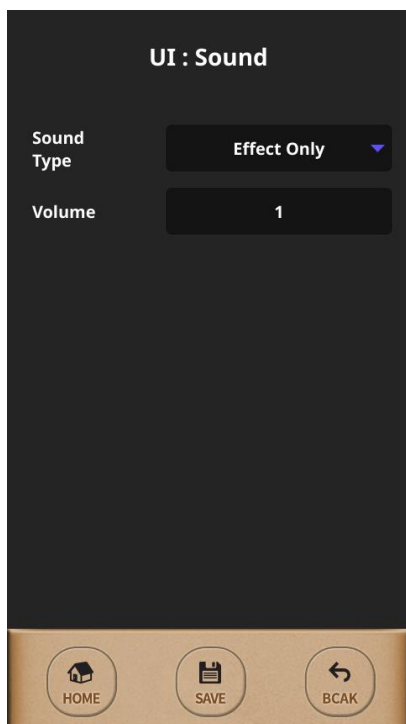

This menu is used to set the Sound type about both voice & effect and control its volume.

3.7.2. Display

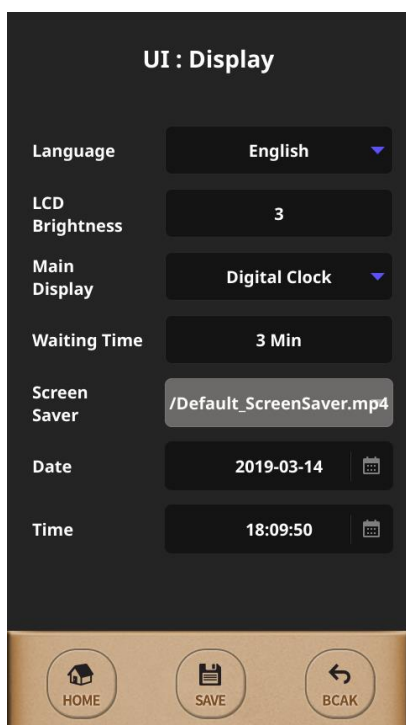

Language

Language for terminal can be selected which you want to use.

LCD Brightness

This is adjustable from 1 to 5 and default is 3.

Main Display

It is selectable among 'Analog Clock', 'Digital Clock', 'Logo Image'.

Date & Time

Terminal's data & time is adjustable manually on the Standalone mode.

UNIONCOMMUNITY Co., Ltd.

Addr : 12F, Munjeong Daemyeong Valeon bldg, 127 Beobwon-ro Songpa-gu, Seoul, Korea (zip code : 05836)

Tel : +82-2-6488-3000 , Fax : +82-2-6488-3099,

E-Mail : sales@unioncomm.co.kr; <http://www.unioncomm.co.kr>



3.8. USB

Select [Menu] → [USB] in order from the terminal, the below picture will be shown.

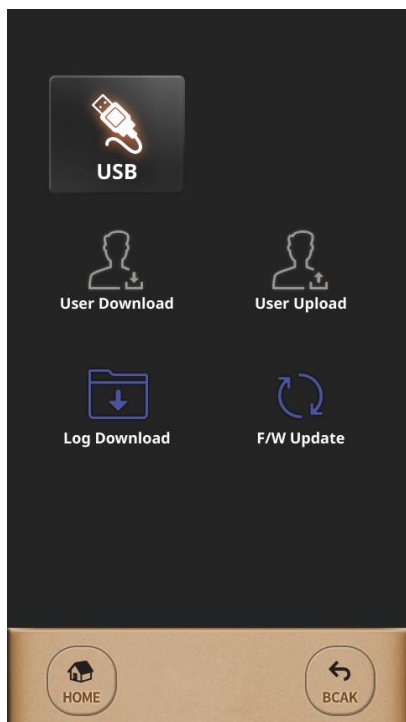

This menu is used to upload or to download the user data or log data via USB memory.

Basically, this feature works all options 'User Download', 'User Upload', 'Log Download' on Standalone mode but on network mode, it is possible to use 'Log Download' only.

3.8.1. F/W Update



It is possible to update the firmware by using USB memory. When selecting the target file from the firmware file list as left picture, terminal will be rebooted automatically after finishing updating as showing below picture.

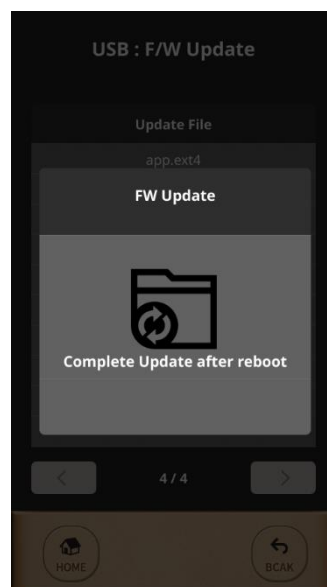

UNIONCOMMUNITY Co., Ltd.

Addr : 12F, Munjeong Daemyeong Valeon bldg, 127 Beobwon-ro Songpa-gu, Seoul, Korea (zip code : 05836)

Tel : +82-2-6488-3000 , Fax : +82-2-6488-3099,

E-Mail : sales@unioncomm.co.kr; <http://www.unioncomm.co.kr>



3.9. Connect your BT module with your app

3.9.1. BT module activation

In order for BT module to be detected in the app, the BT module must be detected in the app, the BT module must be activated and activated by briefly touching the BT icon on the recognizer as shown below.

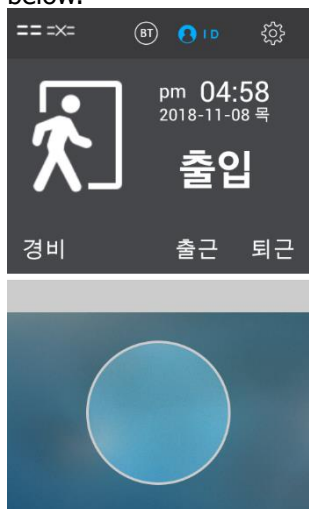

3.9.2. BT module connection wait status

In the active state, it is displayed as below.

Displays the model name, master ID, and BT module MAC address of the recognizer.

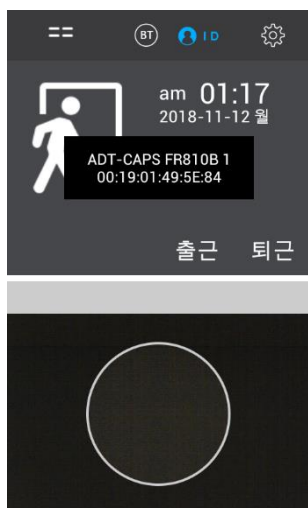

3.9.3. Search and access your app's BT module

If you click Bluetooth search after login the app, BT module information will be searched as shown below.

Select the BT module and try to connect.

UNIONCOMMUNITY Co., Ltd.

Addr : 12F, Munjeong Daemyeong Valeon bldg, 127 Beobwon-ro Songpa-gu, Seoul, Korea (zip code : 05836)

Tel : +82-2-6488-3000 , Fax : +82-2-6488-3099,

E-Mail : sales@unioncomm.co.kr; <http://www.unioncomm.co.kr>



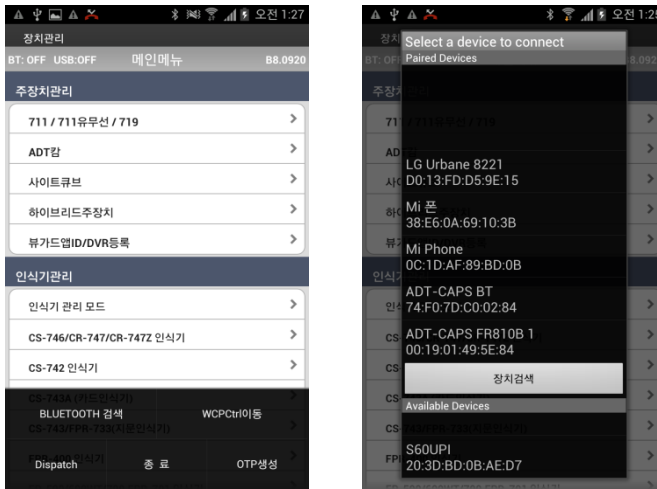

3.9.4. Connected app and BT module

When the app BT module is connected, it will be displayed as the following figure. The app will say "Bluetooth connected" and the BT icon will turn on the recognizer screen as shown below.



3.9.5. Disconnect from app and BT module in recognizer

If the BT module is connected to the app (the BT icon is displayed in blue), or you briefly touch the BT icon while BT is active, you will see "BT Disconnecting ..." Will be Disconnected from the app.

UNIONCOMMUNITY Co., Ltd.

Addr : 12F, Munjeong Daemyeong Valeon bldg, 127 Beobwon-ro Songpa-gu, Seoul, Korea (zip code : 05836)

Tel : +82-2-6488-3000 , Fax : +82-2-6488-3099,

E-Mail : sales@unioncomm.co.kr; <http://www.unioncomm.co.kr>



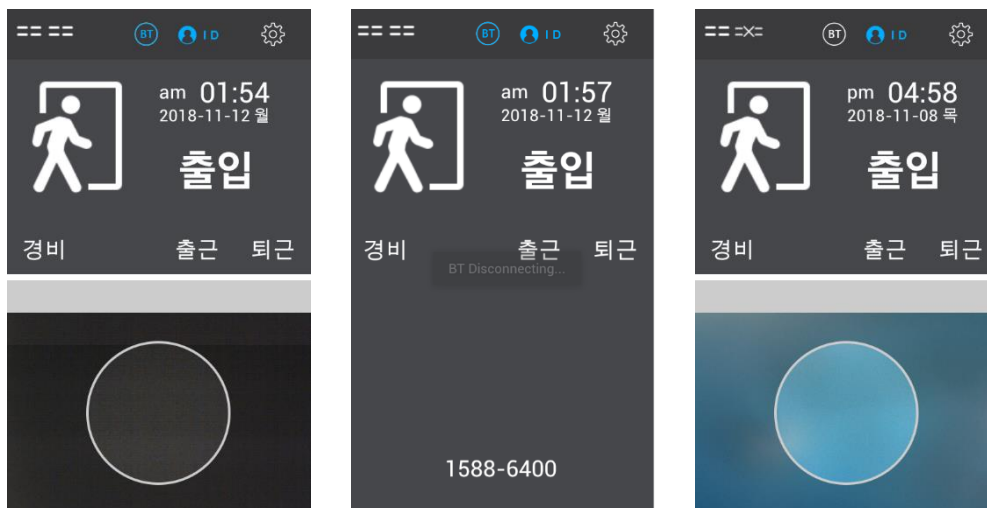

3.10. Initialize

Select [Menu] → [Initialize] in order from the terminal, the below picture will be shown.

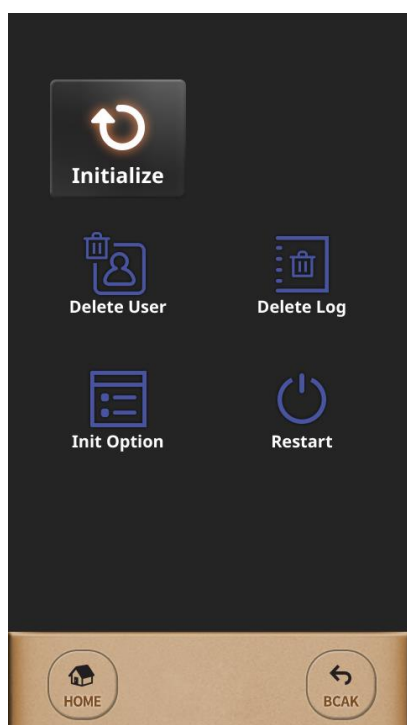

This menu is used to set back to the factory format for all terminal's user data, stored log data and configured options. So please be cautious for these initialization because it is not recoverable.

4. How to use terminal

4.1. How to open the door

There are two below methods to open the door with authentication from the terminal basically.

1:1 Verification

This 1:1 Verification can access the door much faster regardless of the number of users on the terminal because it compares only between the inserted fingerprint to the stored fingerprint of the pressed User ID.

As shown in the figure below, press the button [ID] to input the registered User ID first and then input the fingerprint or password after pressing the button [enter].



1:N Identification

This method is that the registered fingerprint is placed on the fingerprint sensor in the main screen without inserting User ID. But it can take somewhat long time to authenticate because it compares the inserted fingerprint to all fingerprint data in spite of much more convenient than 1:1 Verification.

① Fingerprint Authentication

Insert the fingerprint on the fingerprint sensor without inputting User ID.



② Card Authentication

Swipe the Card on the Card Sensing Area without inserting User ID.

If the User ID should be pressed certainly before inserting fingerprint, please check terminal option 'Use Identify' is not selected.

 '1:N Identify' for password user is same to '1:1 Verify'.

4.2. How to punch for TnA

In TnA mode, user must click function key before authentication. And the log is transferred to server with information which function key is selected. If the function key was not pressed on authentication, it is possible not to record the TnA type firmly for user's 'Attend', 'Leave', 'Out', 'In'. So it should be pressed for each case before authentication.

"UBio-X Slim" model displays the Function keys on the bottom side as following pictures.

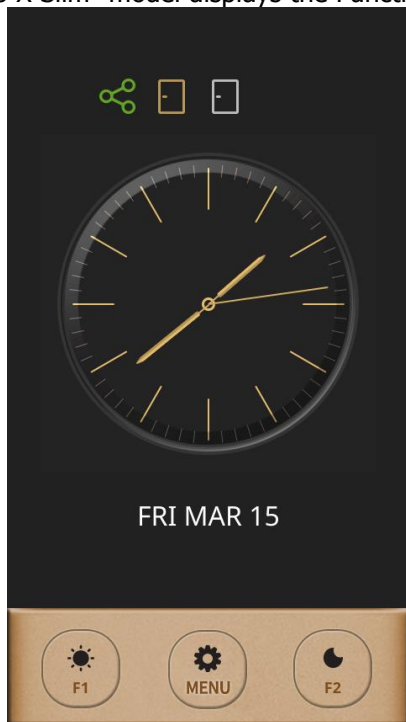

Simple TnA mode

In this mode, the User ID is pressed after pressing Function key and then try to authenticate.

The function keys in Simple TnA mode are defined as below.

- F1: Attend
- F2: Leave

If the function key is pressed before authentication, the pressed key "F1" or "F2" will be recorded on the authentication logs so that they are used on Time & Attendance software.

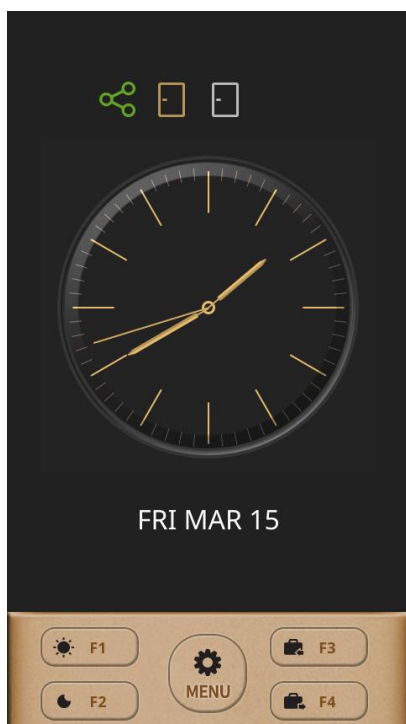

Normal TnA mode

In this mode, the User ID is pressed after pressing Function key and then try to authenticate.

The function keys in Normal TnA mode are defined as below.

- F1: Attend
- F2: Leave
- F3: Out
- F4: In

If the function key is pressed before authentication, the pressed key "F1" to "F4" will be recorded on the authentication logs so that they are used on Time & Attendance software.

UNIONCOMMUNITY Co., Ltd.

Addr : 12F, Munjeong Daemyeong Valeon bldg, 127 Beobwon-ro Songpa-gu, Seoul, Korea (zip code : 05836)

Tel : +82-2-6488-3000 , Fax : +82-2-6488-3099,

E-Mail : sales@unioncomm.co.kr; <http://www.unioncomm.co.kr>



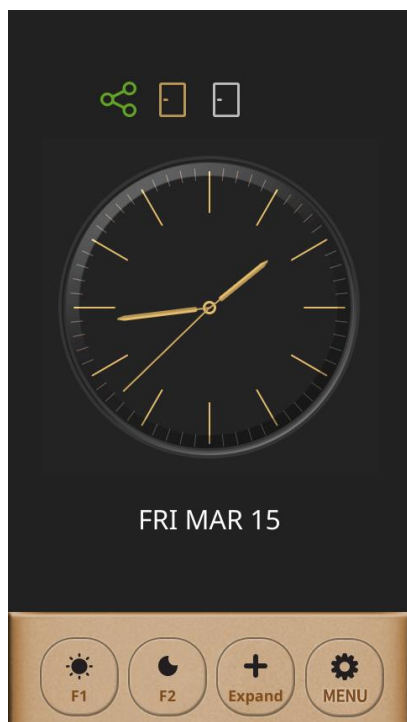

Expand TnA mode

In this mode, the Function keys on the bottom side as the left picture.

When pressing the function key "Expand", the User ID is pressed after pressing Function key number which you want up to 63 and then try to authenticate.

TIP If you want to use 1:N identification on TnA mode, try to authenticate directly after pressing Function key without inserting User ID.

TIP When selecting 'TnA Only' to use, the Function key MUST be pressed for authentication.

UNIONCOMMUNITY Co., Ltd.

**Addr : 12F, Munjeong Daemyeong Valeon bldg, 127 Beobwon-ro Songpa-gu,
Seoul, Korea (zip code : 05836)**

Tel : +82-2-6488-3000 , Fax : +82-2-6488-3099,

E-Mail : sales@unioncomm.co.kr; <http://www.unioncomm.co.kr>

**UNION
COMMUNITY**

FCC Information

This device complies with part 15 of the FCC Results. Operation is subject to the following two conditions :

- (1) This Device may not cause harmful interface, and
- (2) This device must accept any interference received, including interference that may cause undesired operation.

Note: This equipment has been tested and found to comply with the limits for CLASS B digital device, pursuant to Part 15 of FCC Rules. These limits are designed to provide reasonable protection against harmful interference when the equipment is operated in a commercial environment This equipment generates, uses and can radiate radio frequency energy and, if not installed and used in accordance with the instructions, may cause harmful interference to radio communications. However, there is no guarantee that interference will not occur in a particular installation. If this equipment does cause harmful interference to radio or television reception, which can be determined by turning the equipment off and on, the user is encouraged to try correct the interference by one or more of the following measures:

- 1.1. Reorient or relocate the receiving antenna.
- 1.2. Increase the separation between the equipment and receiver.
- 1.3. Connect the equipment into an outlet on a circuit different from that to which receiver is connected.
- 1.4. Consult the dealer or experienced radio/TV technician for help.

WARNING

Changes or modifications not expressly approved by the manufacturer could void the user's authority to operate the equipment.

FCC RF Radiation Exposure Statement:

This equipment complies with FCC RF radiation exposure limits set forth for an uncontrolled environment.

This equipment should be installed and operated with a minimum distance of 20 centimeters between the radiator and your body.

This transmitter must not be co-located or operating in conjunction with any other antenna or transmitter.

UNIONCOMMUNITY Co., Ltd.

**Addr : 12F, Munjeong Daemyeong Valeon bldg, 127 Beobwon-ro Songpa-gu,
Seoul, Korea (zip code : 05836)**

Tel : +82-2-6488-3000 , Fax : +82-2-6488-3099,

E-Mail : sales@unioncomm.co.kr; <http://www.unioncomm.co.kr>

UNION
COMMUNITY

“CAUTION : Exposure to Radio Frequency Radiation.

Antenna shall be mounted in such a manner to minimize the potential for human contact during normal operation. The antenna should not be contacted during operation to avoid the possibility of exceeding the FCC radio frequency exposure limit.

Contains FCC ID: 2AEEY-PBLN51822M

Supplier Name: Viridi USA Inc

Supplier Address (USA): 8900 Winnetka Ave, Northridge, CA 91324, USA

Supplier phone number and / or internet contact information: +1 917 559 3365

UNIONCOMMUNITY Co., Ltd.

**Addr : 12F, Munjeong Daemyeong Valeon bldg, 127 Beobwon-ro Songpa-gu,
Seoul, Korea (zip code : 05836)**

Tel : +82-2-6488-3000 , Fax : +82-2-6488-3099,

E-Mail : sales@unioncomm.co.kr; <http://www.unioncomm.co.kr>

