





Test Report

Test Report No.:	KT109EF12003		
Registration No.:	99058		
Applicant:	UNIONCOMMUNITY		
Applicant Address:	3F, Hyundai Topics Bldg., 44-3, Bangi-dong, Songpa-gu, Seoul, 138-050, Korea		
Product:	Access Controller		
FCC ID:	XX2-AC1000SA	Model No.	AC 1000SA, LACT-10S
Receipt No.:	09-1150	Date of receipt:	November 23, 2009
Date of Issue:	December 01, 2009		
Testing location	Korea Technology Institute Co., Ltd. 51-19, Sanglim3-Ri, Docheok-Myeun, Gwangju-Shi, Gyeongki-Do, Korea		
Test Standards:	FCC/ANSI. C63.4: 2003		
Rule Parts: FCC	Part 15, Class B		
Equipment Class:	Digital device		
Test Result:	The above-mentioned product has been tested with compliance.		
Tested by: T.W. Lee / Engineer  _____ Signature Date		Approved by: G. C. Min /President  _____ Signature Date	
Other Aspects:			
Abbreviations:	* OK, Pass=passed * Fail=failed * N/A=not applicable		
<p>☞ - This test report is not permitted to copy partly without our permission.</p> <p>- This test result is dependent on only equipment to be used.</p> <p>- This test result is based on a single evaluation of one sample of the above mentioned.</p> <p>- This test report must not be used by the client to claim product endorsement by NVLAP or any agency of the U.S Government.</p> <p>- We certify this test report has been based on the measurement standards that is traceable to the national or international standards.</p>			



>> Contents <<

Contents	2
List of Tables	2
List of Figures	2
List of Photographs	2
1. General	4
2. Test Site	4
2.1 Location	4
2.2 List of Test and Measurement Instruments	4
2.3 Test Date	5
2.4 Test Environment	5
3. Description of the tested samples	6
3.1 Rating and Physical characteristics	6
3.2 Submitted documents	6
4. Measurement conditions	7
4.1 Modes of operation	7
4.2 Additional Equipment	7
4.3 Uncertainty	7
4.4 Test Setup	8
5. TEST AND MEASUREMENTS	9
5.1 Antenna Requirement	9
5.1.1 Regulation	9
5.1.2 Results	9
5.2 Emission Test	10
5.2.1 Conducted Emissions	10
5.2.2 Radiated Emissions	14
5.2.2.1 Regulation	14
5.2.2.2 Measurement Procedure	14
5.2.2.3 Calculation of the field strength limits below 30 MHz	15
5.2.2.4 Test Results	16
5.2.2.5 Calculation of the field strength limits above 30 MHz	17
5.2.2.6 Test Results	17



»» **Contents** ««

5. 5.3 Spectrum mask and Occupied bandwidth	20
5.3.1 Regulation	20
5.3.2 Measurement Procedure	20
5.3.3 Test Results	21
5.4 Frequency Tolerance of Carrier Signal	23
5.4.1 Regulation	23
5.4.2 Measurement Procedure	23
5.4.3 Test Results	24
6. Photograph of the Test Set-Up	25

>> List of Tables

Table 1	List of test and measurement equipment	5
Table 2	Test Data. Conducted Emissions	13
Table 3	Test Data, Fundamental Frequency (Ver / Hor)	16
Table 4	Test Data, Radiated Emission below 30 MHz	16
Table 5	Test Data, Radiated Emission above 30 MHz	18
Table 6	Test Data, Frequency Tolerance of carrier signal	24

>> List of Figures

Figure 1	Test Setup	8
Figure 2	Spectral Diagram, LINE-PE	11
Figure 3	Spectral Diagram, NEUTRAL-PE	12
Figure 4	Radiated spurious emissions below 30 MHz	17
Figure 5	Radiated spurious emissions above 30 MHz	19
Figure 6	Spectrum Mask	21
Figure 7	Occupied Bandwidth	22

>> List of Photographs

Photograph 1	Setup for radiated Emissions (below 30 MHz)	25
Photograph 2	Setup for radiated Emissions (above 30 MHz)	26
Photograph 3	Setup for radiated Emissions	27



1. General

This equipment has been shown to be capable of compliance with the applicable technical standards and was tested in accordance with the measurement procedures as indicated in this report.

We attest to the accuracy of data. Korea Technology Institute Co., Ltd. performed all measurements reported herein. And were made under Chief Engineer's supervisor.

We assume full responsibility for the completeness of these measurements and vouch for the qualifications of all persons taking them.

2. Test Site

Korea Technology Institute Co., Ltd.

Location

51-19, Sanglim3-Ri, Docheok-Myeun, Gwangju-Shi, Gyeongki-Do, Korea

The Test Site is in compliance with ANSI C63.4/2003 for measurement of radio Interference.



List of Test and Measurement Instruments

Table 1: List of Test and Measurement Equipment

- Conducted Emissions

Kind of Equipment	Type	S/N	Calibrated until
Field Strength Meter	ESIB40	100093	08.2010
LISN	KNW407	8-1157-2	05.2010
LISN	EM-7823	115019	05.2010
Conducted Cable	N/A	N/A	11.2010

- Radiated Emissions

Kind of Equipment	Type	S/N	Calibrated until
Field Strength Meter	ESIB40	100093	08.2010
Loop Antenna	6502	3434	03.2010
Biconic Logarithmic Periodic Antenna	VULB9163	9163-281	10.2010
Horn Antenna	3115	6443	03.2010
Open Site Cable	N/A	N/A	11.2010
Antenna Master	DETT-03	N/A	N / A
Antenna & Turntable controller	DETT-04	91X519	N / A

Test Date

Date of Application: November 23, 2009

Date of Test: November 25, 2009

Test Environment

Indoor: 21 °C/40%/1000mbar

Outdoor: 9.7 °C/23%/1000mbar



3. Description of the tested samples

The EUT is Access Controller.

Rating and Physical Characteristics

ITEM1	ITEM2	Spec.
Finger Print Part	Max. User	30,000 Persons
	Identification time	Under 1sec at 1:1,000 Template
	Live Finger Detector	Detecting Pafer, Film, Rubber, Silicon, etc
	FRR/ FAR	0.01%/ 0.001%
	FP Sensor Type	Optical
	Auto Sensing	Applied
RF Card Part	RF Option Model	13.56 MHz A Type Module
	Reading Distance	Smart Card : 2.5 cm
Communication Part	Connect to PC Server or Other Device	10 Base-T Ethernet RS232, RS485, Wiegand IN/OUT
	Wiegand Protocol	26 bit / 34 bit Standard
Output Part	Electric Lock Control	Dead-Bolt, EM, Strike, Motor Lock, Auto Door
	LCD Display	128x64 Graphic LCD w/white Back-Light
	Ten Key	3x4 Keypad Matrix
	Function Button	F1~F4 Button
	Call Button	Call Button for a Door Phone
	LED Display	Blue & Red LED
	Voice	Output Voice Information on 1W Speaker
Supply Voltage	AC/DC Adaptor	INPUT: Universal AC 100~220V
		OUTPUT: DC 12V(Max. 5.5W)
		EK, UL, CSA, CE Approved
Operating Temp.		-10 °C ~ +50 °C
Dimensions		140 X 89 X 28 mm [Width x Height x Depth]

Submitted Documents

- User's Guide
- Block Diagram



4. Measurement Conditions

Testing Input Voltage: AC 220V

Modes of Operation

The EUT was in the following operation mode during all testing;

Prior to a measurement, the Instruments of education shall be operated until stabilization has been reached.

Additional Equipment

DEVICE TYPE	Manufacturer	M/N	S/N	FCC ID
PC	COMPAQ	EvoD5M	6F28KN8ZH110	DOC
Monitor	DELL	1704FPTt	7735428790POE	DOC
Keyboard	COMPAQ	SK-2880	B943C0ADPS0ZL	DOC
Mouse	Logitech	M-UV96	265986-003	DOC
Door Lock	BEHOST	BHL-700C	N / A	DOC
Adaptor	I.T.E. Power Supply	JPW128KA1200F03	N / A	DOC
Ferrite Core *	TDK	ZCAT Series	ZCAT1730-0730A	-

* This Ferrite core will be provided as standard equipment by the Manufacturer of this EUT

Uncertainty

1) Radiated disturbance

$$U_c \text{ (Combined standard Uncertainty)} = \pm 1.8\text{dB}$$

$$\text{Expanded uncertainty } U = KU_c$$

$$K = 2$$

$$\therefore U = \pm 3.6\text{dB}$$

2) Conducted disturbance

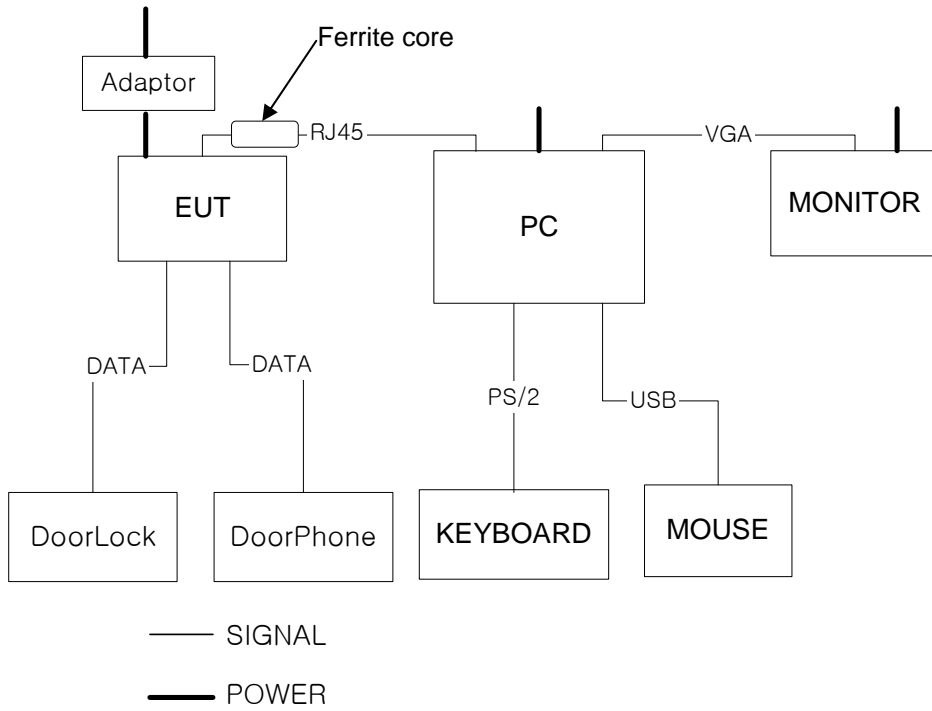
$$U_c = \pm 0.88\text{dB}$$

$$U = KU_c = 2 \times U_c = \pm 1.8\text{dB}$$



4.4 Test Setup

Figure 1: Test Setup





5. TEST AND MEASUREMENTS

Summary of Test Results

Requirement	FCC, 47CFR15	Report Section	Test Result
Antenna Requirement	15.203	5.1	PASS
Conducted Emissions Radiated Emissions Field strength 9 kHz to 30 MHz Field strength 30 MHz to 1000 MHz	15.209 & 15.205	5.2	PASS
Spectrum mask and Occupied bandwidth	15.225(a),(b),(c) & (d)	5.3	PASS
Frequency Tolerance of the Carrier Signal	15.225(e)	5.4	PASS

* According to the Section 15.33(b)(1)&(c), Radiated Emissions & Conducted Emissions were reported in Report No. KT109EF12006.

5.1 ANTENNA REQUIREMENT

5.1.1 Regulation

FCC 47CFR15 – 15.203

An intentional radiator shall be designed to ensure that no antenna other than that furnished by the responsible party shall be used with the device. The use of a permanently attached antenna or of an antenna that uses a unique coupling to the intentional radiator shall be considered sufficient to comply with the provisions of this Section. The manufacturer may design the unit so that a broken antenna can be replaced by the user, but the use of a standard antenna jack or electrical connector is prohibited. This requirement does not apply to carrier current devices or to devices operated under the provisions of Sections 15.211, 15.213, 15.217, 15.219, or 15.221. Further, this requirement does not apply to intentional radiators that must be professionally installed, such as perimeter protection systems and some field disturbance sensors, or to other intentional radiators which, in accordance with Section 15.31(d), must be measured at the installation site. However, the installer shall be responsible for ensuring that the proper antenna is employed so that the limits in this Part are not exceeded.

5.1.2 Result:

PASS

The transmitter has an integral PCB loop antenna that is enclosed within the housing of the EUT, and meets the requirements of this section.



5.2 EMISSION TEST

5.2.1. Conducted Emissions

Result:

Pass

The line-conducted facility is located inside a 2.3M x 3.5M x 5.5M shielded closure.

The shielding effectiveness of the shielded room is in accordance with MIL-Std-285 or NSA 605-05. A 1m x 1.5m wooden table 80cm high is placed 80cm away from the conducting ground plane and 40cm away from the sidewall of the shielded room. Electro-Metroics Model EM-7823 (9kHz-30MHz) 50ohm/50 uH Line-Impedance Stabilization Networks (LISN) are bonded to the shielded room.

The EUT is powered from the Electro-Metroics LISN and the support equipment is powered from the Kyoritsu LISN. Power to the LISN are filtered by a high-current high-insertion loss shield enclosures power line filters (100dB 14kHz-1GHz).

The purpose of the filter is to attenuate ambient signal interference and this filter is also bonded to the shielded enclosure.

All electrical cables are shielded by copper pipe with inner diameter of 1".

If the EUT is a DC-Powered device, power will be derived from the source power supply it normally will be powered from and this supply lines will be connected to the Rohde & Schwarz LISN.

All interconnecting cables more than 1 meter were shortened by non-inductive bundling (serpentine fashion) to a 1-meter length.

Sufficient time for the EUT, Support equipment, and test equipment was allowed in order for them to warm up to their normal operating condition. The RF output of the LISN was connected to the spectrum analyzer to determine the frequency producing the maximum EME from the EUT. The frequency producing the maximum level was reexamined using EMI field Intensity meter (ESIB40). The detector function was set to CISPR quasi-peak mode.

The bandwidth of the receiver was set to 10kHz. The EUT, support equipment, and interconnecting cables were arranged and manipulated to maximize each emission. Each emission was maximized by: switching power lines; varying the mode of operation or resolution; clock or data exchange speed; if applicable; whichever determined the worst-case emission.

Photographs of the worst-case emission can be seen in photograph of conducted test.

Each EME reported was calibrated using self-calibrating mode.



Figure 2: Spectral Diagram, LINE-PE

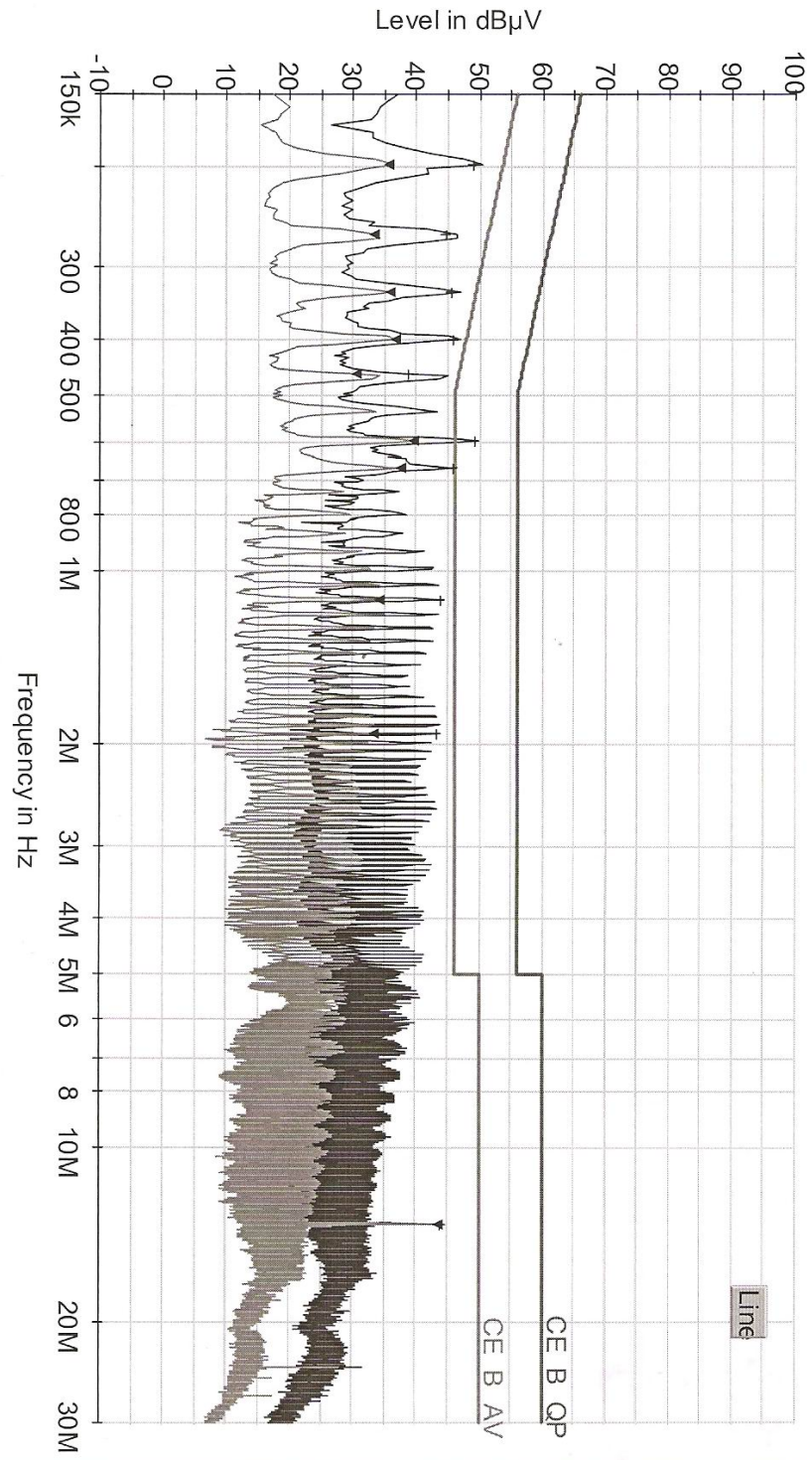




Figure 3: Spectral Diagram, NEUTRAL-PE

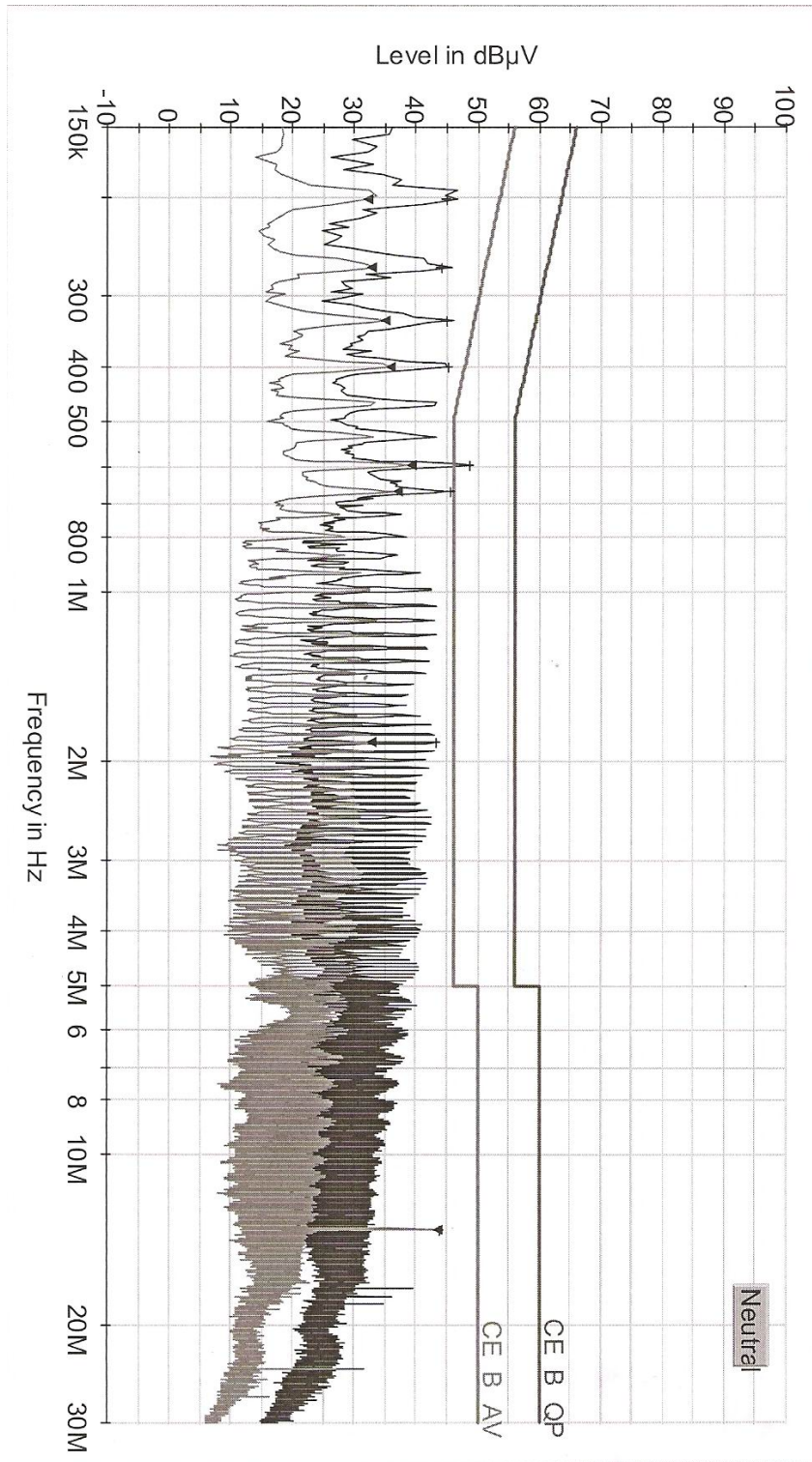




Table 2: Test Data, Conducted Emissions

Frequency (MHz)	(1) Reading (dB μ V)		Line	(2) Limit (dB μ V)		(3) Margin (dB)	
	QP	AV		QP	AV	QP	AV
0.20	48.94	35.59	L1	63.61	53.61	14.67	18.02
0.33	45.56	35.82	L1	59.45	49.45	13.89	13.63
0.40	45.91	36.74	L1	57.85	47.85	11.94	11.11
0.60	49.33	39.77	L1	56.00	46.00	6.67	6.23
0.67	46.07	37.58	L1	56.00	46.00	9.93	8.42
1.12	43.84	34.36	L1	56.00	46.00	12.16	11.64

NOTES:

1. All modes of operation were investigated
And the worst-case emissions are reported.
2. All other emissions are non-significant.
3. All readings are calibrated by self-mode in receiver.
4. Measurements using CISPR quasi-peak mode.
5. L1 = LINE-PE, L2 = NEUTRAL-PE
6. The limit for Class B digital device is 66dBuV to 56dBuV from 150KHz to 500KHz, 56dBuV from 500KHz to 5MHz, 60dBuV Above 5MHz.

♣ Margin Calculation

$$(3) \text{ Margin} = (2) \text{ Limit} - (1) \text{ Reading}$$



5.2.2 Radiated Emissions

5.2.2.1 Regulation

FCC 47CFR15 – 15.209

(a) Except as provided elsewhere in this Subpart, the emissions from an intentional radiator shall not exceed the field strength levels specified in the following table:

Frequency (MHz)	Field strength limit (uV/m)	Field strength limit (dBuV/m)	Measurement Distance (m)
0.009 – 0.490	2400/F(kHz)	48.5-13.8	300
0.490 – 1.705	24000/F(kHz)	33.8-23.0	30
1.705 – 30.0	30	29.5	30
30 – 88	100	40.0	3
88 – 216	150	43.5	3
216 – 960	200	46.0	3
Above 960	500	54.0	3

5.2.2.2 Measurement Procedure

Radiated Emissions Test, 9kHz to 30MHz (Magnetic Field Test)

1. The preliminary radiated measurements were performed to determine the frequency producing the maximum emissions at a distance of 3 meters according to Section 15.31(f)(2).
2. The EUT was placed on the top of the 0.8-meter height, 1 x 1.5 meter non-metallic table.
3. Emissions from the EUT are maximized by adjusting the orientation of the Loop antenna and rotating the EUT on the turntable. Manipulating the system cables also maximizes EUT emissions if applicable.
4. To obtain the final measurement data, each frequency found during preliminary measurements was re-examined and investigated. The test-receiver system was set up to average, peak, and quasi-peak detector with specified bandwidth.



Radiated Emissions Test, 30 MHz to 1000 MHz

1. The preliminary radiated measurements were performed to determine the frequency producing the maximum emissions in an anechoic chamber at a distance of 3 meters.
2. The EUT was placed on the top of the 0.8-meter height, 1 x 1.5 meter non-metallic table. To find the maximum emission levels, the height of a measuring antenna was changed and the turntable was rotated 360
3. The antenna polarization was also changed from vertical to horizontal. The spectrum was scanned from 30 to 1000 MHz using the Biconical and Logperiodue broadband antenna,
4. To obtain the final measurement data, the EUT was arranged on a turntable situated on a 4 x 4 meter at the Open Area Test Site. The EUT was tested at a distance 3 meters.
5. Each frequency found during preliminary measurements was re-examined and investigated. The test-receiver system was set up to average, peak, and quasi-peak detector function with specified bandwidth.
6. The presence of ambient signals was verified by turning the EUT off. In case an ambient signal was detected, the measurement bandwidth was reduced temporarily and verification was made that an additional adjacent peak did not exist. This ensures that the ambient signal does not hide any emissions from the EUT

5.2.2.3 Calculation of the field strength limits below 30 MHz

1. No special calculation for obtaining the field strength in dBuV/m is necessary, because the EMI receiver and the active loop antenna operate as a system, where the reading gives directly the field strength result (dBuV/m). The antenna factors and cable losses are already taken into consideration.
2. For test distance other than what is specified, but fulfilling the requirements of section 15.31 (f)(2) the field strength is calculated by adding additionally an extrapolation factor of 40dB/decade (inverse linear distance for field strength measurements).
3. All following emission measurements were performed using the test receiver's average, peak, and quasi-peak detector function with specified bandwidth.



5.2.2.4 Test Results (Test mode : TX on)

PASS

Table 3: Test Data, Fundamental Frequency (Ver / Hor)

Frequency (MHz)	Pol.	Reading (dB μ V)	AFCL (dB/m)	Actual (dB μ V/m)	Limit (dB μ V/m)	Margin (dB)	Detector
13.560	V	45.46	9.94	55.40	124	68.60	QP
13.560	V	45.69	9.94	55.63	-	-	AV

Frequency (MHz)	Pol.	Reading (dB μ V)	AFCL (dB/m)	Actual (dB μ V/m)	Limit (dB μ V/m)	Margin (dB)	Detector
13.561	H	42.57	9.94	52.51	124	71.49	QP
13.561	H	42.77	9.94	52.71	-	-	AV

FCC 47CFR15 – 15.209 (9 kHz - 30 MHz)

Table 4: Test Data, Radiated Emission below 30 MHz

Frequency (MHz)	Pol.	Height [m]	Angle [°]	(1) Reading (dB μ V)	(2) AFCL (dB/m)	(3) Actual (dB μ V/m)	(4) Limit (dB μ V/m)	(5) Margin (dB)
0.048	H	1.30	176	37.85	12.38	50.23	113.98	63.78
1.264	H	1.28	178	19.96	12.18	32.14	65.57	33.47
9.424	V	1.35	265	11.94	9.98	21.92	69.54	47.62
13.136	V	1.42	271	12.05	9.73	21.78	69.54	47.76
16.100	V	1.38	274	11.89	9.44	21.33	69.54	48.21
20.384	H	1.33	180	10.21	8.83	19.04	69.54	50.50

Margin (dB) = Limit – Actual
[Actual = FS + AF + CL]

- 1.H = Horizontal, V = Vertical Polarization
- 2.AF/CL = Antenna Factor and Cable Loss
- 3.FS = RA + DF

Where FS = Field strength in dB μ V/m

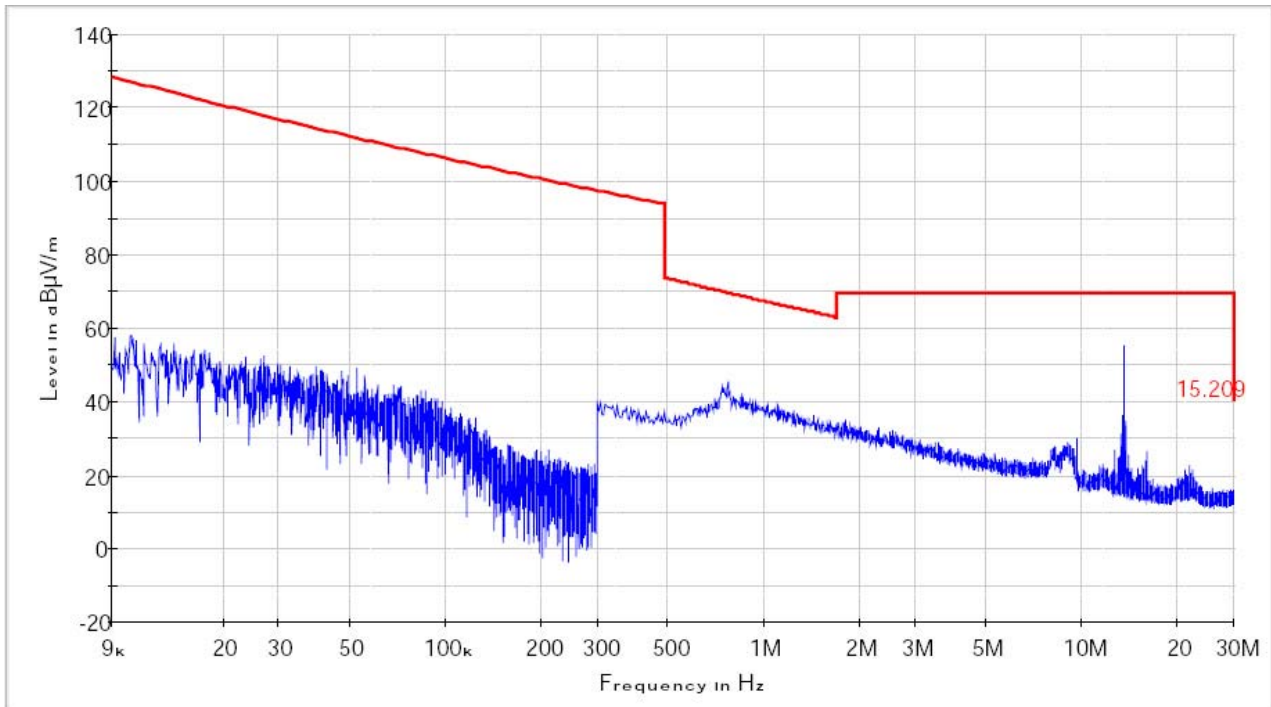
RA = Receiver Amplitude in dB μ V/m

DF = Distance Extrapolation Factor in dB

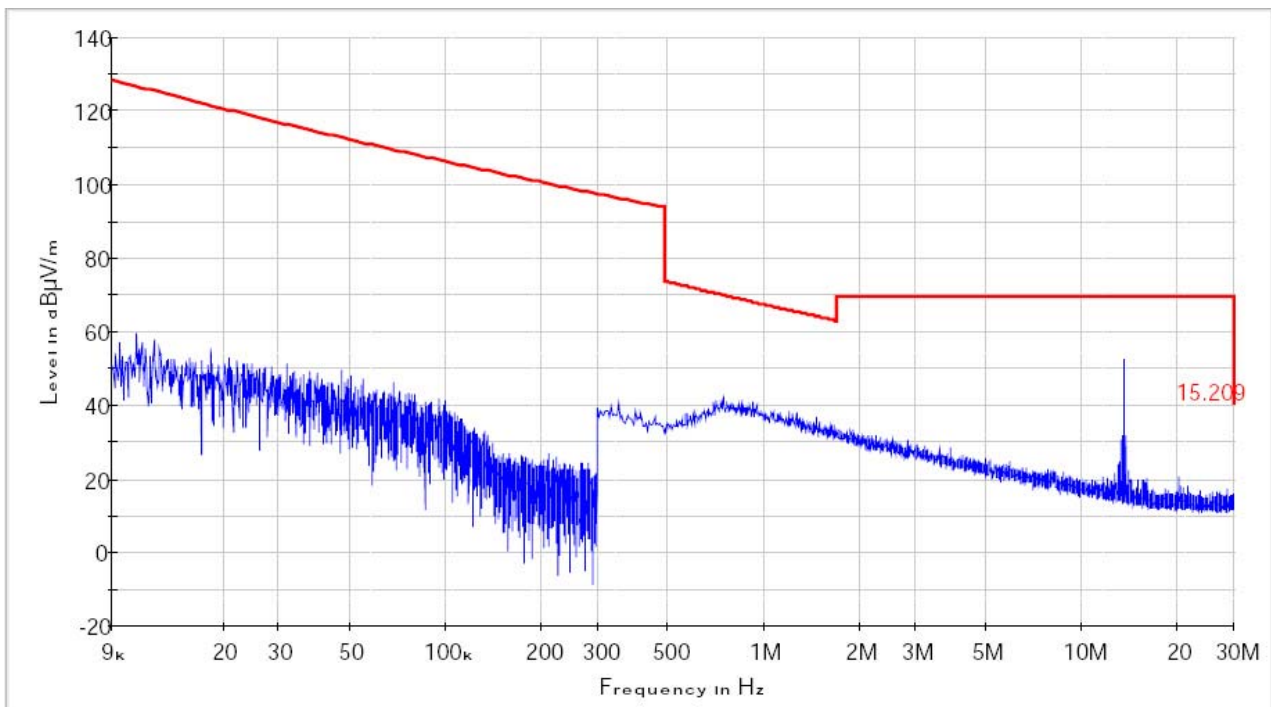


Figure 4: Radiated spurious emissions below 30 MHz

Spurious Emissions from 9 kHz to 30 MHz – Vertical



Spurious Emissions from 9 kHz to 30 MHz – Horizontal





5.2.2.5 Calculation of the field strength limits above 30 MHz

1. No special calculation for obtaining the field strength in dBuV/m is necessary, because the EMI receiver and the active loop antenna operate as a system, where the reading gives directly the field strength result (dBuV/m). The antenna factors and cable losses are already taken into consideration.
2. For test distance other than what is specified, but fulfilling the requirements of section 15.31 (f)(2) the field strength is calculated by adding additionally an extrapolation factor of 40dB/decade (inverse linear distance for field strength measurements).
3. All following emission measurements were performed using the test receiver's average, peak, and quasi-peak detector function with specified bandwidth.

5.2.2.6 Test Results (Test mode : TX on)

PASS

FCC 47CFR15 – 15.209

Table 5: Test Data, Radiated Emission above 30 MHz

Frequency (MHz)	Pol.	Height [m]	Angle [°]	Reading (dBμV)	AFCL (dB/m)	Actual (dBμV/m)	Limit (dBμV/m)	Margin (dB)
176.28	H	1.58	181	24.12	9.58	33.70	43.5	9.80
203.40	H	1.61	181	22.61	11.69	34.30	43.5	9.20
230.52	H	1.62	176	21.46	12.54	34.00	46.0	12.00
304.12	H	1.65	170	21.75	14.35	36.10	46.0	9.90
709.60	V	1.83	164	4.47	21.93	26.40	46.0	19.60
811.44	H	1.78	175	7.49	23.61	31.10	46.0	14.90

FCC 47CFR15-15.205 Restricted Band

Frequency (MHz)	Pol.	Height [m]	Angle [°]	Reading (dBμV)	AFCL (dB/m)	Actual (dBμV/m)	Limit (dBμV/m)	Margin (dB)
108.48	V	1.54	170	9.31	12.09	21.40	43.5	22.10
162.72	H	1.61	175	26.26	8.94	35.20	43.5	8.30
251.04	H	1.61	175	15.35	13.14	28.50	46.0	17.50
254.00	H	1.68	178	17.1	13.20	30.30	46.0	15.70
608.52	H	1.53	188	6.76	21.04	27.80	46.0	18.20

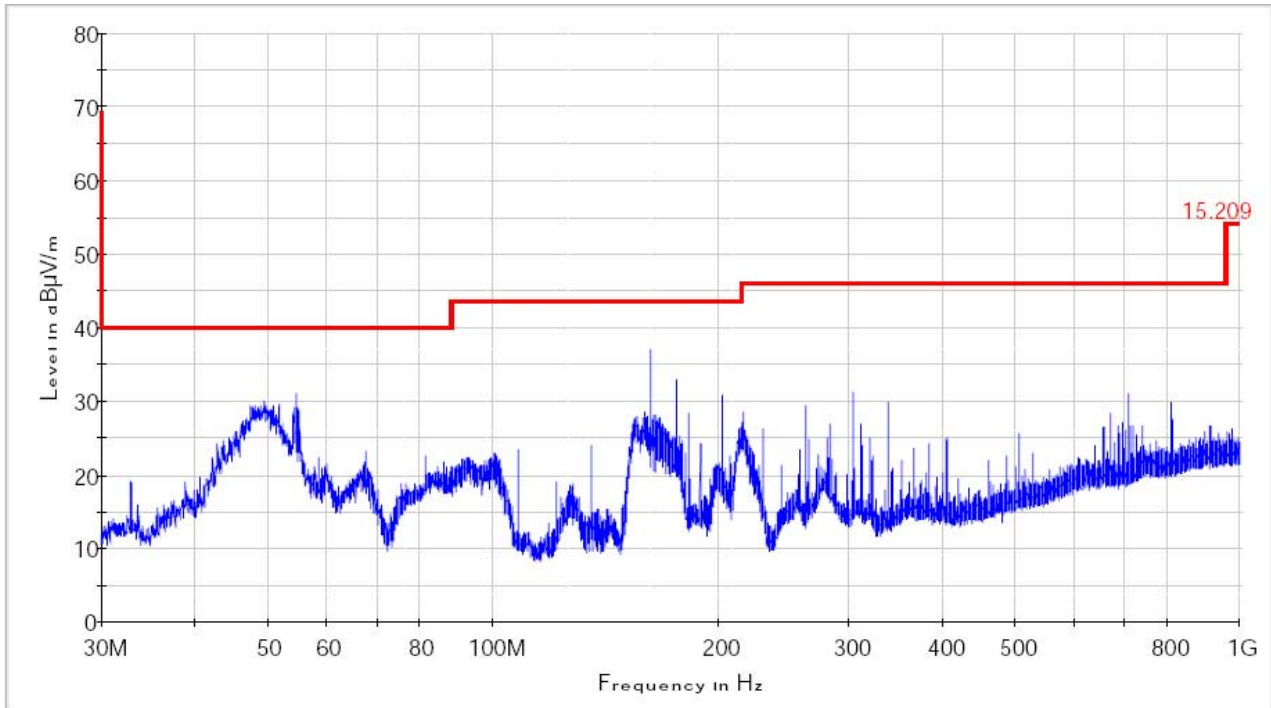
Margin (dB) = Limit – Actual
[Actual = Reading + AF + CL]

- 1.H = Horizontal, V = Vertical Polarization
- 2.AF/CL = Antenna Factor and Cable Loss

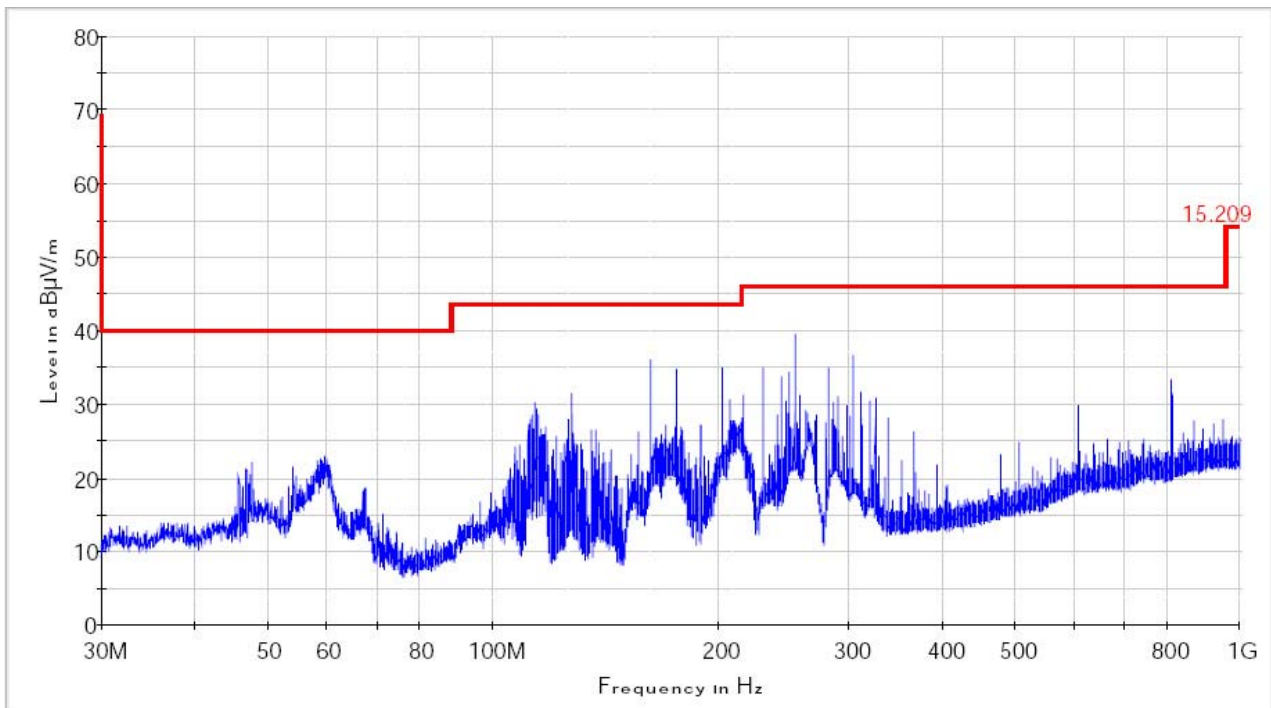


Figure 5: Radiated spurious emissions above 30 MHz

Spurious Emissions from 30 MHz to 1 GHz – Vertical



Spurious Emissions from 30 MHz to 1 GHz – Horizontal





5.3 Spectrum mask and Occupied bandwidth

5.3.1 Regulation

FCC 47CFR15 – 15.225

- (a) The field strength of any emissions within the band 13.553-13.567 MHz shall not exceed 15,848 microvolts/meter at 30 meters.
- (b) Within the bands 13.410-13.553 MHz and 13.567-13.710 MHz, the field strength of any emissions shall not exceed 334 microvolts/meter at 30 meters.
- (c) Within the bands 13.110-13.410 MHz and 13.710-14.010 MHz the field strength of any emissions shall not exceed 106 microvolts/meter at 30 meters.
- (d) The field strength of any emissions appearing outside of the 13.110-14.010 MHz band shall not exceed the general radiated emission limits in § 15.209.

Frequency (MHz)	Field strength limit (uV/m) @ 30m	Field strength limit (dBuV/m) @ 30m	Field strength limit (dBuV/m) @ 3m
13.110 – 13.410	106	40.5	80.5
13.410 – 13.553	334	50.5	90.5
13.553 – 13.567	15,848	84.0	124.0
13.567 – 13.710	334	50.5	90.5
13.710 – 14.010	106	40.5	80.5

5.3.2 Measurement Procedure

Spectrum Mask

1. Place the EUT in the test fixture and switch it on
2. Use the following spectrum analyzer settings: RBW = VBW =1 kHz, Span = wide enough to capture the whole 13 MHz band including the frequency ranges where the 15.209 limit applies, Trace mode = Max Hold, select the limit line 15.225(a),(b),(c)
3. After trace stabilization, set the marker to the single peak.
4. The reference level will be calculated by the amount of the margin of the wanted signal to its 30 m emission limit plus marker value.
5. The whole signal trace has to be below the limit line.



Occupied Bandwidth

1. Place the EUT in the test fixture and switch it on.
2. Use the following spectrum analyzer settings: RBW = VBW =1 kHz, Span = wide enough to capture the 20 dB bandwidth, Trace mode = Max Hold.
3. After trace stabilization, set the first marker and the first display line to the signal peak. Set the second display line 20 dB below the first display line. The Second marker and its delta marker shall be set to cross point of the spectrum line and the second display line and note these frequencies.
4. Alternatively the 20 dB down function of the analyzer could be used, if this function will be applicable to the displayed spectrum.

5.3.3 Test Results (Test mode : Modulated)

PASS

Figure 6: Spectrum Mask

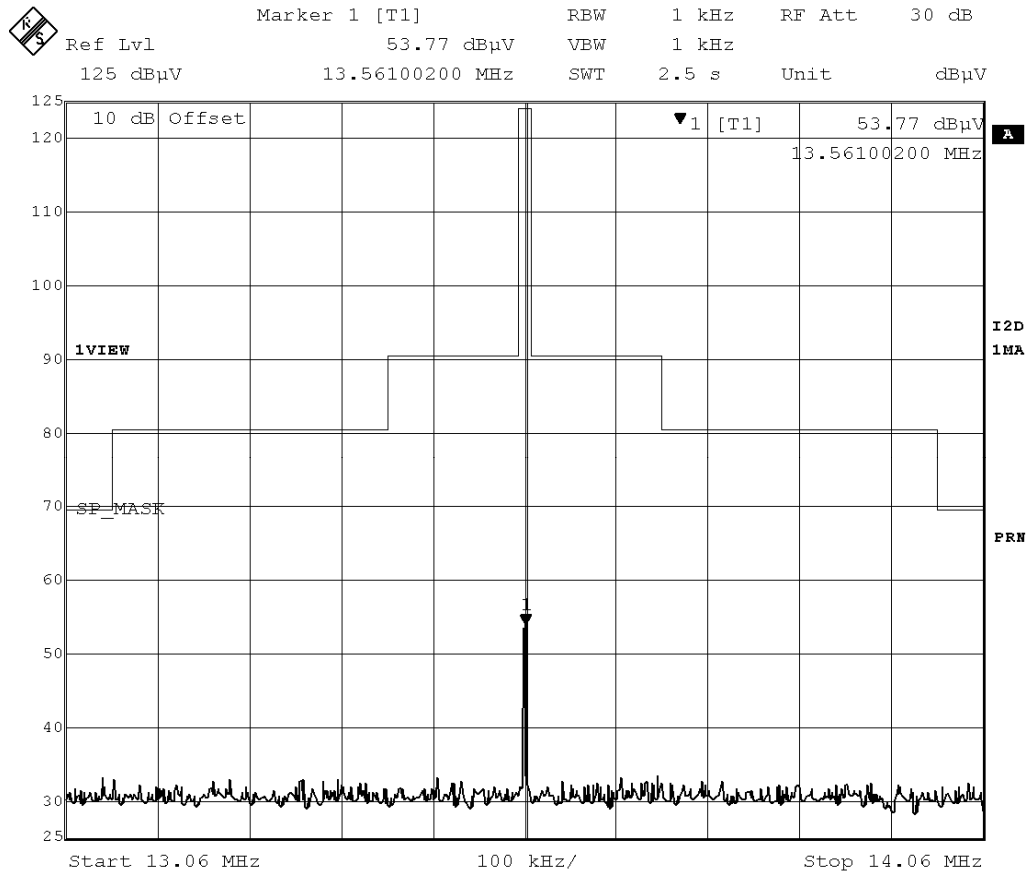
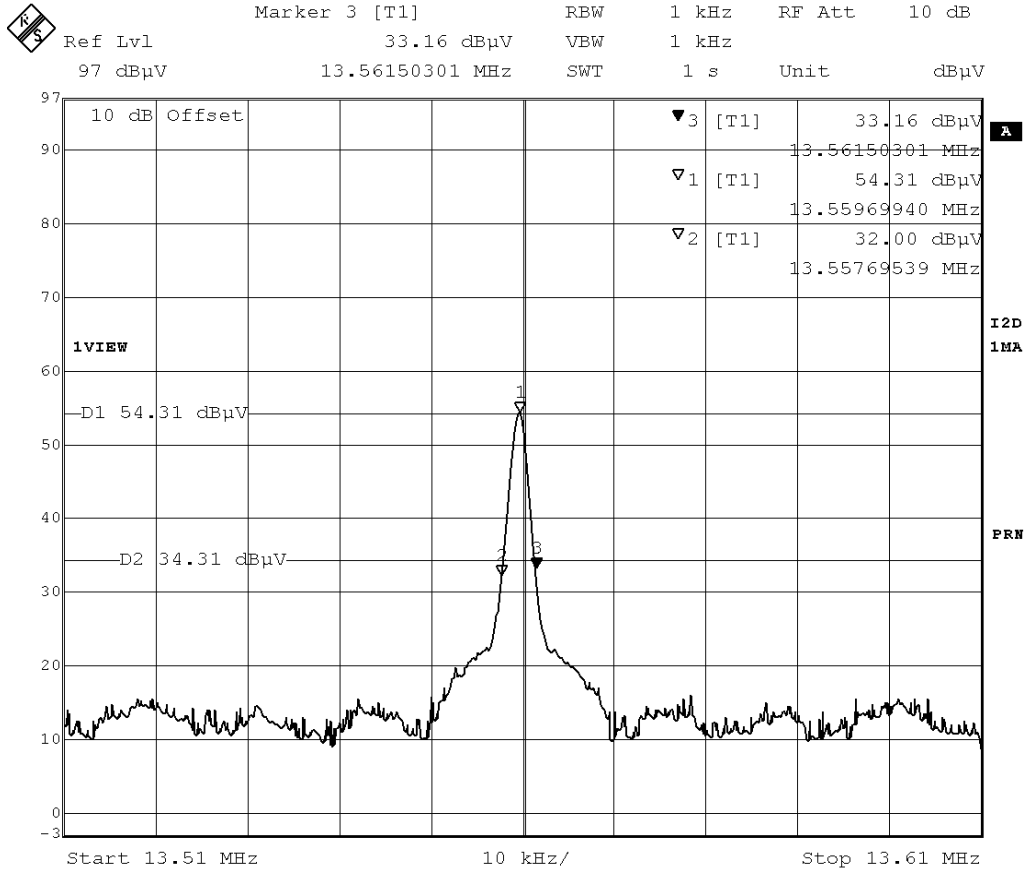




Figure 7: Occupied bandwidth

Occupied Bandwidth = 3.808 kHz



F_L	F_H	Bandwidth ($F_H - F_L$)
13.557695 (MHz)	13.561503 (MHz)	3.808 (kHz)



5.4 FREQUENCY TOLERANCE OF CARRIER SIGNAL

5.4.1 Regulation

FCC 47CFR15 – 15.225(e)

The frequency tolerance of the carrier signal shall be maintained within +/- 0.01% of the operating frequency over a temperature variation of -20 degrees to +50 degrees C at normal supply voltage, and for a variation in the primary supply voltage from 85% to 115% of the rated supply voltage at a temperature of 20 degrees C. For battery-operated equipment, the equipment tests shall be performed using a new battery.

5.4.2 Measurement Procedure

Frequency stability versus environmental temperature

1. Supply the EUT with nominal DC voltage.
2. Turn the EUT off, and place it inside an environmental temperature chamber. For devices that are normally operated continuously, the EUT may be energized while inside the test chamber. For devices that have oscillator heaters, energize only the heater circuit while the EUT is inside the chamber.
3. RF output was connected to a frequency counter or other frequency-measuring instrument via feed through attenuators.
4. Set the temperature control on the chamber to the highest specified EUT operating temperature, and allow the temperature inside the chamber to stabilize at the set temperature before starting frequency measurements.
5. While maintaining a constant temperature inside the environmental chamber, turn the EUT on and record the operating frequency at startup and two, five, and ten minutes after the EUT is energized.
6. After all measurements have been made at the highest specified temperature turn the EUT off.
7. Repeat the above measurement process for the EUT with the test chamber set at the appropriate temperature.

Frequency Stability versus Input Voltage

1. At temperature ($20 \pm 5^{\circ}\text{C}$), supply the EUT with nominal DC voltage.
2. Couple RF output to a frequency counter or other frequency-measuring instrument.
3. Turn the EUT on, and measure the EUT operating frequency at startup and two, five, and ten minutes after startup.
4. Supply it with 85% of the nominal DC voltage and repeat above procedure.
5. Supply it with 115% of the nominal DC voltage and repeat above procedure.



5.4.3 Test Results :

PASS

TEST MODE : TX on

Table 6: Test Data, Frequency Tolerance of carrier signal

Reference Frequency : 13.56 MHz, LIMIT : within ±1356 Hz

Environment Temperature [°C]	Power Supplied [V _{AC}]	Carrier Frequency Measured with Time Elapsed							
		STARTUP		2 minutes		5 minutes		10 minutes	
		[MHz]	Err[Hz]	[MHz]	Err[Hz]	[MHz]	Err[Hz]	[MHz]	Err[Hz]
+50	220	13.559831	-169	13.559812	-188	13.559797	-203	13.559781	-219
+40	220	13.559873	-127	13.559845	-155	13.559835	-165	13.559816	-184
+30	220	13.559924	-76	13.560002	2	13.560035	35	13.560051	51
+20	220	13.560027	27	13.560011	11	13.559999	-1	13.559992	-8
+10	220	13.559635	-365	13.559623	-377	13.559616	-384	13.559608	-392
0	220	13.559670	-330	13.559666	-334	13.559661	-339	13.559649	-351
-10	220	13.559705	-295	13.559700	-300	13.559696	-304	13.559689	-311
-20	220	13.559708	-292	13.559707	-293	13.559706	-294	13.559705	-295

Reference Frequency : 13.56 MHz, LIMIT : within ±1356 Hz

Power Supplied [V _{AC}]	Carrier Frequency Measured with Time Elapsed							
	STARTUP		2 minutes		5 minutes		10 minutes	
	[MHz]	Err[Hz]	[MHz]	Err[Hz]	[MHz]	Err[Hz]	[MHz]	Err[Hz]
85 %	13.559790	-210	13.560024	24	13.560043	43	13.560047	47
100 %	13.559749	-251	13.559947	-53	13.560023	23	13.560040	40
115 %	13.559681	-319	13.559809	-191	13.559973	-27	13.560038	38

Err[Hz] = Measured carrier frequency (MHz) – Reference Frequency (13.56 MHz)