

Test of Zebra Enterprise Solutions Corp.  
WhereLAN III Location Sensor

To: FCC 47 CFR Part 15.247 & IC 210

Test Report Serial No.: GBCC01-U1 Rev A



## TEST REPORT

From



**Test of:** Zebra Enterprise Solutions Corp. WhereLAN III Location Sensor

**To:** FCC 47 CFR Part 15.247 & IC RSS-210

**Test Report Serial No.:** GBCC01-U1 Rev A

This report supersedes: None

**Applicant:** Zebra Enterprise Solutions Corp.  
2940 N. First Street  
San Jose, CA 95134  
USA

**Product Function:** Wireless Location Sensor

**Copy No:** pdf      **Issue Date:** 6th December 2010

**This Test Report is Issued Under the Authority of;**

**MiCOM Labs, Inc.**  
440 Boulder Court, Suite 200  
Pleasanton, CA 94566 USA  
Phone: +1 (925) 462-0304  
Fax: +1 (925) 462-0306  
[www.micomlabs.com](http://www.micomlabs.com)



TESTING CERTIFICATE #2381.01

**MiCOM Labs is an ISO 17025 Accredited Testing Laboratory**



## TABLE OF CONTENTS

<b>1</b>	<b>ACCREDITATION, LISTINGS &amp; RECOGNITION .....</b>	<b>5</b>
1.1	TESTING ACCREDITATION .....	5
1.2	RECOGNITION .....	6
1.3	PRODUCT CERTIFICATION .....	7
<b>2</b>	<b>DOCUMENT HISTORY .....</b>	<b>8</b>
<b>3</b>	<b>TEST RESULT CERTIFICATE .....</b>	<b>9</b>
<b>4</b>	<b>REFERENCES AND MEASUREMENT UNCERTAINTY .....</b>	<b>10</b>
4.1	Normative References .....	10
4.2	Test and Uncertainty Procedures .....	11
<b>5</b>	<b>TEST SUMMARY .....</b>	<b>12</b>
<b>6</b>	<b>PRODUCT DETAILS AND TEST CONFIGURATIONS .....</b>	<b>14</b>
6.1	Test Program Scope .....	14
6.2	EUT Details.....	15
6.3	External A.C/D.C Power Adaptor.....	16
6.4	Operational Power Range .....	16
6.5	Types of Modulation Supported .....	17
6.6	Antenna Details .....	17
6.7	Cabling and I/O Ports .....	17
6.8	EUT Configurations .....	18
6.9	Equipment Details.....	18
6.10	Test Configurations.....	18
6.11	Equipment Modifications.....	19
6.12	Deviations from the Test Standard .....	19
<b>7</b>	<b>TEST RESULTS .....</b>	<b>20</b>
7.1	6 dB and 99% Bandwidth .....	20
7.1.1	<i>6 dB and 99% Bandwidth Results: DSSS .....</i>	<i>22</i>
7.2	Peak Output Power.....	24
7.2.1	<i>Measurement Results: DSSS.....</i>	<i>26</i>
7.3	Peak Power Spectral Density .....	27
7.3.1	<i>Measurement results for DSSS.....</i>	<i>28</i>
7.4	Maximum Permissible Exposure .....	30
7.5	Conducted Spurious .....	31
7.5.1	<i>Measurement Results for DSSS .....</i>	<i>33</i>
7.6	Radiated Spurious Emissions.....	37
7.6.1	<i>Measurement Results DSSS mode: Transmitter Radiated Spurious Emissions.....</i>	<i>43</i>
7.6.2	<i>DSSS Radiated Band Edge Emissions.....</i>	<i>44</i>
7.6.3	<i>Measurement Results AK-210-10 &amp; AK-110-10: Band Edge.....</i>	<i>45</i>
7.6.4	<i>Measurement Results AK-210-10 &amp; AK-110-10: Peak Emissions.....</i>	<i>47</i>
7.7	Radiated Spurious Emissions – Digital Apparatus .....	52

This test report may be reproduced in full only. The document may only be updated by MiCOM Labs personnel. Any changes will be noted in the Document History section of the report.



**Title:** Zebra Enterprise Solutions WhereLAN III  
**To:** FCC 47 CFR Part 15.247 & IC RSS-210  
**Serial #:** GBCC01-U1 Rev A  
**Issue Date:** 6th December 2010  
**Page:** Page 4 of 72

---

7.7.1	<i>Measurement Results for Radiated Spurious Emissions – Digital Apparatus</i> .....	58
7.8	Conducted Disturbance at Mains Terminal (150 kHz – 30 MHz).....	62
7.8.1	<i>Conducted Disturbance at Mains Terminal (150 kHz – 30 MHz)</i> .....	66
<b>8</b>	<b>PHOTOGRAPHS</b> .....	<b>68</b>
8.1	Conducted RF Measurement Set Up.....	68
8.2	Radiated Spurious Emissions Below 1 GHz.....	69
8.3	Radiated Spurious Emissions Above 1 GHz .....	70
<b>9</b>	<b>TEST EQUIPMENT DETAILS</b> .....	<b>71</b>

---

This test report may be reproduced in full only. The document may only be updated by MiCOM Labs personnel. Any changes will be noted in the Document History section of the report.

## 1 ACCREDITATION, LISTINGS & RECOGNITION

### 1.1 TESTING ACCREDITATION

MiCOM Labs, Inc. is an accredited Electrical testing laboratory per the international standard EN ISO/IEC 17025. The company is accredited by the American Association for Laboratory Accreditation (A2LA) [www.a2la.org](http://www.a2la.org) test laboratory number 2381.01. MiCOM Labs test schedule is available at the following URL; <http://www.a2la.org/scopepdf/2381-01.pdf>



The American Association for Laboratory Accreditation

World Class Accreditation

## Accredited Laboratory

A2LA has accredited

**MICOM LABS**

*Pleasanton, CA*

for technical competence in the field of

**Electrical Testing**

This laboratory is accredited in accordance with the recognized International Standard ISO/IEC 17025:2005 *General Requirements for the Competence of Testing and Calibration Laboratories*. This accreditation demonstrates technical competence for a defined scope and the operation of a laboratory quality management system (refer to joint ISO-ILAC-IAF Communiqué dated 8 January 2009).

Presented this 14<sup>th</sup> day of April 2010.



President & CEO  
For the Accreditation Council  
Certificate Number 2381.01  
Valid to November 30, 2011

*For the tests or types of tests to which this accreditation applies, please refer to the laboratory's Electrical Scope of Accreditation.*

This test report may be reproduced in full only. The document may only be updated by MiCOM Labs personnel. Any changes will be noted in the Document History section of the report.



## 1.2 RECOGNITION

MiCOM Labs, Inc has widely recognized Electrical testing capabilities. Our international recognition includes Conformity Assessment Body designation by APEC MRA\*\* countries. Our test reports are widely accepted for global type approvals.

Country	Recognition Body	Status	Phase	Identification No.
USA	Federal Communications Commission (FCC)	TCB	-	Listing #: 102167
Canada	Industry Canada (IC)	FCB	APEC MRA 2	Listing #: 4143A
Japan	VCCI	-	-	No. 2959
	MIC	RCB	APEC MRA 2	US0159
Europe	European Union	NB	N/A	
Australia	Australian Communications and Media Authority (ACMA)	CAB	APEC MRA 1	
Hong Kong	Office of the Telecommunication Authority (OFTA)	CAB	APEC MRA 1	
Korea	Ministry of Information and Communication Radio Research Laboratory (RRL)	CAB	APEC MRA 1	
Singapore	Infocomm Development Authority (IDA)	CAB	APEC MRA 1	
Taiwan	National Communications Commission (NCC) Bureau of Standards, Metrology and Inspection (BSMI)	CAB	APEC MRA 1	
Vietnam	Ministry of Communication (MIC)	CAB	APEC MRA 1	

\*\*APEC MRA – Asia Pacific Economic Community Mutual Recognition Agreement.

Is a recognition agreement under which test lab is accredited to regulatory standards of the APEC member countries.

Phase I - recognition for product testing

Phase II – recognition for both product testing and certification

N/A – Not Applicable

This test report may be reproduced in full only. The document may only be updated by MiCOM Labs personnel. Any changes will be noted in the Document History section of the report.

### 1.3 PRODUCT CERTIFICATION

MiCOM Labs, Inc. is an accredited Product Certification Body per the international standard EN ISO/IEC Guide 65. The company is accredited by the American Association for Laboratory Accreditation (A2LA) [www.a2la.org](http://www.a2la.org) test laboratory number 2381.02. MiCOM Labs test schedule is available at the following URL; <http://www.a2la.org/scopepdf/2381-02.pdf>



The American Association for Laboratory Accreditation

World Class Accreditation

## Accredited Product Certification Body

A2LA has accredited

**MICOM LABS**

Pleasanton, CA

for technical competence as a

Product Certification Body

This product certification body is accredited in accordance with the recognized International Standard ISO/IEC Guide 65:1996 *General requirements for bodies operating product certification systems*. This accreditation demonstrates technical competence for a defined scope and the operation of a quality management system for a Telecommunications Certification Body (TCB) meeting FCC (U.S.), and IC (Canada) requirements.



Presented this 24<sup>th</sup> day of June 2010.



President & CEO  
For the Accreditation Council  
Certificate Number 2381.02  
Valid to November 30, 2011

*For the product certification schemes to which this accreditation applies, please refer to the organization's Product Certification Scope of Accreditation.*

### United States of America – Telecommunication Certification Body

TCB Identifier – US0159

### Industry Canada – Certification Body

CAB Identifier – US0159

This test report may be reproduced in full only. The document may only be updated by MiCOM Labs personnel. Any changes will be noted in the Document History section of the report.



**Title:** Zebra Enterprise Solutions WhereLAN III  
**To:** FCC 47 CFR Part 15.247 & IC RSS-210  
**Serial #:** GBCC01-U1 Rev A  
**Issue Date:** 6th December 2010  
**Page:** Page 8 of 72

---

## 2 DOCUMENT HISTORY

Document History		
Revision	Date	Comments
Draft		
Rev A	6 <sup>th</sup> December 2010	Initial Release

---

This test report may be reproduced in full only. The document may only be updated by MiCOM Labs personnel. Any changes will be noted in the Document History section of the report.





**Title:** Zebra Enterprise Solutions WhereLAN III  
**To:** FCC 47 CFR Part 15.247 & IC RSS-210  
**Serial #:** GBCC01-U1 Rev A  
**Issue Date:** 6th December 2010  
**Page:** Page 9 of 72

### 3 TEST RESULT CERTIFICATE

Applicant:	Zebra Enterprise Solutions Corp. 2940 N. First Street San Jose CA , 95134, USA	Tested By:	MiCOM Labs, Inc. 440 Boulder Court Suite 200 Pleasanton California, 94566, USA
Product:	WhereLAN III Location Sensor	Telephone:	+1 925 462 0304
Model No.:	LOS-5000	Fax:	+1 925 462 0306
S/No's:	M12120901M12		
Date(s) Tested:	25 <sup>th</sup> Oct to 2 <sup>nd</sup> November 2010	Website:	www.micomlabs.com

STANDARD(S)	TEST RESULTS
FCC 47 CFR Part 15.247 & IC 210	EQUIPMENT COMPLIES

MiCOM Labs, Inc. tested the equipment mentioned in accordance with the requirements set forth in the above standards. Test results indicate that the equipment tested is capable of demonstrating compliance with the requirements as documented within this report.

**Notes:**

1. This document reports conditions under which testing was conducted and the results of testing performed.
2. Details of test methods used have been recorded and kept on file by the laboratory.
3. Test results apply only to the item(s) tested.

Approved & Released for MiCOM Labs, Inc. by:



TESTING CERTIFICATE #2381.01

  
\_\_\_\_\_  
Graeme Grieve  
Quality Manager MiCOM Labs, Inc.

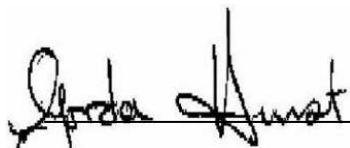
  
\_\_\_\_\_  
Gordon Hurst  
President & CEO MiCOM Labs, Inc.

This test report may be reproduced in full only. The document may only be updated by MiCOM Labs personnel. Any changes will be noted in the Document History section of the report.

## 4 REFERENCES AND MEASUREMENT UNCERTAINTY

### 4.1 Normative References

Ref.	Publication	Year	Title
i.	47 CFR Part 15, SubPart 15.247	2007	For Digitally Modulated Intentional Radiators
ii.	Industry Canada RSS-210	Issue 7 June 2007	Low Power License-Exempt Radiocommunication Devices (All Frequency Bands)
iii.	Industry Canada RSS-Gen	Issue 2 June 2007	General Requirements and Information for the Certification of Radiocommunication Equipment.
iv.	ANSI C63.4	2009	American National Standards for Methods of Measurement of Radio-Noise Emissions from Low-Voltage Electrical and Electronic Equipment in the Range of 9 kHz to 40 GHz
v.	CISPR 22/ EN 55022	2008 2006+A1:2007	Limits and Methods of Measurements of Radio Disturbance Characteristics of Information Technology Equipment
vi.	M 3003	Edition 1 Dec. 1997	Expression of Uncertainty and Confidence in Measurements
vii.	LAB34	Edition 1 Aug 2002	The expression of uncertainty in EMC Testing
viii.	ETSI TR 100 028	2001	Parts 1 and 2 Electromagnetic compatibility and Radio Spectrum Matters (ERM); Uncertainties in the measurement of mobile radio equipment characteristics
ix.	A2LA	9 <sup>th</sup> June 2010	Reference to A2LA Accreditation Status – A2LA Advertising Policy



**Title:** Zebra Enterprise Solutions WhereLAN III  
**To:** FCC 47 CFR Part 15.247 & IC RSS-210  
**Serial #:** GBCC01-U1 Rev A  
**Issue Date:** 6th December 2010  
**Page:** Page 11 of 72

---

## 4.2 Test and Uncertainty Procedures

Conducted and radiated emission measurements were conducted in accordance with American National Standards Institute ANSI C63.4, listed in the Normative References section of this report.

Measurement uncertainty figures are calculated in accordance with ETSI TR 100 028 Parts 1 and 2.

Measurement uncertainties stated are based on a standard uncertainty multiplied by a coverage factor  $k = 2$ , providing a level of confidence of approximately 95 % in accordance with UKAS document M 3003 listed in the Normative References section of this report.

---

This test report may be reproduced in full only. The document may only be updated by MiCOM Labs personnel. Any changes will be noted in the Document History section of the report.



## 5 TEST SUMMARY

### List of Measurements:

The following table represents the list of measurements required under the **FCC CFR47 Part 15.247** and **Industry Canada RSS-210** and **Industry Canada RSS-Gen**.

Section(s)	Test Items	Description	Condition	Result	Test Report Section
15.247(a)(2) A8.2(1) 4.4	6 dB and 99 % Bandwidths	≥500 kHz	Conducted	Complies	7.1
15.247(b)(3) 15.31(e) A8.4(4)	Peak Output Power  Voltage Variation	Shall not exceed 1W  Variation of supply voltage 85 % -115 %	Conducted	Complies	7.2
15.247(e) A8.2	Peak Power Spectral Density	Shall not be greater than +8 dBm in any 3 kHz band	Conducted	Complies	7.3
15.247(i) 5.5	Maximum Permissible Exposure	Exposure to radio frequency energy levels	Conducted	Complies	7.4
15.247(d) 15.205 / 15.209 A8.5 2.2 4.7	Spurious Emissions (30MHz - 26 GHz b/g and 30 MHz – 40 GHz a)	The radiated emission in any 100 kHz of out- band shall be at least 20 dB below the highest in- band spectral density	Conducted	Complies	7.5

This test report may be reproduced in full only. The document may only be updated by MiCOM Labs personnel. Any changes will be noted in the Document History section of the report.



**List of Measurements (continued)**

The following table represents the list of measurements required under the **FCC CFR47 Part 15.247**, **Industry Canada RSS-210**, and **Industry Canada RSS-Gen**.

Section(s)	Test Items	Description	Condition	Result	Test Report Section
15.247(d) 15.205 / 15.209 A8.5 2.2 2.6 4.7	Radiated Emissions	Restricted Bands	Radiated	Complies	7.6
	Transmitter Radiated Spurious Emissions	Emissions above 1 GHz		Complies	
	Radiated Band Edge	Band-edge results		Complies	
Industry Canada only RSS-Gen §4.10, §6	Receiver Spurious Emissions	Peak Emissions Emissions above 1 GHz	Conducted	Complies	7.7
15.205 / 15.209 2.2	Radiated Spurious Emissions	Emissions <1 GHz (30M-1 GHz)	Radiated	Complies	7.8
15.207 7.2.2	AC Wireline Conducted Emissions 150 kHz–30 MHz	Conducted Emissions	Conducted	Complies	7.9

**Note 1:** Test results reported in this document relate only to the items tested

**Note 2:** The required tests demonstrated compliance as per client declaration of test configuration, monitoring methodology and associated pass/fail criteria

**Note 3:** Section 3.7 Equipment Modifications highlights the equipment modifications that were required to bring the product into compliance with the above test matrix

## 6 PRODUCT DETAILS AND TEST CONFIGURATIONS

### 6.1 Test Program Scope

The scope of the test program was to test the Zebra Enterprise Solutions Corp. WhereLAN III Location Sensor Wireless Location System for compliance against FCC 47 CFR Part 15, SubPart 15.247 & IC RSS-210.

**APPLICANT:** Zebra Enterprise Solutions Corp.

**PRODUCT:** WhereLAN III LOCATION SENSOR



This test report may be reproduced in full only. The document may only be updated by MiCOM Labs personnel. Any changes will be noted in the Document History section of the report.



**Title:** Zebra Enterprise Solutions WhereLAN III  
**To:** FCC 47 CFR Part 15.247 & IC RSS-210  
**Serial #:** GBCC01-U1 Rev A  
**Issue Date:** 6th December 2010  
**Page:** Page 15 of 72

## 6.2 EUT Details

Detail	Description
Purpose:	Test of the Zebra Enterprise Solutions Corp. WhereLAN III Location Sensor Wireless Location System for compliance against FCC 47 CFR Part 15, SubPart 15.247 & IC RSS- 210
Applicant:	Zebra Enterprise Solutions Corp.
Manufacturer:	Zebra Enterprise Solutions Corp.
Test Laboratory:	MiCOM Labs, Inc. 440 Boulder Court, Suite 200 Pleasanton, California 94566 USA
Test report reference number:	GBCC01
Date EUT received:	25 <sup>th</sup> October 2010
Dates of test (from - to):	25 <sup>th</sup> October to 2 <sup>nd</sup> November 2010
No of Units Tested:	1
Product Name:	WhereLAN III Location Sensor
Manufacturers Trade Name:	WhereLAN III Location Sensor
Model No.:	LOS-5000
Equipment Primary Function:	Wireless Location System
Equipment Secondary Function(s):	None
Type of Technology:	Wireless (802.11b/g and ISO24730)
Installation type:	Fixed
Construction/Location for Use:	Indoor/Outdoor
Software/Firmware Release:	Rev B
Hardware Release:	Rev 01
Test Software Release:	Windows XP HyperTerminal and FEPdebugger.exe dated 1/13/2009
Transmit/Receive Operation:	Full Duplex
Output Power Type	Stepped fixed for ISO
Automatic Transmit Power Control Available:	N/A
Remote Frequency Control Available:	N/A
Operating Frequency:	2441.75 MHz
Rated Input Voltage and Current DC:	Nominal: 48      Max: 36      Min: 57 Current: 0.35 (A)
Operating Temperature Range °C:	Min: -40      Max: +60°C
ITU Emission Designator(s):	802.11b/g ISO24730 DSSS BPSK
Long Term Frequency Stability:	20 ppm
Equipment Dimensions:	10.25 in X 12.25 in X 1.50 in
Weight:	7 lbs

This test report may be reproduced in full only. The document may only be updated by MiCOM Labs personnel. Any changes will be noted in the Document History section of the report.



**Title:** Zebra Enterprise Solutions WhereLAN III  
**To:** FCC 47 CFR Part 15.247 & IC RSS-210  
**Serial #:** GBCC01-U1 Rev A  
**Issue Date:** 6th December 2010  
**Page:** Page 16 of 72

### 6.3 External A.C/D.C Power Adaptor

Type	Manufacturer	Manufacturers P/N	Input	Output
AC/DC P/S	MEPOS	SIDA25A-S11	100-240V (47-63Hz) 0.55A	48Vdc 0.52A
AC/DC P/S	MEPOS	STDA16A-S11	100-240V (47-63Hz) 0.4A	48Vdc 0.31A
POE	ITE	PW182RB4800F01	100-240V (50-60Hz) 0.6A	48Vdc 0.35A

### 6.4 Operational Power Range

Declared O/P Power Range	Mode 1	
	Max	Min
EUT	10	0

This test report may be reproduced in full only. The document may only be updated by MiCOM Labs personnel. Any changes will be noted in the Document History section of the report.





## 6.5 Types of Modulation Supported

Modulation / Mode	BW 1
ISO24730 DSSS BPSK	60 MHz
802.11b/g	22 MHz

## 6.6 Antenna Details

The following is a description of the EUT antennas.

Antenna Type:	Manufacturer	Model	Gain (dBi)	Frequency Range (MHz)
ISO24730, Helical	ZES	AK-210-10	3	2412-2472
ISO24730, Helical	ZES	AK-110-10	3	2412-1472
802.11, Dipole	Cisco	AIR-ANT4941	2	2402-2495
802.11, Dipole	Cisco	AIR-ANT2506	5.2	2400-2484
802.11 Yagi	Cisco	AIR-ANT1949	13.5	2400-2484

## 6.7 Cabling and I/O Ports

The following is a description of the cable and input, output ports available on the EUT.

Type of I/O Ports	Description	Screened (Y/N)	Qty
RJ-45	Ethernet	N	1
RJ-22	Timing Ports	N	3
DB-9 Male	Serial Port	N	1
MCX female	RF output ports for ISO24730	Y	2
SMB male	RF output port for WIFI	y	1



## 6.8 EUT Configurations

Band (GHz)	Mode	Freq Band (MHz)	Freq Range (MHz)	Low ch	Mid ch	High ch	# Ch	Ch Spacing (MHz)	ChBW (MHz)
2.4	ISO24730 DSSS	2400 - 2483.5	2412 - 2462	--	2441.75	--	1	--	67

## 6.9 Equipment Details

The following is a description of EUT and supporting equipment used during the test program.

Type (EUT/Support)	Equipment Description	Manufacturer	Model No.	Part No (s).
EUT	Location Sensor	Zebra Enterprise Solutions Corp.	LOS-5000	LOS-5000-01AA
Support	Remote Telemetry Module	Zebra Enterprise Solutions Corp.	TFF-2225	TFF-2225-00AA
Support	Laptop PC	Dell	PP18L	72MUF A02
Support	Laptop PC	Dell	PPL	9172P

## 6.10 Test Configurations

Operational Mode(s)	Data Rate Tested	Duty Cycle
ISO24730 DSSS	59.7 kbps	100

This test report may be reproduced in full only. The document may only be updated by MiCOM Labs personnel. Any changes will be noted in the Document History section of the report.



**Title:** Zebra Enterprise Solutions WhereLAN III  
**To:** FCC 47 CFR Part 15.247 & IC RSS-210  
**Serial #:** GBCC01-U1 Rev A  
**Issue Date:** 6th December 2010  
**Page:** Page 19 of 72

---

## **6.11 Equipment Modifications**

The following modifications were required to bring the equipment into compliance:

- No modifications required.

## **6.12 Deviations from the Test Standard**

The following deviations from the test standard were required in order to complete the test program:

- No deviations required.

---

This test report may be reproduced in full only. The document may only be updated by MiCOM Labs personnel. Any changes will be noted in the Document History section of the report.

## 7 TEST RESULTS

### 7.1 6 dB and 99% Bandwidth

#### Test Procedure

The test methodology and conditions utilized for each measurement is referenced in the following test results matrix. 6 dB and 99% bandwidth were measured per the Test Configuration identified below.

Testing was restricted to a single port.

#### Test Configuration

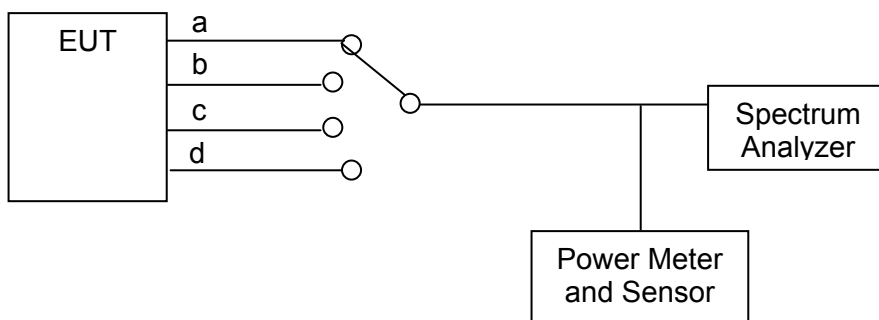

Test configuration for 6 dB & 99% Bandwidth

#### Specification

##### Limits

#### §15.247 (a)(2) & RSS-210 §A8.2(1)

The minimum 6 dB bandwidth shall be at least 500 kHz.

**§ IC RSS-Gen 4.4.1 Occupied Bandwidth** When an occupied bandwidth value is not specified in the applicable RSS, the transmitted signal bandwidth to be reported is to be its 99% emission bandwidth, as calculated or measured.

**§ IC RSS-Gen 4.4.2 6 dB Bandwidth** Where indicated, the 6 dB bandwidth is measured at the points when the spectral density of the signal is 6 dB down from the in-band spectral density of the modulated signal, with the transmitter modulated by a representative signal.



**Title:** Zebra Enterprise Solutions WhereLAN III  
**To:** FCC 47 CFR Part 15.247 & IC RSS-210  
**Serial #:** GBCC01-U1 Rev A  
**Issue Date:** 6th December 2010  
**Page:** Page 21 of 72

---

**Traceability**

Method	Test Equipment Used
Measurements were made per work instruction WI-03 'Measurement of RF Spectrum Mask'	0158, 0252, 0313, 0314, 0116, 0117, 0287, 0363

---

This test report may be reproduced in full only. The document may only be updated by MiCOM Labs personnel. Any changes will be noted in the Document History section of the report.



**7.1.1 6 dB and 99% Bandwidth Results: DSSS**

<b>Test Conditions:</b>	15.247 (a)(2)	<b>Rel. Humidity (%):</b>	35 to 42
<b>Variant:</b>	DSSS	<b>Ambient Temp. (°C):</b>	19 to 22
<b>TPC:</b>	HIGH	<b>Pressure (mBars):</b>	998 to 1003
<b>Modulation:</b>	ON	<b>Duty Cycle (%):</b>	100
<b>Beam Forming Gain (Y):</b>	N/A dB	<b>Antenna Gain:</b>	3 dBi
<b>Applied Voltage:</b>	48.00 Vdc		
<b>Notes 1:</b>			
<b>Notes 2:</b>			

**6 dB Bandwidth**

Test Frequency	6 dB Bandwidth				Minimum 6dB Bandwidth Limit		Margin
	MHz				kHz	MHz	
MHz	a	b	c	d			
2441.750	28.858000	--	--	--	500	0.5	-28.358000
--	--	--	--	--			
--	--	--	--	--			

**99% Bandwidth**

Test Frequency	99 % Bandwidth					
	MHz					
MHz	a	b	c	d		
2441.750	45.210000	--	--	--		
--	--	--	--	--		
--	--	--	--	--		

<b>Measurement uncertainty:</b>	±2.81 dB
---------------------------------	----------

This test report may be reproduced in full only. The document may only be updated by MiCOM Labs personnel. Any changes will be noted in the Document History section of the report.

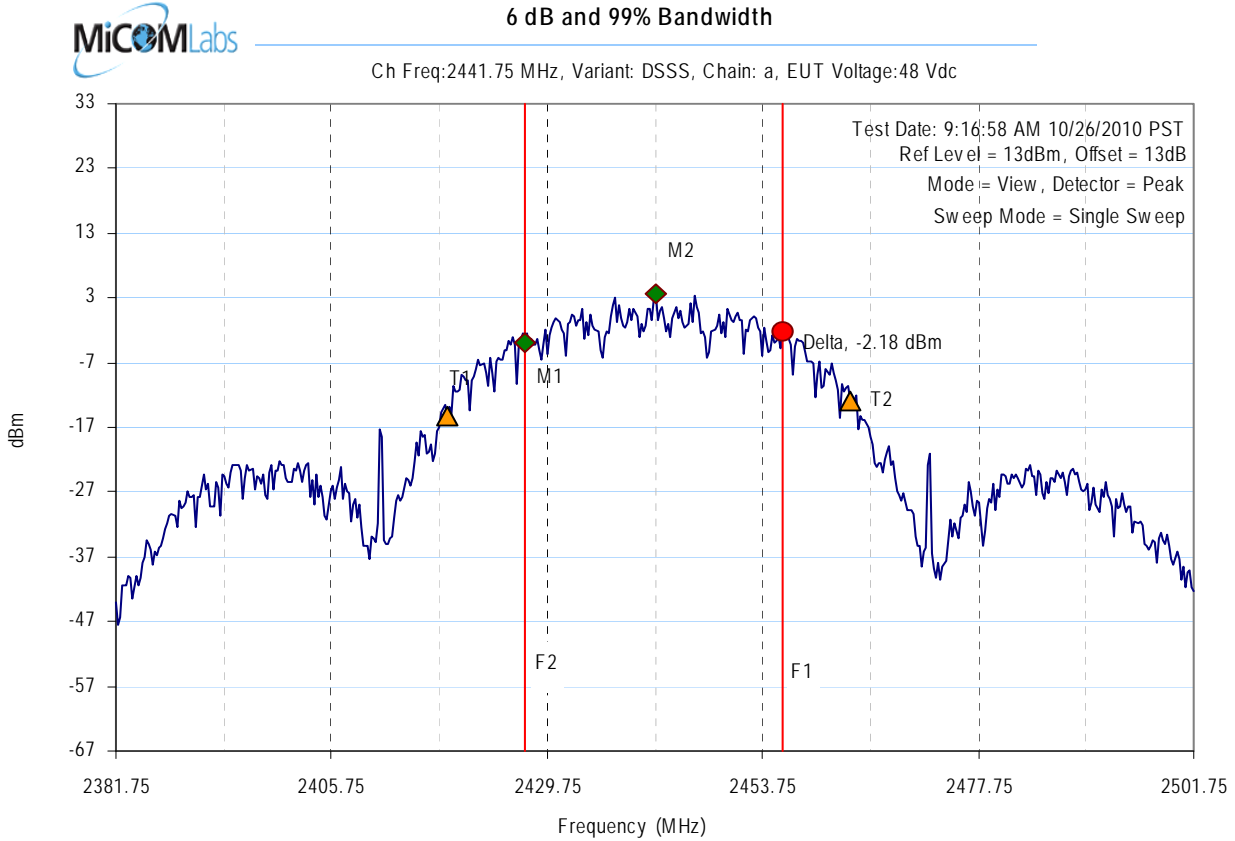

Analyser Setup	Marker : Frequency : Amplitude	Test Results
RBW = 100.00kHz	M1 : 2427.200902MHz : -3.894dBm	Center frequency = 2441.75MHz
VBW = 300.00kHz	M2 : 2441.870240MHz : 3.539dBm	6dB BW(Delta-M1) = 28.857715MHz
Sweep time(s) = 20	Delta : 2456.058617MHz : -2.182dBm	99% OBW(T2-T1) = 45.210421MHz
RF Atten (dB) = 10	T1 : 2418.543587MHz : -15.346dBm	
Span = 120.00MHz	T2 : 2463.513527MHz : -12.859dBm	

This test report may be reproduced in full only. The document may only be updated by MiCOM Labs personnel. Any changes will be noted in the Document History section of the report.

## 7.2 Peak Output Power

### Test Procedure

The test methodology and conditions utilized for each measurement is referenced in the test results matrix. The average output power was measured per the test configuration identified below.

Per the standard measurements were taken at ambient conditions, nominal voltage.

### Test Configuration

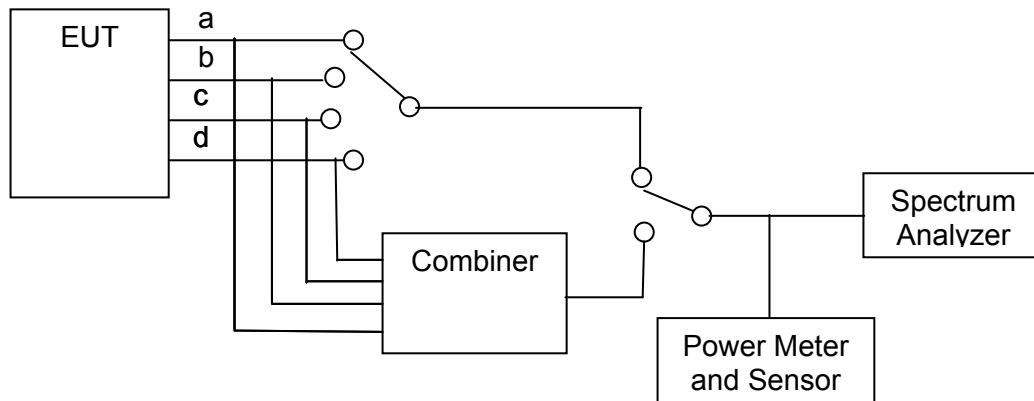

Measurement set-up for Peak Output Power

$$\text{Total Power} = A + G + Y + 10 \log (1/x) \text{ dBm}$$

A = Total Power  $[10 \text{ Log}_{10} (10^{a/10} + 10^{b/10} + 10^{c/10} + 10^{d/10})]$ , G = Antenna Gain,  
Y = Beam Forming Gain, x = Duty Cycle





**Specification**

**Limits**

**§15.247 (b)** The maximum peak output power of the intentional radiator shall not exceed the following:

**§15.247 (b) (3)** For systems using digital modulation in the 902-928 MHz, 2400-2483.5 MHz and 5725-5850 MHz bands: 1.0 watt.

**15.247 (b) (4)** The conducted output power limit specified in paragraph (b) of this section is based on the use of antennas with directional gains that do not exceed 6 dBi. Except as shown in paragraph (c) of this section, if transmitting antennas of directional gain greater than 6 dBi are used, the conducted output power from the intentional radiator shall be reduced below the stated values in paragraphs (b)(1), (b)(2), and (b)(3) of this section, as appropriate, by the amount in dB that the directional gain of the antenna exceeds 6 dBi.

15.247 (c) Operation with directional antenna gains greater than 6 dBi.

(1) Fixed point-to-point operation:

(i) Systems operating in the 2400–2483.5 MHz band that are used exclusively for fixed, point-to-point operations may employ transmitting antennas with directional gain greater than 6 dBi provided the maximum conducted output power of the intentional radiator is reduced by 1 dB for every 3 dB that the directional gain of the antenna exceeds 6 dBi.

(ii) Systems operating in the 5725–5850 MHz band that are used exclusively for fixed, point-to-point operations may employ transmitting antennas with directional gain greater than 6 dBi without any corresponding reduction in transmitter conducted output power.

**§15.31 (e)** For intentional radiators, measurements of the variation of the input power or the radiated signal level of the fundamental frequency component of the emission, as appropriate, shall be performed with the supply voltage varied between 85% and 115% of the nominal rated supply voltage. For battery operated equipment, the equipment tests shall be performed using a new battery.

**§ RSS-210 A8.4(4)** For systems employing digital modulation techniques operating in the 902-928 MHz, 2400-2483.5 MHz and 5725-5850 MHz bands the maximum peak conducted power shall not exceed 1 watt.

**Traceability**

Method	Test Equipment Used
Measurements were made per work instruction WI-01 'Measuring RF Output Power'	0158, 0252, 0313, 0314, 0223, 0116, 0117, 0287, 0363

This test report may be reproduced in full only. The document may only be updated by MiCOM Labs personnel. Any changes will be noted in the Document History section of the report.



**7.2.1 Measurement Results: DSSS**

<b>Test Conditions:</b>	15.247 (b)	<b>Rel. Humidity (%):</b>	35	to	42
<b>Variant:</b>	DSSS	<b>Ambient Temp. (°C):</b>	19	to	22
<b>TPC:</b>	HIGH	<b>Pressure (mBars):</b>	998	to	1003
<b>Modulation:</b>	ON	<b>Duty Cycle (%):</b>	100		
<b>Beam Forming</b>	N/A	<b>Antenna Gain:</b>	3	dBi	
<b>Applied Voltage:</b>	48.00	Vdc			
<b>Notes 1:</b>					
<b>Notes 2:</b>					

Test Frequenc	Measured Peak Power				Total Power (dBm)		Limit dBm	Margin dB
	RF Port (dBm)				Combined	Calculated		
MHz	a	b	c	d				
2442	18.52	--	--	--	18.52	--	30.00	-11.48
0	--	--	--	--	--	--	30.00	
0	--	--	--	--	--	--	30.00	

<b>Measurement uncertainty:</b>	±1.33 dB
---------------------------------	----------

This test report may be reproduced in full only. The document may only be updated by MiCOM Labs personnel. Any changes will be noted in the Document History section of the report.

### 7.3 Peak Power Spectral Density

#### Test Procedure

The test methodology and conditions utilized for each measurement is referenced in the following test results matrix. RF output power, transmit power control and power density were measured per the Test Configuration identified below.

Testing was performed on the highest and lowest power settings of the equipment.

Per the standard measurements were taken at ambient and extreme temperature conditions at nominal and extreme voltage levels.

#### Test Configuration

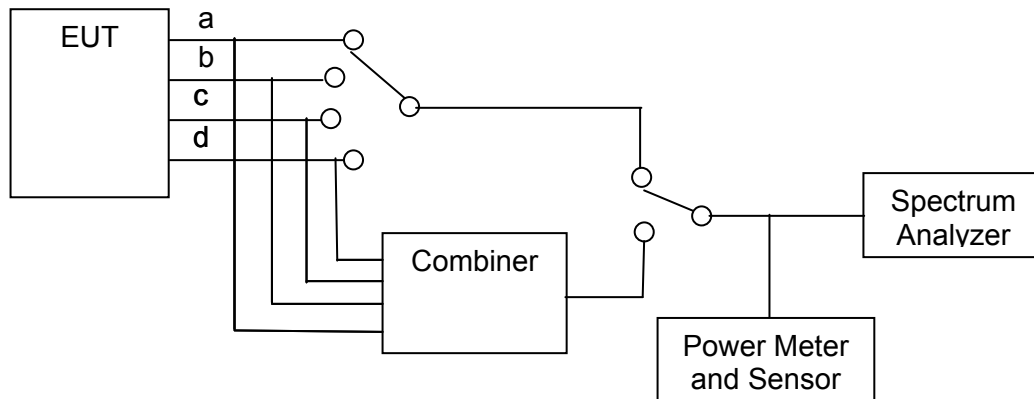

Measurement set-up for Peak Power Spectral Density

#### Specification

##### Peak Power Spectral Density Limits

**§15.247 (e)** For digitally modulated systems, the power spectral density conducted from the intentional radiator to the antenna shall not be greater than +8 dBm in any 3 kHz band during any time interval of continuous transmission

**RSS-210 §A8.2(2)** The transmitter power spectral density (into the antenna) shall not be greater than +8 dBm in any 3 kHz band during any time interval of continuous transmission or over 1.0 second if the transmission exceeds 1.0 second duration.

#### Traceability

Method	Test Equipment Used
Measurements were made per work instruction WI-01 'Measuring RF Output Power'	0158, 0252, 0313, 0314, 0223, 0116, 0117, 0287, 0363

This test report may be reproduced in full only. The document may only be updated by MiCOM Labs personnel. Any changes will be noted in the Document History section of the report.



**Title:** Zebra Enterprise Solutions WhereLAN III  
**To:** FCC 47 CFR Part 15.247 & IC RSS-210  
**Serial #:** GBCC01-U1 Rev A  
**Issue Date:** 6th December 2010  
**Page:** Page 28 of 72

### 7.3.1 Measurement results for DSSS

<b>Test Conditions:</b>	15.247 (e)	<b>Rel. Humidity (%):</b>	35	to	42
<b>Variant:</b>	DSSS	<b>Ambient Temp. (°C):</b>	19	to	22
<b>TPC:</b>	HIGH	<b>Pressure (mBars):</b>	998	to	1003
<b>Modulation:</b>	ON	<b>Duty Cycle (%):</b>	100		
<b>Beam Forming</b>	N/A	<b>Antenna Gain:</b>	3	dBi	
<b>Applied Voltage:</b>	48.00	Vdc			
<b>Notes 1:</b>					
<b>Notes 2:</b>					

Test Frequency	Measured Power Density				Total Peak Power Spectral Density (dBm)		Limit	Margin
	RF Port (dBm)				Combined	Calculated		
MHz	a	b	c	d				
2441.750	0.47	--	--	--	0.47	--	8.00	-7.53
0.000	--	--	--	--	--	--	8.00	
0.000	--	--	--	--	--	--	8.00	

<b>Measurement uncertainty:</b>	± 1.33 dB
---------------------------------	-----------

This test report may be reproduced in full only. The document may only be updated by MiCOM Labs personnel. Any changes will be noted in the Document History section of the report.

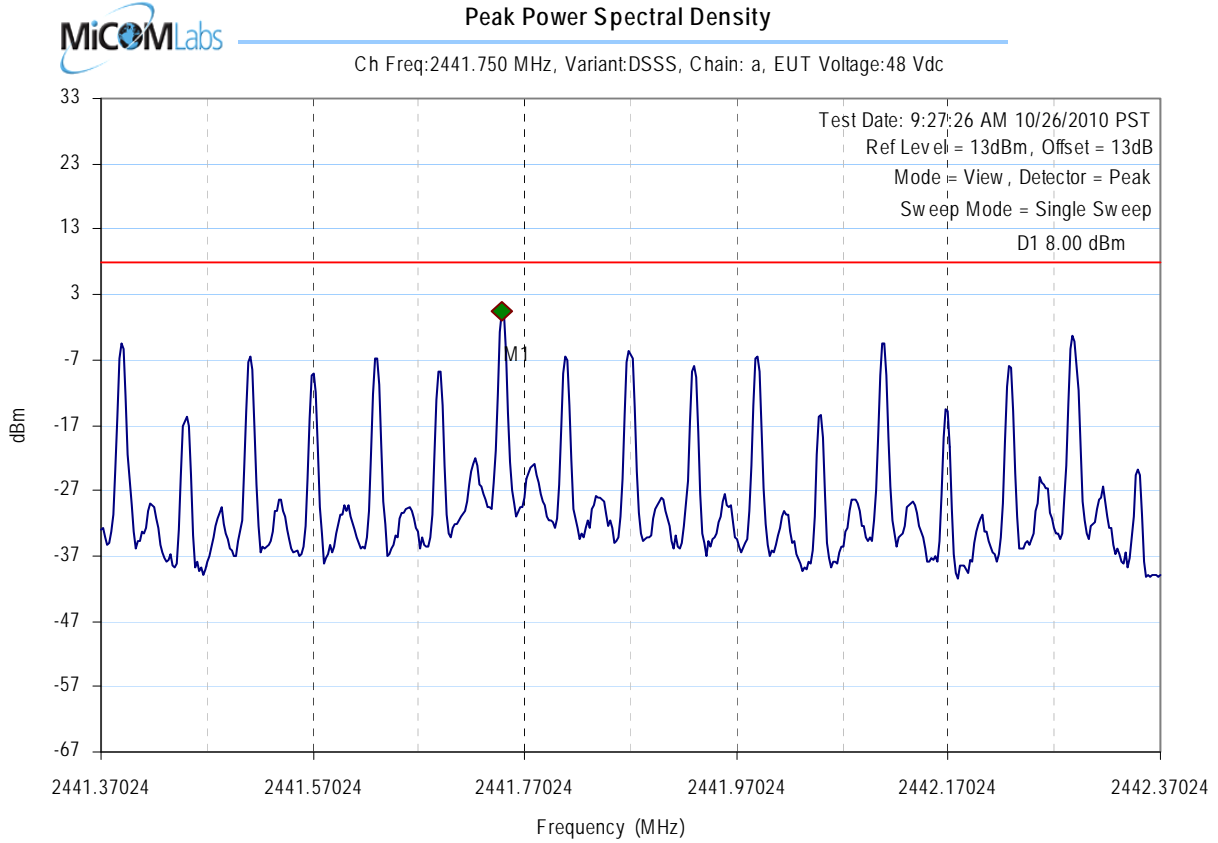

Analyser Setup	Marker : Frequency : Amplitude	Test Results
RBW = 3.00KHz	M1 : 2441.748998MHz : .472dBm	Center frequency = 2441.75MHz
VBW = 10.00KHz		
Sweep time(s) = 350		
RF Atten (dB) = 20		
Span = 1.00MHz		

This test report may be reproduced in full only. The document may only be updated by MiCOM Labs personnel. Any changes will be noted in the Document History section of the report.



## 7.4 Maximum Permissible Exposure

**FCC, Part 15 Subpart C §15.407(f)**

**Industry Canada RSS-Gen §5.5**

### Calculations for Maximum Permissible Exposure Levels

$$\text{Power Density} = P_d \text{ (mW/cm}^2\text{)} = \text{EIRP}/(4\pi d^2)$$

$$\text{EIRP} = P * G$$

P = Peak output power (mW)

G = Antenna numeric gain (numeric)

d = Separation distance (cm)

$$\text{Numeric Gain} = 10^{(G \text{ (dBi)}/10)}$$

The peak power in the table below is calculated by assuming a worst case scenario where all of the EUT transmitters are operating simultaneously in the same band. The Peak Power in mW is the highest transmitter power measured and summed across all transmitters.

Because the EUT belongs to the General Population/Uncontrolled Exposure the limit of power density is 1.0 mW/cm<sup>2</sup>

Freq. Band (MHz)	Antenna Gain (dBi)	Numeric Gain (numeric)	Peak Output Power (dBm)	Peak Output Power (mW)	Calculated Safe Distance @ 1mW/cm <sup>2</sup> Limit(cm)	Minimum Separation Distance (cm)
2400 – 2500	3.0	2.0	18.52	71.12	3.4	20.00

\*Note: for mobile or fixed location transmitters the minimum separation distance is 20cm, even if calculations indicate the MPE distance to be less.

### Specification

#### Maximum Permissible Exposure Limits

§15.247(i) Systems operating under the provisions of this section shall be operated in a manner that ensures that the public is not exposed to radio frequency levels in excess of the Commission's guidelines.

FCC §1.1310 Limit = 1mW / cm<sup>2</sup> from 1.310 Table 1

**RSS-Gen §5.5** Before equipment certification is granted, the application requirements of RSS-102 shall be met.

#### Laboratory Measurement Uncertainty for Power Measurements

Measurement uncertainty	±1.33 dB
-------------------------	----------

This test report may be reproduced in full only. The document may only be updated by MiCOM Labs personnel. Any changes will be noted in the Document History section of the report.

## 7.5 Conducted Spurious

### Test Procedure

Conducted emissions were measured at a limit of 20 dB below the highest in-band spectral density measured with a spectrum analyzer connected to the antenna terminal. Emissions at the band edge were measured and recorded. Measurements were made while EUT was operating in transmit mode of operation at the appropriate center frequency.

Measurements were made using a combiner with the transmitter tuned to the channel closest to the band-edge being measured. All emissions were maximized during measurement. Limits which were derived from the peak emission.

### Test Measurement Set up

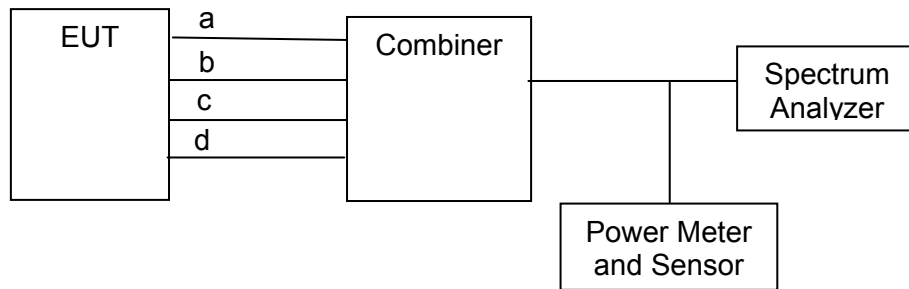

Conducted Spurious Emission measurement test configuration



## Specification

### Limits Band-Edge

Lower Limit Band-edge	Upper Limit Band-edge	Limit below highest level of desired power
2,400 MHz	2,483.5 MHz	≥ 20 dB
5725 MHz	5850 MHz	

**§15.247(d)** In any 100 kHz bandwidth outside the frequency band in which the spread spectrum or digitally modulated intentional radiator is operating, the radio frequency power that is produced by the intentional radiator shall be at least 20 dB below that in the 100 kHz bandwidth within the band that contains the highest level of the desired power, based on either an RF conducted or radiated measurement, provided the transmitter demonstrates compliance with the peak conducted power limits.

#### §15.247(d)

If the transmitter complies with the conducted power limits based on the use of RMS averaging over a time interval, as permitted under paragraph (b)(3) of this section, the attenuation required under this paragraph shall be 30 dB instead of 20 dB. Attenuation below the general limits specified §15.209(a) is not required. In addition, radiated emissions which fall in the restricted bands, as defined in Section §15.205(a), must also comply with the radiated emission limits specified in Section 15.209(a) (see Section 15.205(a)).

**RSS-210 §A8.5** If the transmitter complies with the conducted power limits based on the use of RMS averaging over a time interval, as permitted under section A8.4(4), the attenuation required shall be 30 dB instead of 20 dB. Attenuation below the general limits specified in Tables 2 and 3 is not required. In addition, radiated emissions which fall in the restricted bands of Table 1 must also comply with the radiated emission limits specified in Tables 2 and 3.

#### RSS-Gen §4.7

The search for unwanted emissions shall be from the lowest frequency internally generated or used in the device (local oscillator, intermediate of carrier frequency), or from 30 MHz, whichever is the lowest frequency, to the 5<sup>th</sup> harmonic of the highest frequency generated without exceeding 40 GHz.

## Traceability

Method	Test Equipment Used
Measurements were made per work instruction WI-05 'Measurement of Spurious Emissions'	0158, 0252, 0313, 0314, 0223, 0116, 0117, 0287, 0363.

This test report may be reproduced in full only. The document may only be updated by MiCOM Labs personnel. Any changes will be noted in the Document History section of the report.





### 7.5.1 Measurement Results for DSSS

<b>Test Conditions:</b>	15.247 (a)(2)	<b>Rel. Humidity (%):</b>	35 to 42
<b>Variant:</b>	DSSS	<b>Ambient Temp. (°C):</b>	19 to 22
<b>TPC:</b>	HIGH	<b>Pressure (mBars):</b>	998 to 1003
<b>Modulation:</b>	ON	<b>Duty Cycle (%):</b>	100
<b>Beam Forming</b>	N/A dB	<b>Antenna Gain:</b>	N/A dBi
<b>Applied Voltage:</b>	48.00 Vdc		
<b>Notes 1:</b>			
<b>Notes 2:</b>			

#### *Conducted Spurious Measurement*

Test Frequency	Start Frequency	Stop Frequency	Maximum Observed Emission	Limit (20 dB below peak of fundamental)
MHz	MHz	MHz	dBm	dBm
2441.750	30.00	26000.00	-45.75	-17.02

#### *Band-edge Measurement*

Test Frequency	Band-edge Frequency	Emission Amplitude @ Band-edge	Limit (20 dB below peak of fundamental)	Margin
MHz	MHz	dBm	dBm	dB
2441.750	2400.00	-23.70	-16.57	-7.13
2441.750	2483.50	-25.28	-16.93	-8.36

<b>Measurement uncertainty:</b>	±2.81 dB
---------------------------------	----------

This test report may be reproduced in full only. The document may only be updated by MiCOM Labs personnel. Any changes will be noted in the Document History section of the report.

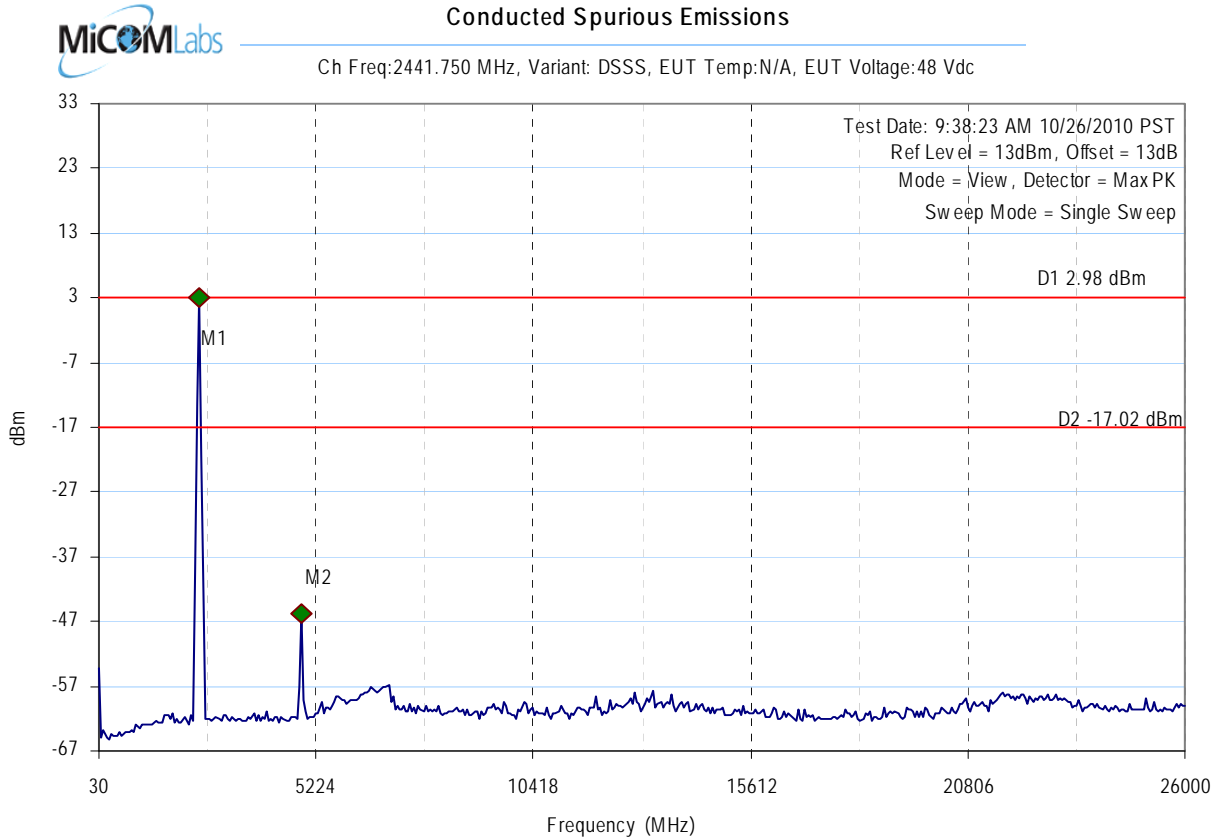

Analyser Setup	Marker : Frequency : Amplitude	Test Results
RBW = 100.00KHz	M1 : 2424.028056MHz : 2.978dBm	Center frequency = 2441.75MHz
VBW = 300.00KHz	M2 : 4870.100200MHz : -45.749dBm	
Sweep time(s) = 60		
RF Atten (dB) = 10		
Span = 25.97GHz		

This test report may be reproduced in full only. The document may only be updated by MiCOM Labs personnel. Any changes will be noted in the Document History section of the report.

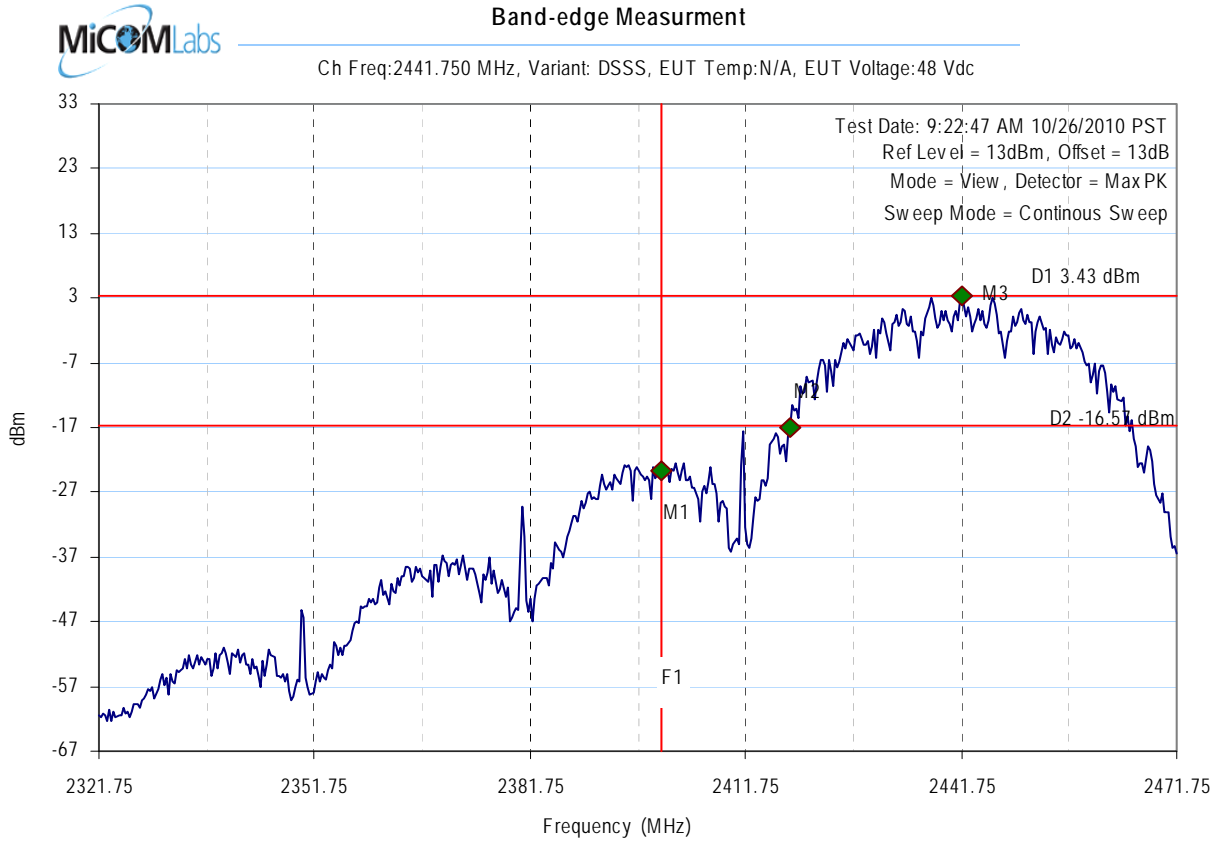

**Analyser Setup**

RBW = 100.00KHz  
VBW = 300.00KHz  
Sweep time(s) = 20  
RF Atten (dB) = 10  
Span = 150.00MHz

**Marker : Frequency : Amplitude**

M1 : 2400.000000MHz : -23.699dBm  
M2 : 2417.942385MHz : -17.061dBm  
M3 : 2441.990481MHz : 3.427dBm

**Test Results**

Center frequency = 2441.75MHz

This test report may be reproduced in full only. The document may only be updated by MiCOM Labs personnel. Any changes will be noted in the Document History section of the report.

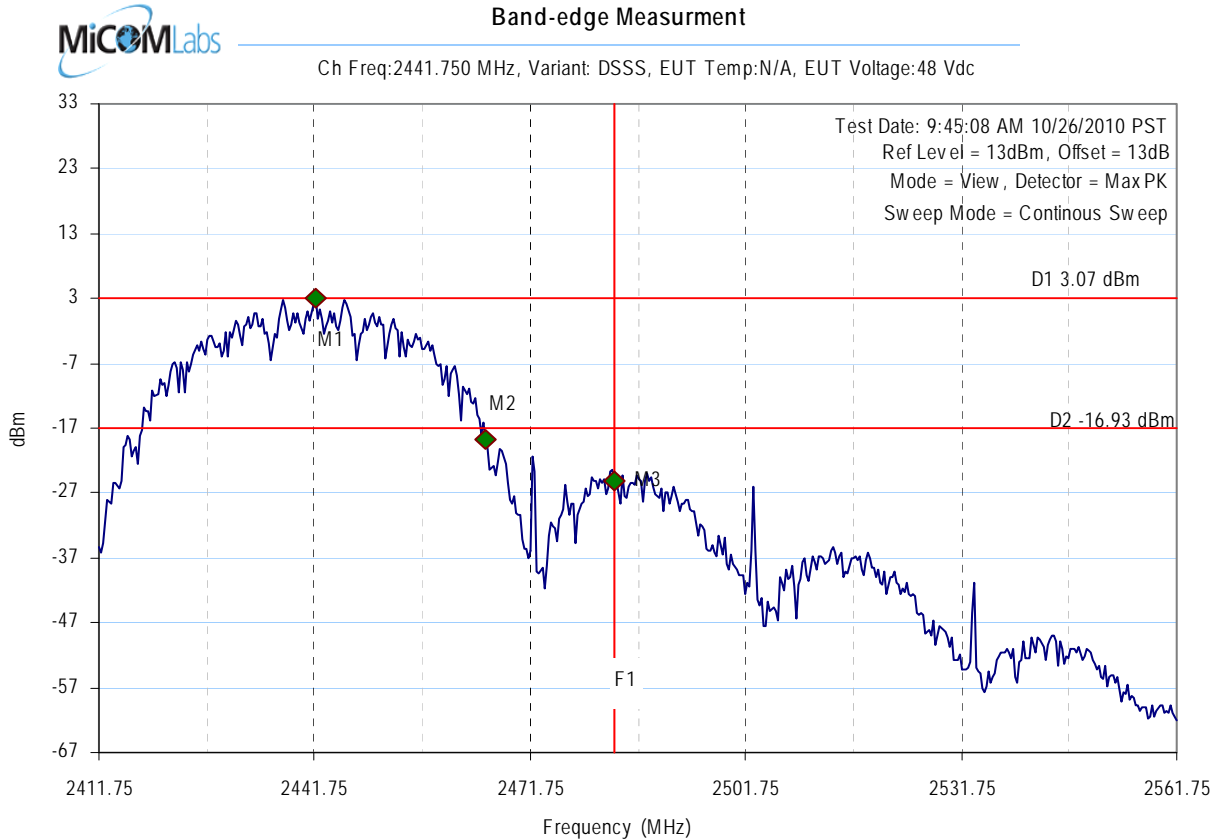

**Analyser Setup**

RBW = 100.00KHz  
VBW = 300.00KHz  
Sweep time(s) = 20  
RF Atten (dB) = 10  
Span = 150.00MHz

**Marker : Frequency : Amplitude**

M1 : 2441.810120MHz : 3.073dBm  
M2 : 2465.557615MHz : -18.836dBm  
M3 : 2483.500000MHz : -25.283dBm

**Test Results**

Center frequency = 2441.75MHz

This test report may be reproduced in full only. The document may only be updated by MiCOM Labs personnel. Any changes will be noted in the Document History section of the report.



**Title:** Zebra Enterprise Solutions WhereLAN III  
**To:** FCC 47 CFR Part 15.247 & IC RSS-210  
**Serial #:** GBCC01-U1 Rev A  
**Issue Date:** 6th December 2010  
**Page:** Page 37 of 72

---

## **7.6 Radiated Spurious Emissions**

### **Test Procedure**

Testing was performed in a 3-meter anechoic chamber. Preliminary radiated emissions were measured on every azimuth and with the receiving antenna in both horizontal and vertical polarizations. Preliminary emissions were recorded with in Spectrum Analyzer mode, using a maximum peak detector while in peak hold mode.

Emissions nearest the limits were chosen for maximization and formal measurement using a CISPR Compliant receiver. Emissions above 1000 MHz are measured utilizing a CISPR compliant average detector with a tuned receiver, using a bandwidth of 1 MHz. Emissions from 30 MHz – 1000 MHz are measured utilizing a CISPR compliant quasi-peak detector with a tuned receiver, using a bandwidth of 120 kHz. Only the highest emissions relative to the limit are listed.

---

This test report may be reproduced in full only. The document may only be updated by MiCOM Labs personnel. Any changes will be noted in the Document History section of the report.

### Radiated Emission Measurement Setup – Above 1 GHz

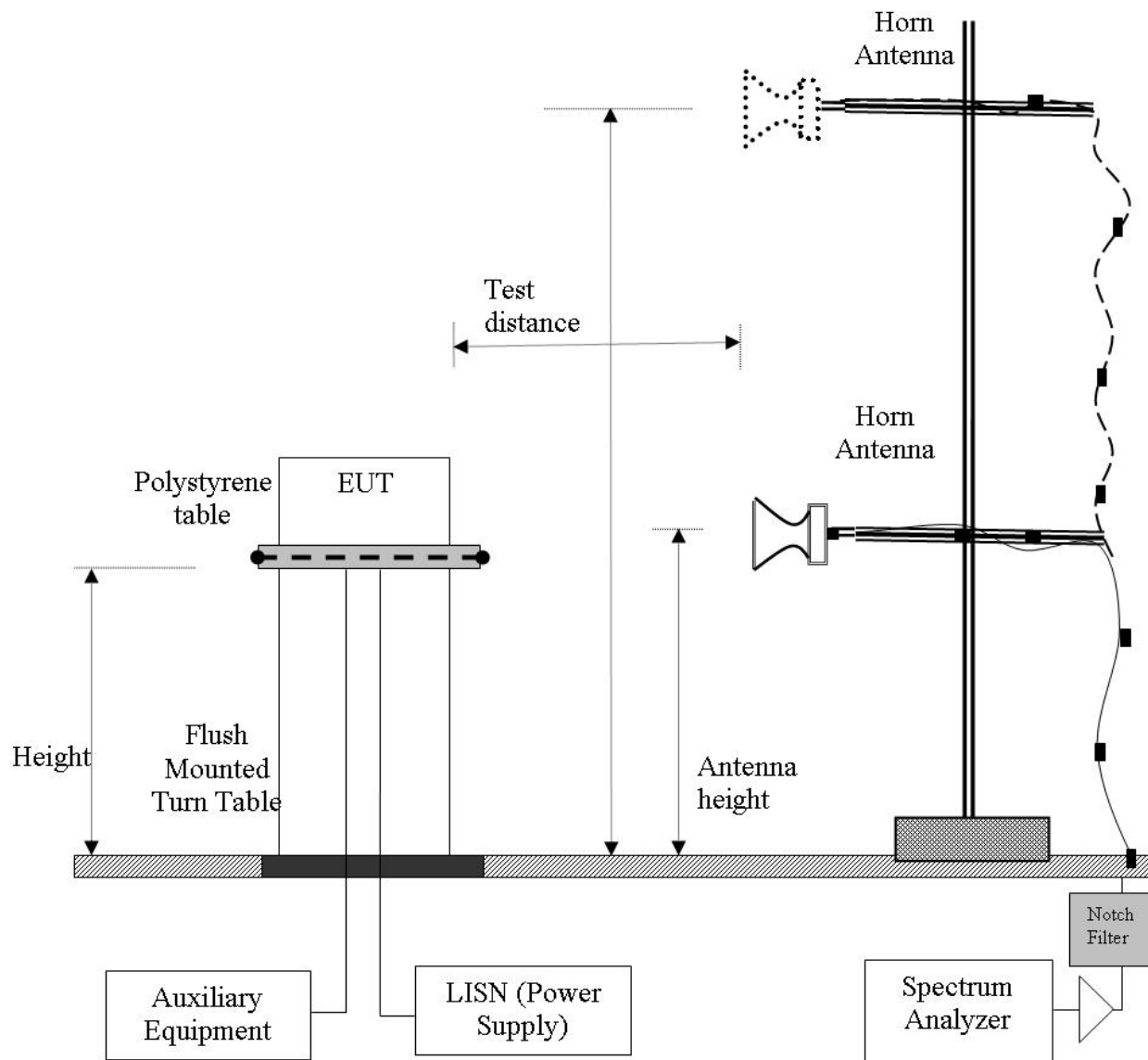

This test report may be reproduced in full only. The document may only be updated by MiCOM Labs personnel. Any changes will be noted in the Document History section of the report.

### Radiated Emission Measurement Setup – Below 1 GHz

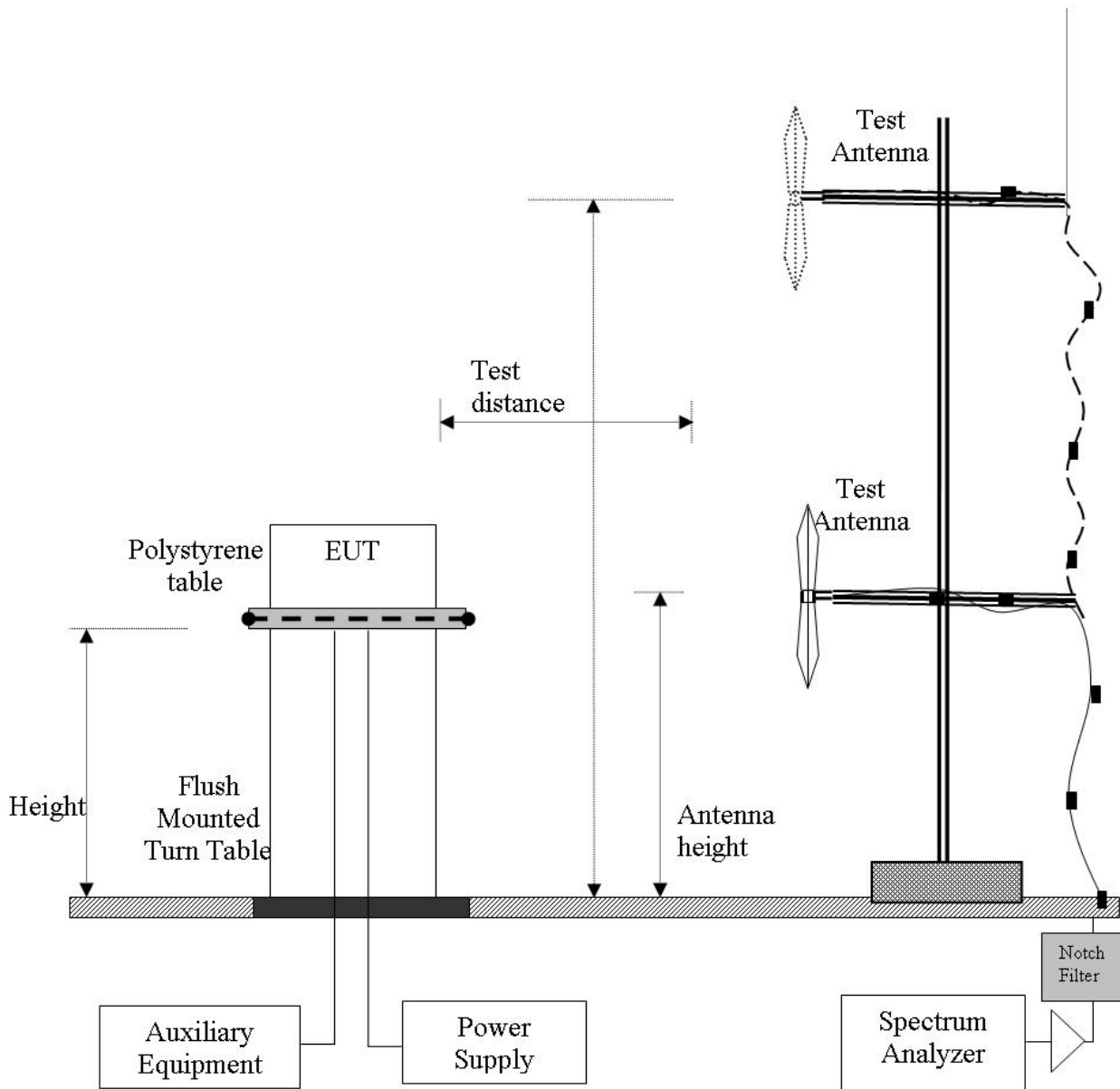

This test report may be reproduced in full only. The document may only be updated by MiCOM Labs personnel. Any changes will be noted in the Document History section of the report.



### Field Strength Calculation

The field strength is calculated by adding the Antenna Factor and Cable Loss, and subtracting Amplifier Gain from the measured reading. All factors are included in the reported data.

$$FS = R + AF + CORR - FO$$

FS = Field Strength

R = Measured Spectrum analyzer Input Amplitude

AF = Antenna Factor

$$CORR = \text{Correction Factor} = CL - AG + NFL$$

CL = Cable Loss

AG = Amplifier Gain

FO = Distance Falloff Factor

NFL = Notch Filter Loss or Waveguide Loss

#### Field Strength Calculation Example:

Given receiver input reading of 51.5 dB $\mu$ V; Antenna Factor of 8.5 dB; Cable Loss of 1.3 dB; Falloff Factor of 0 dB, an Amplifier Gain of 26 dB and Notch Filter Loss of 1 dB. The Field Strength of the measured emission is:

$$FS = 51.5 + 8.5 + 1.3 - 26.0 + 1 = 36.3 \text{ dB}\mu\text{V/m}$$

Conversion between dB $\mu$ V/m (or dB $\mu$ V) and  $\mu$ V/m (or  $\mu$ V) are done as:

$$\text{Level (dB}\mu\text{V/m)} = 20 * \text{Log (level (\mu\text{V/m}))}$$

$$40 \text{ dB}\mu\text{V/m} = 100 \mu\text{V/m}$$

$$48 \text{ dB}\mu\text{V/m} = 250 \mu\text{V/m}$$





**Title:** Zebra Enterprise Solutions WhereLAN III  
**To:** FCC 47 CFR Part 15.247 & IC RSS-210  
**Serial #:** GBCC01-U1 Rev A  
**Issue Date:** 6th December 2010  
**Page:** Page 41 of 72

## Specification Limits

**FCC §15.247(d) and RSS-210 §A8.5** In any 100 kHz bandwidth outside the frequency band in which the spread spectrum or digitally modulated intentional radiator is operating, the radio frequency power that is produced by the intentional radiator shall be at least 20 dB below that in the 100 kHz bandwidth within the band that contains the highest level of the desired power, based on either an RF conducted or radiated measurement, provided the transmitter demonstrates compliance with the peak conducted power limits.

### **FCC §15.247(d)**

If the transmitter complies with the conducted power limits based on the use of RMS averaging over a time interval, as permitted under paragraph (b)(3) of this section, the attenuation required under this paragraph shall be 30 dB instead of 20 dB. Attenuation below the general limits specified §15.209(a) is not required. In addition, radiated emissions which fall in the restricted bands, as defined in Section §15.205(a), must also comply with the radiated emission limits specified in Section 15.209(a) (see Section 15.205(a)).

**IC RSS-210 §A8.5** If the transmitter complies with the conducted power limits based on the use of RMS averaging over a time interval, as permitted under section A8.4(4), the attenuation required shall be 30 dB instead of 20 dB. Attenuation below the general limits specified in Tables 2 and 3 is not required. In addition, radiated emissions which fall in the restricted bands of Table 1 must also comply with the radiated emission limits specified in Tables 2 and 3.

### **IC RSS-Gen §4.7**

The search for unwanted emissions shall be from the lowest frequency internally generated or used in the device (local oscillator, intermediate or carrier frequency), or from 30 MHz, whichever is the lowest frequency, to the 5<sup>th</sup> harmonic of the highest frequency generated without exceeding 40 GHz.

**FCC §15.205 (a)** Except as shown in paragraph (d) of 15.205 (a), only spurious emissions are permitted in any of the frequency bands listed.

**FCC §15.205 (a)** Except as shown in paragraphs (d) and (e) of this section, the field strength of emissions appearing within these frequency bands shall not exceed the limits shown in Section §15.209. At frequencies equal to or less than 1000 MHz, compliance with the limits in Section 15.209 shall be demonstrated using measurement instrumentation employing a CISPR quasi-peak detector. Above 1000 MHz, compliance with the emission limits in Section 15.209 shall be demonstrated based on the average value of the measured emissions. The provisions in Section 15.35 apply to these measurements.

**FCC §15.209 (a)** Except as provided elsewhere in this subpart, the emissions from an intentional radiator shall not exceed the field strength levels specified in the following table.

This test report may be reproduced in full only. The document may only be updated by MiCOM Labs personnel. Any changes will be noted in the Document History section of the report.



**Title:** Zebra Enterprise Solutions WhereLAN III  
**To:** FCC 47 CFR Part 15.247 & IC RSS-210  
**Serial #:** GBCC01-U1 Rev A  
**Issue Date:** 6th December 2010  
**Page:** Page 42 of 72

**Table 1: FCC 15.209 and RSS-Gen §6 Spurious Emissions Limits**

Frequency (MHz)	Field Strength (µV/m)	Field Strength (dBµV/m)	Measurement Distance (meters)
30-88	100	40.0	3
88-216	150	43.5	3
216-960	200	46.0	3
Above 960	500	54.0	3

**Laboratory Measurement Uncertainty for Radiated Emissions**

<b>Measurement Uncertainty</b>	+5.6/ -4.5 dB
--------------------------------	---------------

**Traceability:**

Method	Test Equipment Used
Work instruction WI-03	0088, 0158, 0134, 0304, 0311, 0315, 0310, 0312

This test report may be reproduced in full only. The document may only be updated by MiCOM Labs personnel. Any changes will be noted in the Document History section of the report.



**7.6.1 Measurement Results DSSS mode: Transmitter Radiated Spurious Emissions**

<b>Test Freq.</b>	2412 MHz	<b>Engineer</b>	SB
<b>Variant</b>	DSSS 2441.75	<b>Temp (°C)</b>	22
<b>Freq. Range</b>	1000 MHz - 18000 MHz	<b>Rel. Hum.(%)</b>	34
<b>Power Setting</b>	18 dBm max power	<b>Press. (m Bars)</b>	1005
<b>Antenna</b>	AK-210-10 "Bull Horn" Omni all weather	<b>Duty Cycle (%)</b>	100
<b>Test Notes 1</b>	25 w PSU		
<b>Test Notes 2</b>			

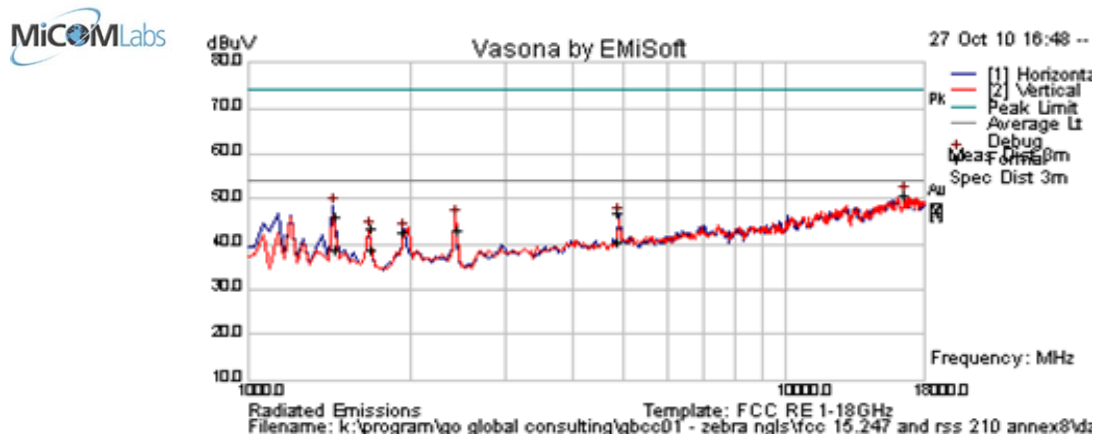

**Formally measured emission peaks**

Frequency MHz	Raw dBuV	Cable Loss	AF dB	Level dBuV	Measurement Type	Pol	Hgt cm	Azt Deg	Limit dBuV	Margin dB	Pass /Fail	Comments
1465.056	51.2	2.4	-14.6	38.9	Peak	V	147	360	74.0	-35.1	Pass	
4883.464	51.8	4.5	-9.3	47.0	Peak	V	98	170	74.0	-27.0	Pass	
1709.200	54.6	2.5	-13.4	43.7	Peak	V	98	245	74	-30.3	Pass	
1465.056	58.4	2.4	-14.6	46.1	Average	V	98	360	54	-7.9	Pass	
4883.464	45.2	4.5	-9.3	40.4	Average	V	98	170	54	-13.6	Pass	
1709.200	49.7	2.5	-13.4	38.8	Average	V	98	245	54	-15.2	Pass	
16534.980	41.7	8.8	0.4	50.9	Peak [Scan]	V	200	0	54	-3.1	Pass	NRB
1953.443	51.6	2.7	-11.6	42.8	Peak [Scan]	V	98	0	54	-11.2	Pass	NRB
2452.372	0.0	0.0	-13.4	42.9	Peak [Scan]	V	98	0	54	-11.1	Pass	NRB

Legend: TX = Transmitter Emissions; DIG = Digital Emissions; FUND = Fundamental; WB = Wideband Emission  
 RB = Restricted Band (15.209 Limits); NRB = Non Restricted Band, Limit is 20dB below fundamental peak

This test report may be reproduced in full only. The document may only be updated by MiCOM Labs personnel. Any changes will be noted in the Document History section of the report.



### 7.6.2 DSSS Radiated Band Edge Emissions

Duty cycle correction factor was applied to spurious emissions in the restricted bands closest to the fundamental transmission.

EUT Operational Duty Cycle: 2.55%  
Correction Factor =  $20 * \text{LOG} (2.55 / 100)$   
Correction Factor = -31.87 dB  
Corrected Value = Measured Value (dB) - 31.87 (dB)

Frequency (MHz)	Measured Value (dBuV/m)	Measurement Type	Corrected Value	Margin (dB)	Pass / Fail
2390.000	67.69	Peak	35.82	-38.18	Pass
2380.861	62.72	Average	30.85	-23.15	Pass
2485.880	78.70	Peak	46.83	-27.17	Pass
2488.294	69.03	Average	37.16	-16.84	Pass

This test report may be reproduced in full only. The document may only be updated by MiCOM Labs personnel. Any changes will be noted in the Document History section of the report.



### 7.6.3 Measurement Results AK-210-10 & AK-110-10: Band Edge

#### Band Edge 2390-2400 MHz DSSS 2441.75mhz h=100cm azt=180



Marker 1 [T1]	RBW	1 MHz	RF Att	30 dB
Ref Lvl	67.69 dBV	VBW	1 MHz	
100 dBV	2.3900000 GHz	SWT	60 s	Unit dBV

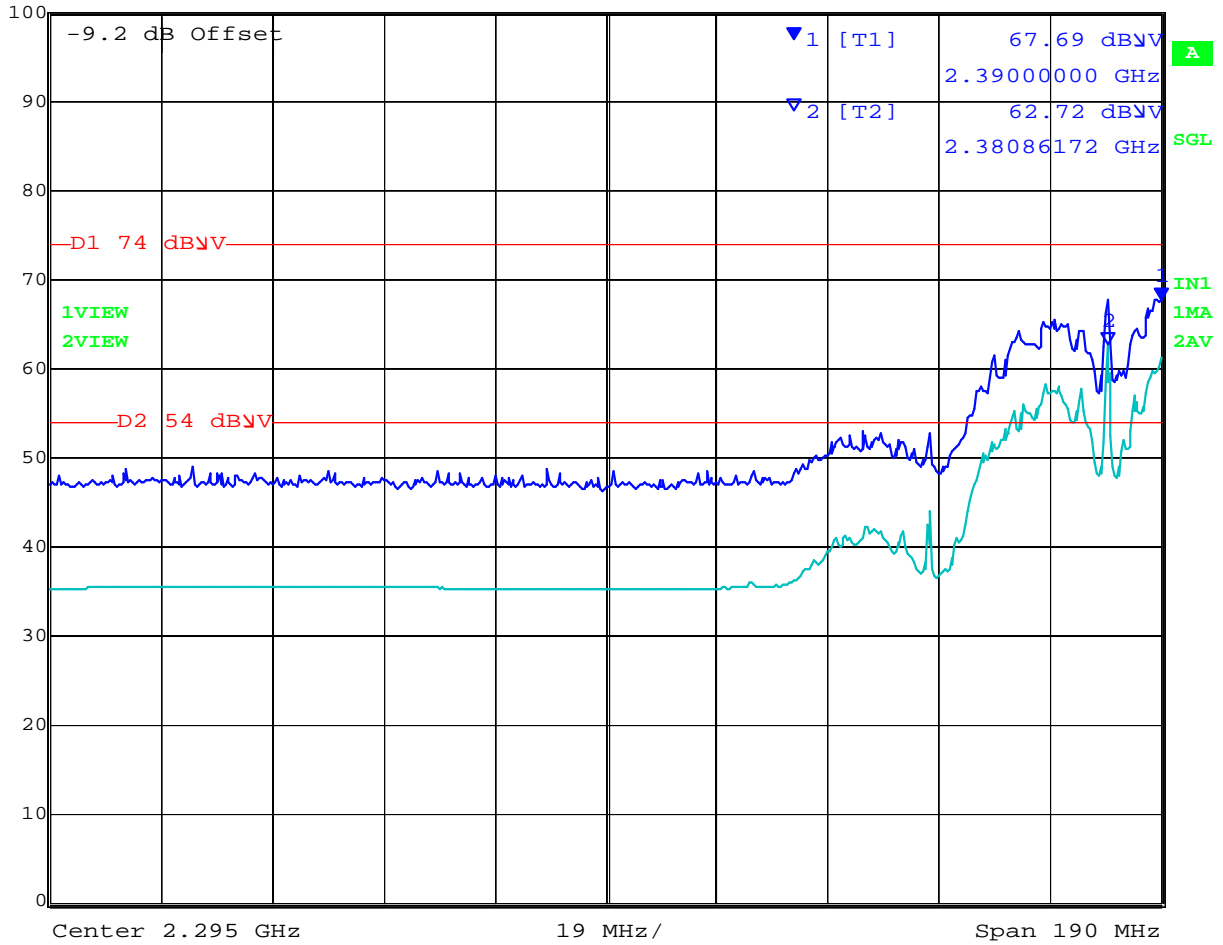

Date: 28.OCT.2010 13:44:25

This test report may be reproduced in full only. The document may only be updated by MiCOM Labs personnel. Any changes will be noted in the Document History section of the report.



BE 2483.5-2500 MHz DSSS 2441.75mhz h=100cm azt=180

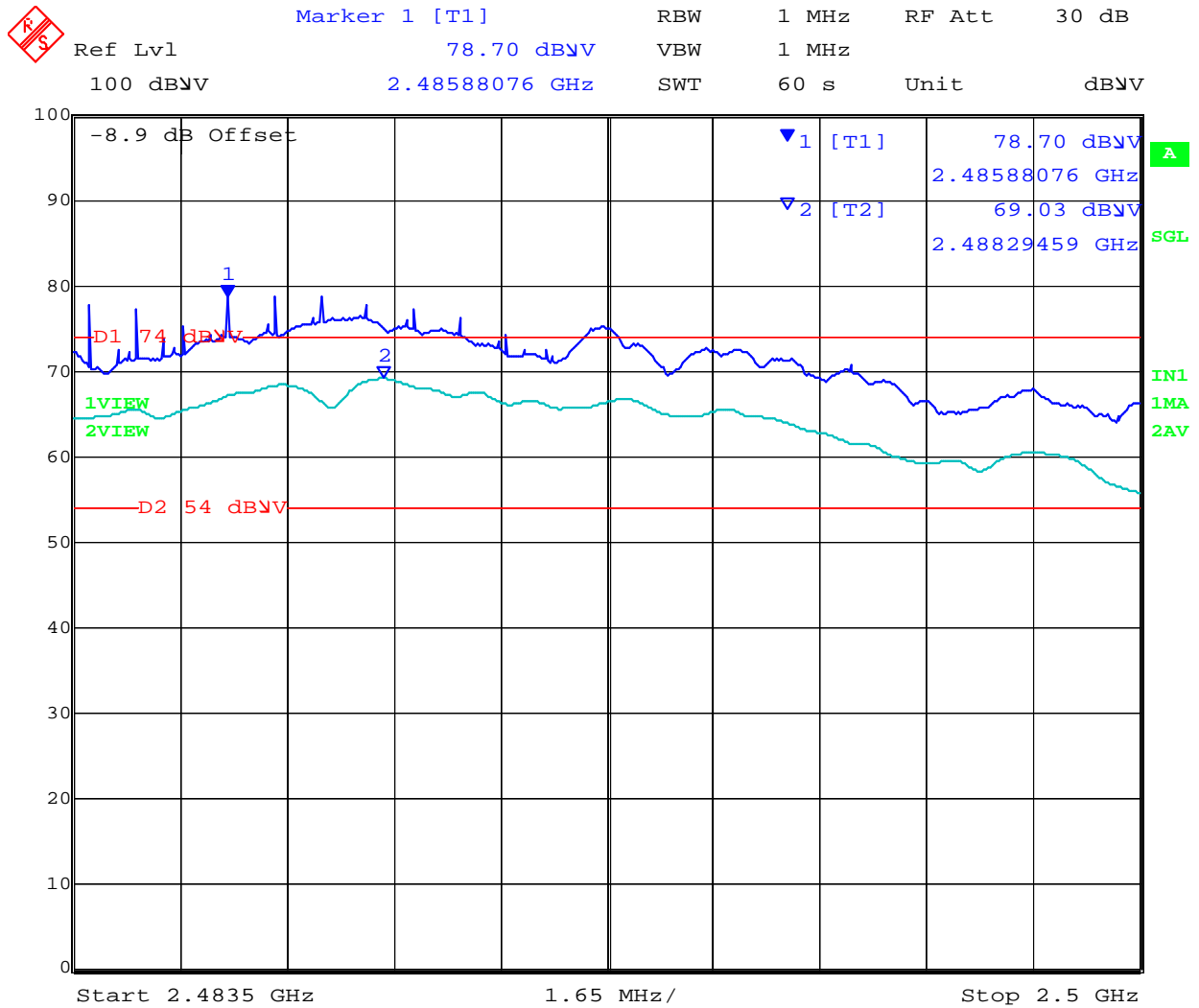

Date: 28.OCT.2010 13:59:23

This test report may be reproduced in full only. The document may only be updated by MiCOM Labs personnel. Any changes will be noted in the Document History section of the report.



#### 7.6.4 Measurement Results AK-210-10 & AK-110-10: Peak Emissions

<b>Test Freq.</b>	2441.75 MHz	<b>Engineer</b>	SB
<b>Variant</b>	DSSS	<b>Temp (°C)</b>	22
<b>Freq. Range</b>	2400 - 2483.5 MHz	<b>Rel. Hum .(%)</b>	34
<b>Power Setting</b>	Max Pow er 18 dBm	<b>Press. (mBars)</b>	1005
<b>Antenna</b>	AK-210-10 "Bull Horn" Omni all w eather	<b>Duty Cycle (%)</b>	100
<b>Test Notes 1</b>			
<b>Test Notes 2</b>			

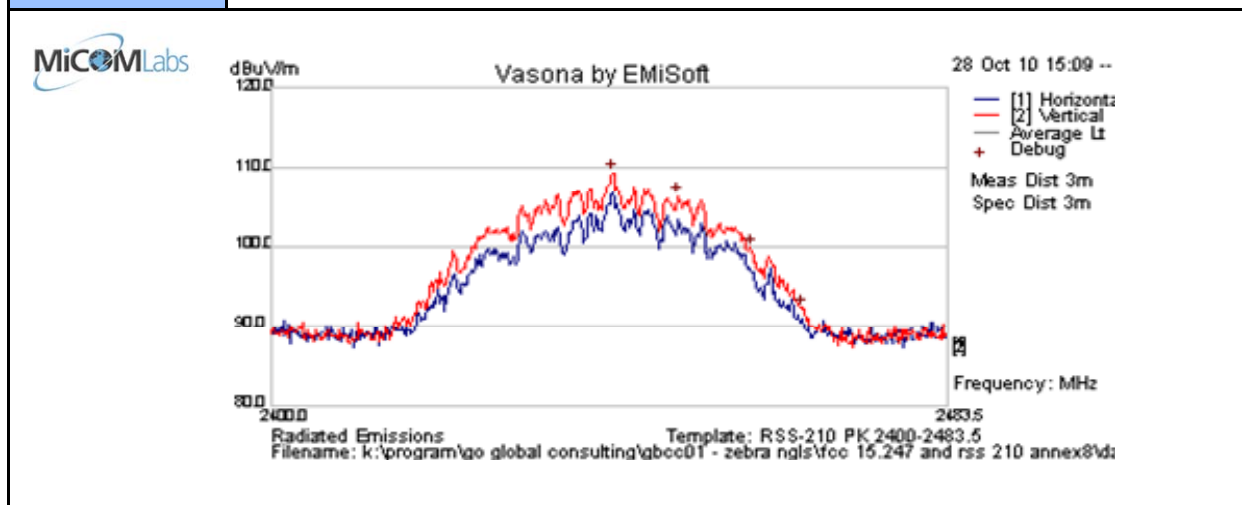

#### Formally measured emission peaks

Frequency MHz	Raw dBuV	Cable Loss	AF dB	Level dBuV/m	Measurement Type	Pol	Hgt cm	Azt Deg	Limit dBuV/m	Margin dB	Pass /Fail	Comments
2441.834	64.2	13.0	32.3	109.4	Peak [Scan]	V						Pk

Legend: TX = Transmitter Emissions; DIG = Digital Emissions; FUND = Fundamental; WB = Wideband Emission  
 PK = Peak emissions of Fundamental

This test report may be reproduced in full only. The document may only be updated by MiCOM Labs personnel. Any changes will be noted in the Document History section of the report.

## 7.7 Receiver Conducted Spurious Emissions

### Industry Canada RSS-Gen §4.10, §6

#### Test Procedure

Conducted emissions were measured with a spectrum analyzer connected to the antenna terminal. Measurements were made while EUT was operating in receive mode.

#### Test Measurement Set up

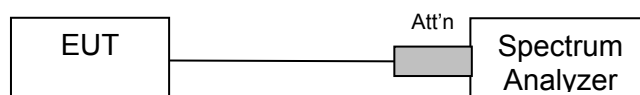

Receiver Conducted spurious emission measurement test configuration

#### Specification

##### Receiver Radiated Spurious Emissions

###### Industry Canada RSS-Gen §4.10,

The search for spurious emissions shall be from the lowest frequency internally generated or used in the receiver (e.g. local oscillator, intermediate or carrier frequency), or 30 MHz, whichever is the higher, to at least 3 times the highest tunable or local oscillator frequency, whichever is the higher, without exceeding 40 GHz.

For emissions below 1 GHz, measurements shall be performed using a CISPR quasi-peak detector and the related measurement bandwidth. As an alternative to CISPR quasi-peak measurement, compliance with the emission limit can be demonstrated using measuring equipment employing a peak detector with the same measurement bandwidth as that for CISPR quasi-peak measurements. Above 1 GHz, measurements shall be performed using an average detector and a resolution bandwidth of 300 kHz to 1 MHz.

###### RSS-Gen §6 (b)

If a conducted measurement is made, no spurious output signals appearing at the antenna terminals shall exceed 2 nanowatts per any 4 kHz spurious frequency in the band 30-1000 MHz, or 5 nanowatts above 1 GHz.





**Title:** Zebra Enterprise Solutions WhereLAN III  
**To:** FCC 47 CFR Part 15.247 & IC RSS-210  
**Serial #:** GBCC01-U1 Rev A  
**Issue Date:** 6th December 2010  
**Page:** Page 49 of 72

---

**Traceability**

Method	Test Equipment Used
Measurements were made per work instruction WI-05 'Measurement of Spurious Emissions'	0287, 0158, 0252, 0223, 0116, 0117, 0287, 0363.

---

This test report may be reproduced in full only. The document may only be updated by MiCOM Labs personnel. Any changes will be noted in the Document History section of the report.



### Receiver Conducted Emissions 30 MHz to 1GHz

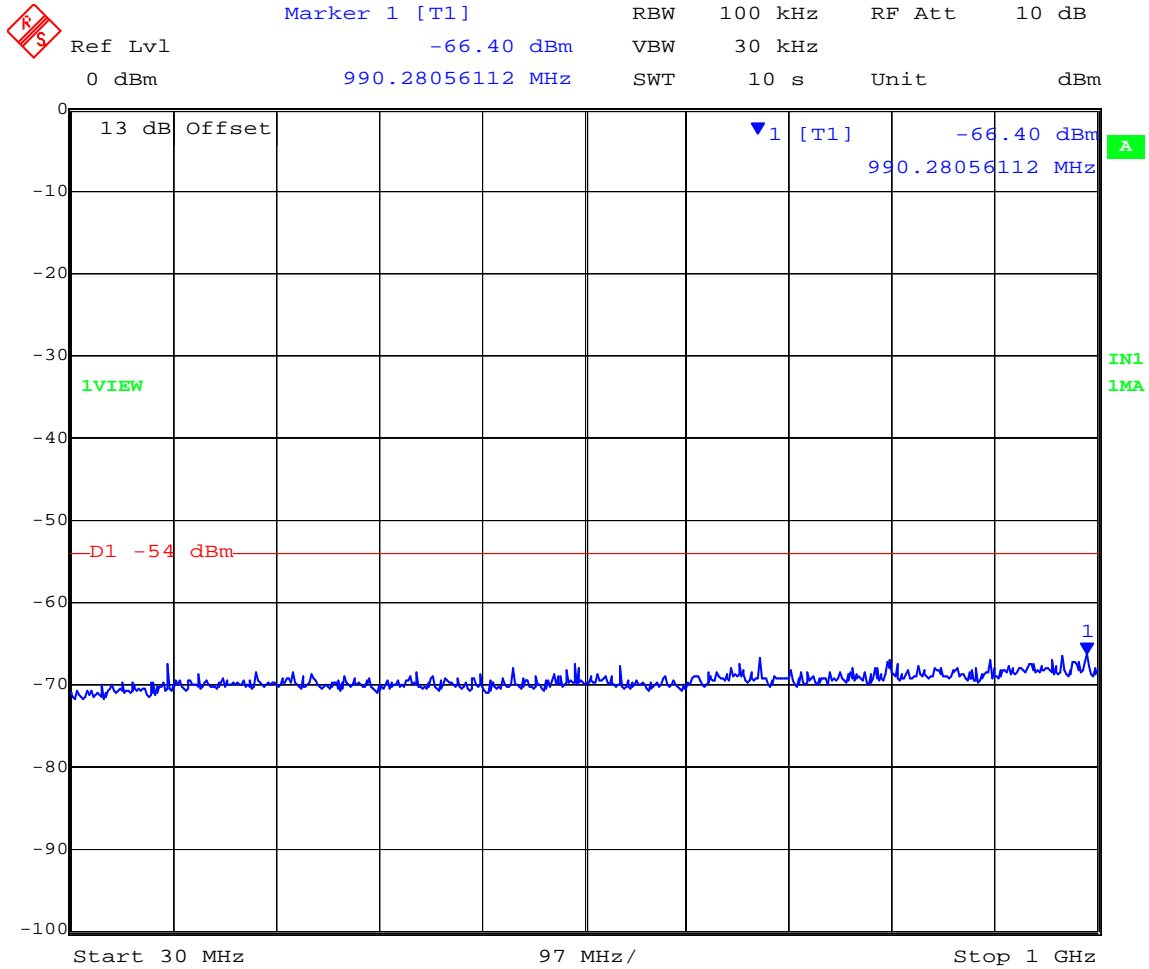

Date: 29.OCT.2010 20:33:25

This test report may be reproduced in full only. The document may only be updated by MiCOM Labs personnel. Any changes will be noted in the Document History section of the report.



### Receiver Conducted Emissions 1 GHz to 12.75 GHz

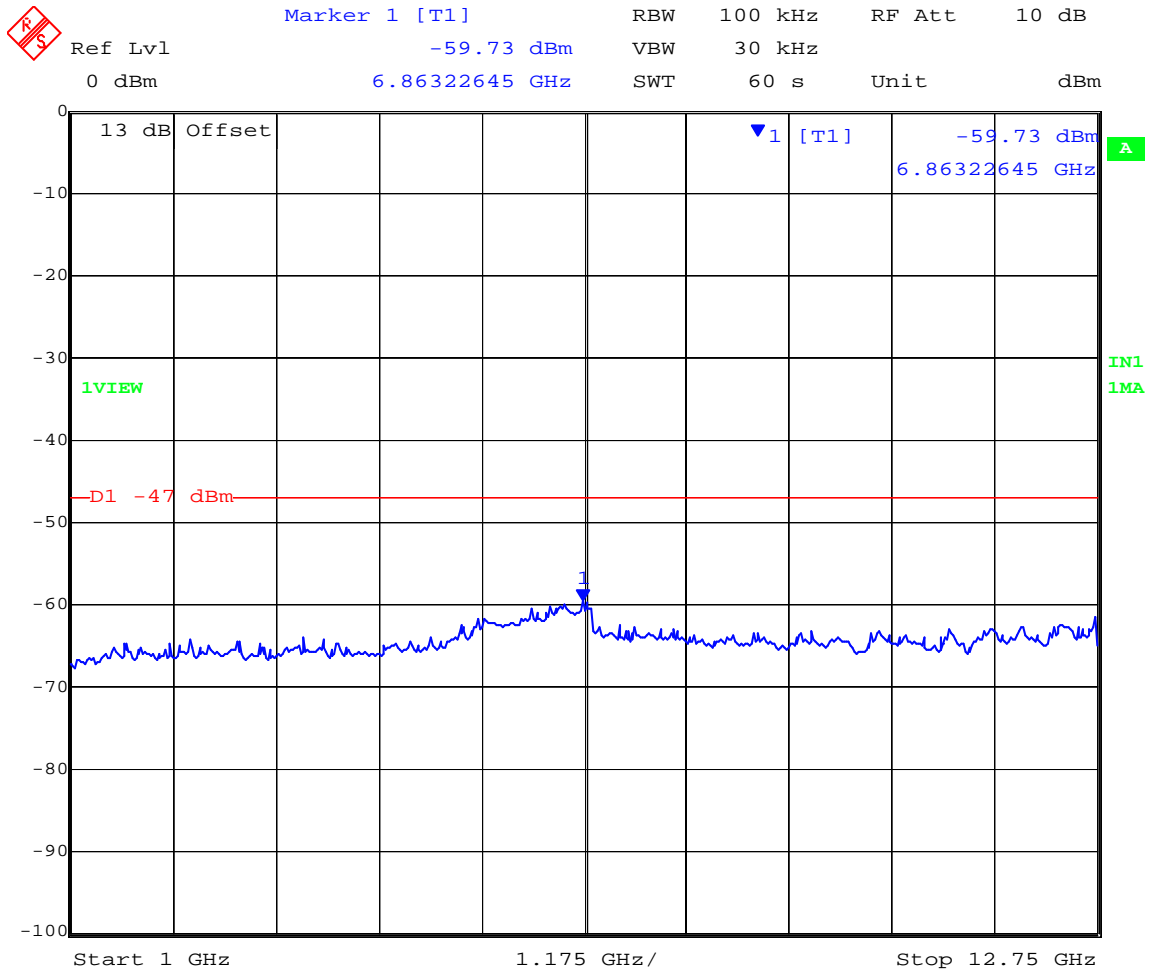

Date: 29.OCT.2010 20:38:58

This test report may be reproduced in full only. The document may only be updated by MiCOM Labs personnel. Any changes will be noted in the Document History section of the report.



**Title:** Zebra Enterprise Solutions WhereLAN III  
**To:** FCC 47 CFR Part 15.247 & IC RSS-210  
**Serial #:** GBCC01-U1 Rev A  
**Issue Date:** 6th December 2010  
**Page:** Page 52 of 72

---

## **7.8 Radiated Spurious Emissions – Digital Apparatus**

### **Standard Reference**

FCC, Part 15 Subpart B §15.109  
Industry Canada ICES-003 §5

### **Test Procedure**

Testing was performed in a 3-meter semi-anechoic chamber. Preliminary radiated emissions were measured on every azimuth and with the receiving antenna in both horizontal and vertical polarizations. Preliminary emissions were recorded with in Spectrum Analyzer mode, using a maximum peak detector while in peak hold mode.

Emissions nearest the limits were chosen for maximization and formal measurement using a CISPR Compliant receiver. Emissions from 30 MHz – 1000 MHz are measured utilizing a CISPR compliant quasi-peak detector with a tuned receiver, using a bandwidth of 120 kHz. Emissions above 1000 MHz are measured utilizing a CISPR compliant average detector with a tuned receiver, using a bandwidth of 1 MHz. Only the highest emissions relative to the limit are listed.

---

This test report may be reproduced in full only. The document may only be updated by MiCOM Labs personnel. Any changes will be noted in the Document History section of the report.

### Test Measurement Set up

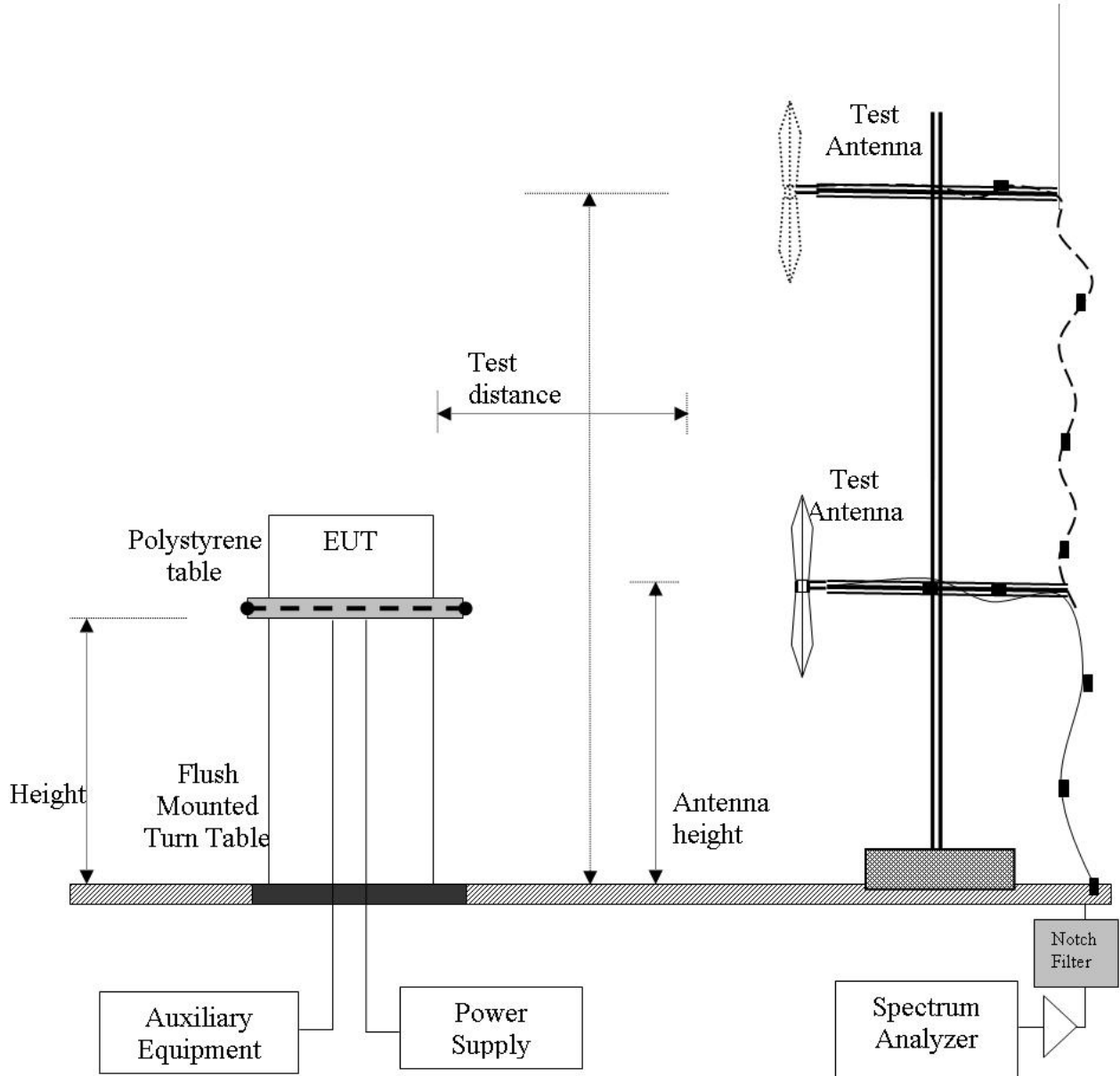

Measurement set up for Radiated Emission Test < 1 GHz

This test report may be reproduced in full only. The document may only be updated by MiCOM Labs personnel. Any changes will be noted in the Document History section of the report.

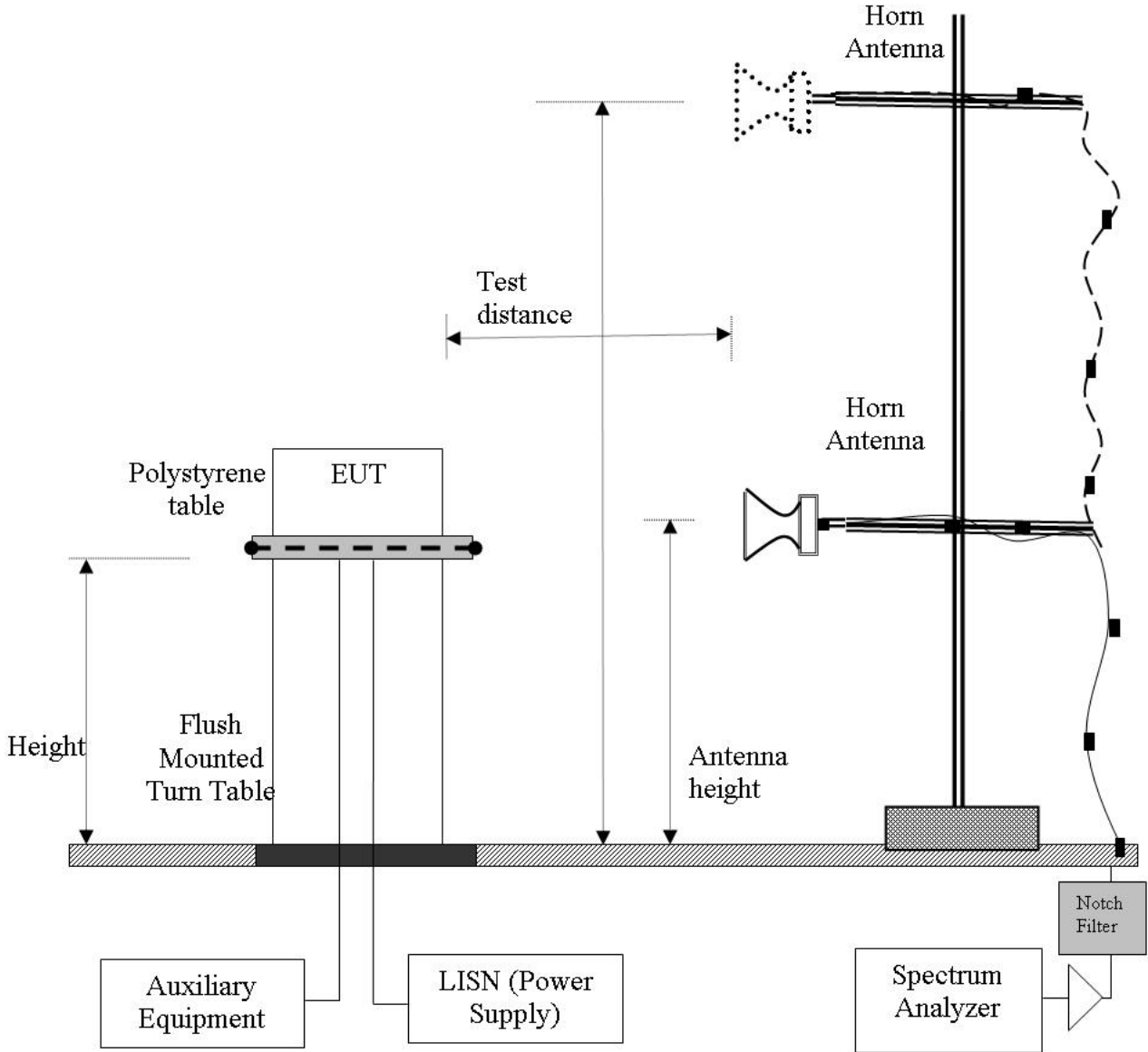

Measurement set up for Radiated Emission Test > 1 GHz



**Title:** Zebra Enterprise Solutions WhereLAN III  
**To:** FCC 47 CFR Part 15.247 & IC RSS-210  
**Serial #:** GBCC01-U1 Rev A  
**Issue Date:** 6th December 2010  
**Page:** Page 55 of 72

### Field Strength Calculation

The field strength is calculated by adding the Antenna Factor and Cable Loss, and subtracting Amplifier Gain from the measured reading. All factors are included in the reported data.

$$FS = R + AF + CORR - FO$$

FS = Field Strength

R = Measured Spectrum analyzer Input Amplitude

AF = Antenna Factor

$$CORR = \text{Correction Factor} = CL - AG + NFL$$

CL = Cable Loss

AG = Amplifier Gain

FO = Distance Falloff Factor

NFL = Notch Filter Loss or Waveguide Loss

#### Field Strength Calculation Example:

Given receiver input reading of 51.5 dB $\mu$ V; Antenna Factor of 8.5 dB; Cable Loss of 1.3 dB; Falloff Factor of 0 dB, an Amplifier Gain of 26 dB and Notch Filter Loss of 1 dB. The Field Strength of the measured emission is:

$$FS = 51.5 + 8.5 + 1.3 - 26.0 + 1 = 36.3 \text{ dB}\mu\text{V/m}$$

Conversion between dB $\mu$ V/m (or dB $\mu$ V) and  $\mu$ V/m (or  $\mu$ V) are done as:

$$\text{Level (dB}\mu\text{V/m)} = 20 * \text{Log (level (\mu\text{V/m}))}$$

$$40 \text{ dB}\mu\text{V/m} = 100 \mu\text{V/m}$$

$$48 \text{ dB}\mu\text{V/m} = 250 \mu\text{V/m}$$

This test report may be reproduced in full only. The document may only be updated by MiCOM Labs personnel. Any changes will be noted in the Document History section of the report.



## Specification

### Radiated Spurious Emissions – Digital Apparatus

#### FCC, Part 15 Subpart B §15.109

A representative type or model of each digital apparatus shall be tested in accordance with the measurement methods described in FCC Part 15; Subpart A - General and FCC Subpart B – Unintentional Radiators.

#### Industry Canada ICES-003

A representative type or model of each digital apparatus shall be tested in accordance with the measurement method described in the publication referred to in Section 7.1 [Canadian Standards Association Standard CAN/CSA-CEI/IEC CISPR 22:02, "Limits and Methods of Measurement of Radio Disturbance Characteristics of Information Technology Equipment."].

### FCC, Part 15 Subpart B §15.109 Spurious Emissions Limits

Except for Class A digital devices, the field strength of radiated emissions from unintentional radiators at a distance of 3 meters shall not exceed the following values.

Frequency (MHz)	Field Strength ( $\mu\text{V/m}$ )	Field Strength ( $\text{dB}\mu\text{V/m}$ )	Measurement Distance (meters)
30-88	100	40.0	3
88-216	150	43.5	3
216-960	200	46.0	3
Above 960	500	54.0	3

Field Strength of radiated emissions for a Class A digital device are as follows.

Frequency (MHz)	Field Strength ( $\mu\text{V/m}$ )	Field Strength ( $\text{dB}\mu\text{V/m}$ )	Measurement Distance (meters)
30-88	100	49.5	3
88-216	150	54.0	3
216-960	200	57.0	3
Above 960	500	60.0	3





**Title:** Zebra Enterprise Solutions WhereLAN III  
**To:** FCC 47 CFR Part 15.247 & IC RSS-210  
**Serial #:** GBCC01-U1 Rev A  
**Issue Date:** 6th December 2010  
**Page:** Page 57 of 72

### ICES-003 §5 Spurious Emissions Limits

**Class A Digital Device:** The field intensity of radio noise emissions that are radiated from a Class A digital apparatus shall not exceed the limits specified in Table 5 of the publication referred to in Section 7.1, within the indicated frequency range.

Frequency range MHz	Quasi-peak limits dB( $\mu$ V/m) @ 10m	Quasi-peak limits dB( $\mu$ V/m) @ 3m
30 to 230	40	50.5
230 to 1 000	47	57.5
Note 1	The lower limit shall apply at the transition frequency.	
Note 2	Additional provisions may be required for cases where interference occurs	

**Class B Digital Device:** The field intensity of radio noise emissions that are radiated from a Class B digital apparatus shall not exceed the limits specified in Table 6 of the publication referred to in Section 7.1, within the indicated frequency range.

Frequency range MHz	Quasi-peak limits dB( $\mu$ V/m) @ 10m	Quasi-peak limits dB( $\mu$ V/m) @ 3m
30 to 230	30	40.5
230 to 1 000	37	47.5
Note 1	The lower limit shall apply at the transition frequency.	
Note 2	Additional provisions may be required for cases where interference occurs	

### Laboratory Measurement Uncertainty for Spectrum Measurement

<b>Measurement Uncertainty</b>	+5.6/ -4.5 dB
--------------------------------	---------------

### Traceability

Method	Test Equipment Used
Work instruction WI-03	0088, 0158, 0134, 0304, 0311, 0315, 0310, 0312

This test report may be reproduced in full only. The document may only be updated by MiCOM Labs personnel. Any changes will be noted in the Document History section of the report.



### 7.8.1 Measurement Results for Radiated Spurious Emissions – Digital Apparatus

Please note: Radio emissions were investigated during digital emissions testing. No radio emissions were witnessed in the range 30 - 1000 MHz during testing.

#### POE Configuration

<b>Test Freq.</b>	2441.75 MHz	<b>Engineer</b>	SB
<b>Variant</b>	Digital Emissions	<b>Temp (°C)</b>	22
<b>Freq. Range</b>	30 MHz - 1000 MHz	<b>Rel. Hum.(%)</b>	34
<b>Power Setting</b>	18 dBm Max	<b>Press. (mBars)</b>	1005
<b>Antenna</b>	AK-210-10 "Bull Horn" Omni all weather		
<b>Test Notes 1</b>	POE Adapter no ferrite(s)		
<b>Test Notes 2</b>	S/N# PW182RB4800F01		

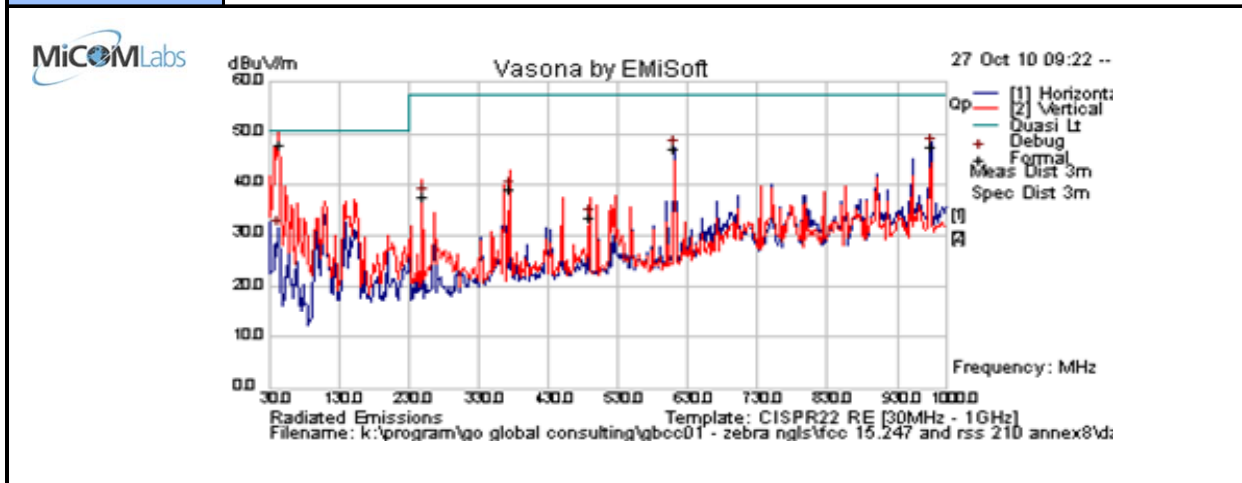

#### Formally measured emission peaks

Frequency MHz	Raw dBuV	Cable Loss	AF dB	Level dBuV/m	Measurement Type	Pol	Hgt cm	Azt Deg	Limit dBuV/m	Margin dB	Pass /Fail	Comments
43.797	63.9	3.6	-19.6	48.0	Quasi Max	V	119	30	50.5	-2.6	Pass	DIG
611.219	51.9	6.4	-11.1	47.2	Peak [Scan]	H	98	343	57.5	-10.3	Pass	DIG
249.924	51.3	5.0	-18.8	37.5	Peak [Scan]	V	98	343	57.5	-20.0	Pass	DIG
374.069	48.5	5.6	-15.2	38.9	Peak [Scan]	V	98	343	57.5	-18.6	Pass	DIG
978.757	46.2	7.6	-6.3	47.5	Peak [Scan]	H	98	343	57.5	-10.0	Pass	DIG
489.181	39.9	6.0	-12.5	33.4	Peak [Scan]	V	98	343	57.5	-24.2	Pass	DIG

Legend: DIG = Digital Device Emission; TX = Transmitter Emission; FUND = Fundamental Frequency  
 NRB = Non-Restricted Band, Limit is 20 dB below Fundamental; RB = Restricted Band

This test report may be reproduced in full only. The document may only be updated by MiCOM Labs personnel. Any changes will be noted in the Document History section of the report.



PSU-STDA16A-S11

<b>Test Freq.</b>	2441.75 MHz	<b>Engineer</b>	SB
<b>Variant</b>	Digital Emissions	<b>Temp (°C)</b>	22
<b>Freq. Range</b>	30 MHz - 1000 MHz	<b>Rel. Hum.(%)</b>	34
<b>Power Setting</b>	18 dBm Max	<b>Press. (mBars)</b>	1005
<b>Antenna</b>	AK-210-10 "Bull Horn" Omni all weather		
<b>Test Notes 1</b>	AC to DC PSU MEPOS Switching PSU STDA16A-S11 (15 W)		
<b>Test Notes 2</b>			

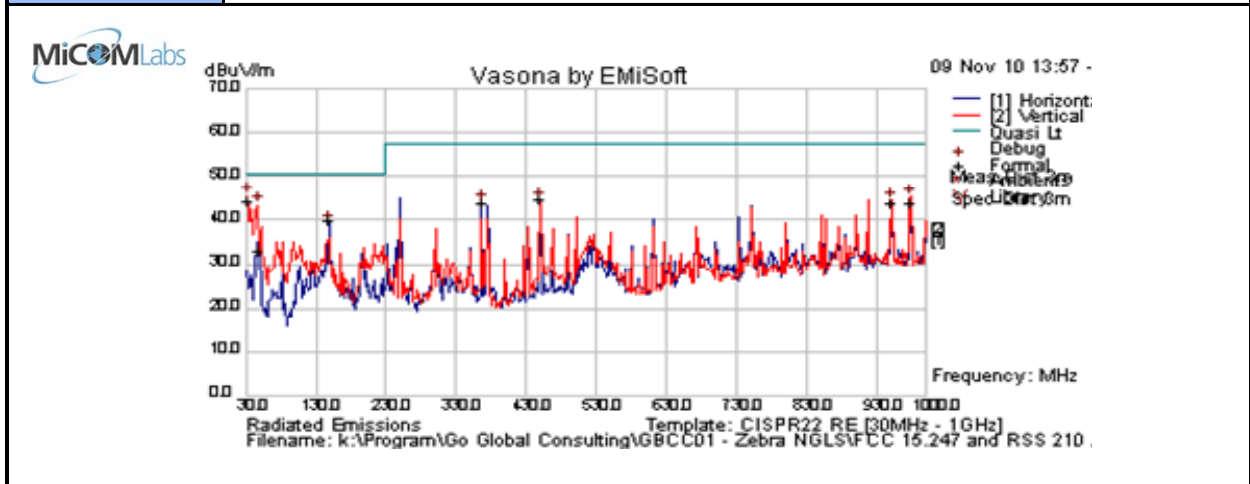

**Formally measured emission peaks**

Frequency MHz	Raw dBuV	Cable Loss	AF dB	Level dBuV/m	Measurement Type	Pol	Hgt cm	Azt Deg	Limit dBuV/m	Margin dB	Pass /Fail	Comments
32.619	52.2	3.4	-11.1	44.5	Quasi Peak	V	98	360	50.5	-6.0	Pass	DIG
450.000	52.7	5.8	-13.8	44.7	Quasi Max	V	112	0	57.5	-12.8	Pass	DIG
950.015	42.9	7.5	-6.6	43.9	Quasi Max	V	99	286	57.5	-13.6	Pass	DIG
366.260	53.4	5.5	-15.2	43.7	Quasi Max	H	98	117	57.5	-13.8	Pass	DIG
150.005	53.8	4.5	-18.3	40.0	Quasi Max	H	173	136	50.5	-10.5	Pass	DIG
976.694	42.6	7.6	-6.4	43.9	Quasi Max	V	98	107	57.5	-13.6	Pass	DIG
48.108	50.9	3.7	-21.7	32.9	Quasi Max	V	145	117	50.5	-17.6	Pass	DIG

Legend: DIG = Digital Device Emission; TX = Transmitter Emission; FUND = Fundamental Frequency  
 NRB = Non-Restricted Band, Limit is 20 dB below Fundamental; RB = Restricted Band

This test report may be reproduced in full only. The document may only be updated by MiCOM Labs personnel. Any changes will be noted in the Document History section of the report.



PSU SIDA25A-S11

<b>Test Freq.</b>	2441.75 MHz	<b>Engineer</b>	SB
<b>Variant</b>	Digital Emissions	<b>Temp (°C)</b>	22
<b>Freq. Range</b>	30 MHz - 1000 MHz	<b>Rel. Hum.(%)</b>	33
<b>Power Setting</b>	18 dBm Max	<b>Press. (mBars)</b>	1000
<b>Antenna</b>	AK-210-10 "Bull Horn" Omni all weather		
<b>Test Notes 1</b>	AC to DC Power Supply SIDA25A-S11 (25 W)		
<b>Test Notes 2</b>			

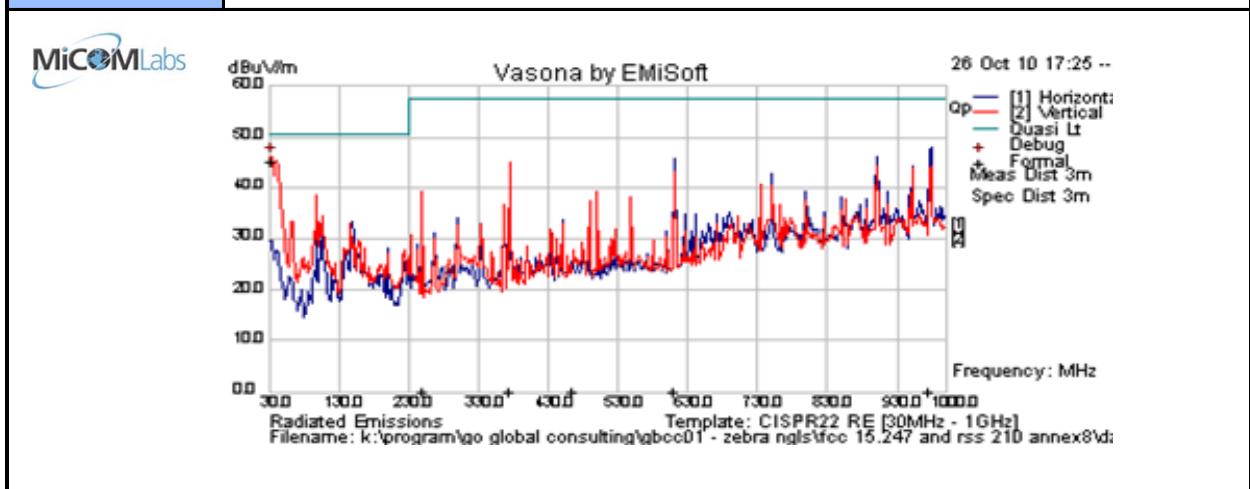

**Formally measured emission peaks**

Frequency MHz	Raw dBuV	Cable Loss	AF dB	Level dBuV/m	Measurement Type	Pol	Hgt cm	Azt Deg	Limit dBuV/m	Margin dB	Pass /Fail	Comments
33.679	53.8	3.5	-12.1	45.2	Quasi Max	V	98	170	50.5	-5.3	Pass	DIG
250.005	52.5	5.0	-18.8	38.7	Peak [Scan]	V	98	--	57.5	-18.8	Pass	DIG
374.989	54.2	5.6	-15.1	44.7	Peak [Scan]	V	98	--	57.5	-12.8	Pass	DIG
610.428	50.0	6.4	-11.2	45.3	Peak [Scan]	H	98	--	57.5	-12.2	Pass	DIG
976.693	46.7	7.6	-6.4	47.9	Peak [Scan]	H	98	--	57.5	-9.6	Pass	DIG
500.391	45.5	5.9	-12.9	38.4	Peak [Scan]	V	98	--	57.5	-19.1	Pass	DIG

Legend: DIG = Digital Device Emission; TX = Transmitter Emission; FUND = Fundamental Frequency  
 NRB = Non-Restricted Band, Limit is 20 dB below Fundamental; RB = Restricted Band

This test report may be reproduced in full only. The document may only be updated by MiCOM Labs personnel. Any changes will be noted in the Document History section of the report.



**Title:** Zebra Enterprise Solutions WhereLAN III  
**To:** FCC 47 CFR Part 15.247 & IC RSS-210  
**Serial #:** GBCC01-U1 Rev A  
**Issue Date:** 6th December 2010  
**Page:** Page 61 of 72

---

Note: Emissions above 1 GHz did not change based on power supply used, Radio transmit frequency, or modulation type.

---

This test report may be reproduced in full only. The document may only be updated by MiCOM Labs personnel. Any changes will be noted in the Document History section of the report.



**Title:** Zebra Enterprise Solutions WhereLAN III  
**To:** FCC 47 CFR Part 15.247 & IC RSS-210  
**Serial #:** GBCC01-U1 Rev A  
**Issue Date:** 6th December 2010  
**Page:** Page 62 of 72

---

## **7.9 Conducted Disturbance at Mains Terminal (150 kHz – 30 MHz)**

### **Standard Reference**

FCC, Part 15 Subpart C §15.107  
Industry Canada ICES-003 §5.3

### **Test Procedure**

The EUT is configured in accordance with ANSI C63.4. The conducted emissions are measured in a shielded room with a spectrum analyzer in peak hold in the first instance. Emissions closest to the limit are measured in the quasi-peak mode (QP) with the tuned receiver using a bandwidth of 9 kHz. The emissions are maximized further by cable manipulation. The highest emissions relative to the limit are listed.

If the average limit is met when using a quasi-peak detector receiver, the EUT shall be deemed to meet both limits and measurement with the average detector receiver is unnecessary.

If the reading of the measuring receiver shows fluctuations close to the limit, the reading shall be observed for at least 15 s at each measurement frequency; the higher reading shall be recorded with the exception of any brief isolated high reading which shall be ignored.

---

This test report may be reproduced in full only. The document may only be updated by MiCOM Labs personnel. Any changes will be noted in the Document History section of the report.

### Test Measurement Set up

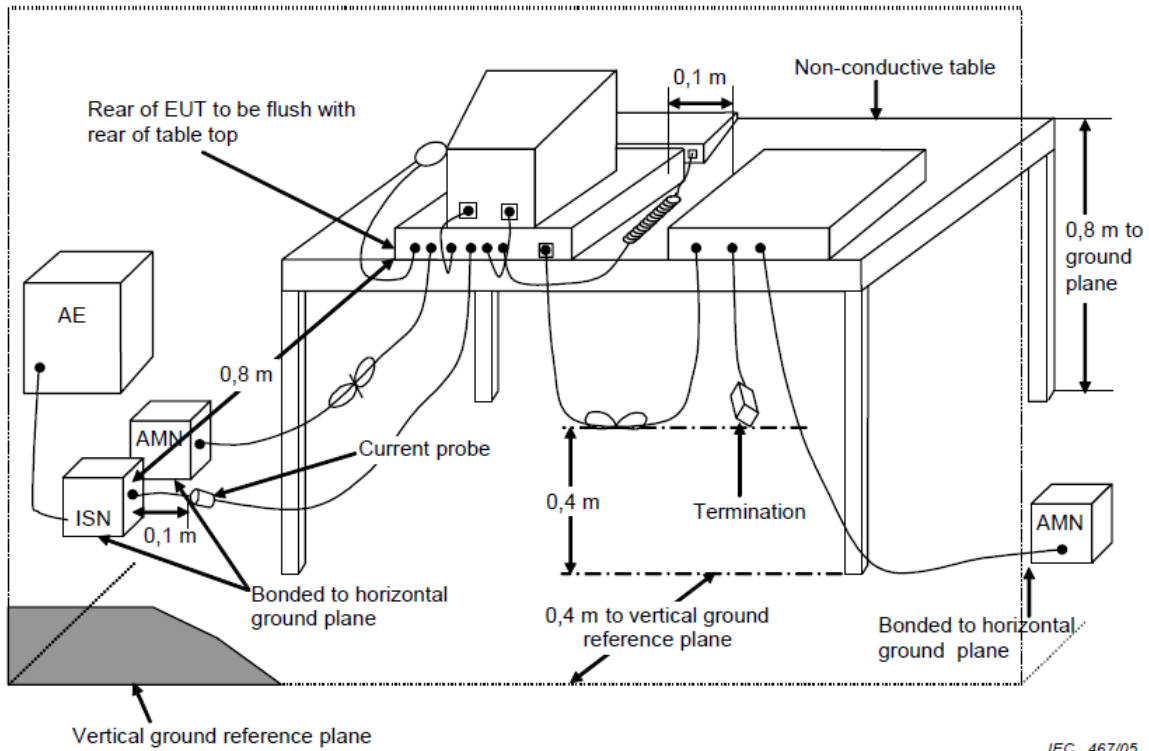

Measurement set up for Conducted Disturbance at Mains Terminals



**Title:** Zebra Enterprise Solutions WhereLAN III  
**To:** FCC 47 CFR Part 15.247 & IC RSS-210  
**Serial #:** GBCC01-U1 Rev A  
**Issue Date:** 6th December 2010  
**Page:** Page 64 of 72

## Specification

### Conducted Disturbance at Mains Terminal – Digital Apparatus

#### FCC, Part 15 Subpart B §15.107

(a) Except for Class A digital devices, for equipment that is designed to be connected to the public utility (AC) power line, the radio frequency voltage that is conducted back onto the AC power line on any frequency or frequencies within the band 150 kHz to 30 MHz shall not exceed the limits in the following table, as measured using a 50  $\mu$ H/50 ohms line impedance stabilization network (LISN). Compliance with the provisions of this paragraph shall be based on the measurement of the radio frequency voltage between each power line and ground at the power terminal. The lower limit applies at the band edges.

(b) For a Class A digital device that is designed to be connected to the public utility (AC) power line, the radio frequency voltage that is conducted back onto the AC power line on any frequency or frequencies within the band 150 kHz to 30 MHz shall not exceed the limits in the following table, as measured using a 50  $\mu$ H/50 ohms LISN. Compliance with the provisions of this paragraph shall be based on the measurement of the radio frequency voltage between each power line and ground at the power terminal. The lower limit applies at the boundary between the frequency ranges.

#### Industry Canada ICES-003

The voltage of radio noise emissions that are conducted along the power supply lines of a Class A digital apparatus shall not exceed the limits specified in Table 1 of the publication referred to in Section 7.1 [Canadian Standards Association Standard CAN/CSA-CEI/IEC CISPR 22:02, "Limits and Methods of Measurement of Radio Disturbance Characteristics of Information Technology Equipment."], within the indicated frequency range.

The voltage of radio noise emissions that are conducted along the power supply lines of a Class B digital apparatus shall not exceed the limits specified in Table 2 of the publication referred to in Section 7.1 [Canadian Standards Association Standard CAN/CSA-CEI/IEC CISPR 22:02, "Limits and Methods of Measurement of Radio Disturbance Characteristics of Information Technology Equipment."], within the indicated frequency range.

This test report may be reproduced in full only. The document may only be updated by MiCOM Labs personnel. Any changes will be noted in the Document History section of the report.





**Title:** Zebra Enterprise Solutions WhereLAN III  
**To:** FCC 47 CFR Part 15.247 & IC RSS-210  
**Serial #:** GBCC01-U1 Rev A  
**Issue Date:** 6th December 2010  
**Page:** Page 65 of 72

### FCC, Part 15 Subpart B §15.107 & Industry Canada ICES-003 Limits

Limits for conducted disturbance at the mains ports of class B ITE

Frequency of emission (MHz)	Quasi-peak dBuV	Average dBuV
0.15–0.5	66 to 56*	56 to 46*
0.5–5	56	46
5–30	60	50
Note 1	* Decreases with the logarithm of the frequency	
Note 2	* The lower limit applies at the boundary between frequency ranges	

Limits for conducted disturbance at the mains ports of class A ITE

Frequency of emission (MHz)	Quasi-peak dBuV	Average dBuV
0.15–0.5	79	66
0.5–30	73	60
Note 1	* The lower limit shall apply at the transition frequency.	

Laboratory Measurement Uncertainty for Conducted Emissions

<b>Measurement uncertainty</b>	±2.64 dB
--------------------------------	----------

Traceability

Method	Test Equipment Used
Work instruction WI-EMC-01	0158, 0184, 0193, 0190, 0293, 0307

This test report may be reproduced in full only. The document may only be updated by MiCOM Labs personnel. Any changes will be noted in the Document History section of the report.



### 7.9.1 Conducted Disturbance at Mains Terminal (150 kHz – 30 MHz)

Test Freq.	N/A	Engineer	SB
Variant	AC Mains	Temp (°C)	22
Freq. Range	0.150 MHz - 30 MHz	Rel. Hum.(%)	34
Power Setting	Max Output	Press. (mBars)	1005
Antenna	AK-210-10 "Bull Horn" Omni all weather		
Test Notes 1	MEPOS 25 W AC to DC Adapter		
Test Notes 2	AC to DC Power Supply SIDA25A-S11 (25 mW)		

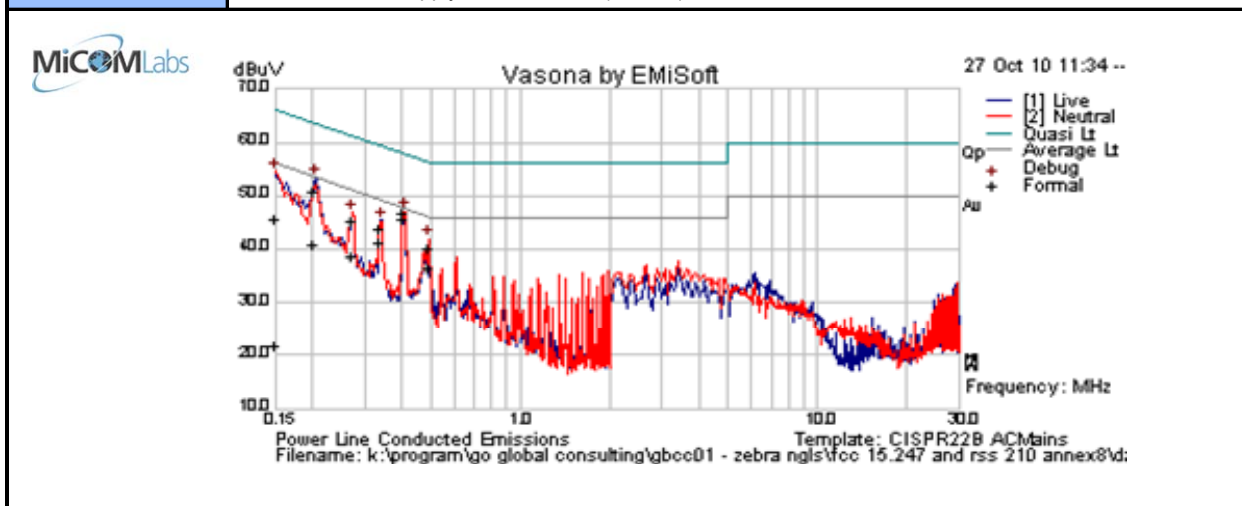

#### Formally measured emission peaks

Frequency MHz	Raw dBuV	Cable Loss	Factors dB	Level dBuV	Measurement Type	Line	Limit dBuV	Margin dB	Pass /Fail	Comments
0.338	33.7	9.9	0.1	43.7	Quasi Peak	Live	59.25	-15.6	Pass	
0.203	40.9	9.9	0.1	50.9	Quasi Peak	Live	63.47	-12.6	Pass	
0.492	30.0	9.9	0.1	40.0	Quasi Peak	Neutral	56.14	-16.1	Pass	
0.406	36.8	9.9	0.1	46.7	Quasi Peak	Neutral	57.74	-11.0	Pass	
0.150	35.9	9.9	0.1	45.8	Quasi Peak	Neutral	65.99	-20.2	Pass	
0.271	35.2	9.9	0.1	45.1	Quasi Peak	Neutral	61.08	-16.0	Pass	
0.338	31.3	9.9	0.1	41.3	Average	Live	49.25	-8.0	Pass	
0.203	30.8	9.9	0.1	40.8	Average	Live	53.47	-12.7	Pass	
0.492	26.4	9.9	0.1	36.4	Average	Neutral	46.14	-9.7	Pass	
0.406	35.8	9.9	0.1	45.8	Average	Neutral	47.74	-2.0	Pass	
0.150	11.7	9.9	0.1	21.7	Average	Neutral	55.99	-34.3	Pass	
0.271	28.5	9.9	0.1	38.5	Average	Neutral	51.08	-12.6	Pass	

Legend: DIG = Digital Device Emission; TX = Transmitter Emission; FUND = Fundamental Frequency  
 NRB = Non-Restricted Band, Limit is 20 dB below Fundamental; RB = Restricted Band

This test report may be reproduced in full only. The document may only be updated by MiCOM Labs personnel. Any changes will be noted in the Document History section of the report.



**Title:** Zebra Enterprise Solutions WhereLAN III  
**To:** FCC 47 CFR Part 15.247 & IC RSS-210  
**Serial #:** GBCC01-U1 Rev A  
**Issue Date:** 6th December 2010  
**Page:** Page 67 of 72

Test Freq.	N/A	SB
Variant	AC Main	22
Freq. Range	0.150 MHz - 30 MHz	34
Power Setting	Max Output	1005
Antenna	AK-210-10 "Bull Horn" Omni all weather	
Test Notes 1	MEPOS 15 W AC to DC Adapter	
Test Notes 2	DC Cable Ferrite 0431167281 1 loop 2 turns 7 inches tip of power adapter plug input	

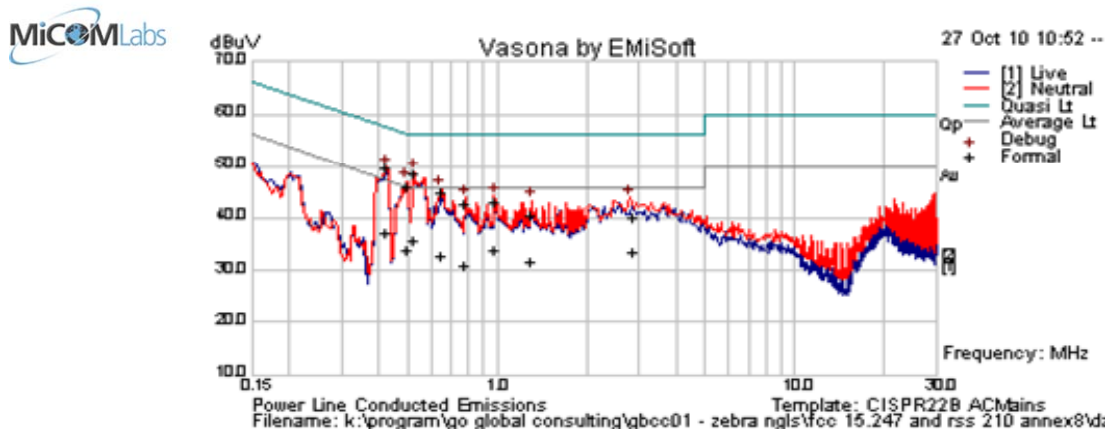

**Formally measured emission peaks**

Frequency MHz	Raw dBuV	Cable Loss	Factors dB	Level dBuV	Measurement Type	Line	Limit dBuV	Margin dB	Pass /Fail	Comments
0.522	38.6	9.9	0.1	48.6	Quasi Peak	Neutral	56.0	-7.4	Pass	
0.427	39.9	9.9	0.1	49.8	Quasi Peak	Neutral	57.3	-7.5	Pass	
0.497	36.0	9.9	0.1	46.0	Quasi Peak	Neutral	56.1	-10.1	Pass	
0.653	34.9	10.0	0.1	45.0	Quasi Peak	Neutral	56.0	-11.1	Pass	
0.979	33.2	9.9	0.1	43.2	Quasi Peak	Neutral	56.0	-12.8	Pass	
0.784	32.6	10.0	0.1	42.6	Quasi Peak	Neutral	56.0	-13.4	Pass	
2.867	29.8	10.1	0.1	40.1	Quasi Peak	Neutral	56.0	-16.0	Pass	
1.308	30.4	10.0	0.1	40.4	Quasi Peak	Neutral	56.0	-15.6	Pass	
0.522	25.8	9.9	0.1	35.8	Average	Neutral	46.0	-10.2	Pass	
0.427	27.2	9.9	0.1	37.2	Average	Neutral	47.3	-10.1	Pass	
0.497	23.8	9.9	0.1	33.8	Average	Neutral	46.1	-12.3	Pass	
0.653	22.9	10.0	0.1	32.9	Average	Neutral	46.0	-13.1	Pass	
0.979	23.7	9.9	0.1	33.8	Average	Neutral	46.0	-12.3	Pass	
0.784	20.8	10.0	0.1	30.9	Average	Neutral	46.0	-15.1	Pass	
2.867	23.2	10.1	0.1	33.4	Average	Neutral	46.0	-12.6	Pass	
1.308	21.8	10.0	0.1	31.8	Average	Neutral	46.0	-14.2	Pass	

Legend: DIG = Digital Device Emission; TX = Transmitter Emission; FUND = Fundamental Frequency  
 NRB = Non-Restricted Band, Limit is 20 dB below Fundamental; RB = Restricted Band

This test report may be reproduced in full only. The document may only be updated by MiCOM Labs personnel. Any changes will be noted in the Document History section of the report.

## 8 PHOTOGRAPHS

### 8.1 Conducted RF Measurement Set Up



This test report may be reproduced in full only. The document may only be updated by MiCOM Labs personnel. Any changes will be noted in the Document History section of the report.



## 8.2 Radiated Spurious Emissions Below 1 GHz



This test report may be reproduced in full only. The document may only be updated by MiCOM Labs personnel. Any changes will be noted in the Document History section of the report.

### 8.3 Radiated Spurious Emissions Above 1 GHz

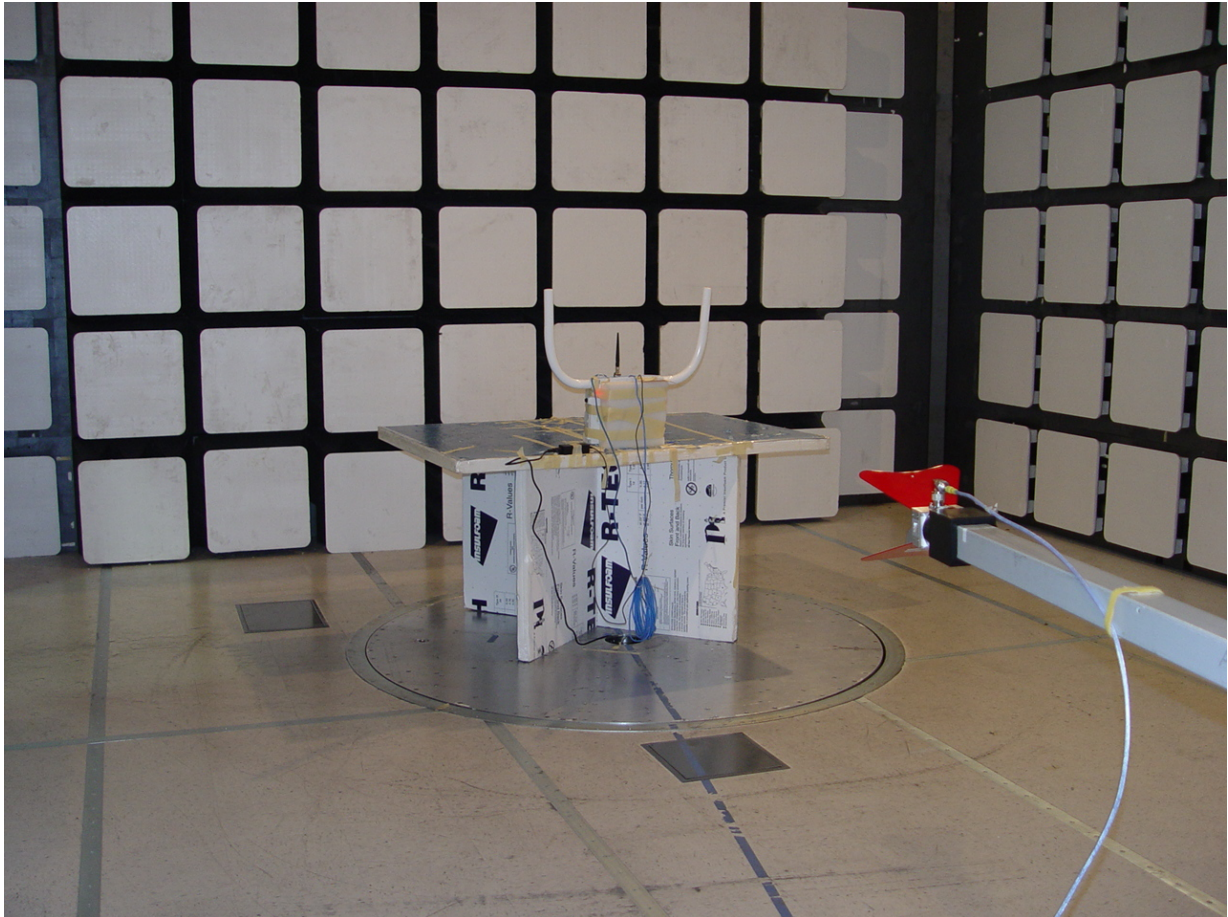

This test report may be reproduced in full only. The document may only be updated by MiCOM Labs personnel. Any changes will be noted in the Document History section of the report.



## 9 TEST EQUIPMENT DETAILS

Asset #	Instrument	Manufacturer	Model #	Serial #
0072	Signal Generator	Hewlett Packard	HP 83640A	2927A00105
0075	Environmental Chamber	Thermatron	SE-300-2-2	27946
0338	Antenna (30M-3GHz)	Sunol Sciences	JB3	A052907
0083	Coupler	Hewlett Packard	HP 87301D	3116A00389
0287	EMI Receiver	Rhode & Schwartz	ESIB 40	100201
0335	Horn Antenna	The Electro-Mechanics Company	3117	00066580
0116	Power Sensor	Hewlett Packard	8485A	3318A19694
0117	Power Sensor	Hewlett Packard	8487D	3318A00371
0134	Amplifier	ComPower	PA-122	181910
0158	Barometer /Thermometer	Control Co.	4196	E2844
0193	EMI Receiver	Rhode & Schwartz	ESI 7	838496/007
0223	Power Meter	Hewlett Packard	HP EPM-442A	US37480256
0252	K-Cable	Megaphase	Sucoflex 104	Unknown
0253	K-Cable	Megaphase	Sucoflex 104	Unknown
0256	K-Cable	Megaphase	Sucoflex 104	Unknown
0251	K-Cable	Megaphase	Sucoflex 104	Unknown
0305	20M-2GHz Amplifier	ML	ML001	001
0310	2m SMA Cable	Micro-Coax	UFA210A-0-0787-3G03G0	209089-001
0312	3m SMA Cable	Micro-Coax	UFA210A-1-1181-3G0300	209092-001
0313	Coupler	Hewlett Packard	86205A	3140A01285
0314	30 dB N-Type Attenuator	ARRA	N944-30	1623
Dipole	20MHz-1GHz Dipole Antennas	EMCO	3121C	9009-505

This test report may be reproduced in full only. The document may only be updated by MiCOM Labs personnel. Any changes will be noted in the Document History section of the report.



440 Boulder Court, Suite 200  
Pleasanton, CA 94566, USA  
Tel: 1.925.462.0304  
Fax: 1.925.462.0306  
[www.micomlabs.com](http://www.micomlabs.com)