



# FCC Radio Test Report

## FCC ID: XW3DK9023RL

This report concerns (check one) :  Original Grant  Class II Change

**Issued Date** : Nov. 23, 2009  
**Project No.** : 0911C061  
**Equipment** : 2.4G WIRELESS KEYBOARD  
**Model Name** : DK-9023RL  
**Applicant** : Dongguan Siliten Electronics CO.,LTD  
**Address** : Sijia Yewu Industrial estate, Shijie Town, Dongguan City, Guangdong Province,China  
**Manufacturer** : Dongguan Siliten Electronics CO.,LTD  
**Address** : Sijia Yewu Industrial estate, Shijie Town, Dongguan City, Guangdong Province,China

**Tested by:**  
 Neutron Engineering Inc. EMC Laboratory  
**Date of Test:**  
 Nov. 15, 2009 ~ Nov. 18, 2009

Testing Engineer : Jeff Yang  
 (Jeff Yang)  
 Technical Manager : Vic Chiu  
 (Vic Chiu)  
 Authorized Signatory : Steven Lu  
 (Steven Lu)

### NEUTRON ENGINEERING INC.

No. 132-1, Lane 329, Sec. 2, Palain Rd.,  
 Shijr City, Taipei, Taiwan  
 TEL : (02) 2646-5426 FAX : (02) 2646-6815





### **Declaration**

**Neutron** represents to the client that testing is done in accordance with standard procedures as applicable and that test instruments used has been calibrated with the standards traceable to National Measurement Laboratory (**NML**) of **R.O.C.**, or National Institute of Standards and Technology (**NIST**) of **U.S.A.**

**Neutron's** reports apply only to the specific samples tested under conditions. It is manufacture's responsibility to ensure that additional production units of this model are manufactured with the identical electrical and mechanical components. **Neutron** shall have no liability for any declarations, inferences or generalizations drawn by the client or others from **Neutron** issued reports.

**Neutron's** reports must not be used by the client to claim product endorsement by the authorities or any agency of the Government.

This report is the confidential property of the client. As a mutual protection to the clients, the public and **Neutron-self**, extracts from the test report shall not be reproduced except in full with **Neutron's** authorized written approval.

**Neutron's** laboratory quality assurance procedures are in compliance with the **ISO Guide 17025** requirements, and accredited by the conformity assessment authorities listed in this test report.

### **Limitation**

For the use of the authority's logo is limited unless the Test Standard(s)/Scope(s)/Item(s) mentioned in this test report is (are) included in the conformity assessment authorities acceptance respective.



<b>Table of Contents</b>	<b>Page</b>
<b>1 . CERTIFICATION</b>	<b>6</b>
<b>2 . SUMMARY OF TEST RESULTS</b>	<b>7</b>
2.1 TEST FACILITY	8
2.2 MEASUREMENT UNCERTAINTY	8
<b>3 . GENERAL INFORMATION</b>	<b>9</b>
3.1 GENERAL DESCRIPTION OF EUT	9
3.2 DESCRIPTION OF TEST MODES	11
3.3 TABLE OF PARAMETERS OF TEXT SOFTWARE SETTING	11
3.4 BLOCK DIGRAM SHOWING THE CONFIGURATION OF SYSTEM TESTED	12
3.5 DESCRIPTION OF SUPPORT UNITS(CONDUCTED MODE)	13
<b>4 . EMC EMISSION TEST</b>	<b>14</b>
4.1 CONDUCTED EMISSION MEASUREMENT	14
4.1.1 POWER LINE CONDUCTED EMISSION LIMITS	14
4.1.2 MEASUREMENT INSTRUMENTS LIST AND SETTING	14
4.1.3 TEST PROCEDURE	15
4.1.4 DEVIATION FROM TEST STANDARD	15
4.1.5 TEST SETUP	15
4.1.6 EUT OPERATING CONDITIONS	16
4.1.7 TEST RESULTS	17
4.2 RADIATED EMISSION MEASUREMENT	18
4.2.1 RADIATED EMISSION LIMITS	18
4.2.2 MEASUREMENT INSTRUMENTS LIST ANS SETTING	19
4.2.3 TEST PROCEDURE	21
4.2.4 DEVIATION FROM TEST STANDARD	21
4.2.5 TEST SETUP	22
4.2.6 EUT OPERATING CONDITIONS	22
4.2.7 TEST RESULTS (BETWEEN30 – 1000 MHZ)	23
4.2.8 TEST RESULTS (ABOVE 1000 MHZ)	25
4.2.9 TEST RESULTS (RESTRICTED BANDS REQUIREMENTS)	37
<b>5 . NUMBER OF HOPPING CHANNEL</b>	<b>41</b>
5.1 APPLIED PROCEDURES / LIMIT	41
5.1.1 MEASUREMENT INSTRUMENTS LIST AND SETTING	41
5.1.2 TEST PROCEDURE	41
5.1.3 DEVIATION FROM STANDARD	41
5.1.4 TEST SETUP	41
5.1.5 EUT OPERATION CONDITIONS	41



<b>Table of Contents</b>	<b>Page</b>
5.1.6 TEST RESULTS	42
<b>6 . AVERAGE TIME OF OCCUPANCY</b>	<b>43</b>
6.1 APPLIED PROCEDURES / LIMIT	43
6.1.1 MEASUREMENT INSTRUMENTS LIST	43
6.1.2. TEST PROCEDURES	43
6.1.3. TEST SETUP LAYOUT	43
6.1.4. TEST DEVIATION	43
6.1.5. EUT OPERATION DURING TEST	43
6.1.6. RESULTS OF OCCUPIED BANDWIDTH AND SPREAD-SPECTRUM BANDWIDTH	44
<b>7 . HOPPING CHANNEL SEPARATION MEASUREMENT</b>	<b>46</b>
7.1 APPLIED PROCEDURES / LIMIT	46
7.1.1 MEASUREMENT INSTRUMENTS LIST AND SETTING	46
7.1.2 TEST PROCEDURE	46
7.1.3 DEVIATION FROM STANDARD	46
7.1.4 TEST SETUP	46
7.1.5 EUT OPERATION CONDITIONS	46
7.1.6 TEST RESULTS	47
<b>8 . BANDWIDTH TEST</b>	<b>49</b>
8.1 APPLIED PROCEDURES / LIMIT	49
8.1.1 MEASUREMENT INSTRUMENTS LIST AND SETTING	49
8.1.2 TEST PROCEDURE	49
8.1.3 DEVIATION FROM STANDARD	49
8.1.4 TEST SETUP	49
8.1.5 EUT OPERATION CONDITIONS	49
8.1.6 TEST RESULTS	50
<b>9 . PEAK OUTPUT POWER TEST</b>	<b>52</b>
9.1 APPLIED PROCEDURES / LIMIT	52
9.1.1 MEASUREMENT INSTRUMENTS LIST AND SETTING	52
9.1.2 TEST PROCEDURE	52
9.1.3 DEVIATION FROM STANDARD	52
9.1.4 TEST SETUP	52
9.1.5 EUT OPERATION CONDITIONS	52
9.1.6 TEST RESULTS	53
<b>10 . ANTENNA CONDUCTED SPURIOUS EMISSION</b>	<b>55</b>
10.1 APPLIED PROCEDURES / LIMIT	55
10.1.1 MEASUREMENT INSTRUMENTS LIST AND SETTING	55
10.1.2 TEST PROCEDURE	55
10.1.3 DEVIATION FROM STANDARD	55



<b>Table of Contents</b>	<b>Page</b>
10.1.4 TEST SETUP	56
10.1.5 EUT OPERATION CONDITIONS	56
10.1.6 TEST RESULTS	57
<b>11 . RF EXPOSURE TEST</b>	<b>59</b>
11.1 APPLIED PROCEDURES / LIMIT	59
11.1.1 MEASUREMENT INSTRUMENTS LIST	59
11.1.2 MPE CALCULATION METHOD	60
11.1.3 DEVIATION FROM STANDARD	61
11.1.4 TEST SETUP	61
11.1.5 EUT OPERATION CONDITIONS	61
11.1.6 TEST RESULTS	62
<b>12 . EUT TEST PHOTO</b>	<b>63</b>



## 1. CERTIFICATION

Equipment: 2.4G WIRELESS KEYBOARD  
Brand Name: N/A  
Model Name: DK-9023RL  
Applicant: Dongguan Siliten Electronics CO.,LTD  
Factory: Dongguan Siliten Electronics CO.,LTD  
Address: Sijia Yewu Industrial estate, Shijie Town, Dongguan City, Guangdong  
Province,China  
Test Item: ENGINEERING SAMPLE  
Date of Test: Nov. 15, 2009 ~ Nov. 18, 2009  
Standards: FCC Part15, Subpart C(15.247) / ANSI C63.4 : 2003

The above equipment has been tested and found compliance with the requirement of the relative standards by Neutron Engineering Inc. EMC Laboratory.

The test data, data evaluation, and equipment configuration contained in our test report (Ref No. NEI-FCCP-1-0911C061) were obtained utilizing the test procedures, test instruments, test sites that has been accredited by the Authority of NVLAP and TAF according to the ISO-17025 quality assessment standard and technical standard(s).



**2. SUMMARY OF TEST RESULTS**

Test procedures according to the technical standards:

<b>FCC Part15 (15.247) , Subpart C</b>			
Standard Section	Test Item	Judgment	Remark
15.207	Conducted Emission	N/A	Note(1)
15.209	Radiated Spurious Emission	PASS	
15.247 (c)	Antenna conducted Spurious Emission	PASS	
15.247 (a)(1)	Hopping Channel Separation	PASS	
15.247 (b)(1)	Peak Output Power	PASS	
15.247 (c)	Radiated Spurious Emission	PASS	
15.247 (b)(1)	Number of Hopping Frequency	PASS	
15.247 (a)(1)	Dwell Time	PASS	
15.205	Restricted Bands	PASS	
15.203	Antenna Requirement	PASS	
1.1307 1.1310 2.1091 2.1093	RF Exposure Compliance	PASS	

**NOTE:**

- (1) "N/A" denotes test is not applicable in this Test Report
- (2) The EUT used new battery.



**2.1 TEST FACILITY**

The test facilities used to collect the test data in this report is **C01/OS02** at the location of No.132-1, Lane 329, Sec. 2, Palain Road, Shijr City, Taipei, Taiwan.

Neutron's test firm number is 95335

**2.2 MEASUREMENT UNCERTAINTY**

The reported uncertainty of measurement  $y \pm U$ , where expended uncertainty **U** is based on a standard uncertainty multiplied by a coverage factor of **k=2**, providing a level of confidence of approximately **95 %**.

A. Conducted Measurement :

Test Site	Method	Measurement Frequency Range	U , (dB)	NOTE
C01	ANSI	150 KHz ~ 30MHz	1.94	

B. Radiated Measurement :

Test Site	Method	Measurement Frequency Range	Ant. H / V	U , (dB)	NOTE
OS-01	ANSI	30MHz ~ 200MHz	V	3.82	
		30MHz ~ 200MHz	H	3.60	
		200MHz ~ 1,000MHz	V	3.86	
		200MHz ~ 1,000MHz	H	3.94	
OS-02	ANSI	30MHz ~ 200MHz	V	2.48	
		30MHz ~ 200MHz	H	2.16	
		200MHz ~ 1,000MHz	V	2.50	
		200MHz ~ 1,000MHz	H	2.66	





**3. GENERAL INFORMATION**

**3.1 GENERAL DESCRIPTION OF EUT**

Equipment	2.4G WIRELESS KEYBOARD	
Brand Name	N/A	
Model Name	DK-9023RL	
OEM Brand/Model Name	N/A	
Model Difference	N/A	
Product Description	The EUT is a 2.4G WIRELESS KEYBOARD	
	Operation Frequency:	2405~2476 MHz
	Modulation Type:	FHSS
	Bit Rate of Transmitter	GFSK(1Mbps)
	Number Of Channel	64 CH
	Antenna Designation:	Please see Note 3.
	Antenna Gain(Peak)	Please see Note 3.
	Output Power:	-14.86dBm
Based on the application, features, or specification exhibited in User's Manual, the EUT is considered as an ITE/Computing Device. More details of EUT technical specification, please refer to the User's Manual.		
Channel List	Please refer to the Note 2.	
Power Source	DC Voltage supplied from 2*AAA size Battery	
Power Rating	DC 3.0V	
Connecting I/O Port(s)	Please refer to the User's Manual	
Products Covered	N/A	
EUT Modification(s)	N/A	

**Note:**

1. For a more detailed features description, please refer to the manufacturer's specifications or the User's Manual.
2. Example of 64 hopping sequence in data mode:

```

22 21 41 15 47 50 30 54
07 13 23 42 14 29 61 43
12 08 52 28 10 44 19 36
03 24 20 62 18 58 32 55
35 25 26 45 39 63 56 34
05 04 46 59 06 00 37 40
53 27 33 31 17 49 01 60
09 11 48 51 38 16 57 02

```



3.

Group 1		Group 2	
Channel	Frequency (MHz)	Channel	Frequency (MHz)
1	2405	33	2407
2	2406	34	2408
3	2409	35	2412
4	2410	36	2414
5	2411	37	2417
6	2412	38	2420
7	2415	39	2421
8	2416	40	2422
9	2418	41	2427
10	2419	42	2428
11	2423	43	2431
12	2425	44	2435
13	2429	45	2436
14	2430	46	2437
15	2432	47	2438
16	2434	<b>48</b>	<b>2439</b>
17	2443	49	2442
18	2444	50	2447
19	2446	51	2451
20	2448	52	2452
21	2449	53	2457
22	2453	54	2458
23	2455	55	2459
24	2456	56	2460
25	2462	57	2461
26	2463	58	2465
27	2464	59	2468
28	2466	60	2469
29	2467	61	2472
30	2470	62	2473
31	2471	63	2475
32	2474	<b>64</b>	<b>2476</b>

4. Table for Filed Antenna

Ant.	Brand	Model Name	Antenna Type	Connector	Gain (dBi)
1	N/A	N/A	Printed Antenna	N/A	0.59



**3.2 DESCRIPTION OF TEST MODES**

To investigate the maximum EMI emission characteristics generates from EUT, the test system was pre-scanning tested base on the consideration of following EUT operation mode or test configuration mode which possible have effect on EMI emission level. Each of these EUT operation mode(s) or test configuration mode(s) mentioned above was evaluated respectively.

Pretest Mode	Description
Mode 1	CH01
Mode 2	CH48
Mode 3	CH64

For Conducted Emission	
Final Test Mode	Description
-	"N/A" denotes test is not applicable in this Test Report

For Radiated Emission	
Final Test Mode	Description
Mode 1	CH01
Mode 2	CH48
Mode 3	CH64

Note:

- (1) The measurements are performed at the highest, middle, lowest available channels.
- (2) The EUT use new battery.

**3.3 TABLE OF PARAMETERS OF TEXT SOFTWARE SETTING**

During testing channel & power controlling software provided by the customer was used to control the operating channel as well as the output power level. The RF output power selection is for the setting of RF output power expected by the customer and is going to be fixed on the firmware of the final end product power parameters of FHSS

Test software Version	Test program: Hardware control		
Frequency	2405 MHz	2439 MHz	2476 MHz
Parameters(1Mbps)	N/A	N/A	N/A



**3.4 BLOCK DIGRAM SHOWING THE CONFIGURATION OF SYSTEM TESTED**

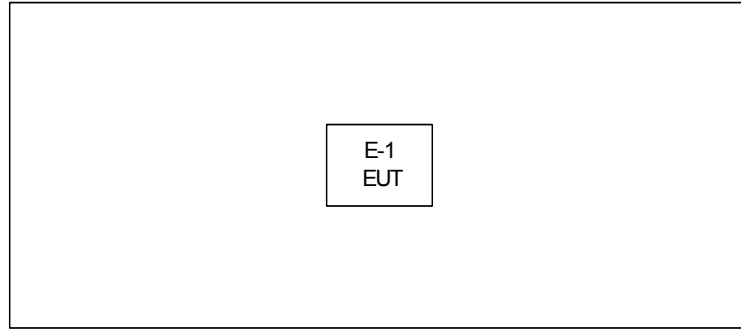



**3.1 DESCRIPTION OF SUPPORT UNITS(CONDUCTED MODE)**

The EUT has been tested as an independent unit together with other necessary accessories or support units. The following support units or accessories were used to form a representative test configuration during the tests.

Item	Equipment	Mfr/Brand	Model/Type No.	FCC ID	Series No.	Note
E-1	2.4G WIRELESS KEYBOARD	N/A	DK-9023RL	XW3DK9023RL	N/A	EUT

Item	Shielded Type	Ferrite Core	Length	Note

Note:

- (1) The support equipment was authorized by Declaration of Confirmation.
- (2) For detachable type I/O cable should be specified the length in cm in 『Length』 column.



**4. EMC EMISSION TEST**

**4.1 CONDUCTED EMISSION MEASUREMENT**

**4.1.1 POWER LINE CONDUCTED EMISSION Limits (Frequency Range 150KHz-30MHz)**

FREQUENCY (MHz)	Class A (dBuV)		Class B (dBuV)		Standard
	Quasi-peak	Average	Quasi-peak	Average	
0.15 -0.5	79.00	66.00	66 - 56 *	56 - 46 *	CISPR
0.50 -5.0	73.00	60.00	56.00	46.00	CISPR
5.0 -30.0	73.00	60.00	60.00	50.00	CISPR

0.15 -0.5	79.00	66.00	66 - 56 *	56 - 46 *	FCC
0.50 -5.0	73.00	60.00	56.00	46.00	FCC
5.0 -30.0	73.00	60.00	60.00	50.00	FCC

Note:

- (1) The tighter limit applies at the band edges.
- (2) The limit of " \* " marked band means the limitation decreases linearly with the logarithm of the frequency in the range.

**4.1.2 MEASUREMENT INSTRUMENTS LIST AND SETTING**

Item	Kind of Equipment	Manufacturer	Type No.	Serial No.	Calibrated until
1	LISN	EMCO	3816/2	00042991	Jan. 23, 2010
2	LISN	EMCO	3816/2	00042990	Jan. 23, 2010
3	Pulse Limiter	Electro-Metrics	EM-7600	112644	Nov. 26, 2009
4	50Ω Terminator	N/A	N/A	N/A	May.11, 2010
5	Test Cable	N/A	C01	N/A	Nov. 26, 2009
6	EMI Test Receiver	R&S	ESCI	100082	Mar. 06, 2010

Remark: " N/A" denotes No Model No. , Serial No. or No Calibration specified.

The following table is the setting of the receiver

Receiver Parameters	Setting
Attenuation	10 dB
Start Frequency	0.15 MHz
Stop Frequency	30 MHz
IF Bandwidth	9 kHz

#### 4.1.3 TEST PROCEDURE

- The EUT was placed 0.4 meters from the horizontal ground plane with EUT being connected to the power mains through a line impedance stabilization network (LISN). All other support equipments powered from additional LISN(s). The LISN provide 50 Ohm/ 50uH of coupling impedance for the measuring instrument.
- Interconnecting cables that hang closer than 40 cm to the ground plane shall be folded back and forth in the center forming a bundle 30 to 40 cm long.
- I/O cables that are not connected to a peripheral shall be bundled in the center. The end of the cable may be terminated, if required, using the correct terminating impedance. The overall length shall not exceed 1 m.
- LISN at least 80 cm from nearest part of EUT chassis.
- For the actual test configuration, please refer to the related Item –EUT Test Photos.

#### 4.1.4 DEVIATION FROM TEST STANDARD

No deviation

#### 4.1.5 TEST SETUP

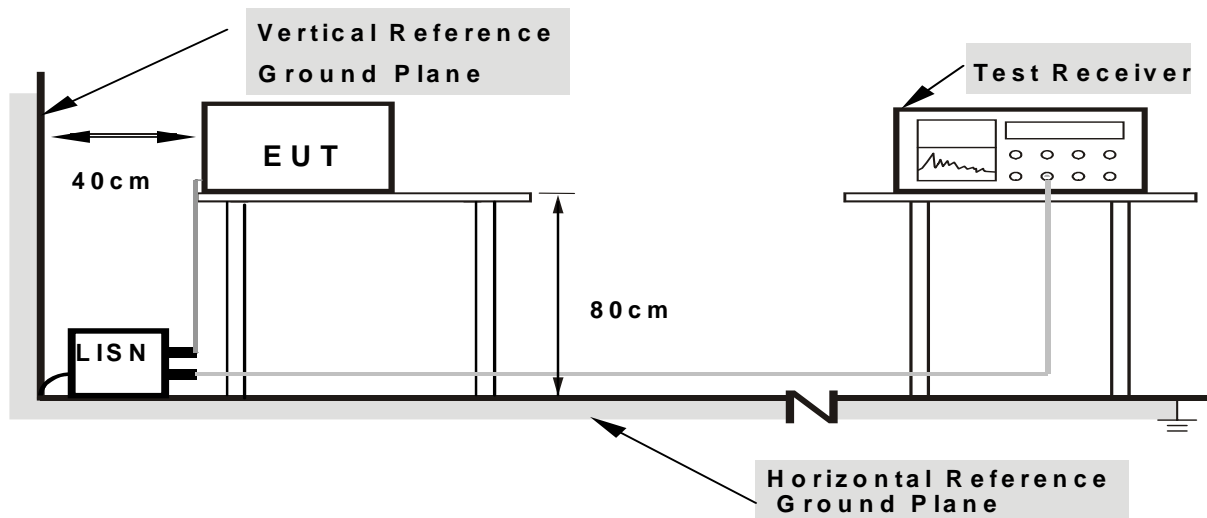

**Note: 1. Support units were connected to second LISN.**

**2. Both of LISNs (AMN) are 80 cm from EUT and at least 80 cm from other units and other metal planes**



#### **4.1.6 EUT OPERATING CONDITIONS**

The EUT was configured for testing in a typical fashion (as a customer would normally use it). The EUT has been programmed to continuously transmit during test. This operating condition was tested and used to collect the included data.





**4.1.7 TEST RESULTS**

EUT :	2.4G WIRELESS KEYBOARD	Model Name :	DK-9023RL
Temperature :	26 °C	Relative Humidity :	45%
Pressure :	1010hPa	Test Power :	DC 3.0V
Test Mode :	" N/A" denotes test is not applicable in this Test Report		

**Remark**

- (1) All readings are QP Mode value unless otherwise stated AVG in column of Note. If the QP Mode Measured value compliance with the QP Limits and lower than AVG Limits, the EUT shall be deemed to meet both QP & AVG Limits and then only QP Mode was measured, but AVG Mode didn't perform. In this case, a " \* " marked in AVG Mode column of Interference Voltage Measured.
- (2) Measuring frequency range from 150KHz to 30MHz.
- (3) " N/A" denotes test is not applicable in this Test Report



**4.2 RADIATED EMISSION MEASUREMENT**

**4.2.1 RADIATED EMISSION LIMITS (Frequency Range 9kHz-1000MHz)**

20dBc in any 100 kHz bandwidth outside the operating frequency band. In case the emission fall within the restricted band specified on 15.205(a), then the 15.209(a) limit in the table below has to be followed.

Frequencies (MHz)	Field Strength (micorvolts/meter)	Measurement Distance (meters)
0.009~0.490	2400/F(KHz)	300
0.490~1.705	24000/F(KHz)	30
1.705~30.0	30	30
30~88	100	3
88~216	150	3
216~960	200	3
Above 960	500	3

**LIMITS OF RADIATED EMISSION MEASUREMENT (Above 1000MHz)**

FREQUENCY (MHz)	Class A (dBuV/m) (at 3M)		Class B (dBuV/m) (at 3M)	
	PEAK	AVERAGE	PEAK	AVERAGE
Above 1000	80	60	74	54

Notes:

- (1) The limit for radiated test was performed according to FCC PART 15C.
- (2) The tighter limit applies at the band edges.
- (3) Emission level (dBuV/m)=20log Emission level (uV/m).

**FREQUENCY RANGE OF RADIATED MEASUREMENT (For unintentional radiators)**

Highest frequency generated or Upper frequency of measurement used in the device or on which the device operates or tunes (MHz)	Range (MHz)
Below 1.705	30
1.705 – 108	1000
108 – 500	2000
500 – 1000	5000
Above 1000	5 <sup>th</sup> harmonic of the highest frequency or 40 GHz, whichever is lower



**4.2.2 MEASUREMENT INSTRUMENTS LIST AND SETTING**

Item	Kind of Equipment	Manufacturer	Type No.	Serial No.	Calibrated until
1	Log-Bicon Antenna	Schwarzbeck	VULB 9160	3058	Nov. 26, 2009
2	Test Cable	N/A	10M_OS02	N/A	Nov. 26, 2009
3	Test Cable	N/A	OS02-1/-2/-3	N/A	Nov. 26, 2009
4	Pre-Amplifier	Anritsu	MH648A	M09961	Nov. 26, 2009
5	EMI Test Receiver	R&S	ESCI	100082	Jan. 29, 2010
6	Antenna Mast	Chance Most	CMTB-1.5	N/A	N/A
7	Turn Table	Chance Most	CMTB-1.5	N/A	N/A
8	Spectrum Analyzer	R&S	FSP_40	100129	Jan. 06, 2010
9	Horn Antenna	Schwarzbeck	BBHA9120D	9120D-325	Oct. 22, 2010
10	Horn Antenna	Schwarzbeck	BBHA9170	9170187	Oct. 22, 2010
11	Microwave Pre_amplifier	Agilent	8449B	3008A01714	Mar. 08, 2010
12	Microflex Cable	United Microwave	57793	1M	Mar. 08, 2010
13	Microflex Cable	United Microwave	A30A30-5006	10M	Jul. 05, 2010

Remark: " N/A" denotes No Model Name / Serial No. and No Calibration specified.

Spectrum Parameter	Setting
Attenuation	Auto
Start Frequency	1000 MHz
Stop Frequency	10th carrier harmonic
RB / VB (emission in restricted band)	1 MHz / 1 MHz for Peak, Average=PK-dycty cycle

Receiver Parameter	Setting
Attenuation	Auto
Start ~ Stop Frequency	9kHz~150kHz / RB 200Hz for QP
Start ~ Stop Frequency	150kHz~30MHz / RB 9kHz for QP
Start ~ Stop Frequency	30MHz~1000MHz / RB 120kHz for QP



DUTY CYCLE : TX 2405MHz (1Mbps)

Dwell time=ON/ON+OFF

ON:3.05msec

ON+OFF:(total time):15.5msec

Dwell time:19.61%

AV=PK+20 log(Dwell time)

AV=PK-14.15

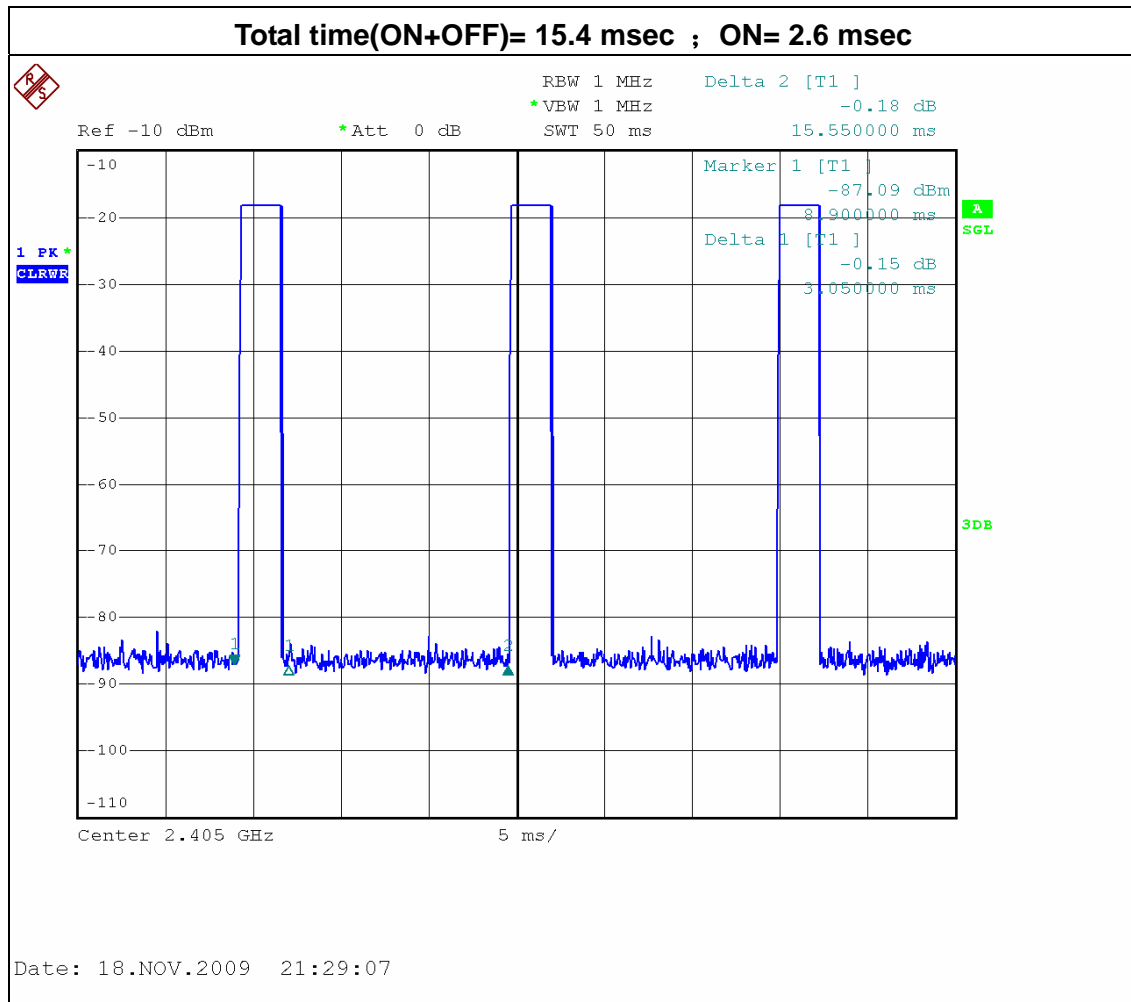



#### **4.2.3 TEST PROCEDURE**

- a. The measuring distance of at 3 m shall be used for measurements at frequency up to 1GHz. For frequencies above 1GHz, any suitable measuring distance may be used.
- b. The EUT was placed on the top of a rotating table 0.8 meters above the ground at a 3 meter open area test site. The table was rotated 360 degrees to determine the position of the highest radiation.
- c. The height of the equipment or of the substitution antenna shall be 0.8 m; the height of the test antenna shall vary between 1 m to 4 m. Both horizontal and vertical polarizations of the antenna are set to make the measurement.
- d. The initial step in collecting conducted emission data is a spectrum analyzer peak detector mode pre-scanning the measurement frequency range. Significant peaks are then marked and then Quasi Peak detector mode re-measured.
- e. If the Peak Mode measured value compliance with and lower than Quasi Peak Mode Limit, the EUT shall be deemed to meet QP Limits and then no additional QP Mode measurement performed.
- f. For the actual test configuration, please refer to the related Item –EUT Test Photos.

#### **4.2.4 DEVIATION FROM TEST STANDARD**

No deviation

**4.2.5 TEST SETUP**

(A) Radiated Emission Test Set-Up, Frequency Below 1000MHz

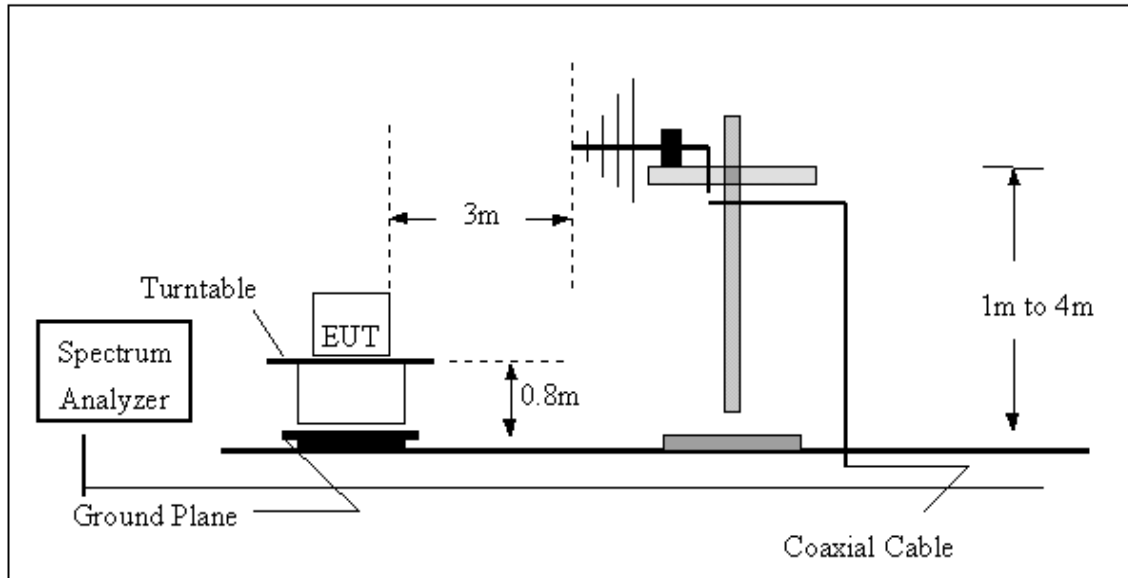

(B) Radiated Emission Test Set-Up Frequency Above 1 GHz

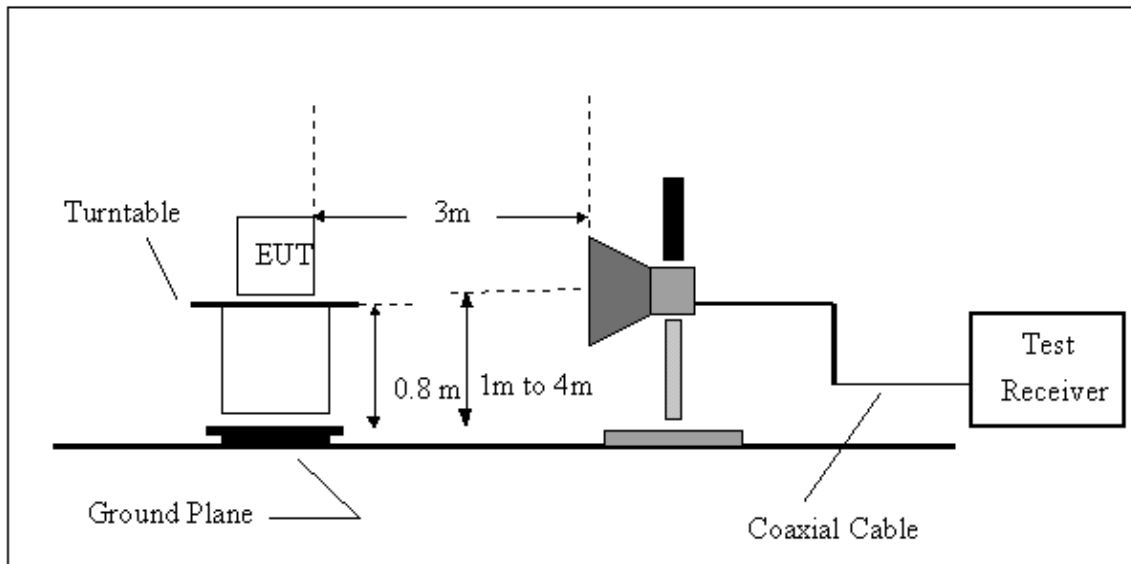

**4.2.6 EUT OPERATING CONDITIONS**

The EUT tested system was configured as the statements of 4.1.6 Unless otherwise a special operating condition is specified in the follows during the testing.



**4.2.7 TEST RESULTS (BETWEEN 30 – 1000 MHZ)**

EUT :	2.4G WIRELESS KEYBOARD	Model Name :	DK-9023RL
Temperature :	27 °C	Relative Humidity :	51 %
Pressure :	1010 hPa	Test Voltage :	DC 3.0V
Test Mode :	TX Mode 2439MHz		

Freq. (MHz)	Ant. H/V	Reading(RA) (dBuV)	Corr.Factor(CF) (dB)	Measured(FS) (dBuV/m)	Limits(QP) (dBuV/m)	Margin (dB)	Note
97.64	V	46.83	-19.79	27.04	43.50	- 16.46	
238.94	V	48.69	-15.88	32.81	46.00	- 13.19	
387.64	V	44.37	-10.86	33.51	46.00	- 12.49	
436.45	V	44.43	-9.40	35.03	46.00	- 10.97	
653.94	V	38.62	-4.60	34.02	46.00	- 11.98	
763.83	V	41.31	-3.11	38.20	46.00	- 7.80	

**Remark :**

- (1) Reading in which marked as QP or Peak means measurements by using are Quasi-Peak Mode or Peak Mode with Detector BW=120KHz ; SPA setting in RBW=120KHz, VBW =120KHz, Swp. Time = 0.3 sec./MHz ◦
- (2) All readings are Peak unless otherwise stated QP in column of 『 Note 』 . Peak denotes that the Peak reading compliance with the QP Limits and then QP Mode measurement didn't perform ◦
- (3) Measuring frequency range from 30MHz to 1000MHz ◦
- (4) If the peak scan value lower limit more than 20dB, then this signal data does not show in table ◦

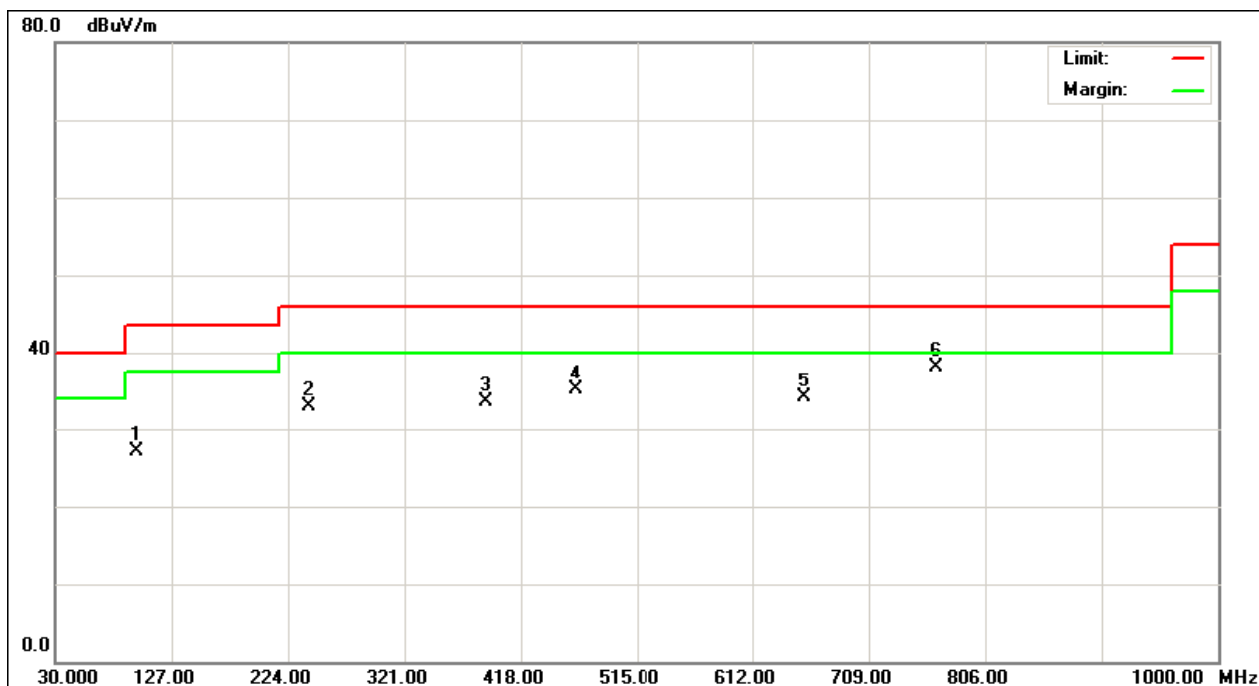



EUT :	2.4G WIRELESS KEYBOARD	Model Name :	DK-9023RL
Temperature :	27 °C	Relative Humidity :	51 %
Pressure :	1010 hPa	Test Voltage :	DC 3.0V
Test Mode :	TX Mode 2439MHz		

Freq. (MHz)	Ant. H/V	Reading(RA) (dBuV)	Corr.Factor(CF) (dB)	Measured(FS) (dBuV/m)	Limits(QP) (dBuV/m)	Margin (dB)	Note
64.92	H	49.82	-21.88	27.94	40.00	- 12.06	
153.92	H	47.74	-19.14	28.60	43.50	- 14.90	
365.73	H	45.72	-11.42	34.30	46.00	- 11.70	
463.24	H	42.82	-9.40	33.42	46.00	- 12.58	
653.82	H	38.91	-4.60	34.31	46.00	- 11.69	
734.82	H	40.13	-3.53	36.60	46.00	- 9.40	

**Remark :**

- (1) Reading in which marked as QP or Peak means measurements by using are Quasi-Peak Mode or Peak Mode with Detector BW=120KHz ; SPA setting in RBW=120KHz, VBW =120KHz, Swp. Time = 0.3 sec./MHz ◦
- (2) All readings are Peak unless otherwise stated QP in column of 『Note』 . Peak denotes that the Peak reading compliance with the QP Limits and then QP Mode measurement didn't perform ◦
- (3) Measuring frequency range from 30MHz to 1000MHz ◦
- (4) If the peak scan value lower limit more than 20dB, then this signal data does not show in table ◦

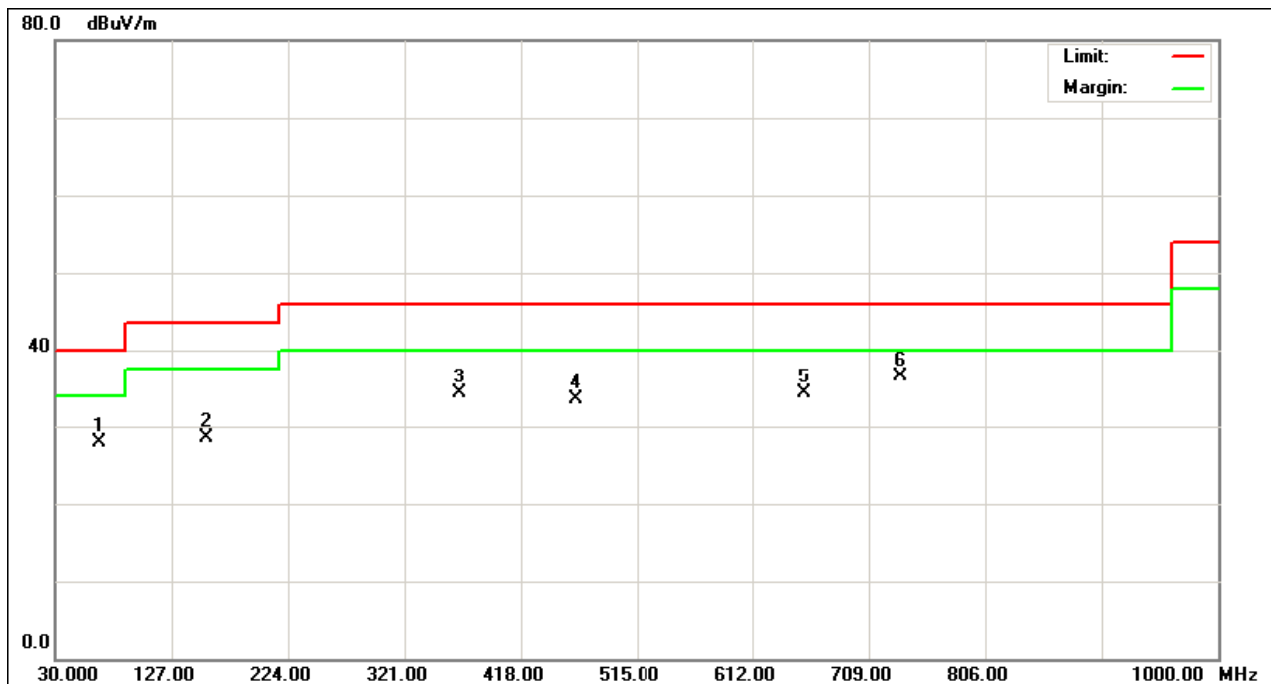





**4.2.8 TEST RESULTS (ABOVE 1000 MHZ)**

EUT :	2.4G WIRELESS KEYBOARD	Model Name :	DK-9023RL
Temperature :	27 °C	Relative Humidity :	51 %
Pressure :	1010 hPa	Test Voltage :	DC 3.0V
Test Mode :	TX 2405MHz		

Freq. (MHz)	Ant.Pol. H/V	Reading		Ant./CF CF(dB)	Act.		Limit		Note
		Peak (dBuV)	AV (dBuV)		Peak (dBuV/m)	AV (dBuV/m)	Peak (dBuV/m)	AV (dBuV/m)	
2390.00	V	21.66	7.51	32.32	53.98	39.83	74.00	54.00	X/E
<b>2405.08</b>	<b>V</b>	<b>46.63</b>	<b>32.48</b>	<b>32.36</b>	<b>78.99</b>	<b>64.84</b>			<b>X/F</b>
4810.25	V	44.82	30.67	4.46	49.28	35.13	74.00	54.00	X/H

**Remark :**

- (1) All readings are Peak unless otherwise stated QP in column of 『Note』 . Peak denotes that the Peak reading compliance with the QP Limits and then QP Mode measurement didn't perform .
- (2) Measuring frequency range from 30MHz to 1000MHz or the 10th harmonic of highest fundamental frequency . "F" denotes fundamental frequency; "H" denotes spurious frequency. "E" denotes band edge frequency. (This judgment method includes the Band Edge Requirement.)
- (3) Radiated emissions measured in frequency range above 1000MHz were made with an instrument using Peak detector mode and AV detector mode of the emission .
- (4) Data of measurement within this frequency range shown " \* " in the table above means the reading of emissions are attenuated more than 20dB below the permissible limits or the field strength is too small to be measured.
- (5) A preamp and high pass filter were used for this test in order to provide sufficient measurement sensitivity.
- (6) EUT Orthogonal Axis :  
 "X" - denotes Laid on Table ; "Y" - denotes Vertical Stand ; "Z" - denotes Side Stand
- (7) During the measurements above 1 GHz it is taken care of that the EUT is always within the 3 dB cone of radiation BW of the used antenna
- (8) The average value of fundamental frequency is:  
 Average = Peak value + 20log(Duty cycle) · Final AV=PK-14.15



TX CH01(Above 1000 MHz, Vertical)

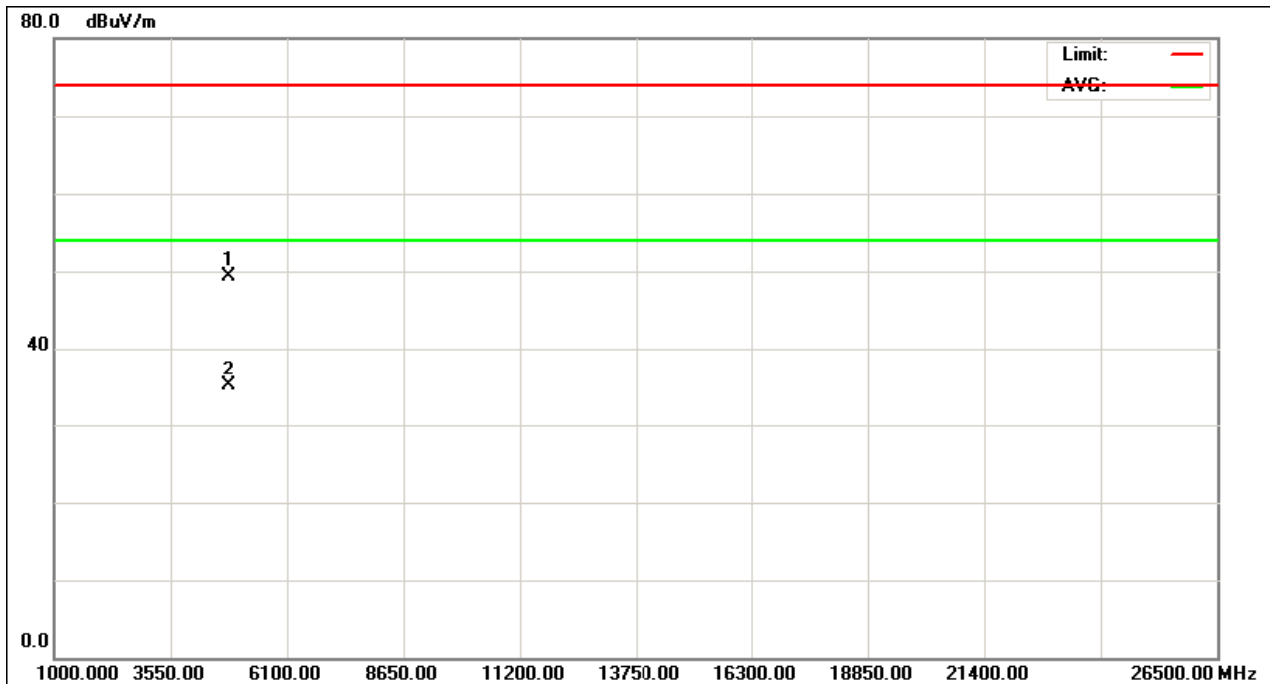
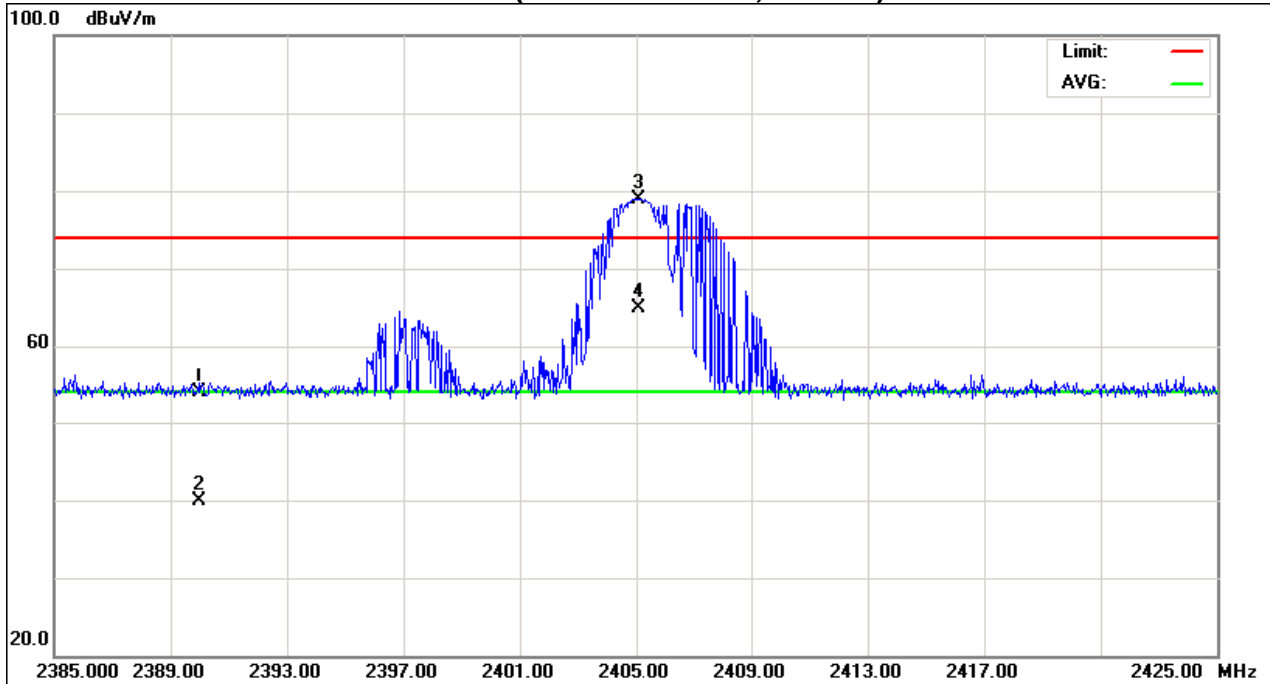



EUT :	2.4G WIRELESS KEYBOARD	Model Name :	DK-9023RL
Temperature :	27 °C	Relative Humidity :	51 %
Pressure :	1010hPa	Test Voltage :	DC 3.0V
Test Mode :	TX 2405MHz		

Freq. (MHz)	Ant.Pol. H/V	Reading		Ant./CF CF(dB)	Act.		Limit		Note
		Peak (dBuV)	AV (dBuV)		Peak (dBuV/m)	AV (dBuV/m)	Peak (dBuV/m)	AV (dBuV/m)	
2390.00	H	21.82	7.67	32.32	54.14	39.99	74.00	54.00	X/E
<b>2405.04</b>	<b>H</b>	<b>45.95</b>	<b>31.80</b>	<b>32.36</b>	<b>78.31</b>	<b>64.16</b>			<b>X/F</b>
4810.09	H	43.94	29.79	4.46	48.40	34.25	74.00	54.00	X/H

Remark :

- (1) All readings are Peak unless otherwise stated QP in column of 『Note』 . Peak denotes that the Peak reading compliance with the QP Limits and then QP Mode measurement didn't perform .
- (2) Measuring frequency range from 30MHz to 1000MHz or the 10th harmonic of highest fundamental frequency . "F" denotes fundamental frequency; "H" denotes spurious frequency. "E" denotes band edge frequency. (This judgment method includes the Band Edge Requirement.)
- (3) Radiated emissions measured in frequency range above 1000MHz were made with an instrument using Peak detector mode and AV detector mode of the emission .
- (4) Data of measurement within this frequency range shown " \* " in the table above means the reading of emissions are attenuated more than 20dB below the permissible limits or the field strength is too small to be measured.
- (5) A preamp and high pass filter were used for this test in order to provide sufficient measurement sensitivity.
- (6) EUT Orthogonal Axis :  
 "X" - denotes Laid on Table ; "Y" - denotes Vertical Stand ; "Z" - denotes Side Stand
- (7) During the measurements above 1 GHz it is taken care of that the EUT is always within the 3 dB cone of radiation BW of the used antenna
- (8) The average value of fundamental frequency is:  
 Average = Peak value + 20log(Duty cycle) · Final AV=PK-14.15



TX CH01(Above 1000 MHz, Horizontal)

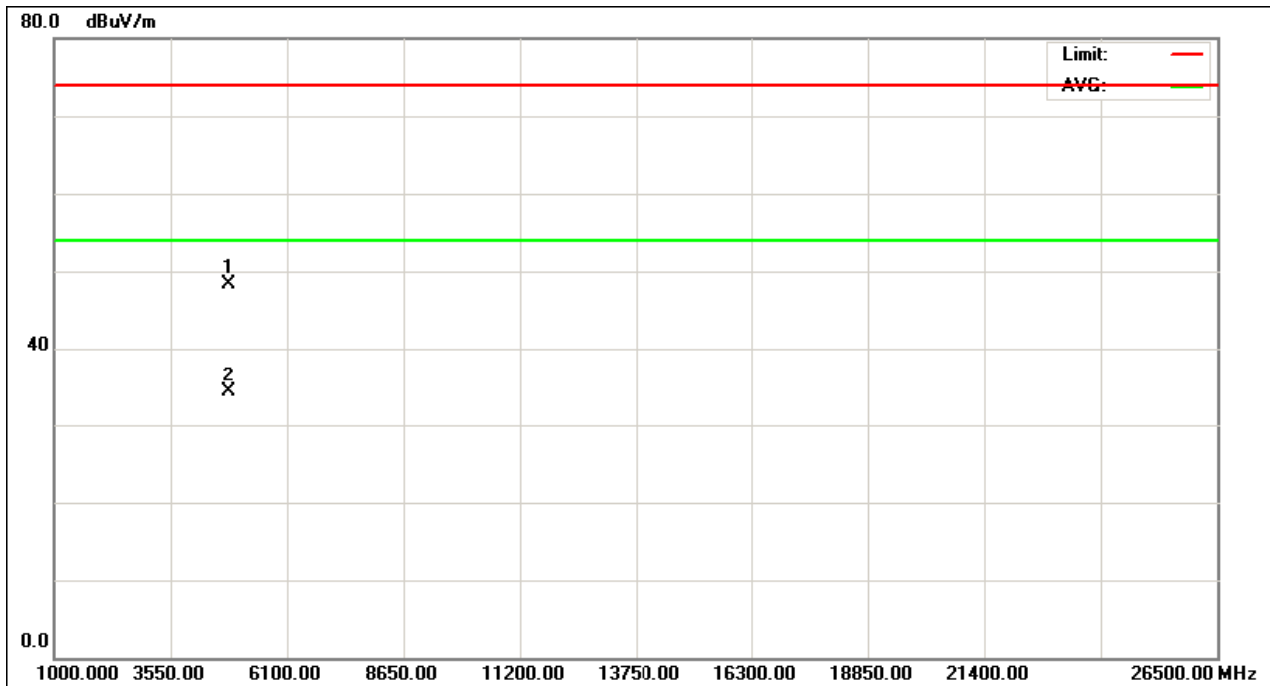
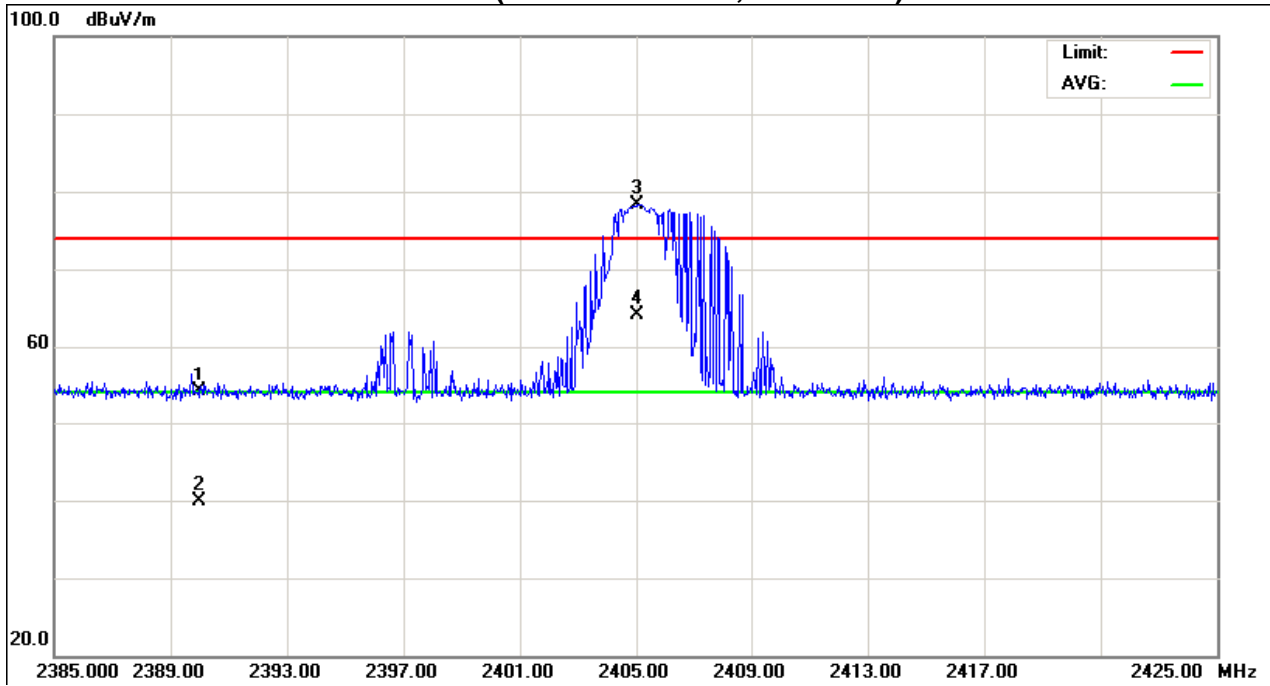



EUT :	2.4G WIRELESS KEYBOARD	Model Name :	DK-9023RL
Temperature :	27 °C	Relative Humidity :	51 %
Pressure :	1010 hPa	Test Voltage :	DC 3.0V
Test Mode :	TX 2439MHz		

Freq.	Ant.Pol.	Reading		Ant./CF	Act.		Limit		Note
		Peak	AV		Peak	AV	Peak	AV	
(MHz)	H/V	(dBuV)	(dBuV)	CF(dB)	(dBuV/m)	(dBuV/m)	(dBuV/m)	(dBuV/m)	
<b>2439.08</b>	<b>V</b>	<b>49.32</b>	<b>35.17</b>	<b>32.49</b>	<b>81.81</b>	<b>67.66</b>			<b>X/F</b>
4878.21	V	43.64	29.49	4.69	48.33	34.18	74.00	54.00	X/H

Remark :

- (1) All readings are Peak unless otherwise stated QP in column of 『Note』 . Peak denotes that the Peak reading compliance with the QP Limits and then QP Mode measurement didn't perform ◦
- (2) Measuring frequency range from 30MHz to 1000MHz or the 10th harmonic of highest fundamental frequency ◦ "F" denotes fundamental frequency; "H" denotes spurious frequency. "E" denotes band edge frequency. (This judgment method includes the Band Edge Requirement.)
- (3) Radiated emissions measured in frequency range above 1000MHz were made with an instrument using Peak detector mode and AV detector mode of the emission ◦
- (4) Data of measurement within this frequency range shown " \* " in the table above means the reading of emissions are attenuated more than 20dB below the permissible limits or the field strength is too small to be measured.
- (5) A preamp and high pass filter were used for this test in order to provide sufficient measurement sensitivity.
- (6) EUT Orthogonal Axis :  
 "X" - denotes Laid on Table ; "Y" - denotes Vertical Stand ; "Z" - denotes Side Stand
- (7) During the measurements above 1 GHz it is taken care of that the EUT is always within the 3 dB cone of radiation BW of the used antenna
- (8) The average value of fundamental frequency is:  
 Average = Peak value + 20log(Duty cycle) ◦ Final AV=PK-14.15



TX CH48 (Above 1000 MHz, Vertical)

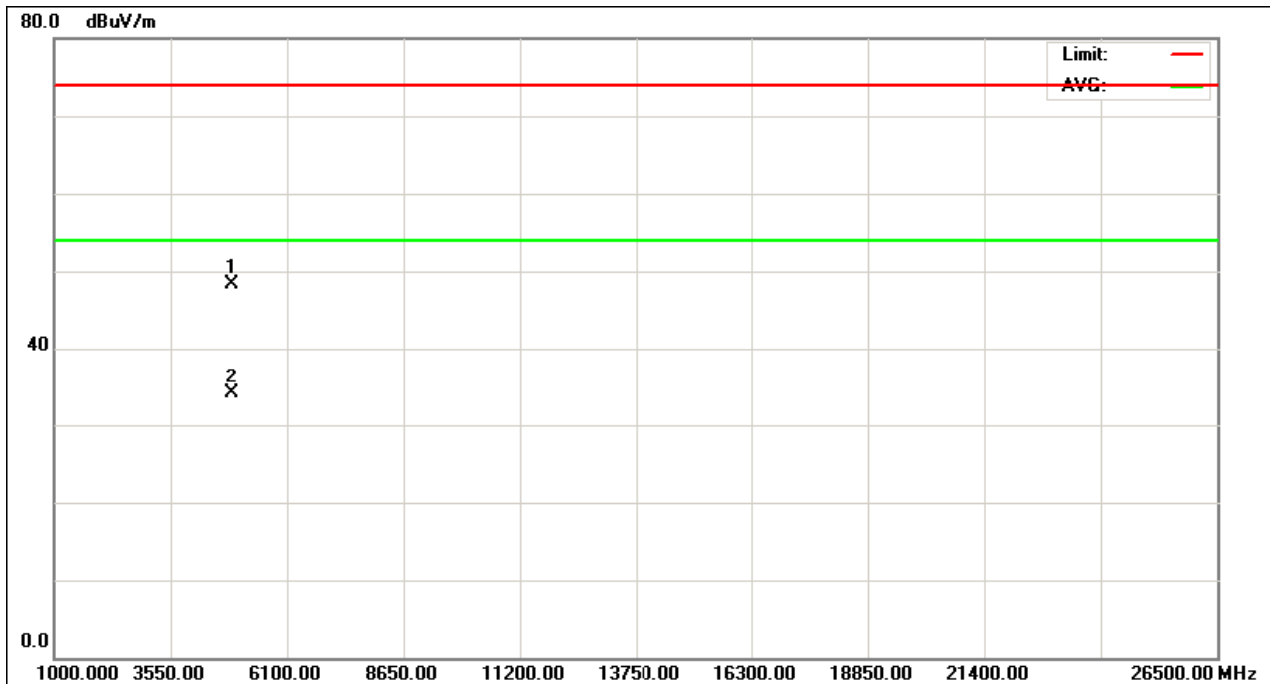
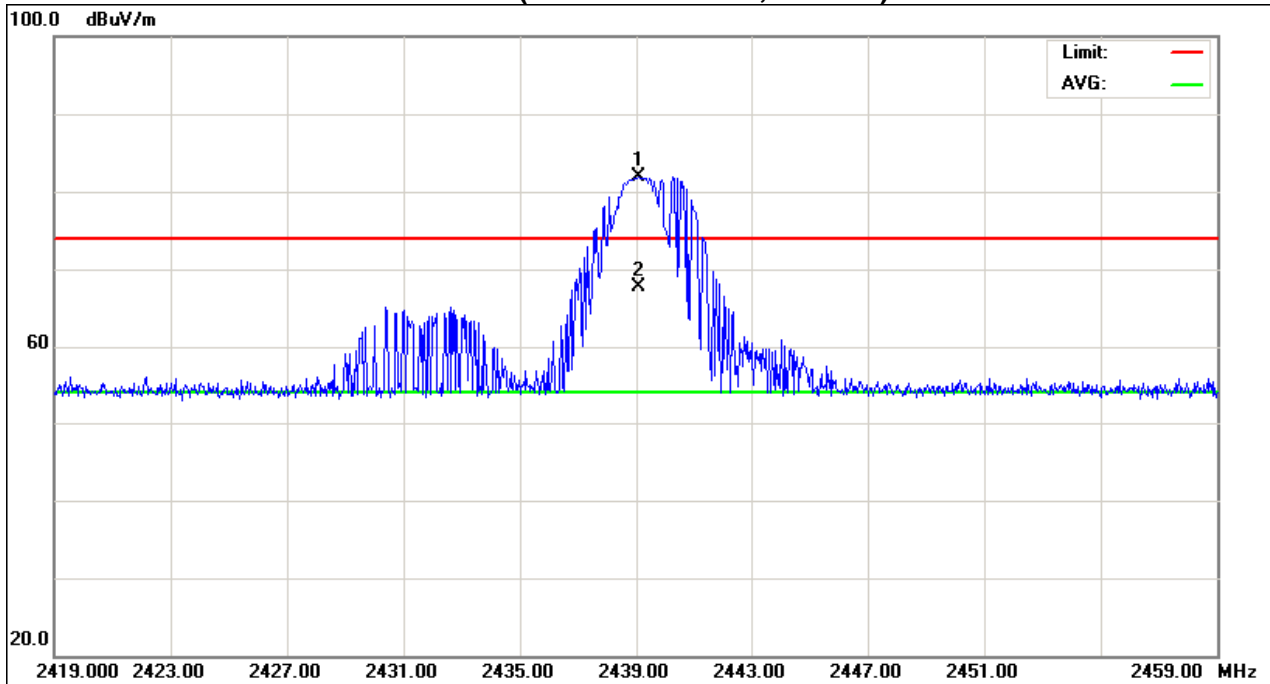



EUT :	2.4G WIRELESS KEYBOARD	Model Name :	DK-9023RL
Temperature :	27 °C	Relative Humidity :	51 %
Pressure :	1010 hPa	Test Voltage :	DC 3.0V
Test Mode :	TX 2439MHz		

Freq. (MHz)	Ant.Pol. H/V	Reading		Ant./CF CF(dB)	Act.		Limit		Note
		Peak (dBuV)	AV (dBuV)		Peak (dBuV/m)	AV (dBuV/m)	Peak (dBuV/m)	AV (dBuV/m)	
<b>2439.08</b>	<b>H</b>	<b>48.04</b>	<b>33.89</b>	<b>32.49</b>	<b>80.53</b>	<b>66.38</b>			<b>X/F</b>
4878.11	H	44.74	30.59	4.69	49.43	35.28	74.00	54.00	X/H

**Remark :**

- (1) All readings are Peak unless otherwise stated QP in column of 『 Note 』 . Peak denotes that the Peak reading compliance with the QP Limits and then QP Mode measurement didn't perform ◦
- (2) Measuring frequency range from 30MHz to 1000MHz or the 10th harmonic of highest fundamental frequency ◦ “F” denotes fundamental frequency; “H” denotes spurious frequency. “E” denotes band edge frequency. (This judgment method includes the Band Edge Requirement.)
- (3) Radiated emissions measured in frequency range above 1000MHz were made with an instrument using Peak detector mode and AV detector mode of the emission ◦
- (4) Data of measurement within this frequency range shown “ \* ” in the table above means the reading of emissions are attenuated more than 20dB below the permissible limits or the field strength is too small to be measured.
- (5) A preamp and high pass filter were used for this test in order to provide sufficient measurement sensitivity.
- (6) EUT Orthogonal Axis :  
“X” - denotes Laid on Table ; “Y” - denotes Vertical Stand ; “Z” - denotes Side Stand
- (7) During the measurements above 1 GHz it is taken care of that the EUT is always within the 3 dB cone of radiation BW of the used antenna
- (8) The average value of fundamental frequency is:  
Average = Peak value + 20log(Duty cycle) ◦ Final AV=PK-14.15



TX CH48 (Above 1000 MHz, Horizontal)

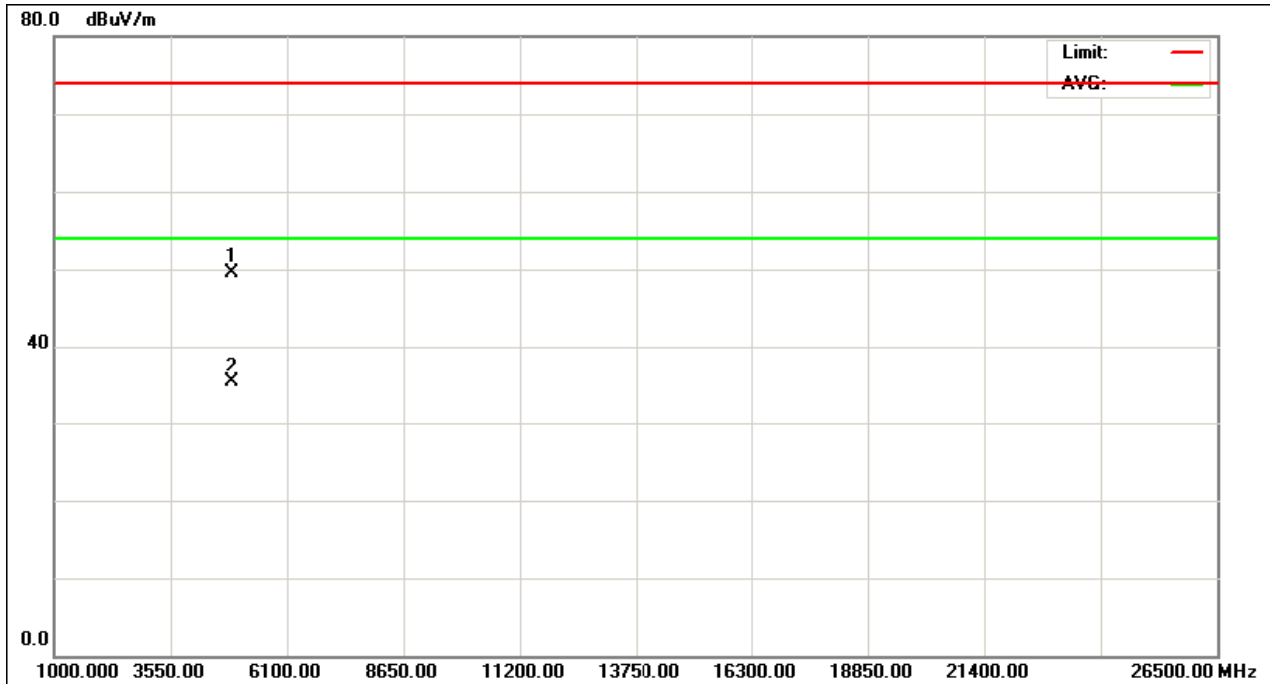
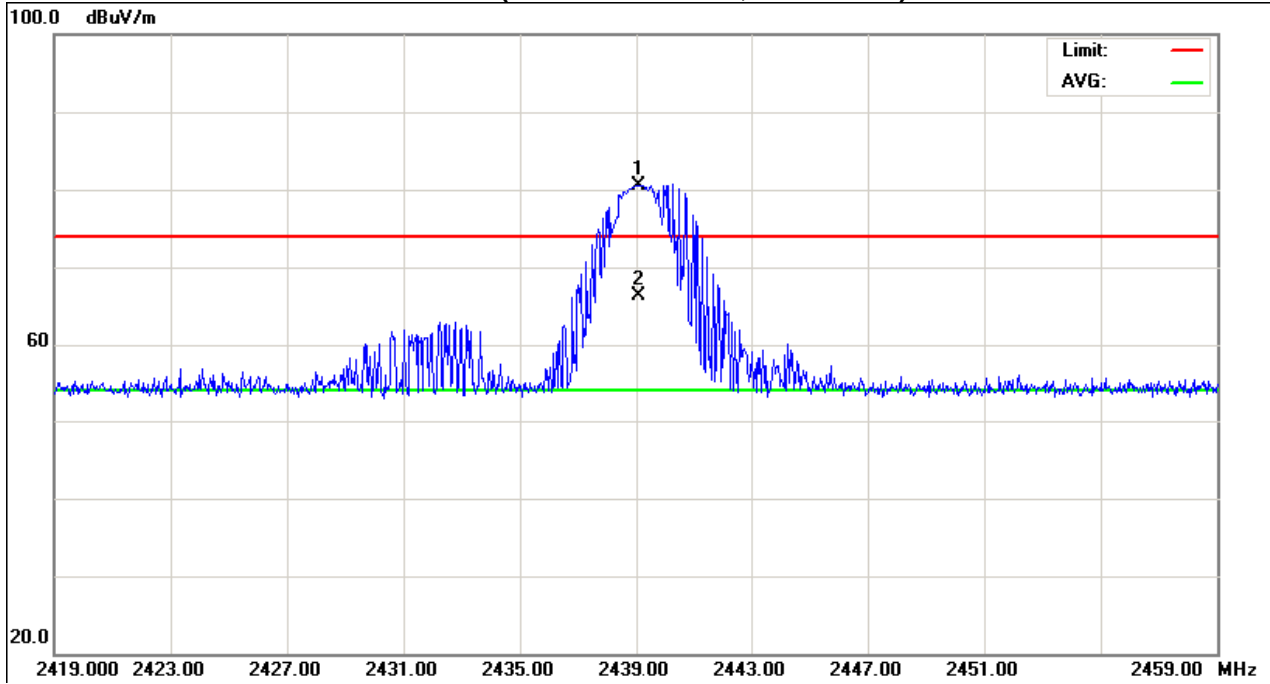





EUT :	2.4G WIRELESS KEYBOARD	Model Name :	DK-9023RL
Temperature :	27 °C	Relative Humidity :	51 %
Pressure :	1010hPa	Test Voltage :	DC 3.0V
Test Mode :	TX 2476MHz		

Freq.	Ant. Pol.	Reading		Ant./CF	Act.		Limit		Note
		Peak	AV		Peak	AV	Peak	AV	
(MHz)	H/V	(dBuV)	(dBuV)	CF(dB)	(dBuV/m)	(dBuV/m)	(dBuV/m)	(dBuV/m)	
<b>2476.04</b>	<b>V</b>	<b>50.51</b>	<b>36.36</b>	<b>32.61</b>	<b>83.12</b>	<b>68.97</b>			<b>X/F</b>
2483.50	V	21.91	7.76	32.63	54.54	40.39	74.00	54.00	X/E
4952.04	V	46.34	32.19	4.92	51.26	37.11	74.00	54.00	X/H

Remark :

- (1) All readings are Peak unless otherwise stated QP in column of 『Note』 . Peak denotes that the Peak reading compliance with the QP Limits and then QP Mode measurement didn't perform .
- (2) Measuring frequency range from 30MHz to 1000MHz or the 10th harmonic of highest fundamental frequency . "F" denotes fundamental frequency; "H" denotes spurious frequency. "E" denotes band edge frequency. (This judgment method includes the Band Edge Requirement.)
- (3) Radiated emissions measured in frequency range above 1000MHz were made with an instrument using Peak detector mode and AV detector mode of the emission .
- (4) Data of measurement within this frequency range shown " \* " in the table above means the reading of emissions are attenuated more than 20dB below the permissible limits or the field strength is too small to be measured.
- (5) A preamp and high pass filter were used for this test in order to provide sufficient measurement sensitivity.
- (6) EUT Orthogonal Axis :  
 "X" - denotes Laid on Table ; "Y" - denotes Vertical Stand ; "Z" - denotes Side Stand
- (7) During the measurements above 1 GHz it is taken care of that the EUT is always within the 3 dB cone of radiation BW of the used antenna
- (8) The average value of fundamental frequency is:  
 Average = Peak value + 20log(Duty cycle) · Final AV=PK-14.15



TX CH64 (Above 1000 MHz, Vertical)

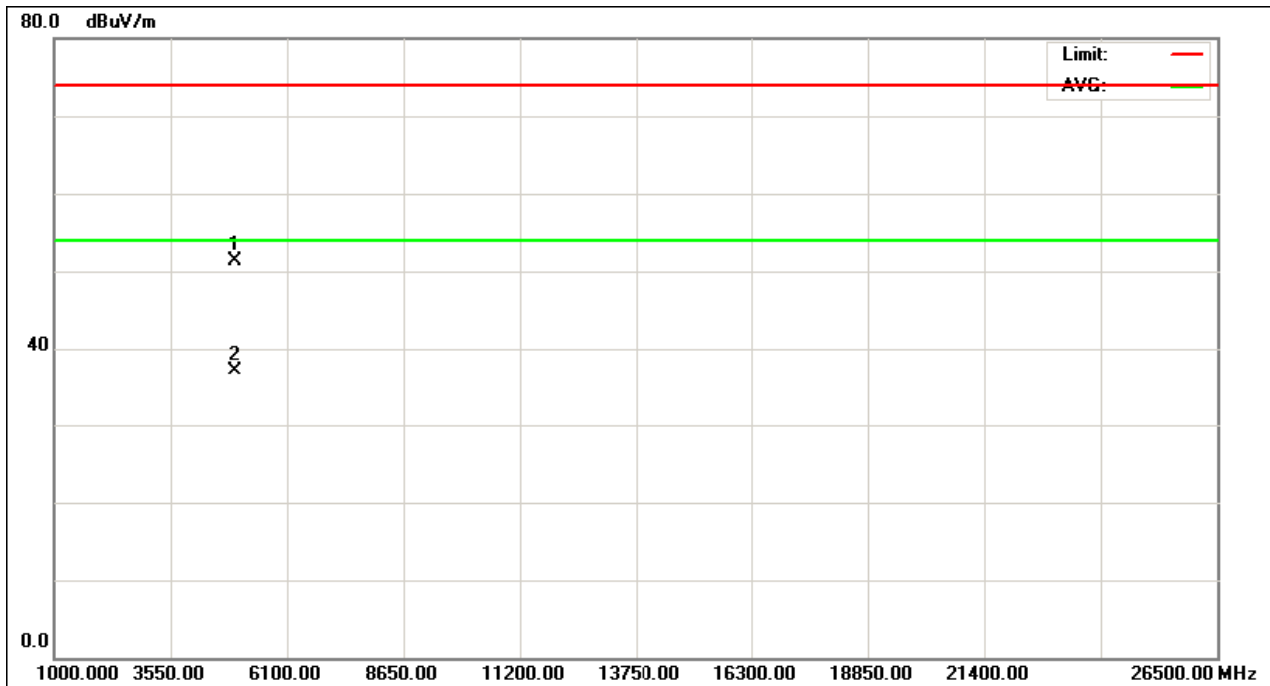
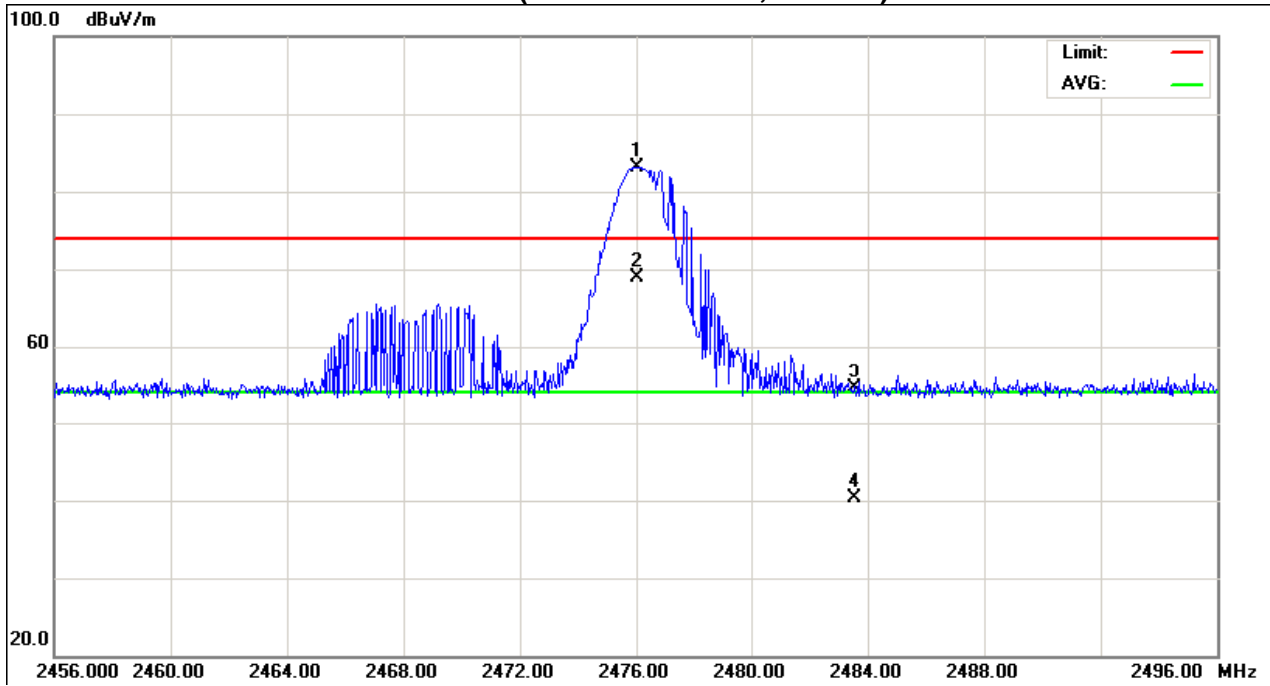



EUT :	2.4G WIRELESS KEYBOARD	Model Name :	DK-9023RL
Temperature :	27 °C	Relative Humidity :	51 %
Pressure :	1010 hPa	Test Voltage :	DC 3.0V
Test Mode :	TX 2476MHz		

Freq.	Ant.Pol.	Reading		Ant./CF	Act.		Limit		Note
		Peak	AV		Peak	AV	Peak	AV	
(MHz)	H/V	(dBuV)	(dBuV)	CF(dB)	(dBuV/m)	(dBuV/m)	(dBuV/m)	(dBuV/m)	
<b>2476.12</b>	<b>H</b>	<b>48.39</b>	<b>34.24</b>	<b>32.61</b>	<b>81.00</b>	<b>66.85</b>			<b>X/F</b>
2483.50	H	21.80	7.65	32.63	54.43	40.28	74.00	54.00	X/E
4952.13	H	45.65	31.50	4.92	50.57	36.42	74.00	54.00	X/H

Remark :

- (1) All readings are Peak unless otherwise stated QP in column of 『Note』 . Peak denotes that the Peak reading compliance with the QP Limits and then QP Mode measurement didn't perform .
- (2) Measuring frequency range from 30MHz to 1000MHz or the 10th harmonic of highest fundamental frequency .“F” denotes fundamental frequency; “H” denotes spurious frequency. “E” denotes band edge frequency. (This judgment method includes the Band Edge Requirement.)
- (3) Radiated emissions measured in frequency range above 1000MHz were made with an instrument using Peak detector mode and AV detector mode of the emission .
- (4) Data of measurement within this frequency range shown “ \* ” in the table above means the reading of emissions are attenuated more than 20dB below the permissible limits or the field strength is too small to be measured.
- (5) A preamp and high pass filter were used for this test in order to provide sufficient measurement sensitivity.
- (6) EUT Orthogonal Axis :  
“X” - denotes Laid on Table ; “Y” - denotes Vertical Stand ; “Z” - denotes Side Stand
- (7) During the measurements above 1 GHz it is taken care of that the EUT is always within the 3 dB cone of radiation BW of the used antenna
- (8) The average value of fundamental frequency is:  
Average = Peak value + 20log(Duty cycle) · Final AV=PK-14.15



TX CH64 (Above 1000 MHz, Horizontal)

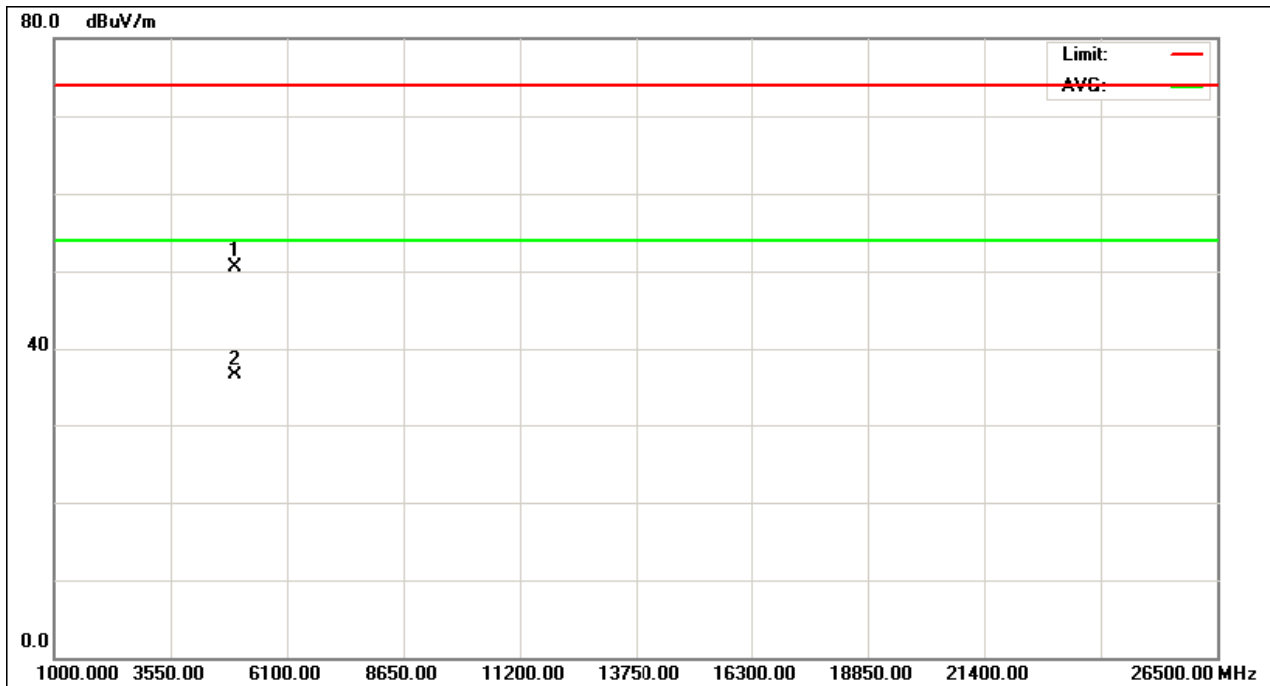
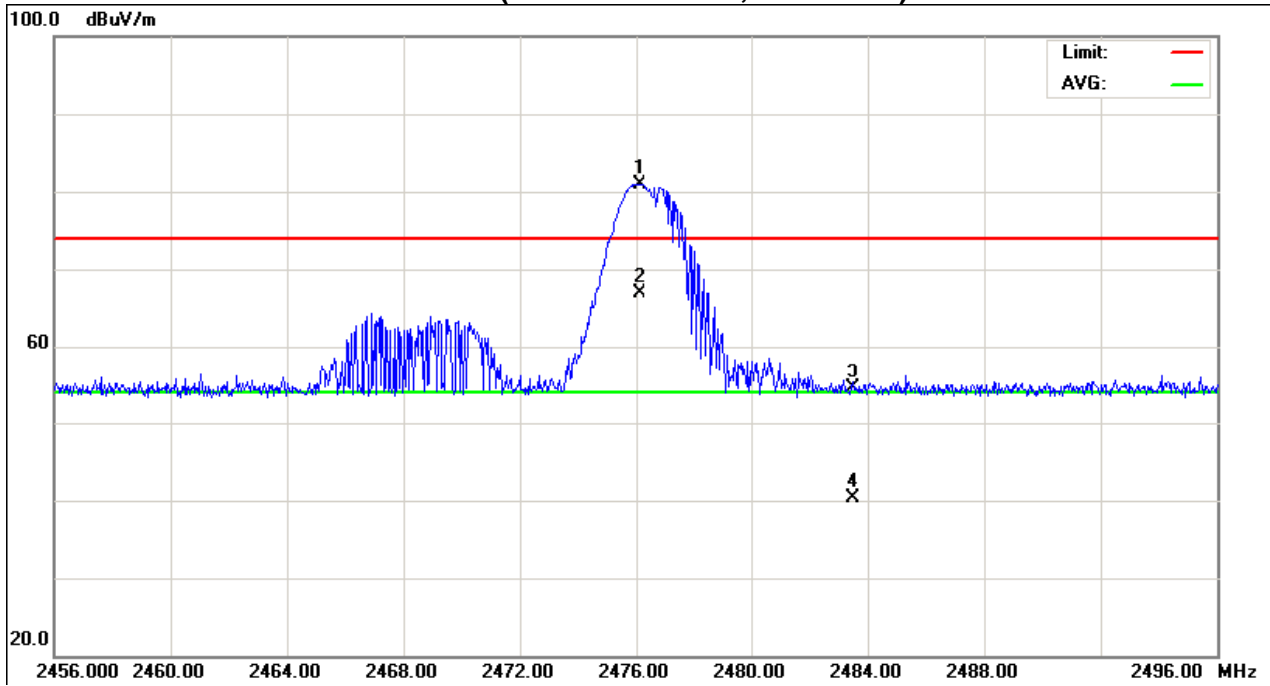



**4.2.9 TEST RESULTS (RESTRICTED BANDS REQUIREMENTS)**

EUT :	2.4G WIRELESS KEYBOARD	Model Name :	DK-9023RL
Temperature :	27 °C	Relative Humidity :	51 %
Pressure :	1010 hPa	Test Voltage :	DC 3.0V
Test Mode :	TX 2405MHz/2476MHz		
Note :	1. The transmitter was setup to transmit at the lowest channel (CH01). Then the field strength was measured at 2310-2390 MHz. 2. The transmitter was setup to transmit at the highest channel (CH64 ). Then the field strength was measured at 2483.5-2500 MHz.		

Freq. (MHz)	Ant.Pol. H/V	Reading		Ant./CF CF(dB)	Act.		Limit		Note
		Peak (dBuV)	AV (dBuV)		Peak (dBuV/m)	AV (dBuV/m)	Peak (dBuV/m)	AV (dBuV/m)	
2390.00	V	21.66	7.51	32.32	53.98	39.83	74.00	54.00	CH01
2483.50	V	21.91	7.76	32.63	54.54	40.39	74.00	54.00	CH64

**Remark :**

- (1) Radiated emissions measured in frequency range above 1000MHz were made with an instrument using Peak detector mode and AV detector mode of the emission .
- (2) EUT Orthogonal Axis :  
 "X" - denotes Laid on Table ; "Y" - denotes Vertical Stand ; "Z" - denotes Side Stand
- (3) During the measurements above 1 GHz it is taken care of that the EUT is always within the 3 dB cone of radiation BW of the used antenna
- (4) The average value of fundamental frequency is:  
 Average = Peak value + 20log(Duty cycle) · Final AV=PK-14.15



### Restricted Bands Requirements, Vertical CH01

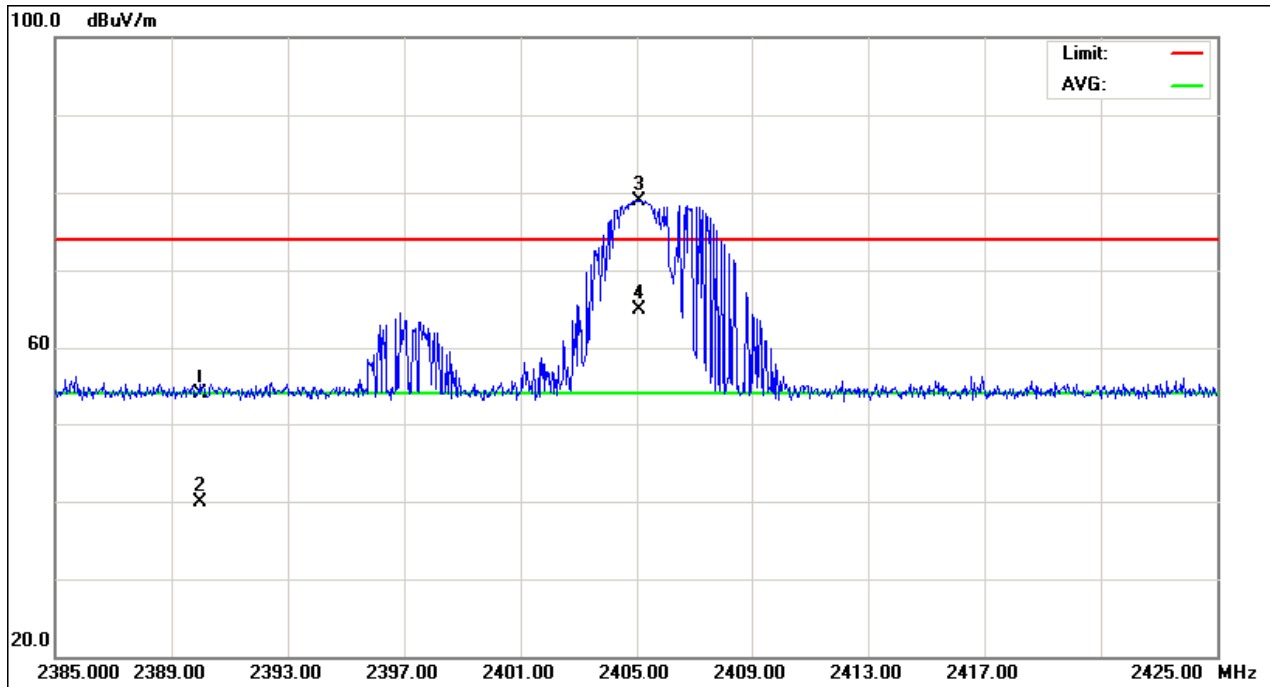

### CH64

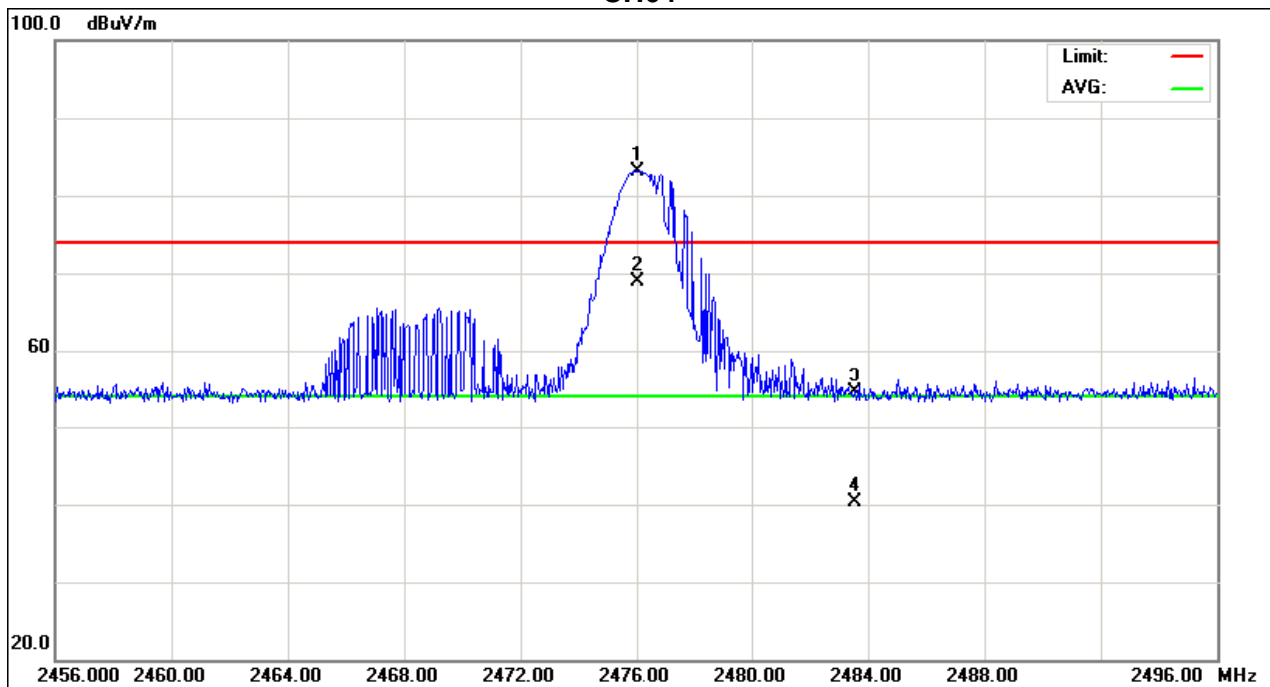



EUT :	2.4G WIRELESS KEYBOARD	Model Name :	DK-9023RL
Temperature :	27 °C	Relative Humidity :	51 %
Pressure :	1010 hPa	Test Voltage :	DC 3.0V
Test Mode :	TX 2405MHz/2476MHz		
Note :	1. The transmitter was setup to transmit at the lowest channel (CH01). Then the field strength was measured at 2310-2390 MHz. 2. The transmitter was setup to transmit at the highest channel (CH64 ). Then the field strength was measured at 2483.5-2500 MHz.		

Freq.	Ant.Pol.	Reading		Ant./CF	Act.		Limit		Note
		Peak	AV		Peak	AV	Peak	AV	
(MHz)	H/V	(dBuV)	(dBuV)	CF(dB)	(dBuV/m)	(dBuV/m)	(dBuV/m)	(dBuV/m)	
2390.00	H	21.82	7.67	32.32	54.14	39.99	74.00	54.00	CH01
2483.50	H	21.80	7.65	32.63	54.43	40.28	74.00	54.00	CH64

**Remark :**

- (1) Radiated emissions measured in frequency range above 1000MHz were made with an instrument using Peak detector mode and AV detector mode of the emission .
- (2) EUT Orthogonal Axis :  
 "X" - denotes Laid on Table ; "Y" - denotes Vertical Stand ; "Z" - denotes Side Stand
- (3) During the measurements above 1 GHz it is taken care of that the EUT is always within the 3 dB cone of radiation BW of the used antenna
- (4) The average value of fundamental frequency is:  
 Average = Peak value + 20log(Duty cycle) · Final AV=PK-14.15



### Restricted Bands Requirements, Horizontal CH01

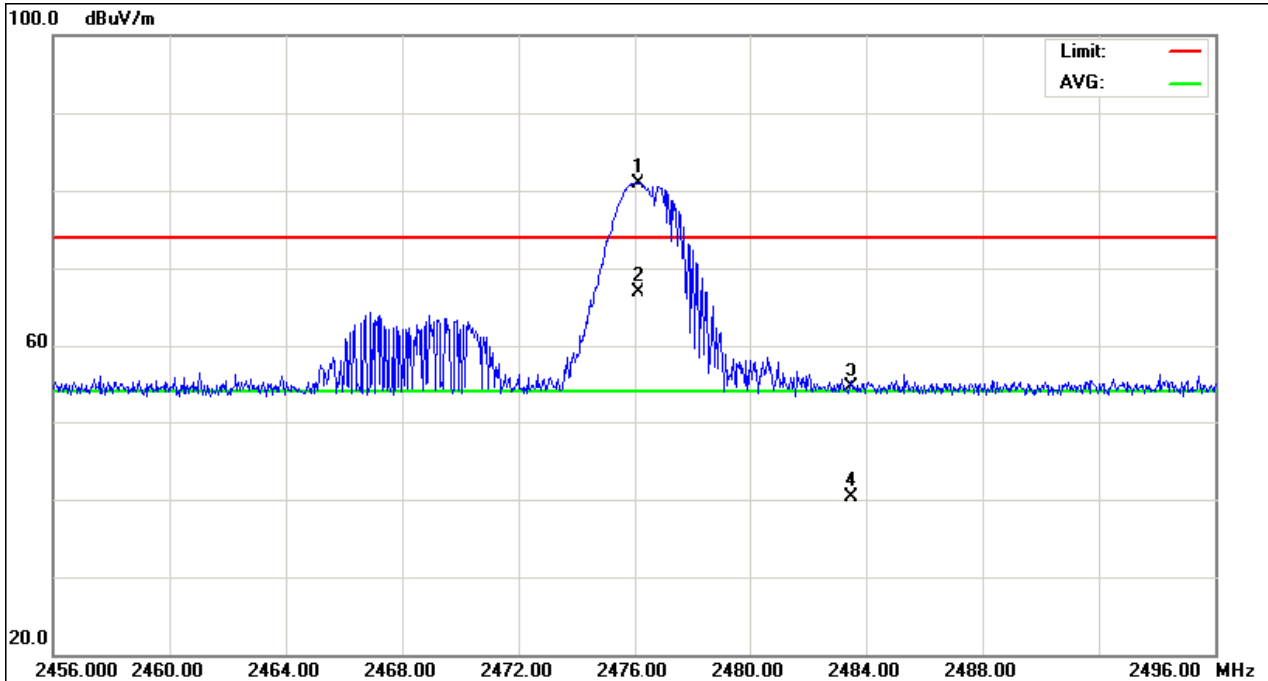
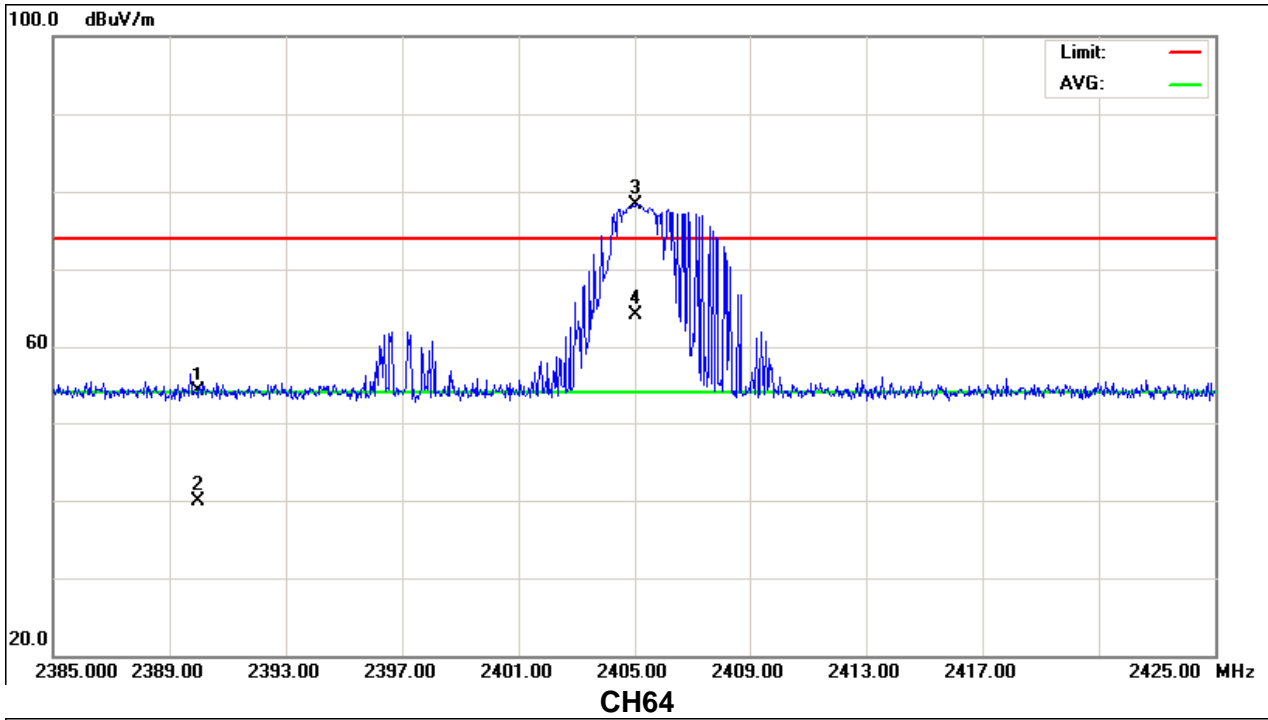





**5. NUMBER OF HOPPING CHANNEL**

**5.1 APPLIED PROCEDURES / LIMIT**

FCC Part15 (15.247) , Subpart C			
Section	Test Item	Frequency Range (MHz)	Result
15.247 (a)(1)(ii)	Number of Hopping Channel	2400-2483.5	PASS

**5.1.1 MEASUREMENT INSTRUMENTS LIST AND SETTING**

Item	Kind of Equipment	Manufacturer	Type No.	Serial No.	Calibrated until
1	Spectrum Analyzer	R&S	FSP_40	100129	Jan. 06, 2010

Remark: " N/A" denotes No Model Name , Serial No. or No Calibration specified.

Spectrum Parameters	Setting
Attenuation	Auto
Span Frequency	> Operating Frequency Range
RB	100 kHz
VB	100 kHz
Detector	Peak
Trace	Max Hold
Sweep Time	Auto

**5.1.2 TEST PROCEDURE**

- a. The EUT was directly connected to the spectrum analyzer and antenna output port as show in the block diagram below,
- b. Spectrum Setting : RBW= 100KHz, VBW=100KHz, Sweep time = Auto.

**5.1.3 DEVIATION FROM STANDARD**

No deviation.

**5.1.4 TEST SETUP**



**5.1.5 EUT OPERATION CONDITIONS**

The EUT tested system was configured as the statements of 4.1.6 Unless otherwise a special operating condition is specified in the follows during the testing.



**5.1.6 TEST RESULTS**

EUT :	2.4G WIRELESS KEYBOARD	Model Name :	DK-9023RL
Temperature :	25 °C	Relative Humidity :	60%
Pressure :	1015 hPa	Test Voltage :	DC 3.0V
Test Mode :	Hopping Mode		

Number of Hopping Channel	64
---------------------------	----

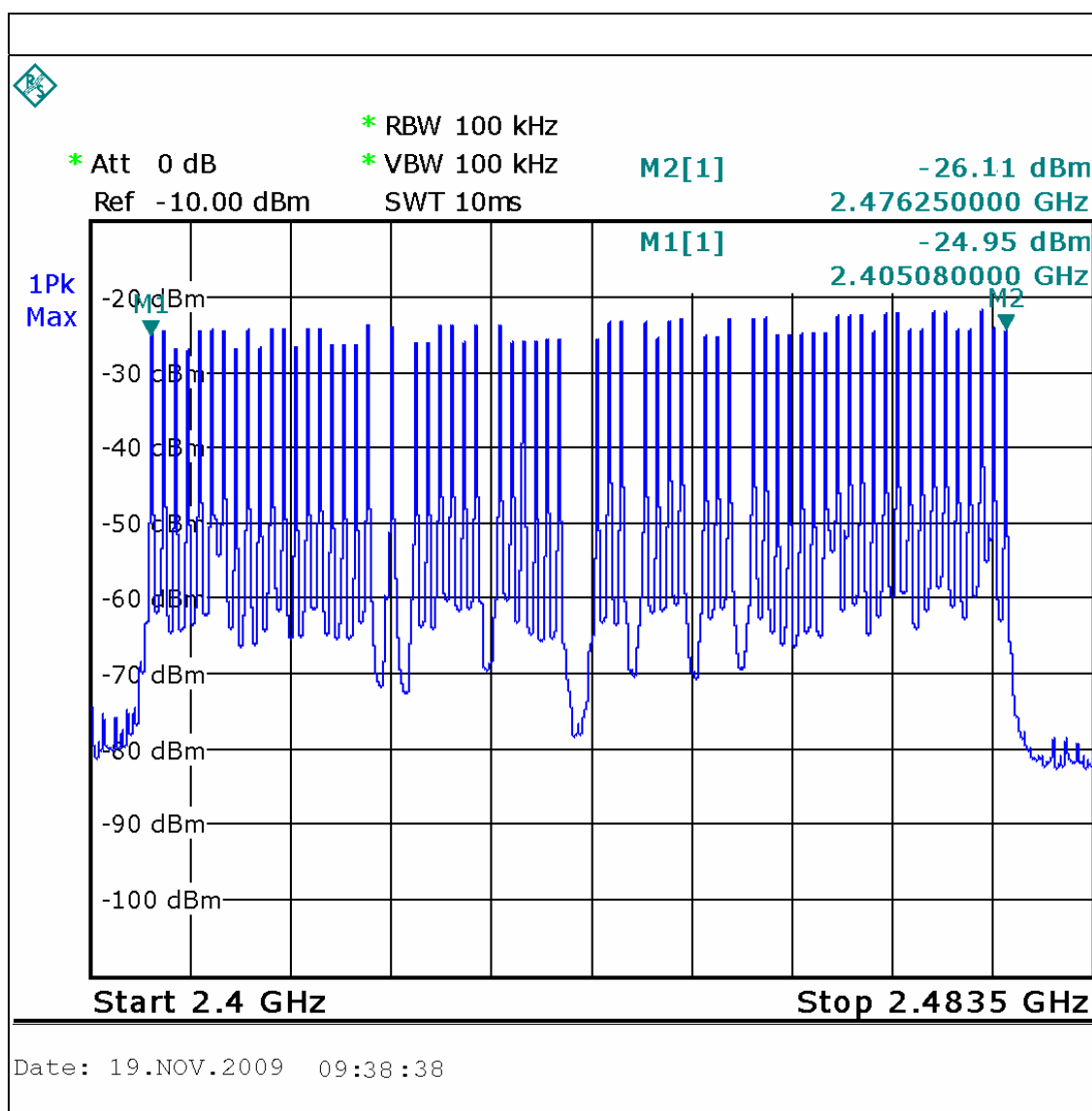

**6. AVERAGE TIME OF OCCUPANCY**

**6.1 APPLIED PROCEDURES / LIMIT**

FCC Part15 (15.247) , Subpart C				
Section	Test Item	Limit	Frequency Range (MHz)	Result
15.247 (a)(1)(ii)	Average Time of Occupancy	0.4sec	2400-2483.5	PASS

**6.1.1 MEASUREMENT INSTRUMENTS LIST**

Item	Kind of Equipment	Manufacturer	Type No.	Serial No.	Calibrated until
1	Spectrum Analyzer	R&S	FSP_40	100129	Jan. 06, 2010

Remark: " N/A" denotes No Model Name , Serial No. or No Calibration specified.

**6.1.2. TEST PROCEDURES**

- a. The transmitter output (antenna port) was connected to the spectrum analyzer
- b. Set RBW of spectrum analyzer to 1MHz and VBW to 1MHz.
- c. Use a video trigger with the trigger level set to enable triggering only on full pulses.
- d. Sweep Time is more than once pulse time.
- e. Set the center frequency on any frequency would be measure and set the frequency span to zero span.
- f. Measure the maximum time duration of one single pulse.
- g. Set the EUT for packet transmitting.
- h. Measure the maximum time duration of one single pulse.

**6.1.3. TEST SETUP LAYOUT**

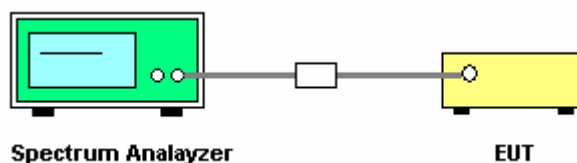

**6.1.4. TEST DEVIATION**

There is no deviation with the original standard.

**6.1.5. EUT OPERATION DURING TEST**

The EUT was programmed to be in continuously transmitting/Hopping mode.



**6.1.6. RESULTS OF OCCUPIED BANDWIDTH AND SPREAD-SPECTRUM BANDWIDTH**

EUT :	2.4G WIRELESS KEYBOARD	Model Name :	DK-9023RL
Temperature :	25 °C	Relative Humidity :	60%
Pressure :	1015 hPa	Test Voltage :	DC 3.0V
Test Mode :	Hopping Mode		

Mode	Number of transmission in a 12.8 (32Hopping*0.4)	Length of transmission time (msec)	Result (msec)	Limit (msec)
2476 MHz	$(256/2/64) * 25.6 = 51.2$ times <b>Note1</b>	0.320	16.384	400

**Note1:** 13 times of occupied channels per 0.2 second

	Results
Measured cycle (sec)	$64 \text{ CH} * 0.4 = 25.6$
The total number of frequency-hopping per second	$((20/5) * 64) = 256$
The number of occupied channels per second (Note1)	$(256/2)/64 = 2(\text{number/sec})$
occupied time for each channel(1)	0.320ms
The total number of channels occupied within one cycle (2)	$2 * 25.6 = 51.2$ times
The average time of occupancy within one cycle(1)*(2)	$51.2 * 0.32 = 16.384\text{msec}$
LIMIT (msec)	400msec

**Note1:** Time of transmission compared to time of receiving is 1 to 1

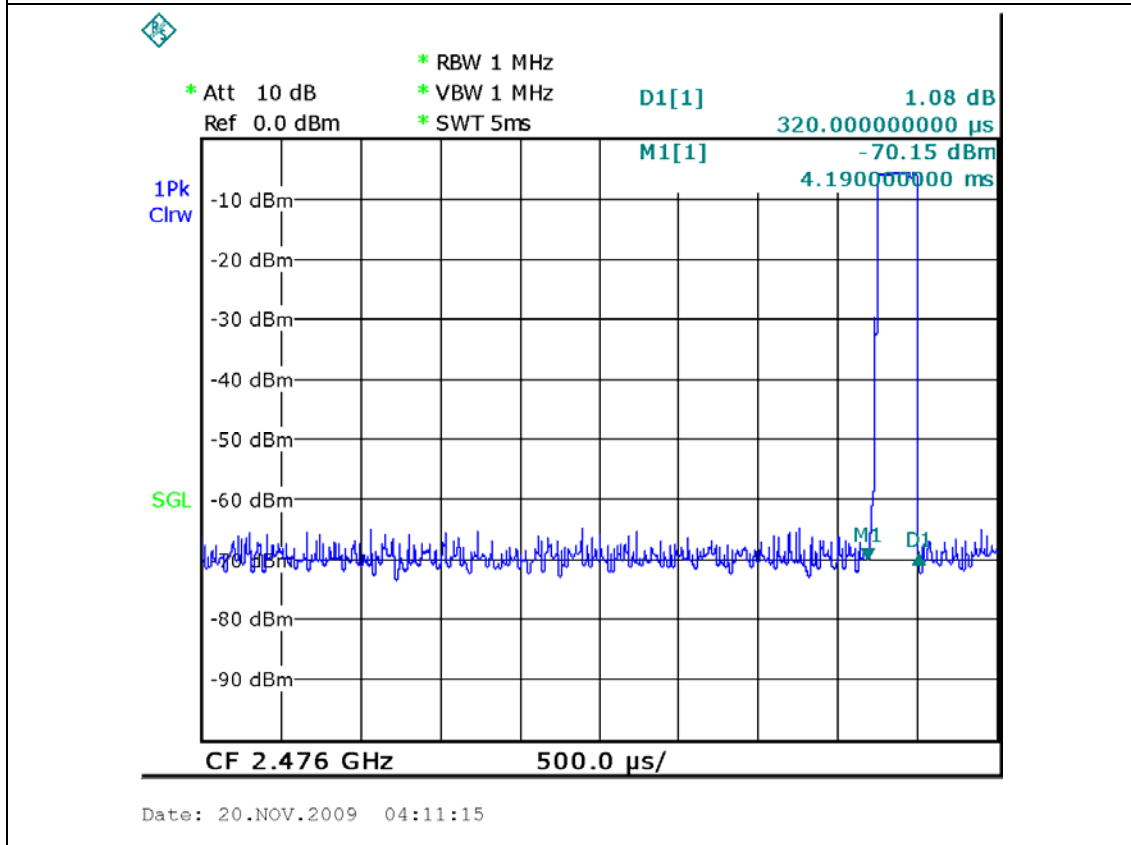

## 7. HOPPING CHANNEL SEPARATION MEASUREMENT

### 7.1 APPLIED PROCEDURES / LIMIT

Frequency hopping systems operating in the 2400-2483.5 MHz band may have hopping channel carrier frequencies that are separated by 25 kHz or two-thirds of the 20 dB bandwidth of the hopping channel, whichever is greater.

#### 7.1.1 MEASUREMENT INSTRUMENTS LIST AND SETTING

Item	Kind of Equipment	Manufacturer	Type No.	Serial No.	Calibrated until
1	Spectrum Analyzer	R&S	FSP_40	100129	Jan. 06, 2010

Remark: " N/A" denotes No Model Name , Serial No. or No Calibration specified.

Spectrum Parameter	Setting
Attenuation	Auto
Span Frequency	> Measurement Bandwidth or Channel Separation
RB	30 kHz (20dB Bandwidth) / 100 kHz (Channel Separation)
VB	100 kHz (20dB Bandwidth) / 300 kHz (Channel Separation)
Detector	Peak
Trace	Max Hold
Sweep Time	Auto

#### 7.1.2 TEST PROCEDURE

- The transmitter output (antenna port) was connected to the spectrum analyser in peak hold mode.
- The resolution bandwidth of 30 kHz and the video bandwidth of 100 kHz were utilised for 20 dB bandwidth measurement.
- The resolution bandwidth of 100 kHz and the video bandwidth of 300 kHz were utilised for channel separation measurement.

#### 7.1.3 DEVIATION FROM STANDARD

No deviation.

#### 7.1.4 TEST SETUP

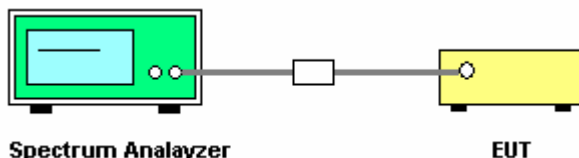

#### 7.1.5 EUT OPERATION CONDITIONS

The EUT was programmed to be in continuously transmitting mode.



**7.1.6 TEST RESULTS**

EUT :	2.4G WIRELESS KEYBOARD	Model Name :	DK-9023RL
Temperature :	25 °C	Relative Humidity :	60%
Pressure :	1012 hPa	Test Voltage :	DC 3.0V
Test Mode :	CH01 / CH48 / CH64		

Frequency	Ch. Separation (MHz)	20d Bandwidth B (MHz)	Result
2405 MHz	1	0.560	<b>Complies</b>
2439 MHz	1	0.570	<b>Complies</b>
2476 MHz	1	0.540	<b>Complies</b>

Ch. Separation Limits: >20dB bandwidth or >2/3 of 20dB bandwidth

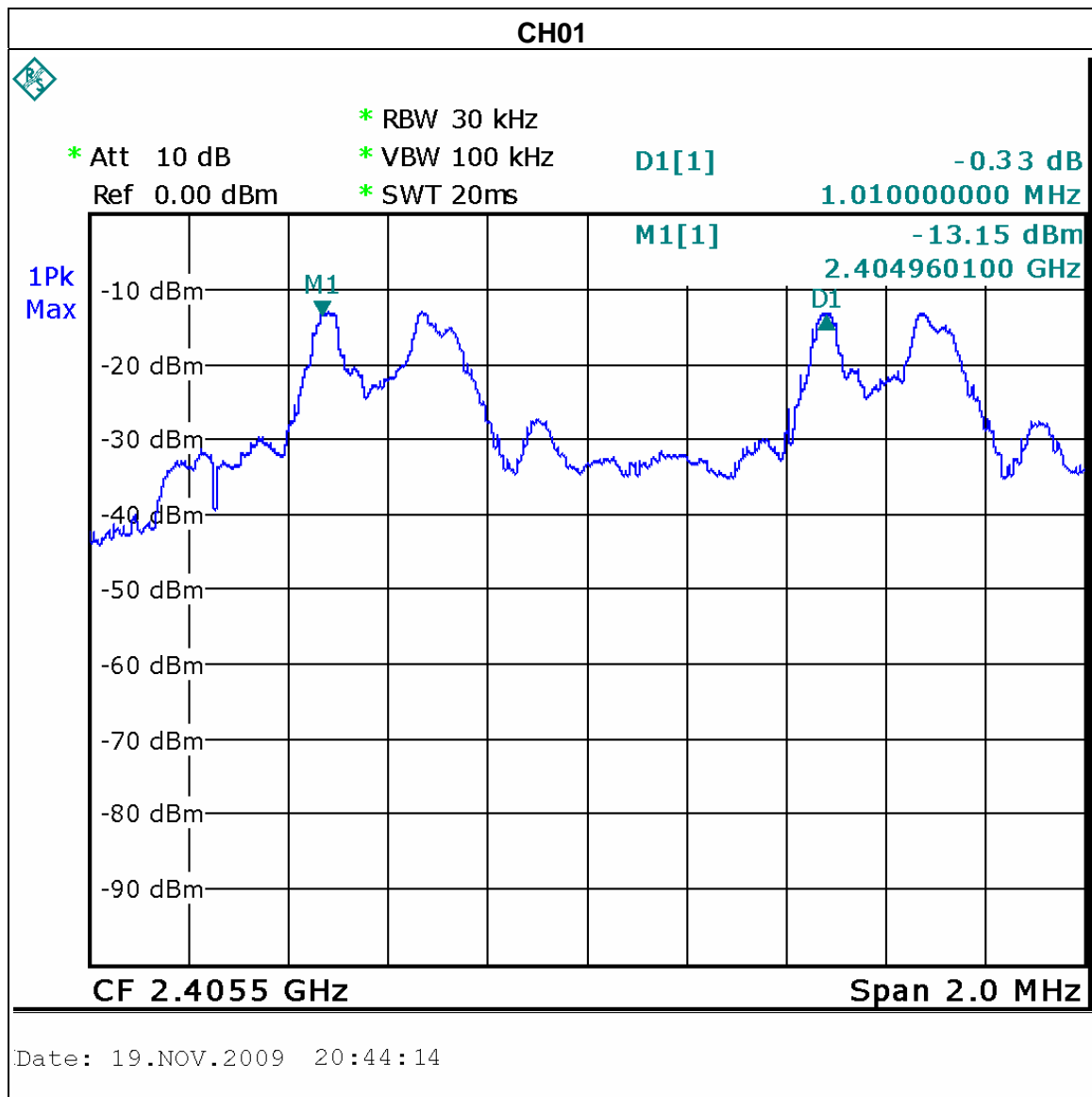



### CH48

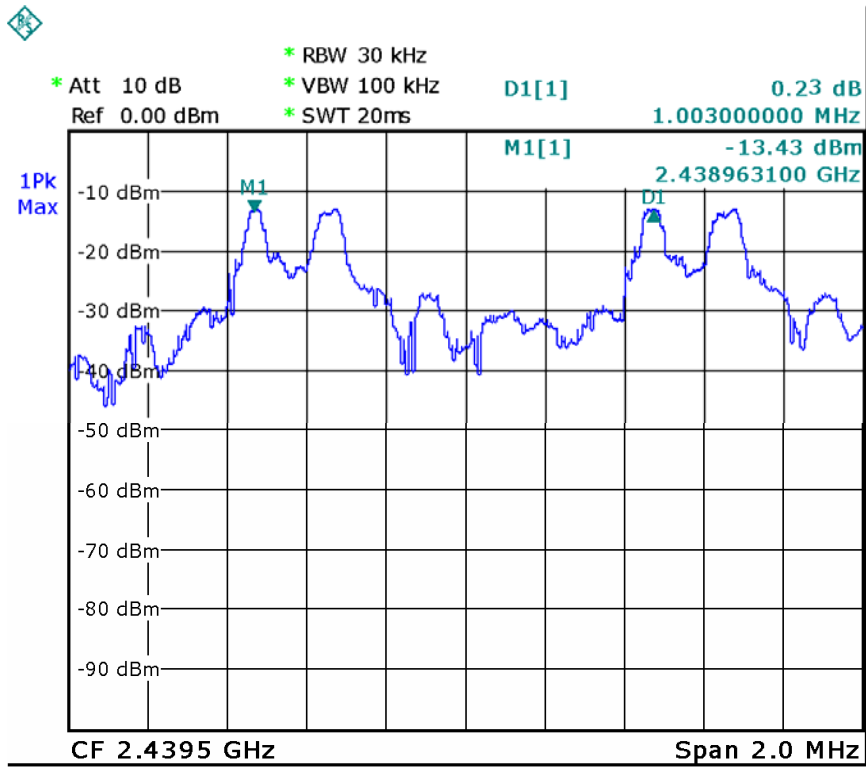

Date: 19.NOV.2009 20:09:20

### CH64

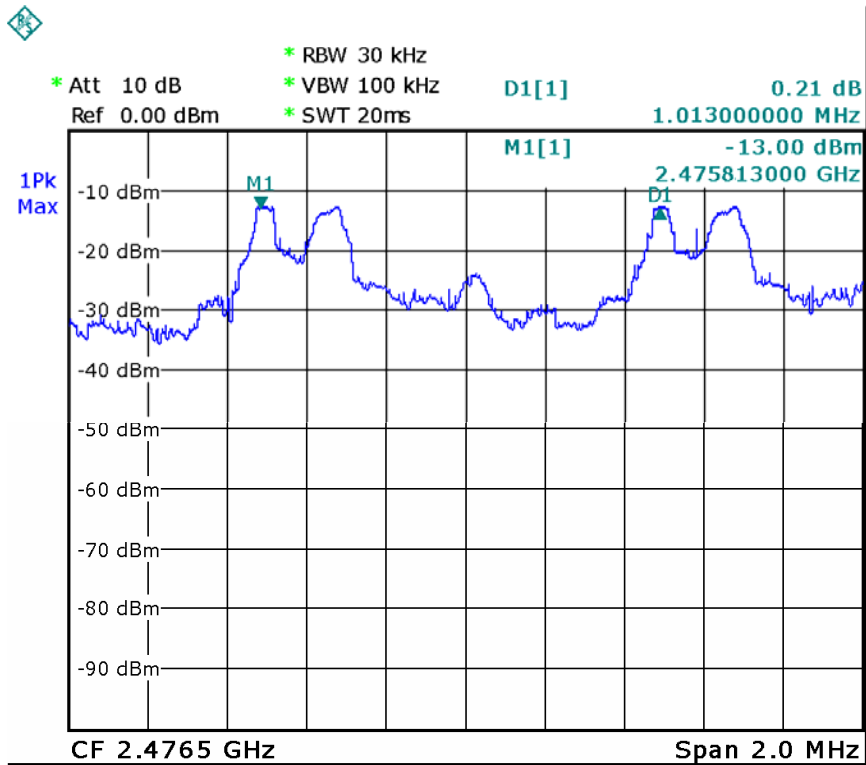

Date: 19.NOV.2009 20:43:09





**8. BANDWIDTH TEST**

**8.1 APPLIED PROCEDURES / LIMIT**

FCC Part15 (15.247) , Subpart C				
Section	Test Item	Limit	Frequency Range (MHz)	Result
15.247 (a)(2)	Bandwidth	<= 1 MHz (20dB bandwidth)	2400-2483.5	PASS

**8.1.1 MEASUREMENT INSTRUMENTS LIST AND SETTING**

Item	Kind of Equipment	Manufacturer	Type No.	Serial No.	Calibrated until
1	Spectrum Analyzer	R&S	FSP_40	100129	Jan. 06, 2010

Remark: " N/A" denotes No Model Name , Serial No. or No Calibration specified.

Spectrum Parameter	Setting
Attenuation	Auto
Span Frequency	> Measurement Bandwidth or Channel Separation
RB	30 kHz (20dB Bandwidth) / 100 kHz (Channel Separation)
VB	100 kHz (20dB Bandwidth) / 300 kHz (Channel Separation)
Detector	Peak
Trace	Max Hold
Sweep Time	Auto

**8.1.2 TEST PROCEDURE**

- a. The EUT was directly connected to the spectrum analyzer and antenna output port as show in the block diagram below,
- b. Spectrum Setting : RBW= 10KHz, VBW=100KHz, Sweep time = Auto.

**8.1.3 DEVIATION FROM STANDARD**

No deviation.

**8.1.4 TEST SETUP**



**8.1.5 EUT OPERATION CONDITIONS**

The EUT tested system was configured as the statements of 4.1.6 Unless otherwise a special operating condition is specified in the follows during the testing.



**8.1.6 TEST RESULTS**

EUT :	2.4G WIRELESS KEYBOARD	Model Name :	DK-9023RL
Temperature :	25 °C	Relative Humidity :	60%
Pressure :	1012 hPa	Test Voltage :	DC 3.0V
Test Mode :	CH01 / CH48 /CH64		

Frequency	20dB Bandwidth (MHz)	Channel Separation (MHz)	Result
2405 MHz	0.560	<= 1MHz	<b>PASS</b>
2439 MHz	0.570	<= 1MHz	<b>PASS</b>
2476 MHz	0.540	<= 1MHz	<b>PASS</b>

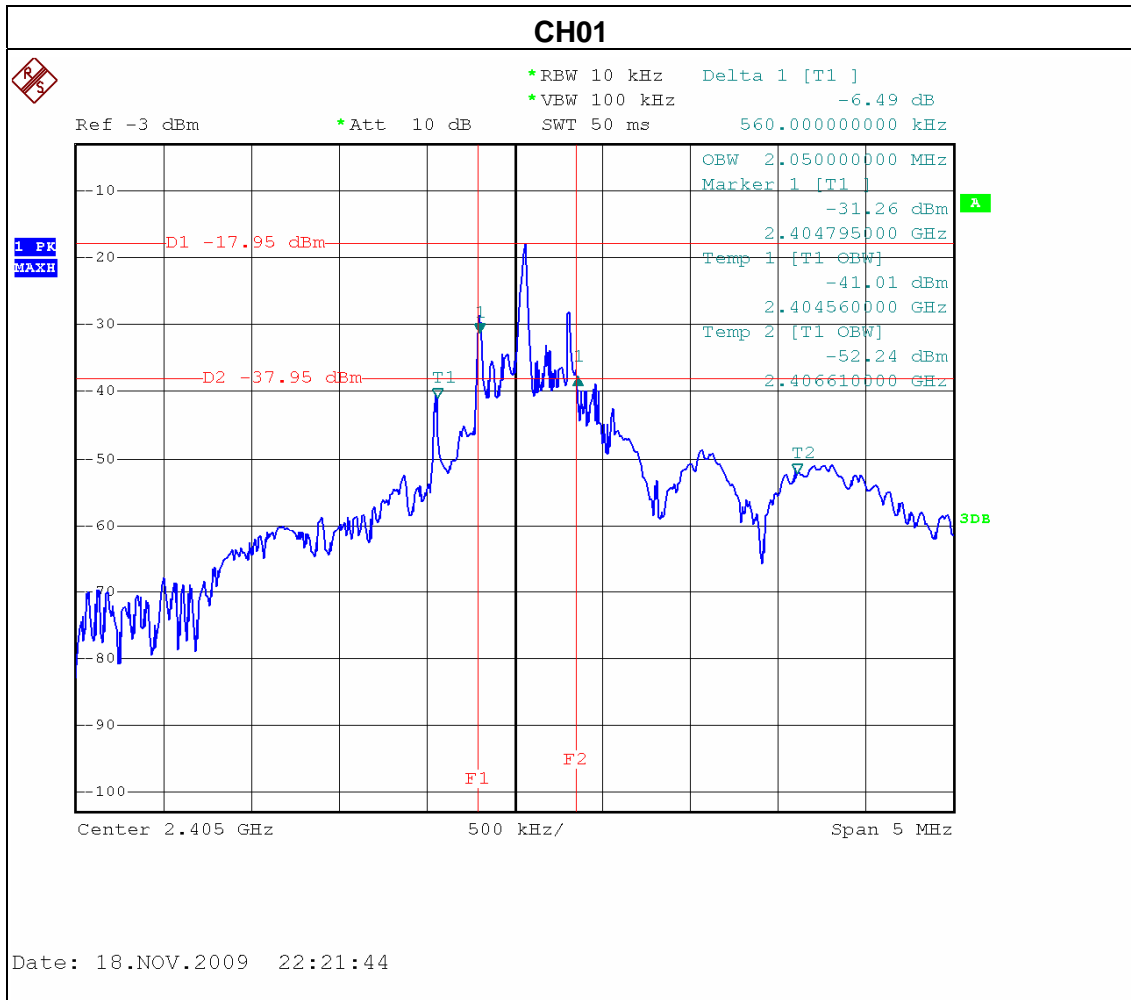

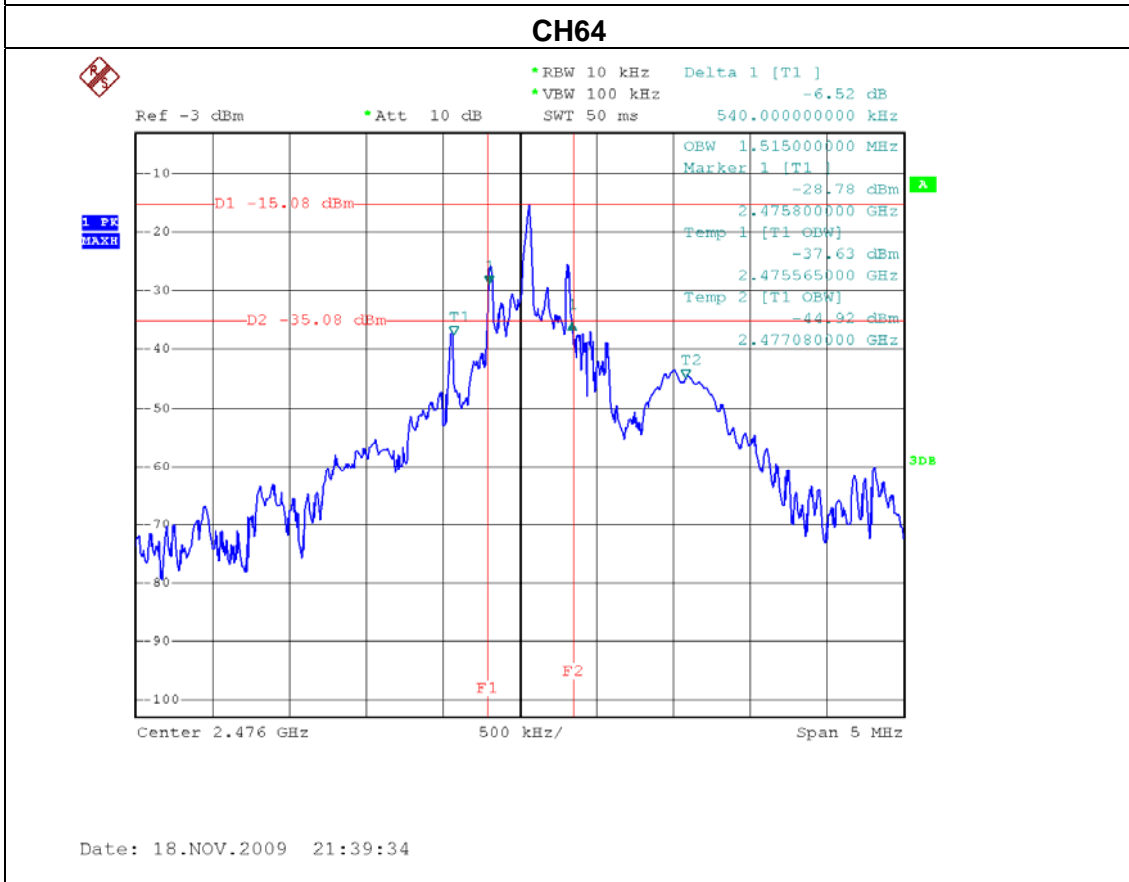
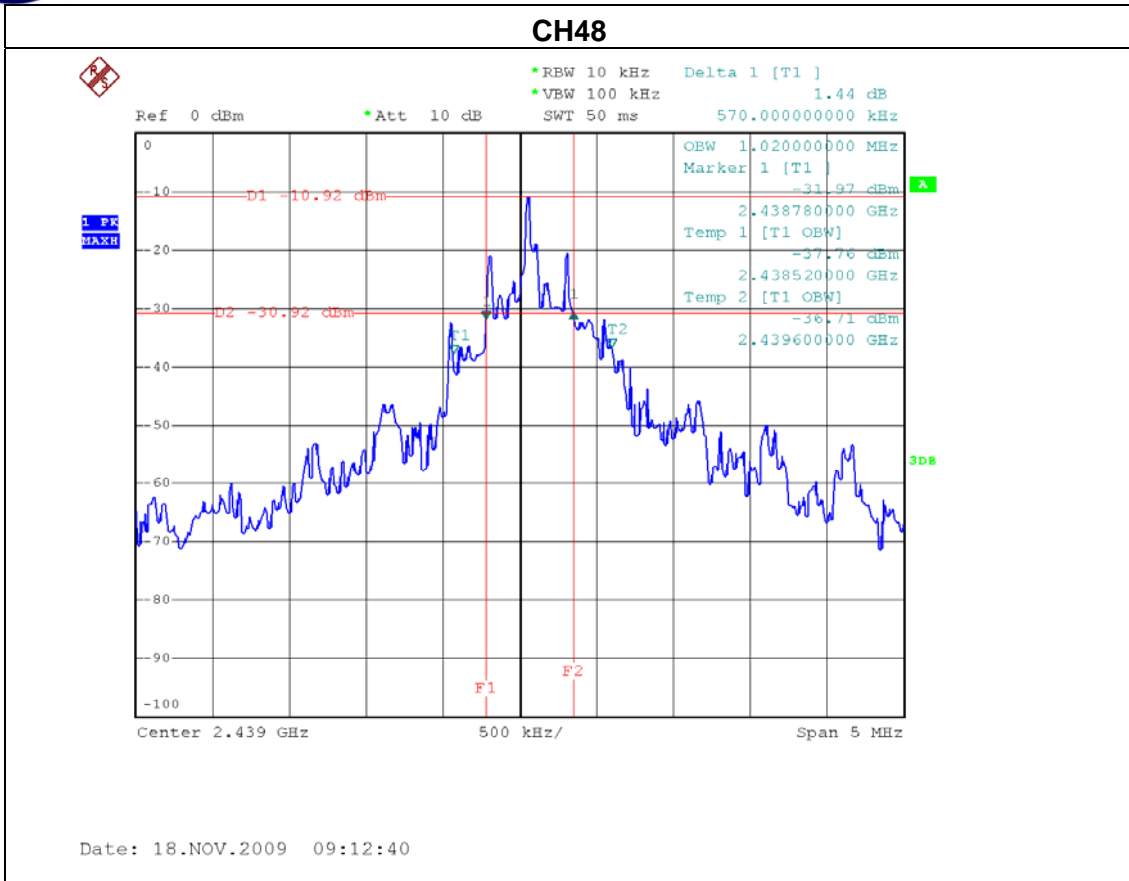



**9. PEAK OUTPUT POWER TEST**

**9.1 APPLIED PROCEDURES / LIMIT**

FCC Part15 (15.247) , Subpart C				
Section	Test Item	Limit	Frequency Range (MHz)	Result
15.247 (b)(1)	Peak Output Power	1 watt or 30dBm	2400-2483.5	PASS

**9.1.1 MEASUREMENT INSTRUMENTS LIST AND SETTING**

Item	Kind of Equipment	Manufacturer	Type No.	Serial No.	Calibrated until
1	Spectrum Analyzer	R&S	FSP_40	100129	Jan. 06, 2010

Remark: " N/A" denotes No Model Name , Serial No. or No Calibration specified.

**9.1.2 TEST PROCEDURE**

- a. The EUT was directly connected to the spectrum analyzer and antenna output port as show in the block diagram below,
- b. Spectrum Setting : RBW= 1MHz, VBW= 1MHz, Sweep time = Auto.

**9.1.3 DEVIATION FROM STANDARD**

No deviation.

**9.1.4 TEST SETUP**



**9.1.5 EUT OPERATION CONDITIONS**

The EUT tested system was configured as the statements of 4.1.6 Unless otherwise a special operating condition is specified in the follows during the testing.



**9.1.6 TEST RESULTS**

EUT :	2.4G WIRELESS KEYBOARD	Model Name :	DK-9023RL
Temperature :	25 °C	Relative Humidity :	60%
Pressure :	1012 hPa	Test Voltage :	DC 3.0V
Test Mode :	CH01/ CH48 /CH64		

Test Channel	Frequency (MHz)	Peak Output Power (dBm)	LIMIT (dBm)	LIMIT (W)
CH01	2405	-17.79	30	1
CH48	2439	-16.67	30	1
CH64	2476	-14.86	30	1

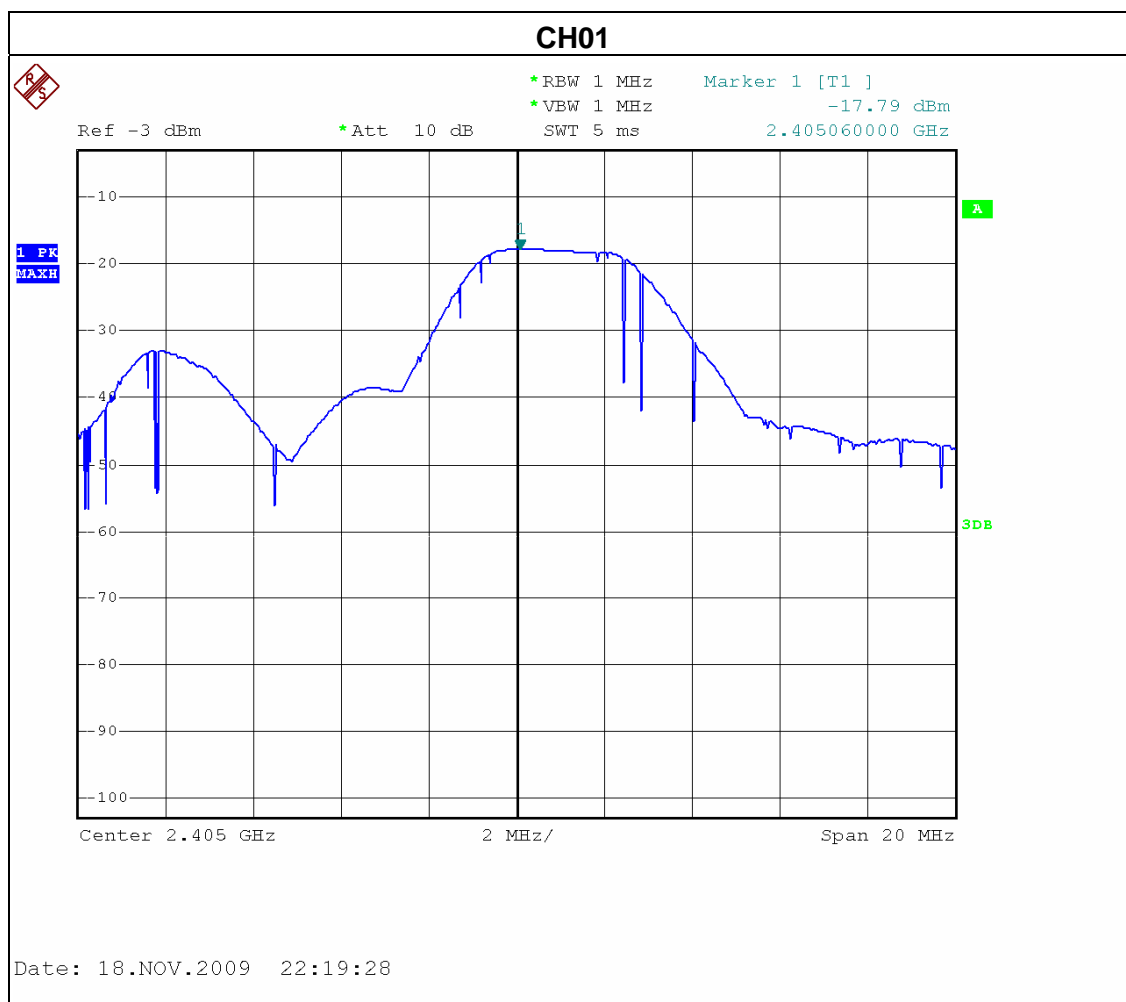



### CH48

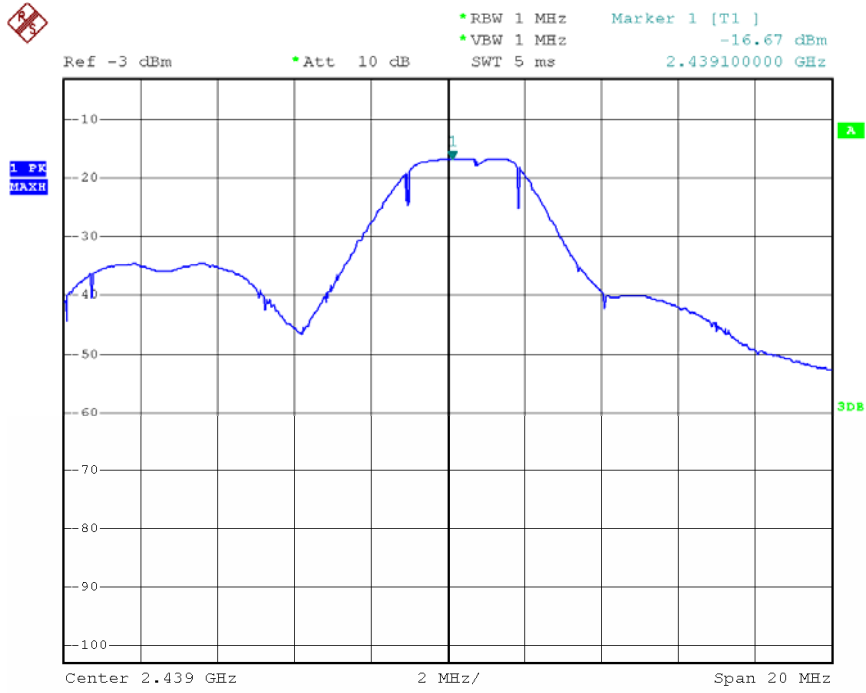

Date: 18.NOV.2009 22:13:13

### CH64

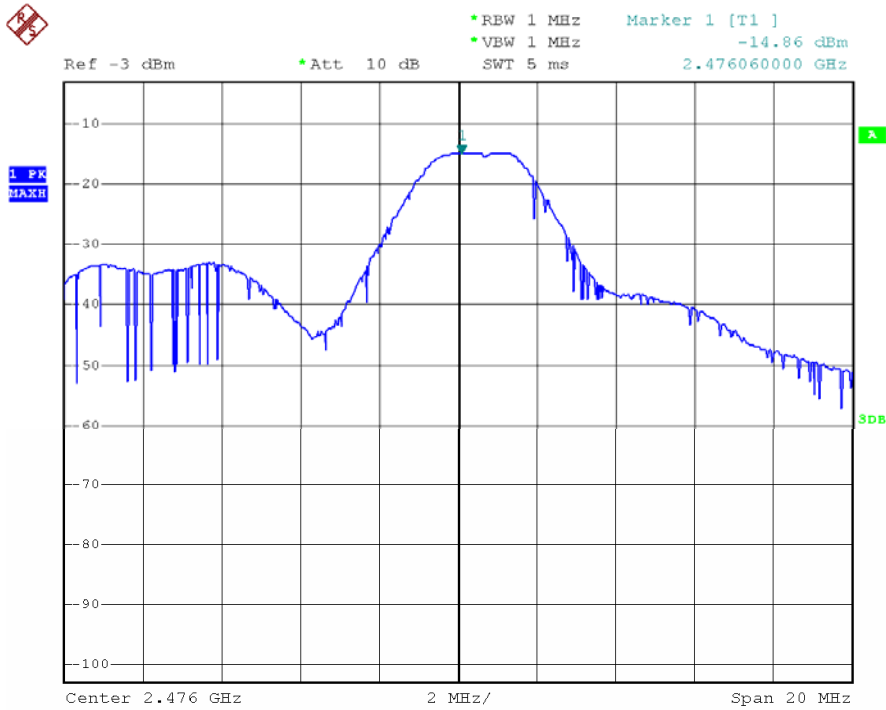

Date: 18.NOV.2009 21:36:54



**10. ANTENNA CONDUCTED SPURIOUS EMISSION**

**10.1 APPLIED PROCEDURES / LIMIT**

20dBc in any 100 kHz bandwidth outside the operating frequency band. In case the emission fall within the restricted band specified on 15.205(a), then the 15.209(a) limit in the table below has to be followed.

Frequencies (MHz)	Field Strength (micorvolts/meter)	Measurement Distance (meters)
0.009~0.490	2400/F(KHz)	300
0.490~1.705	24000/F(KHz)	30
1.705~30.0	30	30
30~88	100	3
88~216	150	3
216~960	200	3
Above 960	500	3

**10.1.1 MEASUREMENT INSTRUMENTS LIST AND SETTING**

Item	Kind of Equipment	Manufacturer	Type No.	Serial No.	Calibrated until
1	Spectrum Analyzer	R&S	FSP_40	100129	Jan. 06, 2010

Remark: " N/A" denotes No Model Name , Serial No. or No Calibration specified.

The following table is the setting of the spectrum analyzer.

Spectrum Parameter	Setting
Attenuation	Auto
Span Frequency	100 MHz
RB / VB (emission in restricted band)	1MHz / 1MHz for Peak, 1 MHz / 10Hz for Average
RB / VB (other emission)	100 KHz /100 KHz for Peak

**10.1.2 TEST PROCEDURE**

- a. The EUT was directly connected to the spectrum analyzer and antenna output port as show in the block diagram below,
- b. Spectrum Setting : RBW= 100KHz, VBW=100KHz, Sweep time = Auto.

**10.1.3 DEVIATION FROM STANDARD**

No deviation.



**10.1.4 TEST SETUP**

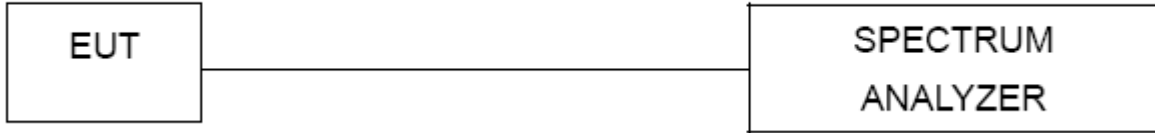

**10.1.5 EUT OPERATION CONDITIONS**

The EUT tested system was configured as the statements of 4.1.6 Unless otherwise a special operating condition is specified in the follows during the testing.





**10.1.6 TEST RESULTS**

EUT :	2.4G WIRELESS KEYBOARD	Model Name :	DK-9023RL
Temperature :	25 °C	Relative Humidity :	60%
Pressure :	1012 hPa	Test Voltage :	DC 3.0V
Test Mode :	CH01 / CH64		

The max. radio frequency power in any 100kHz bandwidth outside the frequency band		The max. radio frequency power in any 100 kHz bandwidth within the frequency band.	
FREQUENCY(MHz)	POWER(dBm)	FREQUENCY(MHz)	POWER(dBm)
2351.20	-55.35	2483.50	-63.44

**Result**

In any 100kHz bandwidth outside the frequency band, the radio frequency power is at least 20dB below that in the 100kHz bandwidth within the band that contains the highest level of the desired power.



### CH01 (Lower)

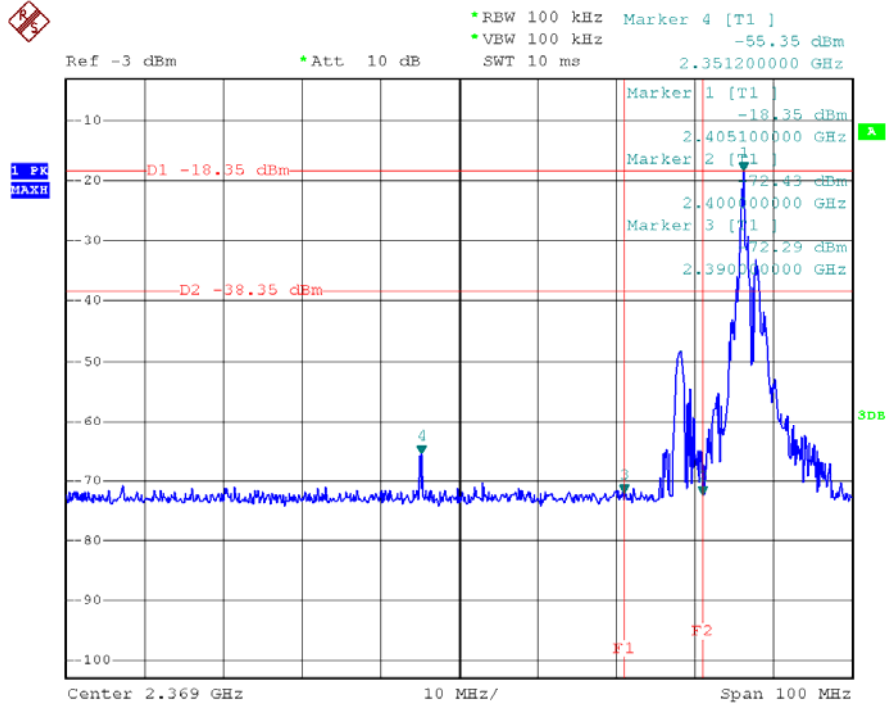

Date: 18.NOV.2009 22:29:45

### CH 78 (Upper)

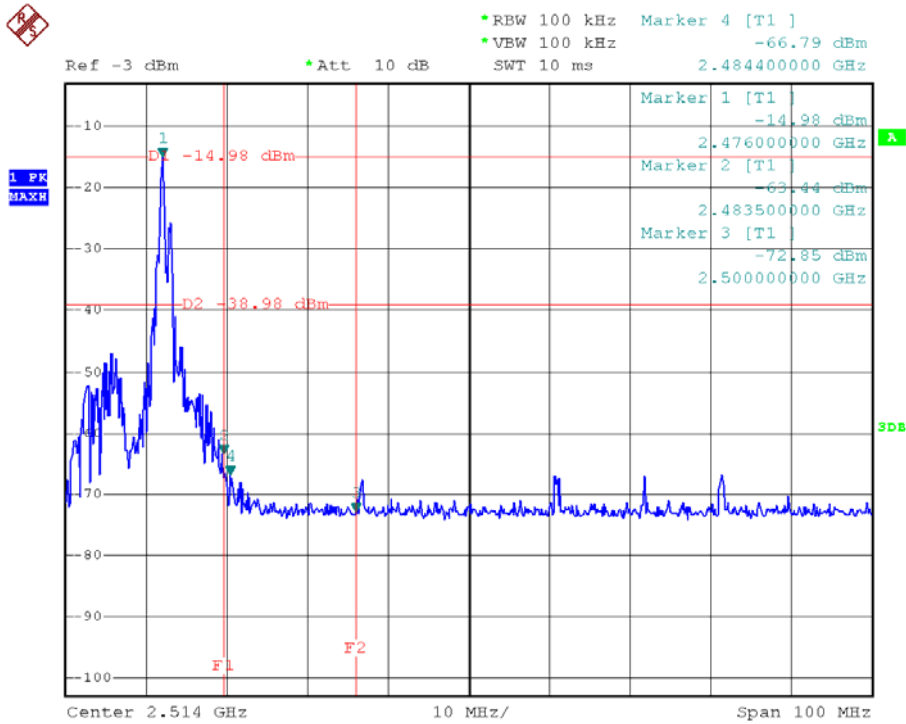

Date: 18.NOV.2009 21:45:16



**11. RF EXPOSURE TEST**

**11.1 APPLIED PROCEDURES / LIMIT**

These devices are not exempted from compliance does not exceed the Commission’s RF exposure guidelines. Unless a device operates at substantially low power levels, with a low gain antenna(s), supporting information is generally needed to establish the various potential operating configurations and exposure conditions of a transmitter and its antenna(s) in order to determine compliance with the RF exposure guidelines.

In order to demonstrate compliance with MPE requirement (see Section 2.1091), the following information is typically needed:

Calculation that estimates the minimum separation distance (20 cm or more) between an antenna and persons required to satisfy power density limits defined for free space.

Antenna installation and device operating instructions for installers (professional/unskilled users), and the parties responsible for ensuring compliance with the RF exposure requirement Any caution statements and/or warning labels that are necessary in order to comply with the exposure limits Any other RF exposure related issues that may affect MPE compliance.

FCC 1.1310: The criteria listed in the following table shall be used to evaluate the environmental impact of human exposure to radio-frequency (RF) radiation as specified in 1.1307(b).

(A) Limits for Occupational / Controlled Exposure

Frequency Range (MHz)	Electric Field Strength (E) (V/m)	Magnetic Field Strength (H) (A/m)	Power Density (S) (mW/ cm <sup>2</sup> )	Averaging Time  E  <sup>2</sup> ,  H  <sup>2</sup> or S (minutes)
0.3-3.0	614	1.63	(100)*	6
3.0-30	1842 / f	4.89 / f	(900 / f)*	6
30-300	61.4	0.163	1.0	6
300-1500			F/300	6
1500-100,000			5	6

(B) Limits for General Population / Uncontrolled Exposure

Frequency Range (MHz)	Electric Field Strength (E) (V/m)	Magnetic Field Strength (H) (A/m)	Power Density (S) (mW/ cm <sup>2</sup> )	Averaging Time  E  <sup>2</sup> ,  H  <sup>2</sup> or S (minutes)
0.3-1.34	614	1.63	(100)*	30
1.34-30	824/f	2.19/f	(180/f)*	30
30-300	27.5	0.073	0.2	30
300-1500			F/1500	30
1500-100,000			1.0	30

Note: f = frequency in MHz ; \*Plane-wave equivalent power density

**11.1.1 MEASUREMENT INSTRUMENTS LIST**

Item	Kind of Equipment	Manufacturer	Type No.	Serial No.	Calibrated until
1	Spectrum Analyzer	R&S	FSP_40	100129	Jan. 06, 2010

Remark: " N/A" denotes No Model Name , Serial No. or No Calibration specified.



### 11.1.2 MPE CALCULATION METHOD

Calculation Method of RF Safety Distance:

$$S = \frac{PG}{4\pi r^2} = \frac{EIRP}{4\pi r^2}$$

P :power input to the antenna in Mw

EIRP :Equivalent(effective) isotropic radiated power.

S :power density mW/ cm<sup>2</sup>

G :numeric gain of antenna relative to isotropic radiator

R :distance to centre of radiation in cm

FCC radio frequency exposure limits may be exceeded at distances closer than r cm from the antenna of this device

$$r = \sqrt{\frac{PG}{4\pi S}} = \sqrt{\frac{EIRP}{4\pi S}}$$

Note:

1. s=1.0 mW /cm<sup>2</sup> for limits for General Population/Uncontrolled Exposures.
  2. The time averaged power over 30 minutes will be equaled Output Power.
  3. Minimum calculated separation distance between antenna and persons required:0.53 cm
  4. The Power Density at a distance of 20cm calculated from the formula is far below the limit of 1MW/ cm<sup>2</sup>
  5. For portable device,the power limit is 60/f(in GHz) mW
  6. For limit 60/f is equal:  
60/2.402=24.98mW  
60/2.441=24.58 mW  
60/2.480=24.19mW
  7. The max.output power E.I.R.P is 0.0327 mW
- So it is complied with the limit,SAR report is not required.



**11.1.3 DEVIATION FROM STANDARD**

No deviation.

**11.1.4 TEST SETUP**



**11.1.5 EUT OPERATION CONDITIONS**

The EUT tested system was configured as the statements of 4.1.6 Unless otherwise a special operating condition is specified in the follows during the testing.



**11.1.6 TEST RESULTS**

EUT :	2.4G WIRELESS KEYBOARD	Model Name :	DK-9023RL
Temperature :	25 °C	Relative Humidity :	60%
Pressure :	1012 hPa	Test Voltage :	DC 3.0V
Test Mode :	CH01 (2405 MHz), CH48(2439 MHz), <b>CH64 (2476 MHz)</b>		

Frequency (MHz)	Antenna Gain (dBi)	Peak Output Power (dBm)	Calculated EIRP (mW)	Power Density (S) (mW/cm <sup>2</sup> )	FCC Threshold (mW)	Test Result
2405	0.59	-17.79	0.0166	0.00000379	24.98	Complies
2439	0.59	-16.67	0.0215	0.00000491	24.58	Complies
<b>2476</b>	<b>0.59</b>	<b>-14.86</b>	<b>0.0327</b>	<b>0.00000745</b>	<b>24.19</b>	<b>Complies</b>



**12. EUT TEST PHOTO**

**Radiated Measurement Photos**

