

## TEST REPORT



|            |   |
|------------|---|
| Applicant: | ACE BAYOU CORP.   |
| Address:   | 3700 Desire Parkway, New Orleans, LA 70126, United States |

|                                     |   |
|-------------------------------------|---|
| Manufacturer or Supplier            | ACE BAYOU CORP.   |
| Address                             | 3700 Desire Parkway, New Orleans, LA 70126, United States |
| Product:                            | X Rocker Chair  |
| Brand Name:                         | X rocker  |
| Model:                              | DACTL   |
| Additional Model & Model Difference | 51XXXXX/07XXXXX(X=0~9), See section 3.1                   |
| Date of tests:                      | May 30, 2023 ~ Jul. 06, 2023                              |

the tests have been carried out according to the requirements of the following standard:

**FCC Part 15, Subpart C, Section 15.249**

**CONCLUSION: The submitted sample was found to COMPLY with the test requirement**

|   |  |
|---|--|
| Tested by Niko Zhang<br>Project Engineer / EMC Department                           | Approved by Glyn He<br>Assistant Manager / EMC Department                            |
|  |  |
|   | Date: Jul. 19, 2023  |

This report is governed by, and incorporates by reference, the Conditions of Testing as posted at the date of issuance of this report at <http://www.bureauveritas.com/home/about-us/our-business/cps/about-us/terms-conditions/> and is intended for your exclusive use. Any copying or replication of this report to or for any other person or entity, or use of our name or trademark, is permitted only with our prior written permission. This report sets forth our findings solely with respect to the test samples identified herein. The results set forth in this report are not indicative or representative of the quality or characteristics of the lot from which a test sample was taken or any similar or identical product unless specifically and expressly noted. Our report includes all of the tests requested by you and the results thereof based upon the information that you provided to us. Measurement uncertainty is only provided upon request for accredited tests. Statements of conformity are based on simple acceptance criteria without taking measurement uncertainty into account, unless otherwise requested in writing. You have 60 days from date of issuance of this report to notify us of any material error or omission caused by our negligence or if you require measurement uncertainty; provided, however, that such notice shall be in writing and shall specifically address the issue you wish to raise. A failure to raise such issue within the prescribed time shall constitute your unqualified acceptance of the completeness of this report, the tests conducted and the correctness of the report contents.

## TABLE OF CONTENTS

|  |           |
|--|-----------|
| <b>RELEASE CONTROL RECORD .....</b>                  | <b>4</b>  |
| <b>1 SUMMARY OF TEST RESULTS.....</b>                | <b>5</b>  |
| <b>2 MEASUREMENT UNCERTAINTY .....</b>               | <b>5</b>  |
| <b>3 GENERAL INFORMATION .....</b>                   | <b>6</b>  |
| 3.1 GENERAL DESCRIPTION OF EUT.....                  | 6         |
| 3.2 DESCRIPTION OF TEST MODES.....                   | 7         |
| 3.3 GENERAL DESCRIPTION OF APPLIED STANDARDS.....    | 8         |
| 3.4 DESCRIPTION OF SUPPORT UNITS.....                | 8         |
| 3.5 CONFIGURATION OF SYSTEM UNDER TEST.....          | 8         |
| 3.6 DUTY CYCLE OF TESET SIGNAL .....                 | 9         |
| <b>4. TEST TYPES AND RESULTS.....</b>                | <b>10</b> |
| 4.1 CONDUCTED EMISSION MEASUREMENT .....             | 10        |
| 4.1.1 LIMITS OF CONDUCTED EMISSION MEASUREMENT ..... | 10        |
| 4.1.2 TEST INSTRUMENTS.....                          | 10        |
| 4.1.3 TEST PROCEDURES .....                          | 11        |
| 4.1.4 DEVIATION FROM TEST STANDARD .....             | 11        |
| 4.1.5 TEST SETUP.....                                | 12        |
| 4.1.6 EUT OPERATING CONDITIONS .....                 | 12        |
| 4.1.7 TEST RESULTS .....                             | 13        |
| 4.2 RADIATED EMISSION MEASUREMENT .....              | 15        |
| 4.2.1 LIMITS OF RADIATED EMISSION MEASUREMENT .....  | 15        |
| 4.2.2 TEST INSTRUMENTS.....                          | 16        |
| 4.2.3 TEST PROCEDURES .....                          | 17        |
| 4.2.4 DEVIATION FROM TEST STANDARD .....             | 17        |
| 4.2.5 TEST SETUP.....                                | 18        |
| 4.2.6 EUT OPERATING CONDITIONS .....                 | 19        |
| 4.2.7 TEST RESULTS .....                             | 20        |
| 4.3 20DB BANDWIDTH MEASUREMENT.....                  | 35        |
| 4.3.1 LIMITS OF 20DB BANDWIDTH MEASUREMENT .....     | 35        |
| 4.3.2 TEST INSTRUMENTS .....                         | 35        |
| 4.3.3 TEST PROCEDURE .....                           | 36        |
| 4.3.4 DEVIATION FROM TEST STANDARD .....             | 36        |
| 4.3.5 TEST SETUP .....                               | 36        |
| 4.3.6 EUT OPERATING CONDITIONS.....                  | 36        |



**BUREAU  
VERITAS**

**Test Report No.: RF2305WDG0208-2**

|       |   |    |
|-------|---|----|
| 4.3.7 | TEST RESULTS .....  | 37 |
| 5.    | PHOTOGRAPHS OF THE TEST CONFIGURATION .....   | 39 |
| 6.    | APPENDIX A - MODIFICATIONS RECORDERS FOR ENGINEERING CHANGES TO THE<br>EUT BY THE LAB ..... | 40 |



Test Report No.: RF2305WDG0208-2

## RELEASE CONTROL RECORD

| ISSUE NO.       | REASON FOR CHANGE | DATE ISSUED   |
|-----------------|-------------------|---------------|
| RF2305WDG0208-2 | Original release  | Jul. 19, 2023 |

## 1 SUMMARY OF TEST RESULTS

The EUT has been tested according to the following specifications:

| APPLIED STANDARD: FCC PART 15, SUBPART C (SECTION 15.249) |                              |        |                              |
|---|------------------------------|--------|------------------------------|
| STANDARD SECTION  | TEST TYPE AND LIMIT          | RESULT | REMARK                       |
| §15.203   | Antenna Requirement          | PASS   | No antenna connector is used |
| §15.207 (a)   | Conducted Emission           | PASS   | Compliant                    |
| §15.205   | Restricted Band of Operation | PASS   | Compliant                    |
| §15.209<br>§15.249(a)                                     | Radiated Emission            | PASS   | Compliant                    |
| §15.215(c)  | 20dB Bandwidth Test          | PASS   | Compliant                    |

## 2 MEASUREMENT UNCERTAINTY

Where relevant, the following measurement uncertainty levels have been estimated for tests performed on the EUT as specified in CISPR 16-4-2:

| MEASUREMENT         | FREQUENCY     | UNCERTAINTY |
|---------------------|---------------|-------------|
| Conducted emissions | 9kHz~30MHz    | 2.68dB      |
| Radiated emissions  | 30MHz ~ 1GMHz | 4.24dB      |
|                     | 1GHz ~ 18GHz  | 4.76dB      |
|                     | 18GHz ~ 40GHz | 4.50dB      |

This uncertainty represents an expanded uncertainty expressed at approximately the 95% confidence level using a coverage factor of  $k = 2$ .

### 3 GENERAL INFORMATION

#### 3.1 GENERAL DESCRIPTION OF EUT

|                              |  |
|------------------------------|--|
| <b>PRODUCT</b>               | X Rocker Chair                         |
| <b>MODEL NO.</b>             | DACTL                                  |
| <b>ADDITIONAL MODEL</b>      | 51XXXXX/07XXXXX(X=0~9)                 |
| <b>FCC ID</b>                | XVMDACTL                               |
| <b>NOMINAL VOLTAGE</b>       | DC 5V From Adapter Input AC 120V/60Hz  |
| <b>MODULATION TECHNOLOGY</b> | FM                                     |
| <b>OPERATING FREQUENCY</b>   | 914MHz, 915MHz, 916MHz                 |
| <b>ANTENNA TYPE</b>          | PCB Antenna, with 2dBi gain            |
| <b>I/O PORTS</b>             | Refer to user's manual                 |
| <b>CABLE SUPPLIED</b>        | USB Line: Detachable, Unshielded, 0.8M |

**NOTES:**

1. For a more detailed features description, please refer to the manufacturer's specifications or the user's manual.
2. For the test results, the EUT had been tested with all conditions, but only the worst case was shown in test report.
3. Please refer to the EUT photo document (Reference No.: 2305WDG0208-2) for detailed product photo.
4. Additional models are identical with the test model DACTL except the model number for marketing purpose.

### 3.2 DESCRIPTION OF TEST MODES

Pre-Scan has been conducted to determine the worst-case mode from all possible combinations between available modulations, data rates, XYZ axis and packet type. The worst case was found when the EUT was positioned on X axis for radiated emission. The EUT was tested under the following mode.

| EUT CONFIGURE<br>MODE | APPLICABLE TO |       |     |    | DESCRIPTION                           |
|-----------------------|---------------|-------|-----|----|---------------------------------------|
|                       | RE<1G         | RE≥1G | PLC | BW |                                       |
| A                     | √             | √     | √   | √  | DC 5V from adapter input AC 120V 60Hz |

Where **RE<1G**: Radiated Emission below 1GHz      **RE≥1G**: Radiated Emission above 1GHz  
**PLC**: Power Line Conducted Emission      **BW**: 20db bandwidth

Following channel(s) was (were) selected for the test as listed below.

| TESTED CHANNEL | TESTED FREQUENCY |
|----------------|------------------|
| Low            | 914 MHz          |
| Middle         | 915 MHz          |
| High           | 916 MHz          |

### TEST CONDITION:

| APPLICABLE TO | ENVIRONMENTAL CONDITIONS | INPUT POWER                              | TESTED BY |
|---------------|--------------------------|--|-----------|
| RE            | 25deg. C, 55%RH          | DC 5V from adapter input<br>AC 120V 60Hz | Stalker   |
| BW            | 25deg. C, 55%RH          | DC 5V from adapter input<br>AC 120V 60Hz | Vincent   |
| PLC           | 25deg. C, 55%RH          | DC 5V from adapter input<br>AC 120V 60Hz | Summer    |

### 3.3 GENERAL DESCRIPTION OF APPLIED STANDARDS

The EUT is a RF Product. According to the specifications of the manufacturer, it must comply with the requirements of the following standards:

**FCC Part 15, Subpart C, Section 15.249**

**ANSI C63.10-2013**

All test items have been performed and recorded as per the above standards.

### 3.4 DESCRIPTION OF SUPPORT UNITS

The EUT has been tested as an independent unit together without any other necessary accessories or support units. The following support units or accessories were used to form a representative test configuration during the tests.

| NO. | PRODUCT | BRAND | MODEL NO.      | SERIAL NO. | FCC ID |
|-----|---------|-------|----------------|------------|--------|
| 1   | Adapter | N/A   | SSW-2680EU     | N/A        | N/A    |
| 2   | Adapter | N/A   | PSM05C-050V-RW | N/A        | N/A    |

| NO. | SIGNAL CABLE DESCRIPTION OF THE ABOVE SUPPORT UNITS |
|-----|---|
| 1-2 | N/A   |

### 3.5 CONFIGURATION OF SYSTEM UNDER TEST

RADIATED EMISSION TEST:

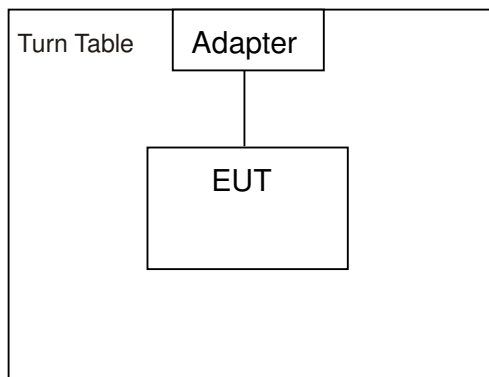

CONDUCTED EMISSION TEST:

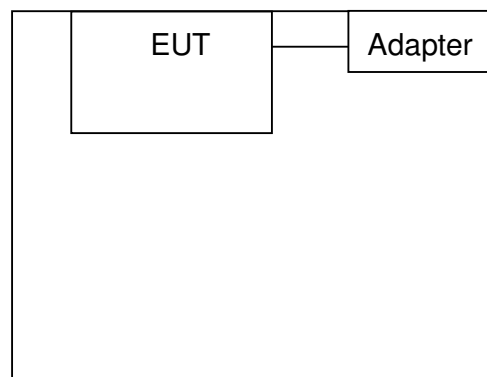





### 3.6 DUTY CYCLE OF TESET SIGNAL

| Test Mode | Packet Type | On Time (ms) | Period (ms) | Duty Cycle (%) | 1/T Min. VBW |
|-----------|-------------|--------------|-------------|----------------|--------------|
| FM        | FM          | -            | -           | 100            | 10Hz         |

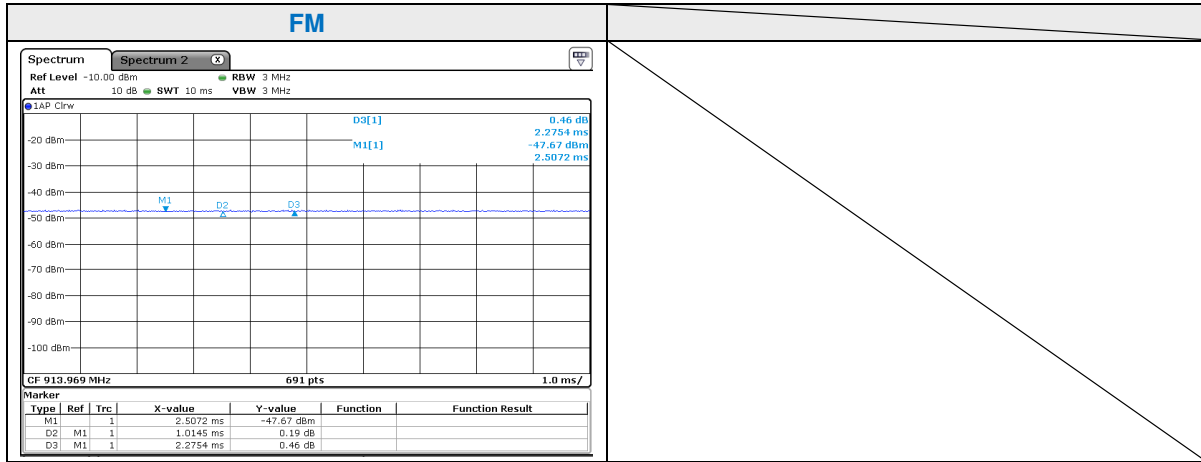

## 4. TEST TYPES AND RESULTS

### 4.1 CONDUCTED EMISSION MEASUREMENT

#### 4.1.1 LIMITS OF CONDUCTED EMISSION MEASUREMENT

| FREQUENCY OF EMISSION (MHz) | CONDUCTED LIMIT (dB $\mu$ V) |          |
|-----------------------------|------------------------------|----------|
|                             | Quasi-peak                   | Average  |
| 0.15 ~ 0.5                  | 66 to 56                     | 56 to 46 |
| 0.5 ~ 5                     | 56                           | 46       |
| 5 ~ 30                      | 60                           | 50       |

- NOTE:**
1. The lower limit shall apply at the transition frequencies.
  2. The limit decreases in line with the logarithm of the frequency in the range of 0.15 to 0.50MHz.
  3. All emanations from a class A/B digital device or system, including any network of conductors and apparatus connected thereto, shall not exceed the level of field strengths specified above.

#### 4.1.2 TEST INSTRUMENTS

| Equipment                | Manufacturer  | Model No.       | Serial No.  | Next Cal.   |
|--------------------------|---------------|-----------------|-------------|-------------|
| EMI Test Receiver        | Rohde&Schwarz | ESR7            | 101494      | Jan. 10, 24 |
| Artificial Mains Network | Rohde&Schwarz | ENV216          | 101173      | Jan. 11, 24 |
| Artificial Mains Network | Rohde&Schwarz | ESH3-Z5         | 100317      | Jan. 10, 24 |
| Voltage probe            | SCHWARZBECK   | TK 9421         | TK 9421-176 | Jul. 27, 23 |
| Test software            | ADT           | ADT_Cond_V7.3.7 | N/A         | N/A         |

**NOTES:**

1. The test was performed in shielded room 553.
2. The calibration interval of the above test instruments is 12 months. And the calibrations are traceable to CEPREI/CHINA, GRGT/CHINA and NIM/CHINA.

#### 4.1.3 TEST PROCEDURES

- a. The EUT was placed 0.4 meters from the conducting wall of the shielded room with EUT being connected to the power mains through a line impedance stabilization network (LISN). Other support units were connected to the power mains through another LISN. The two LISNs provide 50 ohm/ 50uH of coupling impedance for the measuring instrument.
- b. Both lines of the power mains connected to the EUT were checked for maximum conducted interference.
- c. The frequency range from 150kHz to 30MHz was searched. Emission levels under (Limit - 20dB) was not recorded.

**NOTE:** All modes of operation were investigated and the worst-case emissions are reported.

#### 4.1.4 DEVIATION FROM TEST STANDARD

No deviation.

#### 4.1.5 TEST SETUP

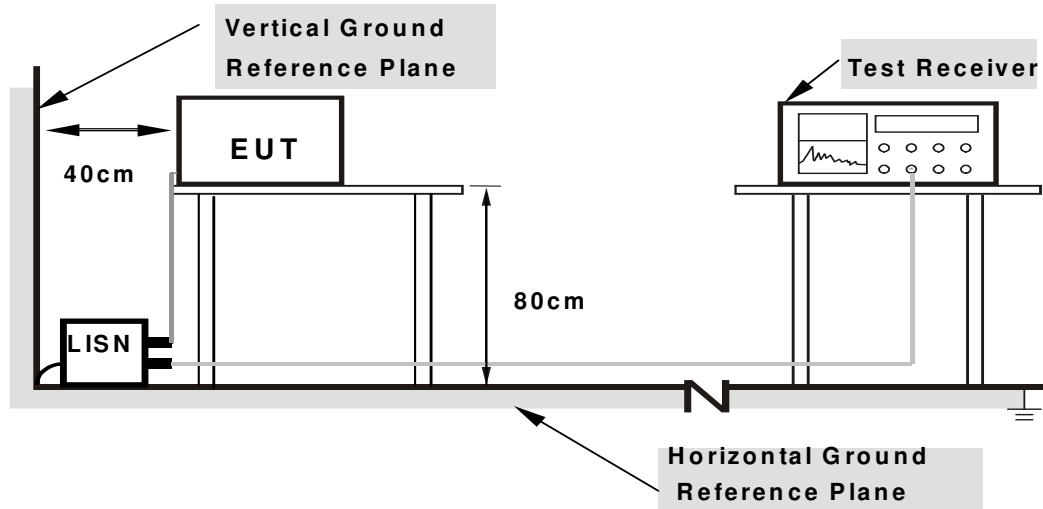

- Note: 1.Support units were connected to second LISN.**  
**2.Both of LISNs (AMN) are 80 cm from EUT and at least 80 cm from other units and other metal planes**

For the actual test configuration, please refer to the attached file (Test Setup Photo).

#### 4.1.6 EUT OPERATING CONDITIONS

- a. Turned on the power and connected of all equipment.
- b. EUT was operated according to the type used was description in manufacturer's specifications or the User's Manual.

### 4.1.7 TEST RESULTS

#### CONDUCTED WORST-CASE DATA:

|              |      |                      |      |
|--------------|------|----------------------|------|
| <b>PHASE</b> | Line | <b>6dB BANDWIDTH</b> | 9kHz |
|--------------|------|----------------------|------|

| No | Freq. [MHz] | Corr. Factor (dB) | Reading Value [dB (uV)] |       | Emission Level [dB (uV)] |       | Limit [dB (uV)] |       | Margin (dB) |        |
|----|-------------|-------------------|-------------------------|-------|--------------------------|-------|-----------------|-------|-------------|--------|
|    |             |                   | Q.P.                    | AV.   | Q.P.                     | AV.   | Q.P.            | AV.   | Q.P.        | AV.    |
| 1  | 0.51834     | 10.21             | 27.35                   | 21.47 | 37.56                    | 31.68 | 56.00           | 46.00 | -18.44      | -14.32 |
| 2  | 0.72103     | 10.24             | 17.41                   | 11.39 | 27.65                    | 21.63 | 56.00           | 46.00 | -28.35      | -24.37 |
| 3  | 1.21939     | 10.24             | 16.94                   | 11.50 | 27.18                    | 21.74 | 56.00           | 46.00 | -28.82      | -24.26 |
| 4  | 1.69350     | 10.25             | 17.47                   | 11.84 | 27.72                    | 22.09 | 56.00           | 46.00 | -28.28      | -23.91 |
| 5  | 3.63075     | 10.34             | 17.66                   | 12.60 | 28.00                    | 22.94 | 56.00           | 46.00 | -28.00      | -23.06 |
| 6  | 16.13175    | 10.79             | 18.61                   | 11.73 | 29.40                    | 22.52 | 60.00           | 50.00 | -30.60      | -27.48 |

- REMARKS:**
1. Q.P. and AV. are abbreviations of quasi-peak and average individually.
  2. "-": The Quasi-peak reading value also meets average limit and measurement with the average detector is unnecessary.
  3. The emission levels of other frequencies were very low against the limit.
  4. Margin value = Emission level - Limit value
  5. Correction factor = Insertion loss + Cable loss
  6. Emission Level = Correction Factor + Reading Value.

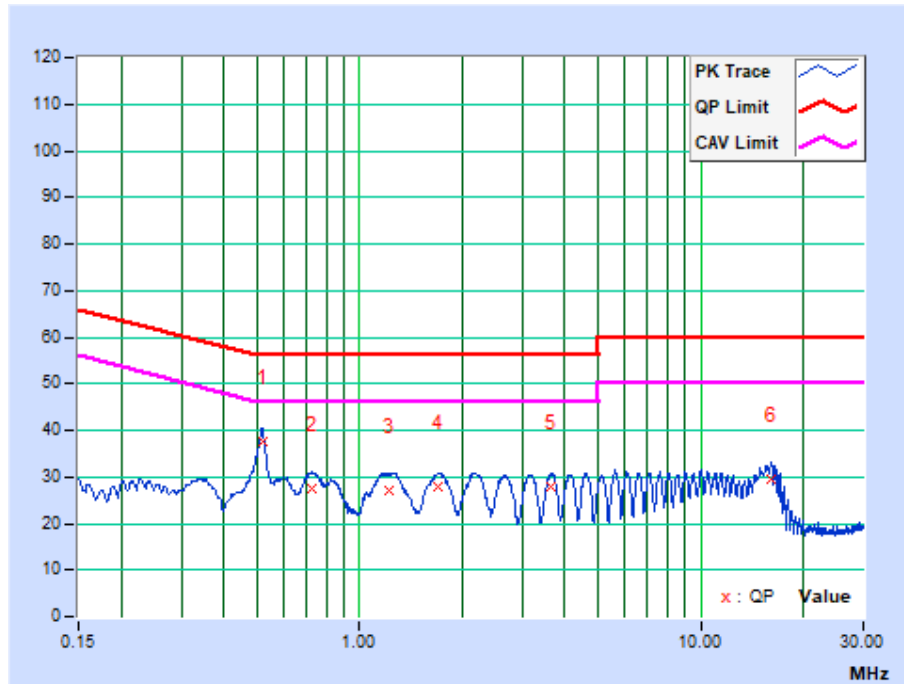

|              |         |                      |      |
|--------------|---------|----------------------|------|
| <b>PHASE</b> | Neutral | <b>6dB BANDWIDTH</b> | 9kHz |
|--------------|---------|----------------------|------|

| No | Freq. [MHz] | Corr. Factor (dB) | Reading Value [dB (uV)] |       | Emission Level [dB (uV)] |       | Limit [dB (uV)] |       | Margin (dB) |        |
|----|-------------|-------------------|-------------------------|-------|--------------------------|-------|-----------------|-------|-------------|--------|
|    |             |                   | Q.P.                    | AV.   | Q.P.                     | AV.   | Q.P.            | AV.   | Q.P.        | AV.    |
| 1  | 0.51900     | 10.17             | 23.33                   | 17.72 | 33.50                    | 27.89 | 56.00           | 46.00 | -22.50      | -18.11 |
| 2  | 0.71913     | 10.20             | 13.75                   | 8.29  | 23.95                    | 18.49 | 56.00           | 46.00 | -32.05      | -27.51 |
| 3  | 1.20022     | 10.21             | 14.45                   | 9.57  | 24.66                    | 19.78 | 56.00           | 46.00 | -31.34      | -26.22 |
| 4  | 2.14552     | 10.25             | 13.50                   | 8.55  | 23.75                    | 18.80 | 56.00           | 46.00 | -32.25      | -27.20 |
| 5  | 2.65650     | 10.28             | 11.79                   | 6.26  | 22.07                    | 16.54 | 56.00           | 46.00 | -33.93      | -29.46 |
| 6  | 16.02375    | 11.15             | 13.99                   | 1.97  | 25.14                    | 13.12 | 60.00           | 50.00 | -34.86      | -36.88 |

- REMARKS:**
1. Q.P. and AV. are abbreviations of quasi-peak and average individually.
  2. "-": The Quasi-peak reading value also meets average limit and measurement with the average detector is unnecessary.
  3. The emission levels of other frequencies were very low against the limit.
  4. Margin value = Emission level - Limit value
  5. Correction factor = Insertion loss + Cable loss
  6. Emission Level = Correction Factor + Reading Value.

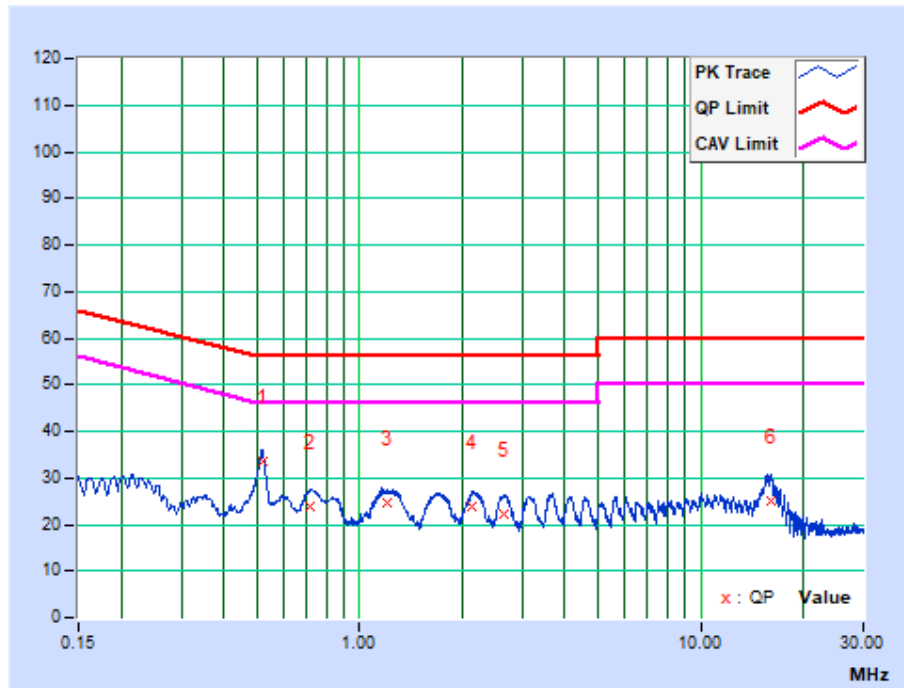

## 4.2 RADIATED EMISSION MEASUREMENT

### 4.2.1 LIMITS OF RADIATED EMISSION MEASUREMENT

Emissions radiated outside of the specified bands, shall be according to the general radiated limits in 15.209 as following:

| FREQUENCIES<br>(MHz) | FIELD STRENGTH<br>(microvolts/meter) | MEASUREMENT DISTANCE<br>(meters) |
|----------------------|--------------------------------------|----------------------------------|
| 0.009 ~ 0.490        | 2400/F(kHz)                          | 300                              |
| 0.490 ~ 1.705        | 24000/F(kHz)                         | 30                               |
| 1.705 ~ 30.0         | 30                                   | 30                               |
| 30 ~ 88              | 100                                  | 3                                |
| 88 ~ 216             | 150                                  | 3                                |
| 216 ~ 960            | 200                                  | 3                                |
| Above 960            | 500                                  | 3                                |

According to §15.249(a), the field strength of emissions from intentional radiators operated within these frequency bands shall comply with the following:

| Fundamental Frequency | Field strength of fundamental<br>(milli-volts/meter) | Field strength of harmonics<br>(micro-volts/meter) |
|-----------------------|--|--|
| 902-928 MHz           | 50   | 500  |
| 2400-2483.5 MHz       | 50   | 500  |
| 5725-5875 MHz         | 50   | 500  |
| 24.0-24.25 GHz        | 250  | 2500   |

The emission limit in this paragraph is based on measurement instrumentation employing an quasi-peak(Below 1GHz)/average(Above 1GHz) detector. The provisions in §15.35 for limiting peak emissions apply.

**NOTE:**

1. The lower limit shall apply at the transition frequencies.
2. Emission level (dBuV/m) = 20 log Emission level (uV/m).
3. As shown in 15.35(b), for frequencies above 1000MHz, the field strength limits are based on average detector, however, the peak field strength of any emission shall not exceed the maximum permitted average limits, specified above by more than 20dB under any condition of modulation.



#### 4.2.2 TEST INSTRUMENTS

| Equipment                           | Manufacturer  | Model No.                 | Serial No.  | Next Cal.   |
|-------------------------------------|---------------|---------------------------|-------------|-------------|
| EMI Test Receiver                   | Rohde&Schwarz | ESU40                     | 100449      | Jan. 10, 24 |
| Signal and Spectrum Analyzer        | Rohde&Schwarz | FSV7                      | 102331      | Apr. 05, 24 |
| Active Loop Antenna (9KHz -30MHz)   | SCHWARZBECK   | FMZB 1519B                | 1519B-045   | May. 09, 24 |
| Amplifier (9KHz -1GHz)              | Burgeon       | BPA-530                   | 100210      | Mar. 06, 24 |
| Trilog-Broadband Antenna            | SCHWARZBECK   | VULB 9168                 | 9168-554    | Jan. 08, 24 |
| Horn Antenna (1GHz -18GHz)          | ETS -Lindgren | 3117                      | 00062558    | Apr. 01, 24 |
| Horn Antenna (18GHz -40GHz)         | SCHWARZBECK   | BBHA 9170                 | BBHA9170147 | Apr. 01, 24 |
| 3m Semi-anechoic Chamber            | ETS-LINDGREN  | 9m*6m*6m                  | NSEMC003    | May. 20, 24 |
| Test Software                       | ADT           | ADT_Radiated_V7.6.15.9 .2 | N/A         | N/A         |
| Broadband Preamplifier (1GHz~18GHz) | SCHWARZBECK   | BBV9718                   | 305         | Apr. 24, 24 |
| Pre-Amplifier (18GHz-40GHz)         | EMCI          | EMC 184045                | 980102      | Jan. 16, 24 |
| BLUETOOTH TESTER                    | Rohde&Schwarz | CBT32                     | 100811      | N/A         |

**NOTES:**

1. The test was performed in 966 Chamber.
2. The calibration interval of the above test instruments are 12 months and the calibrations are traceable to CEPREI/CHINA, GRGT/CHINA and NIM/CHINA.
3. The horn antenna is used only for the measurement of emission frequency above 1 GHz if tested.
4. The FCC Site Registration No. is 749762.



#### 4.2.3 TEST PROCEDURES

- a. The EUT was placed on the top of a rotating table 1.5 meters (above 1GHz) and 0.8 meters (below 1GHz) above the ground at a 3 meters semi-anechoic chamber. The table was rotated 360 degrees to determine the position of the highest radiation.
- b. The EUT was set 3 meters away from the interference-receiving antenna, which was mounted on the top of a variable-height antenna tower.
- c. The antenna is a broadband antenna, and its height is varied from one meter to four meters above the ground to determine the maximum value of the field strength. Both horizontal and vertical polarizations of the antenna are set to make the measurement.
- d. For each suspected emission, the EUT was arranged to its worst case and then the antenna was tuned to heights from 1 meter to 4 meters and the rotatable table was turned from 0 degrees to 360 degrees to find the maximum reading.
- e. The test-receiver system was set to Peak Detect Function and Specified Bandwidth with Maximum Hold Mode.
- f. For below 30MHz, a loop antenna with its vertical plane is place 3m from the EUT and rotated about its vertical axis for maximum response at each azimuth about the EUT. And the centre of the loop shall be 1.3m above the ground.
- g. If the emission level of the EUT in peak mode was lower than the limit specified, then testing could be stopped and the peak values of the EUT would be reported. Otherwise the emissions would be re-tested one by one using peak, quasi-peak or average method as specified and then reported in a data sheet.

#### **NOTES:**

1. The resolution bandwidth and video bandwidth of test receiver/spectrum analyzer is 120kHz for Quasi-peak detection at frequency below 1GHz.
2. The resolution bandwidth of test receiver/spectrum analyzer is 1MHz and video bandwidth is 3MHz for Peak detection at frequency above 1GHz.
3. The resolution bandwidth of test receiver/spectrum analyzer is 1MHz and the video bandwidth is 10Hz for Average detection (AV) at frequency above 1GHz.
4. All modes of operation were investigated and the worst-case emissions are reported.
5. The testing of the EUT was performed on all 3 orthogonal axes; the worst-case test configuration was reported on the file test setup photo.

#### 4.2.4 DEVIATION FROM TEST STANDARD

No deviation.

## 4.2.5 TEST SETUP

### Below 30MHz test setup

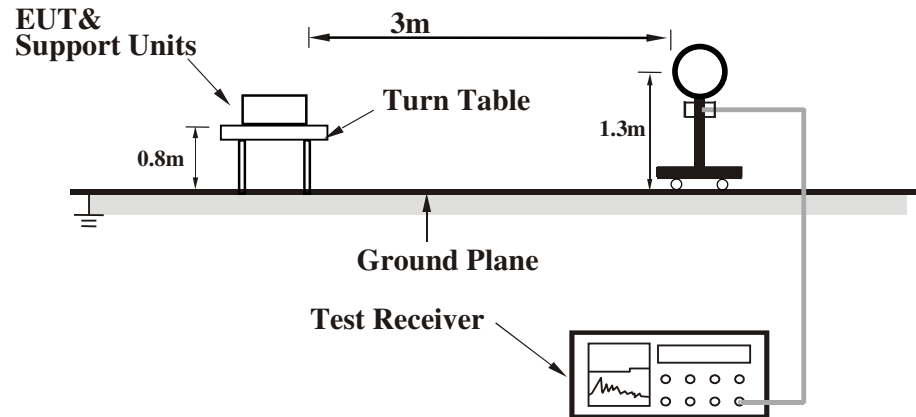

### Below 1GHz test setup

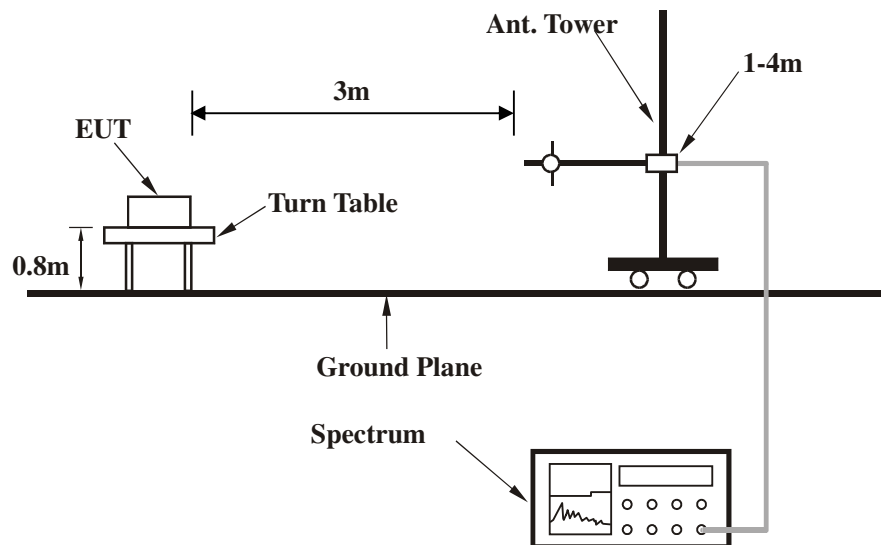

## Above 1GHz test setup

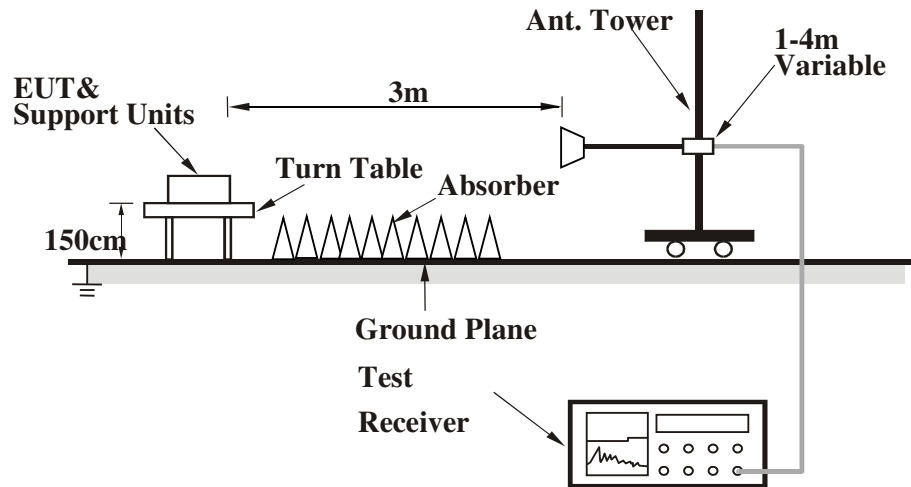

**Note:** For the actual test configuration, please refer to the attached file (Test Setup Photo).

### 4.2.6 EUT OPERATING CONDITIONS

- c) Turned on the power of all equipment.
- d) EUT was operated according to the type used was description in manufacturer's specifications or the User's Manual.

## 4.2.7 TEST RESULTS

### BELOW 1GHz DATA

|                        |                |                              |                 |
|------------------------|----------------|------------------------------|-----------------|
| <b>CHANNEL</b>         | TX Low Channel | <b>DETECTOR<br/>FUNCTION</b> | Quasi-Peak (QP) |
| <b>FREQUENCY RANGE</b> | 9KHz ~ 1GHz    |                              |                 |

| ANTENNA POLARITY & TEST DISTANCE: HORIZONTAL AT 3 M |                |                               |                   |                |                          |                            |                        |                                |
|---|----------------|-------------------------------|-------------------|----------------|--------------------------|----------------------------|------------------------|--------------------------------|
| NO.   | FREQ.<br>(MHz) | EMISSION<br>LEVEL<br>(dBuV/m) | LIMIT<br>(dBuV/m) | MARGIN<br>(dB) | ANTENNA<br>HEIGHT<br>(m) | TABLE<br>ANGLE<br>(Degree) | RAW<br>VALUE<br>(dBuV) | CORRECTION<br>FACTOR<br>(dB/m) |
| 1   | 33.11          | 21.07 QP                      | 40.00             | -18.93         | 1.50 H                   | 0                          | 38.68                  | -17.61                         |
| 2   | 93.73          | 23.63 QP                      | 43.50             | -19.87         | 1.50 H                   | 1                          | 44.21                  | -20.58                         |
| 3   | 118.61         | 31.04 QP                      | 43.50             | -12.46         | 1.50 H                   | 11                         | 48.94                  | -17.90                         |
| 4   | 213.43         | 18.68 QP                      | 43.50             | -24.82         | 1.50 H                   | 0                          | 36.45                  | -17.77                         |
| 5   | 239.86         | 28.35 QP                      | 46.00             | -17.65         | 1.50 H                   | 0                          | 45.02                  | -16.67                         |
| 6   | 457.48         | 40.18 QP                      | 46.00             | -5.82          | 1.50 H                   | 0                          | 50.09                  | -9.91                          |

#### REMARKS:

1. Emission level (dBuV/m) = Raw Value (dBuV) + Correction Factor (dB/m).
2. Correction Factor (dB/m) = Antenna Factor (dB/m) + Cable Factor (dB).
3. The emission levels of other frequencies were less than 20dB margin against the limit.
4. 9KHz~30MHz have been test and test data more than 20dB margin.
5. Margin value = Emission level – Limit value.

The emission is fundamental frequency signal which can be ignored.

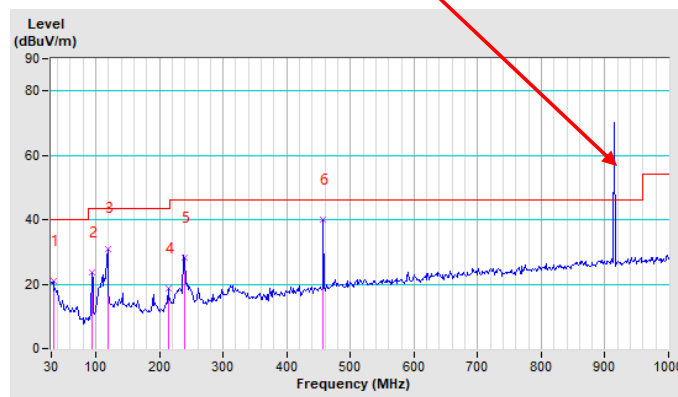

**FUNDAMENTAL FREQUENCY.**

| ANTENNA POLARITY & TEST DISTANCE: HORIZONTAL AT 3 M |             |                         |                |             |                    |                      |                  |                          |
|---|-------------|-------------------------|----------------|-------------|--------------------|----------------------|------------------|--------------------------|
| NO.   | FREQ. (MHz) | EMISSION LEVEL (dBuV/m) | LIMIT (dBuV/m) | MARGIN (dB) | ANTENNA HEIGHT (m) | TABLE ANGLE (Degree) | RAW VALUE (dBuV) | CORRECTION FACTOR (dB/m) |
| 1   | 914         | 70.04 QP                | 94.00          | -23.96      | 1.50 H             | 35                   | 71.50            | -1.46                    |

**REMARKS:**

1. Emission level (dBuV/m) = Raw Value (dBuV) + Correction Factor (dB/m).
2. Correction Factor (dB/m) = Antenna Factor (dB/m) + Cable Factor (dB).
3. The emission levels of other frequencies were less than 20dB margin against the limit.
4. Margin value = Emission level – Limit value.

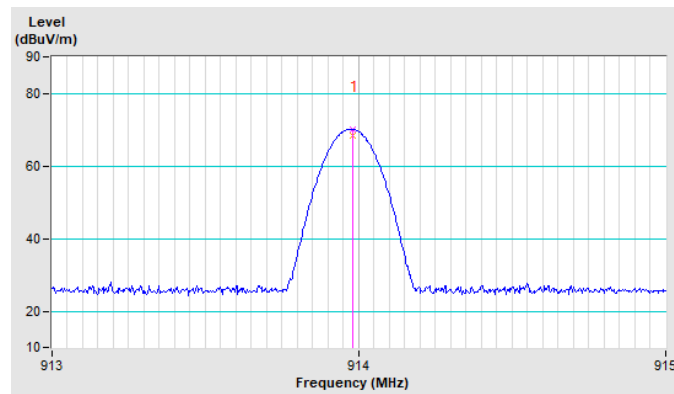

|                        |                |                              |                 |
|------------------------|----------------|------------------------------|-----------------|
| <b>CHANNEL</b>         | TX Low Channel | <b>DETECTOR<br/>FUNCTION</b> | Quasi-Peak (QP) |
| <b>FREQUENCY RANGE</b> | 9KHz ~ 1GHz    |                              |                 |

| ANTENNA POLARITY & TEST DISTANCE: VERTICAL AT 3 M |                |                               |                   |                |                          |                            |                        |                                |
|---|----------------|-------------------------------|-------------------|----------------|--------------------------|----------------------------|------------------------|--------------------------------|
| NO.   | FREQ.<br>(MHz) | EMISSION<br>LEVEL<br>(dBuV/m) | LIMIT<br>(dBuV/m) | MARGIN<br>(dB) | ANTENNA<br>HEIGHT<br>(m) | TABLE<br>ANGLE<br>(Degree) | RAW<br>VALUE<br>(dBuV) | CORRECTION<br>FACTOR<br>(dB/m) |
| 1   | 47.10          | 18.98 QP                      | 40.00             | -21.02         | 1.50 V                   | 221                        | 35.59                  | -16.61                         |
| 2   | 93.73          | 26.68 QP                      | 43.50             | -16.82         | 1.50 V                   | 130                        | 47.26                  | -20.58                         |
| 3   | 118.61         | 28.42 QP                      | 43.50             | -15.08         | 1.50 V                   | 143                        | 46.32                  | -17.90                         |
| 4   | 239.86         | 19.20 QP                      | 46.00             | -26.80         | 1.50 V                   | 159                        | 35.87                  | -16.67                         |
| 5   | 317.58         | 22.43 QP                      | 46.00             | -23.57         | 1.50 V                   | 183                        | 36.04                  | -13.61                         |
| 6   | 457.48         | 41.15 QP                      | 46.00             | -4.85          | 1.50 V                   | 200                        | 51.06                  | -9.91                          |

**REMARKS:**

1. Emission level (dBuV/m) = Raw Value (dBuV) + Correction Factor (dB/m).
2. Correction Factor (dB/m) = Antenna Factor (dB/m) + Cable Factor (dB).
3. The emission levels of other frequencies were less than 20dB margin against the limit.
4. 9KHz~30MHz have been test and test data more than 20dB margin.
5. Margin value = Emission level – Limit value.

The emission is fundamental frequency signal which can be ignored.

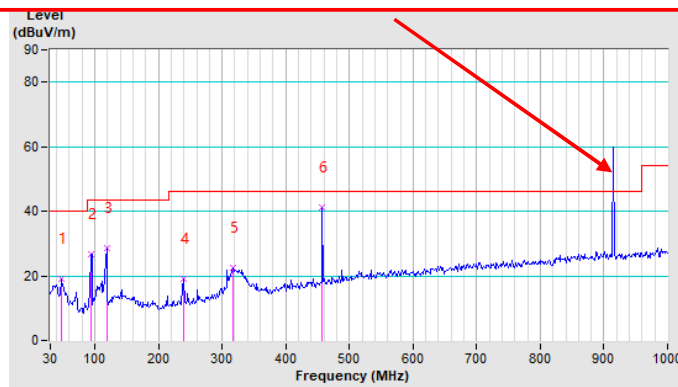

**FUNDAMENTAL FREQUENCY.**

| ANTENNA POLARITY & TEST DISTANCE: VERTICAL AT 3 M |             |                         |                |             |                    |                      |                  |                          |
|---|-------------|-------------------------|----------------|-------------|--------------------|----------------------|------------------|--------------------------|
| NO.   | FREQ. (MHz) | EMISSION LEVEL (dBuV/m) | LIMIT (dBuV/m) | MARGIN (dB) | ANTENNA HEIGHT (m) | TABLE ANGLE (Degree) | RAW VALUE (dBuV) | CORRECTION FACTOR (dB/m) |
| 1   | 914         | 59.88 QP                | 94.00          | -34.12      | 1.50 V             | 61                   | 61.34            | -1.46                    |

**REMARKS:**

1. Emission level (dBuV/m) = Raw Value (dBuV) + Correction Factor (dB/m).
2. Correction Factor (dB/m) = Antenna Factor (dB/m) + Cable Factor (dB).
3. The emission levels of other frequencies were less than 20dB margin against the limit.
4. Margin value = Emission level – Limit value.

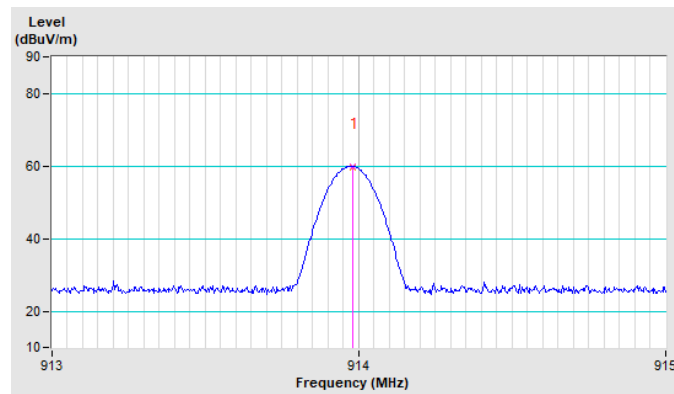



|                 |                   |                   |                 |
|-----------------|-------------------|-------------------|-----------------|
| CHANNEL         | TX Middle Channel | DETECTOR FUNCTION | Quasi-Peak (QP) |
| FREQUENCY RANGE | 9KHz ~ 1GHz       |                   |                 |

| ANTENNA POLARITY & TEST DISTANCE: HORIZONTAL AT 3 M |             |                         |                |             |                    |                      |                  |                          |
|---|-------------|-------------------------|----------------|-------------|--------------------|----------------------|------------------|--------------------------|
| NO.   | FREQ. (MHz) | EMISSION LEVEL (dBuV/m) | LIMIT (dBuV/m) | MARGIN (dB) | ANTENNA HEIGHT (m) | TABLE ANGLE (Degree) | RAW VALUE (dBuV) | CORRECTION FACTOR (dB/m) |
| 1   | 30.00       | 23.72 QP                | 40.00          | -16.28      | 2.00 H             | 0                    | 41.83            | -18.11                   |
| 2   | 93.73       | 22.74 QP                | 43.50          | -20.76      | 1.95 H             | 0                    | 43.32            | -20.58                   |
| 3   | 118.61      | 31.36 QP                | 43.50          | -12.14      | 1.78 H             | 358                  | 49.26            | -17.90                   |
| 4   | 141.92      | 16.82 QP                | 43.50          | -26.68      | 2.00 H             | 0                    | 32.71            | -15.89                   |
| 5   | 239.86      | 27.52 QP                | 46.00          | -18.48      | 1.62 H             | 342                  | 44.19            | -16.67                   |
| 6   | 457.48      | 40.90 QP                | 46.00          | -5.10       | 2.00 H             | 0                    | 50.81            | -9.91                    |

REMARKS:

1. Emission level (dBuV/m) = Raw Value (dBuV) + Correction Factor (dB/m).
2. Correction Factor (dB/m) = Antenna Factor (dB/m) + Cable Factor (dB).
3. The emission levels of other frequencies were less than 20dB margin against the limit.
4. 9KHz~30MHz have been test and test data more than 20dB margin.
5. Margin value = Emission level – Limit value.

The emission is fundamental frequency signal which can be ignored.

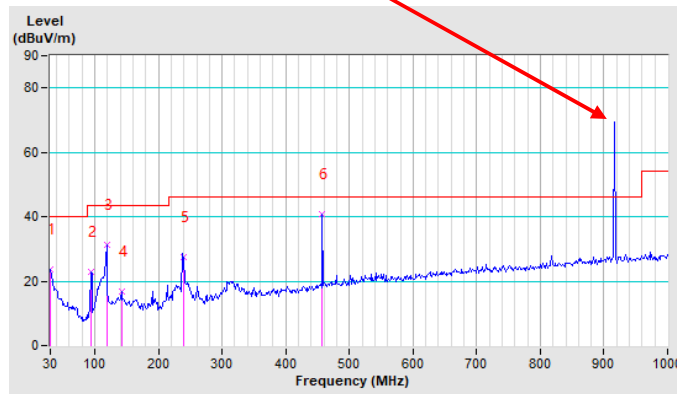



**FUNDAMENTAL FREQUENCY.**

| ANTENNA POLARITY & TEST DISTANCE: HORIZONTAL AT 3 M |             |                         |                |             |                    |                      |                  |                          |
|---|-------------|-------------------------|----------------|-------------|--------------------|----------------------|------------------|--------------------------|
| NO.   | FREQ. (MHz) | EMISSION LEVEL (dBuV/m) | LIMIT (dBuV/m) | MARGIN (dB) | ANTENNA HEIGHT (m) | TABLE ANGLE (Degree) | RAW VALUE (dBuV) | CORRECTION FACTOR (dB/m) |
| 1   | 915         | 68.97 QP                | 94.00          | -25.03      | 1.50 H             | 35                   | 70.41            | -1.44                    |

**REMARKS:**

1. Emission level (dBuV/m) = Raw Value (dBuV) + Correction Factor (dB/m).
2. Correction Factor (dB/m) = Antenna Factor (dB/m) + Cable Factor (dB).
3. The emission levels of other frequencies were less than 20dB margin against the limit.
4. Margin value = Emission level – Limit value.

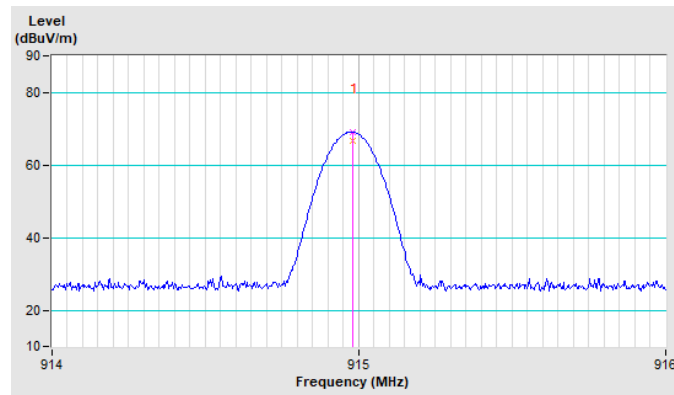



|                        |                   |                          |                 |
|------------------------|-------------------|--------------------------|-----------------|
| <b>CHANNEL</b>         | TX Middle Channel | <b>DETECTOR FUNCTION</b> | Quasi-Peak (QP) |
| <b>FREQUENCY RANGE</b> | 9KHz ~ 1GHz       |                          |                 |

| ANTENNA POLARITY & TEST DISTANCE: VERTICAL AT 3 M |             |                         |                |             |                    |                      |                  |                          |
|---|-------------|-------------------------|----------------|-------------|--------------------|----------------------|------------------|--------------------------|
| NO.   | FREQ. (MHz) | EMISSION LEVEL (dBuV/m) | LIMIT (dBuV/m) | MARGIN (dB) | ANTENNA HEIGHT (m) | TABLE ANGLE (Degree) | RAW VALUE (dBuV) | CORRECTION FACTOR (dB/m) |
| 1   | 47.10       | 20.46 QP                | 40.00          | -19.54      | 1.50 V             | 0                    | 37.07            | -16.61                   |
| 2   | 95.29       | 25.06 QP                | 43.50          | -18.44      | 1.50 V             | 340                  | 45.54            | -20.48                   |
| 3   | 118.61      | 26.35 QP                | 43.50          | -17.15      | 1.50 V             | 353                  | 44.25            | -17.90                   |
| 4   | 239.86      | 19.58 QP                | 46.00          | -26.42      | 1.50 V             | 0                    | 36.25            | -16.67                   |
| 5   | 308.25      | 22.55 QP                | 46.00          | -23.45      | 1.50 V             | 0                    | 36.44            | -13.89                   |
| 6   | 457.49      | 43.20 QP                | 46.00          | -2.80       | 1.50 V             | 219                  | 53.11            | -9.91                    |

**REMARKS:**

1. Emission level (dBuV/m) = Raw Value (dBuV) + Correction Factor (dB/m).
2. Correction Factor (dB/m) = Antenna Factor (dB/m) + Cable Factor (dB).
3. The emission levels of other frequencies were less than 20dB margin against the limit.
4. 9KHz~30MHz have been test and test data more than 20dB margin.
5. Margin value = Emission level – Limit value.

The emission is fundamental frequency signal which can be ignored.

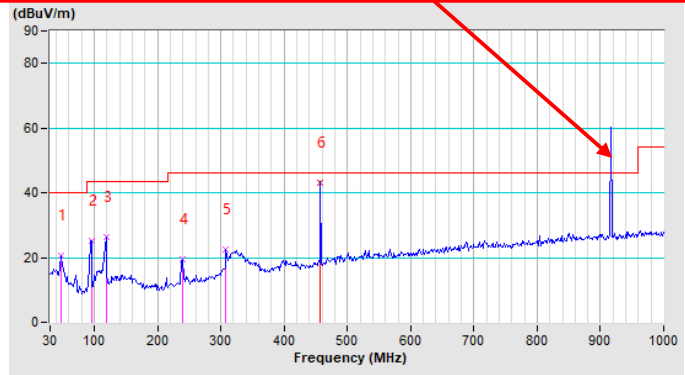

**FUNDAMENTAL FREQUENCY.**

| ANTENNA POLARITY & TEST DISTANCE: VERTICAL AT 3 M |                |                               |                   |                |                       |                            |                        |                                |
|---|----------------|-------------------------------|-------------------|----------------|-----------------------|----------------------------|------------------------|--------------------------------|
| NO.   | FREQ.<br>(MHz) | EMISSION<br>LEVEL<br>(dBuV/m) | LIMIT<br>(dBuV/m) | MARGIN<br>(dB) | ANTENNA<br>HEIGHT (m) | TABLE<br>ANGLE<br>(Degree) | RAW<br>VALUE<br>(dBuV) | CORRECTION<br>FACTOR<br>(dB/m) |
| 1   | 915            | 60.10 QP                      | 94.00             | -33.90         | 1.50 V                | 35                         | 61.54                  | -1.44                          |

**REMARKS:**

1. Emission level (dBuV/m) = Raw Value (dBuV) + Correction Factor (dB/m).
2. Correction Factor (dB/m) = Antenna Factor (dB/m) + Cable Factor (dB).
3. The emission levels of other frequencies were less than 20dB margin against the limit.
4. Margin value = Emission level – Limit value.

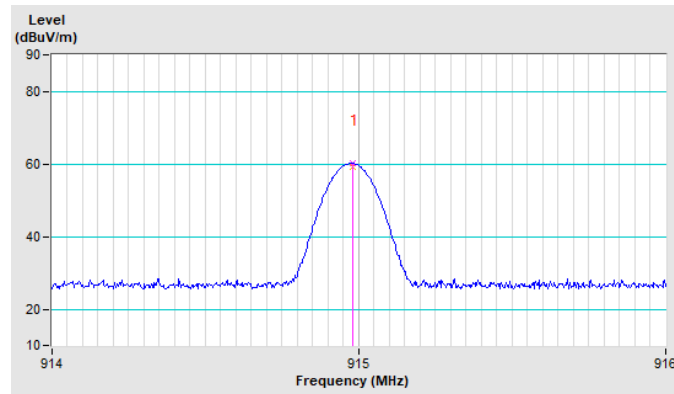



|                        |                 |                              |                 |
|------------------------|-----------------|------------------------------|-----------------|
| <b>CHANNEL</b>         | TX High Channel | <b>DETECTOR<br/>FUNCTION</b> | Quasi-Peak (QP) |
| <b>FREQUENCY RANGE</b> | 9KHz ~ 1GHz     |                              |                 |

| ANTENNA POLARITY & TEST DISTANCE: HORIZONTAL AT 3 M |                |                               |                   |                |                          |                            |                        |                                |
|---|----------------|-------------------------------|-------------------|----------------|--------------------------|----------------------------|------------------------|--------------------------------|
| NO.   | FREQ.<br>(MHz) | EMISSION<br>LEVEL<br>(dBuV/m) | LIMIT<br>(dBuV/m) | MARGIN<br>(dB) | ANTENNA<br>HEIGHT<br>(m) | TABLE<br>ANGLE<br>(Degree) | RAW<br>VALUE<br>(dBuV) | CORRECTION<br>FACTOR<br>(dB/m) |
| 1   | 93.73          | 26.17 QP                      | 43.50             | -17.33         | 2.00 H                   | 0                          | 46.75                  | -20.58                         |
| 2   | 106.17         | 33.27 QP                      | 43.50             | -10.23         | 2.00 H                   | 46                         | 52.38                  | -19.11                         |
| 3   | 118.61         | 36.34 QP                      | 43.50             | -7.16          | 2.00 H                   | 33                         | 54.24                  | -17.90                         |
| 4   | 239.86         | 29.80 QP                      | 46.00             | -16.20         | 2.00 H                   | 0                          | 46.47                  | -16.67                         |
| 5   | 457.48         | 39.08 QP                      | 46.00             | -6.92          | 2.00 H                   | 16                         | 48.99                  | -9.91                          |
| 6   | 891.19         | 39.81 QP                      | 46.00             | -6.19          | 2.00 H                   | 1                          | 41.49                  | -1.68                          |

**REMARKS:**

1. Emission level (dBuV/m) = Raw Value (dBuV) + Correction Factor (dB/m).
2. Correction Factor (dB/m) = Antenna Factor (dB/m) + Cable Factor (dB).
3. The emission levels of other frequencies were less than 20dB margin against the limit.
4. 9KHz~30MHz have been test and test data more than 20dB margin.
5. Margin value = Emission level – Limit value.

The emission is fundamental frequency signal which can be ignored.

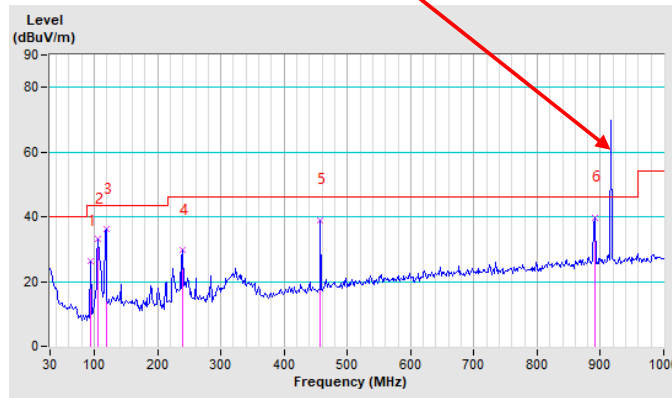

**FUNDAMENTAL FREQUENCY.**

| ANTENNA POLARITY & TEST DISTANCE: HORIZONTAL AT 3 M |                |                               |                   |                |                       |                            |                        |                                |
|---|----------------|-------------------------------|-------------------|----------------|-----------------------|----------------------------|------------------------|--------------------------------|
| NO.   | FREQ.<br>(MHz) | EMISSION<br>LEVEL<br>(dBuV/m) | LIMIT<br>(dBuV/m) | MARGIN<br>(dB) | ANTENNA<br>HEIGHT (m) | TABLE<br>ANGLE<br>(Degree) | RAW<br>VALUE<br>(dBuV) | CORRECTION<br>FACTOR<br>(dB/m) |
| 1   | 916            | 68.53 QP                      | 94.00             | -25.47         | 1.50 H                | 289                        | 69.78                  | -1.43                          |

**REMARKS:**

1. Emission level (dBuV/m) = Raw Value (dBuV) + Correction Factor (dB/m).
2. Correction Factor (dB/m) = Antenna Factor (dB/m) + Cable Factor (dB).
3. The emission levels of other frequencies were less than 20dB margin against the limit.
4. Margin value = Emission level – Limit value.

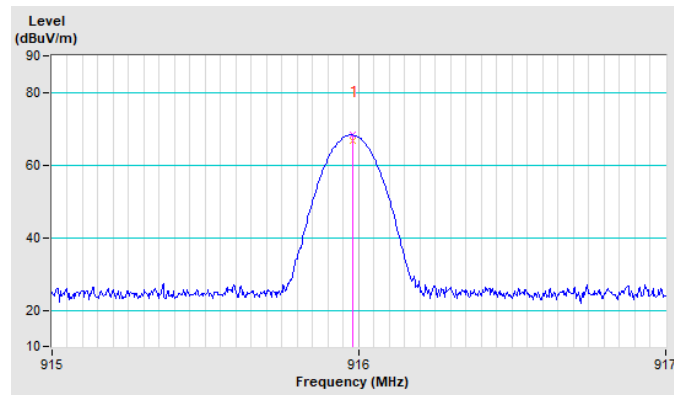



|                 |                 |                   |                 |
|-----------------|-----------------|-------------------|-----------------|
| CHANNEL         | TX High Channel | DETECTOR FUNCTION | Quasi-Peak (QP) |
| FREQUENCY RANGE | 9KHz ~ 1GHz     |                   |                 |

| ANTENNA POLARITY & TEST DISTANCE: VERTICAL AT 3 M |             |                         |                |             |                    |                      |                  |                          |
|---|-------------|-------------------------|----------------|-------------|--------------------|----------------------|------------------|--------------------------|
| NO.   | FREQ. (MHz) | EMISSION LEVEL (dBuV/m) | LIMIT (dBuV/m) | MARGIN (dB) | ANTENNA HEIGHT (m) | TABLE ANGLE (Degree) | RAW VALUE (dBuV) | CORRECTION FACTOR (dB/m) |
| 1   | 93.73       | 25.57 QP                | 43.50          | -17.93      | 1.00 V             | 0                    | 46.15            | -20.58                   |
| 2   | 118.61      | 29.14 QP                | 43.50          | -14.36      | 1.00 V             | 0                    | 47.04            | -17.90                   |
| 3   | 239.86      | 21.63 QP                | 46.00          | -24.37      | 1.00 V             | 0                    | 38.30            | -16.67                   |
| 4   | 326.91      | 21.94 QP                | 46.00          | -24.06      | 1.00 V             | 0                    | 35.27            | -13.33                   |
| 5   | 457.99      | 42.30 QP                | 46.00          | -3.70       | 1.00 V             | 360                  | 52.20            | -9.90                    |
| 6   | 592.72      | 22.19 QP                | 46.00          | -23.81      | 1.00 V             | 165                  | 29.08            | -6.89                    |

REMARKS:

1. Emission level (dBuV/m) = Raw Value (dBuV) + Correction Factor (dB/m).
2. Correction Factor (dB/m) = Antenna Factor (dB/m) + Cable Factor (dB).
3. The emission levels of other frequencies were less than 20dB margin against the limit.
4. 9KHz~30MHz have been test and test data more than 20dB margin.
5. Margin value = Emission level – Limit value.

The emission is fundamental frequency signal which can be ignored.

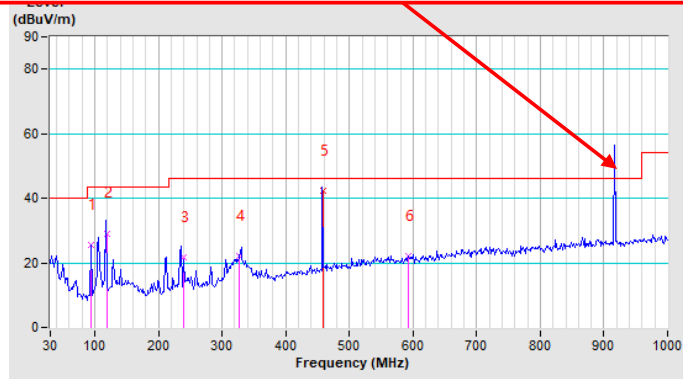

**FUNDAMENTAL FREQUENCY.**

| ANTENNA POLARITY & TEST DISTANCE: VERTICAL AT 3 M |                |                               |                   |                |                       |                            |                        |                                |
|---|----------------|-------------------------------|-------------------|----------------|-----------------------|----------------------------|------------------------|--------------------------------|
| NO.   | FREQ.<br>(MHz) | EMISSION<br>LEVEL<br>(dBuV/m) | LIMIT<br>(dBuV/m) | MARGIN<br>(dB) | ANTENNA<br>HEIGHT (m) | TABLE<br>ANGLE<br>(Degree) | RAW<br>VALUE<br>(dBuV) | CORRECTION<br>FACTOR<br>(dB/m) |
| 1   | 916            | 60.40 QP                      | 94.00             | -33.60         | 1.50 V                | 80                         | 61.83                  | -1.43                          |

**REMARKS:**

1. Emission level (dBuV/m) = Raw Value (dBuV) + Correction Factor (dB/m).
2. Correction Factor (dB/m) = Antenna Factor (dB/m) + Cable Factor (dB).
3. The emission levels of other frequencies were less than 20dB margin against the limit.
4. Margin value = Emission level – Limit value.

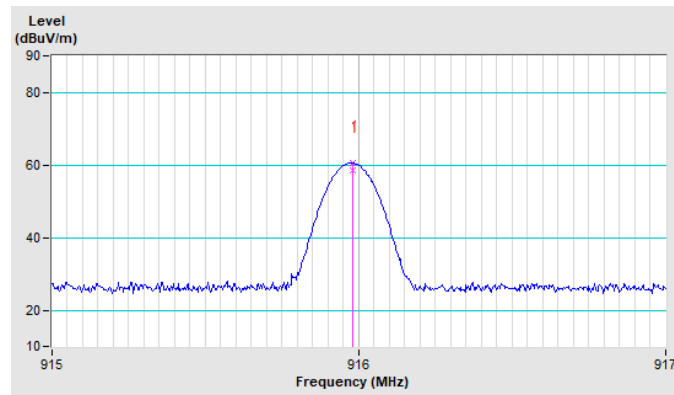

**ABOVE 1GHz WORST-CASE DATA:**

|                        |                |                              |              |
|------------------------|----------------|------------------------------|--------------|
| <b>CHANNEL</b>         | TX Low Channel | <b>DETECTOR<br/>FUNCTION</b> | Peak (PK)    |
| <b>FREQUENCY RANGE</b> | 1GHz ~ 25GHz   |                              | Average (AV) |

**ANTENNA POLARITY & TEST DISTANCE: HORIZONTAL AT 3 M**

| NO. | FREQ.<br>(MHz) | EMISSION<br>LEVEL<br>(dBuV/m) | LIMIT<br>(dBuV/m) | MARGIN<br>(dB) | ANTENNA<br>HEIGHT<br>(m) | TABLE<br>ANGLE<br>(Degree) | RAW<br>VALUE<br>(dBuV) | CORRECTION<br>FACTOR<br>(dB/m) |
|-----|----------------|-------------------------------|-------------------|----------------|--------------------------|----------------------------|------------------------|--------------------------------|
| 1   | 1828.00        | 51.15 PK                      | 74.00             | -22.85         | 1.65 H                   | 92                         | 49.40                  | 1.75                           |
| 2   | 1828.00        | 38.19 AV                      | 54.00             | -15.81         | 1.65 H                   | 92                         | 36.44                  | 1.75                           |
| 3   | 2742.00        | 45.65 PK                      | 74.00             | -28.35         | 1.50 H                   | 62                         | 42.15                  | 3.50                           |
| 4   | 2742.00        | 38.15 AV                      | 54.00             | -15.85         | 1.50 H                   | 62                         | 34.65                  | 3.50                           |
| 5   | 3656.00        | 48.26 PK                      | 74.00             | -25.74         | 1.05 H                   | 52                         | 43.87                  | 4.39                           |
| 6   | 3656.00        | 34.16 AV                      | 54.00             | -19.84         | 1.05 H                   | 52                         | 29.77                  | 4.39                           |

**ANTENNA POLARITY & TEST DISTANCE: VERTICAL AT 3 M**

| NO. | FREQ.<br>(MHz) | EMISSION<br>LEVEL<br>(dBuV/m) | LIMIT<br>(dBuV/m) | MARGIN<br>(dB) | ANTENNA<br>HEIGHT<br>(m) | TABLE<br>ANGLE<br>(Degree) | RAW<br>VALUE<br>(dBuV) | CORRECTION<br>FACTOR<br>(dB/m) |
|-----|----------------|-------------------------------|-------------------|----------------|--------------------------|----------------------------|------------------------|--------------------------------|
| 1   | 1828.00        | 51.26 PK                      | 74.00             | -22.74         | 1.02 V                   | 63                         | 49.51                  | 1.75                           |
| 2   | 1828.00        | 40.26 AV                      | 54.00             | -13.74         | 1.02 V                   | 63                         | 38.51                  | 1.75                           |
| 3   | 2742.00        | 48.59 PK                      | 74.00             | -25.41         | 3.15 V                   | 65                         | 45.77                  | 2.82                           |
| 4   | 2742.00        | 38.10 AV                      | 54.00             | -15.90         | 3.15 V                   | 65                         | 35.28                  | 2.82                           |
| 5   | 3656.00        | 51.25 PK                      | 74.00             | -22.75         | 1.00 V                   | 360                        | 46.86                  | 4.39                           |
| 6   | 3656.00        | 41.25 AV                      | 54.00             | -12.75         | 1.00 V                   | 360                        | 36.86                  | 4.39                           |

**REMARKS:**

1. Emission level (dBuV/m) = Raw Value (dBuV) + Correction Factor (dB/m).
2. Correction Factor (dB/m) = Antenna Factor (dB/m) + Cable Factor (dB).
3. The emission levels of other frequencies were less than 20dB margin against the limit.
4. Margin value = Emission level – Limit value.



|                        |                   |                              |              |
|------------------------|-------------------|------------------------------|--------------|
| <b>CHANNEL</b>         | TX Middle Channel | <b>DETECTOR<br/>FUNCTION</b> | Peak (PK)    |
| <b>FREQUENCY RANGE</b> | 1GHz ~ 25GHz      |                              | Average (AV) |

| ANTENNA POLARITY & TEST DISTANCE: HORIZONTAL AT 3 M |                |                               |                   |                |                          |                            |                        |                                |
|---|----------------|-------------------------------|-------------------|----------------|--------------------------|----------------------------|------------------------|--------------------------------|
| NO.   | FREQ.<br>(MHz) | EMISSION<br>LEVEL<br>(dBuV/m) | LIMIT<br>(dBuV/m) | MARGIN<br>(dB) | ANTENNA<br>HEIGHT<br>(m) | TABLE<br>ANGLE<br>(Degree) | RAW<br>VALUE<br>(dBuV) | CORRECTION<br>FACTOR<br>(dB/m) |
| 1   | 1830.00        | 47.50 PK                      | 74.00             | -26.50         | 1.49 H                   | 52                         | 45.74                  | 1.76                           |
| 2   | 1830.00        | 36.45 AV                      | 54.00             | -17.55         | 1.49 H                   | 52                         | 34.69                  | 1.76                           |
| 3   | 2745.00        | 51.19 PK                      | 74.00             | -22.81         | 1.35 H                   | 63                         | 48.38                  | 2.81                           |
| 4   | 2745.00        | 40.29 AV                      | 54.00             | -13.71         | 1.35 H                   | 63                         | 37.48                  | 2.81                           |
| 5   | 3660.00        | 48.21 PK                      | 74.00             | -25.79         | 1.62 H                   | 63                         | 43.65                  | 4.56                           |
| 6   | 3660.00        | 34.59 AV                      | 54.00             | -19.41         | 1.62 H                   | 63                         | 30.03                  | 4.56                           |
| ANTENNA POLARITY & TEST DISTANCE: VERTICAL AT 3 M   |                |                               |                   |                |                          |                            |                        |                                |
| NO.   | FREQ.<br>(MHz) | EMISSION<br>LEVEL<br>(dBuV/m) | LIMIT<br>(dBuV/m) | MARGIN<br>(dB) | ANTENNA<br>HEIGHT<br>(m) | TABLE<br>ANGLE<br>(Degree) | RAW<br>VALUE<br>(dBuV) | CORRECTION<br>FACTOR<br>(dB/m) |
| 1   | 1830.00        | 48.16 PK                      | 74.00             | -25.84         | 1.06 V                   | 95                         | 46.40                  | 1.76                           |
| 2   | 1830.00        | 38.10 AV                      | 54.00             | -15.90         | 1.06 V                   | 95                         | 36.34                  | 1.76                           |
| 3   | 2745.00        | 45.71 PK                      | 74.00             | -28.29         | 1.35 V                   | 90                         | 42.90                  | 2.81                           |
| 4   | 2745.00        | 36.50 AV                      | 54.00             | -17.50         | 1.35 V                   | 90                         | 33.69                  | 2.81                           |
| 5   | 3660.00        | 49.01 PK                      | 74.00             | -24.99         | 1.65 V                   | 20                         | 44.45                  | 4.56                           |
| 6   | 3660.00        | 36.54 AV                      | 54.00             | -17.46         | 1.65 V                   | 20                         | 31.98                  | 4.56                           |

**REMARKS:**

1. Emission level (dBuV/m) = Raw Value (dBuV) + Correction Factor (dB/m).
2. Correction Factor (dB/m) = Antenna Factor (dB/m) + Cable Factor (dB).
3. The emission levels of other frequencies were less than 20dB margin against the limit.
4. Margin value = Emission level – Limit value.

|                        |                 |                              |              |
|------------------------|-----------------|------------------------------|--------------|
| <b>CHANNEL</b>         | TX High Channel | <b>DETECTOR<br/>FUNCTION</b> | Peak (PK)    |
| <b>FREQUENCY RANGE</b> | 1GHz ~ 25GHz    |                              | Average (AV) |

| ANTENNA POLARITY & TEST DISTANCE: HORIZONTAL AT 3 M |                |                               |                   |                |                          |                            |                        |                                |
|---|----------------|-------------------------------|-------------------|----------------|--------------------------|----------------------------|------------------------|--------------------------------|
| NO.   | FREQ.<br>(MHz) | EMISSION<br>LEVEL<br>(dBuV/m) | LIMIT<br>(dBuV/m) | MARGIN<br>(dB) | ANTENNA<br>HEIGHT<br>(m) | TABLE<br>ANGLE<br>(Degree) | RAW<br>VALUE<br>(dBuV) | CORRECTION<br>FACTOR<br>(dB/m) |
| 1   | 1832.00        | 48.50 PK                      | 74.00             | -25.50         | 1.06 H                   | 52                         | 46.72                  | 1.78                           |
| 2   | 1832.00        | 41.29 AV                      | 54.00             | -12.71         | 1.06 H                   | 52                         | 39.51                  | 1.78                           |
| 3   | 2748.00        | 48.44 PK                      | 74.00             | -25.56         | 1.06 H                   | 201                        | 45.64                  | 2.80                           |
| 4   | 2748.00        | 41.20 AV                      | 54.00             | -12.80         | 1.06 H                   | 201                        | 38.40                  | 2.80                           |
| 5   | 3664.15        | 51.25 PK                      | 74.00             | -22.75         | 1.50 H                   | 60                         | 46.68                  | 4.57                           |
| 6   | 3664.15        | 41.35 AV                      | 54.00             | -12.65         | 1.50 H                   | 60                         | 36.78                  | 4.57                           |
| ANTENNA POLARITY & TEST DISTANCE: VERTICAL AT 3 M   |                |                               |                   |                |                          |                            |                        |                                |
| NO.   | FREQ.<br>(MHz) | EMISSION<br>LEVEL<br>(dBuV/m) | LIMIT<br>(dBuV/m) | MARGIN<br>(dB) | ANTENNA<br>HEIGHT<br>(m) | TABLE<br>ANGLE<br>(Degree) | RAW<br>VALUE<br>(dBuV) | CORRECTION<br>FACTOR<br>(dB/m) |
| 1   | 1832.00        | 48.49 PK                      | 74.00             | -25.51         | 1.06 V                   | 92                         | 46.71                  | 1.78                           |
| 2   | 1832.00        | 32.16 AV                      | 54.00             | -21.84         | 1.06 V                   | 92                         | 30.38                  | 1.78                           |
| 3   | 2748.00        | 51.20 PK                      | 74.00             | -22.80         | 1.35 V                   | 63                         | 48.40                  | 2.80                           |
| 4   | 2748.00        | 40.12 AV                      | 54.00             | -13.88         | 1.35 V                   | 63                         | 37.32                  | 2.80                           |
| 5   | 3664.15        | 51.20 PK                      | 74.00             | -22.80         | 3.15 V                   | 69                         | 46.63                  | 4.57                           |
| 6   | 3664.15        | 40.12 AV                      | 54.00             | -13.88         | 3.15 V                   | 69                         | 35.55                  | 4.57                           |

**REMARKS:**

1. Emission level (dBuV/m) = Raw Value (dBuV) + Correction Factor (dB/m).
2. Correction Factor (dB/m) = Antenna Factor (dB/m) + Cable Factor (dB).
3. The emission levels of other frequencies were less than 20dB margin against the limit.
4. Margin value = Emission level – Limit value.

### 4.3 20dB BANDWIDTH MEASUREMENT

#### 4.3.1 LIMITS OF 20dB BANDWIDTH MEASUREMENT

According to FCC 15.215(c), must be designed to ensure that the 20 dB bandwidth of the emission, or whatever bandwidth may otherwise be specified in the specific rule section under which the equipment operates, is contained within the frequency band designated in the rule section under which the equipment is operated.

#### 4.3.2 TEST INSTRUMENTS

| Equipment                        | Manufacturer  | Model No.                     | Serial No.  | Next Cal.   |
|----------------------------------|---------------|-------------------------------|-------------|-------------|
| Power Sensor                     | Keysight      | U2021XA                       | MY57320002  | Jan. 11, 24 |
| Power Meter                      | Anritsu       | ML2495A                       | 1139001     | Aug. 22, 23 |
| Power Sensor                     | Anritsu       | MA2411B                       | 1531155     | Aug. 22, 23 |
| Digital Multimeter               | FLUKE         | 15B                           | A1220010DG  | N/A         |
| Humid & Temp Programmable Tester | Haida         | HD-225T                       | 110807201   | Nov. 02, 23 |
| Oscilloscope                     | Agilent       | DSO9254A                      | MY51260160  | Jul. 27, 23 |
| Signal and Spectrum Analyzer     | Rohde&Schwarz | FSV40                         | 101094      | Jan. 11, 24 |
| Signal Generator                 | Agilent       | N5183A                        | MY50140980  | Jul. 20, 23 |
| MXG-B RF Vector Signal Generator | Keysight      | N5182B                        | MY56200288  | Jul. 20, 23 |
| BLUETOOTH TESTER                 | Rohde&Schwarz | CBT32                         | 100811      | N/A         |
| Attenuator                       | MINI          | BW-S10W2+                     | S130129FGE2 | N/A         |
| DC Source                        | Keysight      | E3642A                        | MY56146098  | N/A         |
| Test software                    | ADT           | ADT_RF Test Software V6.6.5.3 | N/A         | N/A         |

#### NOTES:

1. The test was performed in RF Oven room.
2. The calibration interval of the above test instruments is 12 months and the calibrations are traceable to CEPREI/CHINA, GRGT/CHINA and NIM/CHINA.

#### 4.3.3 TEST PROCEDURE

- a. Check the calibration of the measuring instrument using either an internal calibrator or a known signal from an external generator.
- b. Turn on the EUT and connect it to measurement instrument. Then set it to any one convenient frequency within its operating range. Set a reference level on the measuring instrument equal to the highest peak value.
- c. Measure the frequency difference of two frequencies that were attenuated 20dB from the reference level. Record the frequency difference as the emission bandwidth.
- d. Repeat above procedures until all frequencies measured were complete.

#### 4.3.4 DEVIATION FROM TEST STANDARD

No deviation.

#### 4.3.5 TEST SETUP

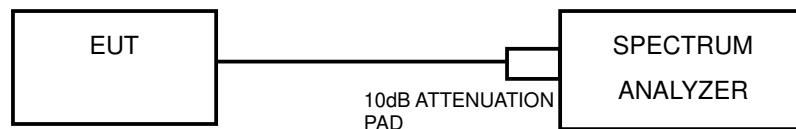

#### 4.3.6 EUT OPERATING CONDITIONS

- a) Turned on the power of all equipment.
- b) EUT was operated according to the type used was description in manufacturer's specifications or the User's Manual.

### 4.3.7 TEST RESULTS

| CHANNEL | CHANNEL FREQUENCY (MHz) | 20dB BANDWIDTH (MHz) |
|---------|-------------------------|----------------------|
| Low     | 914                     | 0.02475              |
| Middle  | 915                     | 0.02496              |
| High    | 916                     | 0.02475              |

#### Test Data: Low channel

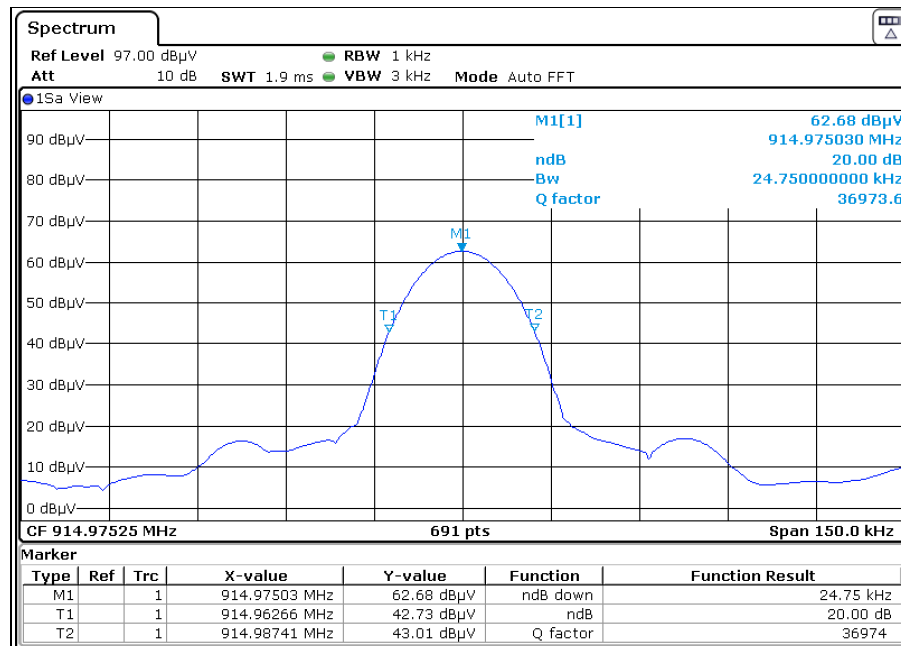

Test Data: Middle channel

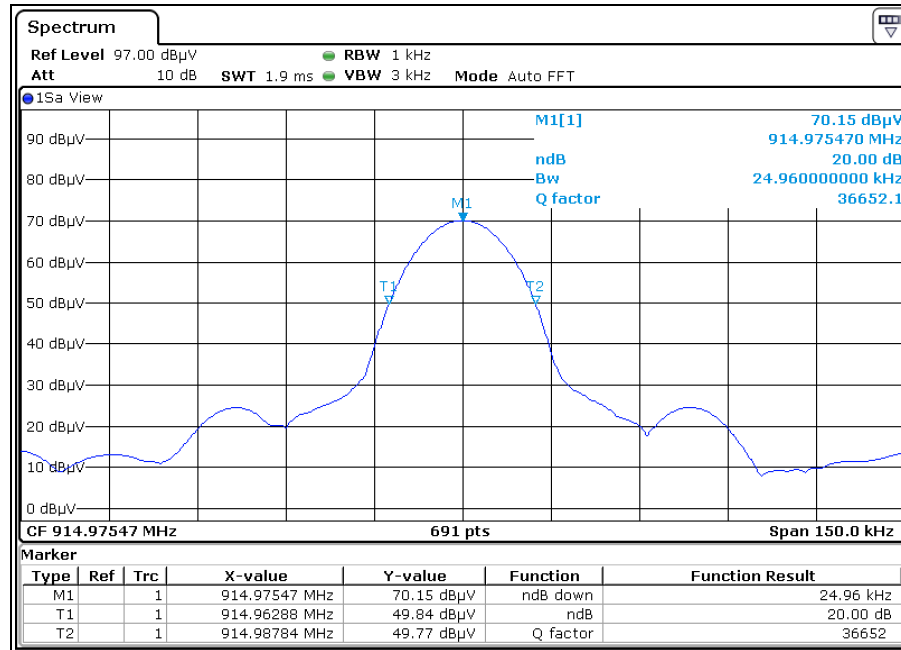

Test Data: High channel

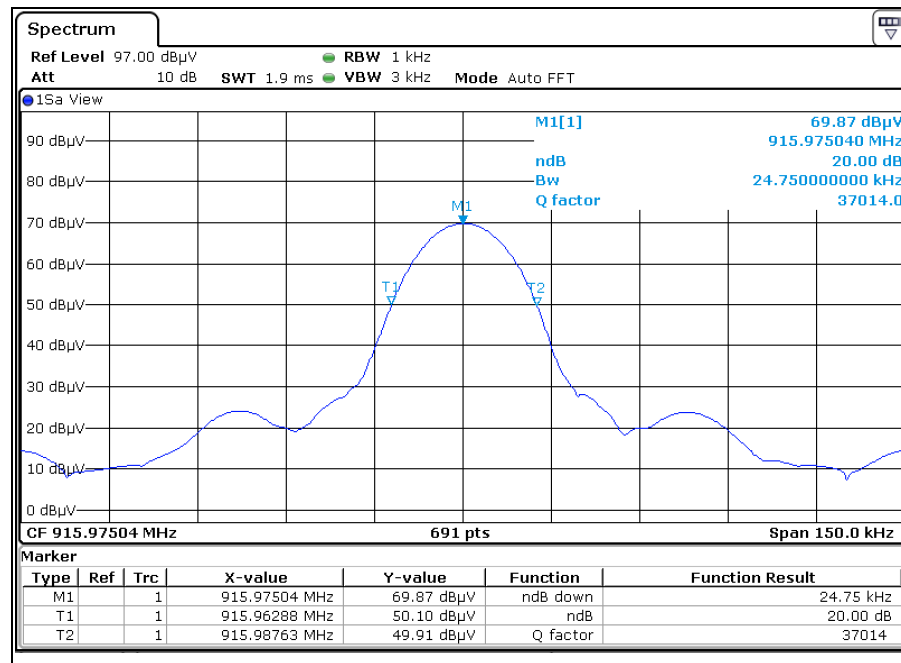



**BUREAU  
VERITAS**

Test Report No.: RF2305WDG0208-2

## 5. PHOTOGRAPHS OF THE TEST CONFIGURATION

Please refer to the attached file (Test Setup Photo).



## 6. APPENDIX A - MODIFICATIONS RECORDERS FOR ENGINEERING CHANGES TO THE EUT BY THE LAB

No any modifications are made to the EUT by the lab during the test.

**---END---**