

Appendix C: Photographs of EUT

Product: Intelligent battery charger

Model: 2973

Internal Photos

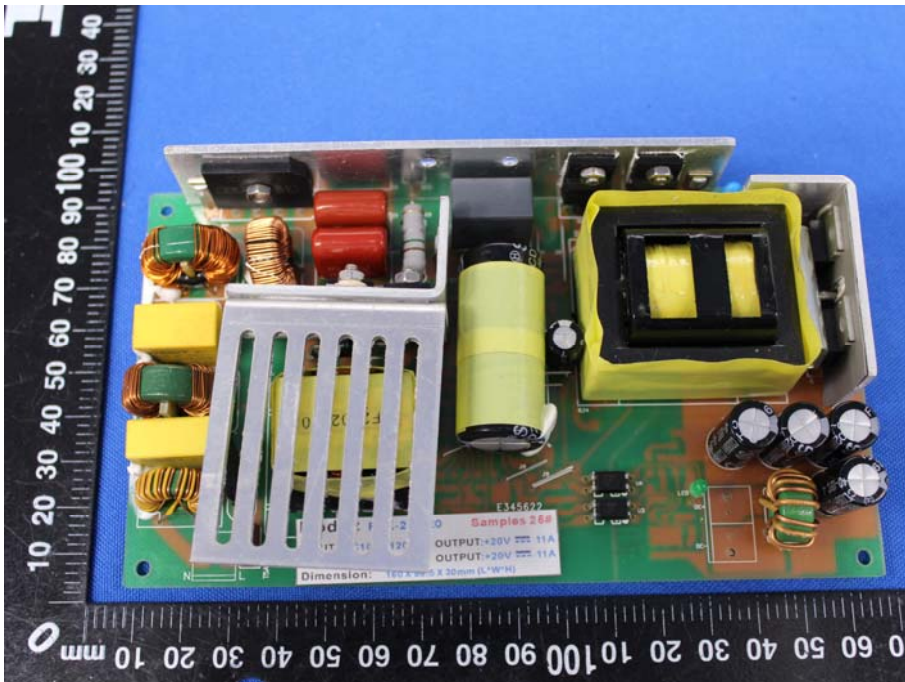

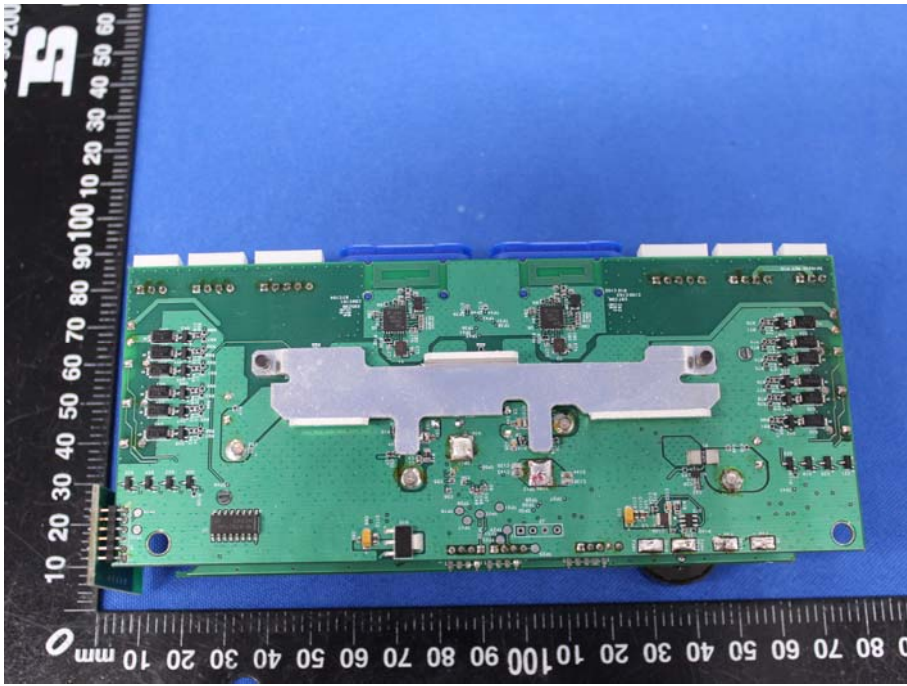
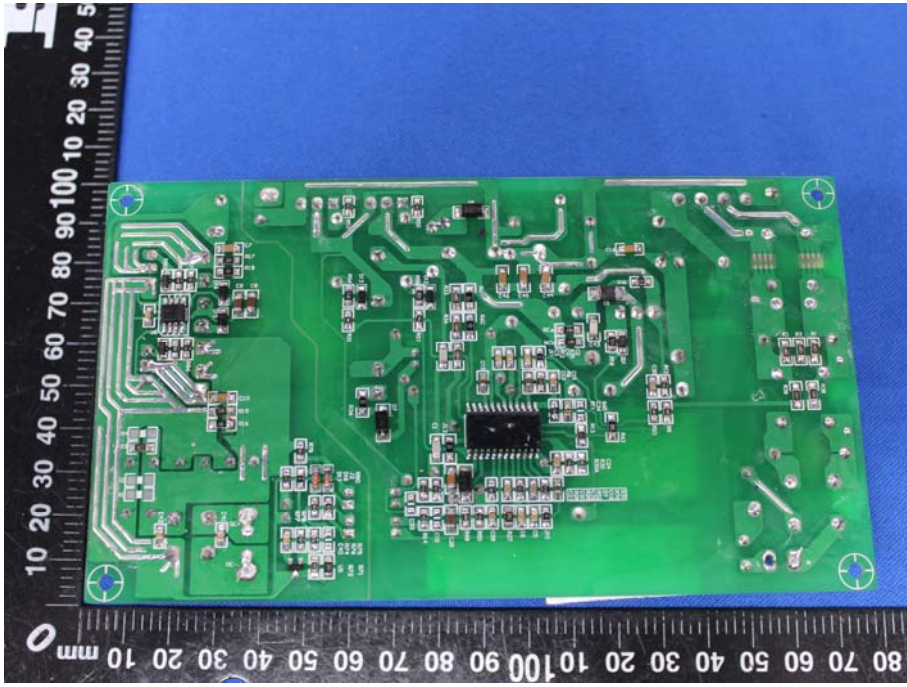

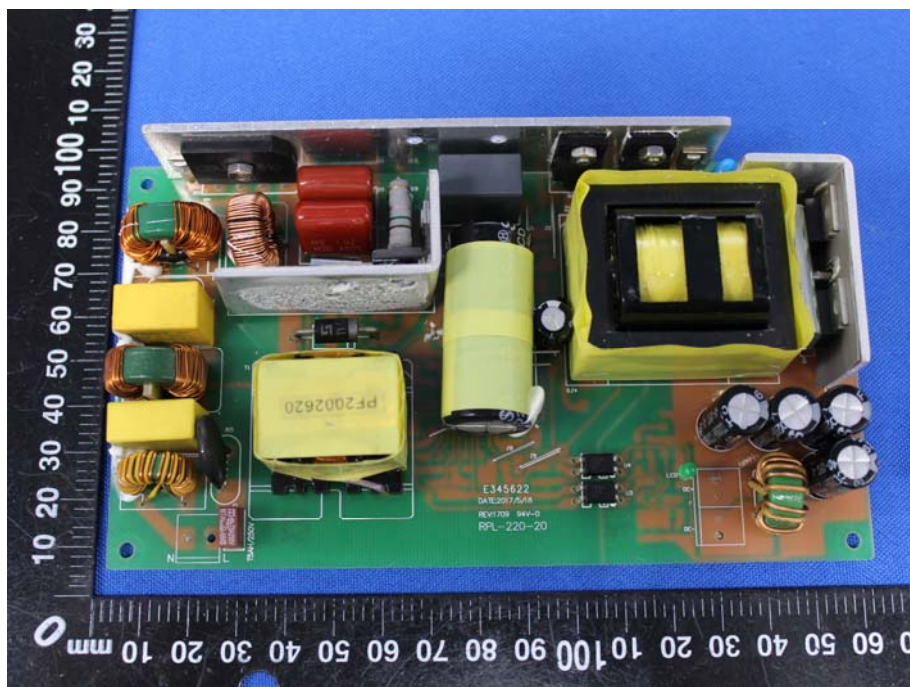
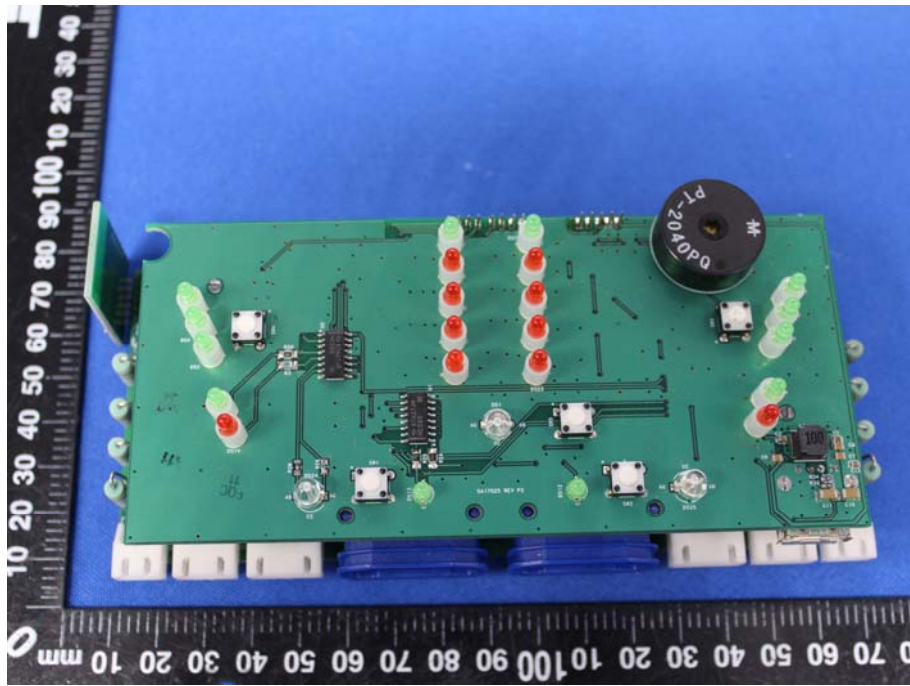

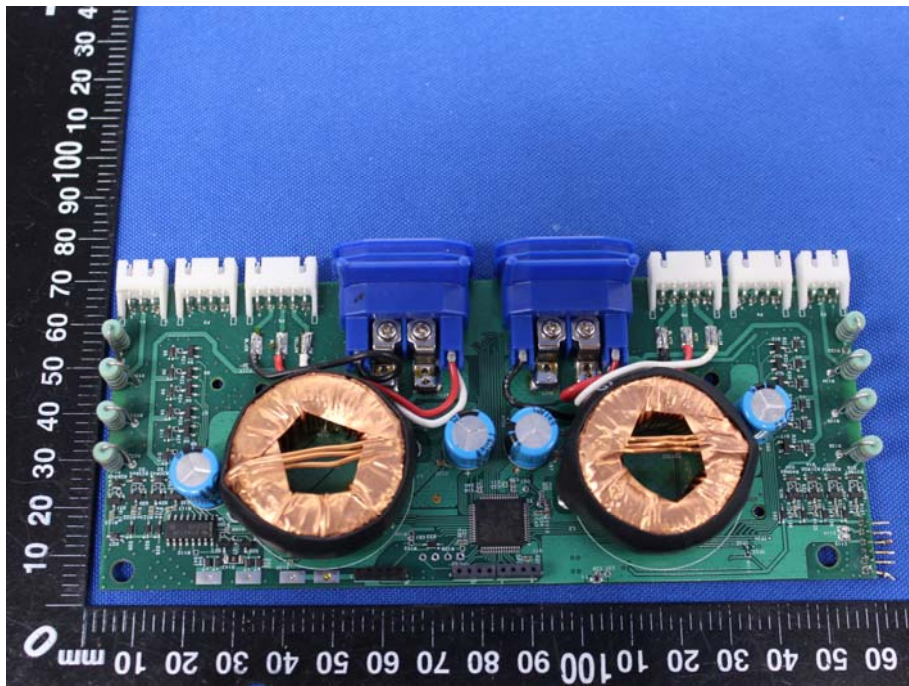
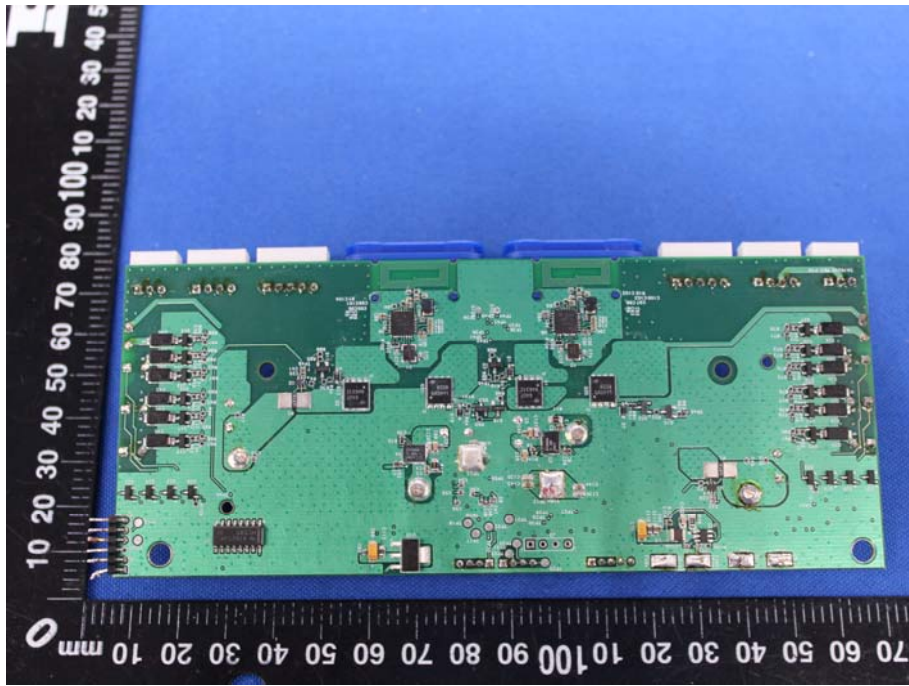

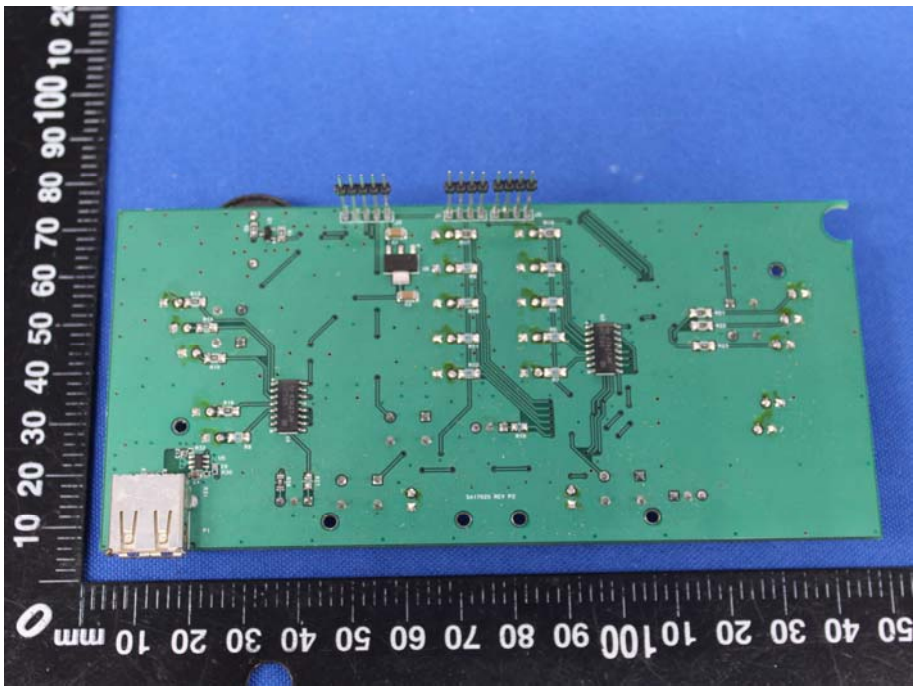
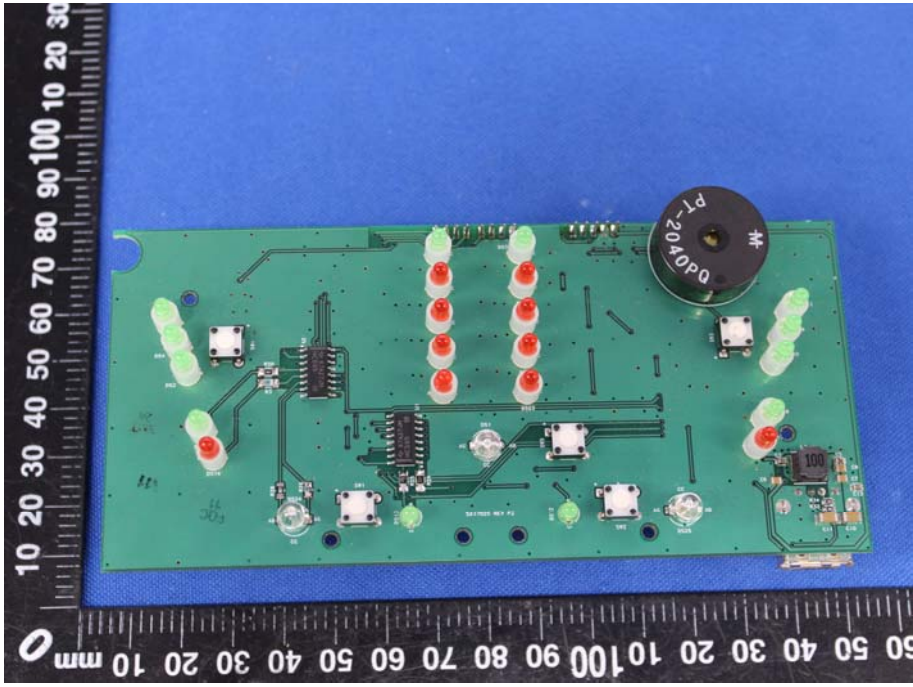

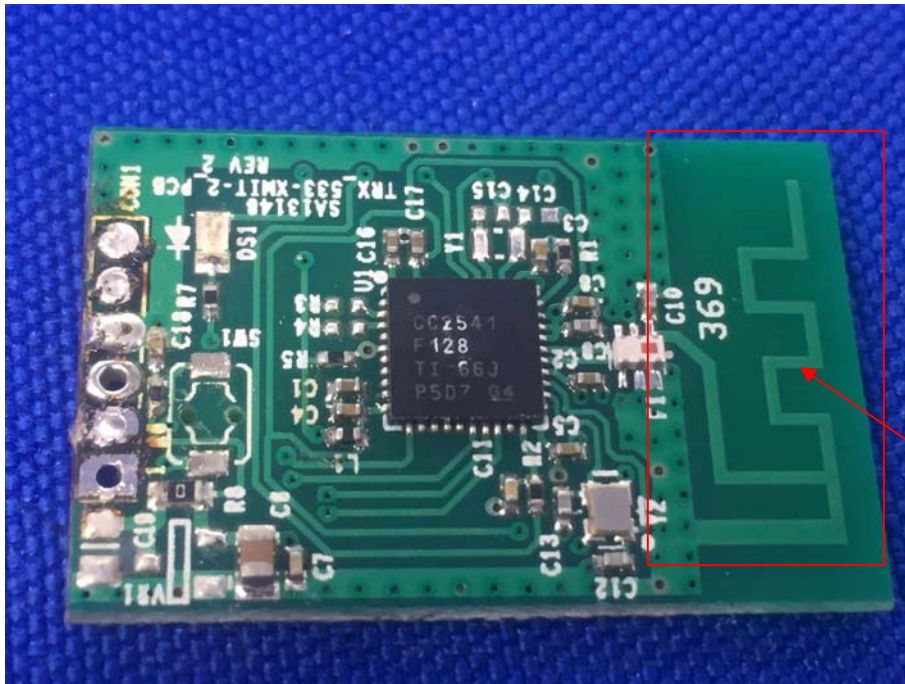

Antenna

