



**FCC 47 CFR PART 15 SUBPART C
ANSI C63.4: 2003**

TEST REPORT

For

Air Keyboard

Model Number: AVK-01

Data Applies To: AVK-02

Brand Name: 

Issued to

Holy Investment Co., Ltd.

1F., No.2, Lane 25, Yong-an 2nd St., Yongkang City, Tainan County 710, Taiwan

Issued by

Compliance Certification Services Inc.

Tainan Lab.

No. 8, Jiu Cheng Ling, Jiaokeng Village, Sinhua
Township, Tainan Hsien 712, Taiwan R.O.C.

TEL: 886-6-580-2201

FAX: 886-6-580-2202



Note: This report shall not be reproduced except in full, without the written approval of Compliance Certification Services Inc. This document may be altered or revised by Compliance Certification Services Inc. personnel only, and shall be noted in the revision section of the document.

Total: 59



REVISION HISTORY

Rev.	Issue Date	Revisions	Effect Page	Revised By
00	November 17, 2009	Initial Issue	ALL	Leah Peng



TABLE OF CONTENTS

1	TEST RESULT CERTIFICATION.....	4
2	EUT DESCRIPTION	5
3	TEST METHODOLOGY	6
3.1	EUT CONFIGURATION	6
3.2	EUT EXERCISE	6
3.3	GENERAL TEST PROCEDURES	6
3.4	FCC PART 15.205 RESTRICTED BANDS OF OPERATIONS	7
3.5	DESCRIPTION OF TEST MODES	8
4	INSTRUMENT CALIBRATION.....	8
5	FACILITIES AND ACCREDITATIONS	9
5.1	FACILITIES.....	9
5.2	EQUIPMENT	9
5.3	LABORATORY ACCREDITATIONS AND LISTING	9
5.4	TABLE OF ACCREDITATIONS AND LISTINGS	9
6	SETUP OF EQUIPMENT UNDER TEST	10
6.1	SETUP CONFIGURATION OF EUT	12
6.2	SUPPORT EQUIPMENT	12
7	FCC PART 15.247 REQUIREMENTS.....	13
7.1	6dB BANDWIDTH	13
7.2	PEAK POWER	16
7.3	BAND EDGES MEASUREMENT	19
7.4	PEAK POWER SPECTRAL DENSITY	23
7.5	RADIO FREQUENCY EXPOSURE	26
7.6	SPURIOUS EMISSIONS	28
7.7	POWER LINE CONDUCTED EMISSIONS	56
8	APPENDIX 1 PHOTOGRAPHS OF TEST SETUP	57



1 TEST RESULT CERTIFICATION

Applicant: Holy Investment Co., Ltd.
1F., No.2, Lane 25, Yong-an 2nd St., Yongkang City, Tainan County 710, Taiwan

Manufacture: Jow Tong Technology CO., LTD.
46, Lane 337, Chung Cheng Rd., Yung Kang City, Tainan County 710, Taiwan, R.O.C.

Equipment Under Test: Air Keyboard

Model Number: AVK-01

Data Applies To: AVK-02

Brand Name: 

Date of Test: September 10, 2009 ~ November 17, 2009

APPLICABLE STANDARDS	
STANDARD	TEST RESULT
FCC 47 CFR Part 15 Subpart C ANSI C63.4: 2003	No non-compliance noted

We hereby certify that:

The above equipment was tested by Compliance Certification Services Inc. The test data, data evaluation, test procedures, and equipment configurations shown in this report were made in accordance with the procedures given in ANSI C63.4 and the energy emitted by the sample EUT tested as described in this report is in compliance with the requirements of FCC Rules Part 15.207, 15.209, 15.247.

The test results of this report relate only to the tested sample EUT identified in this report.

Approved by:



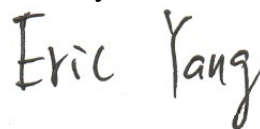

Jeter Wu
Section Manager
Compliance Certification Services Inc.

Reviewed by:



Eric Yang
Senior Engineer
Compliance Certification Services Inc.

2 EUT DESCRIPTION

Product	Air Keyboard		
Model Number	AVK-01		
Data Applies To	AVK-02		
Model Difference	Model	AVK-01	AVK-02
	External Photo		
Brand Name			
Model Discrepancy	N/A		
Frequency Band	902~928MHz		
Frequency Range	903 MHz ~926.8MHz		
Transmit Power	3.07 dBm (2.0277mW)		
Modulation Technique	2-FSK		
Number of Channels	18 Channels		
Antenna Specification	Small 870 PIFA Ceramic Chip Antenna for 700~1000MHz; Type: Base on actual PCB layout; Gain: 0.74dBi; Impedance: 50Ω; Brand: YAGEO		
Power Supply	Powered by battery DC3V (AA 1.5VDC * 2pcs.)		

Remark:

1. The sample selected for test was engineering sample that approximated to production product and was provided by manufacturer. This submittal(s) (test report) is intended for FCC ID: XV3AVK01) filing to comply with Section 15.207, 15.209 and 15.247 of the FCC Part 15, Subpart C Rules.
2. Based on RF technology, the dongle connect with PC port and communicate between PC and destination end devices such as dongle (FCC ID: XV3UD02) to control the multi-media program.

Channel list

Channel 1.	Channel 2.	Channel 3.	Channel 4.	Channel 5.	Channel 6.	Channel 7.	Channel 8.	Channel 9.
903.0 MHz	904.4 MHz	905.8 MHz	907.2 MHz	908.6 MHz	910.0 MHz	911.4 MHz	912.8 MHz	914.2 MHz

Channel 10.	Channel 11.	Channel 12.	Channel 13.	Channel 14.	Channel 15.	Channel 16.	Channel 17.	Channel 18.
915.6 MHz	917.0 MHz	918.4 MHz	919.8 MHz	921.2 MHz	922.6 MHz	924.0 MHz	925.4 MHz	926.8 MHz



3 TEST METHODOLOGY

The tests documented in this report were performed in accordance with ANSI C63.4 and FCC CFR 47 2.1046, 2.1047, 2.1049, 2.1051, 2.1053, 2.1055, 2.1057, 15.207, 15.209 and 15.247.

3.1 EUT CONFIGURATION

The EUT configuration for testing is installed on RF field strength measurement to meet the Commissions requirement and operating in a manner that intends to maximize its emission characteristics in a continuous normal application.

3.2 EUT EXERCISE

The EUT was operated in the engineering mode to fix the TX frequency that was for the purpose of the measurements.

According to its specifications, the EUT must comply with the requirements of the Section 15.207, 15.209 and 15.247 under the FCC Rules Part 15 Subpart C.

3.3 GENERAL TEST PROCEDURES

Conducted Emissions

The EUT is placed on the turntable, which is 0.8 m above ground plane. According to the requirements in Section 13.1.4.1 of ANSI C63.4 Conducted emissions from the EUT measured in the frequency range between 0.15 MHz and 30MHz using CISPR Quasi-peak and average detector modes.

Radiated Emissions

The EUT is placed on a turn table, which is 0.8 m above ground plane. The turntable shall rotate 360 degrees to determine the position of maximum emission level. EUT is set 3m away from the receiving antenna, which varied from 1m to 4m to find out the highest emission. And also, each emission was to be maximized by changing the polarization of receiving antenna both horizontal and vertical. In order to find out the maximum emissions, exploratory radiated emission measurements were made according to the requirements in Section 13.1.4.1 of ANSI C63.4.



3.4 FCC PART 15.205 RESTRICTED BANDS OF OPERATIONS

(a) Except as shown in paragraph (d) of this section, only spurious emissions are permitted in any of the frequency bands listed below:

MHz	MHz	MHz	GHz
0.090 - 0.110	16.42 - 16.423	399.9 - 410	4.5 - 5.15
¹ 0.495 - 0.505	16.69475 - 16.69525	608 - 614	5.35 - 5.46
2.1735 - 2.1905	16.80425 - 16.80475	960 - 1240	7.25 - 7.75
4.125 - 4.128	25.5 - 25.67	1300 - 1427	8.025 - 8.5
4.17725 - 4.17775	37.5 - 38.25	1435 - 1626.5	9.0 - 9.2
4.20725 - 4.20775	73 - 74.6	1645.5 - 1646.5	9.3 - 9.5
6.215 - 6.218	74.8 - 75.2	1660 - 1710	10.6 - 12.7
6.26775 - 6.26825	108 - 121.94	1718.8 - 1722.2	13.25 - 13.4
6.31175 - 6.31225	123 - 138	2200 - 2300	14.47 - 14.5
8.291 - 8.294	149.9 - 150.05	2310 - 2390	15.35 - 16.2
8.362 - 8.366	156.52475 -	2483.5 - 2500	17.7 - 21.4
8.37625 - 8.38675	156.52525	2655 - 2900	22.01 - 23.12
8.41425 - 8.41475	156.7 - 156.9	3260 - 3267	23.6 - 24.0
12.29 - 12.293	162.0125 - 167.17	3332 - 3339	31.2 - 31.8
12.51975 - 12.52025	167.72 - 173.2	3345.8 - 3358	36.43 - 36.5
12.57675 - 12.57725	240 - 285	3600 - 4400	(²)
13.36 - 13.41	322 - 335.4		

¹ Until February 1, 1999, this restricted band shall be 0.490-0.510 MHz.

² Above 38.6

(b) Except as provided in paragraphs (d) and (e), the field strength of emissions appearing within these frequency bands shall not exceed the limits shown in Section 15.209. At frequencies equal to or less than 1000 MHz, compliance with the limits in Section 15.209 shall be demonstrated using measurement instrumentation employing a CISPR quasi-peak detector. Above 1000 MHz, compliance with the emission limits in Section 15.209 shall be demonstrated based on the average value of the measured emissions. The provisions in Section 15.35 apply to these measurements.



3.5 DESCRIPTION OF TEST MODES

The EUT (Model: AVK-01) have been tested under operating condition.

Software detects used to control the EUT for staying in continuous transmitting and receiving mode is programmed.

The worse case (Modulation Technique) is as the following: 2-FSK

Channel	Frequency (MHz)
Low	903
Middle	915.6
High	926.8

4 INSTRUMENT CALIBRATION

The measuring equipment, which was utilized in performing the tests documented herein, has been calibrated in accordance with the manufacturer's recommendations for utilizing calibration equipment, which is traceable to recognized national standards.



5 FACILITIES AND ACCREDITATIONS

5.1 FACILITIES

All measurement facilities used to collect the measurement data are located at

No. 8, Jiu Cheng Ling, Jiaokeng Village, Sinhua Township, Tainan Hsien 712, Taiwan R.O.C.

The sites are constructed in conformance with the requirements of ANSI C63.7, ANSI C63.4 and CISPR Publication 22.

5.2 EQUIPMENT

Radiated emissions are measured with one or more of the following types of linearly polarized antennas: tuned dipole, biconical, log periodic, bi-log, and/or ridged waveguide, horn. Spectrum analyzers with pre-selectors and quasi-peak detectors are used to perform radiated measurements.

Conducted emissions are measured with Line Impedance Stabilization Networks and EMI Test Receivers.





Calibrated wideband preamplifiers, coaxial cables, and coaxial attenuators are also used for making measurements.

All receiving equipment conforms to CISPR Publication 16-1, "Radio Interference Measuring Apparatus and Measurement Methods."

5.3 LABORATORY ACCREDITATIONS AND LISTING

The test facilities used to perform radiated and conducted emissions tests are accredited by Taiwan Accreditation Foundation for the specific scope of accreditation under Lab Code: 1109 to perform Electromagnetic Interference tests according to FCC Part 15 and CISPR 22 requirements. No part of this report may be used to claim or imply product endorsement by TAF or any agency of the US Government. In addition, the test facilities are listed with Federal Communications Commission (registration no.: TW-1037).

5.4 TABLE OF ACCREDITATIONS AND LISTINGS

Country	Agency	Scope of Accreditation	Logo
USA	FCC	3/10 meter Open Area Test Sites to perform FCC Part 15/18 measurements	 TW-1037
Japan	VCCI	3/10 meter Open Area Test Sites and conducted test sites to perform radiated/conducted measurements	 C-2882 R-2635
Taiwan	TAF	CISPR 11, FCC METHOD-47 CFR Part 18, EN 55011, EN 60601-1-2, CISPR 22, CNS 13438, EN 55022, EN 55024, AS/NZS CISPR 22 CISPR 14, EN 55014-1, EN 55014-2, CNS 13783-1, CISPR 22, CNS 13439, EN 55013, FCC Method-47 CFR Part 15 Subpart B, IC ICES-003, VCCI V-3 & V-4 FCC Method-47 CFR Part 15 Subpart C and ANSI C63.4, LP 0002 EN / IEC 61000-4-2 / -3 / -4 / -5 / -6 / -8 / -11 EN 61000-3-2, EN 61000-3-3 EN 61000-6-3, EN 61000-6-1, AS/NZS 4251.1, EN 61000-6-4, EN 61000-6-2, AS/NZS 4251.2, EN 61204-3, EN 50130-4, EN 62040-2, EN 50371, EN 50385, AS/NZS 4268, ETSI EN 300 386 ETSI EN 300 328, ETSI EN 301 489-1/-3/-9/-17 ETSI EN 300 220-2/-1 ETSI EN 300 440-2/-1 ETSI EN 301 357-2/-1 RSS-310, RSS-210 Issue 7, RSS-Gen Issue 2	
Taiwan	BSMI	CNS 13438, CNS 13783-1, CNS13439	 SL2-IN-E-0039 SL2-R1/R2-0039 SL2-A1-E-0039
Canada	Industry Canada	RSS210, Issue 7	 IC 2324H-1

* No part of this report may be used to claim or imply product endorsement by TAF or any agency of the US Government.



6 6. CALIBRATION AND UNCERTAINTY

6.1 MEASURING INSTRUMENT CALIBRATION

The measuring equipment utilized to perform the tests documented in this report has been calibrated in accordance with the manufacturer's recommendations, and is traceable to recognized national standards.

6.2 MEASUREMENT UNCERTAINTY

Where relevant, the following measurement uncertainty levels have been estimated for tests performed on the apparatus:

PARAMETER	UNCERTAINTY
Radiated Emission, 30 to 1000 MHz	+/- 3.2 dB
Radiated Emission, 1 to 26.5 GHz	+/- 3.2 dB
Power Line Conducted Emission	+/- 2.1 dB

This measurement uncertainty is confidence of approximately 95%, k=2

7 SETUP OF EQUIPMENT UNDER TEST

7.1 SETUP CONFIGURATION OF EUT

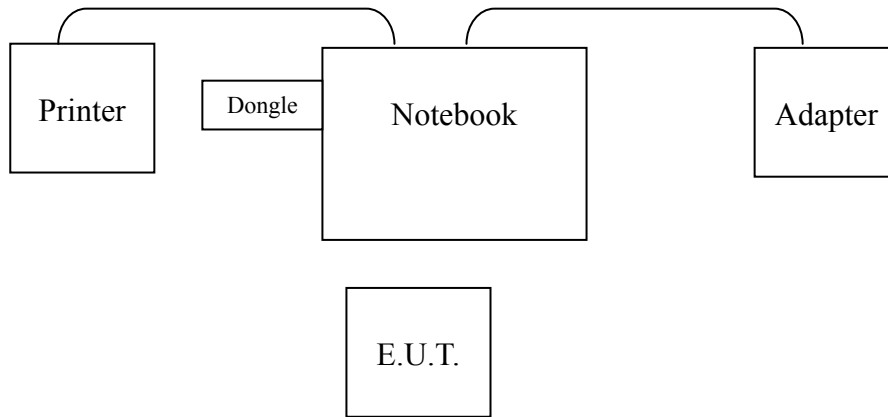

7.2 SUPPORT EQUIPMENT

No.	Product	Manufacturer	Model No.	Certify No.	Signal cable
1	Printer	EPSON	EPSON C43UX	DOC	Printer cable, shd, 1.8m
2	Note Book	IBM	T43	DOC	Power cable, unshd, 1.6m
3	Air Dongle	JTTEL	UD-02	XV3UD02	N/A

No.	Cable	Signal description
A	-	-

REMARK:

1. All the equipment/cables were placed in the worst-case configuration to maximize the emission during the test.
2. Grounding was established in accordance with the manufacturer's requirements and conditions for the intended use.



8 FCC PART 15.247 REQUIREMENTS

8.1 6DB BANDWIDTH

LIMIT

For the direct sequence systems, the minimum 6dB bandwidth shall be at least 500kHz.

MEASUREMENT EQUIPMENT USED

Name of Equipment	Manufacturer	Model	Serial Number	Calibration Due
Spectrum Analyzer	R&S	FSEK 30	835253/002	OCT. 25, 2010

REMARK: Each piece of equipment is scheduled for calibration once a year.

TEST CONFIGURATION

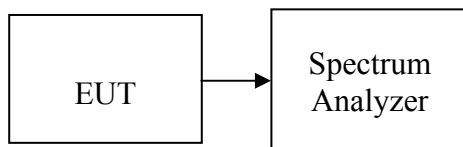

TEST PROCEDURE

1. Place the EUT on the table and set it in the transmitting mode.
2. Remove the antenna from the EUT and then connect a low loss RF cable from the antenna port to the spectrum analyzer.
3. Set the spectrum analyzer as RBW = 100kHz, VBW = RBW, Span = 2MHz, Sweep = auto.
4. Mark the peak frequency and -6dB (upper and lower) frequency.
5. Repeat until all the rest channels are investigated.
6. Offset=Cable loss=11.7 dB

TEST RESULTS

No non-compliance noted.

TEST DATA

Channel	Frequency (MHz)	Bandwidth (kHz)	Limit (kHz)	Margin (kHz)
CH Low	903	504.916	>500	PASS
CH Mid	915.6	501.002	>500	PASS
CH High	926.8	504.916	>500	PASS



TEST PLOT

6dB Bandwidth (CH Low)

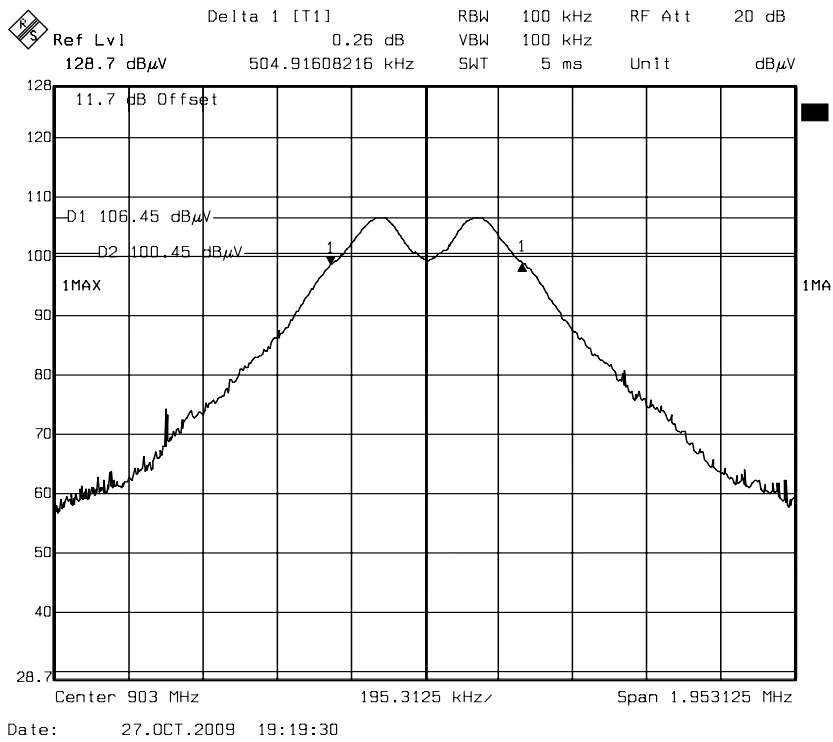

6dB Bandwidth (CH Mid)

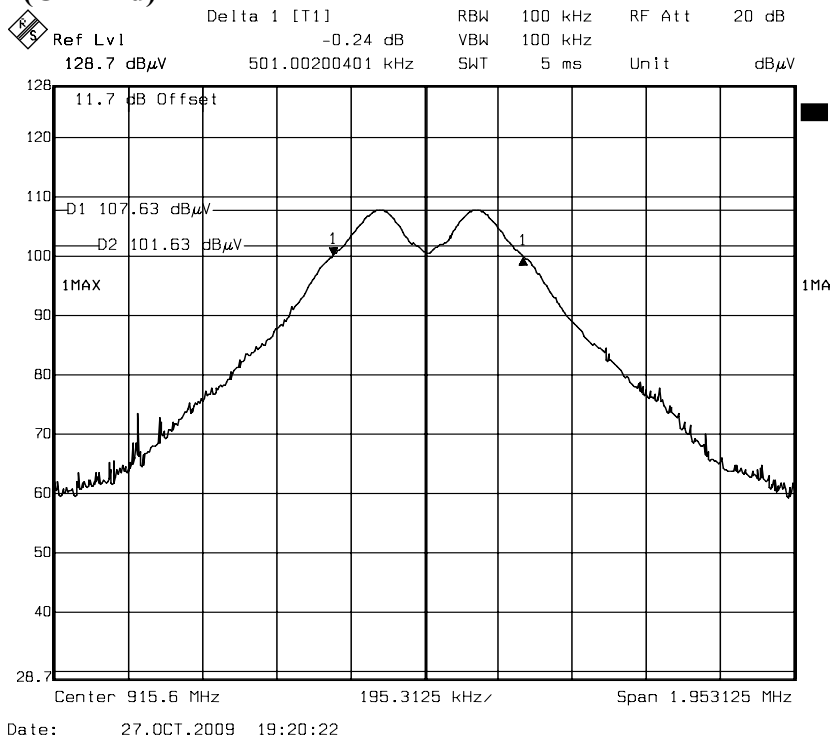



6dB Bandwidth (CH High)

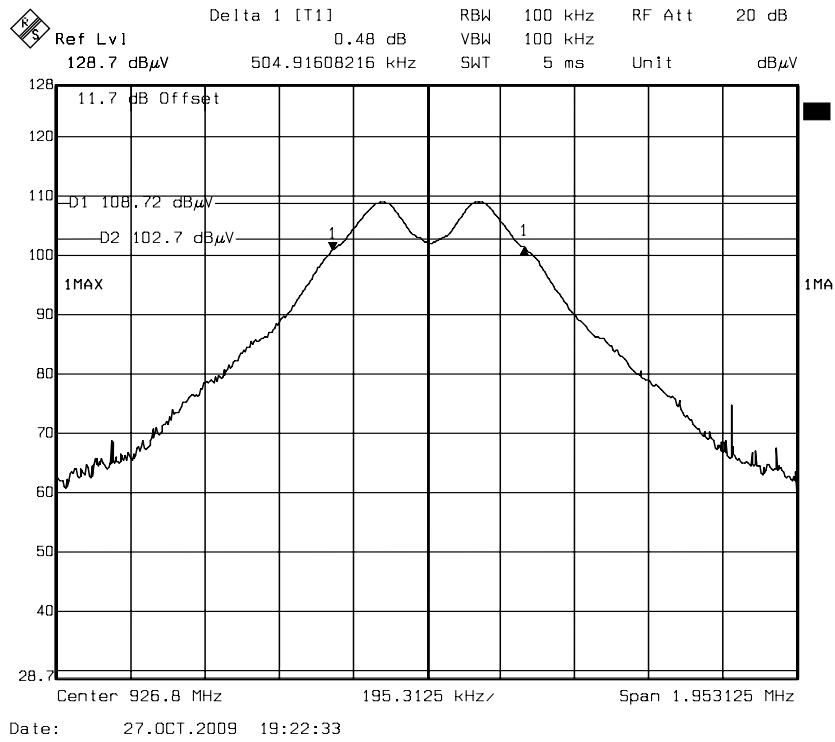



8.2 PEAK POWER

LIMIT

The maximum peak output power of the intentional radiator shall not exceed the following:

1. For systems using digital modulation in the bands of 902-928 MHz, 2400-2483.5 MHz, and 5725-5850 MHz: 1 watt.
2. Except as shown in paragraphs (b)(3) (i), (ii) and (iii) of this section, if transmitting antennas of directional gain greater than 6 dBi are used the peak output power from the intentional radiator shall be reduced below the stated values in paragraphs (b)(1) or (b)(2) of this section, as appropriate, by the amount in dB that the directional gain of the antenna exceeds 6 dBi.

MEASUREMENT EQUIPMENT USED

Name of Equipment	Manufacturer	Model	Serial Number	Calibration Due
Spectrum Analyzer	R&S	FSEK 30	835253/002	OCT. 25, 2010

REMARK: Each piece of equipment is scheduled for calibration once a year.

TEST CONFIGURATION

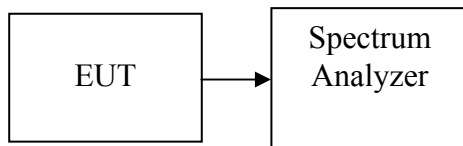

TEST PROCEDURE

1. Place the EUT on the table and set it in transmitting mode
Remove the antenna from the EUT and then connect a low loss RF cable from the antenna port to the spectrum analyzer.
2. Set the spectrum analyzer as RBW = 1MHz, VBW = 3MHz, Span = 10MHz, Sweep=AUTO
3. Record the max. reading
4. Repeat the above procedure until the measurements for all frequencies are completed.
5. Offset=Cable loss=11.7 dB

TEST RESULTS

No non-compliance noted

TEST DATA

Channel	Frequency (MHz)	Reading (dBm)	Output Power(dBm)	Output Power(W)	Limit(W)	Result
Low	903	-0.33	0.67	0.00117	1	PASS
Mid	915.6	0.88	1.88	0.00154	1	PASS
High	926.8	2.07	3.07	0.00203	1	PASS



TEST PLOT

Peak power (CH Low)

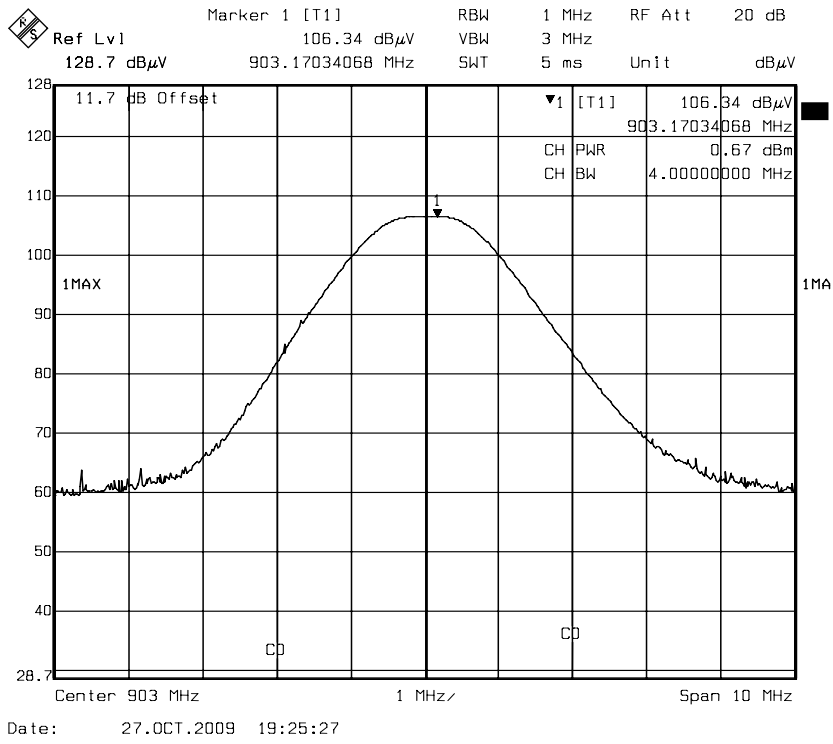

Peak power (CH Mid)

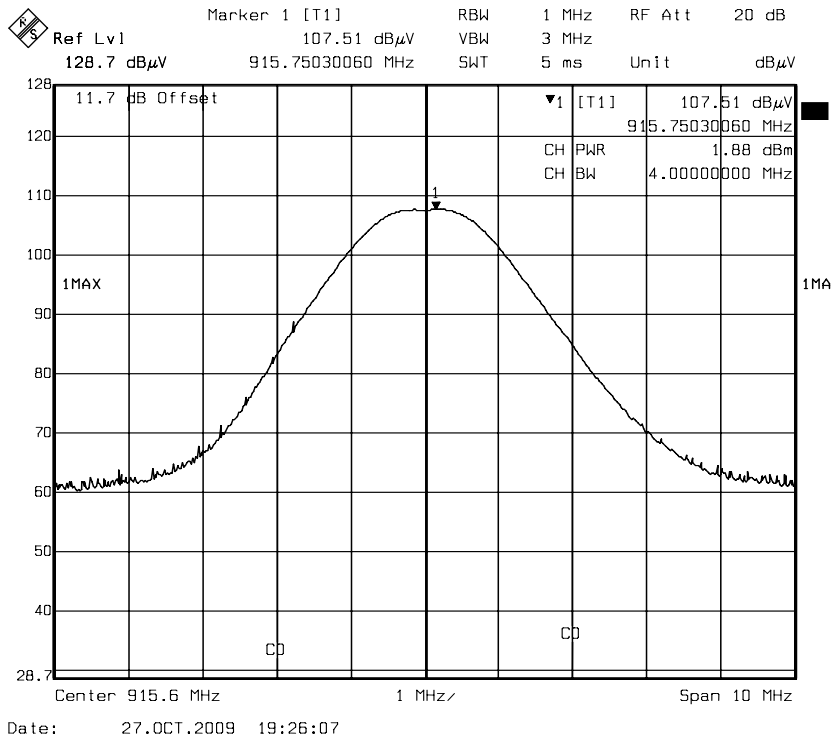



Peak power (CH High)

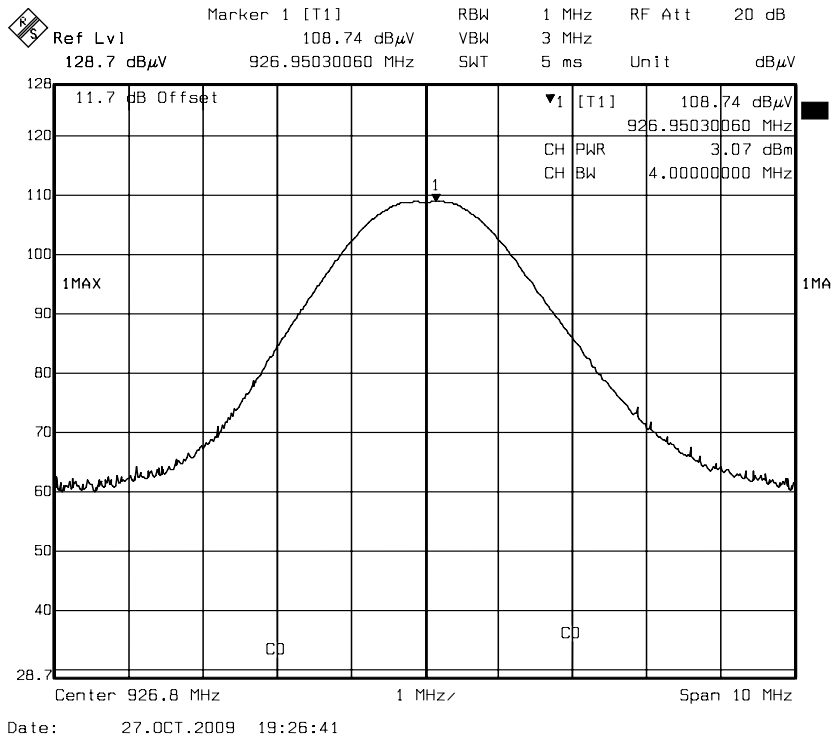



8.3 BAND EDGES MEASUREMENT

LIMIT

According to §15.247(d), in any 100 kHz bandwidth outside the frequency bands in which the spread spectrum intentional radiator is operating, the radio frequency power that is produced by the intentional radiator shall be at least 20dB below that in the 100kHz bandwidth within the band that contains the highest level of the desired power. In addition, radiated emissions which fall in the restricted bands, as defined in §15.205(a), must also comply with the radiated emission limits specified in 15.209(a). The spectrum plots include reference levels of 54 and 74 dBµV. It would appear that the intention of these reference levels is to demonstrate compliance with the restricted band radiated emission limits of 54 and 74 dBµV/m, i.e. field strength values and not absolute voltage levels.

MEASUREMENT EQUIPMENT USED

Open Area Test Site # 6				
Name of Equipment	Manufacturer	Model	Serial Number	Calibration Due
TYPE N COAXIAL CABLE	SUHNER	CHA9513	6	AUG. 31, 2010
EMI Receiver	R&S	ESVS10	833206/012	APR. 28, 2010
Spectrum Analyzer	R&S	FSEK 30	835253/002	OCT. 25, 2010
BI-LOG Antenna	Sunol	JB1	A070506-2	SEP. 8, 2010
Horn Antenna	Com-Power	AH-118	071032	DEC. 22, 2009
SMA RF CABLE	SUHNER	SUCOFLEX104PEA	20520/4PEA	NOV. 12, 2010
Pre-Amplifier	MITEQ	AFS44-00108650-42-10P-4 4	1205908	OCT. 23, 2010
Signal Generator	HP	8673C	2938A00663	AUG. 25, 2010
Pre-Amplifier	HP	8447F	2944A03817	NOV. 01, 2010
Turn Table	Yo Chen	001	-----	N.C.R.
Antenna Tower	AR	TP1000A	309874	N.C.R.
Controller	CT	SC101	-----	N.C.R.
Test S/W	e-3 (5.04303e)			

REMARK: Each piece of equipment is scheduled for calibration once a year.

TEST CONFIGURATION

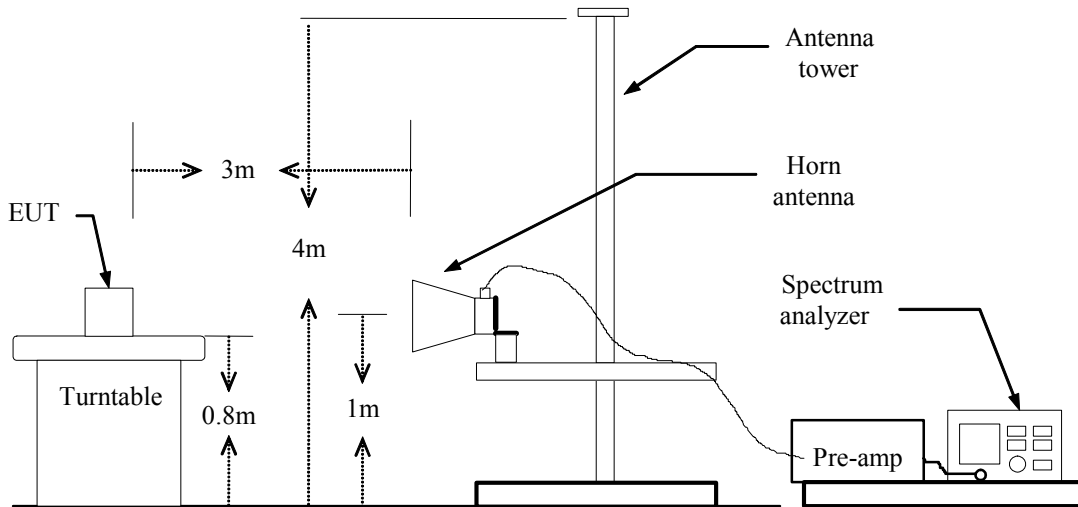

TEST PROCEDURE

1. The EUT is placed on a turntable, which is 0.8m above the ground plane.
2. The turntable shall be rotated for 360 degrees to determine the position of maximum emission level.
3. EUT is set 3m away from the receiving antenna, which is varied from 1m to 4m to find out the highest emission.
4. Set the spectrum analyzer in the following setting in order to capture the lower and upper band-edges of the emission:
 - (a) PEAK: RBW=VBW=1MHz / Sweep=AUTO
 - (b) AVERAGE: RBW=1MHz / VBW=10Hz / Sweep=AUTO
5. Repeat the procedures until all the PEAK and AVERAGE versus POLARIZATION are measured.
6. Offset : Antenna Factor + Cable Loss - Amplifier GAIN

TEST RESULTS

Refer to attach spectrum analyzer data chart.



Band Edges (CH Low)

Detector mode: Peak Polarity: Vertical

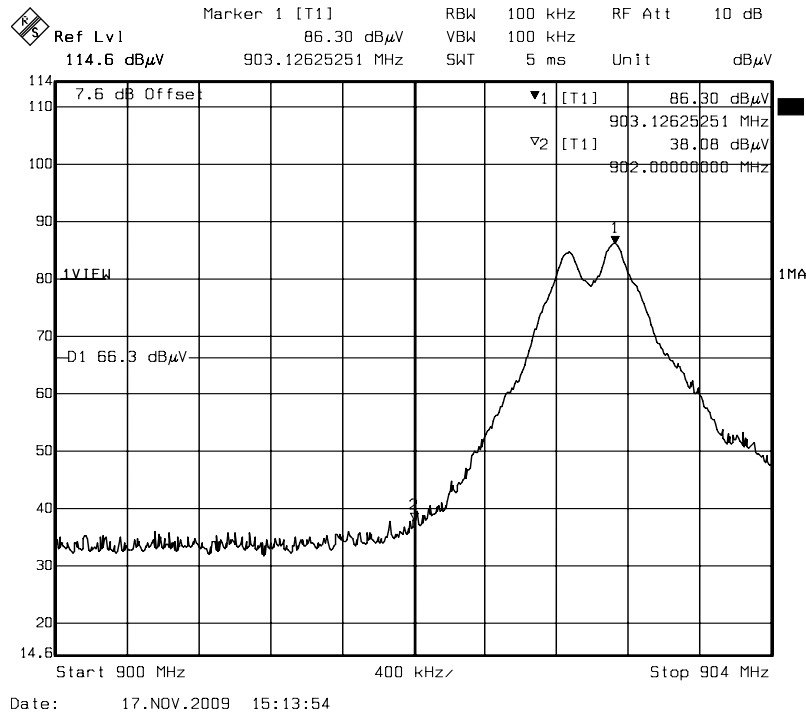

Detector mode: Peak Polarity: Horizontal

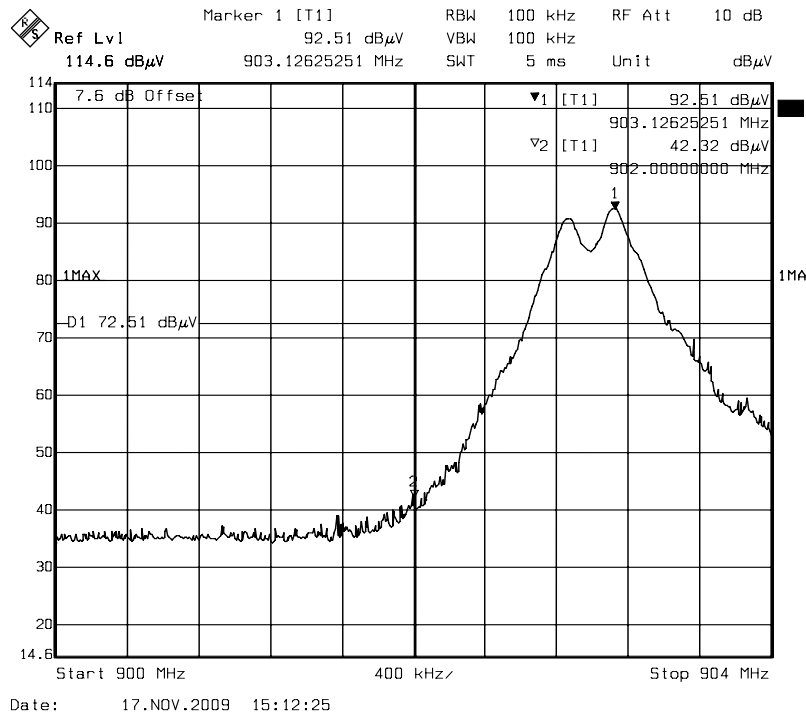



Band Edges (CH High)

Detector mode: Peak Polarity: Vertical

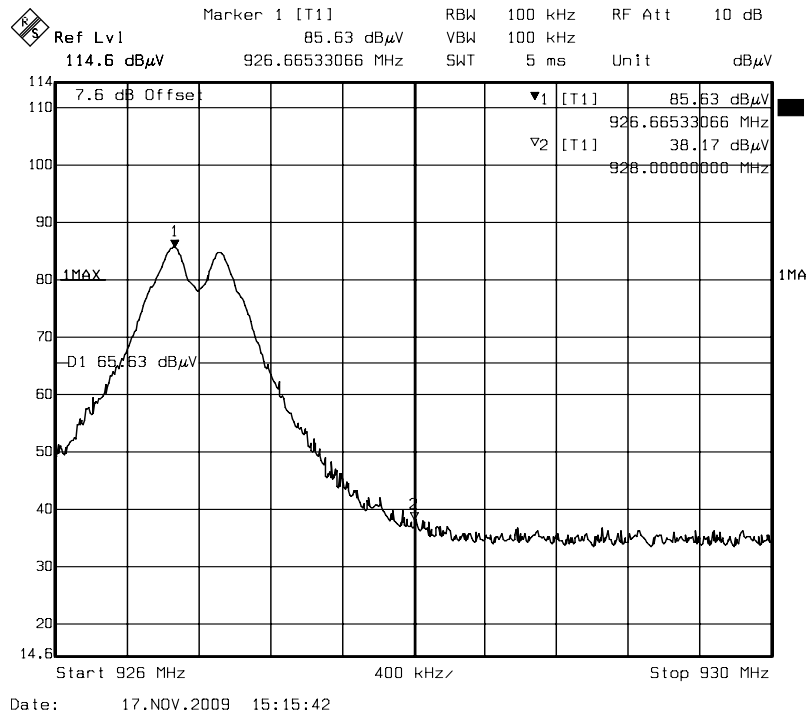

Detector mode: Peak Polarity: Horizontal

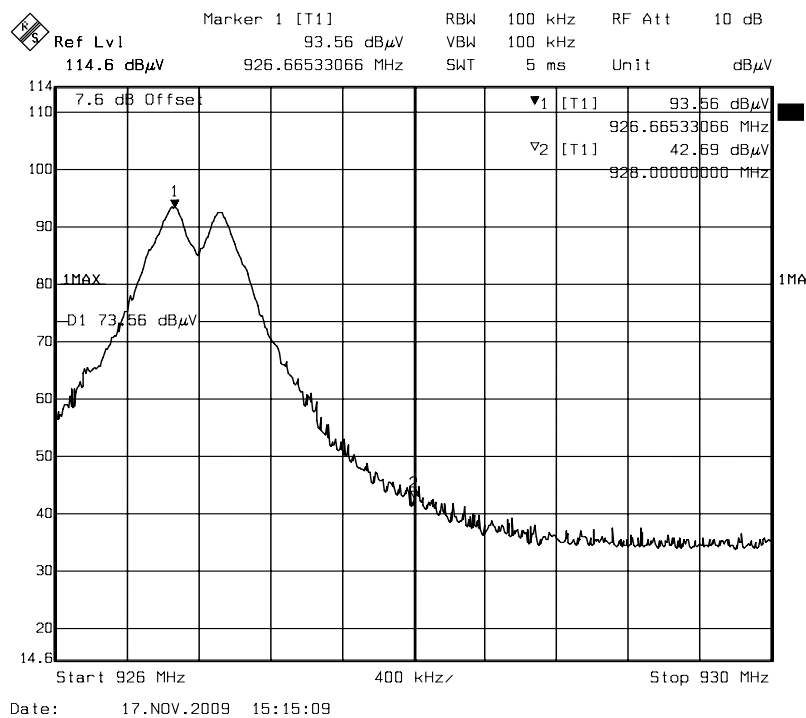



8.4 PEAK POWER SPECTRAL DENSITY

LIMIT

1. For direct sequence systems, the peak power spectral density conducted from the intentional radiator to the antenna shall not be greater than 8dBm in any 3kHz band during any time interval of continuous transmission.
2. The direct sequence operating of the hybrid system, with the frequency hopping operation turned off, shall comply with the power density requirements of paragraph (d) of this section.

MEASUREMENT EQUIPMENT USED

Name of Equipment	Manufacturer	Model	Serial Number	Calibration Due
Spectrum Analyzer	R&S	FSEK 30	835253/002	OCT. 25, 2010

REMARK: Each piece of equipment is scheduled for calibration once a year.

TEST CONFIGURATION

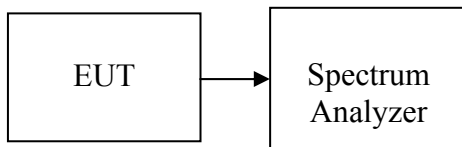

TEST PROCEDURE

1. Place the EUT on the table and set it in transmitting mode.
Remove the antenna from the EUT and then connect a low loss RF cable from the antenna port to the spectrum analyzer.
2. Set the spectrum analyzer as RBW = 3kHz, VBW = 10kHz, Span = 300kHz, Sweep=100s
3. Record the max. reading.
4. Repeat the above procedure until the measurements for all frequencies are completed.
5. Offset=Cable loss=11.7 dB

TEST RESULTS

No non-compliance noted

TEST DATA

Channel	Frequency (MHz)	PPSD (dBm)	Limit (dBm)	Result
Low	903	-4.28	8	PASS
Mid	915.6	-3.05	8	PASS
High	926.8	-1.91	8	PASS



TEST PLOT

PPSD (CH Low)

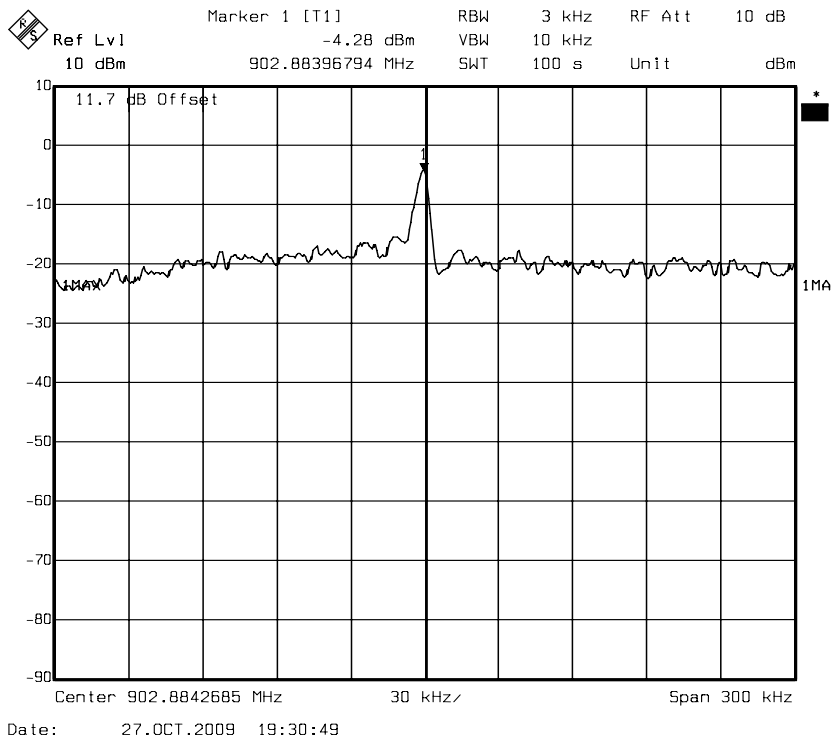

PPSD (CH Mid)

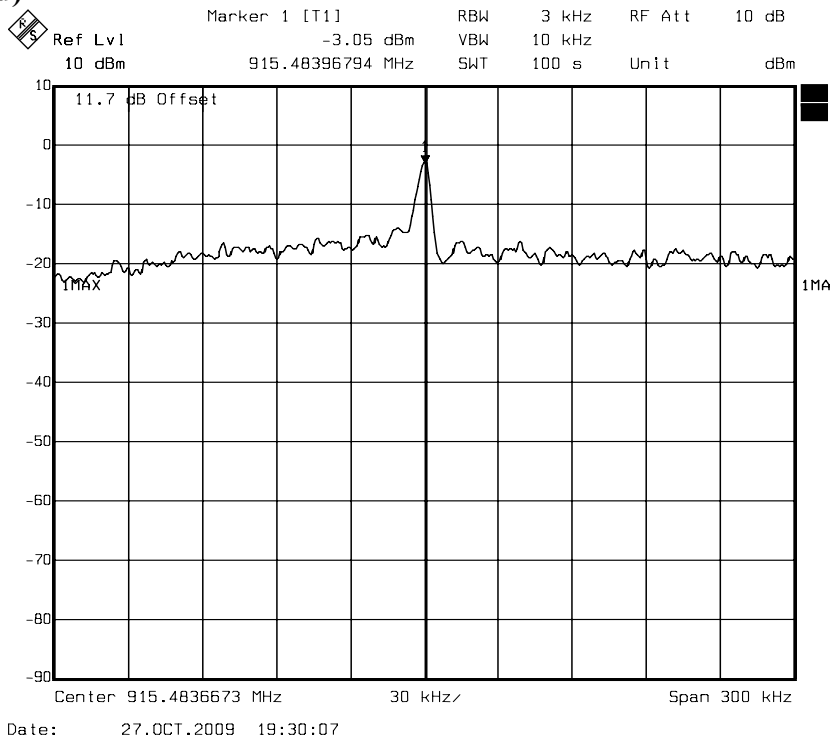



PPSD (CH High)

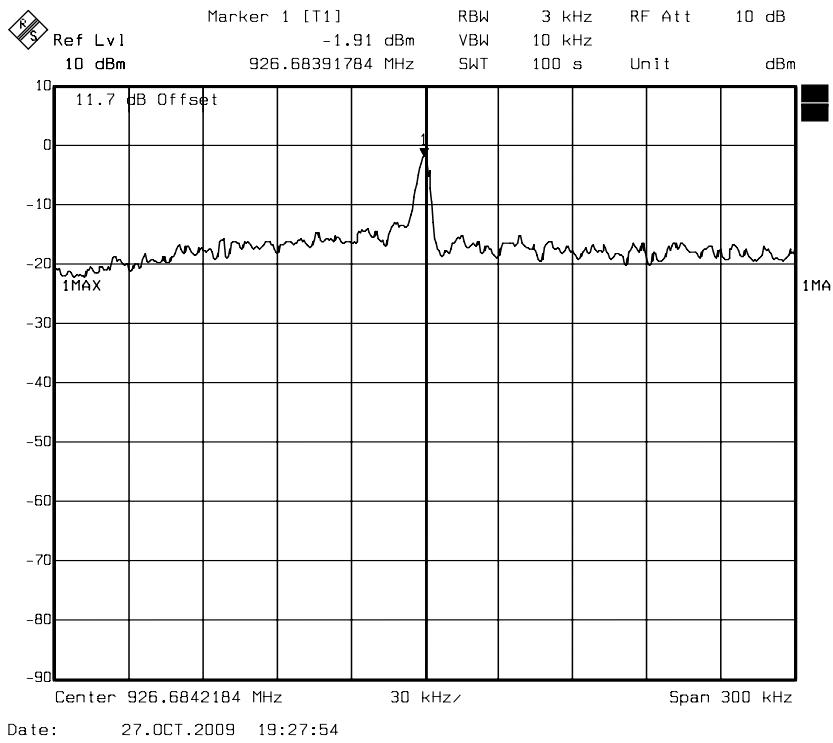



8.5 RADIO FREQUENCY EXPOSURE

LIMIT

Systems operating under the provisions of this section shall be operated in a manner that ensures that the public is not exposed to radio frequency energy levels in excess of the Commission's guidelines. See §15.247(i) and §1.1307(b)(1) of this chapter.

EUT Specification

EUT	Air Keyboard
Frequency band (Operating)	<input type="checkbox"/> WLAN: 2.412GHz ~ 2.462GHz <input type="checkbox"/> WLAN: 5.18GHz ~ 5.32GHz / 5.50GHz ~ 5.70GHz <input type="checkbox"/> WLAN: 5.745GHz ~ 5.825GHz <input checked="" type="checkbox"/> Others: 902MHz~928MHz
Device category	<input type="checkbox"/> Portable (<20cm separation) <input checked="" type="checkbox"/> Mobile (>20cm separation) <input type="checkbox"/> Others
Exposure classification	<input type="checkbox"/> Occupational/Controlled exposure (S = 5mW/cm2) <input checked="" type="checkbox"/> General Population/Uncontrolled exposure (S=1mW/cm2)
Antenna diversity	<input type="checkbox"/> Single antenna <input checked="" type="checkbox"/> Multiple antennas <input type="checkbox"/> Tx diversity <input type="checkbox"/> Rx diversity <input checked="" type="checkbox"/> Tx/Rx diversity
Max. output power	3.07dBm (2.0277 mW)
Antenna gain (Max)	0.74 dBi (Numeric gain: 1.1857)
Evaluation applied	<input checked="" type="checkbox"/> MPE Evaluation <input type="checkbox"/> SAR Evaluation

Remark:

1. The maximum output power is 3.07(2.0277mW) at 926.8MHz (with 1.1857 numeric antenna gain.)
2. DTS device is not subject to routine RF evaluation; MPE estimate is used to justify the compliance.
3. For mobile or fixed location transmitters, no SAR consideration applied. The minimum separation generally be used is at least 20 cm, even if the calculations indicate that the MPE distance would be lesser.

TEST RESULTS

No non-compliance noted.



CALCULATION

Given

$$E = \frac{\sqrt{30 \times P \times G}}{d} \quad \& \quad S = \frac{E^2}{3770}$$

- Where *E* = Field strength in Volts / meter
P = Power in Watts
G = Numeric antenna gain
d = Distance in meters
S = Power density in milliwatts / square centimeter

Combining equations and re-arranging the terms to express the distance as a function of the remaining variables yields:

$$S = \frac{30 \times P \times G}{3770d^2}$$

Changing to units of mW and cm, using:

$$P (mW) = P (W) / 1000 \text{ and}$$

$$d (cm) = d(m) / 100$$

Yields

$$S = \frac{30 \times (P/1000) \times G}{3770 \times (d/100)^2} = 0.0796 \times \frac{P \times G}{d^2} \quad \text{Equation 1}$$

- Where *d* = Distance in cm
P = Power in mW
G = Numeric antenna gain
S = Power density in mW / cm²

Maximum Permissible Exposure

EUT output power = 2.0276mW

Numeric Antenna gain =1.1857

Substituting the MPE safe distance using d = 20 cm into Equation 1:

Yields

$$S = 0.000199 \times P \times G$$

- Where *P* = Power in mW
G = Numeric antenna gain
S = Power density in mW / cm²

Power density = 0.000478 mW / cm²

(For mobile or fixed location transmitters, the minimum separation distance is 20 cm, even if calculations indicate that the MPE distance would be less.)



8.6 SPURIOUS EMISSIONS

7.6.1. CONDUCTED MEASUREMENT

LIMIT

In any 100 kHz bandwidth outside the frequency band in which the spread spectrum or digitally modulated intentional radiator is operating, the radio frequency power that is produced by the intentional radiator shall be at least 20 dB below that in the 100 kHz bandwidth within the band that contains the highest level of the desired power, based on either an RF conducted or a radiated measurement. Attenuation below the general limits specified in Section 15.209(a) is not required. In addition, radiated emissions which fall in the restricted bands, as defined in Section 15.205(a), must also comply with the radiated emission limits specified in Section 15.209(a) (see Section 15.205(c)).

MEASUREMENT EQUIPMENT USED

Name of Equipment	Manufacturer	Model	Serial Number	Calibration Due
Spectrum Analyzer	R&S	FSEK 30	835253/002	OCT. 25, 2010

REMARK: Each piece of equipment is scheduled for calibration once a year.

TEST CONFIGURATION

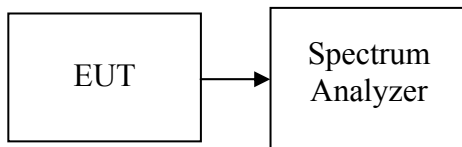

TEST PROCEDURE

Conducted RF measurements of the transmitter output were made to confirm that the EUT antenna port conducted emissions meet the specified limit and to identify any spurious signals that require further investigation or measurements on the radiated emissions site.

The transmitter output is connected to the spectrum analyzer. The resolution bandwidth is set to 100 KHz. The video bandwidth is set to 100 KHz.

Measurements are made over the 30MHz to 26GHz range with the transmitter set to the lowest, middle, and highest channels.

Offset=Cable loss=11.7 dB

TEST RESULTS

No non-compliance noted.



CH Low

Frequency (MHz)	Offset (dB)	Reading (dBuV)	Level (dBuV)	Limit (dBuV)	Margin (dB)
903.0544	11.7	94.39	106.09	N/A	N/A
131.1823	11.7	40.83	52.53	86.09	-33.56
1809.6192	11.7	61.15	72.85	86.09	-13.24
2708.3567	11.7	38.84	50.54	86.09	-35.55

CH Mid

Frequency (MHz)	Offset (dB)	Reading (dBuV)	Level (dBuV)	Limit (dBuV)	Margin (dB)
915.6354	11.7	95.71	107.41	N/A	N/A
125.2304	11.7	38.77	50.47	87.41	-36.94
1833.4268	11.7	58.30	70	87.41	-17.41
2750.02	11.7	38.30	50	87.41	-37.41

CH High

Frequency (MHz)	Offset (dB)	Reading (dBuV)	Level (dBuV)	Limit (dBuV)	Margin (dB)
926.7524	11.7	96.75	108.45	N/A	N/A
125.2304	11.7	38.78	50.48	88.45	-37.97
1857.2344	11.7	56.70	68.4	88.45	-20.05
2779.7795	11.7	38.20	49.9	88.45	-38.55



TEST PLOT

CH Low 1

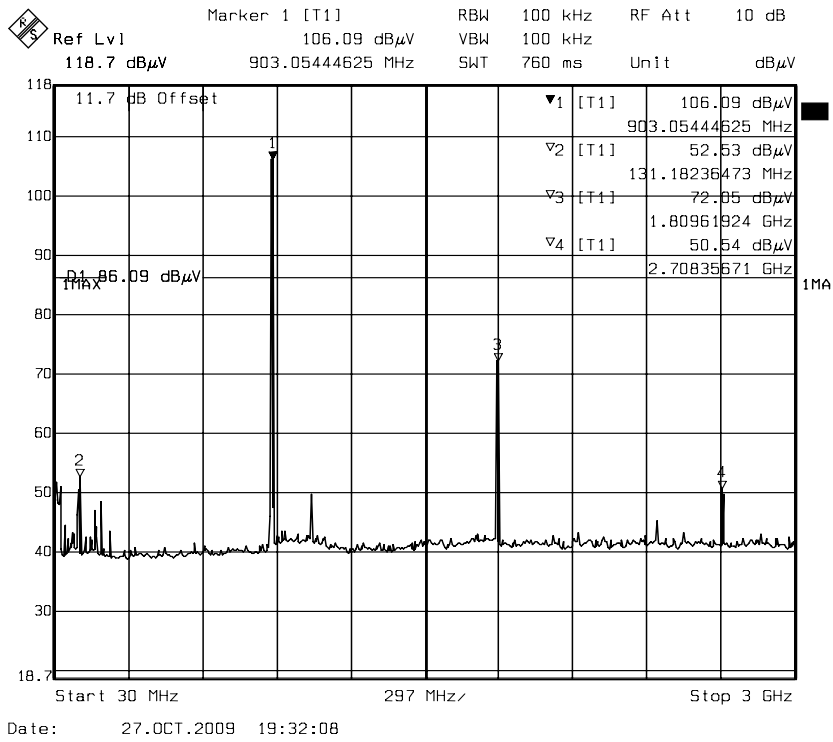

CH Low 2

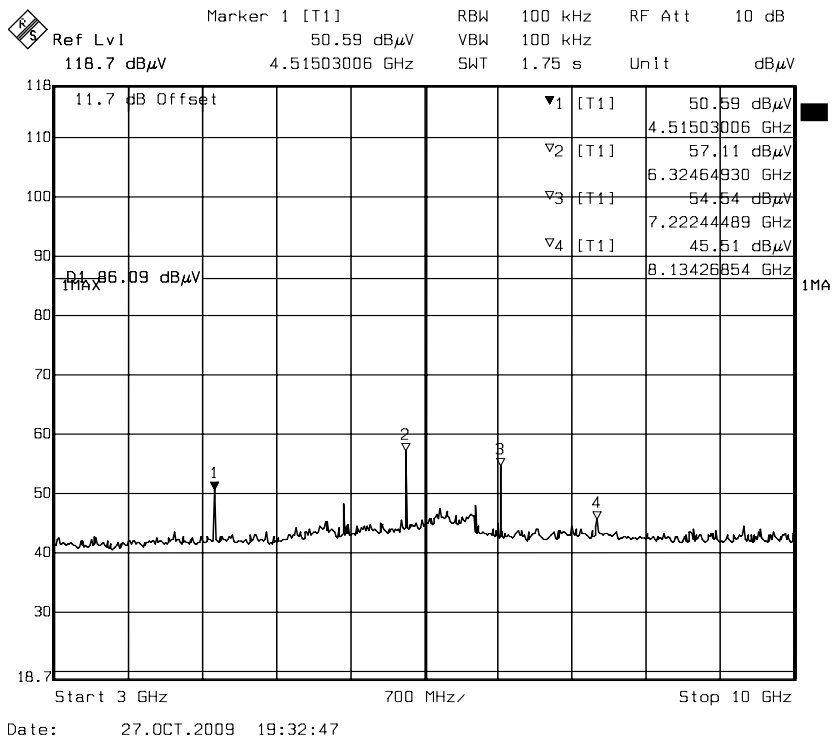



CH Mid 1

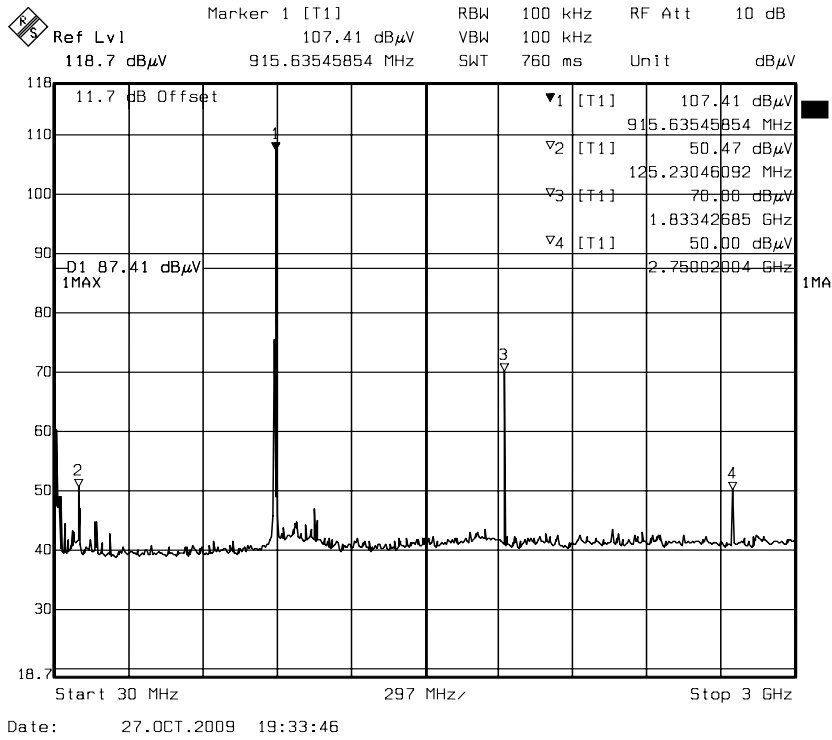

CH Mid 2

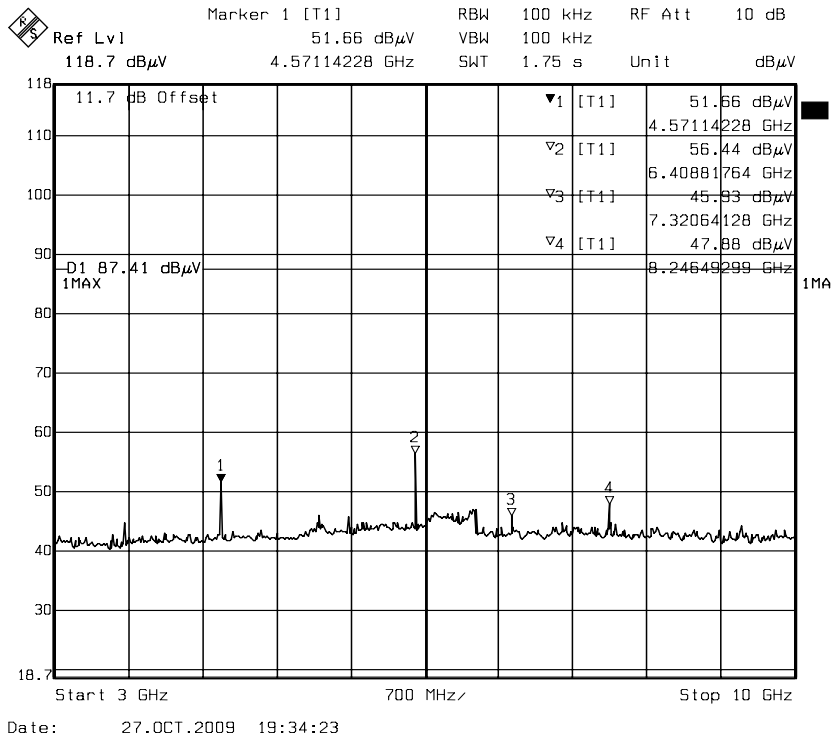



CH High 1

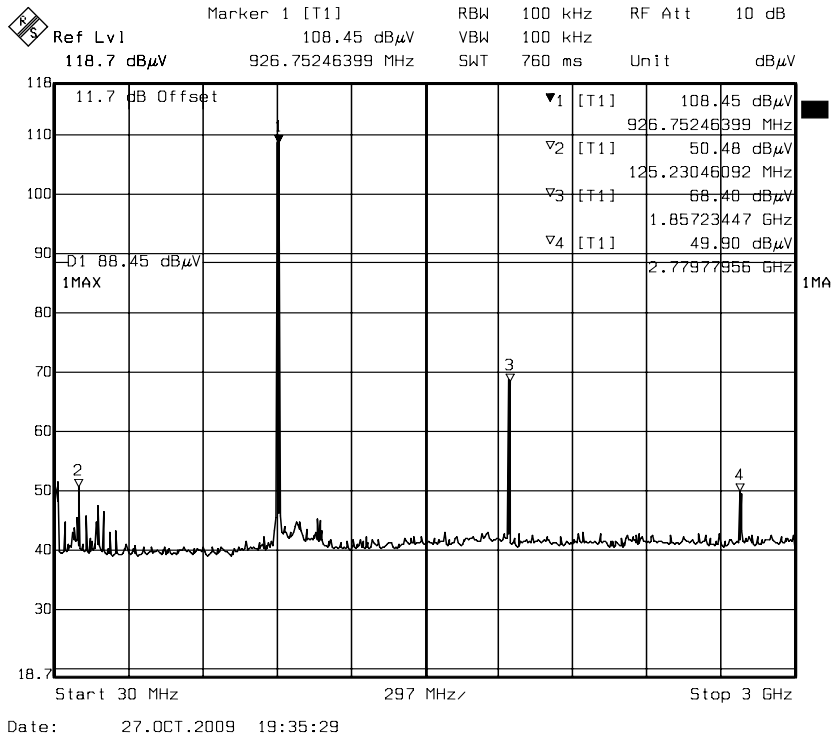

CH High 2

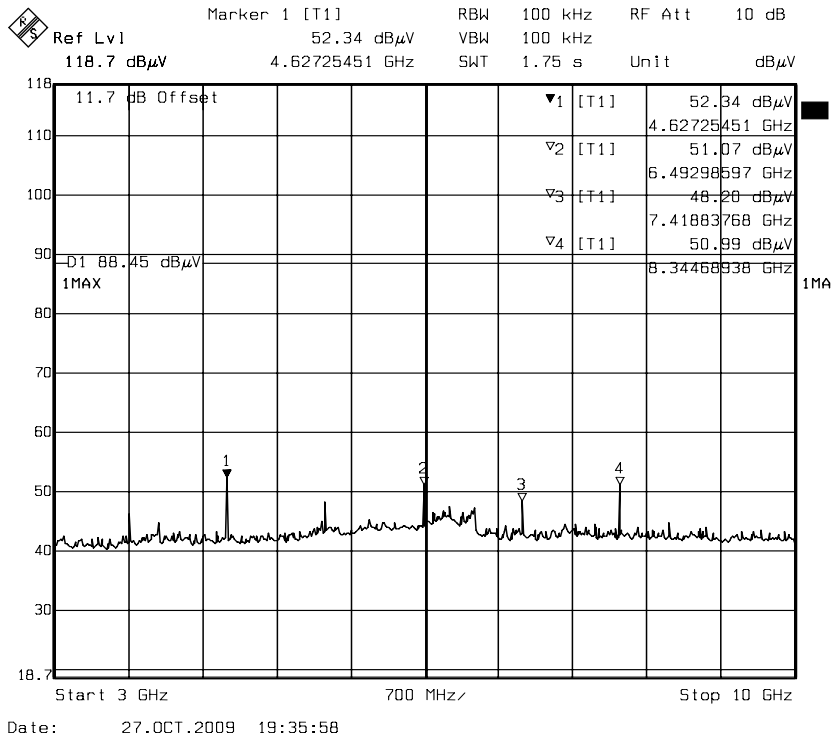



7.6.2. RADIATED EMISSIONS

LIMIT

1. Except as provided elsewhere in this Subpart, the emissions from an intentional radiator shall not exceed the field strength levels specified in the following table:

Frequency (MHz)	Field Strength (mV/m)	Measurement Distance (m)
30-88	100*	3
88-216	150*	3
216-960	200*	3
Above 960	500	3

Remark: Except as provided in paragraph (g), fundamental emissions from intentional radiators operating under this Section shall not be located in the frequency bands 54-72 MHz, 76-88 MHz, 174-216 MHz or 470-806 MHz. However, operation within these frequency bands is permitted under other sections of this Part, e.g., Sections 15.231 and 15.241.

2. In the above emission table, the tighter limit applies at the band edges.

Frequency (Hz)	Field Strength ($\mu\text{V/m}$ at 3-meter)	Field Strength (dB $\mu\text{V/m}$ at 3-meter)
30-88	100	40
88-216	150	43.5
216-960	200	46
Above 960	500	54

MEASUREMENT EQUIPMENT USED

Open Area Test Site # 6				
Name of Equipment	Manufacturer	Model	Serial Number	Calibration Due
TYPE N COAXIAL CABLE	SUHNER	CHA9513	6	AUG. 31, 2010
EMI Receiver	R&S	ESVS10	833206/012	APR. 28, 2010
Spectrum Analyzer	R&S	FSEK 30	835253/002	OCT. 25, 2010
BI-LOG Antenna	Sunol	JB1	A070506-2	SEP. 8, 2010
Horn Antenna	Com-Power	AH-118	071032	DEC. 22, 2009
SMA RF CABLE	SUHNER	SUCOFLEX104PEA	20520/4PEA	NOV. 12, 2009
Pre-Amplifier	MITEQ	AFS44-00108650-42-10P-4 4	1205908	OCT. 23, 2010
Signal Generator	HP	8673C	2938A00663	AUG. 25, 2010
Pre-Amplifier	HP	8447F	2944A03817	NOV. 01, 2010
Turn Table	Yo Chen	001	-----	N.C.R.
Antenna Tower	AR	TP1000A	309874	N.C.R.
Controller	CT	SC101	-----	N.C.R.
Test S/W	e-3 (5.04303e)			

REMARK: Each piece of equipment is scheduled for calibration once a year.

TEST CONFIGURATION

Below 1 GHz

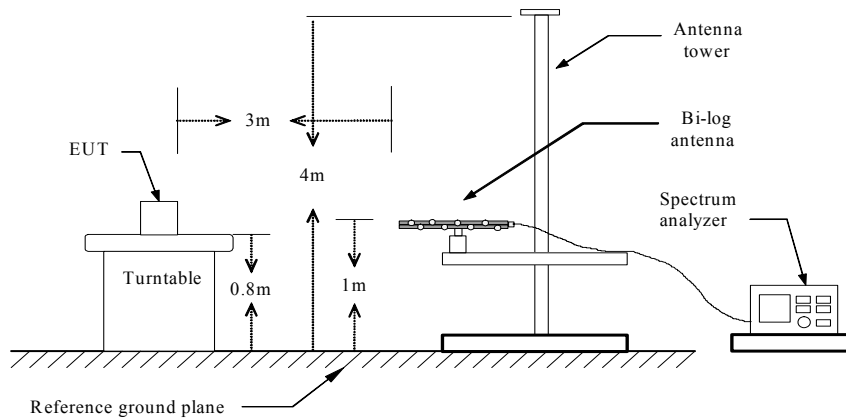

Above 1 GHz

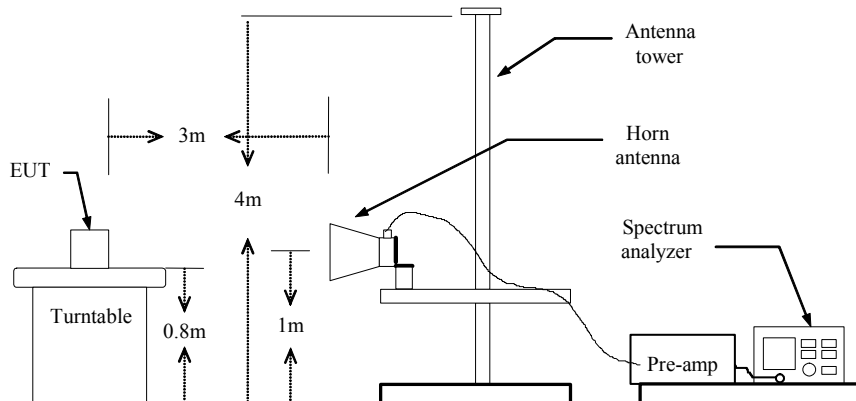

TEST PROCEDURE

1. The EUT is placed on a turntable, which is 0.8m above ground plane.
2. The turntable shall be rotated for 360 degrees to determine the position of maximum emission level.
3. EUT is set 3m away from the receiving antenna, which is varied from 1m to 4m to find out the highest emissions.
4. Maximum procedure was performed on the six highest emissions to ensure EUT compliance.
5. And also, each emission was to be maximized by changing the polarization of receiving antenna both horizontal and vertical.
6. Set the spectrum analyzer in the following setting as:

Below 1GHz:

RBW=100kHz / VBW=300kHz / Sweep=AUTO

Above 1GHz:

(a) PEAK: RBW=VBW=1MHz / Sweep=AUTO

(b) AVERAGE: RBW=1MHz / VBW=10Hz / Sweep=AUTO

7. Repeat above procedures until the measurements for all frequencies are complete.



TEST RESULTS

Below 1 GHz

Operation Mode: Normal Link

Test Date: September 10, 2009

Temperature: 27.5 °C

Tested by: Eric Yang

Humidity: 49 % RH

Polarity: Horizontal

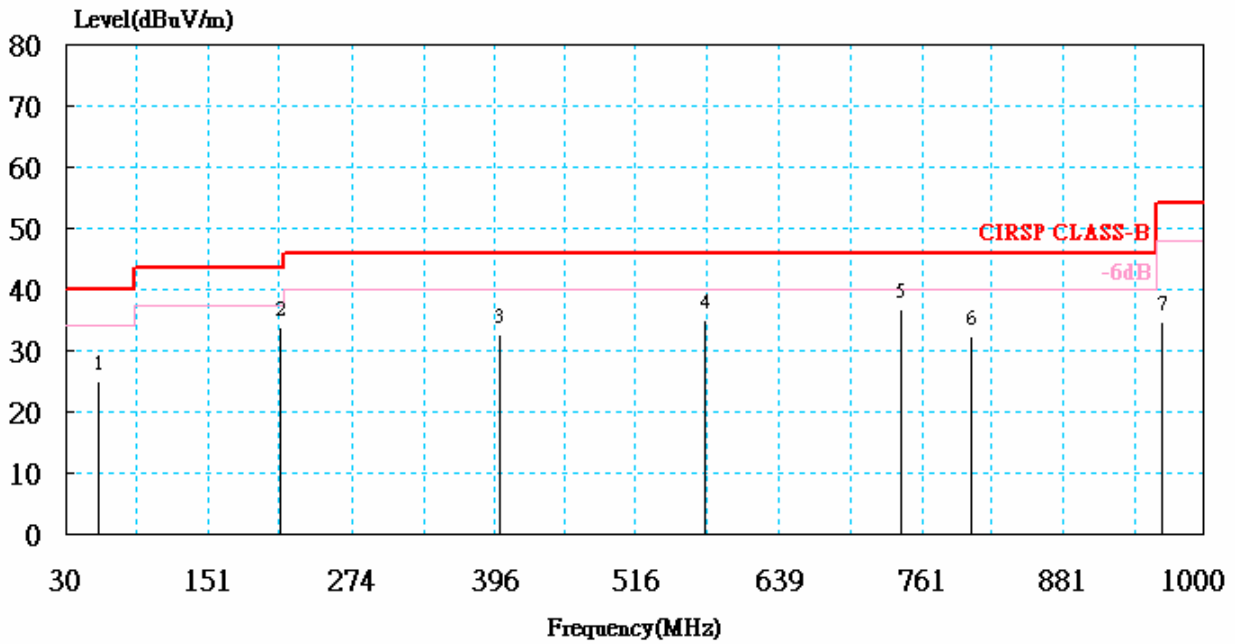

No.	Freq- Uency	Meter Reading at 3 m Level	Antenna Factor	Cable Loss	Emission at 3 m Level	Limits	Margin	Detector Mode
	(MHz)	(dBμV)	(dB/m)	(dB)	(dBμV/m)			(dB)
1	57.05	15.40	7.85	1.43	24.68	40.00	-15.32	QP
2	213.28	18.66	12.16	2.76	33.58	43.50	-9.92	QP
3	400.01	12.40	16.13	3.83	32.36	46.00	-13.64	QP
4	575.95	10.70	19.04	4.99	34.73	46.00	-11.27	QP
5	743.82	9.80	21.13	5.68	36.61	46.00	-9.39	QP
6	803.84	4.40	21.82	5.97	32.18	46.00	-13.82	QP
7	966.36	3.90	23.39	6.98	34.27	54.00	-19.73	QP

Remark:

1. Measuring frequencies from 30 MHz to the 1GHz.
2. Radiated emissions measured in frequency range from 30 MHz to 1000MHz were made with an instrument using Peak detector mode.
3. Data of measurement within this frequency range shown " --- " in the table above means the reading of emissions are attenuated more than 20dB below the permissible limits or the field strength is too small to be measured.
4. The IF bandwidth of SPA between 30MHz to 1GHz was 100kHz.



Operation Mode: Normal Link

Test Date: September 10, 2009

Temperature: 27.5 °C

Tested by: Eric Yang

Humidity: 49 % RH

Polarity: Vertical

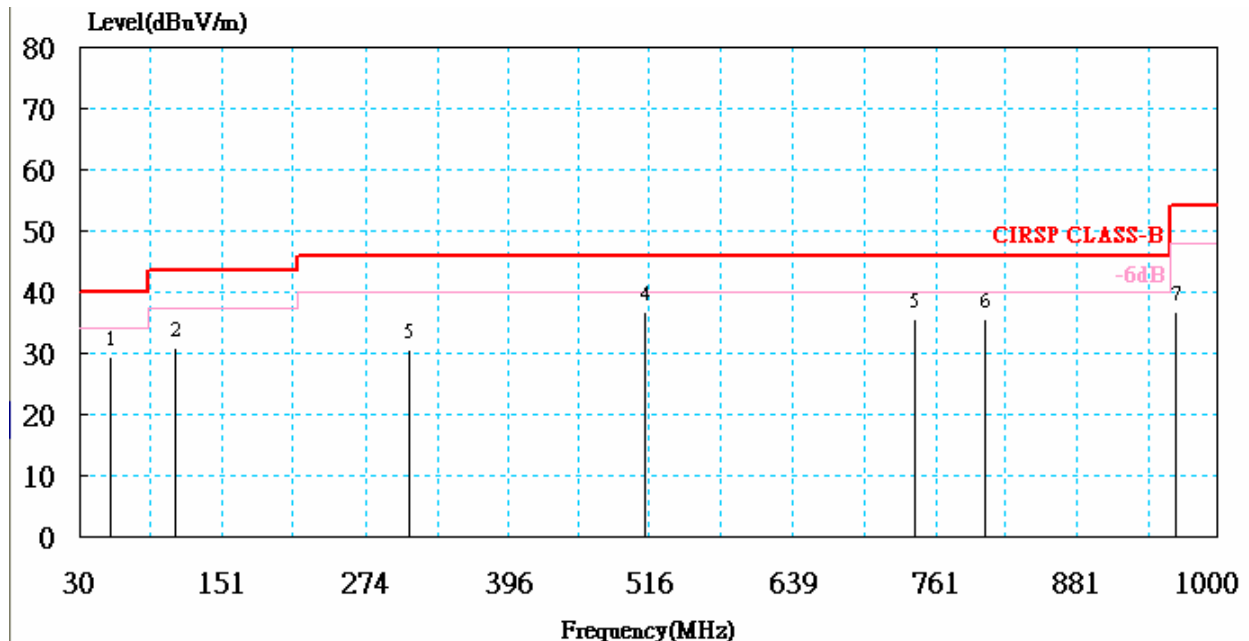

No.	Freq- Uency (MHz)	Meter Reading at 3 m Level (dBµV)	Antenna Factor (dB/m)	Cable Loss (dB)	Emission at 3 m Level (dBµV/m)	Limits (dBµV/m)	Margin (dB)	Detector Mode PK/QP
	1	56.51	19.80	7.88	1.43	29.11	40.00	-10.89
2	111.35	16.40	12.22	2.02	30.63	43.50	-12.87	QP
3	311.05	12.70	14.19	3.30	30.19	46.00	-15.81	QP
4	512.38	13.70	18.18	4.57	36.45	46.00	-9.55	QP
5	743.96	8.50	21.13	5.68	35.31	46.00	-10.69	QP
6	803.82	7.40	21.82	5.97	35.18	46.00	-10.82	QP
7	966.38	6.20	23.39	6.98	36.57	54.00	-17.43	QP

Remark:

1. Measuring frequencies from 30 MHz to the 1GHz.
2. Radiated emissions measured in frequency range from 30 MHz to 1000MHz were made with an instrument using Peak detector mode.
3. Data of measurement within this frequency range shown " --- " in the table above means the reading of emissions are attenuated more than 20dB below the permissible limits or the field strength is too small to be measured.
4. The IF bandwidth of SPA between 30MHz to 1GHz was 100kHz.



Above 1 GHz

Operation Mode: TX(X) / CH Low

Test Date: September 30, 2009

Temperature: 31.2 °C

Tested by: Eric Yang

Humidity: 48% RH

Polarity: Horizontal

TX(X) / CH Low				Measurement Distance at 3m				Horizontal polarity		
Freq.	Reading	AF	Closs	Pre-amp	Filter	Level	Limit	Margin	Mark	
(MHz)	(dBμV)	(dB/m)	(dB)	(dB)	(dB)	(dBμV/m)	(dBμV/m)	(dB)	(P/Q/A)	
903.13	93.24	22.73	4.51	26.19	0.00	94.30	Fundamental Frequency		P	
N/A	-----	-----	-----	-----	-----	-----			A	
1805.65	77.65	28.82	2.22	39.99	0.94	69.65	74.30	-4.65	P	
* 2709.32	56.95	29.96	2.38	39.85	1.39	50.83	74.00	-23.17	P	
* 2709.32	51.02	29.96	2.38	39.85	1.39	44.90	54.00	-9.10	A	
* 3611.47	60.94	30.36	3.25	40.50	0.83	54.87	74.00	-19.13	P	
* 3611.47	55.34	30.36	3.25	40.50	0.83	49.27	54.00	-4.73	A	
* 4514.26	57.02	32.13	3.54	40.87	0.58	52.39	74.00	-21.61	P	
* 4514.26	47.47	32.13	3.54	40.87	0.58	42.84	54.00	-11.16	A	
* 5416.67	64.08	33.87	4.04	42.05	0.87	60.80	74.00	-13.20	P	
* 5416.67	55.27	33.87	4.04	42.05	0.87	51.99	54.00	-2.01	A	
6320.84	57.52	35.37	4.50	42.08	0.76	56.07	74.30	-18.23	P	
7222.80	56.55	38.81	4.92	41.44	1.41	60.25	74.30	-14.05	P	
N/A	-----	-----	-----	-----	-----	-----	-----	-----	P	
N/A	-----	-----	-----	-----	-----	-----	-----	-----	A	

Remark:

1. Measuring frequencies from 1 GHz to the 10th harmonic of highest fundamental frequency.
2. Measurements above show only up to 6 maximum emissions noted, or would be lesser if no specific emissions from the EUT are recorded (ie: margin > 20dB from the applicable limit) and considered that's already beyond the background noise floor.
3. Radiated emissions measured in frequency above 1000MHz were made with an instrument using Peak detector mode and average detector mode of the emission shown in Actual FS column.
4. Spectrum setting:
 - a. Peak Setting 1GHz to 10th harmonics of fundamental, RBW = 1MHz, VBW = 1MHz, Sweep time = Auto.
 - b. AV Setting 1GHz to 10th harmonics of fundamental, RBW = 1MHz, VBW = 10Hz, b. Sweep time = Auto.
5. Remark “*” means the Restricted band.



Operation Mode: TX(X) / CH Low

Test Date: September 30, 2009

Temperature: 31.2 °C

Tested by: Eric Yang

Humidity: 48% RH

Polarity: Vertical

TX(X) / CH Low				Measurement Distance at 3m				Vertical polarity	
Freq.	Reading	AF	Closs	Pre-amp	Filter	Level	Limit	Margin	Mark
(MHz)	(dBμV)	(dB/m)	(dB)	(dB)	(dB)	(dBμV/m)	(dBμV/m)	(dB)	(P/Q/A)
902.87	94.59	22.73	4.51	26.19	0.00	95.65	Fundamental Frequency		P
N/A	-----	-----	-----	-----	-----	-----			A
1805.73	79.38	28.82	2.22	39.99	0.94	71.38	75.65	-4.27	P
* 2709.27	57.91	29.96	2.38	39.85	1.39	51.79	74.00	-22.21	P
* 2709.27	53.14	29.96	2.38	39.85	1.39	47.02	54.00	-6.98	A
* 3611.49	61.17	30.36	3.25	40.50	0.83	55.10	74.00	-18.90	P
* 3611.49	55.21	30.36	3.25	40.50	0.83	49.14	54.00	-4.86	A
* 4515.07	56.05	32.13	3.54	40.87	0.58	51.42	74.00	-22.58	P
* 4515.07	45.42	32.13	3.54	40.87	0.58	40.79	54.00	-13.21	A
* 5418.71	65.52	33.87	4.04	42.05	0.87	62.25	74.00	-11.75	P
* 5417.22	55.24	33.87	4.04	42.05	0.87	51.96	54.00	-2.04	A
6322.07	60.39	35.37	4.50	42.08	0.76	58.95	75.65	-16.70	P
7222.82	58.02	38.81	4.92	41.44	1.41	61.72	75.65	-13.93	P
N/A	-----	-----	-----	-----	-----	-----	-----	-----	P
N/A	-----	-----	-----	-----	-----	-----	-----	-----	A

Remark:

1. Measuring frequencies from 1 GHz to the 10th harmonic of highest fundamental frequency.
2. Measurements above show only up to 6 maximum emissions noted, or would be lesser if no specific emissions from the EUT are recorded (ie: margin>20dB from the applicable limit) and considered that's already beyond the background noise floor.
3. Radiated emissions measured in frequency above 1000MHz were made with an instrument using Peak detector mode and average detector mode of the emission shown in Actual FS column.
4. Spectrum setting:
 - a. Peak Setting 1GHz to 10th harmonics of fundamental, RBW = 1MHz, VBW = 1MHz, Sweep time = Auto.
 - b. AV Setting 1GHz to 10th harmonics of fundamental, RBW = 1MHz, VBW = 10Hz, b. Sweep time = Auto.
5. Remark “*” means the Restricted band.



Operation Mode: TX(X) / CH Mid

Test Date: September 30, 2009

Temperature: 31.2 °C

Tested by: Eric Yang

Humidity: 48% RH

Polarity: Horizontal

TX(X) / CH Mid				Measurement Distance at 3m			Horizontal polarity		
Freq.	Reading	AF	Closs	Pre-amp	Filter	Level	Limit	Margin	Mark
(MHz)	(dBμV)	(dB/m)	(dB)	(dB)	(dB)	(dBμV/m)	(dBμV/m)	(dB)	(P/Q/A)
915.72	92.82	22.86	4.53	26.17	0.00	94.03	Fundamental Frequency		P
N/A	-----	-----	-----	-----	-----	-----			A
1831.49	70.46	29.02	2.24	40.01	0.96	62.66	74.03	-11.37	P
* 2747.28	59.06	29.95	2.38	39.87	1.41	52.94	74.00	-21.06	P
* 2747.28	53.36	29.95	2.38	39.87	1.41	47.24	54.00	-6.76	A
* 3662.95	58.85	30.43	3.27	40.53	0.80	52.82	74.00	-21.18	P
* 3662.95	52.05	30.43	3.27	40.53	0.80	46.02	54.00	-7.98	A
* 4578.74	57.97	32.27	3.57	40.97	0.60	53.45	74.00	-20.55	P
* 4578.74	49.22	32.27	3.57	40.97	0.60	44.70	54.00	-9.30	A
5492.34	64.23	33.99	4.08	42.13	0.89	61.05	74.30	-13.25	P
6409.92	60.67	35.58	4.55	42.00	0.77	59.57	74.30	-14.73	P
* 7325.84	60.43	38.96	4.97	41.30	1.63	64.68	74.00	-9.32	P
* 7325.84	47.55	38.96	4.97	41.30	1.63	51.80	54.00	-2.20	A
N/A	-----	-----	-----	-----	-----	-----	-----	-----	P
N/A	-----	-----	-----	-----	-----	-----	-----	-----	A

Remark:

1. Measuring frequencies from 1 GHz to the 10th harmonic of highest fundamental frequency.
2. Measurements above show only up to 6 maximum emissions noted, or would be lesser if no specific emissions from the EUT are recorded (ie: margin>20dB from the applicable limit) and considered that's already beyond the background noise floor.
3. Radiated emissions measured in frequency above 1000MHz were made with an instrument using Peak detector mode and average detector mode of the emission shown in Actual FS column.
4. Spectrum setting:
 - a. Peak Setting 1GHz to 10th harmonics of fundamental, RBW = 1MHz, VBW = 1MHz, Sweep time = Auto.
 - b. AV Setting 1GHz to 10th harmonics of fundamental, RBW = 1MHz, VBW = 10Hz, Sweep time = Auto.
5. Remark “*” means the Restricted band.



Operation Mode: TX(X) / CH Mid

Test Date: September 30, 2009

Temperature: 31.2 °C

Tested by: Eric Yang

Humidity: 48% RH

Polarity: Vertical

TX(X) / CH Mid				Measurement Distance at 3m				Vertical polarity	
Freq.	Reading	AF	Closs	Pre-amp	Filter	Level	Limit	Margin	Mark
(MHz)	(dBμV)	(dB/m)	(dB)	(dB)	(dB)	(dBμV/m)	(dBμV/m)	(dB)	(P/Q/A)
915.73	94.09	22.86	4.53	26.17	0.00	95.30	Fundamental Frequency		P
N/A	-----	-----	-----	-----	-----	-----			A
1831.43	72.61	29.02	2.24	40.01	0.96	64.81	75.30	-10.49	P
* 2746.43	56.80	29.95	2.38	39.87	1.41	50.68	74.00	-23.32	P
* 2746.43	51.18	29.95	2.38	39.87	1.41	45.06	54.00	-8.94	A
* 3662.91	57.84	30.43	3.27	40.53	0.80	51.81	74.00	-22.19	P
* 3662.91	51.30	30.43	3.27	40.53	0.80	45.27	54.00	-8.73	A
* 4578.72	58.22	32.27	3.57	40.97	0.60	53.70	74.00	-20.30	P
* 4578.72	49.57	32.27	3.57	40.97	0.60	45.05	54.00	-8.95	A
5492.67	66.31	33.99	4.08	42.13	0.89	63.13	75.65	-12.51	P
6407.97	61.85	35.58	4.55	42.00	0.77	60.74	75.65	-14.90	P
* 7323.68	62.66	38.95	4.97	41.30	1.62	66.90	74.00	-7.10	P
* 7323.68	48.21	38.95	4.97	41.30	1.62	52.45	54.00	-1.55	A
N/A	-----	-----	-----	-----	-----	-----	-----	-----	P
N/A	-----	-----	-----	-----	-----	-----	-----	-----	A

Remark:

1. Measuring frequencies from 1 GHz to the 10th harmonic of highest fundamental frequency.
2. Measurements above show only up to 6 maximum emissions noted, or would be lesser if no specific emissions from the EUT are recorded (ie: margin>20dB from the applicable limit) and considered that's already beyond the background noise floor.
3. Radiated emissions measured in frequency above 1000MHz were made with an instrument using Peak detector mode and average detector mode of the emission shown in Actual FS column.
4. Spectrum setting:
 - a. Peak Setting 1GHz to 10th harmonics of fundamental, RBW = 1MHz, VBW = 1MHz, Sweep time = Auto.
 - b. AV Setting 1GHz to 10th harmonics of fundamental, RBW = 1MHz, VBW = 10Hz, b. Sweep time = Auto.
5. Remark “*” means the Restricted band.



Operation Mode: TX(X) / CH High

Test Date: September 30, 2009

Temperature: 31.2 °C

Tested by: Eric Yang

Humidity: 48% RH

Polarity: Horizontal

TX(X) / CH High				Measurement Distance at 3m			Horizontal polarity		
Freq.	Reading	AF	Closs	Pre-amp	Filter	Level	Limit	Margin	Mark
(MHz)	(dBμV)	(dB/m)	(dB)	(dB)	(dB)	(dBμV/m)	(dBμV/m)	(dB)	(P/Q/A)
926.80	90.57	22.97	4.54	26.16	0.00	91.92	Fundamental Frequency		P
N/A	-----	-----	-----	-----	-----	-----			A
1853.10	67.02	29.18	2.25	40.02	0.97	59.39	74.00	-14.61	P
* 2780.76	58.97	29.94	2.39	39.89	1.43	52.84	74.00	-21.16	P
* 2780.76	54.87	29.94	2.39	39.89	1.43	48.74	54.00	-5.26	A
* 3707.71	58.54	30.49	3.28	40.54	0.77	52.54	74.00	-21.46	P
* 3707.71	52.11	30.49	3.28	40.54	0.77	46.11	54.00	-7.89	A
* 4634.54	58.27	32.40	3.60	41.05	0.62	53.84	74.00	-20.16	P
* 4634.54	49.69	32.40	3.60	41.05	0.62	45.26	54.00	-8.74	A
5559.96	62.72	34.07	4.11	42.17	0.87	59.61	74.30	-14.69	P
6486.60	60.80	35.77	4.58	41.93	0.78	60.00	74.30	-14.30	P
* 7415.25	60.31	39.08	5.00	41.17	1.82	65.04	74.00	-8.96	P
* 7415.25	47.10	39.08	5.00	41.17	1.82	51.83	54.00	-2.17	A
N/A	-----	-----	-----	-----	-----	-----	-----	-----	P
N/A	-----	-----	-----	-----	-----	-----	-----	-----	A

Remark:

1. Measuring frequencies from 1 GHz to the 10th harmonic of highest fundamental frequency.
2. Measurements above show only up to 6 maximum emissions noted, or would be lesser if no specific emissions from the EUT are recorded (ie: margin>20dB from the applicable limit) and considered that's already beyond the background noise floor.
3. Radiated emissions measured in frequency above 1000MHz were made with an instrument using Peak detector mode and average detector mode of the emission shown in Actual FS column.
4. Spectrum setting:
 - a. Peak Setting 1GHz to 10th harmonics of fundamental, RBW = 1MHz, VBW = 1MHz, Sweep time = Auto.
 - b. AV Setting 1GHz to 10th harmonics of fundamental, RBW = 1MHz, VBW = 10Hz, b. Sweep time = Auto.
5. Remark “*” means the Restricted band.



Operation Mode: TX(X) / CH High

Test Date: September 30, 2009

Temperature: 31.2 °C

Tested by: Eric Yang

Humidity: 48% RH

Polarity: Vertical

TX(X) / CH High				Measurement Distance at 3m				Vertical polarity		
Freq.	Reading	AF	Closs	Pre-amp	Filter	Level	Limit	Margin	Mark	
(MHz)	(dBμV)	(dB/m)	(dB)	(dB)	(dB)	(dBμV/m)	(dBμV/m)	(dB)	(P/Q/A)	
926.89	94.06	22.97	4.54	26.16	0.00	95.41	Fundamental Frequency		P	
N/A	-----	-----	-----	-----	-----	-----			A	
1853.40	72.96	29.19	2.25	40.02	0.97	65.34	75.41	-10.08	P	
* 2780.81	58.77	29.94	2.39	39.89	1.43	52.64	74.00	-21.36	P	
* 2780.81	53.85	29.94	2.39	39.89	1.43	47.72	54.00	-6.28	A	
* 3706.61	61.52	30.49	3.28	40.54	0.77	55.52	74.00	-18.48	P	
* 3706.61	55.83	30.49	3.28	40.54	0.77	49.83	54.00	-4.17	A	
* 4633.27	57.22	32.39	3.60	41.05	0.62	52.79	74.00	-21.21	P	
* 4633.27	48.40	32.39	3.60	41.05	0.62	43.97	54.00	-10.03	A	
5560.83	66.29	34.07	4.11	42.17	0.87	63.18	75.65	-12.47	P	
6486.63	62.21	35.77	4.58	41.93	0.78	61.41	75.65	-14.24	P	
* 7415.81	61.25	39.08	5.00	41.17	1.82	65.99	74.00	-8.01	P	
* 7415.81	47.85	39.08	5.00	41.17	1.82	52.59	54.00	-1.41	A	
N/A	-----	-----	-----	-----	-----	-----	-----	-----	P	
N/A	-----	-----	-----	-----	-----	-----	-----	-----	A	

Remark:

1. Measuring frequencies from 1 GHz to the 10th harmonic of highest fundamental frequency.
2. Measurements above show only up to 6 maximum emissions noted, or would be lesser if no specific emissions from the EUT are recorded (ie: margin>20dB from the applicable limit) and considered that's already beyond the background noise floor.
3. Radiated emissions measured in frequency above 1000MHz were made with an instrument using Peak detector mode and average detector mode of the emission shown in Actual FS column.
4. Spectrum setting:
 - a. Peak Setting 1GHz to 10th harmonics of fundamental, RBW = 1MHz, VBW = 1MHz, Sweep time = Auto.
 - b. AV Setting 1GHz to 10th harmonics of fundamental, RBW = 1MHz, VBW = 10Hz, b. Sweep time = Auto.
5. Remark “*” means the Restricted band.



Operation Mode: TX(Y) / CH Low

Test Date: September 30, 2009

Temperature: 31.2 °C

Tested by: Eric Yang

Humidity: 48% RH

Polarity: Horizontal

TX(Y) / CH Low				Measurement Distance at 3m			Horizontal polarity		
Freq.	Reading	AF	Closs	Pre-amp	Filter	Level	Limit	Margin	Mark
(MHz)	(dBμV)	(dB/m)	(dB)	(dB)	(dB)	(dBμV/m)	(dBμV/m)	(dB)	(P/Q/A)
903.13	93.24	22.73	4.51	26.19	0.00	94.30	Fundamental Frequency		P
N/A	-----	-----	-----	-----	-----	-----			A
1805.59	79.35	28.82	2.22	39.99	0.94	71.34	74.30	-2.95	P
* 2709.38	59.45	29.96	2.38	39.85	1.39	53.33	74.00	-20.67	P
* 2709.38	55.10	29.96	2.38	39.85	1.39	48.98	54.00	-5.02	A
* 3611.44	59.98	30.36	3.25	40.50	0.83	53.91	74.00	-20.09	P
* 3611.44	54.20	30.36	3.25	40.50	0.83	48.13	54.00	-5.87	A
* 4515.77	56.45	32.13	3.54	40.87	0.58	51.83	74.00	-22.17	P
* 4515.77	45.62	32.13	3.54	40.87	0.58	41.00	54.00	-13.00	A
* 5417.22	64.53	33.87	4.04	42.05	0.87	61.25	74.00	-12.75	P
* 5417.22	55.68	33.87	4.04	42.05	0.87	52.40	54.00	-1.60	A
6431.63	60.88	35.64	4.56	41.98	0.77	59.86	74.30	-14.44	P
7222.84	61.37	38.81	4.92	41.44	1.41	65.07	74.30	-9.23	P
N/A	-----	-----	-----	-----	-----	-----	-----	-----	P
N/A	-----	-----	-----	-----	-----	-----	-----	-----	A

Remark:

1. Measuring frequencies from 1 GHz to the 10th harmonic of highest fundamental frequency.
2. Measurements above show only up to 6 maximum emissions noted, or would be lesser if no specific emissions from the EUT are recorded (ie: margin>20dB from the applicable limit) and considered that's already beyond the background noise floor.
3. Radiated emissions measured in frequency above 1000MHz were made with an instrument using Peak detector mode and average detector mode of the emission shown in Actual FS column.
4. Spectrum setting:
 - a. Peak Setting 1GHz to 10th harmonics of fundamental, RBW = 1MHz, VBW = 1MHz, Sweep time = Auto.
 - b. AV Setting 1GHz to 10th harmonics of fundamental, RBW = 1MHz, VBW = 10Hz, Sweep time = Auto.
5. Remark “*” means the Restricted band.



Operation Mode: TX(Y) / CH Low

Test Date: September 30, 2009

Temperature: 31.2 °C

Tested by: Eric Yang

Humidity: 48% RH

Polarity: Vertical

TX(Y) / CH Low				Measurement Distance at 3m				Vertical polarity		
Freq.	Reading	AF	Closs	Pre-amp	Filter	Level	Limit	Margin	Mark	
(MHz)	(dBμV)	(dB/m)	(dB)	(dB)	(dB)	(dBμV/m)	(dBμV/m)	(dB)	(P/Q/A)	
902.87	94.59	22.73	4.51	26.19	0.00	95.65	Fundamental Frequency		P	
N/A	-----	-----	-----	-----	-----	-----			A	
1805.79	76.77	28.82	2.22	39.99	0.94	68.77	75.65	-6.88	P	
* 2709.21	57.65	29.96	2.38	39.85	1.39	51.53	74.00	-22.47	P	
* 2709.21	52.83	29.96	2.38	39.85	1.39	46.71	54.00	-7.29	A	
* 3611.38	60.75	30.36	3.25	40.50	0.83	54.68	74.00	-19.32	P	
* 3611.38	55.00	30.36	3.25	40.50	0.83	48.93	54.00	-5.07	A	
* 4516.07	58.22	32.14	3.54	40.87	0.58	53.60	74.00	-20.40	P	
* 4516.07	49.31	32.14	3.54	40.87	0.58	44.69	54.00	-9.31	A	
* 5418.58	66.38	33.87	4.04	42.05	0.87	63.11	74.00	-10.89	P	
* 5418.58	55.72	33.87	4.04	42.05	0.87	52.45	54.00	-1.55	A	
6321.17	63.16	35.37	4.50	42.08	0.76	61.71	75.65	-13.93	P	
7223.02	58.46	38.81	4.92	41.44	1.41	62.16	75.65	-13.49	P	
N/A	-----	-----	-----	-----	-----	-----	-----	-----	P	
N/A	-----	-----	-----	-----	-----	-----	-----	-----	A	

Remark:

1. Measuring frequencies from 1 GHz to the 10th harmonic of highest fundamental frequency.
2. Measurements above show only up to 6 maximum emissions noted, or would be lesser if no specific emissions from the EUT are recorded (ie: margin>20dB from the applicable limit) and considered that's already beyond the background noise floor.
3. Radiated emissions measured in frequency above 1000MHz were made with an instrument using Peak detector mode and average detector mode of the emission shown in Actual FS column.
4. Spectrum setting:
 - a. Peak Setting 1GHz to 10th harmonics of fundamental, RBW = 1MHz, VBW = 1MHz, Sweep time = Auto.
 - b. AV Setting 1GHz to 10th harmonics of fundamental, RBW = 1MHz, VBW = 10Hz, b. Sweep time = Auto.
5. Remark “*” means the Restricted band.



Operation Mode: TX(Y) / CH Mid

Test Date: September 30, 2009

Temperature: 31.2 °C

Tested by: Eric Yang

Humidity: 48% RH

Polarity: Horizontal

TX(Y) / CH Mid				Measurement Distance at 3m				Horizontal polarity	
Freq.	Reading	AF	Closs	Pre-amp	Filter	Level	Limit	Margin	Mark
(MHz)	(dBμV)	(dB/m)	(dB)	(dB)	(dB)	(dBμV/m)	(dBμV/m)	(dB)	(P/Q/A)
915.72	92.82	22.86	4.53	26.17	0.00	94.03	Fundamental Frequency		P
N/A	-----	-----	-----	-----	-----	-----			A
1831.38	73.98	29.02	2.24	40.01	0.96	66.18	74.03	-7.85	P
* 2746.31	59.01	29.95	2.38	39.87	1.41	52.89	74.00	-21.11	P
* 2746.31	54.52	29.95	2.38	39.87	1.41	48.40	54.00	-5.60	A
* 3662.88	59.48	30.43	3.27	40.53	0.80	53.45	74.00	-20.55	P
* 3662.88	53.66	30.43	3.27	40.53	0.80	47.63	54.00	-6.37	A
* 4578.68	58.00	32.27	3.57	40.97	0.60	53.48	74.00	-20.52	P
* 4578.68	49.59	32.27	3.57	40.97	0.60	45.07	54.00	-8.93	A
5492.24	64.97	33.99	4.08	42.13	0.89	61.79	74.30	-12.51	P
6410.05	64.95	35.58	4.55	42.00	0.77	63.85	74.30	-10.45	P
* 7325.75	61.24	38.96	4.97	41.30	1.63	65.49	74.00	-8.51	P
* 7325.75	48.57	38.96	4.97	41.30	1.63	52.82	54.00	-1.18	A
N/A	-----	-----	-----	-----	-----	-----	-----	-----	P
N/A	-----	-----	-----	-----	-----	-----	-----	-----	A

Remark:

1. Measuring frequencies from 1 GHz to the 10th harmonic of highest fundamental frequency.
2. Measurements above show only up to 6 maximum emissions noted, or would be lesser if no specific emissions from the EUT are recorded (ie: margin>20dB from the applicable limit) and considered that's already beyond the background noise floor.
3. Radiated emissions measured in frequency above 1000MHz were made with an instrument using Peak detector mode and average detector mode of the emission shown in Actual FS column.
4. Spectrum setting:
 - a. Peak Setting 1GHz to 10th harmonics of fundamental, RBW = 1MHz, VBW = 1MHz, Sweep time = Auto.
 - b. AV Setting 1GHz to 10th harmonics of fundamental, RBW = 1MHz, VBW = 10Hz, Sweep time = Auto.
5. Remark “*” means the Restricted band.



Operation Mode: TX(Y) / CH Mid

Test Date: September 30, 2009

Temperature: 31.2 °C

Tested by: Eric Yang

Humidity: 48% RH

Polarity: Vertical

TX(Y) / CH Mid				Measurement Distance at 3m				Vertical polarity		
Freq.	Reading	AF	Closs	Pre-amp	Filter	Level	Limit	Margin	Mark	
(MHz)	(dBμV)	(dB/m)	(dB)	(dB)	(dB)	(dBμV/m)	(dBμV/m)	(dB)	(P/Q/A)	
915.73	94.09	22.86	4.53	26.17	0.00	95.30	Fundamental Frequency		P	
N/A	-----	-----	-----	-----	-----	-----			A	
1831.22	68.94	29.02	2.24	40.01	0.96	61.14	75.30	-14.17	P	
* 2746.26	57.27	29.95	2.38	39.87	1.41	51.15	74.00	-22.85	P	
* 2746.26	51.75	29.95	2.38	39.87	1.41	45.63	54.00	-8.37	A	
* 3662.89	58.31	30.43	3.27	40.53	0.80	52.28	74.00	-21.72	P	
* 3662.89	52.26	30.43	3.27	40.53	0.80	46.23	54.00	-7.77	A	
* 4579.01	57.77	32.27	3.57	40.97	0.60	53.25	74.00	-20.75	P	
* 4579.01	49.07	32.27	3.57	40.97	0.60	44.55	54.00	-9.45	A	
5492.36	67.18	33.99	4.08	42.13	0.89	64.00	75.65	-11.65	P	
6409.99	65.78	35.58	4.55	42.00	0.77	64.68	75.65	-10.97	P	
* 7325.88	62.61	38.96	4.97	41.30	1.63	66.86	74.00	-7.14	P	
* 7325.88	47.82	38.96	4.97	41.30	1.63	52.07	54.00	-1.93	A	
N/A	-----	-----	-----	-----	-----	-----	-----	-----	P	
N/A	-----	-----	-----	-----	-----	-----	-----	-----	A	

Remark:

1. Measuring frequencies from 1 GHz to the 10th harmonic of highest fundamental frequency.
2. Measurements above show only up to 6 maximum emissions noted, or would be lesser if no specific emissions from the EUT are recorded (ie: margin>20dB from the applicable limit) and considered that's already beyond the background noise floor.
3. Radiated emissions measured in frequency above 1000MHz were made with an instrument using Peak detector mode and average detector mode of the emission shown in Actual FS column.
4. Spectrum setting:
 - a. Peak Setting 1GHz to 10th harmonics of fundamental, RBW = 1MHz, VBW = 1MHz, Sweep time = Auto.
 - b. AV Setting 1GHz to 10th harmonics of fundamental, RBW = 1MHz, VBW = 10Hz, b. Sweep time = Auto.
5. Remark “*” means the Restricted band.



Operation Mode: TX(Y) / CH High

Test Date: September 30, 2009

Temperature: 31.2 °C

Tested by: Eric Yang

Humidity: 48% RH

Polarity: Horizontal

TX(Y) / CH High				Measurement Distance at 3m			Horizontal polarity		
Freq.	Reading	AF	Closs	Pre-amp	Filter	Level	Limit	Margin	Mark
(MHz)	(dBμV)	(dB/m)	(dB)	(dB)	(dB)	(dBμV/m)	(dBμV/m)	(dB)	(P/Q/A)
926.80	90.57	22.97	4.54	26.16	0.00	91.92	Fundamental Frequency		P
N/A	-----	-----	-----	-----	-----	-----			A
1954.00	71.90	29.95	2.30	40.09	1.02	65.08	74.00	-8.92	P
* 2780.92	59.99	29.94	2.39	39.89	1.43	53.86	74.00	-20.14	P
* 2780.92	55.31	29.94	2.39	39.89	1.43	49.18	54.00	-4.82	A
* 3706.61	60.96	30.49	3.28	40.54	0.77	54.96	74.00	-19.04	P
* 3706.61	55.43	30.49	3.28	40.54	0.77	49.43	54.00	-4.57	A
* 4633.23	59.14	32.39	3.60	41.05	0.62	54.71	74.00	-19.29	P
* 4633.23	51.06	32.39	3.60	41.05	0.62	46.63	54.00	-7.37	A
5560.09	64.74	34.07	4.11	42.17	0.87	61.63	74.30	-12.67	P
6486.61	64.87	35.77	4.58	41.93	0.78	64.07	74.30	-10.23	P
* 7415.27	62.58	39.08	5.00	41.17	1.82	67.31	74.00	-6.69	P
* 7415.27	47.25	39.08	5.00	41.17	1.82	51.98	54.00	-2.02	A
N/A	-----	-----	-----	-----	-----	-----	-----	-----	P
N/A	-----	-----	-----	-----	-----	-----	-----	-----	A

Remark:

1. Measuring frequencies from 1 GHz to the 10th harmonic of highest fundamental frequency.
2. Measurements above show only up to 6 maximum emissions noted, or would be lesser if no specific emissions from the EUT are recorded (ie: margin>20dB from the applicable limit) and considered that's already beyond the background noise floor.
3. Radiated emissions measured in frequency above 1000MHz were made with an instrument using Peak detector mode and average detector mode of the emission shown in Actual FS column.
4. Spectrum setting:
 - a. Peak Setting 1GHz to 10th harmonics of fundamental, RBW = 1MHz, VBW = 1MHz, Sweep time = Auto.
 - b. AV Setting 1GHz to 10th harmonics of fundamental, RBW = 1MHz, VBW = 10Hz, Sweep time = Auto.
5. Remark “*” means the Restricted band.



Operation Mode: TX(Y) / CH High

Test Date: September 30, 2009

Temperature: 31.2 °C

Tested by: Eric Yang

Humidity: 48% RH

Polarity: Vertical

TX(Y) / CH High				Measurement Distance at 3m				Vertical polarity		
Freq.	Reading	AF	Closs	Pre-amp	Filter	Level	Limit	Margin	Mark	
(MHz)	(dBμV)	(dB/m)	(dB)	(dB)	(dB)	(dBμV/m)	(dBμV/m)	(dB)	(P/Q/A)	
926.89	94.06	22.97	4.54	26.16	0.00	95.41	Fundamental Frequency		P	
N/A	-----	-----	-----	-----	-----	-----			A	
1853.26	68.97	29.18	2.25	40.02	0.97	61.35	75.41	-14.07	P	
* 2780.97	54.46	29.94	2.39	39.89	1.43	48.33	74.00	-25.67	P	
* 2780.97	47.64	29.94	2.39	39.89	1.43	41.51	54.00	-12.49	A	
* 3707.63	58.55	30.49	3.28	40.54	0.77	52.55	74.00	-21.45	P	
* 3707.63	52.33	30.49	3.28	40.54	0.77	46.33	54.00	-7.67	A	
* 4634.71	58.85	32.40	3.60	41.05	0.62	54.42	74.00	-19.58	P	
* 4634.71	50.73	32.40	3.60	41.05	0.62	46.30	54.00	-7.70	A	
5559.98	65.01	34.07	4.11	42.17	0.87	61.90	75.65	-13.75	P	
6486.38	63.38	35.77	4.58	41.93	0.78	62.58	75.65	-13.07	P	
* 7415.69	62.84	39.08	5.00	41.17	1.82	67.58	74.00	-6.42	P	
* 7415.69	48.03	39.08	5.00	41.17	1.82	52.77	54.00	-1.23	A	
N/A	-----	-----	-----	-----	-----	-----	-----	-----	P	
N/A	-----	-----	-----	-----	-----	-----	-----	-----	A	

Remark:

1. Measuring frequencies from 1 GHz to the 10th harmonic of highest fundamental frequency.
2. Measurements above show only up to 6 maximum emissions noted, or would be lesser if no specific emissions from the EUT are recorded (ie: margin>20dB from the applicable limit) and considered that's already beyond the background noise floor.
3. Radiated emissions measured in frequency above 1000MHz were made with an instrument using Peak detector mode and average detector mode of the emission shown in Actual FS column.
4. Spectrum setting:
 - a. Peak Setting 1GHz to 10th harmonics of fundamental, RBW = 1MHz, VBW = 1MHz, Sweep time = Auto.
 - b. AV Setting 1GHz to 10th harmonics of fundamental, RBW = 1MHz, VBW = 10Hz, b. Sweep time = Auto.
5. Remark “*” means the Restricted band.

**Operation Mode:** TX(Z) / CH Low**Test Date:** September 30, 2009**Temperature:** 31.2 °C**Tested by:** Eric Yang**Humidity:** 48% RH**Polarity:** Horizontal

TX(Z) / CH Low				Measurement Distance at 3m			Horizontal polarity		
Freq.	Reading	AF	Closs	Pre-amp	Filter	Level	Limit	Margin	Mark
(MHz)	(dBμV)	(dB/m)	(dB)	(dB)	(dB)	(dBμV/m)	(dBμV/m)	(dB)	(P/Q/A)
902.86	84.23	22.73	4.51	26.19	0.00	85.29	Fundamental Frequency		P
N/A	-----	-----	-----	-----	-----	-----			A
1805.68	72.24	28.82	2.22	39.99	0.94	64.24	74.00	-9.76	P
* 2709.32	61.18	29.96	2.38	39.85	1.39	55.06	74.00	-18.94	P
* 2709.32	57.80	29.96	2.38	39.85	1.39	51.68	54.00	-2.32	A
* 3612.40	60.21	30.36	3.25	40.50	0.83	54.14	74.00	-19.86	P
* 3612.40	55.43	30.36	3.25	40.50	0.83	49.36	54.00	-4.64	A
* 4515.68	60.11	32.13	3.54	40.87	0.58	55.49	74.00	-18.51	P
* 4515.68	53.38	32.13	3.54	40.87	0.58	48.76	54.00	-5.24	A
* 5418.73	64.21	33.87	4.04	42.05	0.87	60.94	74.00	-13.06	P
* 5418.73	55.87	33.87	4.04	42.05	0.87	52.60	54.00	-1.40	A
6321.88	62.20	35.37	4.50	42.08	0.76	60.76	74.00	-13.24	P
7223.01	61.46	38.81	4.92	41.44	1.41	65.16	74.00	-8.84	P
N/A	-----	-----	-----	-----	-----	-----	-----	-----	P
N/A	-----	-----	-----	-----	-----	-----	-----	-----	A

Remark:

1. Measuring frequencies from 1 GHz to the 10th harmonic of highest fundamental frequency.
2. Measurements above show only up to 6 maximum emissions noted, or would be lesser if no specific emissions from the EUT are recorded (ie: margin > 20dB from the applicable limit) and considered that's already beyond the background noise floor.
3. Radiated emissions measured in frequency above 1000MHz were made with an instrument using Peak detector mode and average detector mode of the emission shown in Actual FS column.
4. Spectrum setting:
 - a. Peak Setting 1GHz to 10th harmonics of fundamental, RBW = 1MHz, VBW = 1MHz, Sweep time = Auto.
 - b. AV Setting 1GHz to 10th harmonics of fundamental, RBW = 1MHz, VBW = 10Hz, b. Sweep time = Auto.
5. Remark “*” means the Restricted band.



Operation Mode: TX(Z) / CH Low

Test Date: September 30, 2009

Temperature: 31.2 °C

Tested by: Eric Yang

Humidity: 48% RH

Polarity: Vertical

TX(Z) / CH Low				Measurement Distance at 3m				Vertical polarity		
Freq.	Reading	AF	Closs	Pre-amp	Filter	Level	Limit	Margin	Mark	
(MHz)	(dBμV)	(dB/m)	(dB)	(dB)	(dB)	(dBμV/m)	(dBμV/m)	(dB)	(P/Q/A)	
903.12	90.35	22.73	4.51	26.19	0.00	91.41	Fundamental Frequency		P	
N/A	-----	-----	-----	-----	-----	-----			A	
1805.57	77.28	28.82	2.22	39.99	0.94	69.27	74.00	-4.73	P	
* 2708.51	56.11	29.96	2.38	39.85	1.39	49.99	74.00	-24.01	P	
* 2708.51	49.33	29.96	2.38	39.85	1.39	43.21	54.00	-10.79	A	
* 3611.46	58.04	30.36	3.25	40.50	0.83	51.97	74.00	-22.03	P	
* 3611.46	51.75	30.36	3.25	40.50	0.83	45.68	54.00	-8.32	A	
* 4515.71	54.90	32.13	3.54	40.87	0.58	50.28	74.00	-23.72	P	
* 4515.71	43.55	32.13	3.54	40.87	0.58	38.93	54.00	-15.07	A	
* 5417.12	64.43	33.87	4.04	42.05	0.87	61.15	74.00	-12.85	P	
* 5417.12	55.64	33.87	4.04	42.05	0.87	52.36	54.00	-1.64	A	
6322.19	60.36	35.37	4.50	42.08	0.76	58.92	74.00	-15.08	P	
7222.94	58.70	38.81	4.92	41.44	1.41	62.40	74.00	-11.60	P	
N/A	-----	-----	-----	-----	-----	-----	-----	-----	P	
N/A	-----	-----	-----	-----	-----	-----	-----	-----	A	

Remark:

1. Measuring frequencies from 1 GHz to the 10th harmonic of highest fundamental frequency.
2. Measurements above show only up to 6 maximum emissions noted, or would be lesser if no specific emissions from the EUT are recorded (ie: margin>20dB from the applicable limit) and considered that's already beyond the background noise floor.
3. Radiated emissions measured in frequency above 1000MHz were made with an instrument using Peak detector mode and average detector mode of the emission shown in Actual FS column.
4. Spectrum setting:
 - a. Peak Setting 1GHz to 10th harmonics of fundamental, RBW = 1MHz, VBW = 1MHz, Sweep time = Auto.
 - b. AV Setting 1GHz to 10th harmonics of fundamental, RBW = 1MHz, VBW = 10Hz, Sweep time = Auto.
5. Remark “*” means the Restricted band.



Operation Mode: TX(Z) / CH Mid

Test Date: September 30, 2009

Temperature: 31.2 °C

Tested by: Eric Yang

Humidity: 48% RH

Polarity: Horizontal

TX(Z) / CH Mid				Measurement Distance at 3m			Horizontal polarity		
Freq.	Reading	AF	Closs	Pre-amp	Filter	Level	Limit	Margin	Mark
(MHz)	(dBμV)	(dB/m)	(dB)	(dB)	(dB)	(dBμV/m)	(dBμV/m)	(dB)	(P/Q/A)
915.72	84.51	22.86	4.53	26.17	0.00	85.72	Fundamental Frequency		P
N/A	-----	-----	-----	-----	-----	-----			A
1830.91	70.01	29.01	2.24	40.01	0.96	62.21	74.00	-11.79	P
* 2746.34	61.69	29.95	2.38	39.87	1.41	55.57	74.00	-18.43	P
* 2746.34	57.23	29.95	2.38	39.87	1.41	51.11	54.00	-2.89	A
* 3661.70	60.26	30.43	3.26	40.52	0.80	54.23	74.00	-19.77	P
* 3661.70	55.30	30.43	3.26	40.52	0.80	49.27	54.00	-4.73	A
* 4578.57	60.66	32.27	3.57	40.97	0.60	56.14	74.00	-17.86	P
* 4578.57	54.11	32.27	3.57	40.97	0.60	49.59	54.00	-4.41	A
5494.30	68.89	33.99	4.08	42.13	0.89	65.71	74.00	-8.29	P
6409.99	65.17	35.58	4.55	42.00	0.77	64.07	74.00	-9.93	P
* 7325.78	62.14	38.96	4.97	41.30	1.63	66.39	74.00	-7.61	P
* 7325.78	48.25	38.96	4.97	41.30	1.63	52.50	54.00	-1.50	A
N/A	-----	-----	-----	-----	-----	-----	-----	-----	P
N/A	-----	-----	-----	-----	-----	-----	-----	-----	A

Remark:

1. Measuring frequencies from 1 GHz to the 10th harmonic of highest fundamental frequency.
2. Measurements above show only up to 6 maximum emissions noted, or would be lesser if no specific emissions from the EUT are recorded (ie: margin>20dB from the applicable limit) and considered that's already beyond the background noise floor.
3. Radiated emissions measured in frequency above 1000MHz were made with an instrument using Peak detector mode and average detector mode of the emission shown in Actual FS column.
4. Spectrum setting:
 - a. Peak Setting 1GHz to 10th harmonics of fundamental, RBW = 1MHz, VBW = 1MHz, Sweep time = Auto.
 - b. AV Setting 1GHz to 10th harmonics of fundamental, RBW = 1MHz, VBW = 10Hz, Sweep time = Auto.
5. Remark “*” means the Restricted band.



Operation Mode: TX(Z) / CH Mid

Test Date: September 30, 2009

Temperature: 31.2 °C

Tested by: Eric Yang

Humidity: 48% RH

Polarity: Vertical

TX(Z) / CH Mid				Measurement Distance at 3m				Vertical polarity		
Freq.	Reading	AF	Closs	Pre-amp	Filter	Level	Limit	Margin	Mark	
(MHz)	(dBµV)	(dB/m)	(dB)	(dB)	(dB)	(dBµV/m)	(dBµV/m)	(dB)	(P/Q/A)	
915.47	91.71	22.85	4.53	26.17	0.00	92.92	Fundamental Frequency		P	
N/A	-----	-----	-----	-----	-----	-----			A	
1831.42	69.53	29.02	2.24	40.01	0.96	61.73	74.00	-12.27	P	
* 2746.39	57.27	29.95	2.38	39.87	1.41	51.15	74.00	-22.85	P	
* 2746.39	53.03	29.95	2.38	39.87	1.41	46.91	54.00	-7.09	A	
* 3662.29	56.91	30.43	3.27	40.52	0.80	50.88	74.00	-23.12	P	
* 3662.29	49.83	30.43	3.27	40.52	0.80	43.80	54.00	-10.20	A	
* 4577.26	60.36	32.27	3.57	40.97	0.60	55.84	74.00	-18.16	P	
* 4577.26	52.17	32.27	3.57	40.97	0.60	47.65	54.00	-6.35	A	
5494.43	62.77	33.99	4.08	42.13	0.89	59.59	74.00	-14.41	P	
6408.25	62.47	35.58	4.55	42.00	0.77	61.36	74.00	-12.64	P	
* 7326.28	62.35	38.96	4.97	41.30	1.63	66.61	74.00	-7.39	P	
* 7326.28	48.35	38.96	4.97	41.30	1.63	52.61	54.00	-1.39	A	
N/A	-----	-----	-----	-----	-----	-----	-----	-----	P	
N/A	-----	-----	-----	-----	-----	-----	-----	-----	A	

Remark:

1. Measuring frequencies from 1 GHz to the 10th harmonic of highest fundamental frequency.
2. Measurements above show only up to 6 maximum emissions noted, or would be lesser if no specific emissions from the EUT are recorded (ie: margin>20dB from the applicable limit) and considered that's already beyond the background noise floor.
3. Radiated emissions measured in frequency above 1000MHz were made with an instrument using Peak detector mode and average detector mode of the emission shown in Actual FS column.
4. Spectrum setting:
 - a. Peak Setting 1GHz to 10th harmonics of fundamental, RBW = 1MHz, VBW = 1MHz, Sweep time = Auto.
 - b. AV Setting 1GHz to 10th harmonics of fundamental, RBW = 1MHz, VBW = 10Hz, b. Sweep time = Auto.
5. Remark “*” means the Restricted band.



Operation Mode: TX(Z) / CH High

Test Date: September 30, 2009

Temperature: 31.2 °C

Tested by: Eric Yang

Humidity: 48% RH

Polarity: Horizontal

TX(Z) / CH High				Measurement Distance at 3m			Horizontal polarity		
Freq.	Reading	AF	Closs	Pre-amp	Filter	Level	Limit	Margin	Mark
(MHz)	(dBμV)	(dB/m)	(dB)	(dB)	(dB)	(dBμV/m)	(dBμV/m)	(dB)	(P/Q/A)
926.66	84.25	22.97	4.54	26.16	0.00	85.60	Fundamental Frequency		P
N/A	-----	-----	-----	-----	-----	-----			A
1853.40	72.24	29.19	2.25	40.02	0.97	64.62	74.00	-9.38	P
* 2781.02	61.14	29.94	2.39	39.89	1.43	55.01	74.00	-18.99	P
* 2781.02	57.01	29.94	2.39	39.89	1.43	50.88	54.00	-3.12	A
* 3707.58	62.17	30.49	3.28	40.54	0.77	56.17	74.00	-17.83	P
* 3707.58	56.72	30.49	3.28	40.54	0.77	50.72	54.00	-3.28	A
* 4634.55	61.30	32.40	3.60	41.05	0.62	56.87	74.00	-17.13	P
* 4634.55	53.85	32.40	3.60	41.05	0.62	49.42	54.00	-4.58	A
5559.88	64.66	34.07	4.11	42.17	0.87	61.55	74.00	-12.45	P
6486.67	64.70	35.77	4.58	41.93	0.78	63.90	74.00	-10.10	P
* 7415.35	62.53	39.08	5.00	41.17	1.82	67.26	74.00	-6.74	P
* 7415.35	48.11	39.08	5.00	41.17	1.82	52.84	54.00	-1.16	A
N/A	-----	-----	-----	-----	-----	-----	-----	-----	P
N/A	-----	-----	-----	-----	-----	-----	-----	-----	A

Remark:

1. Measuring frequencies from 1 GHz to the 10th harmonic of highest fundamental frequency.
2. Measurements above show only up to 6 maximum emissions noted, or would be lesser if no specific emissions from the EUT are recorded (ie: margin>20dB from the applicable limit) and considered that's already beyond the background noise floor.
3. Radiated emissions measured in frequency above 1000MHz were made with an instrument using Peak detector mode and average detector mode of the emission shown in Actual FS column.
4. Spectrum setting:
 - a. Peak Setting 1GHz to 10th harmonics of fundamental, RBW = 1MHz, VBW = 1MHz, Sweep time = Auto.
 - b. AV Setting 1GHz to 10th harmonics of fundamental, RBW = 1MHz, VBW = 10Hz, Sweep time = Auto.
5. Remark “*” means the Restricted band.



Operation Mode: TX(Z) / CH High

Test Date: September 30, 2009

Temperature: 31.2 °C

Tested by: Eric Yang

Humidity: 48% RH

Polarity: Vertical

TX(Z) / CH High				Measurement Distance at 3m				Vertical polarity		
Freq.	Reading	AF	Closs	Pre-amp	Filter	Level	Limit	Margin	Mark	
(MHz)	(dBμV)	(dB/m)	(dB)	(dB)	(dB)	(dBμV/m)	(dBμV/m)	(dB)	(P/Q/A)	
926.89	91.24	22.97	4.54	26.16	0.00	92.59	Fundamental Frequency		P	
N/A	-----	-----	-----	-----	-----	-----			A	
1853.28	70.19	29.18	2.25	40.02	0.97	62.57	74.00	-11.43	P	
* 2780.75	56.90	29.94	2.39	39.89	1.43	50.77	74.00	-23.23	P	
* 2780.75	51.30	29.94	2.39	39.89	1.43	45.17	54.00	-8.83	A	
* 3706.38	56.56	30.49	3.28	40.54	0.77	50.56	74.00	-23.44	P	
* 3706.38	49.51	30.49	3.28	40.54	0.77	43.51	54.00	-10.49	A	
* 4633.15	56.75	32.39	3.60	41.05	0.62	52.32	74.00	-21.68	P	
* 4633.15	45.97	32.39	3.60	41.05	0.62	41.54	54.00	-12.46	A	
5559.88	61.25	34.07	4.11	42.17	0.87	58.14	74.00	-15.86	P	
6486.62	61.57	35.77	4.58	41.93	0.78	60.77	74.00	-13.23	P	
* 7415.96	61.24	39.08	5.00	41.17	1.82	65.98	74.00	-8.02	P	
* 7415.96	47.86	39.08	5.00	41.17	1.82	52.60	54.00	-1.40	A	
N/A	-----	-----	-----	-----	-----	-----	-----	-----	P	
N/A	-----	-----	-----	-----	-----	-----	-----	-----	A	

Remark:

1. Measuring frequencies from 1 GHz to the 10th harmonic of highest fundamental frequency.
2. Measurements above show only up to 6 maximum emissions noted, or would be lesser if no specific emissions from the EUT are recorded (ie: margin>20dB from the applicable limit) and considered that's already beyond the background noise floor.
3. Radiated emissions measured in frequency above 1000MHz were made with an instrument using Peak detector mode and average detector mode of the emission shown in Actual FS column.
4. Spectrum setting:
 - a. Peak Setting 1GHz to 10th harmonics of fundamental, RBW = 1MHz, VBW = 1MHz, Sweep time = Auto.
 - b. AV Setting 1GHz to 10th harmonics of fundamental, RBW = 1MHz, VBW = 10Hz, b. Sweep time = Auto.
5. Remark “*” means the Restricted band.



8.7 POWER LINE CONDUCTED EMISSIONS

LIMIT

For an intentional radiator which is designed to be connected to the public utility (AC) power line, the radio frequency voltage that is conducted back onto the AC power line on any frequency or frequencies within the band 150 kHz to 30 MHz shall not exceed 250 microvolts (The limit decreases linearly with the logarithm of the frequency in the range 0.15 MHz to 0.50 MHz). The limits at specific frequency range is listed as follows:

Frequency Range (MHz)	Limits (dBµV)	
	Quasi-peak	Average
0.15 to 0.50	66 to 56	56 to 46
0.50 to 5	56	46
5 to 30	60	50

Compliance with this provision shall be based on the measurement of the radio frequency voltage between each power line (*Live Line* and *Neutral Line*) and ground at the power terminals.

MEASUREMENT EQUIPMENT USED

Conducted Emission room #1				
Name of Equipment	Manufacturer	Model	Serial Number	Calibration Due
L.I.S.N.	SCHWARZBECK	NNLK 8121	8121-446	NOV. 19, 2009 For Insertion loss
	Rohde & Schwarz	ESH 3-Z5	840062/021	OCT. 05, 2010
TEST RECEIVER	Rohde & Schwarz	ESCS 30	100348	JUL. 02, 2010
TYPE N COAXIAL CABLE	SUHNER	BELDEN9913	2981	JAN. 14, 2010
Test S/W	e-3 (5.04211c) R&S (2.27)			

REMARK: Each piece of equipment is scheduled for calibration once a year.

TEST CONFIGURATION

See test photographs attached in Appendix 1 for the actual connections between EUT and support equipment.

TEST PROCEDURE

1. The EUT was placed on a table, which is 0.8m above ground plane.
2. Maximum procedure was performed on the six highest emissions to ensure EUT compliance.
3. Repeat above procedures until all frequency measured were complete.

TEST RESULTS

This EUT has not connection to AC Source directly. No applicability for this test.