

# COMMUNICATION CERTIFICATION LABORATORY

1940 West Alexander Street  
Salt Lake City, UT 84119  
801-972-6146

## Test Report

Certification

Test Of:

SKYAP1

FCC ID:

XUS-SKYAP1

Test Specifications:

FCC PART 15, Subpart C

Test Report Serial No: 2495

Applicant:

Ellab A/S  
Trollesmindealle 25  
DK-3400 Hilleroed  
Denmark

Date of Test: November 17, 2009

Issue Date: December 1, 2009

Accredited Testing Laboratory By:



NVLAP Lab Code 100272-0

**CERTIFICATION OF ENGINEERING REPORT**

This report has been prepared by Communication Certification Laboratory to document compliance of the device described below with the requirements of Federal Communications Commission (FCC) Part 15, Subpart C. This report may be reproduced in full, partial reproduction may only be made with the written consent of the laboratory. The results in this report apply only to the sample tested.

- Applicant: Ellab A/S
- Manufacturer: Ellab A/S
- Brand Name: Ellab
- Model Number: SKYAP1
- FCC ID Number: XUS-SKYAP1

On this 1<sup>st</sup> day of December 2009, I, individually, and for Communication Certification Laboratory, certify that the statements made in this engineering report are true, complete, and correct to the best of my knowledge, and are made in good faith.

Although NVLAP has recognized that the Communication Certification Laboratory EMC testing facilities are in good standing, this report must not be used to claim product certification, approval, or endorsement by NVLAP, NIST, or any agency of the federal government.

COMMUNICATION CERTIFICATION LABORATORY



---

Tested by: Norman P. Hansen  
EMC Technician

## TABLE OF CONTENTS

	<u>PAGE</u>
<u>SECTION 1.0 CLIENT INFORMATION</u> .....	4
<u>SECTION 2.0 EQUIPMENT UNDER TEST (EUT)</u> .....	5
<u>SECTION 3.0 TEST SPECIFICATION, METHODS &amp; PROCEDURES</u> .....	7
<u>SECTION 4.0 OPERATION OF EUT DURING TESTING</u> .....	14
<u>SECTION 5.0 SUMMARY OF TEST RESULTS</u> .....	15
<u>SECTION 6.0 MEASUREMENTS, EXAMINATIONS AND DERIVED RESULTS</u> .....	16
<u>APPENDIX 1 TEST PROCEDURES AND TEST EQUIPMENT</u> .....	29
<u>APPENDIX 2 PHOTOGRAPHS</u> .....	37

**SECTION 1.0 CLIENT INFORMATION**

**1.1 Applicant:**

Company Name: Ellab A/S  
Trollesmindealle 25  
DK-3400 Hilleroed  
Denmark

Contact Name: Niels Hansen  
Title: Engineer

**1.2 Manufacturer:**

Company Name: Ellab A/S  
Trollesmindealle 25  
DK-3400 Hilleroed  
Denmark

Contact Name: Niels Hansen  
Title: Engineer

**SECTION 2.0 EQUIPMENT UNDER TEST (EUT)****2.1 Identification of EUT:**

Brand Name: Ellab  
 Model Number: SKYAP1  
 Serial Number: None

**2.2 Description of EUT:**

The SKYAP1 is a module for use in Access Points for Ellab systems. The SKYAP1 module has an 802.15.4 transceiver and uses a Hwa Yao Tech Co. Ltd. 5 dBi, ¼ wave dipole antenna with reverse SMA connector. There are 15 channels used, starting at 2405 MHz, spaced every 5 MHz, with the upper channel at 2475 MHz (See the table below). 3.3 Vdc and data from the host are brought into the module over a 4 pin header.

Channel	Frequency (MHz)	Channel	Frequency (MHz)	Channel	Frequency (MHz)
11	2405	16	2430	21	2455
12	2410	17	2435	22	2460
13	2415	18	2440	23	2465
14	2420	19	2445	24	2470
15	2425	20	2450	25	2475

Testing was performed at the upper (2475 MHz), middle (2440 MHz), and lower (2405 MHz) channels.

This report covers the circuitry of the devices subject to FCC Part 15, Subpart C. The circuitry of the device subject to other standards, is to be tested and covered in other reports.

**2.3 EUT and Support Equipment:**

The FCC ID numbers for all the EUT and support equipment used during the test are listed below:

Brand Name Model Number	FCC ID Number	Description	Name of Interface Ports / Interface Cables
BN: Ellab MN: SKYAP1 (Note 1)	XUS-SKYAP1	Transmitter Module	See Section 2.4

Brand Name Model Number	FCC ID Number	Description	Name of Interface Ports / Interface Cables
BN: Ellab MN: Test Fixture	None	Test fixture acting as module host	Module Interface/4 conductor cable (Note 2)  Serial/Shielded serial cable with DB9 connector to Serial to USB interface adapter  DC power/ Unshielded 2 conductor cable
BN: Stontronics MN: T3172ST	None	Power Supply	AC/3 conductor power cord  DC/Unshielded 2 conductor cable

Note: (1) EUT  
(2) Interface port connected to EUT (See Section 2.4)

The support equipment listed above was not modified in order to achieve compliance with this standard.

#### **2.4 Interface Ports on EUT:**

Name of Ports	No. of Ports Fitted to EUT	Cable Descriptions/Length
System Interface	1	4 conductor cable/20 cm

#### **2.5 Modification Incorporated/Special Accessories on EUT:**

There were no modifications or special accessories required to comply with the specification.

Signature: \_\_\_\_\_

Typed Name: Niels Hansen

Title: Engineer

**SECTION 3.0 TEST SPECIFICATION, METHODS & PROCEDURES****3.1 Test Specification:**

Title: FCC PART 15, Subpart C (47 CFR 15).  
15.203, 15.207, and 15.247

Limits and methods of measurement of radio interference characteristics of radio frequency devices.

Purpose of Test: The tests were performed to demonstrate initial compliance.

**3.2 Methods & Procedures:****3.2.1 §15.203 Antenna Requirement**

An intentional radiator shall be designed to ensure that no antenna other than that furnished by the responsible party shall be used with the device. The use of a permanently attached antenna or of an antenna that uses a unique coupling to the intentional radiator shall be considered sufficient to comply with the provisions of this Section. The manufacturer may design the unit so that a broken antenna can be replaced by the user, but the use of a standard antenna jack or electrical connector is prohibited. This requirement does not apply to carrier current devices or to devices operated under the provisions of Sections 15.211, 15.213, 15.217, 15.219, or 15.221. Further, this requirement does not apply to intentional radiators that must be professionally installed, such as perimeter protection systems and some field disturbance sensors, or to other intentional radiators which, in accordance with Section 15.31(d), must be measured at the installation site. However, the installer shall be responsible for ensuring that the proper antenna is employed so that the limits in this Part are not exceeded.

**3.2.2 §15.207 Conducted Limits**

(a) Except for Class A digital devices, for equipment that is designed to be connected to the public utility (AC) power line, the radio frequency voltage that is conducted back onto the AC power line on any frequency or frequencies within the band 150 kHz to 30 MHz shall not exceed the limits in the following table, as measured using a 50  $\mu$ H/50 ohms line impedance stabilization network (LISN). Compliance with the provisions of this paragraph shall be based on the measurement of the radio frequency voltage between each power line and ground at the power terminal. The lower limit applies at the band edges.

Frequency of Emission (MHz)	Conducted Limit (dB $\mu$ V)	
	Quasi-peak	Average
0.15 - 0.5*	66 to 56*	56 to 46*
0.5 - 5	56	46
5 - 30	60	50

\*Decreases with the logarithm of the frequency.

### **3.2.3 §15.247 Operation within the bands 902 - 928 MHz, 2400 - 2483.5 MHz, and 5725 -5850 MHz**

(a) Operation under the provisions of this Section is limited to frequency hopping and digitally modulated intentional radiators that comply with the following provisions:

(1) Frequency hopping systems shall have hopping channel carrier frequencies separated by a minimum of 25 kHz or the 20 dB bandwidth of the hopping channel, whichever is greater. Alternatively, frequency hopping systems operating in the 2400 - 2483.5 MHz band may have hopping channel carrier frequencies that are separated by 25 kHz or two-thirds of the 20 dB bandwidth of the hopping channel, whichever is greater, provided the systems operate with an output power no greater than 125 mW. The system shall hop to channel frequencies that are selected at the system hopping rate from a pseudorandomly ordered list of hopping frequencies. Each frequency must be used equally on the average by each transmitter. The system receivers shall have input bandwidths that match the hopping channel bandwidths of their corresponding transmitters and shall shift frequencies in synchronization with the transmitted signals.

(i) For frequency hopping systems operating in the 902-928 MHz band: if the 20 dB bandwidth of the hopping channel is less than 250 kHz, the system shall use at least 50 hopping frequencies and the average time of occupancy on any frequency shall not be greater than 0.4 seconds within a 20 second period; if the 20 dB bandwidth of the hopping channel is 250 kHz or greater, the system shall use at least 25 hopping frequencies and the average time of occupancy on any frequency shall not be greater than 0.4 seconds within a 10 second period. The maximum allowed 20 dB bandwidth of the hopping channel is 500 kHz.

(ii) Frequency hopping systems operating in the 5725-5850 MHz band shall use at least 75 hopping frequencies. The maximum 20 dB bandwidth of the hopping channel is 1 MHz. The average time of occupancy on any frequency shall not be greater than 0.4 seconds within a 30 second period.



(iii) Frequency hopping systems in the 2400-2483.5 MHz band shall use at least 15 non-overlapping channels. The average time of occupancy on any channel shall not be greater than 0.4 seconds within a period of 0.4 seconds multiplied by the number of hopping channels employed. Frequency hopping systems may avoid or suppress transmissions on a particular hopping frequency provided that a minimum of 15 non-overlapping channels are used.

(2) Systems using digital modulation techniques may operate in the 902 - 928 MHz, 2400 - 2483.5 MHz, and 5725 - 5850 MHz bands. The minimum 6 dB bandwidth shall be at least 500 kHz.

(b) The maximum peak output power of the intentional radiator shall not exceed the following:

(1) For frequency hopping systems operating in the 2400-2483.5 MHz band employing at least 75 non-overlapping hopping channels, and all frequency hopping systems in the 5725-5850 MHz band: 1 watt. For all other frequency hopping systems in the 2400-2483.5 MHz band: 0.125 watts.

(2) For frequency hopping systems operating in the 902-928 MHz band: 1 watt for systems employing at least 50 hopping channels; and, 0.25 watts for systems employing less than 50 hopping channels, but at least 25 hopping channels, as permitted under paragraph (a)(1)(i) of this section.

(3) For systems using digital modulation in the 902-928 MHz, 2400-2483.5 MHz, and 5725 - 5850 MHz bands: 1 watt. As an alternative to a peak power measurement, compliance with the Conducted Output Power is defined as the total transmit power delivered to all antennas and antenna elements averaged across all symbols in the signaling alphabet when the transmitter is operating at its maximum power control level. Power must be summed across all antennas and antenna elements. The average must not include any time intervals during which the transmitter is off or is transmitting at a reduced power level. If multiple modes of operation are possible (e.g., alternative modulation methods), the maximum conducted output power is the highest total transmit power occurring in any mode.

(4) The conducted output power limit specified in paragraph (b) of this section is based on the use of antennas with directional gains that do not exceed 6 dBi. Except as shown in paragraph (c) of this section, if transmitting antennas of directional gain greater than 6 dBi are used, the conducted power from the intentional radiator

shall be reduced below the stated values in paragraphs (b)(1), (b)(2), and (b)(3) of this section, as appropriate, by the amount in dB that the directional gain of the antenna exceeds 6 dBi.

(c) Operation with directional antenna gains greater than 6 dBi.

(1) Fixed point-to-point operation:

(i) Systems operating in the 2400-2483.5 MHz band that are used exclusively for fixed, point-to-point operations may employ transmitting antennas with directional gain greater than 6 dBi provided the maximum peak output power of the intentional radiator is reduced by 1 dB for every 3 dB that the directional gain of the antenna exceeds 6 dBi.

(ii) Systems operating in the 5725-5850 MHz band that are used exclusively for fixed, point-to-point operations may employ transmitting antennas with directional gain greater than 6 dBi without any corresponding reduction in transmitter peak output power.

(iii) Fixed, point-to-point operation, as used in paragraphs (b)(4)(i) and (b)(4)(ii) of this section, excludes the use of point-to-multipoint systems, omnidirectional applications, and multiple co-located intentional radiators transmitting the same information. The operator of the spread spectrum or digitally modulated intentional radiator or, if the equipment is professionally installed, the installer is responsible for ensuring that the system is used exclusively for fixed, point-to-point operations. The instruction manual furnished with the intentional radiator shall contain language in the installation instructions informing the operator and the installer of this responsibility.

(2) In addition to the provisions in paragraphs (b)(1), (b)(3), (b)(4) and (c)(1)(i) of this section, transmitters operating in the 2400-2483.5 MHz band that emit multiple directional beams, simultaneously or sequentially, for the purpose of directing signals to individual receivers or to groups of receivers provided the emissions comply with the following:

(i) Different information must be transmitted to each receiver.

(ii) If the transmitter employs an antenna system that emits multiple directional beams but does not emit

multiple directional beams simultaneously, the total output power conducted to the array or arrays that comprise the device, i.e., the sum of the power supplied to all antennas, antenna elements, staves, etc. and summed across all carriers or frequency channels, shall not exceed the limit specified in paragraph (b)(1) or (b)(3) of this section, as applicable. However, the total conducted output power shall be reduced by 1 dB below the specified limits for each 3 dB that the directional gain of the antenna /antenna array exceeds 6 dBi. The directional antenna gain shall be computed as follows:

(A) The directional gain shall be calculated as the sum of  $10 \log$  (number of array elements or staves) plus the directional gain of the element or staff having the highest gain.

(B) A lower value for the directional gain than that calculated in paragraph (c)(2)(ii)(A) of this section will be accepted if sufficient evidence is presented, e.g., due to shading of the array or coherence loss in the beamforming.

(iii) If a transmitter employs an antenna that operates simultaneously on multiple directional beams using the same or different frequency channels, the power supplied to each emission beam is subject to the power limit specified in paragraph (c)(2)(ii) of this section. If transmitted beams overlap, the power shall be reduced to ensure that their aggregate power does not exceed the limit specified in paragraph (c)(2)(ii) of this section. In addition, the aggregate power transmitted simultaneously on all beams shall not exceed the limit specified in paragraph (c)(2)(ii) of this section by more than 8 dB.

(iv) Transmitters that emit a single directional beam shall operate under the provisions of paragraph (c)(1) of this section.

(d) In any 100 kHz bandwidth outside the frequency band in which the spread spectrum or digitally modulated intentional radiator is operating, the radio frequency power that is produced by the intentional radiator shall be at least 20 dB below that in the 100 kHz bandwidth within the band that contains the highest level of the desired power, based on either an RF conducted or a radiated measurement, provided the transmitter demonstrates compliance with the peak conducted power limits. If the transmitter complies with the conducted power limits based on the use of RMS averaging over a time interval, as permitted under paragraph (b)(3) of this section, the attenuation required under

this paragraph shall be 30 dB instead of 20 dB. Attenuation below the general limits specified in Section 15.209(a) is not required. In addition, radiated emissions which fall in the restricted bands, as defined in Section 15.205(a), must also comply with the radiated emission limits specified in Section 15.209(a) (see Section 15.205(c)).

(e) For digitally modulated systems, the power spectral density conducted from the intentional radiator to the antenna shall not be greater than 8 dBm in any 3 kHz band during any time interval of continuous transmission. This power spectral density shall be determined in accordance with the provisions of paragraph (b) of this section. The same method of determining the conducted output power shall be used to determine the power spectral density.

(f) For the purposes of this section, hybrid systems are those that employ a combination of both frequency hopping and digital modulation techniques. The frequency hopping operation of the hybrid system, with the direct sequence or digital modulation operation turned off, shall have an average time of occupancy on any frequency not to exceed 0.4 seconds within a time period in seconds equal to the number of hopping frequencies employed multiplied by 0.4. The digital modulation operation of the hybrid system, with the frequency hopping turned off, shall comply with the power density requirements of paragraph (d) of this section.

(g) Frequency hopping spread spectrum systems are not required to employ all available hopping channels during each transmission. However, the system, consisting of both the transmitter and the receiver, must be designed to comply with all of the regulations in this section should the transmitter be presented with a continuous data (or information) stream. In addition, a system employing short transmission bursts must comply with the definition of a frequency hopping system and must distribute its transmissions over the minimum number of hopping channels specified in this section.

(h) The incorporation of intelligence within a frequency hopping spread spectrum system that permits the system to recognize other users within the spectrum band so that it individually and independently chooses and adapts its hopsets to avoid hopping on occupied channels is permitted. The coordination of frequency hopping systems in any other manner for the express purpose of avoiding the simultaneous occupancy of individual hopping frequencies by multiple transmitters is not permitted.

(i) Systems operating under the provisions of this section shall be operated in a manner that ensures that the public is not exposed to radio frequency energy levels in excess of the Commission's guidelines. See § 1.1307(b)(1) of this Chapter.

Note: Spread spectrum systems are sharing these bands on a noninterference basis with systems supporting critical Government requirements that have been allocated the usage of these bands, secondary only to ISM equipment operated under the provisions of Part 18 of this Chapter. Many of these Government systems are airborne radiolocation systems that emit a high EIRP which can cause interference to other users. Also, investigations of the effect of spread spectrum interference to U. S. Government operations in the 902-928 MHz band may require a future decrease in the power limits allowed for spread spectrum operation.

### **3.3 Test Procedure**

The conducted disturbance at mains ports and radiated disturbance testing was performed according to the procedures in ANSI C63.4: 2004. Testing was performed at CCL's Wanship open area test site #2, located at 29145 Old Lincoln Highway, Wanship, UT. This site has been fully described in a report submitted to the FCC, and was accepted in a letter dated March 11, 2009 (90504).

CCL is accredited by National Voluntary Laboratory Accreditation Program (NVLAP); NVLAP Lab Code: 100272-0, which is effective until September 30, 2010.

For radiated emissions testing at 30 MHz or above that is performed at distances closer than the specified distance, an inverse proportionality factor of 20 dB per decade is used to normalize the measured data for determining compliance.

**SECTION 4.0 OPERATION OF EUT DURING TESTING**

**4.1 Operating Environment:**

Power Supply:           120 VAC/60 Hz to AC power supply  
                          3.3 Vdc from Host to EUT

**4.2 Operating Modes:**

The transmitter was tested on three orthogonal axes while in a constant transmit mode at the desired frequency, using either the upper, middle, or lower channel.

**4.3 EUT Exercise Software:**

Ellab A/S software was used to exercise the transmitter.

**SECTION 5.0 SUMMARY OF TEST RESULTS****5.1 FCC Part 15, Subpart C****5.1.1 Summary of Tests:**

<b>Section</b>	<b>Environmental Phenomena</b>	<b>Frequency Range (MHz)</b>	<b>Result</b>
15.203	Antenna Requirements	Structural requirement	Complied
15.207	Conducted Disturbance at Mains Ports	0.15 to 30	Complied
15.247(a)	Bandwidth Requirement	2400 - 2483.5	Complied
15.247(b)	Peak Output Power	2400 - 2483.5	Complied
15.247(c)	Antenna Conducted Spurious Emissions	30 - 25000	Complied
15.247(c)	Radiated Spurious Emissions	30 - 25000	Complied
15.247(d)	Peak Power Spectral Density	2400 - 2483.5	Complied
15.247(e)	Reserved Paragraph	N/A	Not Applicable
15.247(f)	Hybrid System Requirements	2400 - 2483.5	Not Applicable
15.247(g)	Frequency Hopping Channel Usage	2400 - 2438.5	Not Applicable
15.247(h)	Frequency Hopping Intelligence	2400 - 2483.5	Not Applicable

**5.2 Result**

In the configuration tested, the EUT complied with the requirements of the specification.

**SECTION 6.0 MEASUREMENTS, EXAMINATIONS AND DERIVED RESULTS****6.1 General Comments:**

This section contains the test results only. Details of the test methods used and a list of the test equipment used during the measurements can be found in Appendix 1 of this report.

**6.2 Test Results:****6.2.1 §15.203 Antenna Requirements**

The EUT uses a Hwa Yao Technology Co. Ltd. 5 dBi,  $\frac{1}{4}$  wave antenna with reverse SMA connector.

**6.2.2 §15.207 Conducted Disturbance at the AC Mains Ports**

Frequency (MHz)	AC Mains Lead	Detector	Measured Level (dB $\mu$ V)	Limit (dB $\mu$ V)	Margin (dB)
0.17	Hot Lead	Quasi-Peak (Note 2)	52.9	64.8	-11.9
0.17	Hot Lead	Average (Note 2)	39.4	54.8	-15.4
0.36	Hot Lead	Peak (Note 1)	42.9	48.7	-5.8
0.38	Hot Lead	Peak (Note 1)	40.3	48.2	-7.9
0.52	Hot Lead	Peak (Note 1)	35.5	46.0	-10.5
6.45	Hot Lead	Peak (Note 1)	38.5	50.0	-11.5
7.35	Hot Lead	Peak (Note 1)	38.4	50.0	-11.6
0.16	Neutral Lead	Quasi-Peak (Note 2)	51.4	65.5	-14.1
0.16	Neutral Lead	Average (Note 2)	32.4	55.5	-23.1
0.26	Neutral Lead	Peak (Note 1)	45.7	51.5	-5.8
0.46	Neutral Lead	Peak (Note 1)	37.5	46.7	-9.2
0.57	Neutral Lead	Peak (Note 1)	33.9	46.0	-12.1
6.55	Neutral Lead	Peak (Note 1)	37.6	50.0	-12.4
7.25	Neutral Lead	Peak (Note 1)	37.8	50.0	-12.2

Note 1: The reference detector used for the measurements was Quasi-Peak or Peak and the data was compared to the average limit; therefore, the EUT was deemed to meet both the average and quasi-peak limits.

Note 2: The reference detector used for the measurements was quasi-peak and average and the data was compared to the respective limits.



**RESULT**

The EUT complied with the specification by 5.8 dB.

**6.2.3 §15.247(a)(2) Emission Bandwidth**

Frequency (MHz)	Emission 6 dB bandwidth (kHz)
2405	1660
2440	1610
2475	1590

**RESULT**

In the configuration tested, the 6 dB bandwidth was greater than 500 kHz; therefore, the EUT complied with the requirements of the specification (see spectrum analyzer plots below).

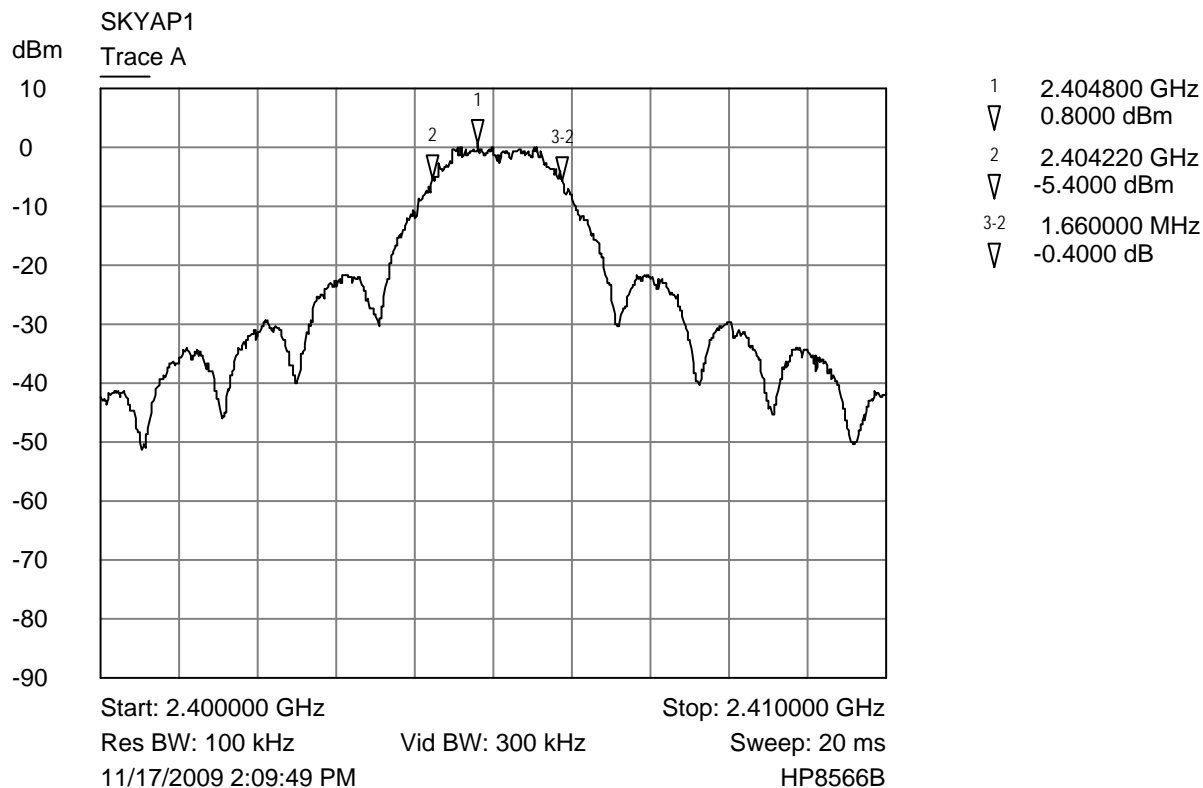

Trace A Lower channel band width

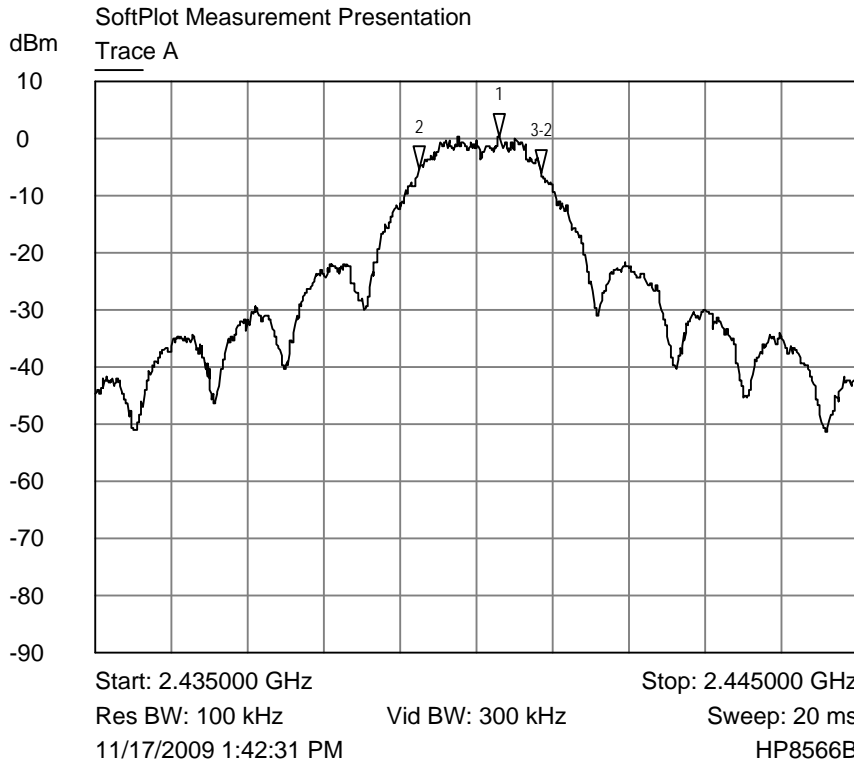

- 1 2.440300 GHz  
 ▽ 0.4000 dBm
- 2 2.439240 GHz  
 ▽ -5.4000 dBm
- 3-2 1.610000 MHz  
 ▽ -0.5000 dB

Trace A Middle channel bandwidth

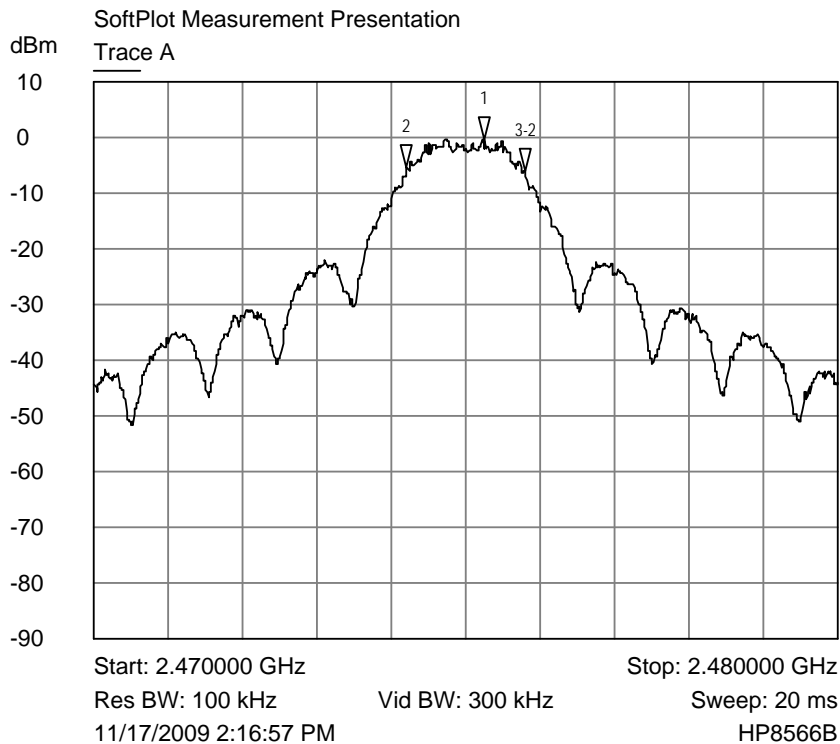

- 1 2.475260 GHz  
 ▽ -0.2000 dBm
- 2 2.474200 GHz  
 ▽ -5.4000 dBm
- 3-2 1.590000 MHz  
 ▽ -0.7000 dB

Trace A Upper channel band width

**6.2.4 §15.247(b)(3) Peak Output Power**

The maximum peak RF Conducted output power measured for this device was 5.3 dBm or 3.39 mW. The limit is 30 dBm or 1 Watt when using antennas with 6 dBi or less gain. The EUT uses an antenna with a maximum gain of 5 dBi.

Frequency (MHz)	Measured Output Power (dBm)	Measured Output Power (mW)
2405	5.3	3.39
2440	4.8	3.02
2475	4.1	2.57

**RESULT**

In the configuration tested, the RF peak output power was less than 1 Watt; therefore, the EUT complied with the requirements of the specification (see spectrum analyzer plots below).

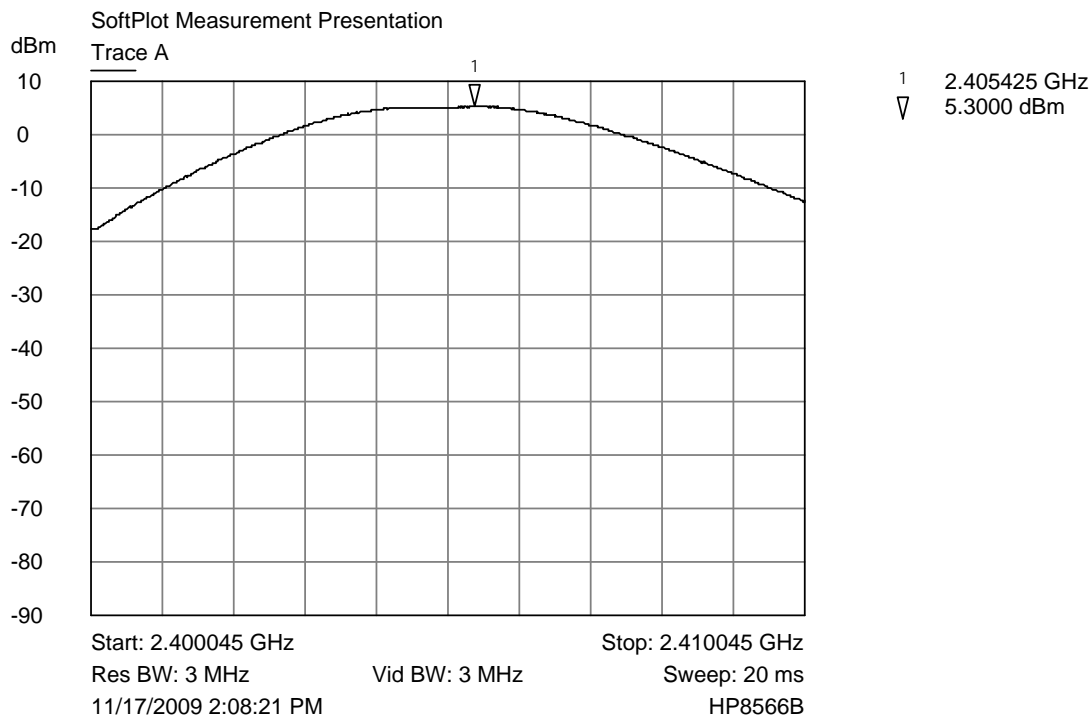

Trace A Lower channel output power

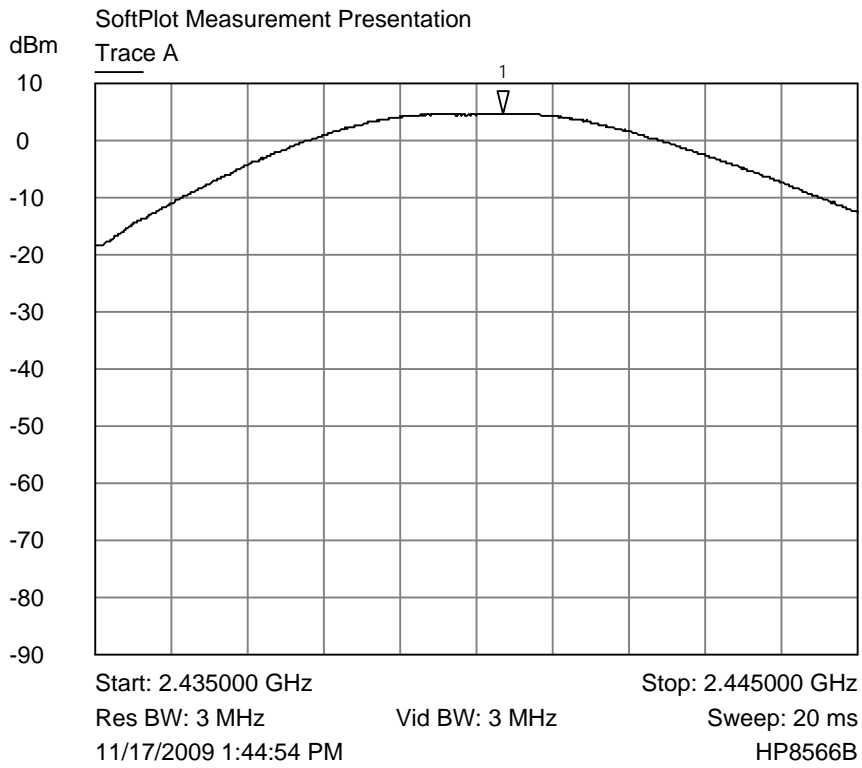

Trace A Middle channel output power

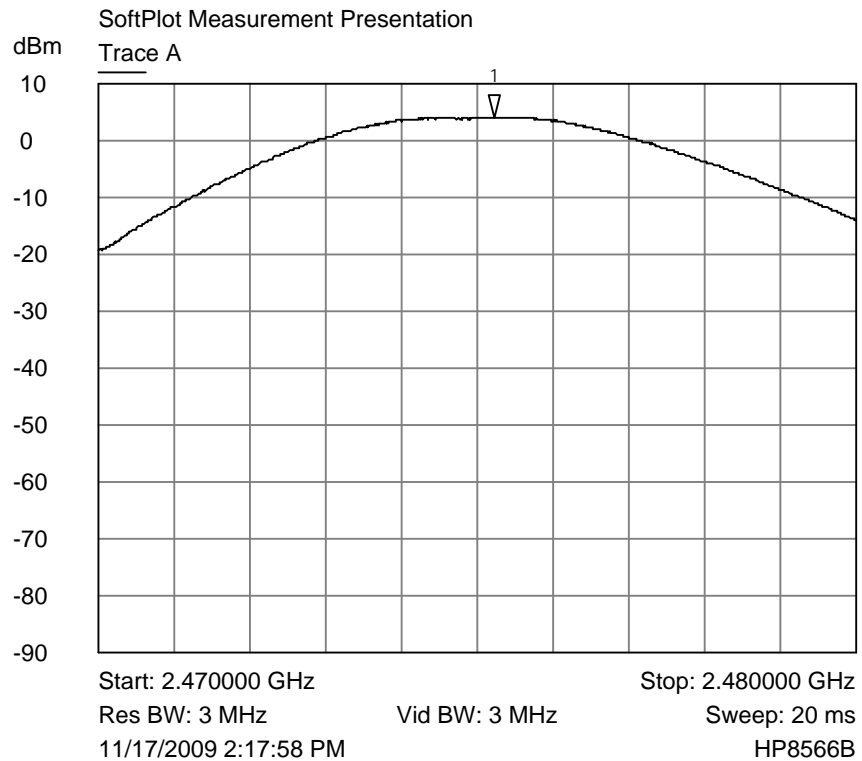

Trace A Upper channel output power

**6.2.5 §15.247(c) Spurious Emissions****6.2.5.1 Conducted Spurious Emissions**

The frequency range from 8 MHz to the tenth harmonic of the highest fundamental frequency was investigated to measure any antenna-conducted emissions. The tables show the measurement data from spurious emissions noted across the frequency range when transmitting at the lowest frequency, middle frequency, and upper frequency. Shown below are plots with the EUT tuned to the upper and lower channels. These demonstrate compliance with the provisions of this section at the band edges.

The emissions must be attenuated 20 dB below the highest power level measured within the authorized band as measured with a 100 kHz RBW. The highest level measured 0.8 dBm; therefore, the criteria is  $0.8 - 20.0 = -19.2$  dBm.

**RESULT**

Conducted spurious emissions were attenuated 20 dB or more from the fundamental; therefore, the EUT complies with the specification.

## Transmitting on the Lowest Channel (2405 MHz)

Frequency (MHz)	Corrected Level (dBm)	Criteria (dBm)
4810	-61.6	-19.2
7215	-53.1	-19.2
9620	-57.8	-19.2
12025	-70.3	-19.2
14430	-66.6	-19.2
16835	-65.5	-19.2
19240	-61.1	-19.2
21645	-59.7	-19.2
24050	-58.0	-19.2

## Transmitting on the Middle Channel (2440 MHz)

Frequency (MHz)	Corrected Level (dBm)	Criteria (dBm)
4880	-61.2	-19.2
7320	-50.7	-19.2
9760	-57.9	-19.2
12200	-70.8	-19.2

Frequency (MHz)	Corrected Level (dBm)	Criteria (dBm)
14640	-66.1	-19.2
17080	-66.3	-19.2
19520	-61.2	-19.2
21960	-58.8	-19.2
24400	-58.0	-19.2

Transmitting on the Highest Channel (2475 MHz)

Frequency (MHz)	Corrected Level (dBm)	Criteria (dBm)
4950	-63.0	-19.2
7425	-47.3	-19.2
9900	-61.7	-19.2
12375	-71.4	-19.2
14850	-66.3	-19.2
17325	-66.1	-19.2
19800	-61.2	-19.2
22275	-60.0	-19.2
24750	-58.0	-19.2

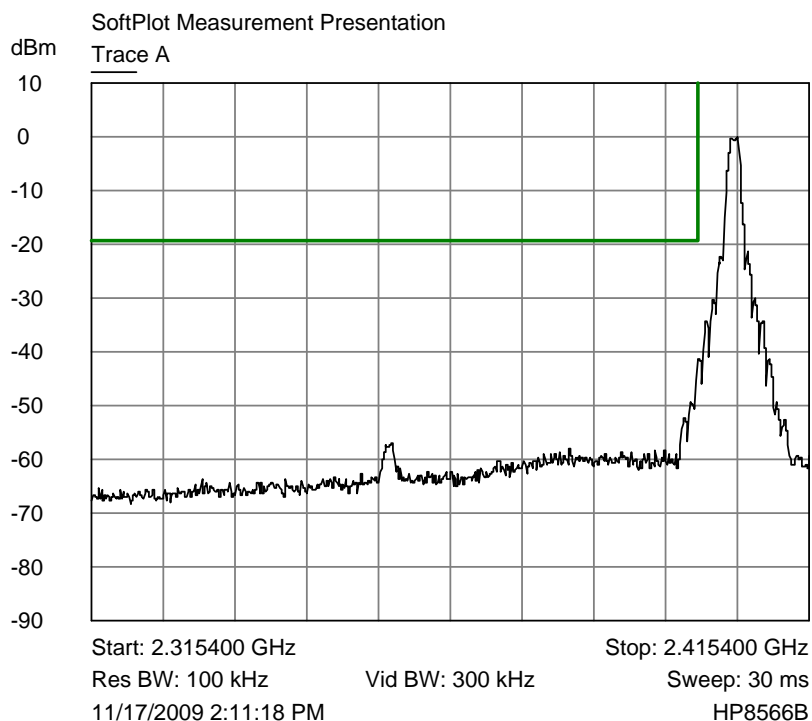

Trace A Lower channel band edge

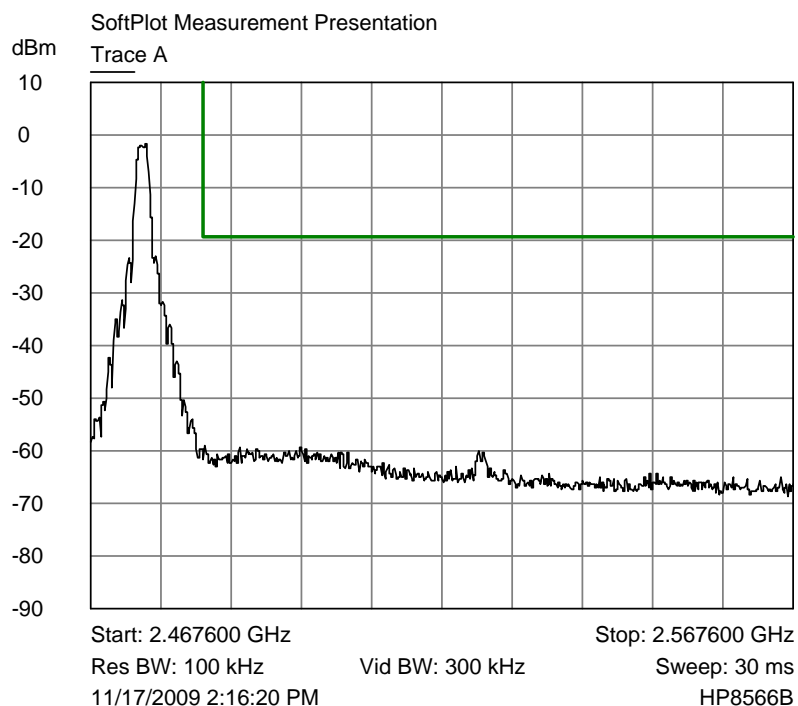

Trace A Upper channel band edge

### 6.2.5.2 Radiated Emissions in the Restricted Bands of §15.205

The frequency range from 30 MHz to 25 GHz was investigated to measure any radiated emissions in the restricted bands. The following tables show measurements of any emission that fell into the restricted bands of §15.205. The tables show the worst-case emission measured from the SKYAP1. For frequencies above 12.5 GHz, a measurement distance of 1 meter was used. The noise floor was a minimum of 6 dB below the limit. The emissions in the restricted bands must meet the limits specified in §15.209. Tabular data for each of the spurious emissions is shown below for each of the units. Plots of the band edges are also shown.

For frequencies below 1000 MHz RBW = 100 kHz and VBW = 300 kHz, For frequencies above 1000 MHz RBW = 1 Mhz and VBW = 3 MHz.

#### AVERAGE FACTOR

The EUT transmits continuously therefore; there is not an average factor for this device.

**RESULT**

All emissions in the restricted bands of §15.205 met the limits specified in §15.209; therefore, the EUT complies with the specification.

## Transmitting at the Lowest Frequency (2405 MHz)

Frequency (MHz)	Detection Mode	Antenna Polarity	Receiver Reading (dBμV)	Correction Factor (dB)	Field Strength (dBμV/m)	Limit (dBμV/m)	Margin (dB)
4810	Peak	Vertical	1.1	37.5	38.6	74.0	-35.4
4810	Average	Vertical	-11.6	37.5	25.9	54.0	-28.1
4810	Peak	Horizontal	14.6	37.5	52.1	74.0	-21.9
4810	Average	Horizontal	7.6	37.5	45.1	54.0	-8.9
7215	Peak	Vertical	12.1	41.4	53.5	74.0	-20.5
7215	Average	Vertical	4.3	41.4	45.7	54.0	-8.3
7215	Peak	Horizontal	13.9	41.4	55.3	74.0	-18.7
7215	Average	Horizontal	6.2	41.4	47.6	54.0	-6.4
12025	Peak	Vertical	1.6	46.0	47.6	74.0	-26.4
12025	Average	Vertical	-11.5	46.0	34.5	54.0	-19.5
12025	Peak	Horizontal	2.0	46.0	48.0	74.0	-26.0
12025	Average	Horizontal	-11.3	46.0	34.7	54.0	-19.3

## Transmitting at the Middle Frequency (2440 MHz)

Frequency (MHz)	Detection Mode	Antenna Polarity	Receiver Reading (dBμV)	Correction Factor (dB)	Field Strength (dBμV/m)	Limit (dBμV/m)	Margin (dB)
4880	Peak	Vertical	1.3	37.7	39.0	74.0	-35.0
4880	Average	Vertical	-10.9	37.7	26.8	54.0	-27.2
4880	Peak	Horizontal	13.0	37.7	50.7	74.0	-23.3
4880	Average	Horizontal	6.1	37.7	43.8	54.0	-10.2
7320	Peak	Vertical	15.7	41.7	57.4	74.0	-16.6
7320	Average	Vertical	8.3	41.7	50.0	54.0	-4.0
7320	Peak	Horizontal	14.2	41.7	55.9	74.0	-18.1
7320	Average	Horizontal	6.9	41.7	48.6	54.0	-5.4
12200	Peak	Vertical	1.9	46.2	48.1	74.0	-25.9
12200	Average	Vertical	-11.3	46.2	34.9	54.0	-19.1
12200	Peak	Horizontal	2.6	46.2	48.8	74.0	-25.2
12200	Average	Horizontal	-11.1	46.2	35.1	54.0	-18.9



Transmitting at the Highest Frequency (2462 MHz)

Frequency (MHz)	Detection Mode	Antenna Polarity	Receiver Reading (dBμV)	Correction Factor (dB)	Field Strength (dBμV/m)	Limit (dBμV/m)	Margin (dB)
4950	Peak	Vertical	1.1	37.8	38.9	74.0	-35.1
4950	Average	Vertical	-11.4	37.8	26.4	54.0	-27.6
4950	Peak	Horizontal	15.5	37.8	53.3	74.0	-20.7
4950	Average	Horizontal	8.7	37.8	46.5	54.0	-7.5
7425	Peak	Vertical	13.3	42.0	55.3	74.0	-18.7
7425	Average	Vertical	5.7	42.0	47.7	54.0	-6.3
7425	Peak	Horizontal	16.6	42.0	58.6	74.0	-15.4
7425	Average	Horizontal	9.3	42.0	51.3	54.0	-2.7
12375	Peak	Vertical	1.7	45.3	47.0	74.0	-27.0
12375	Average	Vertical	-10.5	45.3	34.8	54.0	-19.2
12375	Peak	Horizontal	1.5	45.3	46.8	74.0	-27.2
12375	Average	Horizontal	-11.6	45.3	33.7	54.0	-20.3

No other emissions were seen in the restricted bands. Noise floor was greater than 6 dB below the limit. At frequencies above 12.5 GHz, a 1 meter measurement distance was used.

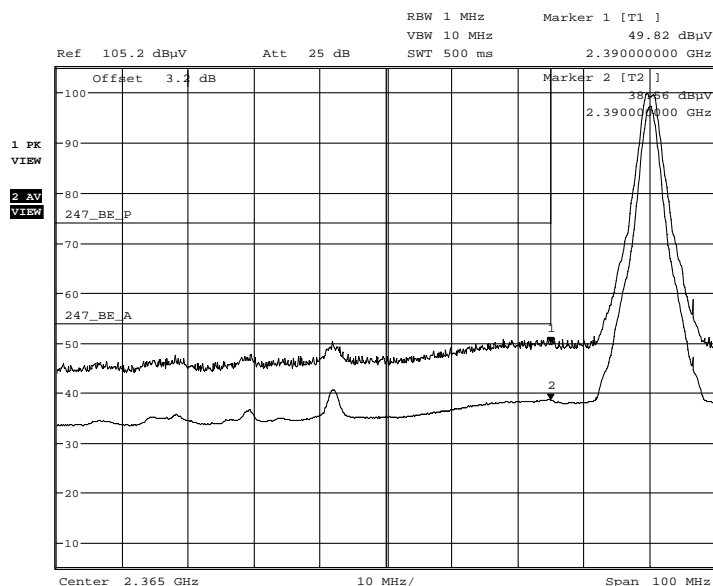

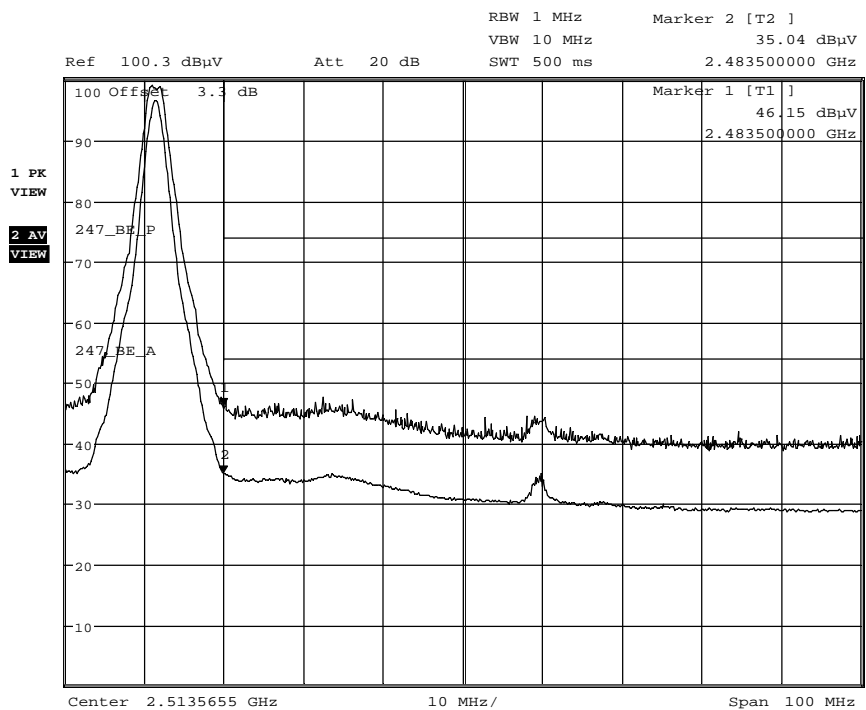

Date: 17.NOV.2009 09:09:54

**6.2.6 §15.247(d) Peak Power Spectral Density**

The peak power spectral density conducted from the intentional radiator to the antenna shall not be greater than 8 dBm in any 3 kHz band during any time interval of continuous transmission. The plots are shown below and the results of this testing are summarized in the table below.

Frequency (MHz)	Measurement (dBm)	Criteria (dBm)
2405	-9.8	8.0
2440	-10.4	8.0
2475	-10.9	8.0

The spectrum analyzer RBW was set to 3 kHz and the VBW set greater than the RBW. The span was set to 1.5 MHz and the sweep was set to 500 seconds (Sweep = (Span/3 kHz)).

**RESULT**

The maximum peak power spectral density was -9.8 dBm. The limit is 8 dBm. The EUT complies with the specification by 17.8 dB.

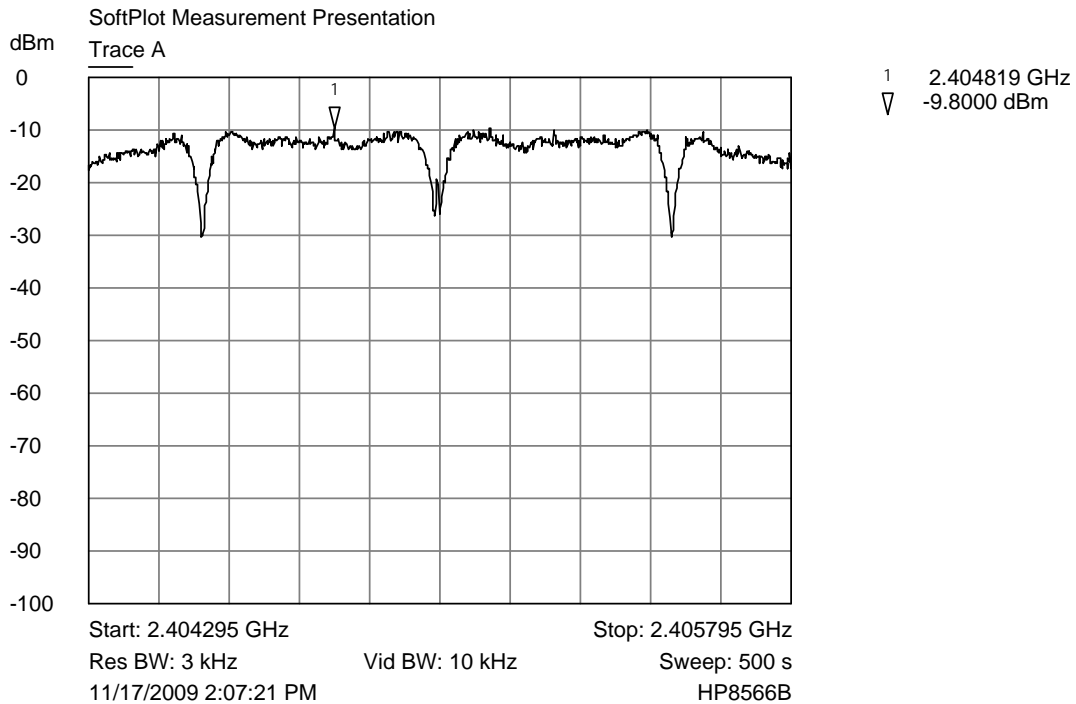

Trace A Lower channel 3kHz power spectral density

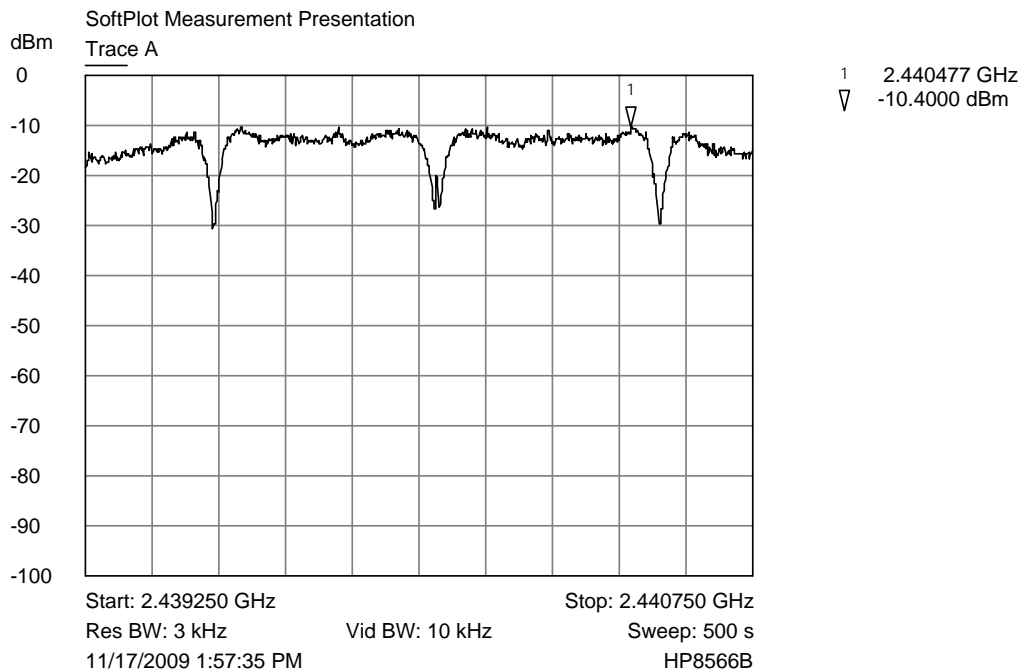

Trace A Middle channel 3kHz power spectral density

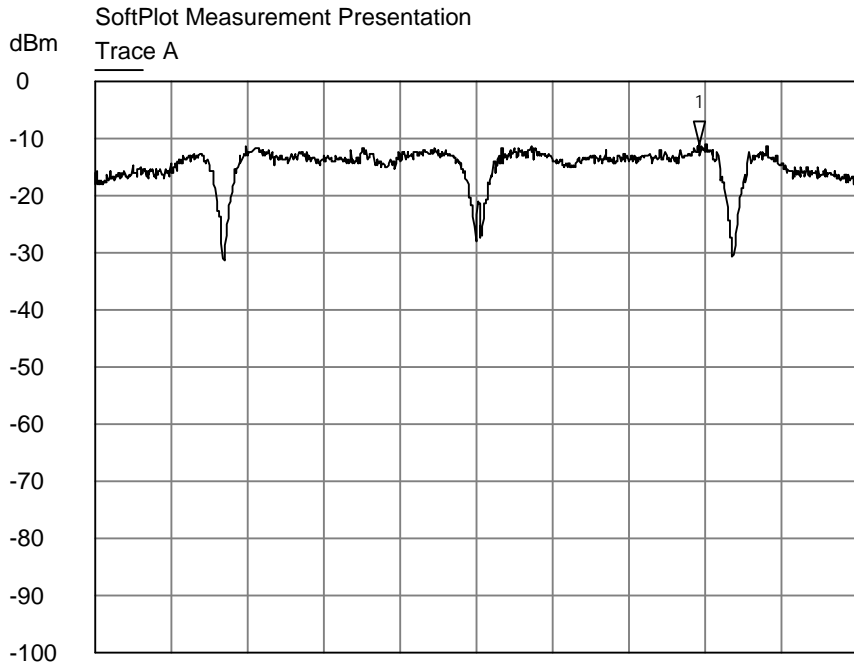

1 2.475474 GHz  
▽ -10.9000 dBm

Start: 2.474286 GHz Stop: 2.475786 GHz  
Res BW: 3 kHz Vid BW: 10 kHz Sweep: 500 s  
11/17/2009 2:29:36 PM HP8566B

Trace A Upper channel 3 kHz power spectral density

**APPENDIX 1 TEST PROCEDURES AND TEST EQUIPMENT****§15.207 Conducted Disturbance at the AC Mains**

The conducted disturbance at mains ports from the EUT was measured using a spectrum analyzer with a quasi-peak adapter for peak, quasi-peak and average readings. The quasi-peak adapter uses a bandwidth of 9 kHz, with the spectrum analyzer's resolution bandwidth set at 100 kHz, for readings in the 150 kHz to 30 MHz frequency ranges.

The conducted disturbance at mains ports measurements are performed in a screen room using a (50  $\Omega$ /50  $\mu$ H) Line Impedance Stabilization Network (LISN).

Where mains flexible power cords are longer than 1 m, the excess cable is folded back and forth as far as possible so as to form a bundle not exceeding 0.4 m in length.

Where the EUT is a collection of equipment with each device having its own power cord, the point of connection for the LISN is determined from the following rules:

- a) Each power cord, which is terminated in a mains supply plug, shall be tested separately.
- b) Power cords, which are not specified by the manufacturer to be connected via a host unit, shall be tested separately.
- c) Power cords which are specified by the manufacturer to be connected via a host unit or other power supplying equipment shall be connected to that host unit and the power cords of that host unit connected to the LISN and tested.
- d) Where a special connection is specified, the necessary hardware to effect the connection is supplied by the manufacturer for the testing purpose.
- e) When testing equipment with multiple mains cords, those cords not under test are connected to an artificial mains network (AMN) different than the AMN used for the mains cord under test.

For AC mains port testing the desktop EUT are placed on a non-conducting table at least 0.8 meters from the metallic floor. The equipment is placed a minimum of 40 cm from all walls. Floor standing equipment is placed directly on the earth grounded floor.

Type of Equipment	Manufacturer	Model Number	Serial Number	Date of Last Calibration
Wanship Open Area Test Site #2	CCL	N/A	N/A	10/08/2009
Test Software	CCL	Conducted Emissions	Revision 1.2	N/A
Spectrum Analyzer	Hewlett Packard	8566B	2232A02726	01/15/2009
Quasi-Peak Detector	Hewlett Packard	85650A	2043A00287	03/18/2009
LISN	EMCO	3825/2	9305-2099	03/09/2009
Conductance Cable Wanship Site #2	CCL	Cable J	N/A	12/31/2008
Transient Limiter	Hewlett Packard	11947A	3107A02266	12/31/2008

An independent calibration laboratory or CCL personnel calibrates all the equipment listed above at intervals defined in ANSI C63.4:2003 Section 4.4 following outlined calibration procedures. All measurement instrumentation is traceable to the National Institute of Standards and Technology (NIST). Supporting documentation relative to tractability is on file and is available for examination upon request.

Conducted Emissions Test Setup

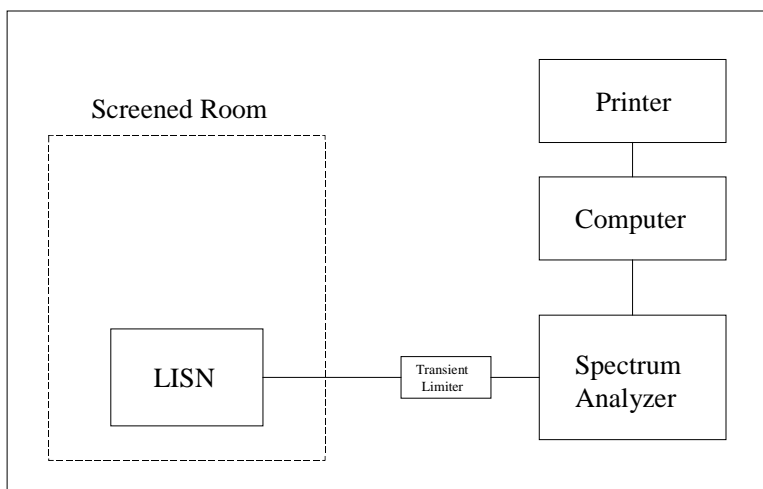

**§15.247(a)(2) Emission Bandwidth**

The EUT was directly connected to the spectrum analyzer via the antenna output port as shown in the block diagram below.

The measurements were performed on three channels, as per 47 CFR 15.31(m), one near the bottom of the spectrum, one near the middle of the spectrum and one near the top of the spectrum.

The spectrum analyzer's resolution bandwidth and video bandwidth were set as follows:

RBW = 100 kHz  
VBW = 300 kHz

Type of Equipment	Manufacturer	Model Number	Serial Number
Spectrum Analyzer	Hewlett Packard	8566B	2232A02726
Quasi-Peak Detector	Hewlett Packard	85650A	2043A00287
Spectrum Analyzer/Receiver	Rohde & Schwarz	1302.6005.40	100064
Low Loss Cable (1 dB)	N/A	N/A	N/A

An independent calibration laboratory or CCL personnel calibrates all the equipment listed above at intervals defined in ANSI C63.4:2003 Section 4.4 following outlined calibration procedures. All measurement instrumentation is traceable to the National Institute of Standards and Technology (NIST). Supporting documentation relative to tractability is on file and is available for examination upon request.

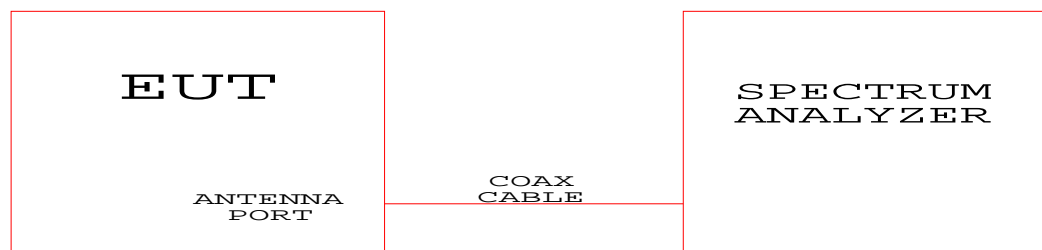
**Test Configuration Block Diagram**

**§15.247(b)(3) Peak Output Power**

The EUT was directly connected to the spectrum analyzer via the antenna output port as shown in the block diagram below.

The measurements were performed on three channels, as per 47 CFR 15.31(m), one near the bottom of the spectrum, one near the middle of the spectrum and one near the top of the spectrum.

The spectrum analyzer's resolution bandwidth and video bandwidth were set as follows:

RBW = 3 MHz

VBW = 3 MHz

Type of Equipment	Manufacturer	Model Number	Serial Number
Spectrum Analyzer	Hewlett Packard	8566B	2232A02726
Quasi-Peak Detector	Hewlett Packard	85650A	2043A00287
Spectrum Analyzer/Receiver	Rohde & Schwarz	1302.6005.40	100064
Low Loss Cable (1 dB)	N/A	N/A	N/A

An independent calibration laboratory or CCL personnel calibrates all the equipment listed above at intervals defined in ANSI C63.4:2003 Section 4.4 following outlined calibration procedures. All measurement instrumentation is traceable to the National Institute of Standards and Technology (NIST). Supporting documentation relative to tractability is on file and is available for examination upon request.

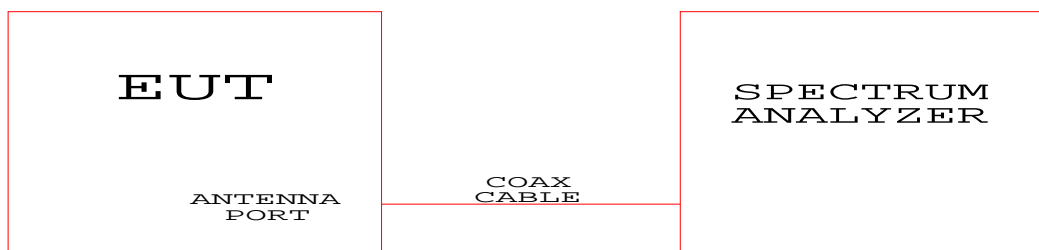
**Test Configuration Block Diagram**



**§15.247(c) Conducted Spurious Emissions**

The EUT was directly connected to the spectrum analyzer via the antenna output port as shown in the block diagram below.

The measurements were performed on three channels, as per 47 CFR 15.31(m), one near the bottom of the spectrum, one near the middle of the spectrum and one near the top of the spectrum.

The spectrum analyzer's resolution bandwidth and video bandwidth were set as follows:

RBW = 100 kHz  
VBW = 300 kHz

Type of Equipment	Manufacturer	Model Number	Serial Number
Spectrum Analyzer	Hewlett Packard	8566B	2232A02726
Quasi-Peak Detector	Hewlett Packard	85650A	2043A00287
Spectrum Analyzer/Receiver	Rohde & Schwarz	1302.6005.40	100064
Low Loss Cable (1 dB)	N/A	N/A	N/A

An independent calibration laboratory or CCL personnel calibrates all the equipment listed above at intervals defined in ANSI C63.4:2003 Section 4.4 following outlined calibration procedures. All measurement instrumentation is traceable to the National Institute of Standards and Technology (NIST). Supporting documentation relative to tractability is on file and is available for examination upon request.

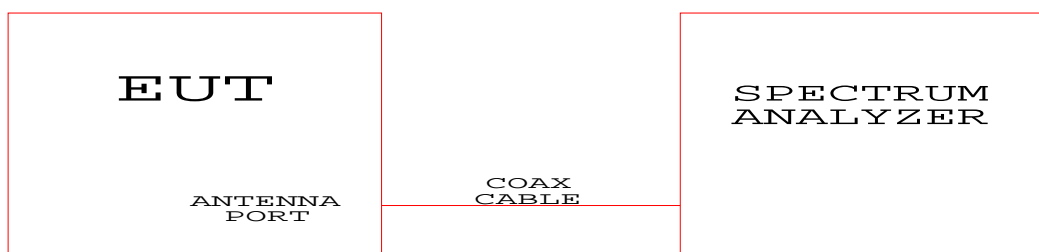
**Test Configuration Block Diagram**

**§15.247(c) Radiated Spurious Emissions in the Restricted Bands**

The radiated emissions from the intentional radiator were measured using a spectrum analyzer with a quasi-peak adapter for peak and quasi-peak readings. An amplifier and preamplifier were used to increase the sensitivity of the measuring instrumentation. The quasi-peak adapter uses a bandwidth of 120 kHz, with the spectrum analyzer's resolution bandwidth set at 1 MHz, for readings in the 30 to 1000 MHz frequency ranges. For peak emissions above 1000 MHz the spectrum analyzer's resolution bandwidth was set to 1 MHz and the video bandwidth was set to 3 MHz. For average emissions above 1000 MHz the spectrum analyzer's resolution bandwidth was set to 1 MHz and the video bandwidth was set to 10 Hz.

A biconilog antenna was used to measure the frequency range of 30 to 1000 MHz and a Double Ridge Guide Horn antenna was used to measure the frequency range of 1 GHz to 18 GHz, and a Pyramidal Horn antenna was used to measure the frequency range of 18 GHz to 25 GHz, at a distance of 3 meters from the EUT. The readings obtained by these antennas are correlated to the levels obtained with a tuned dipole antenna by adding antenna factors.

The configuration of the intentional radiator was varied to find the maximum radiated emission. The intentional radiator was connected to the peripherals listed in Section 2.4 via the interconnecting cables listed in Section 2.5. These interconnecting cables were manipulated manually by a technician to obtain worst case radiated emissions. The intentional radiator was rotated 360 degrees, and the antenna height was varied from 1 to 4 meters to find the maximum radiated emission. Where there are multiple interface ports all of the same type, cables are either placed on all of the ports or cables added to these ports until the emissions do not increase by more than 2 dB.

Desktop intentional radiators are measured on a non-conducting table 80 centimeters above the ground plane. The table is placed on a turntable which is level with the ground plane. The turntable has slip rings, which supply AC power to the intentional radiator. For equipment normally placed on floors, the equipment shall be placed directly on the turntable.

Type of Equipment	Manufacturer	Model Number	Serial Number	Date of Last Calibration
Wanship Open Area Test Site #2	CCL	N/A	N/A	10/08/2009
Test Software	CCL	Radiated Emissions	Revision 1.3	N/A

Type of Equipment	Manufacturer	Model Number	Serial Number	Date of Last Calibration
Spectrum Analyzer/Receiver	Rohde & Schwarz	1302.6005.40	100064	07/08/2009
Spectrum Analyzer	Hewlett Packard	8566B	2232A02726	01/15/2009
Quasi-Peak Detector	Hewlett Packard	85650A	2043A00287	03/18/2009
Biconilog Antenna	EMCO	3142	9601-1008	9/26/2008
Double Ridged Guide Antenna	EMCO	3115	9409-4355	03/11/2009
High Frequency Amplifier	Miteq	AFS4-01001800-43-10P-4	1096455	06/04/2009
20' High Frequency Cable	Utiflex	UFA210A-1-2400-30050U	1175	03/05/2009
3 Meter Radiated Emissions Cable Wanship Site #2	CCL	Cable K	N/A	12/31/2008
Pre/Power-Amplifier	Hewlett Packard	8447F	3113A05161	08/24/2009
6 dB Attenuator	Hewlett Packard	8491A	32835	12/31/2008

An independent calibration laboratory or CCL personnel calibrates all the equipment listed above at intervals defined in ANSI C63.4:2003 Section 4.4 following outlined calibration procedures. All measurement instrumentation is traceable to the National Institute of Standards and Technology (NIST). Supporting documentation relative to tractability is on file and is available for examination upon request.

Radiated Emissions Test Setup

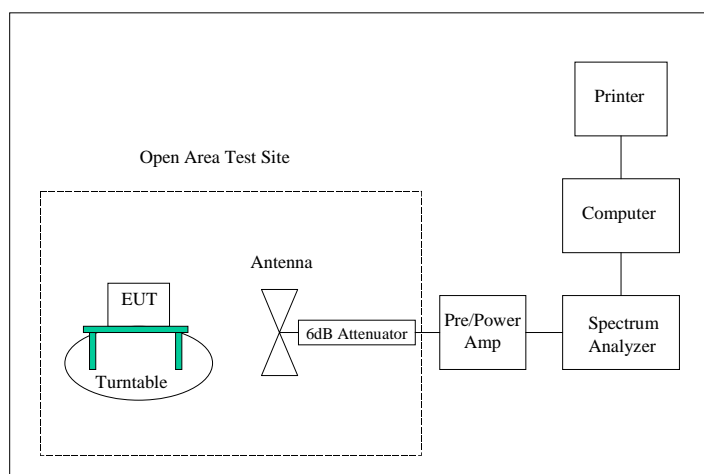

**§15.247(d) Peak Power Spectral Density**

The EUT was directly connected to the spectrum analyzer via the antenna output port as shown in the block diagram below.

The measurements were performed on three channels, as per 47 CFR 15.31(m), one near the bottom of the spectrum, one near the middle of the spectrum and one near the top of the spectrum.

The spectrum analyzer's resolution bandwidth and video bandwidth were set as follows:

RBW = 3 kHz  
VBW = 10 kHz

Type of Equipment	Manufacturer	Model Number	Serial Number
Spectrum Analyzer	Hewlett Packard	8566B	2232A02726
Quasi-Peak Detector	Hewlett Packard	85650A	2043A00287
Spectrum Analyzer/Receiver	Rohde & Schwarz	1302.6005.40	100064
Low Loss Cable (1 dB)	N/A	N/A	N/A

An independent calibration laboratory or CCL personnel calibrates all the equipment listed above at intervals defined in ANSI C63.4:2003 Section 4.4 following outlined calibration procedures. All measurement instrumentation is traceable to the National Institute of Standards and Technology (NIST). Supporting documentation relative to tractability is on file and is available for examination upon request.

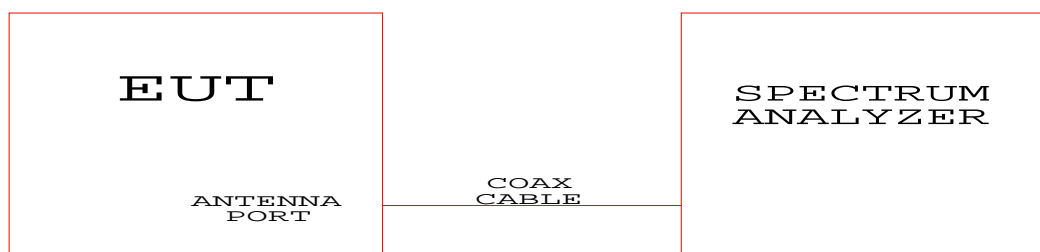
**Test Configuration Block Diagram**

**APPENDIX 2 PHOTOGRAPHS**

Photograph 1 - View Radiated Emissions in the Restricted Bands -  
Vertical Orientation

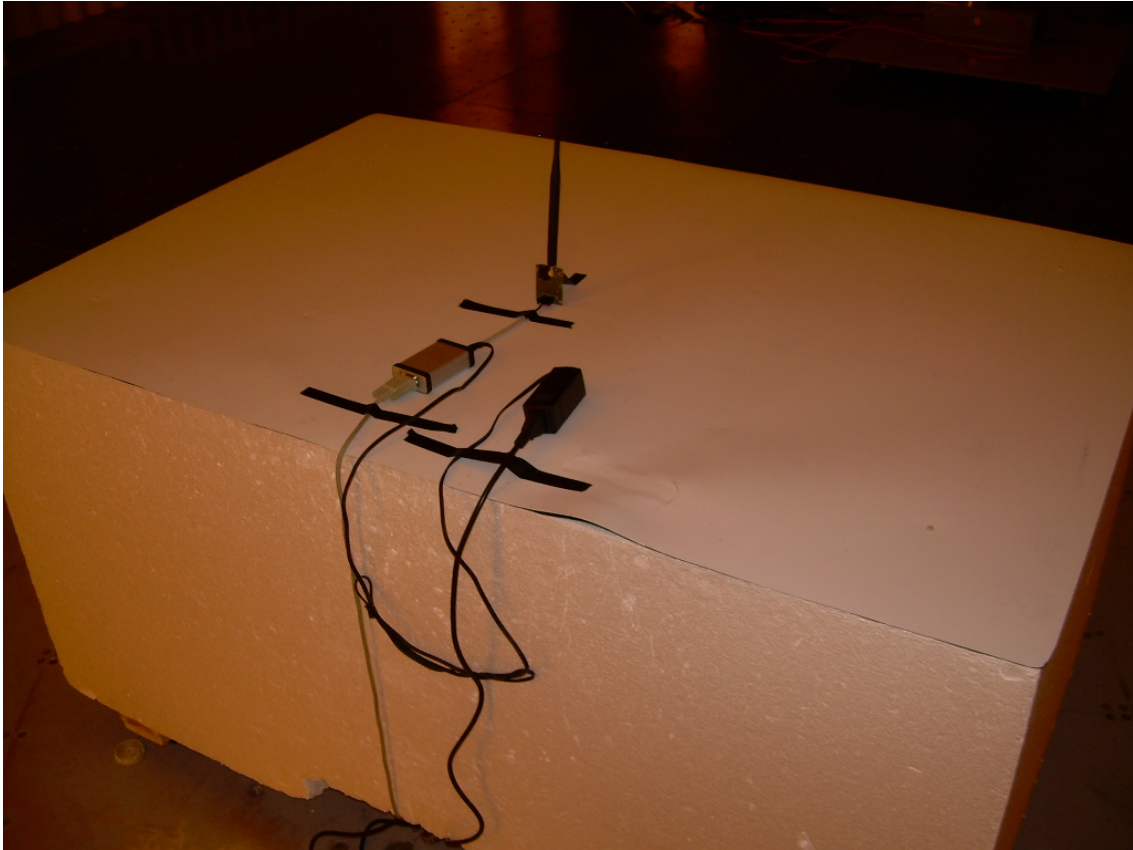

Photograph 2 - View Radiated Emissions in the Restricted Bands -  
On-Edge Orientation

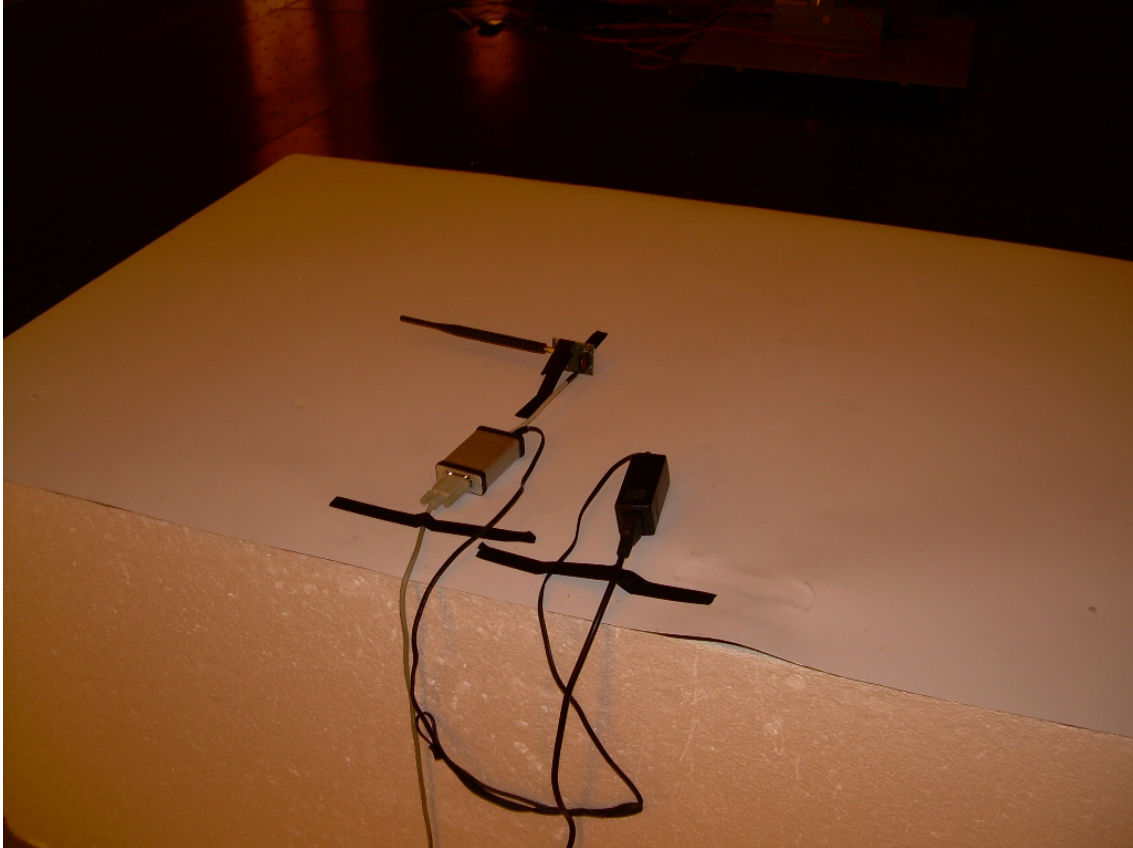

Photograph 3 - View Radiated Emissions in the Restricted Bands -  
Horizontal Orientation

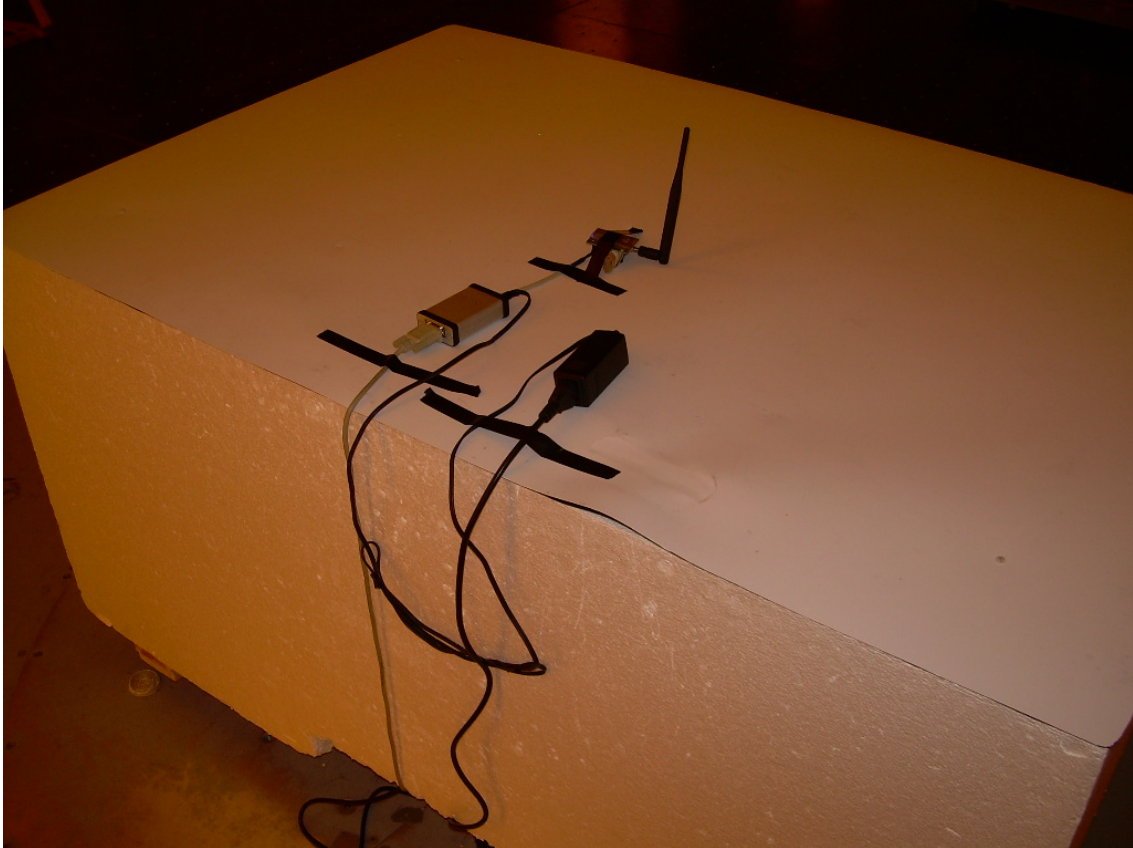

Photograph 4 - Front View Conducted Disturbance Worst Case Configuration





Photograph 5 - Back View Conducted Disturbance Worst Case Configuration

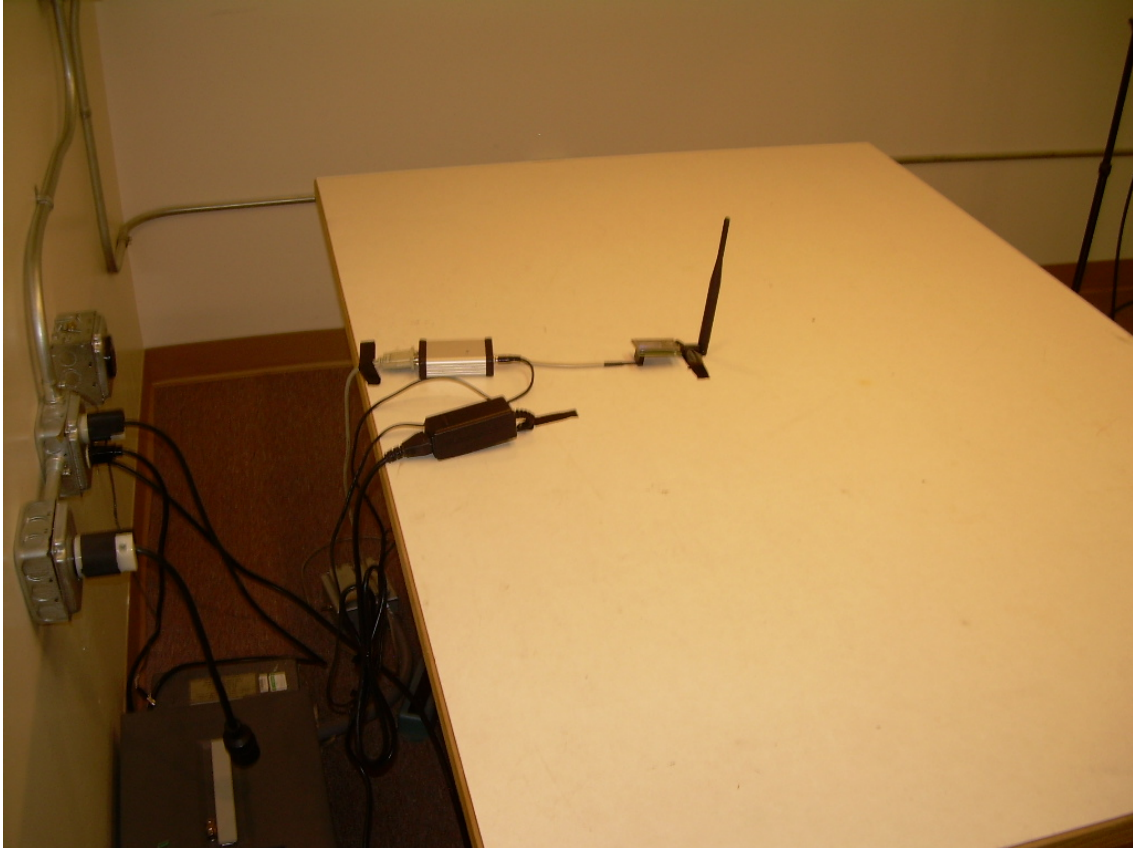

Photograph 6 - Front View of the EUT



Photograph 7 - Front View of the EUT with RF Shielding Removed

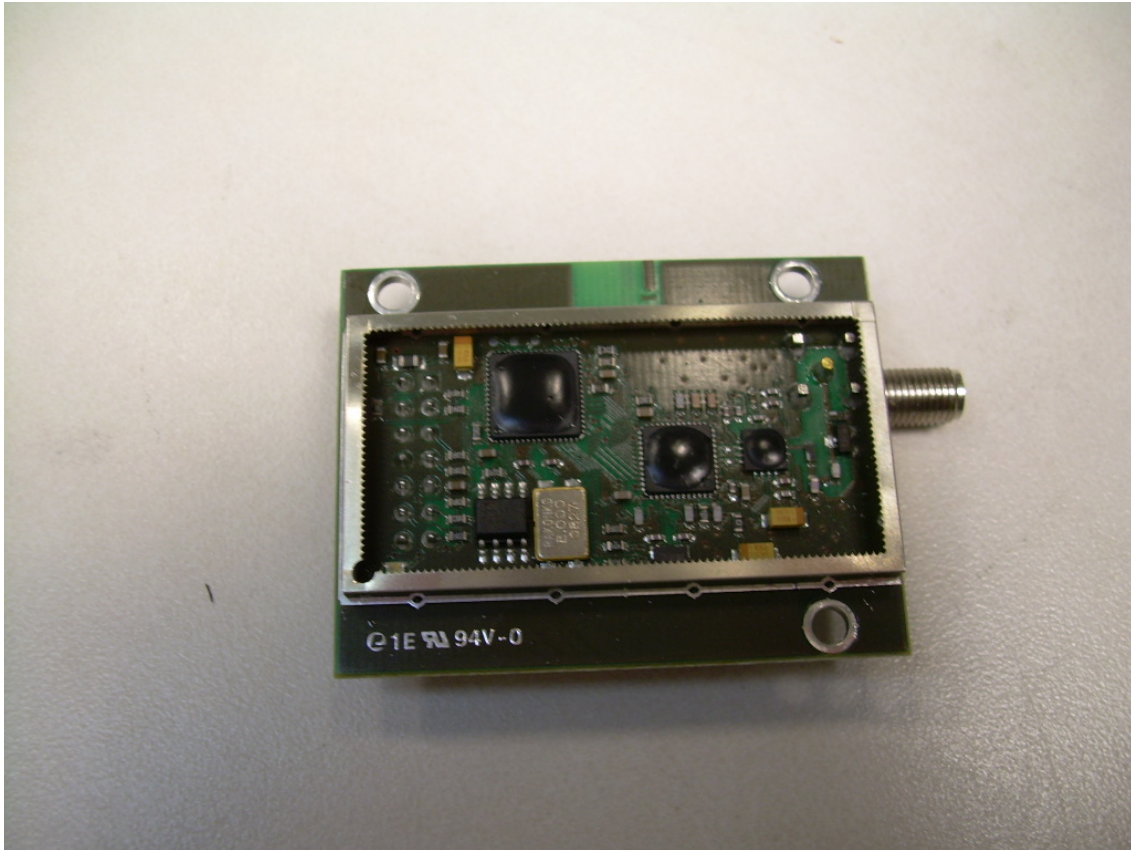

Photograph 8 - Back View of the EUT

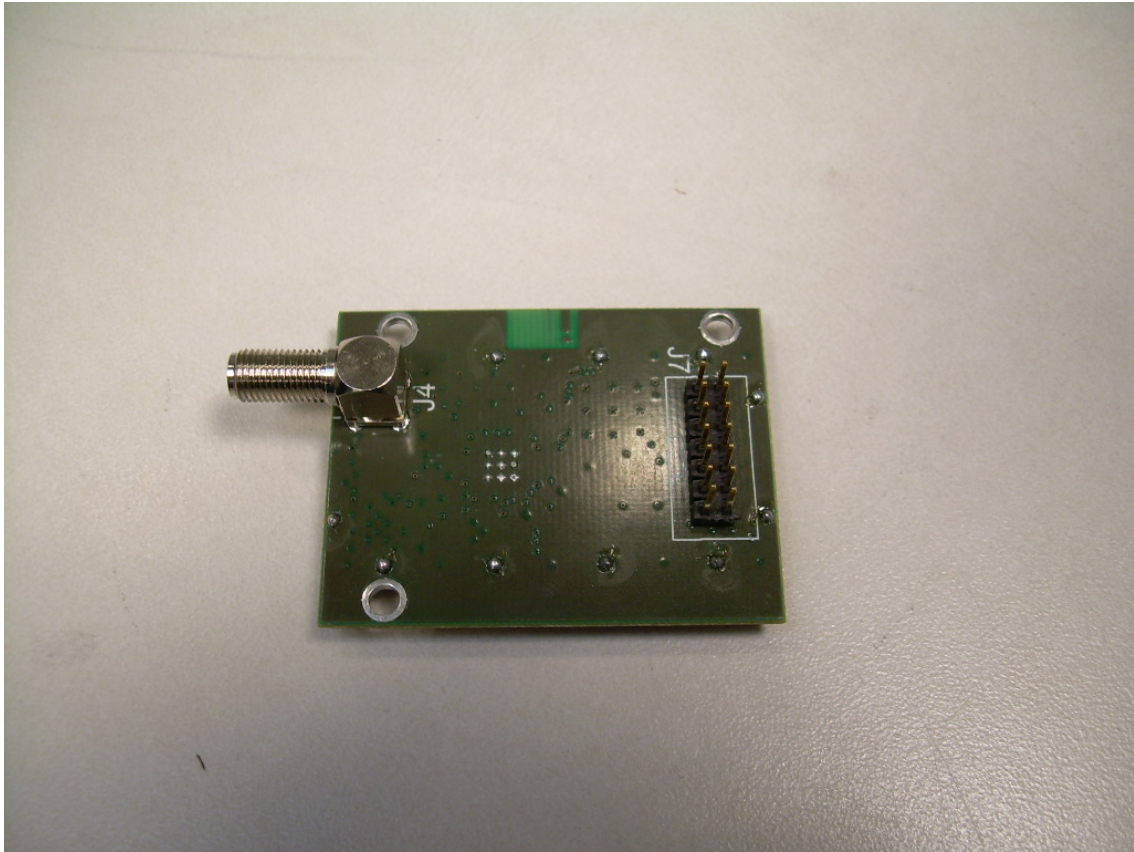

Photograph 9 - View of Module and Antenna

