

V1.00.001

2011-04-07

## Trademark Information

LAUNCH is a registered trademark of LAUNCH TECH. CO., LTD. (also called LAUNCH for short) in China and other countries. All other LAUNCH trademarks, service marks, domain names, logos, and company names referred to in this manual are either trademarks, registered trademarks, service marks, domain names, logos, company names of or are otherwise the property of LAUNCH or its affiliates. In countries where any of the LAUNCH trademarks, service marks, domain names, logos and company names are not registered, LAUNCH claims other rights associated with unregistered trademarks, service marks, domain names, logos, and company names. Other products or company names referred to in this manual may be trademarks of their respective owners. You may not use any trademark, service mark, domain name, logo, or company name of LAUNCH or any third party without permission from the owner of the applicable trademark, service mark, domain name, logo, or company name. You may contact LAUNCH by visiting Launch at <http://www.cnlaunch.com>, or writing to LAUNCH TECH. CO., LTD., Launch Industrial Park, North of Wuhe Avenue, Banxuegang, Bantian, Longgang, Shenzhen, Guangdong, P.R.China, to request written permission to use Materials on this manual for purposes or for all other questions relating to this manual.

## Copyright Information

Copyright © 2011 by LAUNCH TECH. CO., LTD. All rights reserved. No part of this publication may be reproduced, stored in a retrieval system, or transmitted in any form or by any means, electronic, mechanical, photocopying, recording or otherwise, without the prior written permission of LAUNCH. The information contained herein is designed only for the use of this unit. LAUNCH is not responsible for any use of this information as applied to other units.

Neither LAUNCH nor its affiliates shall be liable to the purchaser of this unit or third parties for damages, losses, costs, or expenses incurred by purchaser or third parties as a result of: accident, misuse, or abuse of this unit, or unauthorized modifications, repairs, or alterations to this unit, or failure to strictly comply with LAUNCH operating and maintenance instructions.

LAUNCH shall not be liable for any damages or problems arising from the use of any options or any consumable products other than those designated as Original LAUNCH Products or LAUNCH Approved Products by LAUNCH.

## General Notice

- Other product names used herein are for identification purposes only and may be trademarks of their respective owners. LAUNCH disclaims any and all rights in those marks.
- There is a possibility that this unit is inapplicable to some of the vehicle models or systems listed in the diagnosis section due to different countries, areas, and/or years. Do not hesitate to contact LAUNCH if you come across such questions. We are to help you solve the problem as soon as possible.

## Disclaimer

- To take full advantage of the unit, you should be familiar with the engine.
- All information, illustrations, and specifications contained in this manual are based on the latest information available at the time of publication. The right is reserved to make change at any time without notice.

## Table of Contents

Introduction .....	2	System information .....	36
Features .....	2	User Information .....	36
Outline of X-431TOOL .....	3	About .....	36
Structure and explanations .....	4	Tool .....	36
Ports and Indicators .....	5	PIM .....	39
Hardware Configuration .....	5	Memo .....	39
Printer Operation .....	7	Address .....	41
Mounting Paper .....	7	Delete Address .....	42
Specifications .....	8	To Do .....	42
First Use of X-431TOOL .....	9	Schedule .....	44
Start-up .....	9	System .....	47
Taskbar .....	9	Control Panel .....	47
Input .....	10	System Information .....	50
Control of App .....	11	Shut Down .....	51
Help .....	11	FAQ .....	52
Vehicle Diagnosis .....	12	About Update via Internet .....	52
Conditions for Test .....	12	About Hardware .....	53
Select Diagnostic Connector .....	12	About System Setting .....	54
Diagnostic Socket Location .....	12	About Operation .....	55
Connection .....	12	Questions Related to Vehicle .....	56
Operation .....	13	About ECU .....	57
Entering Function Menu .....	13	Composition and Working Principle of Computer-	
Control module .....	14	Control System .....	57
Resetting Maintain/oil Indicator .....	24	Sensor .....	57
Setting Service Code .....	25	ECU .....	58
OBD II Diagnostic function .....	25	Actuator .....	58
Freeze Frame Data .....	25	Self-diagnosis of Electronic Control System .....	59
Readiness Test .....	26	Working Principle of Self-diagnosis .....	59
Diagnostic Socket Description .....	26	Readout of Fault Code in Automotive	
Update of diagnostic software .....	27	Self-diagnosis System .....	59
User Registration .....	27	Basic Knowledge of ECU .....	60
Software Update .....	28	Composition of Vehicle ECU .....	60
Flow Chart of X-431TOOL Update for New User		Precautions Related to ECU .....	60
.....	33	Appendix: X-431 TOOL Connectors and Sockets	
PDA function .....	34	Location .....	62

## Safety Precautions

### Precautions on Operation

- Do not collide when operation.
- For screen, flicker occurs at just the moment of the engine ignition.
- Be careful when connect the main cable and the diagnostic socket. Tighten the screw and avoid disconnecting or destroying the interface.
- Handle with care. Avoid collision. Unplug the power after operation.
- When it is necessary to remove the leather cover, pull out the CF card first and push in the ejector button to avoid scratching the leather cover.
- Put the cables, connectors and other accessories into box.
- Hold the connector when plug or unplug it. Do not pull the cable for unplugging.
- The matched lithium battery is special for X-431TOOL. Do not use other battery, otherwise it may cause explosion.

### Safety Precautions

- Automotive batteries contain sulfuric acid which is harmful to skin. When operation, direct contact with the automotive batteries should be avoided. Pay attention not to splash the sulfuric acid into eyes. Keep ignition sources away from the battery at all times.
- Engines produce various poisonous compound (hydrocarbon, carbon monoxide, azote oxid, etc,) which should be avoided.
- Avoid contacting high temperature assembly such as water tank and vent-pipe as the temperature of the running engine is very high.
- Before starting engine, put the speed lever in the neutral position or in the P position to avoid injury.
- Wear an ANSI approved eye shield when testing or repairing vehicles.
- If you are using the battery as a power source, connect the RED (+) battery clip to the positive vehicle battery terminal and the

BLACK (-) battery clip to the negative.

### Precautions on Operating Vehicle ECU

- Do not disconnect the vehicle inner battery when connect the ignition switch. When disconnection, transient voltage is very high, which causes the damage to the sensor and ECU.
- Do not put the wireless reproducer near to the computer.
- Do cut off the power supply of the ECU system before jointing on the vehicle.
- Pay more attention to the ECU and sensor when operation is next to the ECU and sensor.
- Do not use the pointer ohm meter instead of digital instrument for testing ECU and sensor without special explanation.
- Do not test the electric device about the ECU with the test lamp without instrument.
- People who get in and out the vehicle must wear the earthing metal strip with one end on the wrist and other on the vehicle body.
- Pay attention to connect the ECU terminal.

## Introduction

X-431TOOL is a new generation of automobile diagnostic computer. It features wireless communication and color screen. It is based on the technology of open diagnostic platform, the most advanced automobile diagnostic technology brought forward by LAUNCH. The open diagnostic platform represents the highest level of automobile diagnostic technology, and is the developing trend of this field in the future.

## Features

- X-431TOOL can diagnose almost all vehicle models in the world. The function of software update via Internet makes it easy for customer to get the latest diagnostic programs and keep pace with the development of automotive technology.
- Using an open-platform based on LINUX system and with the help of a DIAGBOX platform and various onboard diagnostic sockets, the scan tool can perform functions like reading DTCs, erasing DTCs, reading data stream tests on engines, automatic transmission, ABS, airbags and cruise control. Other functions include actuation test, communication with computer, etc.
- Built-in printer with real-time printout of test data.
- The main unit communicates with the DIAGBOX by means of Bluetooth technology. This provides great convenience in operation.
- X-431TOOL is the most advanced automobile diagnostic unit in the world at present. It is compactly designed and with large LCD multicolor touch screen.
- The product is a perfect combination of the automobile industry and the communication technology.
- The product has perfect appearance, large multicolor touch screen. Its PDA function supports Multi-language operation, which provides convenience for people of all countries.
- X-431TOOL can continuously work at least 4 hours with the lithium battery.
- Equipped with Smart OBD II -16E diagnostic connector.

## Outline of X-431TOOL

X-431TOOL consists of five parts: cabinet, X-431TOOL main unit, adaptor box, DIAGBOX and reference box.

Fig. 2-1 shows the cabinet where there are X-431TOOL main unit, adaptor box, DIAGBOX and reference box.

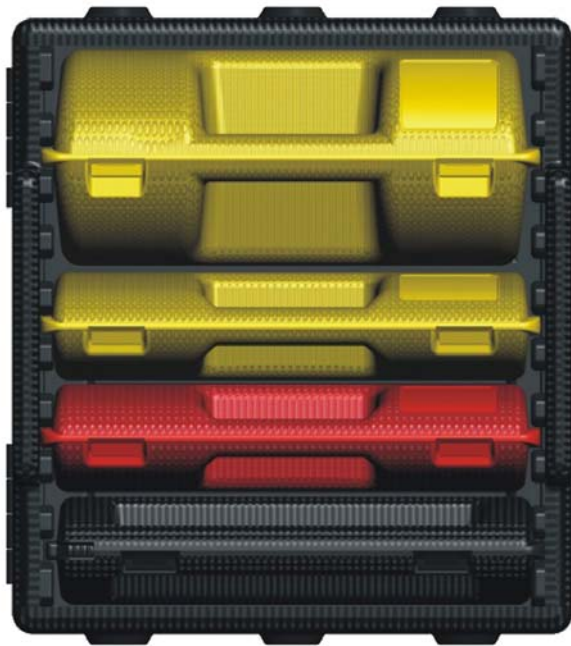

Fig 2-1 outline of X-431TOOL cabinet

## Structure and explanations

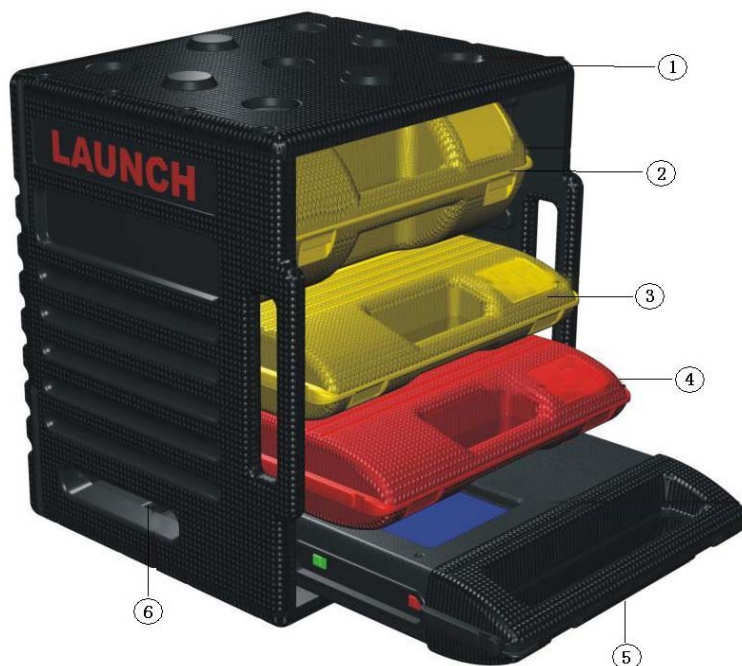

Fig.2-2 X-431TOOL structure

NO.	Name	Note
①	Cabinet	
②	Adaptor box	Used to place adaptors. (Big yellow box)
③	Reference box	Used to place CF card, reader/writer, printing paper, USB cable, password envelope, user's manual and disks. (Small yellow box)
④	DIAGBOX	Used to place X-431TOOL DIAGBOX, general adaptors, diagnostic cable and power cable of main unit. (Red box)
⑤	X-431TOOLmain unit	Consists of main unit and main unit housing.
⑥	Socket for recharge	Recharge X-431TOOL directly through the socket.

### Ports and Indicators

See Fig 2-3 for X-431TOOL connection ports and indicators.

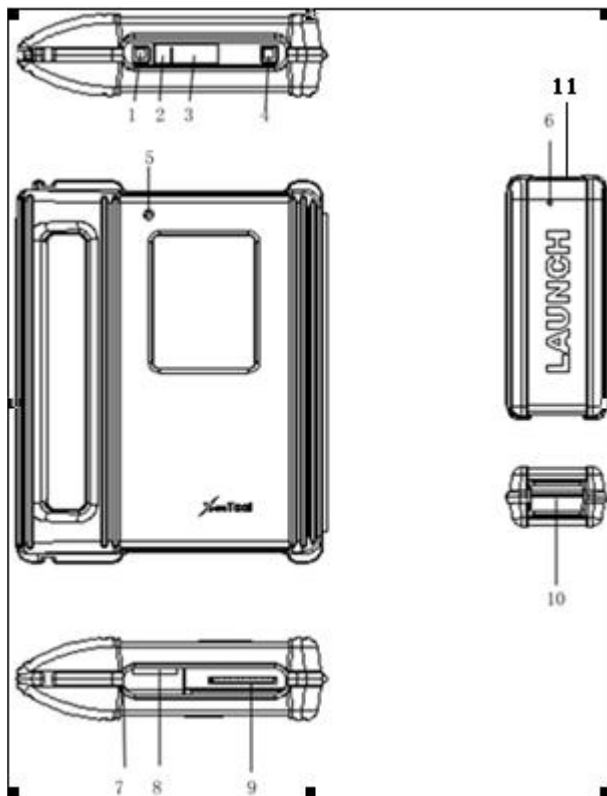

Fig 2-3 ports and indicators

1	Power switch button of main unit	2	Power input of main unit (12V DC)
3	Parallel communication port of main unit	4	Hotkey button
5	Bluetooth indicator of main unit	6	Bluetooth indicator of DIAGBOX
7	CF card ejection key	8	CF card slot
9	Paper Out	10	Diagnostic interface of DIAGBOX
11	Data interface of DIAGBOX		

### Hardware Configuration

For vehicle diagnosis, some accessories (e.g. connectors and cables) should be used to connect X-431TOOL main part to vehicle diagnostic socket.

X-431TOOL configuration is as shown in Fig. 2-4



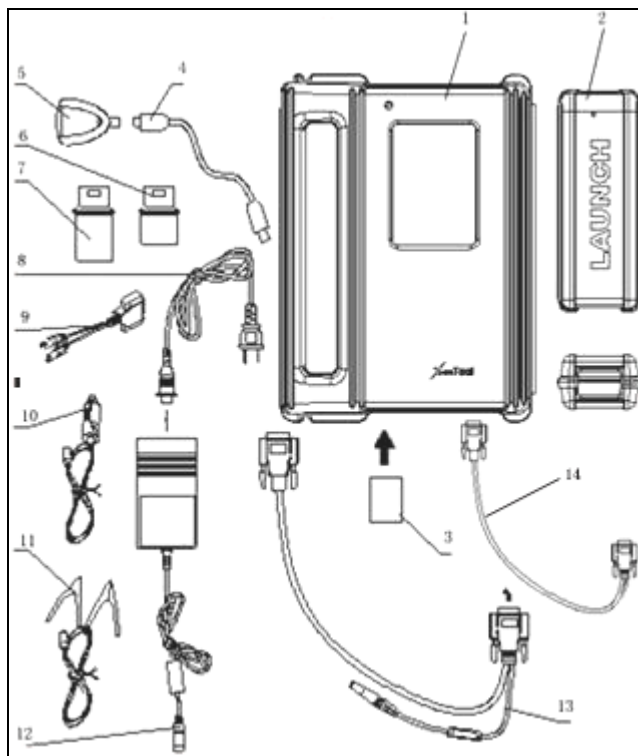

Fig 2-4

No.	Name	Description
1	X-431TOOL Main Unit	The screen of main unit can display the operation buttons, the test result and the help information.
2	DIAGBOX	Perform vehicle diagnosis
3	CF card	Store diagnostic software and data
4	USB cable	Connect CF card reader and computer
5	CF card reader	Read or write data from/to the CF card
6	Diagnostic connector	Dozens of connectors are provided/available for various vehicles. Here shows a typical one.
7	Smart OBD II -16E diagnostic connector (Standard)	Support all standard OBD II -16 DLCs.
8	Power cord	Connect the AC 100-240V (50-60Hz) outlet and the power adapter.
9	Diagnostic connector with cable	Connect the vehicle diagnostic socket

10	Cigarette lighter cable	Get power from the vehicle cigarette lighter
11	Battery cable w/two clips	Get power from the vehicle battery
12	Power adapter	Convert 100-240V AC power into 12V DC power.
13	Main cable	Connect the diagnostic connector and DIAGBOX
14	X-431TOOL box cable	Connect DIAGBOX and main unit for wire diagnosis.

### Printer Operation

Fig. 2-5 shows the back view of the X-431TOOL (Open the housing of X-431 Tool main unit, and get out the main unit.).

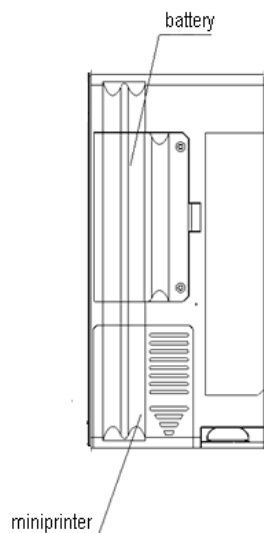

Fig. 2-5

### Mounting Paper

Miniprinter uses thermal paper with size of  $\Phi 30 \times 57\text{mm}$  (internal hole  $\Phi 7\text{mm}$ ). Refer to Fig. 2-5 for mounting the paper.

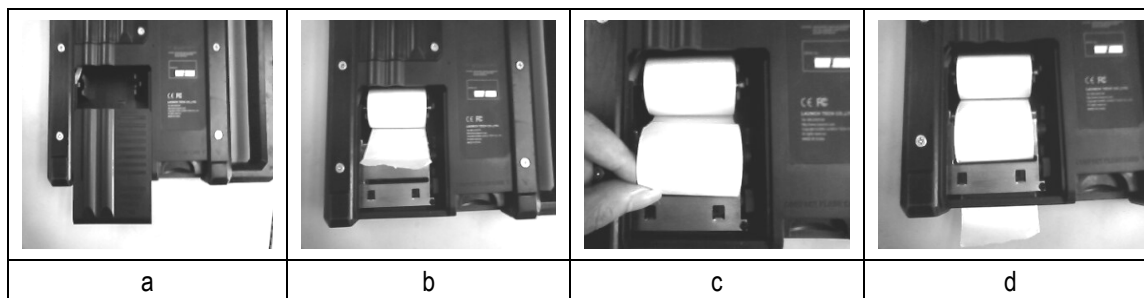

Fig 2-6

## Method I:

1. Turn off the power of main unit.
2. Open the housing of main unit and get out main unit.
3. Open the paper lid on the back of the printer. See Fig 2-6a.
4. Take out the spindle and mount the paper scroll onto the spindle. Put the paper spindle into the printer with correct direction. The paper may not be fed if the direction is wrong. See Fig 2-6b.
5. Lead the paper into slot. See Fig 2-56c. The paper will automatically lead out from the slot.
6. Adjust the paper and attach the paper lid. See Fig 2-6d.
7. Put main unit into housing.

## Method II:

1. Open the housing of main unit and get out main unit.
2. Open the paper lid on the back of the printer. See Fig 2-6a.
3. Take out the spindle and mount the paper scroll onto the spindle. Put the paper spindle into the printer with correct direction. The paper may not be fed if the direction is wrong. See Fig 2-6b.
4. Open the side plate, pull up the pressing rod and lead the paper into slot. See Fig 2-6c. Turn the feed knob clockwise until the paper comes out of the outlet. See Fig 2-6d.
5. Adjust the paper and attach the paper lid.
6. Put main unit into housing.

*Note: the printer paper is thermal paper which should avoid being heated. If being heated, the paper will lose the efficiency or the printing result will lose.*

## Specifications

- Operating system: LINUX
- CPU: 32-bit MPU
- CF card: 512M
- Main unit I/O: standard serial
- Main unit power source: DC12V
- Main unit power: about 9W
- Printer: high-speed thermal mini printer
- Screen: 240\*320 color LCD with touch-screen
- ConFIGuration: Main unit, DIAGBOX, miniprinter.
- Com. Distance: the maximal distance between DIAGBOX and main unit is 25 meters by bluetooth.
- DIAGBOX power source: DC 12V
- DIAGBOX power: about 3W

- Operation temperature: -20℃~70℃
- Battery capacitance: 2000mAH

## First Use of X-431TOOL

### Start-up

Connect the power of main unit and click [power].  
 If you want to calibrate the touch screen, please click [hotkey]. If you don't want to, please wait to enter the start-up menu as Fig 2-7 shows. Press [hotkey] more than 2 seconds, the main unit will be turned off.



Fig 2-7

### Taskbar

The taskbar is at bottom of the X-431TOOL operation interface, which has several icons, and the functions as follow :( see Fig 2-8)

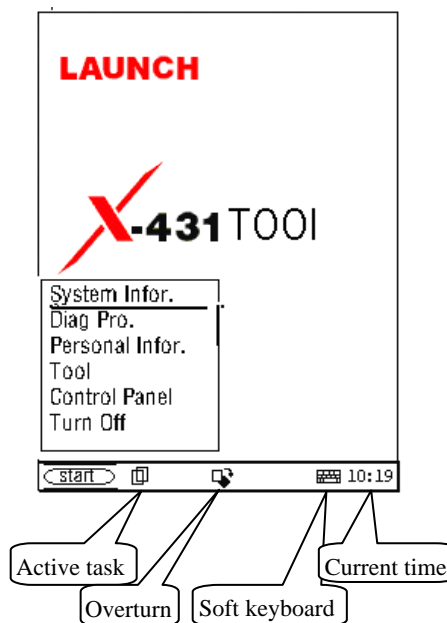

Fig 2-8

[start]: The use of the icon is similar in the windows. After clicking it with the stylus, the [start] menu is popped up, which includes the main functions of X-431TOOL.

[Active Task Icon]: Clicking the button can display the currently open interface. The interfaces can also be switched.

[Soft Keyboard Icon]: To display or hide soft keyboard. Click it to activate the soft keyboard. Then you have three ways to choose:

1. Input by hand writing.
2. Input by English.
3. Input by Chinese.

Current time: setting current time, please refer to this chapter clock.

**Input**

*Note: To input data, please activate soft Keyboard with stylus and use the stylus in the subsequent operations.*

**Using the Soft Keyboard**

- Activate and Hide
- Input by Soft Keyboard

You have two ways to choose. One is to input by Soft Keyboard just like normal keyboard. The other is to input by writing board. Click [En] button, it will switch from normal keyboard to writing board [HW]. And click [HW] button, it will switch back.

- The Function Key

There are four function keys on the upper-right of the Soft Keyboard. SBC/DBC case, punctuations, Keyboard/Writing board, and the Soft Keyboard position can be determined by clicking one of the four keys for each of the functions from left to right. (Refer to Fig.2-9)

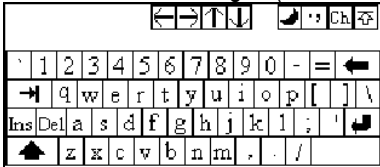

Fig 2-9

The four function keys at the upper-middle position are for moving the cursor leftward, rightward, upward or downward.

In keyboard mode, the key at the bottom left of the keyboard is [Shift] key. Click it to change the lowercase letter into the uppercase letter, and the numeral key into special symbol (same as the special characters corresponding to the numeral keys in normal keyboard). The white key at the bottom right of the Soft Keyboard is space key.

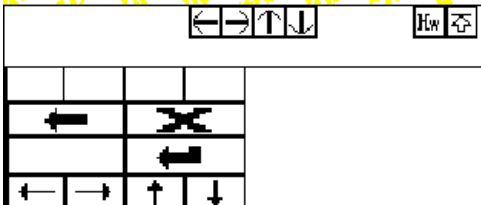

Fig.2-10

In writing board mode (refer to Fig.2-10), there are eight function keys at the lower left of the soft keyboard. The four ones on the bottom implement the function: to move the cursor leftward, rightward, upward or downward. The other four functions are (from left to right): to delete the first character before the current cursor, clear the hand-writing section, space and return.

- Input by Keyboard
  - 1) Open an interface, such as User information.
  - 2) Click Soft Keyboard Icon in the tool bar to activate Soft Keyboard.
  - 3) Click the characters on Soft Keyboard to enter data. (Refer to Fig.2-11)
- Input by Writing Board
  - 1) Open an interface, such as Memo.
  - 2) Click [New] button.
  - 3) Click the function key to switch to Writing Board. (Refer to the section "Use for Soft Keyboard").
  - 4) Write on the white board to the right of the Soft Keyboard. Enter the information by function key operation.

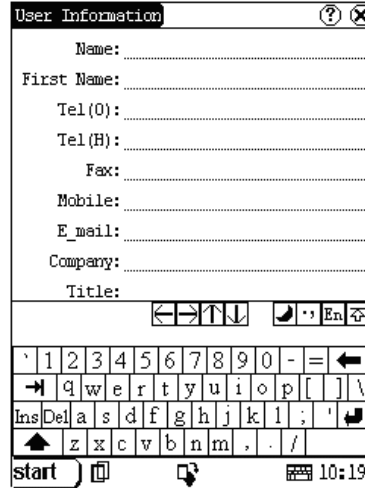

Fig 2-11

Control of App

Scrolling Bar

Check Box

Scrolling Bar is usually at the right side of the touch screen. You can click or drag it to operate. If the content can't be displayed completely in one page, moving the Scrolling Bar can turn to next page. (Refer to Fig2-13)

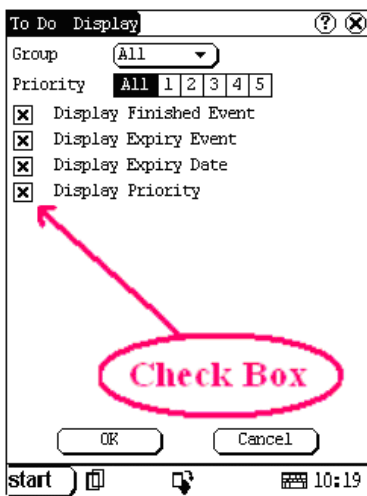

Fig 2-12

Click the check box to select the function. When the function is selected, 'X ' will be marked in the check box and the function description will be displayed on the right of the check box. You can select several functions at the same time. (Refer to Fig.2-12)

Common Button

[X] Button at top right corner of the interface: After clicking it, current interface will be closed. When editing is being done, clicking of the button will be treated as quitting the editing.

[?] Button at top right corner of the interface: After clicking it, the help information will be shown.

[Cancel] Button in the interface: After clicking it, current interface will be closed.

Help

Click [?] button at the top right corner of the interface to get helpful tips for current interface.

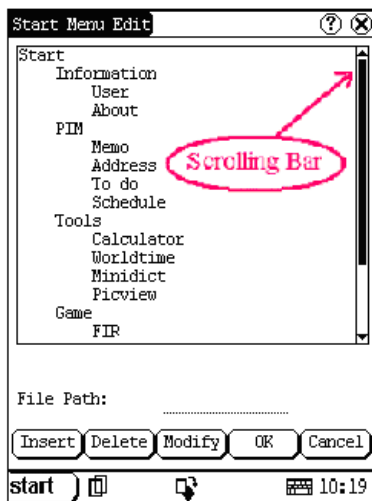

Fig. 2-13

## Vehicle Diagnosis

### Conditions for Test

- Turn on the key.
- The voltage of vehicle battery should be 11-14V. The rated voltage of the X-431TOOL is 12V.
- The throttle should be in the closed position.
- X-431TOOL works in the temperature range of 0-50 °C . (30 minutes of warming-up may be necessary when the ambient temperature is 5 °C) .

### Select Diagnostic Connector

Various diagnostic connectors are supplied with X-431TOOL. Select a specific connector according to the tested vehicle. Refer to appendix I and appendix II .

### Diagnostic Socket Location

Different vehicles have different socket locations. Please refer to appendix I and appendix II .

### Connection

Wireless connection:

- Insert the CF card into the CF card slot, keep the face labeled "UPSIDE" upward, and make sure the card is fully seated.
- Insert one end of the main cable into the diagnostic socket on DIAGBOX.
- Connect the other end of the main cable to the diagnostic connector.
- Connect the other end of the diagnostic connector to the vehicle diagnostic socket.
- For more details, please refer to Fig. 3-1.

Wire connection:

- Connect data interface of DIAGBOX and communication port of main unit via x-431TOOL box cable.

- Insert one end of X-431TOOL diagnostic cable to diagnostic interface of DIAGBOX.
- Connect the other end of X-431TOOL diagnostic cable to the diagnostic connector.
- Connect the other end of the diagnostic connector to the vehicle diagnostic socket.

*Note: the Bluetooth indicator of X-431TOOL DIAGBOX will extinguish when doing wire connection.*

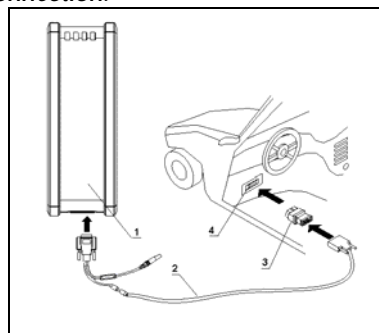

Fig 3-1

- 1—DIAGBOX                      2—main cable  
3—diagnostic connector      4—diagnostic socket

*Note:*

*If the power supply on vehicle diagnostic socket is insufficient or the power pin is damaged, you can get power in the following ways:*

- ◆ *From cigarette lighter: insert one end of the cigarette lighter cable into the lighter socket in vehicle and connect the other end to the power connector of X-431TOOL main cable.*
- ◆ *From battery: clamp the two clips of battery cable on the positive and negative poles of battery and insert another end of the cable into the power connector of X-431TOOL main cable.*
- ◆ *From power adapter: connect the power adapter to the 100-240V AC outlet with power cord. Insert the 12V DC plug of power adapter into the power connector of X-431TOOL main cable.*
- ◆ *When the battery power of the main*

*unit is insufficient, the above methods can also be used to get power. (There is an input power port for the main unit. Please refer to Fig. 2-2).*

## Operation

More and more vehicle, models and systems can be tested by X-431TOOL. Please log on the <http://www.X431.com> and update the latest software in time.

### Entering Function Menu

After connection, press [POWER] key to start X-431TOOL.

After starting the main unit, press [HOTKEY] (or click [Start] button on the main menu, and select [GAG]→[GD Scan] on the pop-up menu), the screen will display the home page of vehicle diagnosis as shown in Fig 3-2.

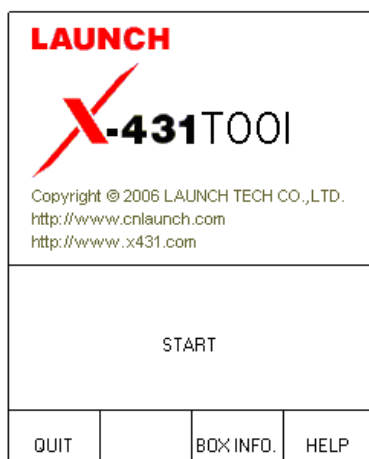

Fig 3-2

#### Button descriptions:

- ◆ [START]: to start the diagnosis.
- ◆ [QUIT]: to exit the diagnostic program.
- ◆ [BOX INFO.]: to display hardware and software version of X-431TOOL.
- ◆ [HELP]: to display help information.

Click [START] button, the screen will display [vehicle make] menu as shown in Fig 3-3.



Fig 3-3

#### Button descriptions:

- ◆ [BACK]: to return to the previous interface.
- ◆ [PAGE UP]: to display the previous page, it is inactive if the current page is the first page.
- ◆ [PAGE DOWN]: to display the next page, it is inactive if the current page is the last page.
- ◆ [HELP]: to display the help information.

Click the icon of Volkswagen on the [vehicle make] menu. The screen will be displayed as shown in Fig 3-4. Select the version that you need or the latest version. The latest version of the software is compatible with all the issued versions.

#### Note:

*The test operation for different systems is similar. Here we take Volkswagen model as an example for demonstration purpose.*



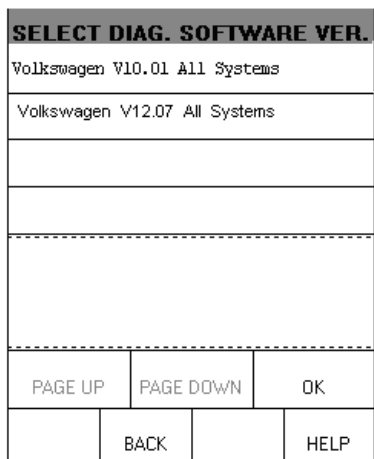

Fig 3-4

**Button descriptions:**

- ◆ [BACK]: to return to the previous interface.
- ◆ [HELP]: to display the help information.

Click [Volkswagen V10.01 All Systems]. The display will be shown as in Fig 3-5, then click [OK] button to enter the diagnostic interface.

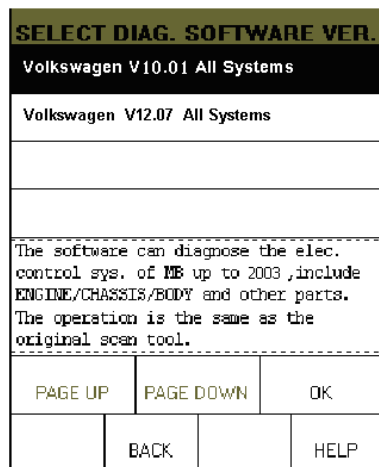

Fig 3-5

For the software version selection, the latest version is recommended, although your CF card can store multiple software versions during the upgrades of X-431TOOL.

**Note:**

The test operation for different systems is similar. Here we only take Volkswagen

model as an example to describe.

**Button descriptions:**

- ◆ [Ok]: to continue the diagnosis.
- ◆ [BACK]: to return to the previous interface.

**Control module**

Click [OK] button, the screen will display the information as shown in Fig 3-6

**Note:**

The test operation for different systems is similar. Here we only take Volkswagen model as an example to describe.

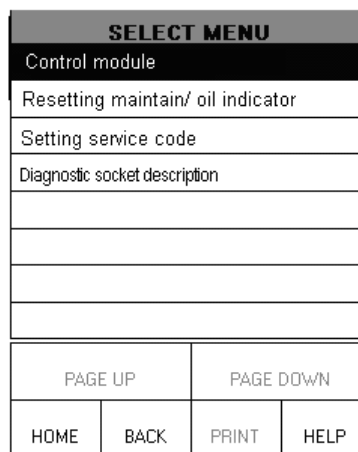

Fig 3-6

**Button descriptions:**

- ◆ [HOME]: to return to the homepage of vehicle diagnosis.
- ◆ [BACK]: to return to the previous interface.
- ◆ [HELP]: to display the help information.

Click [Control module]. The screen displays the menu of test systems as shown in Fig 3-7.

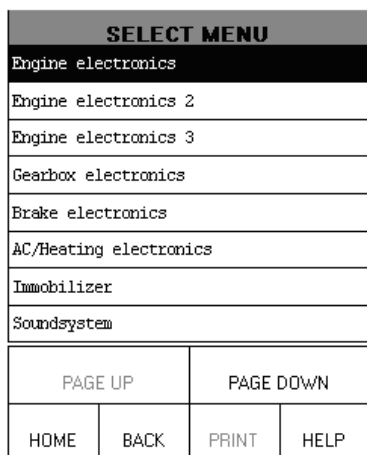

Fig 3-7

There are several pages for the menu. Click [PAGE DOWN] to see the next page.

**Note:**

The test operation for different systems is similar. Here we take [Engine electronics] as an example for demonstration.

**Button descriptions:**

- ◆ [PAGE DOWN]: to display the next page.
- ◆ [HOME]: to return to the homepage of vehicle diagnosis.
- ◆ [BACK]: to return to the previous interface.
- ◆ [HELP]: to display the help information.

Click [Engine electronics]. If the communication is successful, the screen will display the information on vehicle ECU, as shown in Fig 3-8

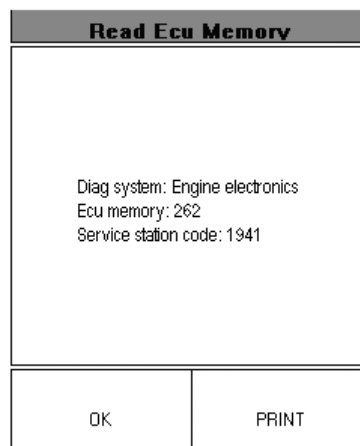

Fig 3-8

**Note:**

The information is from the vehicle ECU. If you have any question during test, don't hesitate to contact LAUNCH to get answer as soon as possible.

**Button descriptions:**

- ◆ [OK]: to go on the test.
- ◆ [PRINT]: to print the displayed information.

Fig 3-9 shows an example of printed report.

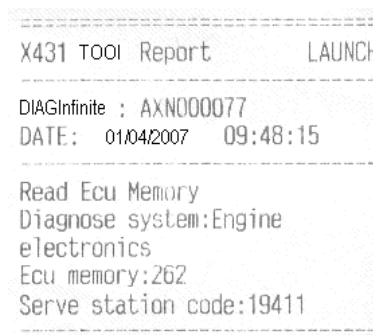

Fig 3-9

Click [OK] button. The screen will display the function menu as shown in Fig 3-10:

1. Read ECU memory
2. Read fault memory
3. Read measuring value
4. Erase fault memory
5. Basic setting
6. Adaptation

7. Read individual measuring value
8. Diagnose final control
9. Code control unit
10. Login procedure
11. End output

DIAGNOSE ITEM			
Read ecu memory			
Read fault memory			
Erease fault memory			
Diag final ctrl			
Basic setting			
Read measuring value			
Read individual measuring value			
Adaptation			
PAGE UP		PAGE DOWN	
HOME	BACK	PRINT	HELP

Fig 3-10

**Button descriptions:**

- ◆ [HOME]: to return to the homepage of vehicle diagnosis.
- ◆ [BACK]: to return to the previous interface.
- ◆ [HELP]: to display the help information.
- ◆ [PAGE DOWN]: to display the next page.

Click [PAGE DOWN] button to display the second page of the function menu as shown in Fig 3-11.

DIAGNOSE ITEM			
Code control unit			
End output			
Login procedure			
PAGE UP		PAGE DOWN	
HOME	BACK	PRINT	HELP

Fig 3-11

**Read ECU Information**

Click [Read ECU Memory] on the function menu. The screen will display the information on ECU of the tested system. See Fig 3-12.

Read Ecu Memory	
Diag system: 01 engine system 1GD906033A 1.6l/2V SIMO S3W 00ATSC04 Ecu memory: 00003 Service station code: 00001	
OK	PRINT

Fig 3-12

**Note:**

The information is from the vehicle ECU. If you have any question during test, don't hesitate to contact LAUNCH to get answer as soon as possible.

Click [OK] button to return to the function menu.

**Read Fault Memory**

Click [Read Fault Memory] in the function menu. X-431TOOL starts to test the fault code. The screen will display the test result when the test is finished. Fig 3-13 is an example of a test result.

DTC CODE			
00768 R.heat exchanger temp. Signal at sender-G154			
00771 Fuel gauge sender-G			
PAGE UP		PAGE DOWN	
HOME	BACK	PRINT	HELP

Fig 3-13

Fault Code
No fault code.
OK

Fig 3-15

**Button descriptions:**

- ◆ [HOME]: to return to the homepage of vehicle diagnosis.
- ◆ [BACK]: to return to the previous interface.
- ◆ [PRINT]: to print the test result.

Click [PRINT] to print out the test result. Fig 3-14 shows an example of printed report.

```

=====
X431 TOOL Report      LAUNCH
=====
DIAGInfinite : AXN000077
DATE: 01/04/2007 09:48:20
=====
Total codes: 002
CODE001:
00768 R.heat exchanger Signal at
temp.sender- positive
G154
CODE002:
00771 Fuel gauge
sender-G
=====
    
```

Fig 3-14

If there is no fault code in the tested system, the display will be as shown in Fig 3-15

Click [OK] button to return to the function menu.

**Read Measuring Value**

**Read Measuring Value of Volkswagen**

On the function menu, click [read measuring value] to read the datastream. See Fig 3-16.

Click the corresponding number to choose the channel.

Basic setting					
Channels(0~255):					
01					
OK		CANCEL		BACK SPACE	
1	2	3	4	5	.
6	7	8	9	0	+/-

Fig 3-16

**Button descriptions:**

- ◆ [OK]: to execute the read datastream

memory function.

- ◆ [CANCEL]: to return to the function menu.
- ◆ [BACK SPACE]: to delete the wrong number.

For example, when "1" is inputted for the channel No., the screen will display the live value of data stream of the channel. See Fig 3-17

DATA STREAM			
CHANNEL:	1		
	2.00 ms		
	840.0 /min		
	A/C - High		
	149 75 116		
PAGE UP	PAGE DOWN	GRAPHIC-1	
HOME	BACK	PRINT	HELP

Fig 3-17

*Note: Refer to appendix III for the channel and parameter defined of Volkswagen/Audi.*

On the datastream display menu, after clicking [CHOOSE DATASTREAM OPTION], then click [GRAPHIC 1]. The screen will display the chosen waveform as shown Fig 3-18.

DATA STREAM			
23.1	[Graphical Area]		
23.0			
22.9			
PAGE UP	PAGE DOWN	GRAPHIC-2	
HOME	BACK	PRINT	HELP

Fig 3-18

Click [GRAPHIC-2] to display the waveforms of 2 data stream items. See Fig. 3-19. It is convenient for the user to make live comparison between two correlative data stream items.

DATA STREAM			
CHANNEL:	2		
1	[Graphical Area]		
0			
min			
640.1	min		
640.0	[Graphical Area]		
639.9			
PAGE UP	PAGE DOWN	DIGITAL	
HOME	BACK	PRINT	HELP

Fig. 3-19

*Note:*

- ◆ The screen will display the live value of data stream again if the [DIGITAL] button is clicked in the interface.
- ◆ The three display modes -- [DIGITAL], [GRAPHIC-1] and [GRAPHIC-2] can be switched in turn.

Read Measuring Value of other series

On the function menu, select [read measuring value] to enter the [choose measuring option] menu. Click the measuring option to view. (See Fig. 3-20)

SELECT MEASURING VALUE			
Fault indicator			
Fuel system state			
CALC load			
Coolant temperature			
Short fuel learn #1			
Long fuel learn #1			
Engine rev			
Engine speed			
PAGE UP	PAGE DOWN	OK	
HOME	BACK	PRINT	HELP

Fig 3-20

**Button descriptions:**

- ◆ [PAGE DOWN]: to display the next page.
- ◆ [HOME]: to return to the homepage of vehicle diagnosis.
- ◆ [BACK]: to return to the previous interface.

As Fig 3-21 shows, the selected options will be displayed in white on the black background.

**Button descriptions:**

- ◆ [PAGE DOWN]: to display the next page.
- ◆ [OK]: to display the dynamic data of selected datastream.
- ◆ [HOME]: to return to the homepage of vehicle diagnosis.
- ◆ [BACK]: to return to the previous interface.

SELECT MEASURING VALUE			
Fault indicator			
Fuel system state			
CALC load			
Coolant temperature			
Short fuel learn #1			
Long fuel learn #1			
Engine rev			
Engine speed			
PAGE UP	PAGE DOWN	OK	
HOME	BACK	PRINT	HELP

Fig 3-21

Click [OK]; the screen will display the dynamic data of selected datastream. (See Fig 3-22).

DATA STREAM	
Fuel system state	Open loop due to dri
CALC load	0.0 %
Coolant temperature	78 °C
Short fuel learn #1	3.91 %
Long fuel learn #1	3.12 %
PAGE UP	PAGE DOWN GRAPH-1
HOME	BACK PRINT HELP

Fig 3-22

**Button descriptions:**

- ◆ [GRAPH-1]: to display the waveform of one datastream option.
- ◆ [HOME]: to return to the homepage of vehicle diagnosis.
- ◆ [BACK]: to return to the previous interface.
- ◆ [PRINT]: to print the test result.

**Erase Fault Memory**

Click [Erase Fault Memory] on the function menu. X-431TOOL starts to erase the fault code. (See Fig 3-23).

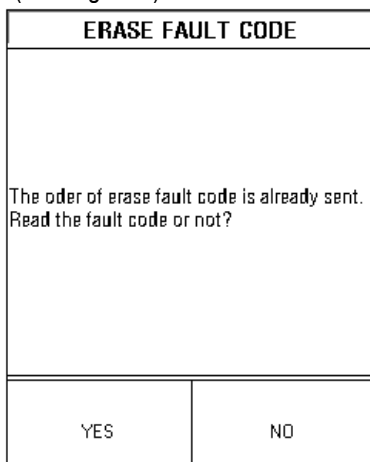

Fig 3-23

**Button descriptions:**

- ◆ [YES]: to execute read and erase the fault code.
- ◆ [NO]: to return the function menu.

If all fault codes are erased or there is no fault code in the tested system, the screen will be displayed as shown in Fig 3-24

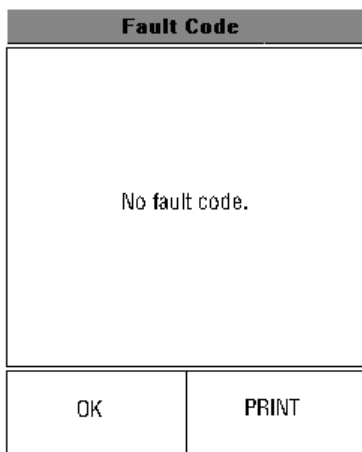

Fig 3-24

**Button descriptions:**

- ◆ [OK]: to return the function menu.

- ◆ [PRINT]: to print the test result.

**Basic Setting**

Basic setting is necessary for some systems after service is done.

Click [Basic Setting] on the function menu. Click the number button to input the group No. (See Fig 3-25)

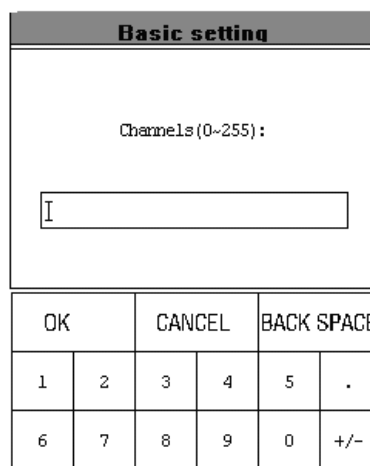

Fig 3-25

**Button descriptions:**

- ◆ [OK]: to execute the basic setting function.
- ◆ [CANCEL]: to return the function menu.
- ◆ [BACK SPACE]: to delete the wrong input number.

**Adaptation**

Click [Adaptation] the function menu. Click the number button to input the group No. The screen will be displayed as shown in Fig 3-26.

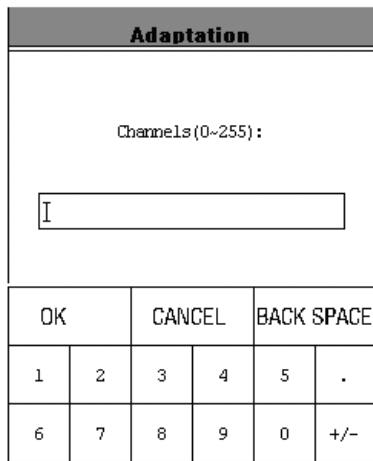

Fig 3-26

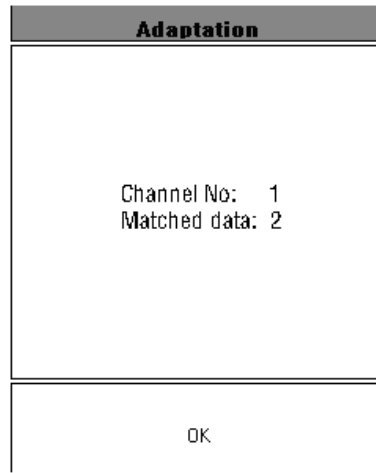

Fig 3-28

*Note: Refer to appendix IV for the basic setting channel of Volkswagen.*

Click [OK]. If the adaptation is successful, the screen will be displayed as shown in Fig 3-29

**Button descriptions:**

- ◆ [OK]: to make sure the inputted channel.
- ◆ [CANCEL]: to return the function menu.
- ◆ [BACK SPACE]: to delete the wrong input number

After the correct channel No. is inputted, click [OK] button. X-431TOOL prompts user to input the matched data. See Fig 3-27

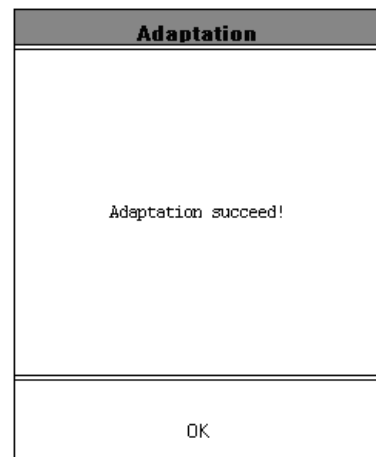

Fig 3-29

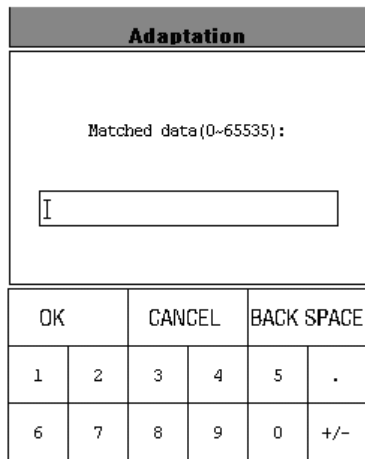

Fig 3-27

**Read Individual Measuring Value**

Click [Read Individual Measuring Value] from the function menu. The screen will be displayed as shown in Fig 3-30. Click the number button to input the group No.

After the matched data are inputted, click [OK] button to perform the function of "adaptation". (See Fig 3-28)



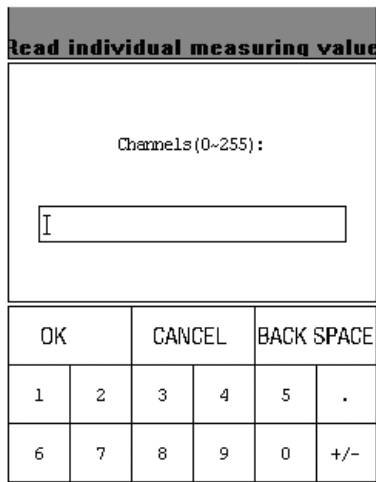

Fig 3-30

**Button descriptions:**

- ◆ [OK]: to make sure the inputted channel.
- ◆ [CANCEL]: to return the function menu.
- ◆ [BACK SPACE]: to delete the wrong input number

For example, when "1" is inputted for the channel No., the screen will display the live value of the channel. Click [OK] to return the function menu. See Fig 3-31.

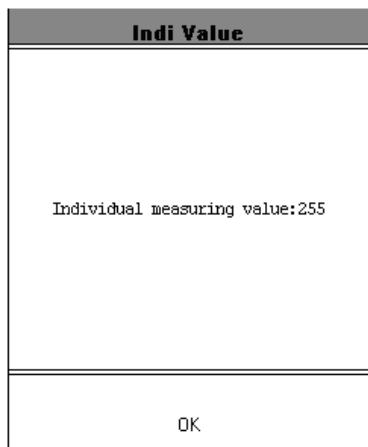

Fig 3-31

Click [OK] to return the function menu.

**Diagnose Final Control**

Click [Diag Final Ctrl] on the function menu.

The screen will display the information as shown in Fig 3-32

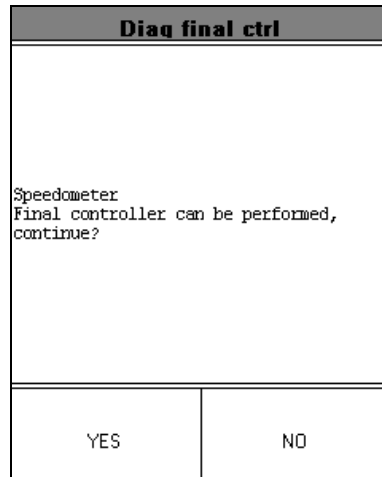

Fig 3-32

**Button descriptions:**

- ◆ [YES]: to perform the test for next component.
- ◆ [NO]: to quit the test and return to the function menu.

When the test for all actuators is finished, the screen will display the information as shown in Fig 3-33.

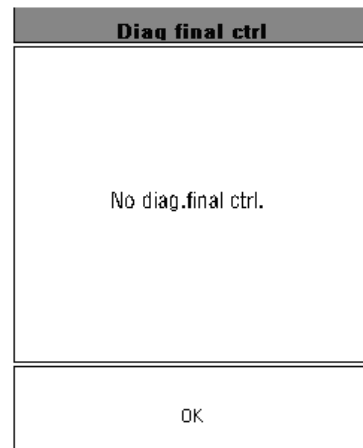

Fig 3-33

Click [OK] button to return to the function menu.

**Control Unit Code**

Click [Control Unit Code], the screen will display the information as shown in Fig 3-34. X-431TOOL prompts user to input the code control unit. Click the number button to input the group No.

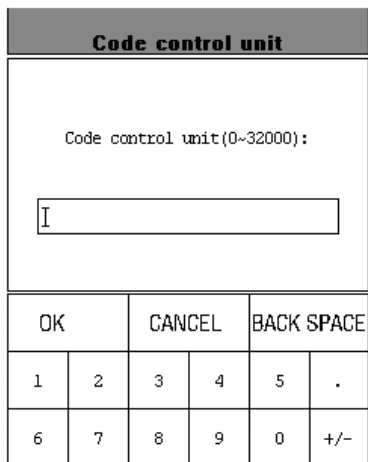

Fig 3-34

**Button descriptions:**

- ◆ [OK]: to make sure the inputted code.
- ◆ [CANCEL]: to return the function menu.
- ◆ [BACK SPACE]: to delete the wrong inputted number

Click [OK] to enter the interface as shown in Fig 3-35.

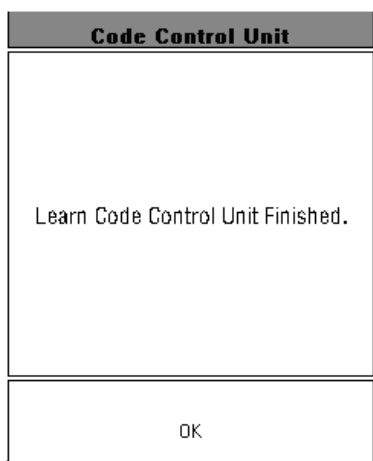

Fig 3-35

Click [OK] to enter the interface about the ECU as shown in Fig 3-36.

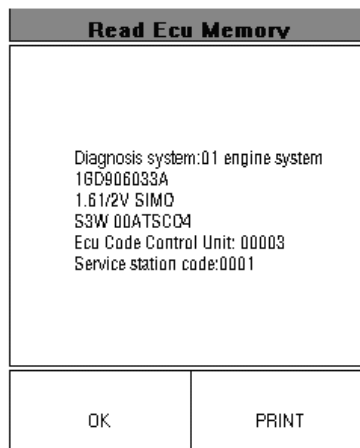

Fig 3-36

**Note:**

*The information is from the vehicle ECU. If you have any question during test, don't hesitate to contact LAUNCH to get answer as soon as possible.*

**Button descriptions:**

- ◆ [OK]: to return the function menu.
- ◆ [PRINT]: to print the displayed information.

If the control unit can't be coded, the screen will be displayed as shown in Fig 3-37.

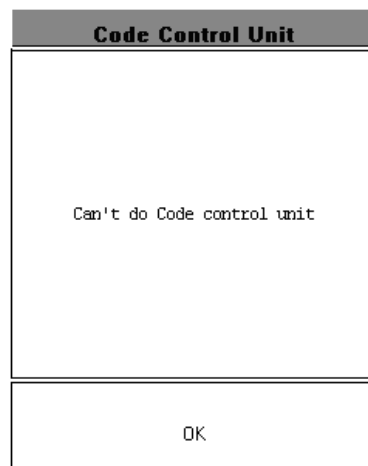

Fig 3-37

Click [OK] to return to the function menu.

**Login Procedure**

Click [Login Procedure] on the function menu. The screen will be displayed as shown in Fig 3-38 X-431TOOL prompts user to input the password. Click the number to input the password.

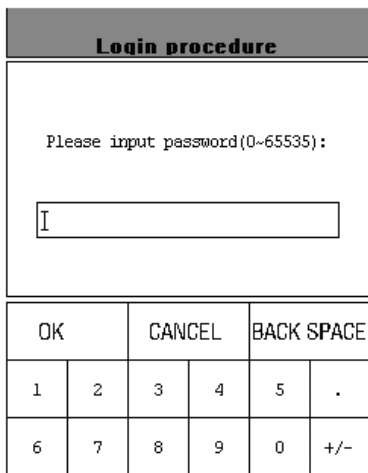

Fig 3-38

**Button descriptions:**

- ◆ [OK]: to execute the login procedure function.
- ◆ [CANCEL]: to return the function menu.
- ◆ [BACK SPACE]: to delete the wrong inputted number

**Note:**

Perform this function first before performing the functions like "code control unit", "adaptation", etc.

After the login password is inputted, click [OK] button. X-431TOOL starts to log in. When the login is successful, the screen will display the information as shown in Fig 3-39. Click [OK] to return the function menu.

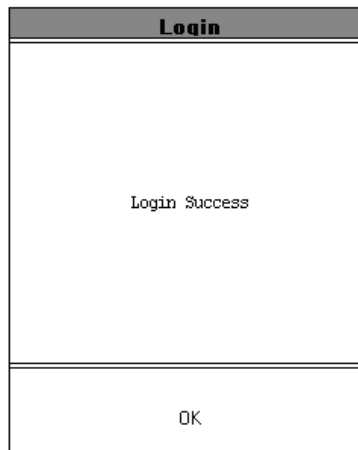

Fig 3-39

Click [OK] button to return to the function menu.

**Resetting Maintain/oil Indicator**

On the diagnosis menu (see Fig 3-40& Fig 3-41), click [Resetting maintain/oil indicator] to execute this function.

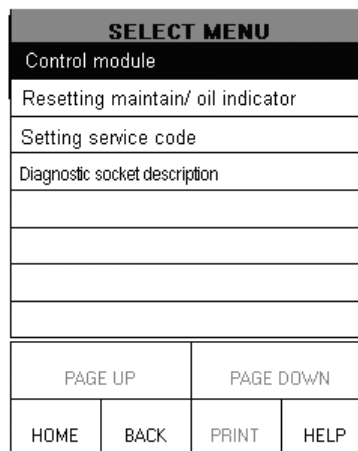

Fig 3-40

SELECT MENU			
OIL			
IN1			
IN2			
PAGE UP		PAGE DOWN	
HOME	BACK	PRINT	HELP

Fig 3-41

Login procedure					
setting service code(0~65535):					
I					
OK		CANCEL		BACK SPACE	
1	2	3	4	5	.
6	7	8	9	0	+/-

Fig 3-42

The following is the resetting options of the maintain indicator.

Maintain option	Resetting indicator
12068km/6 m	OIL
24139km/12 m	OIL 、 IN1
36209km/18 m	OIL
48278km/24 m	OIL、 IN1、 IN2
60348km/30 m	OIL
72417km/36 m	OIL、 IN01
84487km/42 m	OIL
96556km/48 m	OIL、 IN01、 IN2

### Setting Service Code

Some functions for Volkswagen and Audi will be executed after setting service code. If not, these functions, such as adaptation and control unit code function, will not be done. Click [setting service code] in the Fig 3-42.

### OBD II Diagnostic function

#### Freeze Frame Data

Freeze frame test of OBD II is used for the OBD II vehicle. On the [select vehicle make] menu choose [OBD II] to enter [freeze frame data] for executing this function.(See Fig 3-43)

SELECT DIAG FUNCTION			
Read fault memory			
Erase fault memory			
Read measuring value			
Read freeze frame data			
Readiness Tests			
PAGE UP		PAGE DOWN	
HOME	BACK	PRINT	HELP

Fig 3-43

Click the option that you want to view, and then click [OK]. Click [BACK] to return the function menu. (See Fig 3-44).



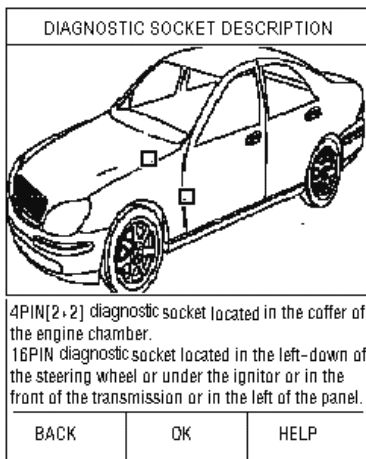

Fig 3-48

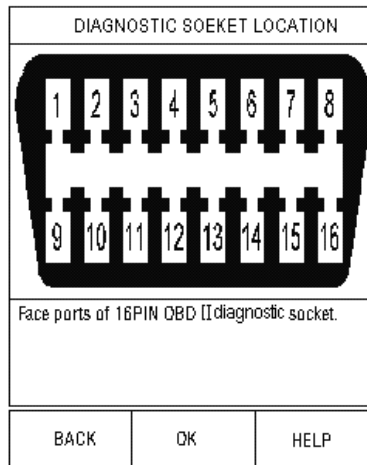

Fig 3-50

If there is still the glittery pane, you can continue to click it till the diagnostic socket location is displayed. (See Fig 3-49).

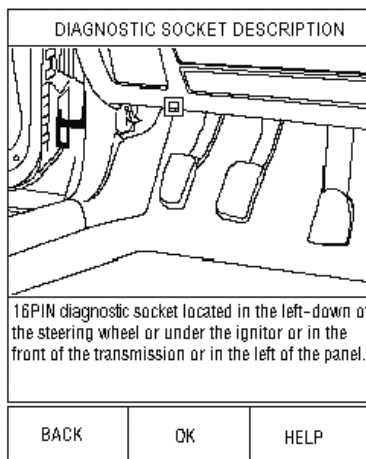

Fig 3-49

At last, the particular diagnostic socket location will displayed. (See Fig 3-50).

## Update of diagnostic software

### User Registration

Log on [www.X431.com](http://www.X431.com). Select the favorite language on the pull-down menu at the lower right of the interface to enter the homepage. See Fig 3-51.



Fig 3-51

- Read Terms of Service  
Click "Register" in the interface shown in Fig 3-52 to open the window as shown in Fig 3-52.

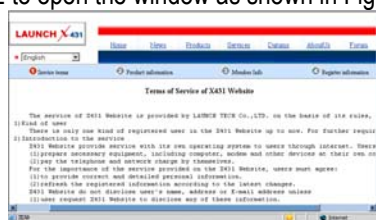

Fig 3-52

**Note:**  
When the member purchases one or more products after registration, he should log

onto the member area, and then click "product control" to register the newly purchased product. Refer to the section "Member login".

The terms of service is shown in the screen. After reading and fully understand it, click "I accept" button to enter the interface shown in Fig 3-52.

- Fill in Product Information  
Fill in the serial No. of DIAGBOX, registration No. and dealer code in the interface shown in Fig 3-53.

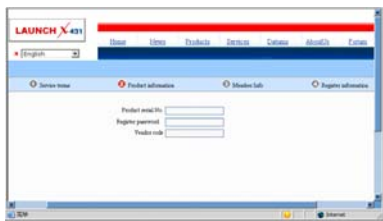

Fig 3-53

The serial No. is marked on the back of DIAGBOX. The registration No. is in an envelope delivered with the product (the number must be kept confidential). The dealer code is attached on the last page of the user's manual.

After the information is filled, click "Next step" to enter the next interface shown in Fig 3-55.

**Note:**  
*When a product is sold, the dealer will log onto [www.X431.com](http://www.X431.com) and enter the dealer code in the "Dealer administration" area so that the user can do effective registration later. User should contact the dealer if registration can not be done effectively.*

If the filled serial No. or registration No. is invalid, the screen will display the message as shown in Fig 3-54. Click "OK" button to return to the previous interface to re-fill the correct numbers.

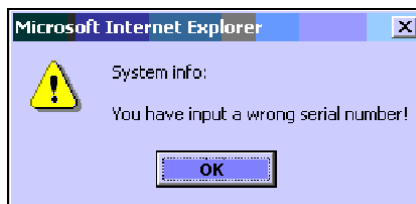

Fig 3-54

- Fill User Information

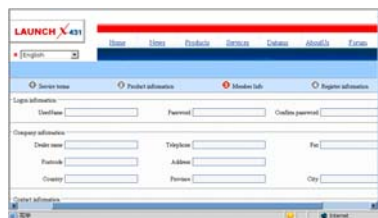

Fig 3-55

After information is filled in the interface shown in Fig 3-55(The red textbox must be filled. After registration, we will send the confidential information to your registered e-mail, so please make sure that your e-mail is valid.), click "Next step", then the screen will display the interface shown as Fig 3-56. Click "OK" then the registration is completed.



Fig 3-56

**Note:**  
*Only the registered user can download and update the software.*

Software Update

Member Login

The user becomes the registered member after registration. Member can log in the website by filling username, password and user type in the interface shown in Fig 3-51.

*Note: when choose the user type, the common users may choose the customer. If the dealer and the branch want to log to the website, please use the user information given by LAUNCH head office.*

After log successfully, the screen will display the interface as shown in Fig 3-57(default download center interface).



Fig 3-57

[Download Center]: Refer to “software download”.

[Purchase Center]& [Update center]: Refer to “software purchase and update”.

[Member Information]: to display and renew the current member information.

[Product Registration]: Register newly purchased product.

[Order Information]: to check or cancel the unpaid order.

[Renew Password]: After entering the right old password, then can renew the password.

[Awarded collection for claim] if users meet some trouble during the operation, he can feedback to LAUNCH. Effective complaint will be awarded by LAUNCH

[Logout]: Users exit the registration.

**Software Download**

After log successfully, the screen will enter the [download center] interface. (See Fig.3-57) Registered user can download the software that installed in the download center. Before download, users had better set up a new folder named [X-431TOOL update] on the computer desktop and put the download file to the[X-431TOOL update] according the next

steps.

*Note:*

1. *Software update of free charge will be provided by LAUNCH for one year. The free period is from the registration date on the website, not the purchase date. That is, during one year after the registration, users can free download the corresponding software.*
2. *If there is not the latest version in the download center, users can buy the version in the purchase center or in the update center. In the purchase center, users can buy the software that don't install in the download center. In the update center, users can buy the software that is beyond the free download period. After purchase successfully, the purchased software will be automatically added in the download center list.*

**Update Tool Download**

Before update, users must download the update tools. On the drop-down menu, users select the language then click [download]. The screen will display the interface as shown in Fig 3-58.



Fig 3-58



Click [save] to put into the[X-431TOOL update].

### Display Program Download

When download the diagnostic program, users can also download the display program. On the drop-down menu, users select the language then click [down]. On the pop-up menu, click [save] to put the program into the[X-431TOOL update].

### System Data Download

On the drop-down menu, users select the language then click [down]. On the pop-up menu, click [save] to put the program into the[X-431TOOL update].

### Diagnostic Program Download

On the drop-down menu, select the language and the version (default version is the latest version). Click [down] icon, then click [save] on the pop-up menu to save the file.

Click [view] to learn the detailed information of the version.

Users can down the diagnostic program into the [X-431TOOL update]. Up to now, the software that is for update is downloaded completely.

### Connection of the Reader and Install the Driver

- Necessary Hardware:
  1. A computer that can access the Internet.
  2. A CF card reader and a CF card that need to be updated.
- Connection of Reader
 

See Fig. 3-59 for hardware connection.

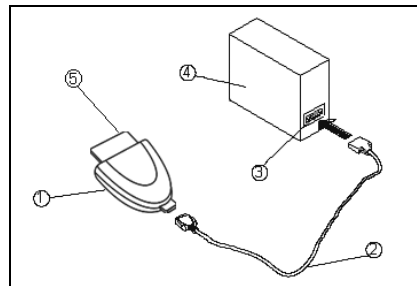

Fig. 3-59

- 1-CF card reader      2-USB cable  
3-USB Port      4-Computer      5-CF card

- Insert the CF card into the CF card reader.
- Connect one end of the USB cable② to the port of the CF card reader①, and the other end to the USB port of the computer.
- Install the Driver
 

If it is the first time to use the CF card reader, you may have to install its driver. Use CD-ROM or floppy disk which are bought separately or delivered with the CF card reader to install the driver.

CF card reader can use the default driver in Windows Me/2000/XP and Mac OS 9.x/Mac OS X. However, it is necessary to install the driver on Windows 98.

The installation procedure is as follows:

1. Boot Windows 98.
2. Insert the CD-ROM into CD-ROM drive.
3. Connect CF card to the USB port of the PC with the attached USB cable. Find and Double click on setup.exe file in the catalogue of CD-ROM. The system will make preparation for the installation. See Fig 3-60
4. When the preparation is complete, the screen will prompt to continue the operation. See Fig 3-61 Click "Next" to start installation.

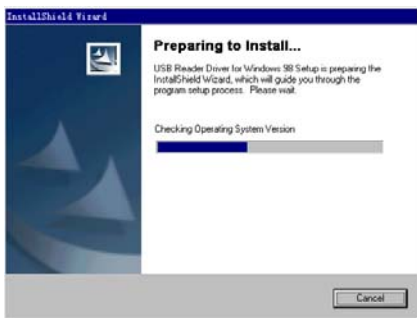

Fig 3-60

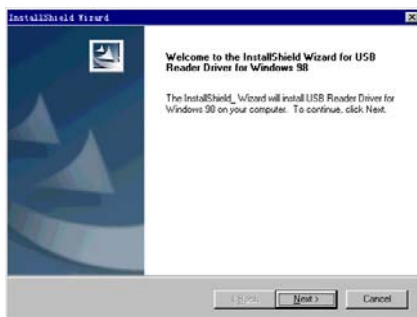

Fig 3-61

- When installation is finished, the screen will display the information as shown in Fig 3-62. Click "Finish" to exit.

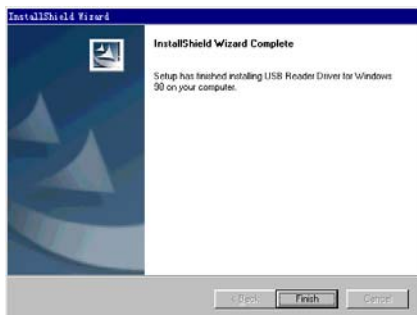



Fig 3-62

When the CF card reader is installed successfully, a "Removable disk" icon  will be added in the catalogue of "My computer".

### Precaution on Operation of the CF Card

#### Reader:

- Do not unplug the CF card reader from the USB port while its LED is blinking, otherwise data would be damaged!

- Pull out the CF card  
The CF card must not be pulled out when the CF card reader is being used. Otherwise, the data in the CF card will be lost.

**Procedure for pulling out the CF card:**  
On the desktop of Windows, open the window of "My computer". Click the right mouse button on "Removable disk" to pop up a menu. Select "Ejector (J)" in the menu. Then pull out the CF card. The written data may be lost if the CF card is pulled out discretionarily. When you want to use the CF card again, put it in.

### Software Update

Open the "X-431TOOL update" folder, and double click the icon . Then install the update tool according to the prompts on the screen.

When the installation is complete, the "X-431TOOL update tool" icon will appear on the desktop.

Make sure that the X-431TOOL CF card reader and the CF card are well connected to the computer. Then double click the "X-431TOOL update tool" icon to run the program. The program will automatically check the downloaded update files, including the diagnostic program and the display program. See Fig 3-63



Fig 3-63

Select the module for update in the interface shown in Fig 3-63, and click “Update” icon to update. When the update is complete, prompts will appear to notify successful update.

The required space and available space are listed at the lower left of the interface. If the available space is not enough to perform the operation, click  to show the installed programs. Select the programs that can be deleted and click “Delete” button to make some more space available.

Software Purchase

If the users can't find the software that he needed, at this time users must buy the software in the purchase center. Log on the [www.X431.com](http://www.X431.com) then enter the interface as shown in Fig 3-64.



Fig 3-64

Click [purchase center] to choose the serial number, and then tick in front of the serial number.

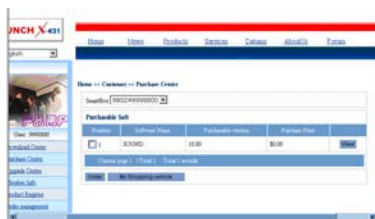

Fig 3-65

Click [pay] to buy the software. The bought software will be automatically added in the user's download center.

Click [clear] to clear all the software in the shopping cart.

Click [purchase other] to buy other software. (See Fig 3-66).



Fig 3-66

The operation for update center is the same as for the purchase center.

## Flow Chart of X-431TOOL Update for New User

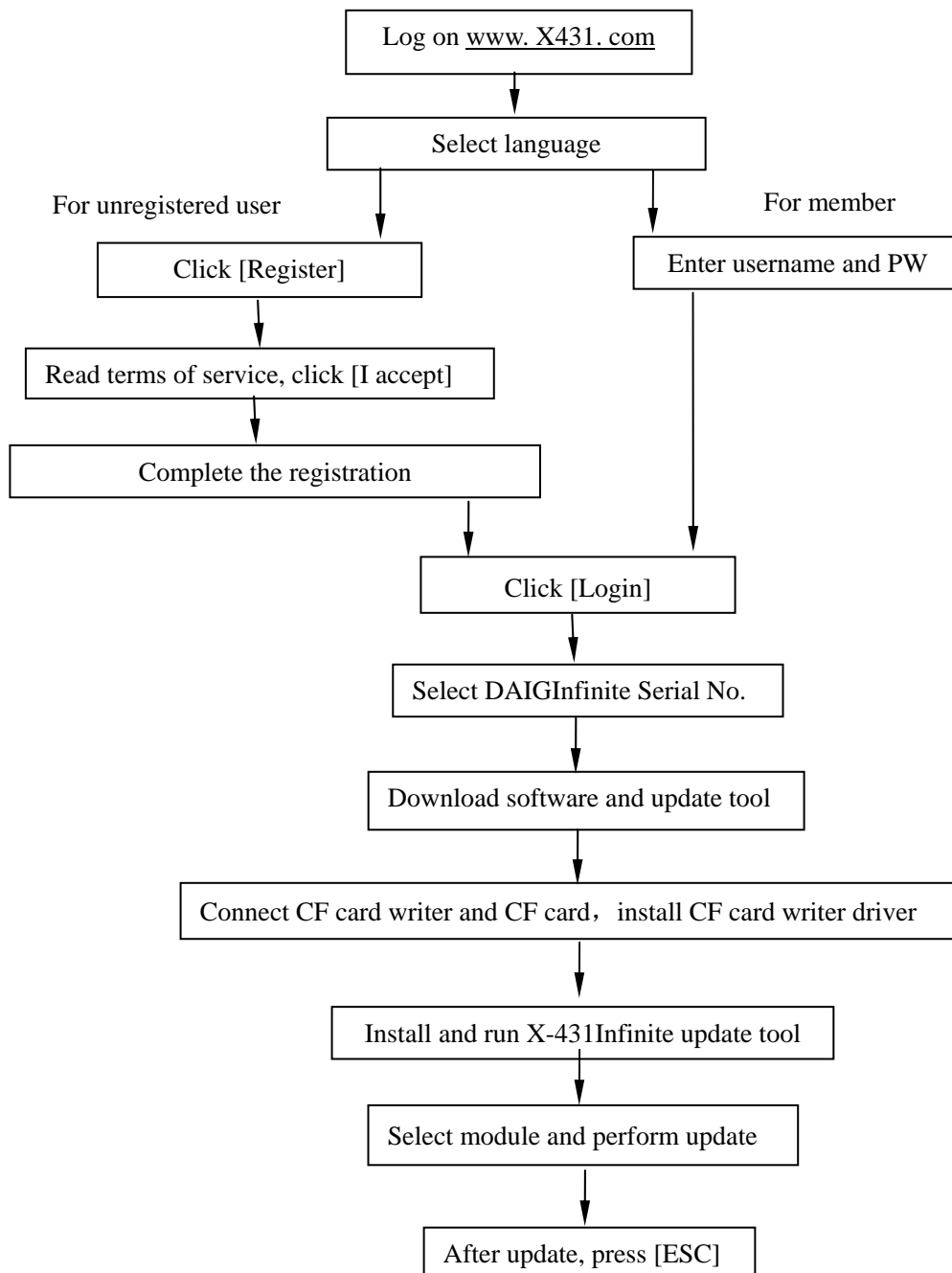

## PDA function

In the X-431TOOL operation interface, click [start] to pop up the menu that included the main PDA functions executed by equipped stylus.(See Fig 4-1)  
The items and their respective functions in the menu are shown in the following table.

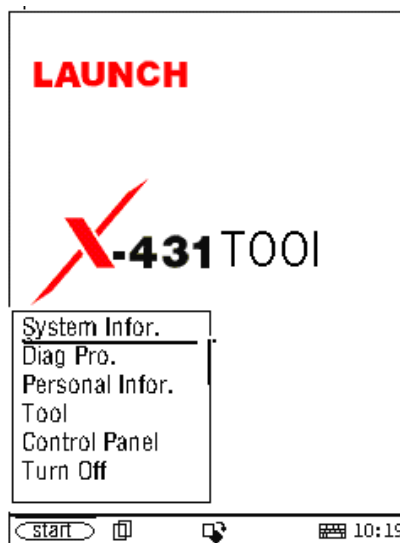

Fig 4-1

### PDA Function Summary

System Information	User Information	Set the user name, company and telephone number etc. information by user.
	About	About the main unit serial number, hardware version and software information.
PIM (Personal Information Management)	Memo	To record all kinds of important information and ideas, and make corresponding classification.
	Address	To store the detailed information of relative, friends, colleagues and business partners, which can be easily edited, retrieved and searched.
	To Do	It is convenient for user to record the business to do or being done, to delete or add task records, to arrange the priority of tasks, and to browse the classified tasks.
	Schedule	To arrange the appointments, journeys and meetings in a whole day; to check time schedule on business daily, weekly, monthly and/or annually; and to describe the place, time and other details for each schedule record.
Tools	Calculator	Both simple and scientific calculators are available.

	World Time	The time of many big cities in the world are offered. It is a helpful assistant for your travel.
	Mini Dictionary	An English-Chinese dictionary embodies a large number of words, which cover all fields to overcome your inconvenience in language.
	Picture View	To enjoy all kinds of pictures which can be zoomed in/out.
Control Panel	Application	To link the application with the 'Start' menu, or delete it from the 'Start' menu.
	Power Management	To preset the use of power to save on electricity as possible.
	Clock Set	To set the system time.
	Contrast	To adjust the contrast of display.
	Language Set	To select language to be used.

## System information

### User Information

The user information is filled out by the user. To register the information, the rights and interests of the user will be more guaranteed. (See Fig 4-2)

- Click [start] button;
- In the pop-up menu, select [system information];
- In the pop-up option from the system information, select [user register] to open the user information interface;
- In the user information menu, active the soft keyboard to input user information;
- Click [ok] to save and close user information.

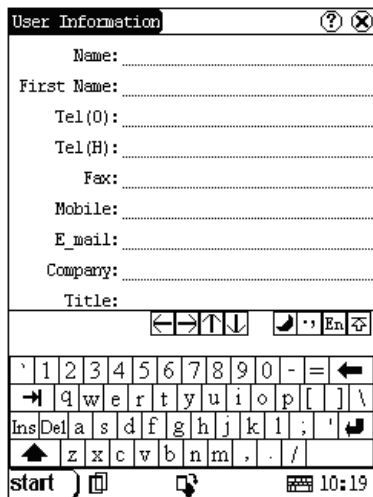

Fig 4-2

### About

In the system information menu, click [about] to display the corresponding information of the hardware and the software. Click [ok] to close the about information. (See Fig 4-3)

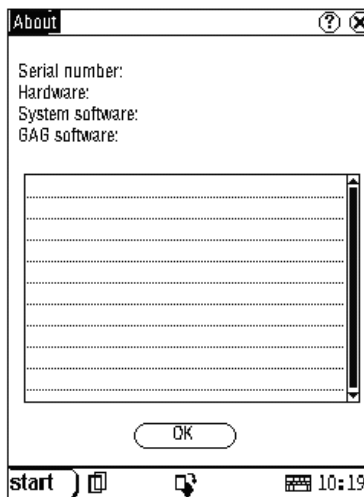

Fig 4-3

## Tool

X-431TOOL provides some practical tools to solve some trouble.

- Click [start];
- In the pop-up menu select [tool];
- In the pop-up options select the function you need.

### Calculator

This calculator can perform not only common calculations as a simple calculator, such as addition and subtraction, but also the function operations as a scientific calculator, such as logarithm and factorial. (Refer to Fig 4-4).

- 1) In the pop-up menu of 'Tools', select 'Calculator' to open the Calculator interface.
- 2) Click the square overlap icon on upper left of the screen to switch between scientific calculator and simple calculator.
- 3) Click 'Unit Conversion' button to switch between unit conversion calculator and simple calculator.

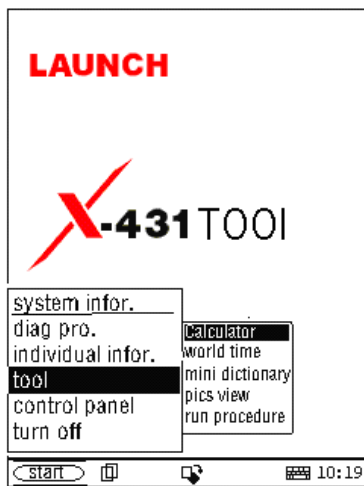

Fig 4-4

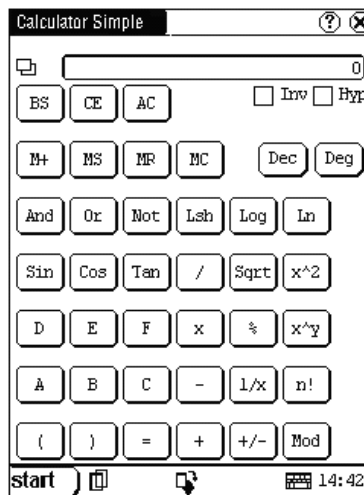

Fig 4-6

- 1) Click [Start] button.
- 2) Select 'Tools' in the pop-up menu.
- 3) Select the function needed in the pop-up submenu.

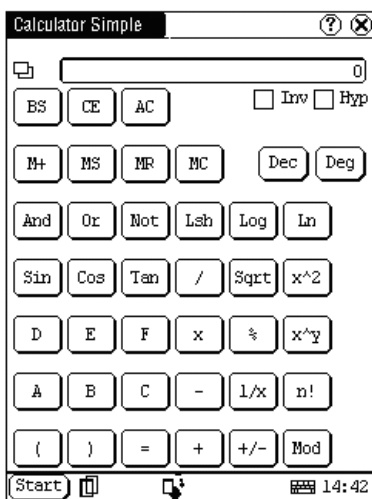

Fig 4-5

Calculator simple and calculator scientific (refer to Fig 4-5 and Fig 4-6):

- 1) Click numeral keys on the screen to input.
- 2) Or activate Soft Keyboard, and click numeral key on Soft Keyboard to input.
- 3) The operation is the same as that for normal calculator.

Unit Conversion Calculator (Refer to Fig 4-7):

- 1) Click 'Unit type' button at the top right corner to select unit type.
- 2) Input the number to be converted in the blank next to the unit name, and then you will see the conversion result.
- 3) If you want to return to simple calculator, please click 'X' button at the top right corner to close the current interface.



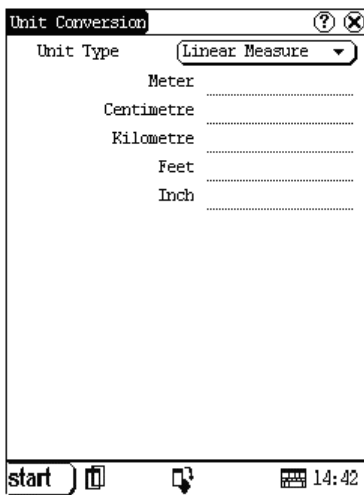

Fig 4-7

### World Time

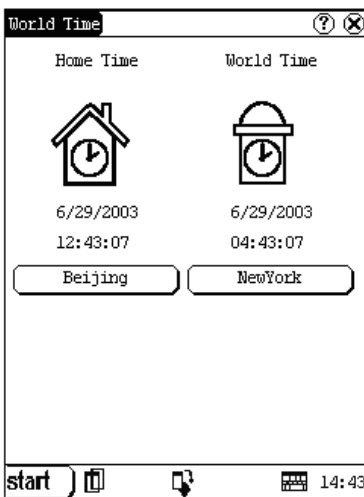

Fig 4-8

- 1) In the pop-up menu of 'Tools', select 'world time' to open the world time interface.
- 2) Click the button under the 'Home Time' icon to select region.
- 3) Click the button under the 'World Time' icon to select region.
- 4) Then you can see the time directly. (See Fig 4-8).

### Dictionary

- 1) In the pop-up menu of 'Tools', select 'Dictionary' to open the Dictionary interface. (See Fig 4-9)
- 2) Activate Soft Keyboard, and input words.
- 3) Select the word from the list on the left.
- 4) Click the word, and then you can find the translation in the right list.

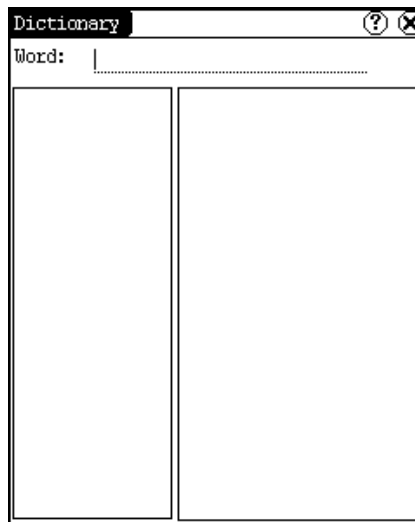



Fig 4-9

### Picture View

- 1) Click [Start] button.
- 2) Select 'Tools' in the pop-up menu.
- 3) In the pop-up 'Tools' list, select 'Preview' to open the Picture interface.
- 4) In the Picture interface, click  icon in the toolbar on the top. (See Fig 4-10)
- 5) Select directory from the left list interface.
- 6) Select file from the right list interface.
- 7) Click [Parent Dir] button and you can see the directory of current directory's parent.
- 8) You can see the directory of the picture at the right side of 'Path'.
- 9) You can see the file name of the picture at the right side of 'File'.
- 10) Click [OK] button to open the picture.

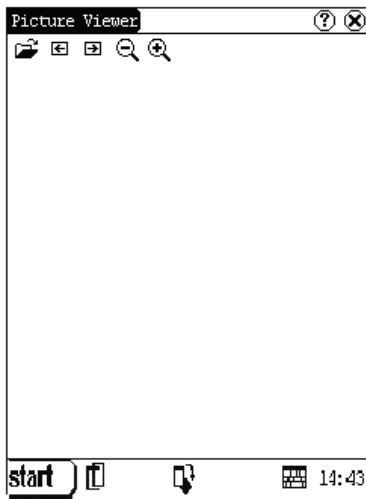

Fig 4-10

Browse the pictures in current directory

- 1) In the Picture interface, click icon on the top to browse the previous picture.
- 2) In the Picture interface, click icon on the top to browse the next picture.

*Note:*

*This operation is needed only when more than one picture has been stored.*

Zoom in and zoom out:

In the Picture interface, click or icon on the top, then you can zoom in or zoom out the current picture at will.

**PIM**

- 1) Click [Start] button.
- 2) Select 'PIM' in the pop-up menu.
- 3) Select the function needed in the pop-up list. See Fig 4-11.

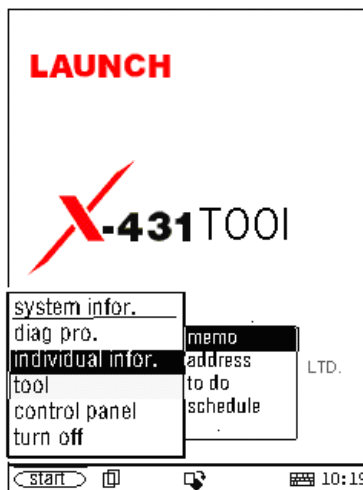

Fig 4-11

**Memo**

The basic functions of Memo include: add new memo, view memo, delete memo, browse by types, etc.

- 1) In the pop-up 'PIM' list, select 'Memo' to open the Memo interface. (See Fig 4-12)
- 2) After you click the [▼] button on top right corner, the type list will pop up. Then you can select the type of the memo.
- 3) You can also select the Edit Group in the type list to open the Edit Group interface.
- 4) The memo list of corresponding type will be displayed in the list box on the midst of the Memo interface.
- 5) Click one memo in the memo list to open the Memo Edit interface.
- 6) Click [New] button to open the New Memo interface.

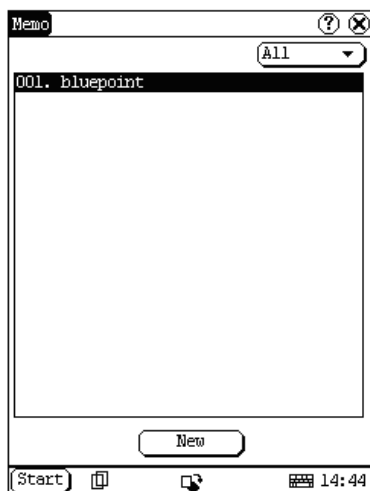

Fig 4-12

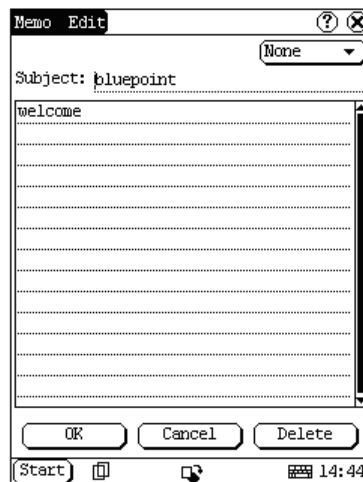

Fig 4-13

### Add New Memo

- 1) In the Memo interface, click [New] button to open the New Memo interface.
- 2) Activate Soft Keyboard, and fill the subject and contents.
- 3) Click the button on top right corner, then select the type in the pop-up list
- 4) Click [OK] button to save and close the New Memo interface.
- 5) Then you can see the new memo in the list box of the Memo interface.

### View Memo

- 1) In the list box of the Memo interface, click the memo that you want to view.
- 2) Then you can view the contents of the memo in the opened Memo Edit interface.
- 3) Click [OK] button to close the Memo Edit interface.

### Edit Memo

- 1) In the list box of the Memo interface, click the memo that you want to edit.
- 2) Then you can edit the contents of the memo in the opened Memo Edit interface. See Fig 4-13.
- 3) After editing, click [OK] button to save the edited contents and close the Memo Edit interface.

### Delete Memo

- 1) In the list box of the Memo interface, click the memo that you want to delete.
- 2) Then you can delete the memo in the opened Memo Edit interface.
- 3) Click [Delete] button to delete the memo and close the Memo Edit interface.

### Edit Type

- 1) Click the [▼] button on the top right of the interface ① so that the type list pops up.
- 2) In the type list, select the Edit Group to open the Edit Group interface.
- 3) In the Edit Group interface, activate Soft Keyboard.
- 4) In the text box at the bottom of the interface, input the name of the type.
- 5) Click [Add] button to add a new type and it will be displayed in the list box of the Edit Group interface. (See Fig 4-14)
- 6) Select one type in the list box, and then click [Delete] button to delete it.
- 7) Click [Close] button to close the Edit Group interface.

*The interface ① : It represents the Memo Interface, the New Memo interface and the Memo Edit interface.*

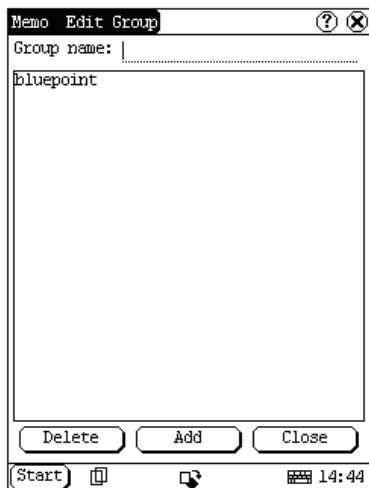

Fig 4-14

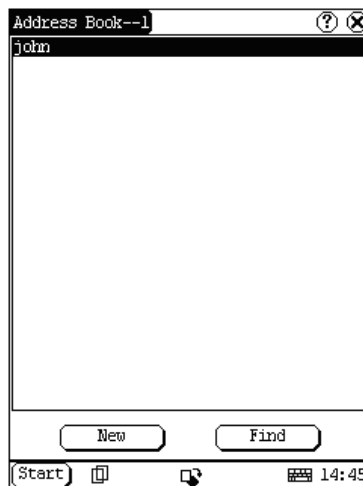

Fig 4-15

**Browse By Types**

- 1) Click the [▼] button on the top right of the Memo interface so that the type list pops up.
- 2) Select the type in the list.
- 3) Then you can see the memo belonging to the type in the list box.

*Note: Only the memo belonging to the type can be displayed here. If you want to browse all memos, please select 'All' in the steps 1 and 2.*

**Address**

The basic functions of Address Book include: add new address, view address, delete address, to search address, etc.

- 1) In the pop-up 'PIM' list, select 'Address' to open the Address Book interface.
- 2) It lists the name of persons whose communication information has been stored.
- 3) Click [New] button to open the Address New interface. (See Fig 4-15)
- 4) Click [Find] button to pop up the Find People interface.

The operation guide for each function is described below:

**Add New Address**

- 1) In the Address Book interface, click [New] button to open the Address New interface. (See Fig 4-16)
- 2) Activate Soft Keyboard, and fill the detailed information on relatives and friends.
- 3) Click [OK] button to save and close the Address New interface.
- 4) Then the added name will be displayed in the list box of the Address Book interface.

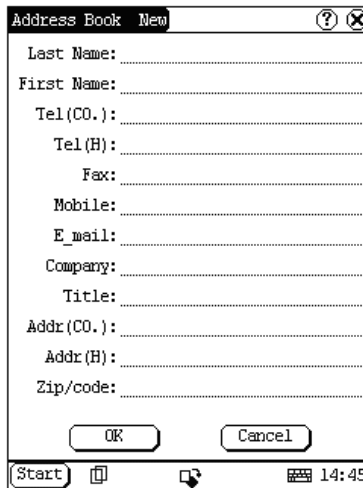

Fig 4-16

**View Address**

- 1) In the list box of the Address Book interface, click the name that you want to view.

- 2) Then the detailed information about the person will be shown in the opened Address Edit interface.
- 3) Click [OK] button to close the Address Edit interface.

**Edit Address**

- 1) In the list box of the Address Book interface, click the name that you want to edit.
- 2) Then the information about the person can be edited in the opened Address Edit interface. See Fig 4-17.
- 3) After editing, click [OK] button to save the edited contents and close the Address Edit interface.

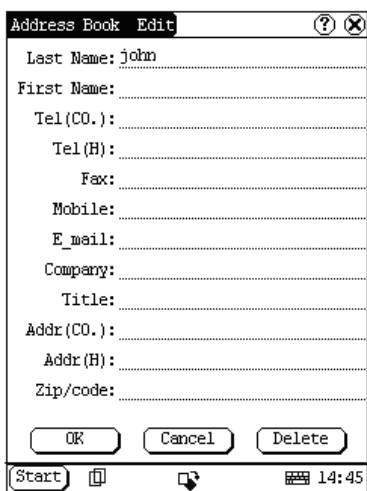

Fig 4-17

**Delete Address**

- 1) In the list box of the Address Book interface, click the name that you want to delete.
- 2) Then the information about the person will be shown in the opened Address Edit interface.
- 3) Click [Delete] button to delete the person's information and close the Address Edit interface.

**Search Address**

- 1) In the Address Book interface, click [Find] button to pop up the Find People interface. See Fig 4-18.

- 2) Activate Soft Keyboard, and input the name you want to search.
- 3) Click [OK] button, and then you will see that the name you search is highlighted in the list box.

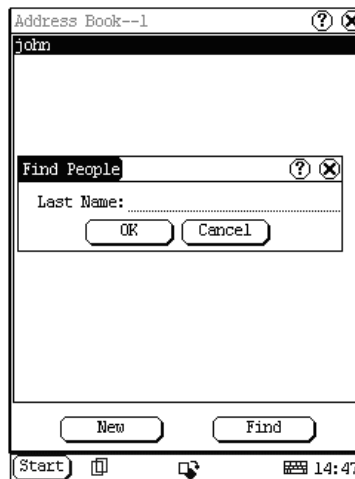

Fig 4-18

**To Do**

The basic functions of To Do include: add new To Do, view To Do, delete To Do and set To Do, etc.

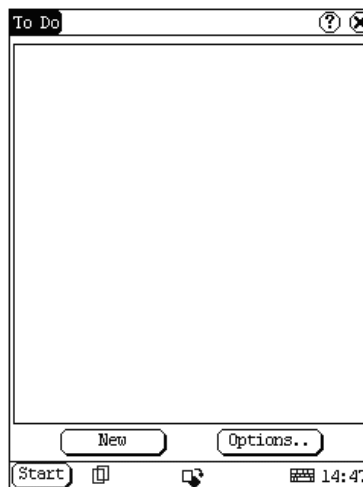

Fig 4-19

- 1) In the pop-up 'PIM' list, select 'To Do' item to open the To Do interface.
- 2) The To Do list of corresponding items will be displayed in the list box on the midst of

the Memo interface.

- 3) Click [Options] button to open the To Do Display interface. (See Fig 4-19)
- 4) Click [New] button to open the To Do New interface.

#### Add New To Do

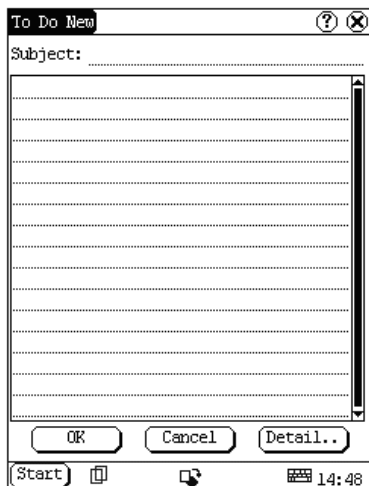

Fig 4-20

- 1) In the To Do interface, click [New] button to open the To Do New interface. See Fig 4-20.
- 2) Activate Soft Keyboard, and fill in the subject and contents.
- 3) Click [Detail] button to open the To Do Detail interface. See Fig 4-21.
- 4) In the To Do Detail interface, click the button to the right of 'Group' to pop up the type list.
- 5) Click the button to the right of 'Expired', and select the data in the pop-up list.
- 6) Click the number to the right of 'Priority' to set the priority of the To Do.
- 7) If the To Do has been finished, please click the box to the right of 'Finished'. When the function is selected, 'X' will be marked in the box,
- 8) Click [OK] button to save and close the To Do Detail interface.
- 9) In the To Do Detail interface, click [OK] button to save and close the To Do New interface.

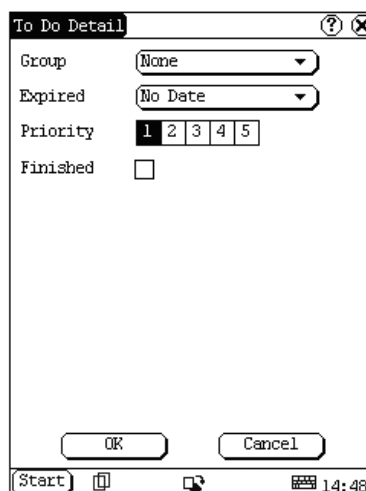

Fig 4-21

#### View To Do

- 1) In the list box of the To Do interface, click the [to do] option that you want to view.
- 2) Then the contents of the To Do will be shown in the opened To Do Edit interface.
- 3) Click [OK] button to close the To Do Edit interface.

#### Edit To Do

- 1) In the list box of the To Do interface, click the memo that you want to edit.
- 2) Then the contents of the memo will be shown in the opened To Do Edit interface.
- 3) Click [Detail] button to open the To Do Detail interface, please refer to step 4~8 in the section "Add New To Do".
- 4) After editing, click [OK] button to save the edited contents and close the To Do Edit interface.

#### Delete To Do

- 1) In the list box of the To Do interface, click to do that you want to delete.
- 2) Then the contents will be shown in the opened To Do Edit interface.
- 3) Click [Delete] button to delete the To Do and close the To Do Edit interface.

#### Edit Type

- 1) Click the [▼] button to the right of 'Group' in the interface so that the type list

- pops up.
- 2) In the type list, select 'Edit Group' to open the Edit Group interface. See Fig 4-22.
- 3) In the Edit Group interface, activate Soft Keyboard.
- 4) In the text box at the bottom of the interface, input the name of the type.
- 5) Click [New] button to add a new type and it will be displayed in the list box of the Edit Group interface.
- 6) Select one type in the list box, and then click [Delete] button to delete it.
- 7) Click [Close] button to close the Edit Group interface.

*The interface ④ : It represents the To Do Detail Interface (Refer to step 1-3 in the section "Add New To Do" and "Edit To Do"), and the To Do Display interface (Refer to step 1 in the section "The Set of Display ").*

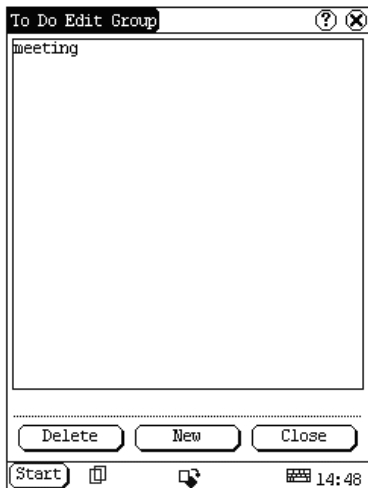

Fig 4-22

The Set of Display

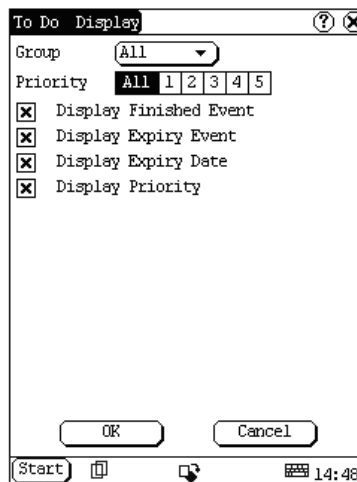

Fig 4-23

- 1) In the To Do interface, click [Options] button to open the To Do Display interface.
- 2) In the To Do Display interface, click the button to the right of 'Group' to pop up type list, and select the type in the pop-up list.
- 3) Click the button to the right of 'Expired', and select the data in the pop-up list.
- 4) Click the number or 'All' to the right of 'Priority' to set the priority of the displayed To Do.
- 5) Click the box to the right of each function. When 'X' is displayed in the box, the function is selected. (See Fig 4-23)
- 6) Click [OK] button to close the To Do Display interface.
- 7) Then you can see the corresponding To Do in the list box of the To Do interface.

Schedule

The basic functions of Schedule include: add new schedule, view schedule, delete schedule, etc.

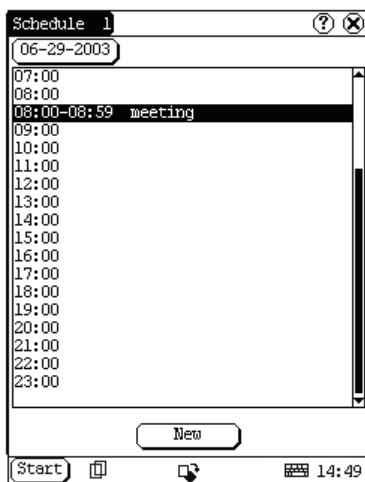

Fig 4-24

- 1) In the pop-up list of 'PIM', select 'Schedule' to open the Schedule interface.
- 2) Click the Date button on the upper left of the interface to open the Select Date interface.
- 3) In the list box in the middle of the interface, all schedules on that day corresponding to the Date button will be displayed. (See Fig 4-24)
- 4) Click [New] button, and then the cycle list pops up. You may select 'Common', 'Daily', 'Weekly', 'Monthly' and 'Annual'.
- 5) In the cycle list, select one item to open the Schedule New interface.

**Add New Schedule**

Set the date of the schedule:

- 1) In the Schedule interface, click the Date button on the upper left to open the Select Date interface.
- 2) In the Select Date interface, click [◀] icon to the left of the month or year to select the previous month or year.
- 3) Click the [▶] icon to the right of the month or year to select the next month or year. (See Fig 4-25)
- 4) Click to select the date in the current month. When it is highlighted, it is selected.
- 5) Or click [Today] button to display the current year, month and date directly.
- 6) Click [OK] button to save the date setting

and close the Select Date interface.

- 7) You may see the date you set on the button on the top right of the Schedule interface.

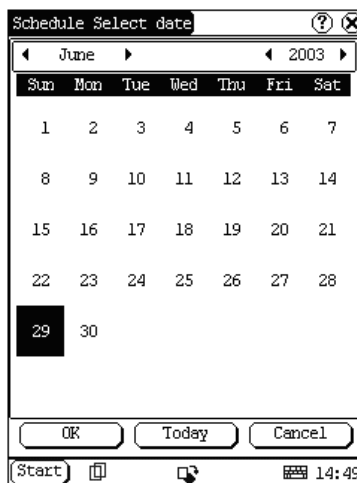

Fig 4-25

Set the cycle of the schedule:

- 1) In the Schedule interface, click [New] button so that the Cycle list pops up. See Fig 4-26.
- 2) In the Cycle list, select 'Common' if it is done on the selected date.
- 3) Select 'Daily' if it is done every day.
- 4) Select 'Weekly' if it is done on a fixed day every week.
- 5) Select 'Monthly' if it is done on a fixed day every month.
- 6) Select 'Annual' if it is done on a fixed day every year.
- 7) After selecting, open the New Schedule interface.



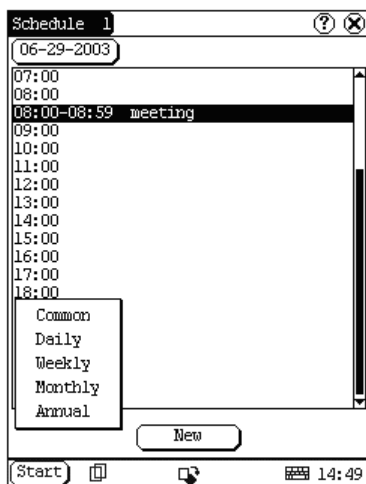

Fig 4-26

Set the content of the schedule:

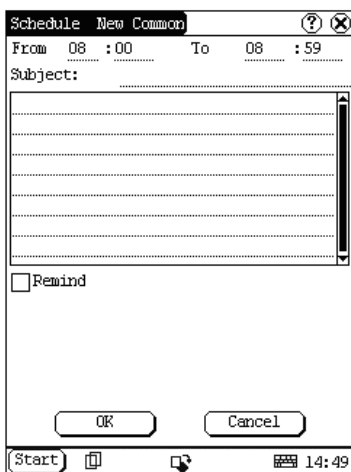

Fig 4-27

- 1) In the Schedule New interface, activate Soft Keyboard, and fill the subject and contents.
- 2) In the textbox on the top of the interface, fill the time of the schedule.
- 3) If the selected cycle is 'Daily', 'Weekly', 'Monthly' or 'Annual', you can input the repeat time in the textbox on the bottom of the interface. See Fig 4-27.
- 4) "Remind" function can be selected and the reminding time can be set in the interface. The "Remind" function will not be available when the machine is turned

off.

- 5) Click [OK] button to save and close the Schedule New interface

**View Schedule**

- 2) In the Schedule interface, select the date that has been scheduled. (Refer to the section "Add New Schedule → Set the date of the schedule")
- 3) In the list box of the Schedule interface, click Scrolling Bar to turn to next page, and click the schedule you want to view.
- 4) Then the contents of the schedule will be shown in the opened Schedule View interface.
- 5) Click [OK] button to close the Schedule View interface.

**Edit Schedule**

- 1) In the Schedule interface, select the date that has been scheduled. (Refer to the section "Add New Schedule → Set the date of the schedule")
- 2) In the list box of the Schedule interface, click Scrolling Bar to turn to next page, and click the schedule you want to edit.
- 3) Then the contents of the schedule will be shown in the opened Schedule View interface.
- 4) If the edited affair is 'Daily', 'Weekly', 'Monthly' or 'Annual', you can edit the repeat time in the textbox on the bottom of the interface.
- 5) After editing, click [OK] button to save the edited contents and close the Schedule View interface.

**Delete Schedule**

- 1) In the Schedule interface, select the date that has been scheduled. (Refer to the section "Add New Schedule → Set the date of the schedule")
- 2) In the list box of the Schedule interface, click Scrolling Bar to turn to next page, and click the schedule you want to edit.
- 3) Then the schedule will be shown in the opened Schedule View interface. See Fig 4-28.
- 4) Click [Delete] button to delete it and close the Schedule View interface.

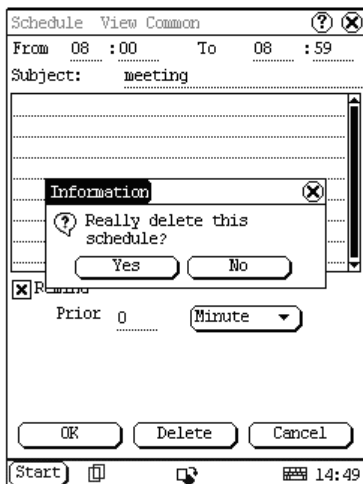

Fig 4-28

## System

### Control Panel

The control panel includes all interrelated software and hardware configurations. It makes the software more custom-built for you by configuring.

- 1) Click [Start] button.
- 2) Select 'Control Panel' in the pop-up menu.
- 3) Open the Control Panel interface. (See Fig 4-29)

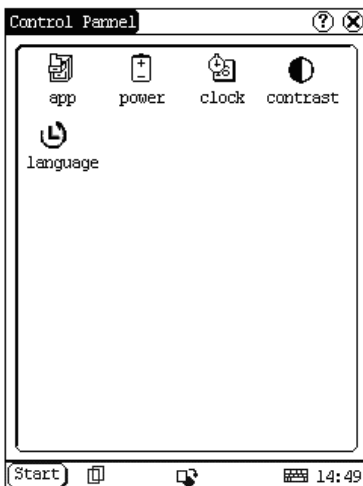

Fig 4-29

### Application

It displays the application information contained in the 'Start' menu, including the group name, the submenu, etc.

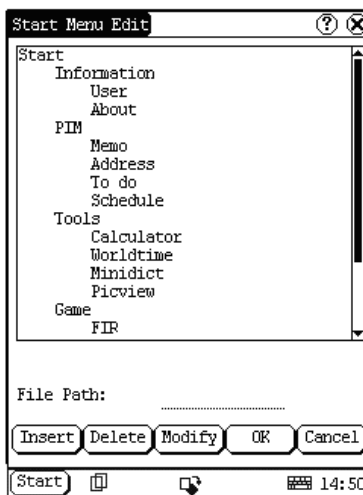

Fig 4-30

- 1) In the Control Panel interface, click 'App' icon to open the Application Manager interface.
- 2) Then you can see the corresponding information in the list box of the interface. (See Fig 4-30)
- 3) Insert a new group:  
Click [Insert] button and input the item name. Then choose "Start" as its parent and click [OK] button.



Fig 4-31

- 4) **Insert a new submenu:**  
Click [Insert] button and input the item name and the file path. Then choose a group as its parent and click [OK] button. The path can be inputted directly or found out in a dialogue box after clicking [Browser] button. See Fig 4-31 and Fig 4-32. Click [OK] button after selecting an item in the list. Then the selected file will be automatically copied to the edit box.  
  
The submenu should be linked to a present group instead of the "Start" item or another submenu.
- 5) **Delete a group or a submenu:**  
Select a group or a submenu and then click [Delete] button. When a group is deleted, all of its submenus will be deleted.
- 6) **Modify a group or a submenu:**  
Click [Modify] button and then select the group or submenu from the list. Now you can modify the item name, file path and so on followed by clicking [OK] button.
- 7) **Save the information:**  
After editing the application, click [OK] button. The modified information will be saved in the corresponding file. If you want to quit the modification, click [Cancel] button.

**Note:**  
*Quit all other applications before saving the modification.*

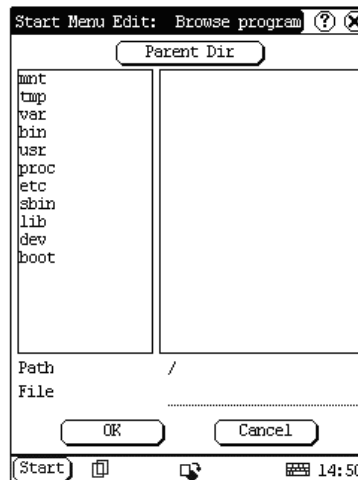

Fig 4-32

#### Power Management

In the Power Manager interface, you can see the condition of memory, and set the standby time. (See Fig 4-33)

- 1) In the Control Panel interface, click 'Power' icon to open the Power Manager interface.
- 2) Click the button to the right of 'Standby time', and select the time or 'None' in the pop-up list.
- 3) Click [OK] button to save the setting and close the Power Manager interface.

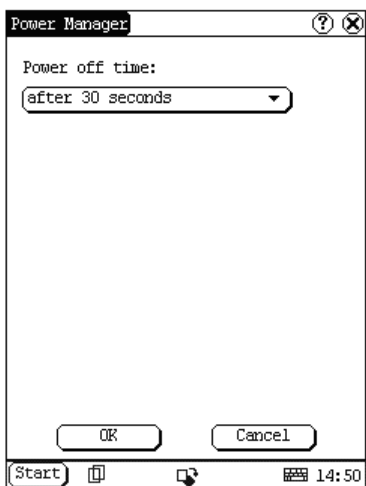

Fig 4-33

**Clock**

User can set the time and the time zone of the system.

set 'Hours', 'Minutes' and 'Seconds' directly.

- 5) Click [OK] button to save and close the Set Time interface.

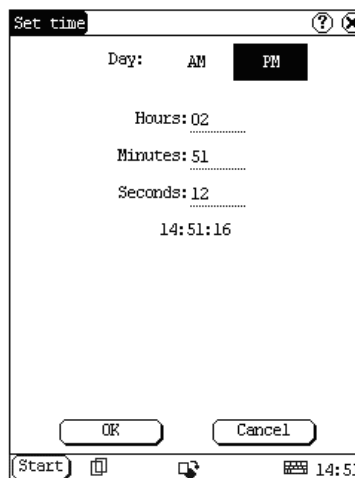

Fig 4-35



Fig 4-34

**Set Time:**

- 1) In the Control Panel interface, click 'Clock' icon to open the Date/Time interface as shown in Fig 4-34.
- 2) In the Date/Time interface, click [Set Time] button to open the Set Time interface as shown in Fig 4-35.
- 3) Click the characters to the right of 'Day' to set AM and PM, the selected one will be highlighted.
- 4) Activate Soft Keyboard, and then you can

**Set Date:**

- 2) In the Date/Time interface, you can set date directly.
- 3) Click [◀] icon to the left of the month or year to select the previous month or year.
- 4) Click the [▶] icon to the right of the month or year to select the next month or year. (See Fig 4-34)
- 5) Click the date in the current month. It will be highlighted when it is selected.
- 6) Click [Set Time] button to save the setting.
- 7) Click [Quit] button to exit.

**Set Time Zone**

- 1) In the Date/Time interface, click [Set Time zone] button to open the Set Zone interface as shown in Fig 4-36.
- 2) Click Scrolling Bar to turn to next page of the list, and select your zone. It will be highlighted when it is selected.
- 3) Click [OK] button to save and close the Set Zone interface.



Fig 4-36

After finishing all settings, click [OK] button in the Date/Time interface to exit and close the interface.

**Contrast**

It is for adjusting the contrast of the screen to make the interface clearer.

- 1) In the Control Panel interface, click 'Contrast' icon to open the Contrast interface. See Fig 4-37.
- 2) In the Contrast interface, click the position you want, and then you can set it.

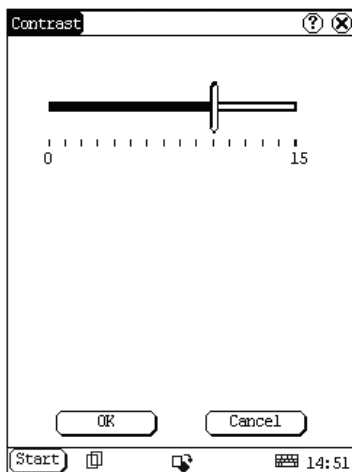

Fig 4-37

**Language**

You can make selection among several languages for convenient operation of the system.

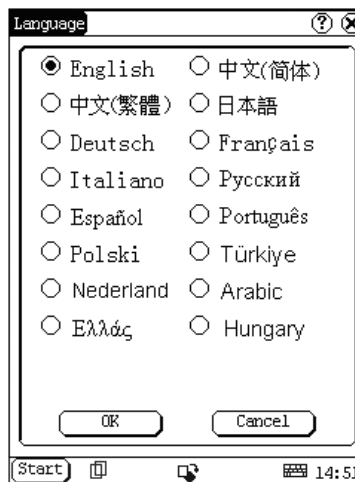

Fig 4-38

- 1) In the Control Panel interface, click 'Language' icon to open the Language interface. See Fig 4-38.
- 2) Select the language you want to use.
- 3) Click [OK] button to confirm the selection and close the language interface and the Control Panel interface.

*Note: Before selecting language, be sure to quit all applications.*

**System Information**

**Calibrate Touch Screen**

It is for getting the desired accuracy of the touch screen. Calibrating of touch screen can be divided into two steps. The first step is to detect noise automatically. If you click the touch screen at this step, the noise value would be affected. After detecting the noise, the system will come to the calibration step. Then the cross cursor will be displayed.

- 1) After switching on the machine, follow the tips to press the hot key. The calibration interface will be opened.
- 2) Click the cross cursor on the screen

accurately, and wait until it changes. Then one step of calibration is finished.

- 3) After calibration is finished for all corners, the system will automatically return to the start-up main interface.

**Note:**

- ◆ Do not click the touch screen before the cross cursor appears.
- ◆ In the calibration step, if you fail to click the cross cursor accurately, the cross cursor will be displayed on the screen again and again until the calibration is finished completely.

**User Register**

The user's right can be well protected after registration.

- 1) Click [Start] button.
- 2) Select 'Information' in the pop-up menu.
- 3) Select 'User' in the pop-up list to open the User Information interface. (See Fig 4-39)
- 4) In the User Information interface, activate Soft Keyboard, and input the user information. (See Fig 4-40)
- 5) Click [OK] button to save the information and close the User Information interface.

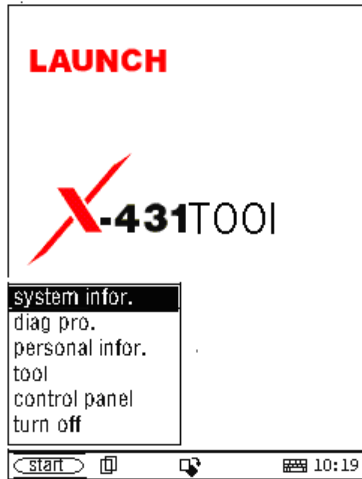

Fig 4-39

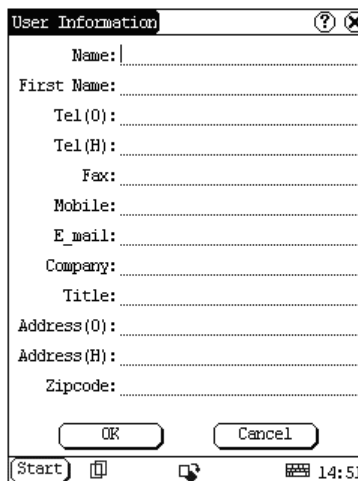

Fig 4-40

**About**

In 'Information' list, click 'About', the screen will display the information about system software and hardware. Then click [OK] button to close it. (See Fig 4-41)

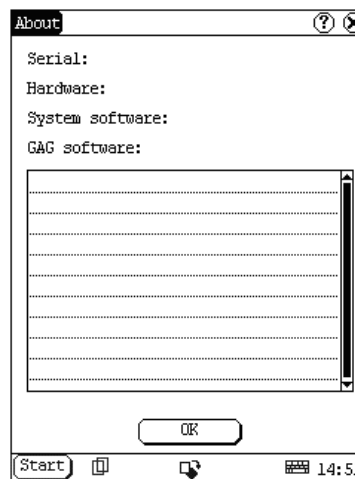

Fig 4-41

**Shut Down**

Click "Shut Down" in the Start menu when you attempt to turn off the machine.

## FAQ

X-431TOOL is a hi-tech product. With the development of modern automotive industry, more and more new technology will be adopted and there may be questions during operation. Read the user's manual to get the answer whenever you have any question, or contact our Customer Service Center for help.

Here we list some frequently asked questions and answers relating to X-431TOOL.

### About Update via Internet

**Question:** "Removable Disk" icon does not appear in the catalogue of "My computer" after the CF card reader is connected to the USB port of computer. Why?

**Answer:**

**Possible cause:** there may not be driver for CF card reader in the computer. The default driver is with the operating systems like Windows Me/2000/XP, Mac OS 9.x/Mac OS X and Linux 2.4.X. However, there is no such default driver with Windows 98.

**Solution:** Check if there is the driver for CF card reader in the computer. If the computer uses Windows 98 operating system, it is necessary to install the driver into computer by using the CD-ROM provided with CF card reader.

When the CF card reader driver is installed successfully, a "Removable disk" icon will appear in the catalogue of "My computer". Usually it is listed after original disk drive. For example, if there were drives A, B, C and D originally, the removable disk will be "E". If there were drives A, B, C, D and E originally, the removable disk will be "F". The rest may be deduced by analogy.

**Question:** Some downloaded diagnostic program is not listed in the update tool, what is the reason?

**Answer:** There are two possible causes:

1. The downloaded diagnostic program is not put in the same folder as other diagnostic programs. Please move it to the same folder as others.
2. The diagnostic program is not fully downloaded. Please download the program again.

**Question:** When the updated software is used in vehicle diagnosis, some diagnostic program can not be downloaded successfully from the CF card. Why?

**Answer:** possible causes and solutions:

1. The Display Program may have not been updated. Please update the Display Program.
2. The diagnostic program for the vehicle make is damaged. Please re-download the diagnostic program and update.

**Question:** Why can't the main unit recognize the replaced CF card?

**Answer:** There are two possible causes:

1. The original CF card has not been fully copied. Please delete the incomplete file and copy again.
2. The CF card reader is not compatible with the CF card. Monofunctional CF card reader is better in such situation.

**Question:** How to make a new X-431TOOL CF card when the data in old one is lost or damaged?

**Answer:** In case X-431TOOL CF card is damaged and the program in the card can not be used, please use the following procedure to make a new CF card:

1. Log onto the website "www.X431.com". Enter your username and password to log in.

Select the DIAGBOX No., and then download the following programs into your computer:

- 1) Necessary programs for making CF card:

- X-431 UPDATE TOOLS---- for writing the program from computer to CF card when doing X-431 update
  - DISPLAY PROGRAM---- for displaying the X-431 diagnostic information and managing the X-431 diagnostic programs
- 2) Optional programs that can be selected according to user's demand:  
Diagnostic program for various vehicles
  2. Install the X-431 UPDATE TOOLS into computer.
  3. Format the X-431 CF card.
  4. Run the X-431 UPDATE TOOLS and write the display program and diagnostic programs onto CF card.

## About Hardware

**Question:** After X-431TOOL downloads the diagnostic program from the CF card, it prompts "Please contact your local dealer". What is the reason?

**Answer:** It is because the license No. in CF card does not match the DIAGBOX. It can be solved in the following way:

1. Download the software that is corresponding to the DIAGBOX so that the CF card can match the DIAGBOX.
2. Use the UPDATE TOOL that is provided on <http://www.X431.com> for update. Never use WINZIP or other decompressing tool for update.

**Question:** Why does the LCD screen respond so slowly?

**Answer:** It is because the ambient temperature is close to the lower limit of operating temperature range (0-50°C). In this situation, it is necessary to warm up the machine for 20 minutes before test.

**Question:** Power can not be turned on with the power button on the main unit after the machine

is connected to vehicle diagnostic socket through cables and connectors. What can I do?

**Answer:** Check the power pin of vehicle diagnostic socket with multimeter for power. The power pin in diagnostic socket varies from one vehicle to another. Please refer to the User's Manual of specific vehicle diagnostic program to find the power pin. If there is no power supply from the diagnostic socket, please get power in other ways, such as from battery or cigarette lighter.

**Question:** There is no character on the backlit screen. What should I do?

**Answer:** Check if the power is well connected. Turn off the machine, unplug the power connector and re-plug it. Turn on the machine after it has been connected to the power for 1 second.

**Question:** Why can't the diagnostic program be downloaded to DIAGBOX?

**Answer:** Please make sure that the DIAGBOX is well connected with X-431TOOL main unit.

**Question:** Why does X-431TOOL fail in communication with ECU?

**Answer:** Please make sure that the diagnostic connector and diagnostic program are matching vehicle make.

**Question:** The screen keeps blank after flashing when the machine is turned on. What should I do?

**Answer:** Take out the CF card and re-start the machine to see if there is normal display. If the display is normal when the CF card is taken out, the CF card should be replaced. If the screen is still blank, please contact the local service engineer.

**Question:** Why does the system prompt that no CF card is found when the machine is turned on?



**Answer:** The possible cause is that no CF card is in the machine, or CF card is inserted improperly or damaged. If it is damaged, it is necessary to make a new one.

**Question:** What should I do if I can't get into the diagnostic interface during test?

**Answer:** The possible cause is that no CF card is in the machine, or CF card is inserted improperly or damaged. If it is damaged, it is necessary to make a new one.

**Question:** Program is not run or screen is confused after glints. What should I do?

**Answer:** Unplug the 9-pin connector on the main unit and re-plug it.

**Question:** What can I do if the system halts or fails during self-detection?

**Answer:** Please make sure that cables and CF card are well connected.

**Question:** Why can't the data be inputted after Soft Keyboard is activated?

**Answer:** The position where the cursor lies can't be edited. Or you have not activated the cursor on the input position. Please use the stylus to click the part to edit. When the cursor twinkles, you can input the data.

**Question:** The screen is inactive after the cross cursor appears on the screen. Why?

**Answer:** The system is calibrating the touch screen. The machine will work after the screen is calibrated. Refer to the section "Calibrate Touch Screen" in User's Manual".

**Question:** Why does the saved data disappear?

**Answer:** There are two possible causes:  
 1. Your CF card is damaged.  
 2. You've changed language and the data is related to language. You may find the data after switching back to the former language.

**Question:** How to know what applications (interfaces) are opened.

**Answer:** Click the active taskbar icon, then the pop-up list will display the applications (interfaces) opened.

**Question:** Why can't I do operation in current interface?

**Answer:** There are two possible causes:  
 1. Your current interface has exited illegally. In this situation, you may not see the name of the application (interface) in the pop-up list when you click the active taskbar icon.  
 2. The system is busy, please wait patiently, or click the active taskbar icon to switch to another application.

**Question:** The listed icons of vehicle make occupy more than one page of screen. I may have to turn several pages to find a specific icon of vehicle make. How can it be simplified?

**Answer:** X-431TOOL can test many vehicle makes and the vehicle makes are still increasing. We have considered the convenience when designing the software. The system will count the clicks and move the icon with more clicks forward.

## About System Setting

**Question:** The screen is too white and characters can not be seen. What is the reason and what should I do?

**Answer:** It may be caused by improper contrast. Please refer to the section "Contrast" to adjust the contrast.

**Question:** The screen is inactive after the cross cursor appears on the screen. Why?

**Answer:** The system is calibrating the touch screen. The machine will work after the screen is calibrated. Refer to the section "Calibrate Touch Screen" in User's Manual".

**Question:** The screen does not respond or responds wrongly when I click it with stylus. What should I do?

**Answer:** It is necessary to calibrate the screen. Please refer to the section "Calibrate Touch Screen" in User's Manual.

**Question:** The time displayed in the lower right corner of the screen is incorrect. How to adjust it?

**Answer:** It is because the time was set incorrectly. Please refer to the section "Clock" in the User's Manual to set correct time.

## About Operation

**Question:** System halts when reading data stream. What is the reason?

**Answer:** It may be caused by a slackened connector. Please turn off the machine, firmly connect the connector, and switch on the machine again.

**Question:** Why is the screen inactive when the cross cursor is clicked during screen calibration?

**Answer:** You may have touched the screen when the system is detecting noise before the cross cursor appears. Please turn off the machine and then turn on. Calibrate the screen after the cross cursor appears.

**Question:** Why is the machine automatically powered off during standby?

**Answer:** It is because the machine has been set for energy saving. Automatic shutdown will take place if the machine is not operated for a specified period of time. Refer to the section "Power management" in User's Manual to set the "Power off time" to "None" or select a longer standby time.

**Question:** Why can't the tested result be printed out?

**Answer:** There may be no paper in the printer or the printer is not well connected. Please mount a roll of new paper. See the section "Printer Operation" in the User's Manual.

**Question:** Why is there no character in the printed paper?

**Answer:** The paper is mounted reversely. Please take out the paper and mount it again. See the section "Printer Operation" in the User's Manual.

**Question:** Why can't I input data after activating Soft Keyboard?

**Answer:** The position where the cursor lies can't be edited. Or you have not activated the Ocursor on the input position. Use the stylus to click the part to edit. When the cursor twinkles, you can input the data.

**Question:** What should I do if I am not able to switch from Active Taskbar to the running application interface?

**Answer:** Please close interfaces related to the application, such as the Help or Detail.

**Question:** Why does the saved data disappear?

**Answer:** There are two possible causes:  
 1. Your CF card is damaged. It is necessary to make a new CF card.  
 2. You've changed language and the data is related to language. You may find the data after switching back to the former language.

**Question:** What can I do when the screen is confused?

**Answer:** Please quit the current application (interface), and run it again. If the problem still exists, please restart the system.

**Question:** How to know what applications (interfaces) are opened.

**Answer:** Click the active taskbar icon, then the

pop-up list will display the applications (interfaces) opened.

**Question:** Why can't I do operation in current interface?

**Answer:** There are two possible causes:

1. Your current interface has exited illegally. In this situation, you may not see the name of the application (interface) in the pop-up list when you click the active taskbar icon.
2. The system is busy, please wait patiently, or click the active taskbar icon to switch to another application.

analysis.

**Question:** Why are there too many trouble codes?

**Answer:** It may be caused by poor contact or poor grounding. Make sure that the vehicle model/year is selected correctly and the vehicle is equipped with the system.

## Questions Related to Vehicle

**Question:** Why does the screen flickers during engine starting?

**Answer:** It is caused by the electromagnetic interference. No problem with X-431TOOL.

**Question:** Why is operation interrupted during diagnosis?

**Answer:** It may be caused by electromagnetic interference or incorrect connection of connector.

**Question:** Why is there no response from vehicle ECU at communication?

**Answer:** Make sure that the voltage of vehicle battery, ignition timer and idle speed are in standard range; the throttle is in the closed position; and all electric devices, such as A/C, headlight, stereos etc, are turned off. Refer to the section "Conditions for Test".

**Question:** Some systems can not be diagnosed. Why?

**Answer:** The diagnostic socket for the system on some early vehicle may be separated. Refer to the vehicle instruction manual.

**Question:** No trouble code is found. Why?

**Answer:** It may be caused by the shared circuit. Find the nearest trouble code and circuit for

## About ECU

In the last two decades, we have seen more and more extensive application of IT and electronic technologies in modern vehicles. Many vehicle control systems, typically EFI (Electronic Fuel Injection), ABS (Anti-block Braking System), SRS (Air Bag), TC (Traction Control), AT (Automatic Transmission), etc., are computerized. Computerization makes the control precisely, quickly, effectively and safely. Consequently, a significant progress in vehicle driveability, fuel economy, power performance, comfortability, emissions, safety and so on has been made.

## Composition and Working Principle of Computer-Control System

The Computer Control System consists of the on-board computer, and several related control devices (sensors, switches, and actuators). Most on-board computers are located inside the vehicle behind the dashboard, under the passenger's or driver's seat, or behind the right kick panel. Some manufacturers may still position it in the engine compartment. The sensors, switches, and actuators are devices such as oxygen sensors, coolant temperature sensors, throttle position sensors, fuel injectors, etc., that are located throughout the engine, and are connected by electrical wiring to the on-board computer. As an example, the diagram of engine control system is shown in Fig 6-1.

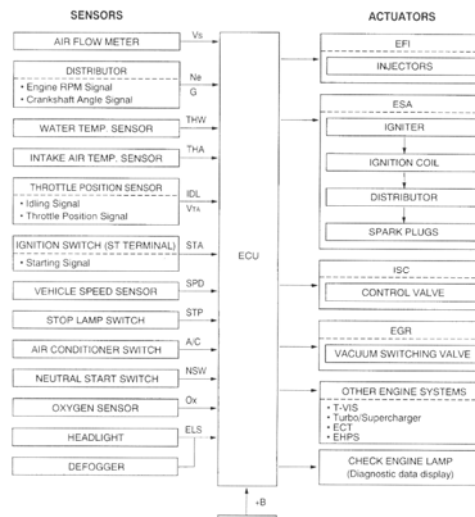

Fig 6-1

### Sensor

It is a device that converts non-electric variable into electric signal. More than 50 types of sensor are used in modern vehicles, most of which are found in powertrain, chassis control systems, body control system, safety system, etc.

According to the physical variables controlled, sensors are sorted into following types: temperature sensor, pressure sensor, air flow sensor, position/angular sensor, gas concentration sensor, rotary speed sensor, acceleration sensor, vibration sensor, light sensor, distance sensor, electrical current sensor, angular speed sensor, shaft sensor, liquid level sensor, etc.

The commonly-used sensors in corresponding control systems of vehicle are:

- 1) In engine management system: intake air pressure (or air flow), air/fuel ratio, crankshaft position, knock, RPM, intake air temperature, coolant temperature and O<sub>2</sub> sensors.
- 2) In transmission system: vehicle speed, throttle position, RPM, A/T output shaft speed, torque, oil pressure/temperature, shift position sensors.

- 3) In braking system: vehicle speed, wheel speed, deceleration, sliding rate, braking pedal force, braking pedal position sensors, etc.
- 4) In steering control system: steering, vehicle acceleration, vehicle speed sensors, etc.
- 5) In suspension system: vehicle speed, vehicle height, steering angle, throttle position, braking force sensors, etc.
- 6) In A/C system: external temperature, internal temperature, sunshine, coolant temperature, refrigerant pressure and humidity sensors, etc.
- 7) In instrument, alarm and diagnosis systems: remaining fuel, coolant temperature, oil pressure, oil status, intake air pressure, windshield washer fluid level, battery liquid level, door lock, braking fluid level sensors.

into electrical parameter.

- 2) A/D converter: it converts the analogue signal from the sensor into digital signal. Then the digital signal can get into SMC.
- 3) SMC: it consists of I/O interface, CPU, RAM/ROM, etc. The received digital signal is computed here with the pre-programmed parameters from ROM. The computed result is transmitted through I/O interface to the output circuit, and then to the corresponding actuators.

The data in ROM is written by manufacturer and will not be lost when power is off. However, the data in RAM will be lost when power is off.

- 4) Output circuit: it is to amplify the signal from SMC. The weak current from SMC is not able to activate the actuator. So it has to be amplified.

**ECU**

The electronic control unit is composed of input circuit, A/D converter, SMC, output circuit, etc. See Fig 6-2.

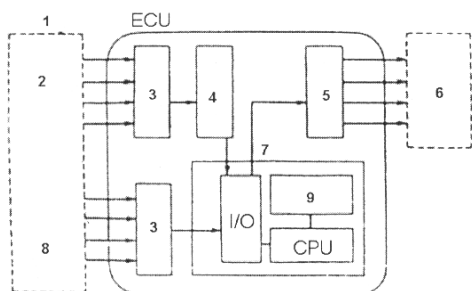

Fig 6-2

- |                  |                   |                   |
|------------------|-------------------|-------------------|
| 1- Sensor        | 4- A/D converter  | 7- SMC            |
| 2- Analog signal | 5- output circuit | 8- Digital signal |
| 3- Input circuit | 6- Actuator       | 9- ROM/RAM        |

- 1) Input circuit: digital signal from sensor will enter the CPU directly. However, the analogue signal will be treated in the A/D converter before getting into CPU. The input circuit filters out the noise, converts sine wave into rectangular wave and then

**Actuator**

Actuator is to convert the electrical signal into force or displacement. The popular actuators are listed below:

- 1) Solenoid valve: This actuator is to convert electrical signal into linear movement. Two types of solenoid valves are used in the vehicle. One is directly driven with linkage, e.g. the magnetic switch of starter motor. The other is for controlling pressure and flow by transferring the movement to relevant valves. For example, in engine intake air control, electronically controlled automatic transmission, suspension control, etc.
- 2) Motor: DC motor is the most popular actuator used in automobile. It can be divided into two types according to its use. One is rotated by power, e.g. windshield wiper, seat adjuster, etc. The other is used in servo mechanism. In this situation, external force makes the rotor rotate around the stator, e.g. the servo motor for

damper.

Besides the two types listed above, there are other types, such as relay, electronic switch, etc.

## Self-diagnosis of Electronic Control System

All modern cars are controlled by an Electronic Control Unit (ECU). The main purpose of the electronic control system is to provide maximum engine performance with the least amount of air pollution and the best fuel efficiency possible. However, the complexity of the system may increase the difficulty for its troubleshooting. The function of self-diagnosis is for solving such problem with electronic control system.

### Working Principle of Self-diagnosis

The composition of self-diagnosis system is similar to electronic control system. The basic component is electronic control unit. The main purpose of self-diagnosis system is to diagnose the sensors, actuators, circuits and ECU in vehicle.

The computer assigns a numeric code for each specific problem that it detects, and stores these codes in its memory for later retrieval, and turns on the fault indicator on the dash panel to warn the driver. The problem detected may be: inputted/outputted signal exceeds the specified range, or some circuit is short-circuited or open.

Now let's take gasoline injection control system as an example to describe the working principle of the self-diagnosis system. When problem occurs, the process of diagnosis and treatment will be as follows:

#### 1) For sensor

If the output signal from the sensor is out of the specified range of voltage when engine is running, it will be deemed as fault. For example, the normal output voltage from coolant temperature sensor should be in the range of

0.3-0.4V. If not, the situation will be deemed as fault and fault code will be stored in memory. Self-diagnosis system can detect damaged sensor, or short/open circuit, but it can not appraise the performance of sensor. Occasional occurrence of abnormal signal will not be deemed as fault immediately. For not being interrupted by the sensor fault, the engine will be controlled by the pre-stored normal coolant temperature (e.g. 80°C) from the self-diagnosis system.

#### 2) For actuator

When the engine is running, ECU sends commands to actuators according to the practical situation. If the actuator can not work normally, the monitoring circuit will transmit the message to the ECU. ECU can make the message displayed and take measures to ensure the safe running of engine. For example, when the power tube in engine ignition system is out of order, the ignition monitoring circuit sends feedback to the ECU. ECU emits warning signal and sends commands to actuator for stopping injection so as to prevent the unburnt mixture from damaging the catalytic converter of exhaust system.

#### 3) For ECU

There is no monitoring circuit, but a monitoring clock in the ECU for resetting ECU regularly. If ECU is out of order, its program will not be run and the clock will not reset the ECU so that overflow may occur. This situation is deemed as fault for displaying.

For preventing unexpected stopping of vehicle caused by problem with ECU, there is a backup circuit in ECU. When the backup circuit receives the signal of abnormality from the monitoring circuit, a spare control program will be started for keeping the engine running as pre-programmed.

### Readout of Fault Code in Automotive Self-diagnosis System

The fault in vehicle electronic system is stored in KAM of ECU as fault code. The fault code can be read out by the on board diagnostic

system or external scan tool.

The on board diagnostic system in different vehicle may indicate the fault in different way. In general, the following ways are popular:

- 1) Blinking of fault indicators on the instrument panel
- 2) Swing of multimeter index
- 3) Blinking of red/green LED on ECU
- 4) Shown by a special device

The more intuitionistic way for showing the fault is by external scan tool.

The diagnostic system of modern cars is equipped with diagnostic socket or DLC (data link connector). Fault code in vehicle ECU can be read out by connecting a scan tool to the diagnostic socket. In early time, each vehicle system had its own type of diagnostic socket. Since 1996, SAE has specified a uniform system called OBDII on board diagnostic system. Each vehicle that is made in accordance with the system may have the same diagnostic socket, same definition of pin and same description of fault code. The control units of every system are connected to bus, so only one diagnostic socket is needed for readout of fault code. OBD provides the possibility of reading data stream and displaying working status of switches and actuators. Moreover, external scan tool can send commands to activate the actuators.

X-431TOOL is such an external scan tool for vehicle diagnosis. It not only has the diagnostic function like reading fault code, reading data stream, actuation test, displaying sensor waveform, coding control unit, etc., but also has PDA function.

## Basic Knowledge of ECU

### Composition of Vehicle ECU

Vehicle ECU consists of ALU, CPU, power source and memory.

#### 1. ALU

It converts the electronic signal from each

sensor into digital signal needed by CPU.

#### 2. CPU

The digital signal is transferred to CPU for computation and logical operation so that correct air/fuel mixture can be obtained. CPU can also compute ignition timing and idle speed, and control exhaust, fuel and diagnostic systems.

#### 3. Power source

The reference output signal (5V) of ECU and the 12V voltage for control module are from vehicle battery. Memory is also dependent on the power supplied by the battery.

#### 4. Memory

ECU contains three types of memory: ROM, RAM and PROM (or EEPROM).

##### 1) ROM

ROM stores the programming information that can only be read by ECU. The program in ROM is not editable. Power cut will not damage the data in ROM.

##### 2) RAM

It is for temporarily storing the inputted data, fault code and computed result. Power cut will make all information in RAM erased.

##### 3) PROM

Its program is made by manufacturer to suit the application of transmission, engine, exhaust control, driveability, rear axle ratio, etc. PROM is can be detached from ECU and power cut will not damage the data in it.

##### 4) EEPROM

Its function is similar to PROM. The difference between EEPROM and PROM is that EEPROM can be re-programmed by manufacturer with a special device.

### Precautions Related to ECU

The circuit inside the ECU is very accurate and may be easily damaged by overvoltage, static electricity and/or magnetic fields. Pay more attention when diagnosing the devices that is

connected to ECU because most ECU's are operated under low voltage (about 5V).

Whenever you work in the vicinity of ECU or engine control system, please obey the following precautions:

1. Never damage the lead or connector. Prevent them from being grounded or contacting with an unexpected power source.
2. Never use the electrical test tool that is powered by 6V battery or over. Strong current may cause the element in ECU broken or shorted. For checking the engine control circuit, only the multimeter with large internal impedance (over 10M $\Omega$ ) can be used.
3. Never try to disassemble or repair ECU if there are not necessary tools and information. Any mistake may damage the component or increase the difficulty for service station.
4. The spark plug wire must be at least 25.4mm from any sensor circuit or control circuit. Some unexpected fault in ECU circuit is caused by magnetic fields that transmit wrong signal to ECU. High tension wire or transformer may interfere with ECU, but the most common cause for such problem is that the spark plug is too close to ECU harness.
5. Be careful when moving ECU or working around ECU. Remember that static electricity may cause strong electrical shock and damage ECU.



## Appendix: X-431 TOOL Connectors and Sockets Location

Model	Connectors	Socket Location
OBDII	[SMART OBD II -16E] diagnostic connector	OBD II -16 socket is often under instrument panel. The location will be different as different model.
HYUNDAI	1. [MITSUBISHI/ HYUNDAI -12+16] diagnostic connector 2. [SMART OBD II -16E] diagnostic connector	<ul style="list-style-type: none"> <li>● HYUNDAI socket is often under the instrument panel by the driver's side.</li> </ul>
DAEWOO	[DAEWOO-12] diagnostic connector [SMART OBD II -16 E] diagnostic connector	<ul style="list-style-type: none"> <li>● DAEWOO -12 socket is often under the steering wheel column in the compartment, or under instrument panel by the passenger's side or other place.</li> <li>● OBD II -16 trapeziform socket is under instrument panel.</li> </ul>
KIA	1. [KIA-20] diagnostic connector 2. [SMART OBD II -16E] diagnostic connector	<ul style="list-style-type: none"> <li>● KIA-20 socket is in the right of engine compartment.</li> <li>● OBD II -16 trapeziform socket is often under the instrument panel.</li> </ul>
HONDA	1. [HONDA-3] diagnostic connector 2. [SMART OBD II -16E] diagnostic connector	<ul style="list-style-type: none"> <li>● In left bottom of instrument panel.</li> <li>● In the storage box under instrument panel.</li> </ul>
TOYOTA	1. [TOYOTA-17F] diagnostic connector 2. [TOYOTA-17] diagnostic connector 3. [SMART OBD II -16E] diagnostic connector	<ul style="list-style-type: none"> <li>● TOYOTA-17F quadrate socket is often in the engine compartment.</li> <li>● TOYOTA-17 semicircle socket is in left bottom of instrument panel.</li> <li>● OBD II -16 socket is often under the steering wheel column in the compartment.</li> </ul>
NISSAN	1. [NISSAN-14+16] diagnostic connector 2. [SMART OBD II -16E] diagnostic connector	<ul style="list-style-type: none"> <li>● Sockets are often in the left of radio under instrument panel.</li> </ul>
SSANGYONG	1. [SSANGYONG -20] diagnostic connector 2. [SSANGYONG -14] diagnostic connector	<ul style="list-style-type: none"> <li>● [SSANGYONG -20] diagnostic connector socket is in the rear of the engine next to wiper.</li> <li>● [SSANGYONG-14] diagnostic connector circle socket is in the head next to front seat.</li> </ul>
CITROEN	1. [CITROEN-2] diagnostic connector 2. [SMART OBD II -16E] diagnostic connector	<ul style="list-style-type: none"> <li>● In the left of engine in engine compartment.</li> </ul>
DAIHATSU	[DAIHATSU-4] diagnostic connector	<ul style="list-style-type: none"> <li>● Under instrument panel.</li> </ul>

MITSUBISHI	1.[MITSUBISHI/HYUNDAI-12+16] diagnostic connector 2. [SMART OBD II -16E] diagnostic connector	<ul style="list-style-type: none"> <li>● MITSUBISHI socket is under instrument panel by the driver's side.</li> </ul>
Renault	[SMART OBD II -16E] diagnostic connector	<ul style="list-style-type: none"> <li>● Sockets are in the left bottom of instrument panel of driver's seat.</li> </ul>
OPEL	[SMART OBD II -16E] diagnostic connector	<ul style="list-style-type: none"> <li>● OPEL socket is in compartment. It will be in different location as different model: under instrument panel, under steering wheel column, between cigar lighter and radio, or under board behind shift column.</li> </ul>
FIAT	[FIAT-3] diagnostic connector	<ul style="list-style-type: none"> <li>● Under steering wheel.</li> </ul>
BMW	1. [BMW-20] diagnostic connector 2. [SMART OBD II -16E] diagnostic connector	<ul style="list-style-type: none"> <li>● 80-90 BMW socket is in the right of engine compartment.</li> <li>● 525i&amp;535i socket is in the right or left of engine compartment.</li> <li>● 325&amp;635i socket is under instrument panel.</li> <li>● BMW 735i socket is in the left of engine compartment, 20PIN</li> </ul>
MERCEDES BENZ	1. [MERCEDES BENZ-38] diagnostic connector 2. [SMART OBD II -16E] diagnostic connector 3. 16PIN quadrate socket&8PIN quadrate socket [UNIVERSAL-3] diagnostic connector  <i>Note: for [UNIVERSAL-3] diagnostic connector, connect red end to power; black to ground; yellow to signal cable.</i>	<ul style="list-style-type: none"> <li>● Benz A160&amp;OBD II -16 socket is under instrument panel by driver's side.</li> <li>● BenzC180&amp;202 chassis, MERCEDES BENZ-38 socket is right behind of engine compartment.</li> <li>● Benz S320 , 220 chassis , OBD II -16 socket, under instrument panel.</li> <li>● Benz S320 140 chassis , MERCEDES BENZ-38 socket, under the right side lid of engine compartment.</li> <li>● Benz 560SEL 129 chassis, MERCEDES BENZ-38 socket, in the right side of engine compartment.</li> <li>● Benz 300SEL 140 chassis, MERCEDES BENZ-38 socket, in the right side of engine compartment.</li> </ul>
MAZDA	1. [MAZDA-17] diagnostic connector 2. [SMART OBD II -16E] diagnostic connector	<ul style="list-style-type: none"> <li>● MAZDA-17 semicircle socket is in the left side of engine in the engine compartment.</li> <li>● Next to brake main cylinder.</li> <li>● Under instrument panel.</li> </ul>
VOLKSWAGEN	1. [AUDI-4] diagnostic connector 2. [SMART OBD II -16E] diagnostic connector	<ul style="list-style-type: none"> <li>● Sockets for PASSAT-1993 , in the central control board ; 1994-96, next to steering column; 96-09/00, next to parking brake under gasket.</li> <li>● Sockets for POLO 10/99, under ashtray; 1994, in the glove box of driver; Sockets for 94-07/97, in the side glove box of driver; Sockets for 08/97-09/99, in the combination</li> </ul>

		<p>instrument panel.</p> <ul style="list-style-type: none"> <li>● Beetle socket, under side instrument panel.</li> </ul>
AUDI	<ol style="list-style-type: none"> <li>1. [AUDI-4] diagnostic connector</li> <li>2. [SMART OBD II -16E] diagnostic connector</li> </ol> <p><i>Note: for connecting AUDI4PIN socket, connect black end of diagnostic connector to black socket, white to white. VOLKSWAGEN socket is alive so it doesn't need external power.</i></p>	<ul style="list-style-type: none"> <li>● Sockets for A2 , A4/S42000- , A6/Allroad1997-, under instrument panel by driver's side.</li> <li>● Sockets for A3/S31991-2001, in the central board.</li> <li>● Sockets for 80, coupe Cabriolet 1991-2001, in the fuse relay box under engine hood.</li> <li>● Sockets for A4/S41994-2000, behind central board.</li> <li>● Sockets for 100/A6-1997, in the relay box under engine hood.</li> <li>● Sockets for A8/S81991-2001, under front ashtray.</li> <li>● Sockets for TT1991-01, under driver instrument panel.</li> <li>● Coupe S2 socket is under driver instrument panel.</li> </ul>
G.M.	<ol style="list-style-type: none"> <li>1. [SMART OBD II -16E] diagnostic connector</li> <li>2. GM/VAZ-12 diagnostic connector</li> </ol>	<ul style="list-style-type: none"> <li>● Under instrument panel by driver's side next to door.</li> </ul>
FORD	<ol style="list-style-type: none"> <li>1. [FORD-6+1] diagnostic connector</li> <li>2. [SMART OBD II -16E] diagnostic connector</li> </ol>	<ul style="list-style-type: none"> <li>● In the right of engine in engine compartment.</li> <li>● Under instrument panel.</li> </ul>
CHRYSLER	<ol style="list-style-type: none"> <li>1. [CHRYSLER-6] diagnostic connector</li> <li>2. [SMART OBD II -16E] diagnostic connector</li> </ol> <p><i>Note: 6PIN socket is only used for engine system. 16PIN socket is used for all systems.</i></p>	<ul style="list-style-type: none"> <li>● CHRYSLER-6 socket is in the engine compartment.</li> <li>● OBD II -16 socket is under instrument panel in the compartment.</li> </ul>
PEUGEOT	[SMART OBD II -16E] diagnostic connector	<ul style="list-style-type: none"> <li>● Under instrument panel.</li> </ul>
LANDROVER	[SMART OBD II -16E] diagnostic connector	<ul style="list-style-type: none"> <li>● Under instrument panel.</li> </ul>
SUBARU	[SUBARU-9] diagnostic connector	<ul style="list-style-type: none"> <li>● Under steering wheel.</li> </ul>
VOLVO	[SMART OBD II -16E] diagnostic connector	<ul style="list-style-type: none"> <li>● Under left bottom of driver instrument panel.</li> </ul>
GREAT WALL	1. [FIAT-3] diagnostic	<ul style="list-style-type: none"> <li>● FIAT-3 socket is in engine compartment. .</li> </ul>

	connector 2. [SMART OBD II -16E] diagnostic connector	<ul style="list-style-type: none"> <li>● OBD II -16 trapeziform socket is under instrument panel.。</li> </ul>
CHERY	<ol style="list-style-type: none"> <li>1. [FIAT-3] diagnostic connector</li> <li>2. [SMART OBD II -16E] diagnostic connector</li> </ol>	<ul style="list-style-type: none"> <li>● FIAT-3 socket is in engine compartment.。</li> <li>● OBD II -16 socket is in left bottom of instrument panel in compartment.</li> <li>● CHERY ABS socket is under instrument panel.</li> <li>● Sockets for CHERY , MOTOROLA K2 electronic control system, next to firewall in engine compartment.</li> <li>● Sockets for CHERY MM electronic control system, next to firewall in engine compartment.</li> </ul>
KINGLONG	<ol style="list-style-type: none"> <li>1. [NISSAN-14+16] diagnostic connector for KINGLONG equipped with NISSAN electronic control system.</li> <li>2. [SMART OBD II -16E] diagnostic connector.</li> <li>3. [TOYOTA-17F] diagnostic connector for KINGLONG equipped with TOYOTA electronic control system.</li> </ol>	<ul style="list-style-type: none"> <li>● Sockets for NISSAN system, under instrument panel of front seat.</li> <li>● Sockets for DELPHI 491QE, under driver's seat.</li> <li>● Sockets for DELPHI JM495, next to passenger door.</li> <li>● Sockets for HINO system of KINGLONG saloon car, behind left rear wheel.</li> </ul>
ZHONGHUA CAR	[SMART OBD II -16E] diagnostic connector	<ul style="list-style-type: none"> <li>● 16Pin socket is under right side of steering wheel in compartment..</li> </ul>

## Warranty

THIS WARRANTY IS EXPRESSLY LIMITED TO PERSONS WHO PURCHASE LAUNCH PRODUCTS FOR PURPOSES OF RESALE OR USE IN THE ORDINARY COURSE OF THE BUYER'S BUSINESS.

LAUNCH electronic product is warranted against defects in materials and workmanship for one year (12 months) from date of delivery to the user.

This warranty does not cover any part that has been abused, altered, used for a purpose other than for which it was intended, or used in a manner inconsistent with instructions regarding use. The exclusive remedy for any automotive meter found to be defective is repair or replacement, and LAUNCH shall not be liable for any consequential or incidental damages.

Final determination of defects shall be made by LAUNCH in accordance with procedures established by LAUNCH. No agent, employee, or representative of LAUNCH has any authority to bind LAUNCH to any affirmation, representation, or warranty concerning LAUNCH automotive meters, except as stated herein.

## Disclaimer

THE ABOVE WARRANTY IS IN LIEU OF ANY OTHER WARRANTY, EXPRESSED OR IMPLIED, INCLUDING ANY WARRANTY OF MERCHANTABILITY OR FITNESS FOR A PARTICULAR PURPOSE.

## Order Information

Replaceable and optional parts can be ordered directly from your LAUNCH authorized tool

supplier. Your order should include the following information:

1. Quantity
2. Part number
3. Item description

## Customer Service

If you have any questions on the operation of the unit, please contact us:

Tel: 86-755-84528431/84528822

E-mail: X431@cnlaunch.com

If your unit requires repair service, return it to the manufacturer with a copy of the sales receipt and a note describing the problem. If the unit is determined to be in warranty, it will be repaired or replaced at no charge. If the unit is determined to be out of warranty, it will be repaired for a nominal service charge plus return freight. Send the unit pre-paid to:

Attn: Customer Service Department  
LAUNCH TECH. CO., LTD.  
Launch Industrial Park,  
North of Wuhe Avenue,  
Banxuegang, Bantian,  
Longgang, Shenzhen, Guangdong  
P.R.China, 518129

**X-431 TOOL Serial No.****DEALER CODE****Note:**

1. 'X-431 TOOL Serial No.' label is attached by LAUNCH before shipping.
2. Dealer should fill in the Dealer Code when selling the machine to customer and stamp on the code.
3. The 'X-431 TOOL Serial No.' and 'Dealer Code' are useful when updating the software. Refer to the section 'Update of Diagnostic Software'. Keep the user's manual carefully.
4. Dealer should log on <http://www.X431.com> to fill in the Dealer Code and other information in 'Dealer administration' area when a product is sold so that customer can do software updating.

**Statement:** *LAUNCH reserves the rights to make any change to product designs and specifications without notice. The actual object may differ a little from the descriptions in the manual in physical appearance, color and configuration. We have tried our best to make the descriptions and illustrations in the manual as accurate as possible, and defects are inevitable, if you have any question, please contact local dealer or after-sale service center of LAUNCH, LAUNCH does not bear any responsibility arising from misunderstandings.*

## **FCC STATEMENT**

1. This device complies with Part 15 of the FCC Rules. Operation is subject to the following two conditions:

(1) This device may not cause harmful interference.

(2) This device must accept any interference received, including interference that may cause undesired operation.

2. Changes or modifications not expressly approved by the party responsible for compliance could void the user's authority to operate the equipment.

NOTE: This equipment has been tested and found to comply with the limits for a Class B digital device, pursuant to Part 15 of the FCC Rules. These limits are designed to provide reasonable protection against harmful interference in a residential installation.

This equipment generates uses and can radiate radio frequency energy and, if not installed and used in accordance with the instructions, may cause harmful interference to radio communications. However, there is no guarantee that interference will not occur in a particular installation. If this equipment does cause harmful interference to radio or television reception, which can be determined by turning the equipment off and on, the user is encouraged to try to correct the interference by one or more of the following measures:

Reorient or relocate the receiving antenna.

Increase the separation between the equipment and receiver.

Connect the equipment into an outlet on a circuit different from that to which the receiver is connected.

Consult the dealer or an experienced radio/TV technician for help.