



CTC Laboratories, Inc.

1-2/F., Building 2, Jiaquan Building, Guanlan High-Tech Park, Shenzhen, Guangdong, China
Tel: +86-755- 27521059 Fax: +86-755- 27521011 Http://www.sz-ctc.org.cn

TEST REPORT

Report No.: **CTC20231384E01**

FCC ID.....: **XUJX431PROV5**

Applicant.....: **Launch Tech Co., Ltd.**

Address.....: Launch Industrial Park, North of Wuhe Avenue, Banxuegang, Longgang, Shenzhen, Guangdong, P.R. China

Manufacturer.....: Launch Tech Co., Ltd.

Address.....: Launch Industrial Park, North of Wuhe Avenue, Banxuegang, Longgang, Shenzhen, Guangdong, P.R. China

Product Name.....: **AUTO Smart Diagnostic Tool**

Trade Mark.....: LAUNCH

Model/Type reference.....: OADD-PO1005V, OADD-PO0805V

Listed Model(s): /

Standard.....: **FCC CFR Title 47 Part 15 Subpart C Section 15.247**

Date of receipt of test sample...: Jun. 21, 2023

Date of testing.....: Jun. 22, 2023 ~ Aug. 06, 2023

Date of issue.....: Aug. 07, 2023

Result.....: **PASS**

Compiled by:		
(Printed name+signature)	Terry Su	
Supervised by:		
(Printed name+signature)	Eric Zhang	
Approved by:		
(Printed name+signature)	Totti Zhao	

Testing Laboratory Name.....: **CTC Laboratories, Inc.**

Address.....: 1-2/F., Building 2, Jiaquan Building, Guanlan High-Tech Park, Shenzhen, Guangdong, China

This test report may be duplicated completely for legal use with the approval of the applicant. It should not be reproduced except in full, without the written approval of our laboratory. The client should not use it to claim product endorsement by CTC. The test results in the report only apply to the tested sample. The test report shall be invalid without all the signatures of testing engineers, reviewer and approver. Any objections must be raised to CTC within 15 days since the date when the report is received. It will not be taken into consideration beyond this limit. The test report merely correspond to the test sample.



Table of Contents

Page

1. TEST SUMMARY..... 3

1.1. TEST STANDARDS.....3

1.2. REPORT VERSION.....3

1.3. TEST DESCRIPTION.....4

1.4. TEST FACILITY5

1.5. MEASUREMENT UNCERTAINTY5

1.6. ENVIRONMENTAL CONDITIONS6

2. GENERAL INFORMATION..... 7

2.1. CLIENT INFORMATION7

2.2. GENERAL DESCRIPTION OF EUT8

2.3. ACCESSORY EQUIPMENT INFORMATION9

2.4. OPERATION STATE..... 10

2.5. MEASUREMENT INSTRUMENTS LIST 11

3. TEST ITEM AND RESULTS..... 13

3.1. CONDUCTED EMISSION..... 13

3.2. RADIATED EMISSION 15

3.3. BAND EDGE EMISSIONS (RADIATED)25

3.4. BAND EDGE AND SPURIOUS EMISSIONS (CONDUCTED) 30

3.5. DTS BANDWIDTH..... 31

3.6. PEAK OUTPUT POWER 32

3.7. POWER SPECTRAL DENSITY 33

3.8. DUTY CYCLE 34

3.9. ANTENNA REQUIREMENT 35



1. 7TEST SUMMARY

1.1. Test Standards

The tests were performed according to following standards:

[FCC Rules Part 15.247](#): Operation within the bands of 902-928MHz, 2400-2483.5MHz, and 5725-5850MHz.

[RSS 247 Issue 2](#): Standard Specifications for Frequency Hopping Systems (FHSs) and Digital Transmission Systems (DTSS) Operating in the Bands 902-928MHz, 2400-2483.5MHz and 5725-5850MHz.

[ANSI C63.10-2013](#): American National Standard for Testing Unlicensed Wireless Devices.

1.2. Report version

Revised No.	Date of issue	Description
01	Aug. 07, 2023	Original

Note: Replace the leather case, the prototype becomes thinner, and the RF part remains unchanged, Add radiation part testing, This report is based on the report of NO.: CTC20210728E11.



1.3. Test Description

FCC Part 15 Subpart C (15.247) / RSS 247 Issue 2				
Test Item	Standard Section		Result	Test Engineer
	FCC	IC		
Antenna Requirement	15.203	/	Pass	Alicia Liu
Conducted Emission	15.207	RSS-Gen 8.8	N/A	N/A
Conducted Band Edge and Spurious Emissions	15.247(d)	RSS 247 5.5	N/A	N/A
Radiated Band Edge and Spurious Emissions	15.205&15.209&15.247(d)	RSS 247 5.5	Pass	Alicia Liu
6dB Bandwidth	15.247(a)(2)	RSS 247 5.2 (a)	N/A	N/A
Conducted Max Output Power	15.247(b)(3)	RSS 247 5.4 (d)	N/A	N/A
Power Spectral Density	15.247(e)	RSS 247 5.2 (b)	N/A	N/A
Transmitter Radiated Spurious	15.209&15.247(d)	RSS 247 5.5&RSS-Gen 8.9	Pass	Alicia Liu

Note: The measurement uncertainty is not included in the test result.

“N/A” is no application.



1.4. Test Facility

CTC Laboratories, Inc.

Add: 1-2/F., Building 2, Jiaquan Building, Guanlan High-Tech Park, Shenzhen, Guangdong, China

Laboratory accreditation

The test facility is recognized, certified, or accredited by the following organizations:

A2LA-Lab Cert. No.: 4340.01

CTC Laboratories, Inc. EMC Laboratory has been accredited by A2LA for technical competence in the field of electrical testing, and proved to be in compliance with ISO/IEC 17025:2017 General Requirements for the Competence of Testing and Calibration Laboratories and any additional program requirements in the identified field of testing.

Industry Canada (Registration No.: 9783A, CAB Identifier: CN0029)

CTC Laboratories, Inc. EMC Laboratory has been registered by Certification and Engineer Bureau of Industry Canada for the performance of with Registration NO.: 9783A on Jan, 2016.

FCC (Registration No.: 951311, Designation Number CN1208)

CTC Laboratories, Inc. EMC Laboratory has been registered and fully described in a report filed with the (FCC) Federal Communications Commission. The acceptance letter from the FCC is maintained in our files. Registration 951311, Aug 26, 2017.

1.5. Measurement Uncertainty

The data and results referenced in this document are true and accurate. The reader is cautioned that there may be errors within the calibration limits of the equipment and facilities. The measurement uncertainty was calculated for all measurements listed in this test report acc. to TR-100028-01 "Electromagnetic compatibility and Radio spectrum Matters (ERM); Uncertainties in the measurement of mobile radio equipment characteristics; Part 1" and TR-100028-02 "Electromagnetic compatibility and Radio spectrum Matters (ERM); Uncertainties in the measurement of mobile radio equipment characteristics; Part 2" and is documented in the CTC Laboratories, Inc. quality system acc. to DIN EN ISO/IEC 17025. Furthermore, component and process variability of devices similar to that tested may result in additional deviation. The manufacturer has the sole responsibility of continued compliance of the device.

Below is the best measurement capability for CTC Laboratories, Inc.



Test Items	Measurement Uncertainty	Notes
DTS Bandwidth	$\pm 0.0196\%$	(1)
Maximum Conducted Output Power	± 0.686 dB	(1)
Maximum Power Spectral Density Level	± 0.743 dB	(1)
Band-edge Compliance	± 1.328 dB	(1)
Unwanted Emissions In Non-restricted Freq Bands	9kHz-1GHz: ± 0.746 dB 1GHz-26GHz: ± 1.328 dB	(1)
Conducted Emissions 9kHz~30MHz	± 3.08 dB	(1)
Radiated Emissions 30~1000MHz	± 4.51 dB	(1)
Radiated Emissions 1~18GHz	± 5.84 dB	(1)
Radiated Emissions 18~40GHz	± 6.12 dB	(1)

Note (1): This uncertainty represents an expanded uncertainty expressed at approximately the 95% confidence level using a coverage factor of $k=2$.

1.6. Environmental conditions

During the measurement the environmental conditions were within the listed ranges:

Temperature:	21°C ~ 27°C
Relative Humidity:	40% ~ 60%
Air Pressure:	101kPa



2. GENERAL INFORMATION

2.1. Client Information

Applicant:	Launch Tech Co., Ltd.
Address:	Launch Industrial Park, North of Wuhe Avenue, Banxuegang, Longgang, Shenzhen, Guangdong, P.R. China
Manufacturer:	Launch Tech Co., Ltd.
Address:	Launch Industrial Park, North of Wuhe Avenue, Banxuegang, Longgang, Shenzhen, Guangdong, P.R. China



2.2. General Description of EUT

Product Name:	AUTO Smart Diagnostic Tool
Trade Mark:	LAUNCH
Model/Type reference:	OADD-PO1005V, OADD-PO0805V
Listed Model(s):	/
Model Difference:	All these models are identical in the same PCB, Layout and electrical circuit, The only difference is screen size, antenna and antenna position.
Power supply:	5Vdc/5A from AC/DC Adapter 7.6Vdc from 6300mAh Li-ion Battery
Adapter model:	PSYC0505000US Input: 100-240V~ 50/60Hz 0.6A Max Output: 5Vdc/5A
Hardware version:	/
Software version:	/
BT 5.1/ BLE	
Modulation:	GFSK
Operation frequency:	2402MHz~2480MHz
Channel number:	40
Channel separation:	2MHz
Antenna type:	FPC Antenna
OADD-PO1005V Antenna gain:	3.42dBi Max
OADD-PO0805V Antenna gain:	2.96dBi Max

Note: OADD-PO1005V, OADD-PO0805V has been testes, Just the worst case recorded in report.



2.3. Accessory Equipment information

Equipment Information			
Name	Model	S/N	Manufacturer
/	/	/	/
/	/	/	/
Cable Information			
Name	Shielded Type	Ferrite Core	Length
/	/	/	/
Test Software Information			
Name	/	/	/
Engineering mode	/	/	/



2.4. Operation state

Operation Frequency List: The EUT has been tested under typical operating condition. The Applicant provides communication tools software to control the EUT for staying in continuous transmitting and receiving mode for testing. BT BLE, 40 channels are provided to the EUT. Channels 00/19/39 were selected for testing. Operation Frequency List:

Channel	Frequency (MHz)
00	2402
01	2404
:	:
18	2438
19	2440
20	2442
:	:
38	2478
39	2480

Note: The display in grey were the channel selected for testing.

Test mode

For RF test items:
The engineering test program was provided and enabled to make EUT continuous transmit.
For AC power line conducted emissions:
The EUT was set to connect with the Bluetooth instrument under large package sizes transmission.
For Radiated spurious emissions test item:
The engineering test program was provided and enabled to make EUT continuous transmit. The EUT in each of three orthogonal axis emissions had been tested, but only the worst case (X axis) data recorded in the report.



2.5. Measurement Instruments List

Tonscend JS0806-2 Test system					
Item	Test Equipment	Manufacturer	Model No.	Serial No.	Calibrated until
1	MXA Signal Analyzer	Keysight	N9020A	MY46471737	Dec. 16, 2023
2	Spectrum Analyzer	R&S	FSU26	100105	Dec. 16, 2023
3	Spectrum Analyzer	R&S	FSV40-N	101331	Mar. 14, 2024
4	MXG Vector Signal Generator	Agilent	N5182A	MY47420864	Dec. 16, 2023
5	PSG Analog Signal Generator	Agilent	E8257D	MY46521908	Dec. 16, 2023
6	Power Sensor	Keysight	U2021XA	MY55130004	Mar. 14, 2024
7	Power Sensor	Keysight	U2021XA	MY55130006	Mar. 14, 2024
8	Wideband Radio Communication Tester	R&S	CMW500	102414	Dec. 16, 2023
9	High and low temperature box	ESPEC	MT3035	/	Mar. 24, 2024
10	JS1120 RF Test system	TONSCEND	v2.6	/	/

Radiated emission(3m chamber 2)					
Item	Test Equipment	Manufacturer	Model No.	Serial No.	Calibrated Until
1	Trilog-Broadband Antenna	Schwarzbeck	VULB 9168	9168-1013	Dec. 07, 2024
2	Horn Antenna	Schwarzbeck	BBHA 9120D	9120D-647	Dec. 07, 2024
3	Loop Antenna	LAPLAC	RF300	9138	Dec. 16, 2023
4	Spectrum Analyzer	R&S	FSU26	100105	Dec. 16, 2023
5	Spectrum Analyzer	R&S	FSV40-N	101331	Mar. 14, 2024
6	Pre-Amplifier	SONOMA	310	186194	Dec. 16, 2023
7	Low Noise Pre-Amplifier	EMCI	EMC051835	980075	Dec. 16, 2023
8	Test Receiver	R&S	ESCI7	100967	Dec. 16, 2023
9	3m chamber 2	Frankonia	EE025	/	Oct. 23, 2024

Radiated emission(3m chamber 3)					
Item	Test Equipment	Manufacturer	Model No.	Serial No.	Calibrated Until
1	Trilog-Broadband Antenna	Schwarzbeck	VULB 9163	01026	Dec. 18, 2024
2	Horn Antenna	Schwarzbeck	BBHA 9120D	9120D-647	Dec. 01, 2024
3	Test Receiver	Keysight	N9038A	MY56400071	Dec. 16, 2023
4	Broadband Premplifier	SCHWARZBECK	BBV9743B	259	Dec. 16, 2023
5	Mirowave Broadband Amplifier	SCHWARZBECK	BBV9718C	111	Dec. 16, 2023
6	Pre-Amplifier	R&S	SCU-26	10033	Dec. 16, 2023
7	Pre-Amplifier	R&S	SCU-40	10030	Dec. 16, 2023
8	Board-Band Horn Antenna	Schwarzbeck	BBHA 9170	BBHA 9170-497	Dec. 16, 2023
9	3m chamber 3	YIHENG	EE106	/	Sep. 09, 2023

CTC Laboratories, Inc.

1-2/F., Building 2, Jiaquan Building, Guanlan High-Tech Park, Shenzhen, Guangdong, China

Tel.: (86)755-27521059

Fax: (86)755-27521011

Http://www.sz-ctc.org.cn



中国国家认证认可监督管理委员会
Certification and Accreditation Administration of the People's Republic of China

For anti-fake verification, please visit the official website of Certification and Accreditation Administration of the People's Republic of China : yz.cnca.cn



Conducted Emission					
Item	Test Equipment	Manufacturer	Model No.	Serial No.	Calibrated until
1	LISN	R&S	ENV216	101112	Dec. 16, 2023
2	LISN	R&S	ENV216	101113	Dec. 16, 2023
3	EMI Test Receiver	R&S	ESCS30	100353	Dec. 16, 2023

Note: 1. The Cal. Interval was one year.

2. The Cal. Interval was three year of the chamber

3. The cable loss has calculated in test result which connection between each test instruments.

3. TEST ITEM AND RESULTS

3.1. Conducted Emission

Limit

FCC CFR Title 47 Part 15 Subpart C Section 15.207/ RSS - Gen 8.8

Frequency range (MHz)	Limit (dBuV)	
	Quasi-peak	Average
0.15-0.5	66 to 56*	56 to 46*
0.5-5	56	46
5-30	60	50

* Decreases with the logarithm of the frequency.

Test Configuration

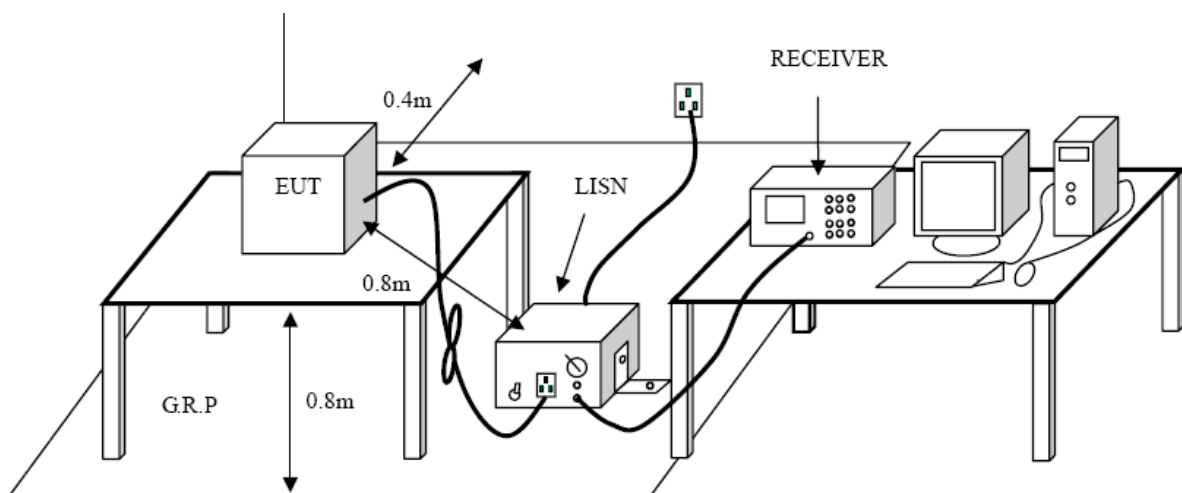

Test Procedure

1. The EUT was setup according to ANSI C63.10:2013 requirements.
2. The EUT was placed on a platform of nominal size, 1 m by 1.5 m, raised 80 cm above the conducting ground plane. The vertical conducting plane was located 40 cm to the rear of the EUT. All other surfaces of EUT were at least 80 cm from any other grounded conducting surface.
3. The EUT and simulators are connected to the main power through a line impedances stabilization network (LISN). The LISN provides a 50ohm /50uH coupling impedance for the measuring equipment. The peripheral devices are also connected to the main power through a LISN. (Please refer to the block diagram of the test setup and photographs)
4. Each current-carrying conductor of the EUT power cord, except the ground (safety) conductor, was individually connected through a LISN to the input power source.
5. The excess length of the power cord between the EUT and the LISN receptacle were folded back and forth at the center of the lead to form a bundle not exceeding 40 cm in length.
6. Conducted Emissions were investigated over the frequency range from 0.15MHz to 30MHz using a receiver bandwidth of 9 kHz.
7. During the above scans, the emissions were maximized by cable manipulation.



Test Mode:

Please refer to the clause 2.4.

Test Results

Note: This test item not applicable.

3.2. Radiated Emission

Limit

FCC CFR Title 47 Part 15 Subpart C Section 15.209/ RSS – Gen 8.9

Frequency	Limit (dBuV/m @3m)	Value
30 MHz ~ 88 MHz	40.00	Quasi-peak
88 MHz ~ 216 MHz	43.50	Quasi-peak
216 MHz ~ 960 MHz	46.00	Quasi-peak
960 MHz ~ 1 GHz	54.00	Quasi-peak
Above 1 GHz	54.00	Average
	74.00	Peak

Note:

- (1) The tighter limit applies at the band edges.
- (2) Emission Level (dBuV/m)=20log Emission Level (uV/m).

Test Configuration

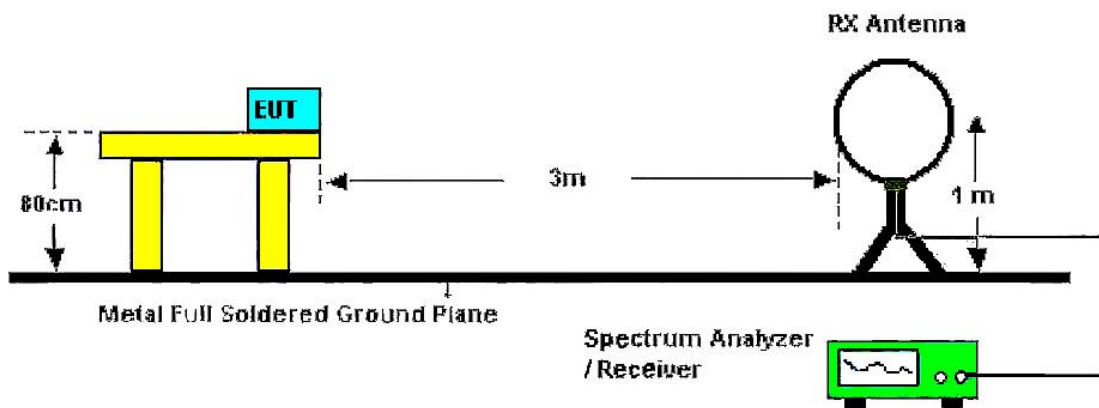

Below 30MHz Test Setup

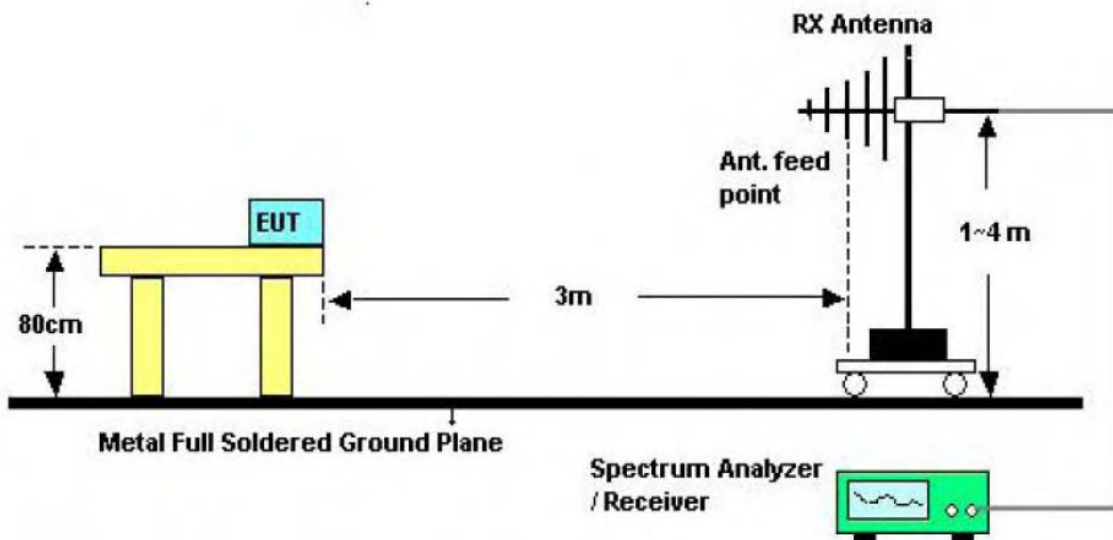

Below 1000MHz Test Setup

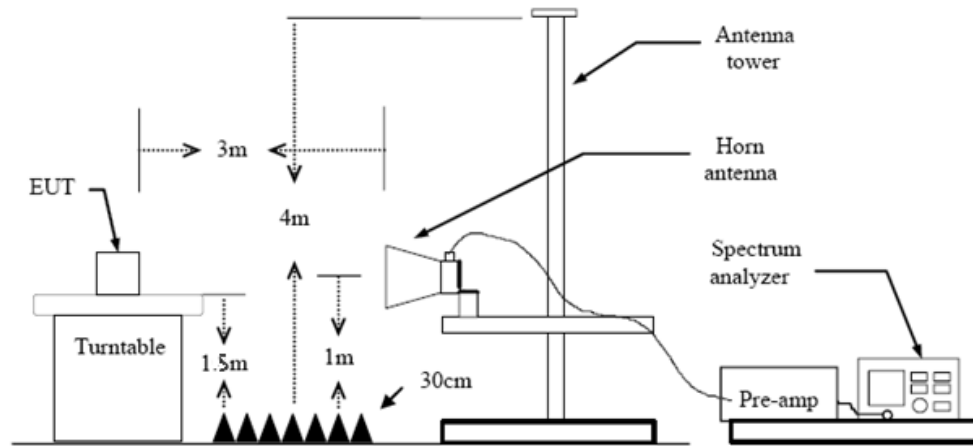

Above 1GHz Test Setup

Test Procedure

1. The EUT was setup and tested according to ANSI C63.10:2013
 2. The EUT is placed on a turn table which is 0.8 meter above ground for below 1 GHz, and 1.5 m for above 1 GHz. The turn table is rotated 360 degrees to determine the position of the maximum emission level.
 3. The EUT was set 3 meters from the receiving antenna, which was mounted on the top of a variable height antenna tower.
 4. For each suspected emission, the EUT was arranged to its worst case and then tune the Antenna tower (from 1 m to 4 m) and turntable (from 0 degree to 360 degrees) to find the maximum reading. A pre-amp and a high pass filter are used for the test in order to get better signal level to comply with the guidelines.
 5. Set to the maximum power setting and enable the EUT transmit continuously.
 6. Use the following spectrum analyzer settings
 - (1) Span shall wide enough to fully capture the emission being measured;
 - (2) Below 1 GHz:
RBW=120 kHz, VBW=300 kHz, Sweep=auto, Detector function=peak, Trace=max hold;
If the emission level of the EUT measured by the peak detector is 3 dB lower than the applicable limit, the peak emission level will be reported. Otherwise, the emission measurement will be repeated using the quasi-peak detector and reported.
 - (3) From 1 GHz to 10th harmonic:
RBW=1MHz, VBW=3MHz Peak detector for Peak value.
RBW=1MHz, VBW \geq 1/T Peak detector for Average value.
- Note 1: For the 1/T & Duty Cycle please refer to clause 3.8 Duty Cycle.

Test Mode

Please refer to the clause 2.4.

Test Result

9 KHz~30 MHz

From 9 KHz to 30 MHz: Conclusion: PASS

Note: The amplitude of spurious emissions which are attenuated by more than 20dB below the permissible value has no need to be reported.



30MHz-1GHz

Ant. Pol.	Horizontal
Test Mode:	TX Mode 2402MHz
Remark:	Only worse case is reported

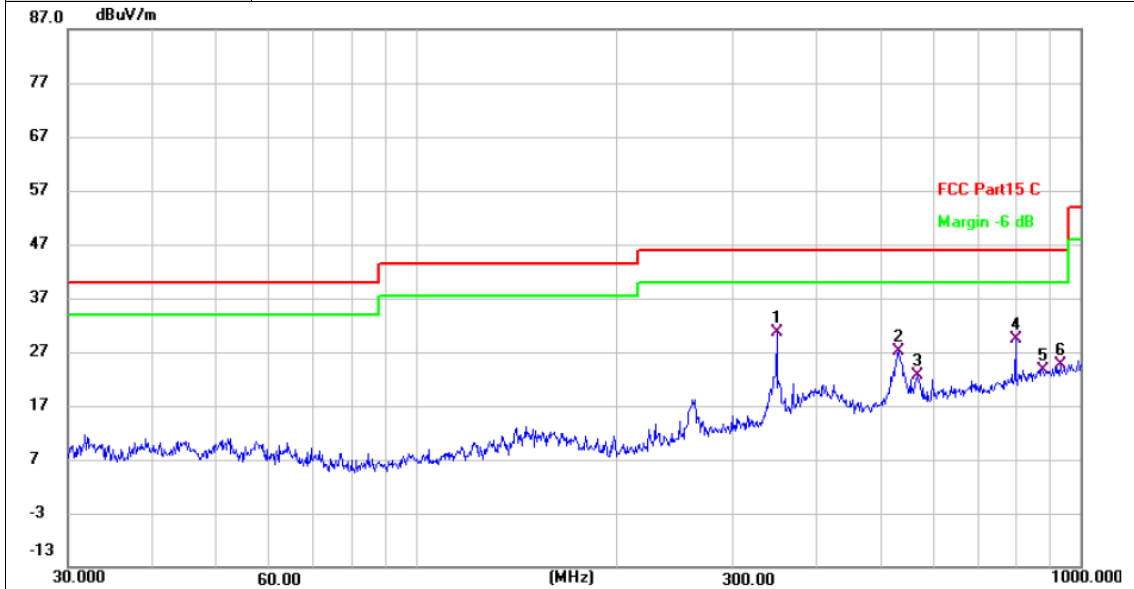

No.	Frequency (MHz)	Reading (dBuV)	Factor (dB/m)	Level (dBuV/m)	Limit (dBuV/m)	Margin (dB)	Detector
1 *	349.2500	46.57	-15.99	30.58	46.00	-15.42	QP
2	531.9634	39.22	-12.04	27.18	46.00	-18.82	QP
3	568.6126	34.09	-11.36	22.73	46.00	-23.27	QP
4	798.9797	36.69	-7.33	29.36	46.00	-16.64	QP
5	875.2469	29.86	-6.24	23.62	46.00	-22.38	QP
6	932.2715	30.04	-5.49	24.55	46.00	-21.45	QP

Remarks:

1. Factor (dB/m) = Antenna Factor (dB/m)+Cable Factor (dB)-Pre-amplifier Factor
2. Margin value = Level -Limit value



Ant. Pol.	Vertical																																																														
Test Mode:	TX Mode 2402MHz																																																														
Remark:	Only worse case is reported																																																														
<table border="1"> <thead> <tr> <th>No.</th> <th>Frequency (MHz)</th> <th>Reading (dBuV)</th> <th>Factor (dB/m)</th> <th>Level (dBuV/m)</th> <th>Limit (dBuV/m)</th> <th>Margin (dB)</th> <th>Detector</th> </tr> </thead> <tbody> <tr> <td>1 *</td> <td>33.5624</td> <td>38.82</td> <td>-18.11</td> <td>20.71</td> <td>40.00</td> <td>-19.29</td> <td>QP</td> </tr> <tr> <td>2</td> <td>349.2500</td> <td>40.75</td> <td>-15.99</td> <td>24.76</td> <td>46.00</td> <td>-21.24</td> <td>QP</td> </tr> <tr> <td>3</td> <td>531.9635</td> <td>36.74</td> <td>-12.04</td> <td>24.70</td> <td>46.00</td> <td>-21.30</td> <td>QP</td> </tr> <tr> <td>4</td> <td>798.9797</td> <td>32.79</td> <td>-7.33</td> <td>25.46</td> <td>46.00</td> <td>-20.54</td> <td>QP</td> </tr> <tr> <td>5</td> <td>866.0879</td> <td>31.14</td> <td>-6.38</td> <td>24.76</td> <td>46.00</td> <td>-21.24</td> <td>QP</td> </tr> <tr> <td>6</td> <td>942.1305</td> <td>29.79</td> <td>-5.37</td> <td>24.42</td> <td>46.00</td> <td>-21.58</td> <td>QP</td> </tr> </tbody> </table>								No.	Frequency (MHz)	Reading (dBuV)	Factor (dB/m)	Level (dBuV/m)	Limit (dBuV/m)	Margin (dB)	Detector	1 *	33.5624	38.82	-18.11	20.71	40.00	-19.29	QP	2	349.2500	40.75	-15.99	24.76	46.00	-21.24	QP	3	531.9635	36.74	-12.04	24.70	46.00	-21.30	QP	4	798.9797	32.79	-7.33	25.46	46.00	-20.54	QP	5	866.0879	31.14	-6.38	24.76	46.00	-21.24	QP	6	942.1305	29.79	-5.37	24.42	46.00	-21.58	QP
No.	Frequency (MHz)	Reading (dBuV)	Factor (dB/m)	Level (dBuV/m)	Limit (dBuV/m)	Margin (dB)	Detector																																																								
1 *	33.5624	38.82	-18.11	20.71	40.00	-19.29	QP																																																								
2	349.2500	40.75	-15.99	24.76	46.00	-21.24	QP																																																								
3	531.9635	36.74	-12.04	24.70	46.00	-21.30	QP																																																								
4	798.9797	32.79	-7.33	25.46	46.00	-20.54	QP																																																								
5	866.0879	31.14	-6.38	24.76	46.00	-21.24	QP																																																								
6	942.1305	29.79	-5.37	24.42	46.00	-21.58	QP																																																								
Remarks: 1. Factor (dB/m) = Antenna Factor (dB/m)+Cable Factor (dB)-Pre-amplifier Factor 2. Margin value = Level -Limit value																																																															



Above 1GHz

Ant. Pol.	Horizontal
Test Mode:	TX BLE Mode 2402MHz
Remark:	No report for the emission which more than 10 dB below the prescribed limit.

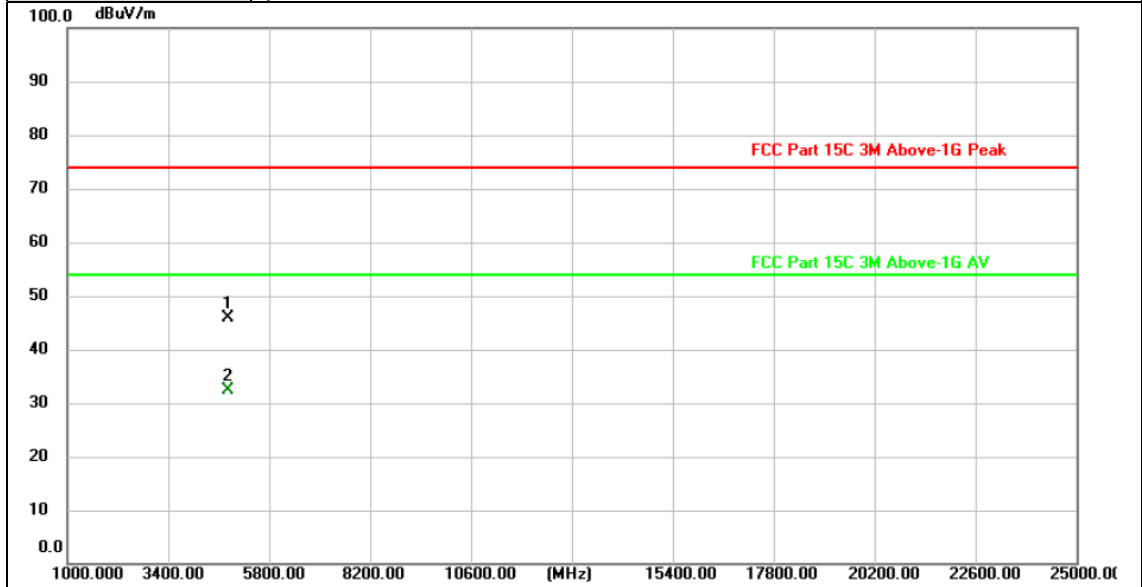

No.	Frequency (MHz)	Reading (dBuV)	Factor (dB/m)	Level (dBuV/m)	Limit (dBuV/m)	Margin (dB)	Detector
1	4803.667	48.43	-2.44	45.99	74.00	-28.01	peak
2 *	4805.000	34.73	-2.44	32.29	54.00	-21.71	AVG

Remarks:

- 1. Factor (dB/m) = Antenna Factor (dB/m)+Cable Factor (dB)-Pre-amplifier Factor
- 2. Margin value = Level -Limit value



Ant. Pol.	Vertical
Test Mode:	TX BLE Mode 2402MHz
Remark:	No report for the emission which more than 10 dB below the prescribed limit.

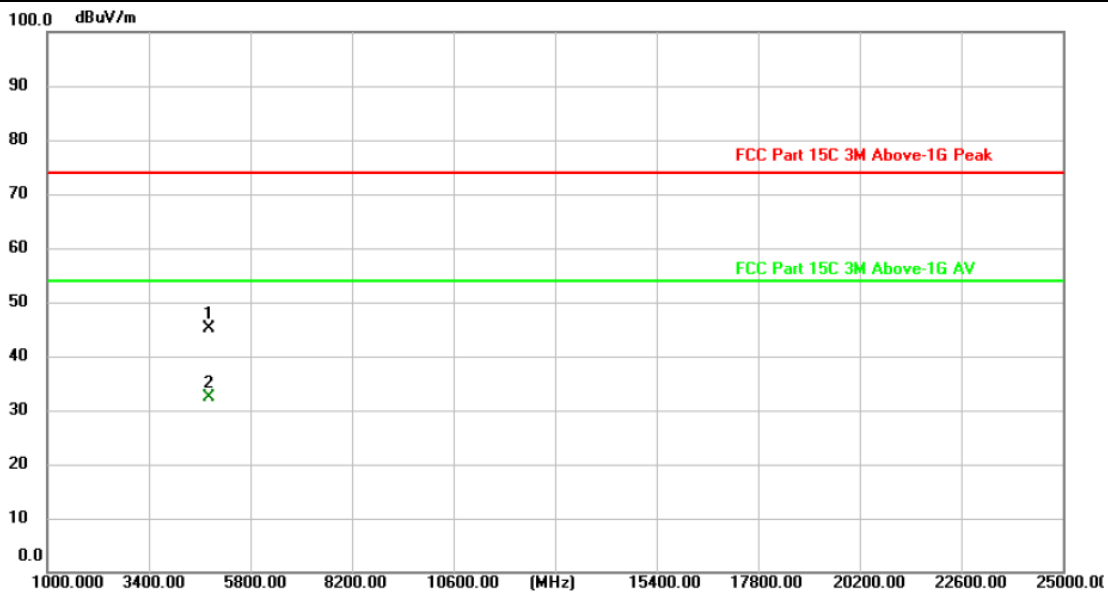

No.	Frequency (MHz)	Reading (dBuV)	Factor (dB/m)	Level (dBuV/m)	Limit (dBuV/m)	Margin (dB)	Detector
1	4804.389	47.51	-2.44	45.07	74.00	-28.93	peak
2 *	4804.654	34.81	-2.44	32.37	54.00	-21.63	AVG

Remarks:
 1. Factor (dB/m) = Antenna Factor (dB/m)+Cable Factor (dB)-Pre-amplifier Factor
 2. Margin value = Level -Limit value



Ant. Pol.	Horizontal
Test Mode:	TX BLE Mode 2440MHz
Remark:	No report for the emission which more than 10 dB below the prescribed limit.

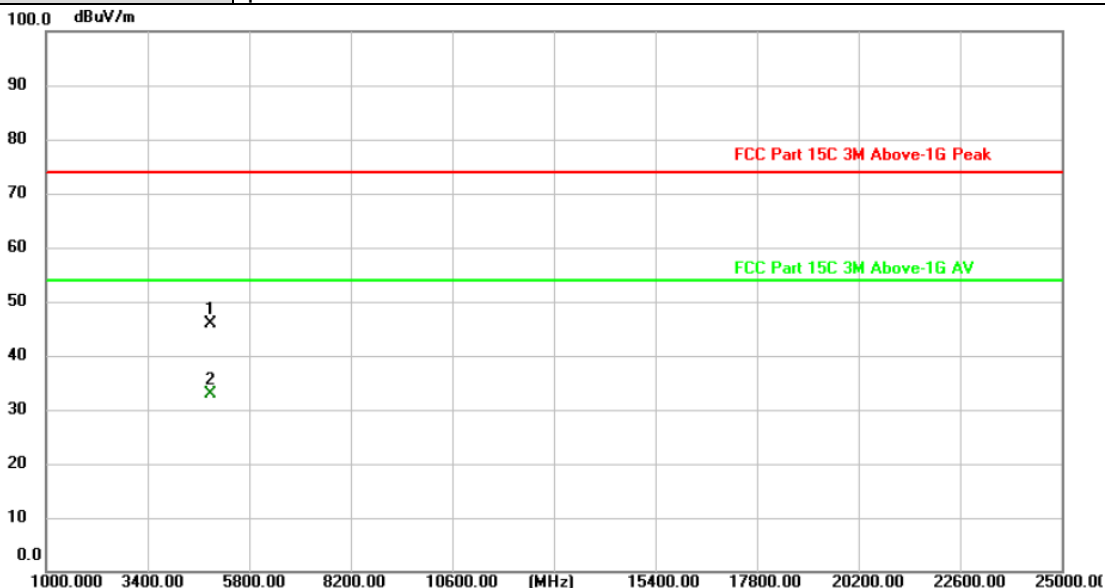

No.	Frequency (MHz)	Reading (dBuV)	Factor (dB/m)	Level (dBuV/m)	Limit (dBuV/m)	Margin (dB)	Detector
1	4879.000	47.89	-2.11	45.78	74.00	-28.22	peak
2 *	4880.946	34.94	-2.11	32.83	54.00	-21.17	AVG

Remarks:
 1. Factor (dB/m) = Antenna Factor (dB/m)+Cable Factor (dB)-Pre-amplifier Factor
 2. Margin value = Level -Limit value



Ant. Pol.	Vertical
Test Mode:	TX BLE Mode 2440MHz
Remark:	No report for the emission which more than 10 dB below the prescribed limit.

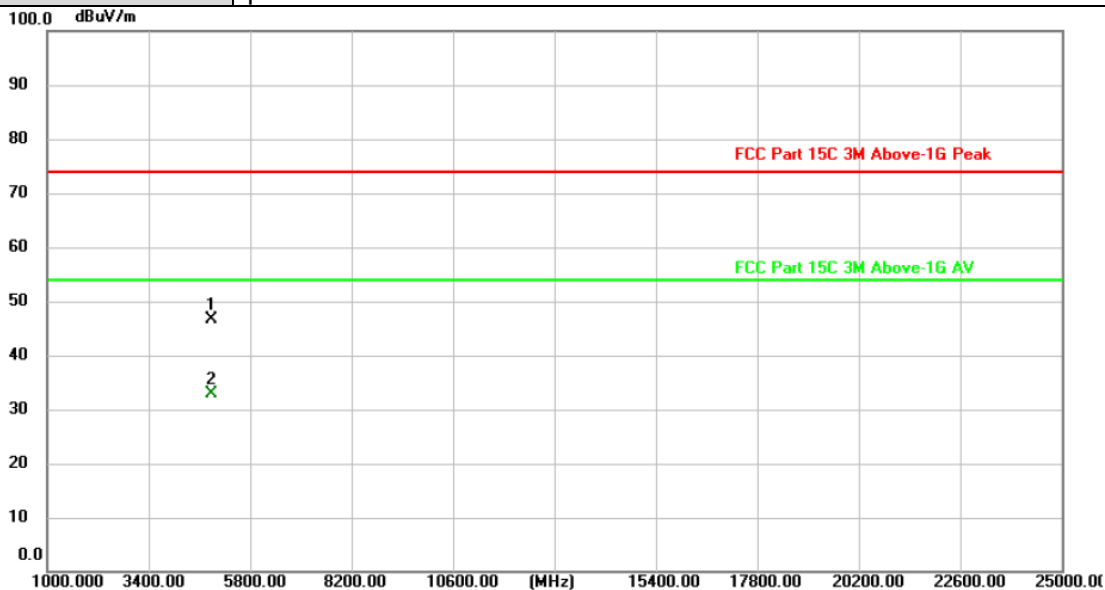

No.	Frequency (MHz)	Reading (dBuV)	Factor (dB/m)	Level (dBuV/m)	Limit (dBuV/m)	Margin (dB)	Detector
1	4879.067	48.69	-2.11	46.58	74.00	-27.42	peak
2 *	4880.754	34.94	-2.11	32.83	54.00	-21.17	AVG

Remarks:
 1. Factor (dB/m) = Antenna Factor (dB/m)+Cable Factor (dB)-Pre-amplifier Factor
 2. Margin value = Level -Limit value



Ant. Pol.	Horizontal
Test Mode:	TX BLE Mode 2480MHz
Remark:	No report for the emission which more than 10 dB below the prescribed limit.

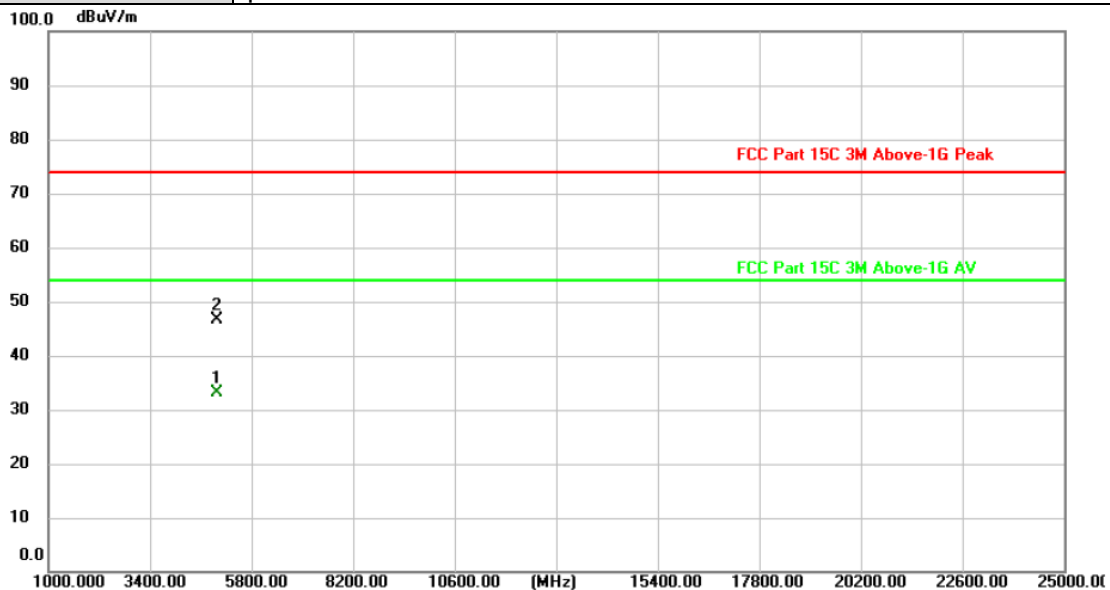

No.	Frequency (MHz)	Reading (dBuV)	Factor (dB/m)	Level (dBuV/m)	Limit (dBuV/m)	Margin (dB)	Detector
1 *	4959.261	34.93	-1.78	33.15	54.00	-20.85	AVG
2	4960.541	48.40	-1.77	46.63	74.00	-27.37	peak

Remarks:

1. Factor (dB/m) = Antenna Factor (dB/m) + Cable Factor (dB) - Pre-amplifier Factor
2. Margin value = Level - Limit value



Ant. Pol.	Vertical
Test Mode:	TX BLE Mode 2480MHz
Remark:	No report for the emission which more than 10 dB below the prescribed limit.

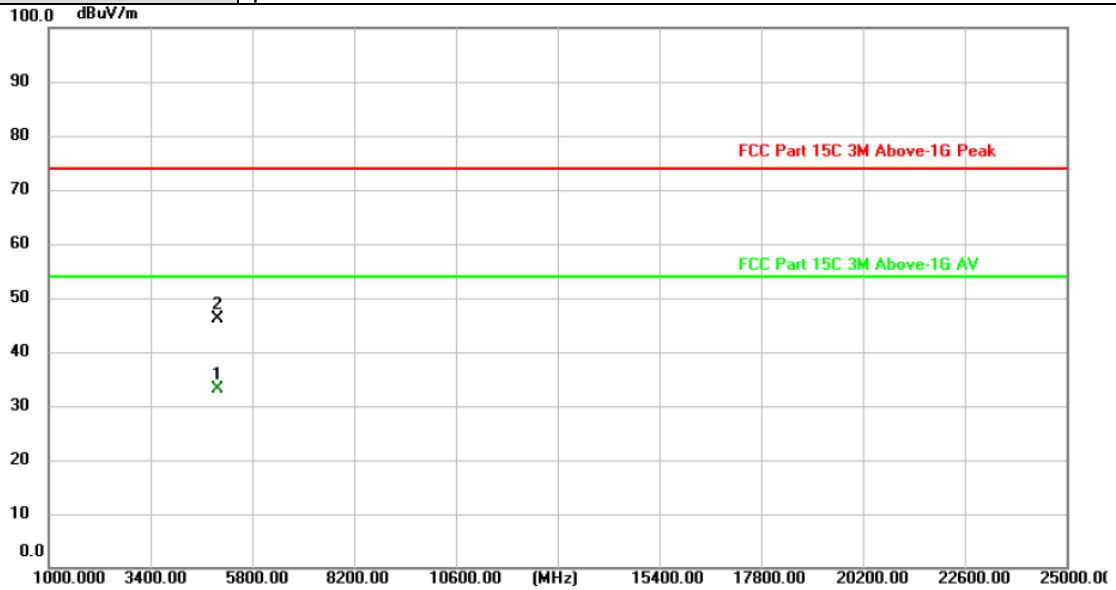

No.	Frequency (MHz)	Reading (dBuV)	Factor (dB/m)	Level (dBuV/m)	Limit (dBuV/m)	Margin (dB)	Detector
1 *	4960.074	34.83	-1.77	33.06	54.00	-20.94	AVG
2	4960.757	47.95	-1.77	46.18	74.00	-27.82	peak

Remarks:
 1. Factor (dB/m) = Antenna Factor (dB/m)+Cable Factor (dB)-Pre-amplifier Factor
 2. Margin value = Level -Limit value

3.3. Band Edge Emissions (Radiated)

Limit

FCC CFR Title 47 Part 15 Subpart C Section 15.247 (d)/ RSS 247 5.5:

Restricted Frequency Band (MHz)	(dBuV/m)(at 3m)	
	Peak	Average
2310 ~ 2390	74	54
2483.5 ~ 2500	74	54

Test Configuration

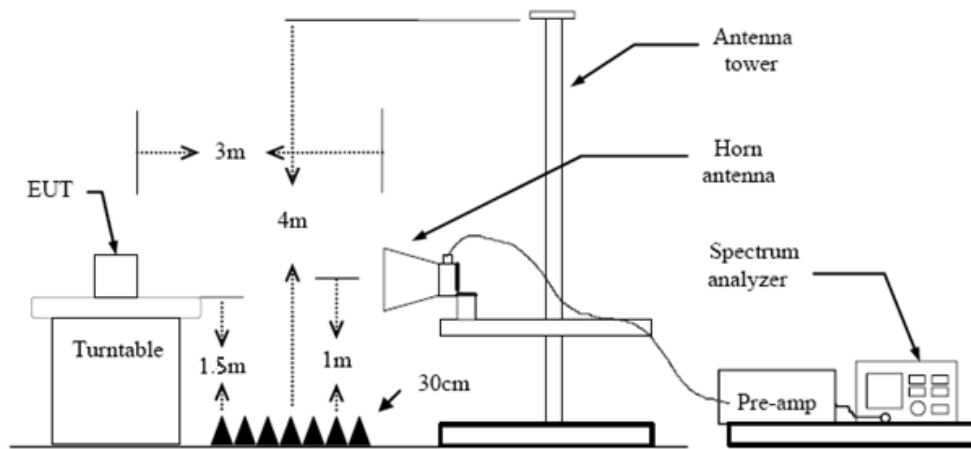

Test Procedure

1. The EUT was setup and tested according to ANSI C63.10:2013 requirements.
2. The EUT is placed on a turn table which is 1.5 meter above ground. The turn table is rotated 360 degrees to determine the position of the maximum emission level.
3. The EUT was positioned such that the distance from antenna to the EUT was 3 meters.
4. The antenna is scanned from 1 meter to 4 meters to find out the maximum emission level. This is repeated for both horizontal and vertical polarization of the antenna. In order to find the maximum emission, all of the interface cables were manipulated according to ANSI C63.10:2013 on radiated measurement.
5. The receiver set as follow:
 RBW=1MHz, VBW=3MHz Peak detector for Peak value.
 RBW=1MHz, VBW see note 1 with Peak Detector for Average Value.

Note 1: For measurements above 1 GHz the resolution bandwidth is set to 1 MHz, then the video bandwidth is set to 3 MHz for peak measurements and 1 MHz resolution bandwidth with 1/T video bandwidth with peak detector for average measurements. For the Duty Cycle please refer to clause 3.7 Duty Cycle.

Test Mode

Please refer to the clause 2.4.



Test Results

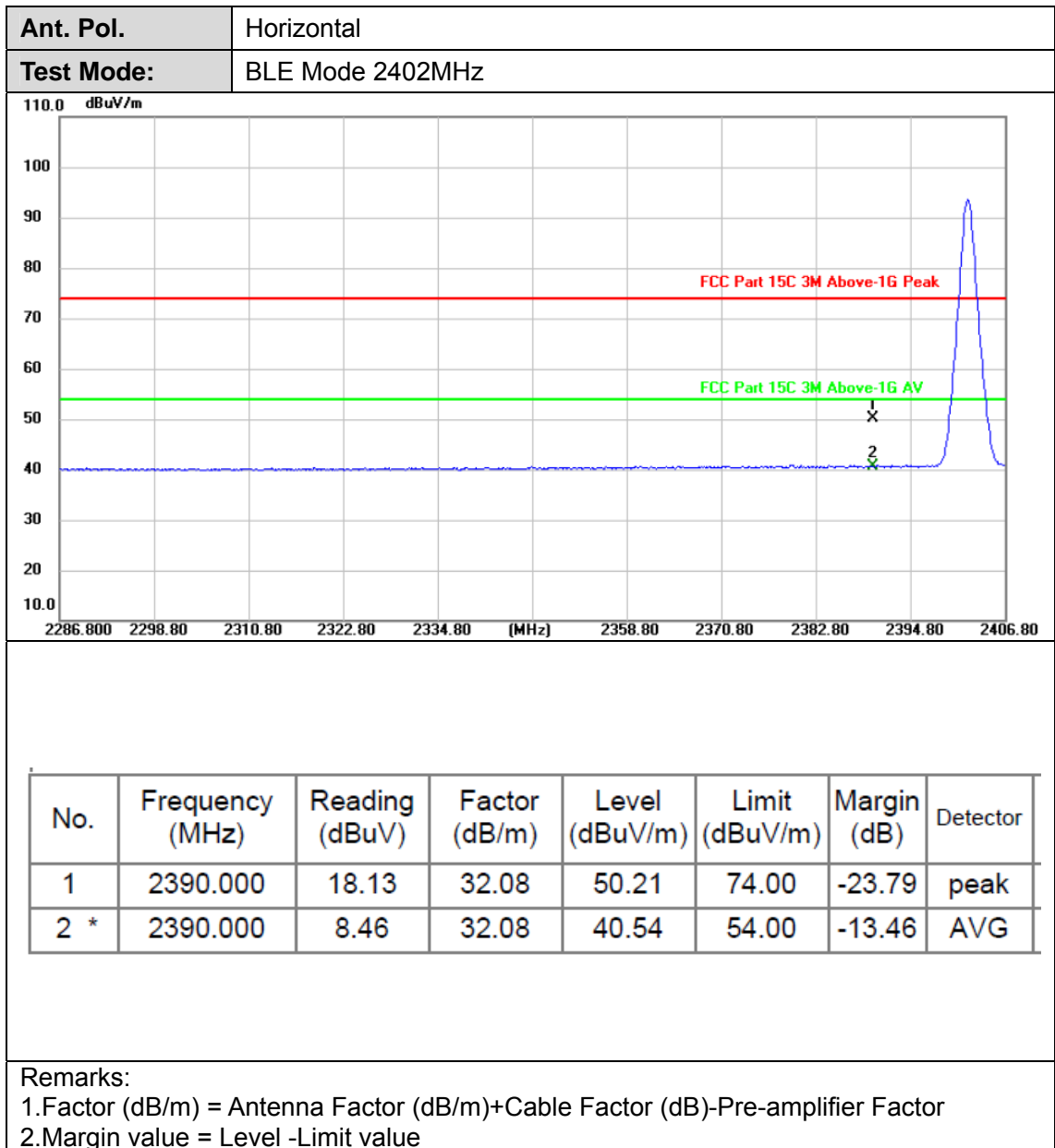

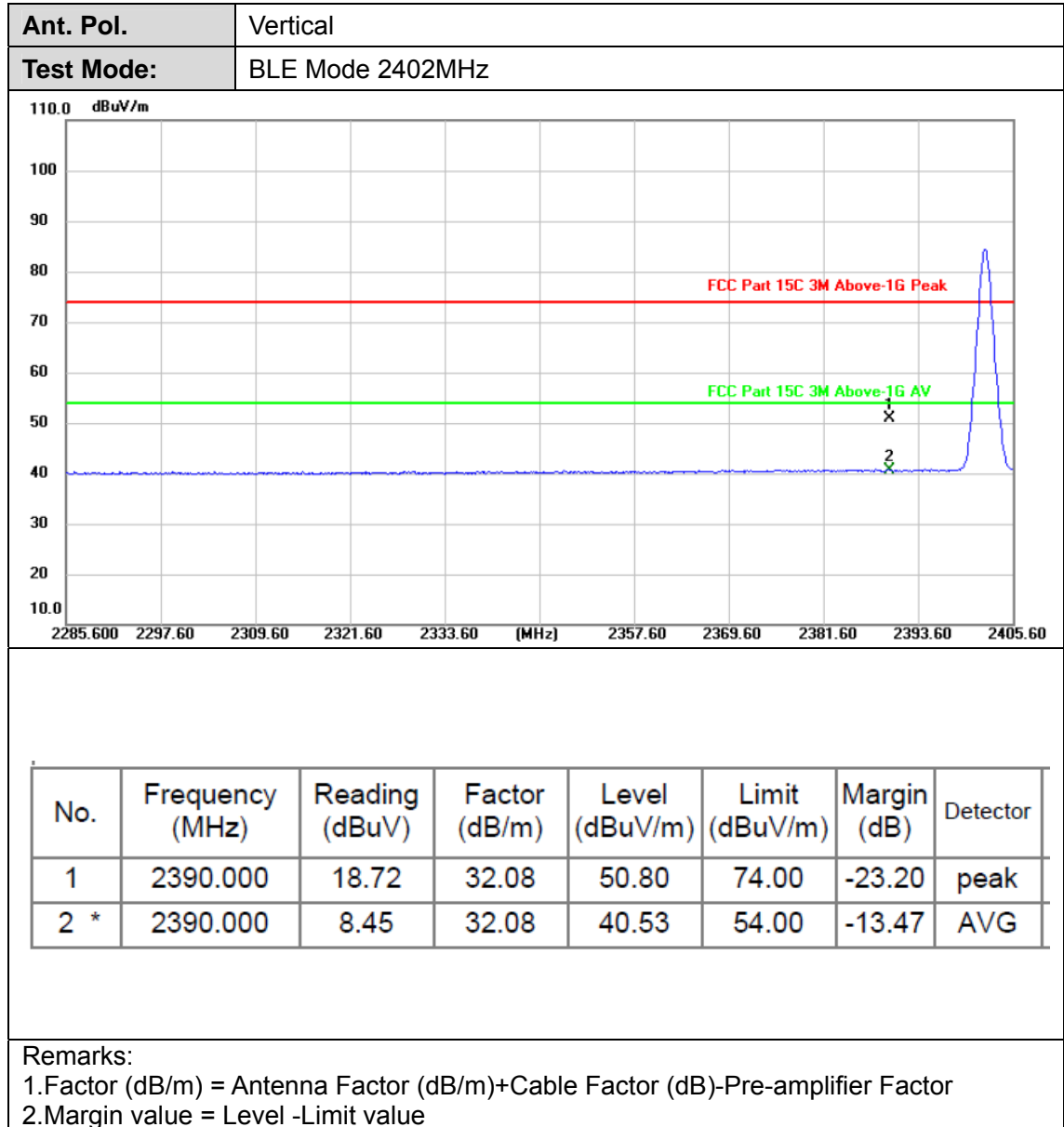



Ant. Pol.	Horizontal																														
Test Mode:	BLE Mode 2480 MHz																														
<table border="1"> <thead> <tr> <th>No.</th> <th>Frequency (MHz)</th> <th>Reading (dBuV)</th> <th>Factor (dB/m)</th> <th>Level (dBuV/m)</th> <th>Limit (dBuV/m)</th> <th>Margin (dB)</th> <th>Detector</th> </tr> </thead> <tbody> <tr> <td>1</td> <td>2483.500</td> <td>20.13</td> <td>32.52</td> <td>52.65</td> <td>74.00</td> <td>-21.35</td> <td>peak</td> </tr> <tr> <td>2 *</td> <td>2483.500</td> <td>9.48</td> <td>32.52</td> <td>42.00</td> <td>54.00</td> <td>-12.00</td> <td>AVG</td> </tr> </tbody> </table>								No.	Frequency (MHz)	Reading (dBuV)	Factor (dB/m)	Level (dBuV/m)	Limit (dBuV/m)	Margin (dB)	Detector	1	2483.500	20.13	32.52	52.65	74.00	-21.35	peak	2 *	2483.500	9.48	32.52	42.00	54.00	-12.00	AVG
No.	Frequency (MHz)	Reading (dBuV)	Factor (dB/m)	Level (dBuV/m)	Limit (dBuV/m)	Margin (dB)	Detector																								
1	2483.500	20.13	32.52	52.65	74.00	-21.35	peak																								
2 *	2483.500	9.48	32.52	42.00	54.00	-12.00	AVG																								
Remarks: 1. Factor (dB/m) = Antenna Factor (dB/m)+Cable Factor (dB)-Pre-amplifier Factor 2. Margin value = Level -Limit value																															

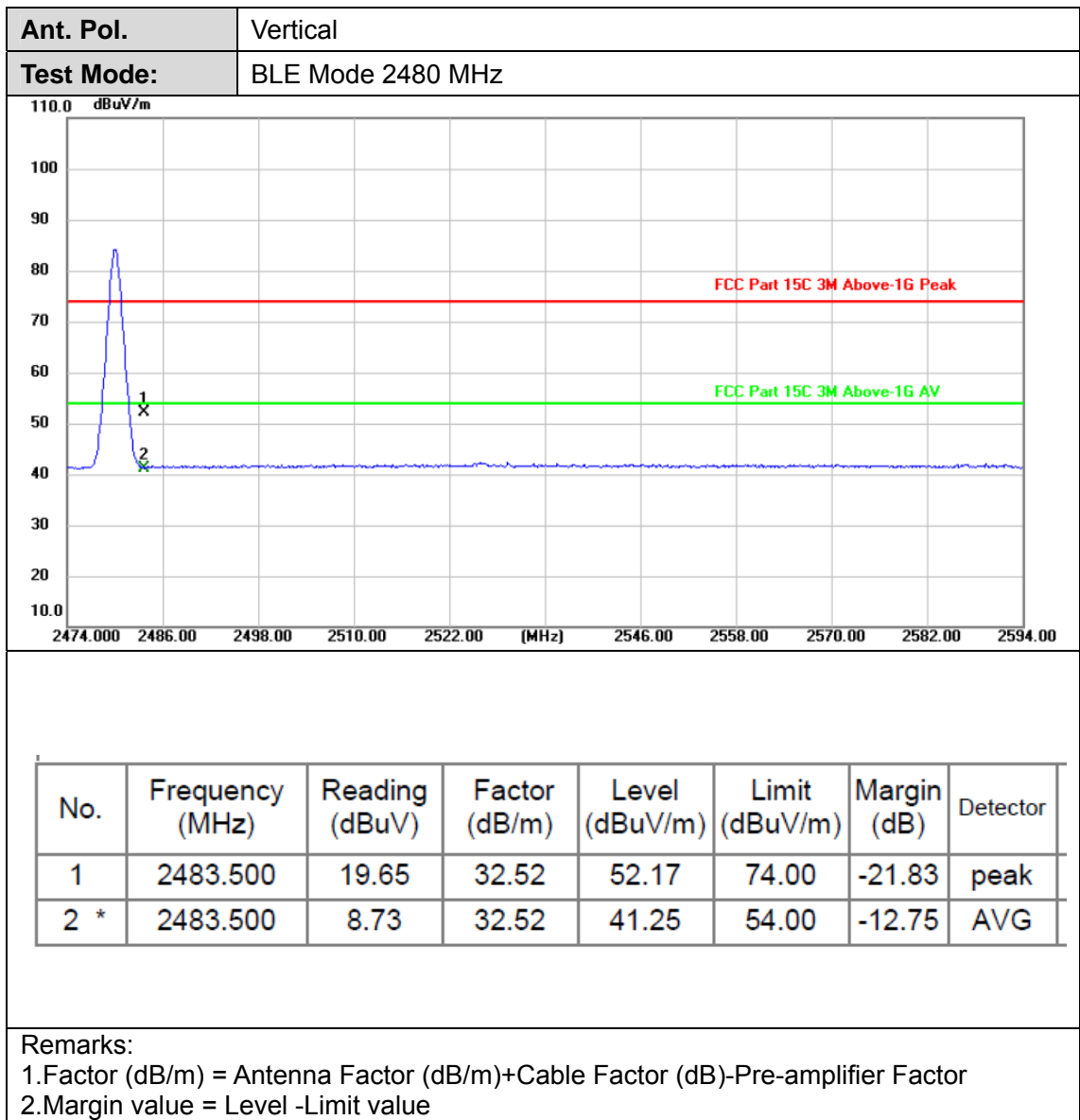

3.4. Band edge and Spurious Emissions (Conducted)

Limit

FCC CFR Title 47 Part 15 Subpart C Section 15.247 (d): In any 100 kHz bandwidth outside the frequency band in which the spread spectrum intentional radiator is operating, the radio frequency power that is produced by the intentional radiator shall be at least 20 dB below that in the 100 kHz bandwidth within the band that contains the highest level of the desired power, based on either an RF conducted or a radiated measurement.

Test Configuration

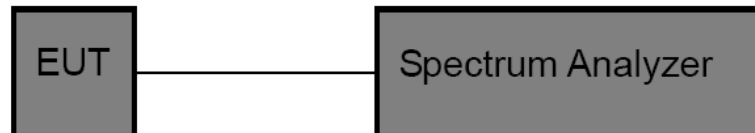

Test Procedure

1. The transmitter output was connected to the spectrum analyzer through an attenuator, the path loss was compensated to the results for each measurement.
2. Set to the maximum power setting and enable the EUT transmit continuously
3. Use the following spectrum analyzer settings:
RBW = 100 kHz, VBW ≥ RBW, scan up through 10th harmonic.
Sweep = auto, Detector function = peak, Trace = max hold
4. Measure and record the results in the test report.

Test Mode

Please refer to the clause 2.4.

Test Results

(1) Band edge Conducted Test

Note: This test item not applicable.

(2) Conducted Spurious Emissions Test

Note: This test item not applicable.

3.5. DTS Bandwidth

Limit

FCC CFR Title 47 Part 15 Subpart C Section 15.247 (a)(2)/ RSS-247 5.2 a:

Test Item	Limit	Frequency Range(MHz)
DTS Bandwidth	≥ 500 KHz (6dB bandwidth)	2400~2483.5

Test Configuration

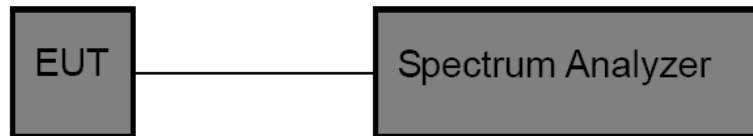

Test Procedure

- The EUT was directly connected to the spectrum analyzer and antenna output port as show in the block diagram above.
- DTS Spectrum Setting:
 - Set RBW = 100 kHz.
 - Set the video bandwidth (VBW) ≥ 3 RBW.
 - Detector = Peak.
 - Trace mode = Max hold.
 - Sweep = Auto couple.
- OCB Spectrum Setting:
 - Set RBW = 1% ~ 5% occupied bandwidth.
 - Set the video bandwidth (VBW) ≥ 3 RBW.
 - Detector = Peak.
 - Trace mode = Max hold.
 - Sweep = Auto couple.

NOTE: The EUT was set to continuously transmitting in each mode and low, Middle and high channel for the test.

Test Mode

Please refer to the clause 2.4.

Test Results

Note: This test item not applicable.



3.6. Peak Output Power

Limit

FCC CFR Title 47 Part 15 Subpart C Section 15.247 (b)(3)/ RSS-247 5.4 d:

Section	Test Item	Limit	Frequency Range(MHz)
CFR 47 FCC 15.247(b)(3)	Maximum conducted output power	1 Watt or 30dBm	2400~2483.5
ISED RSS-247 5.4 d	EIRP	4 Watt or 36dBm	2400~2483.5

Test Configuration

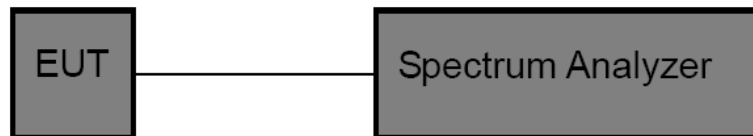

Test Procedure

- The EUT was directly connected to the spectrum analyzer and antenna output port as show in the block diagram above.
- Spectrum Setting:
 Peak Detector: $RBW \geq DTS \text{ Bandwidth}$, $VBW \geq 3 * RBW$.
 Sweep time=Auto.
 Detector= Peak.
 Trace mode= Maxhold.
 Allow trace to fully stabilize. Then use the peak marker function to determine the maximum amplitude level.

Test Mode

Please refer to the clause 2.4.

Test Result

Note: This test item not applicable.

3.7. Power Spectral Density

Limit

FCC CFR Title 47 Part 15 Subpart C Section 15.247 (e)/ RSS-247 5.2 b:

Test Item	Limit	Frequency Range(MHz)
Power Spectral Density	8dBm(in any 3 kHz)	2400~2483.5

Test Configuration

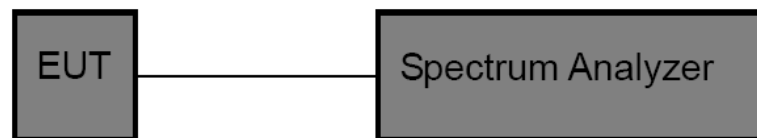

Test Procedure

1. The EUT was directly connected to the spectrum analyzer and antenna output port as show in the block diagram above.
2. The EUT was directly connected to the Spectrum Analyzer and antenna output port as show in the block diagram above. The measurement according to section 10.2 of KDB 558074 D01 DTS Meas Guidance v05r02.
3. Spectrum Setting:
Set analyzer center frequency to DTS channel center frequency.
Set the span to 1.5 times the DTS bandwidth.
Set the RBW to: 3 kHz
Set the VBW to: 10 kHz
Detector: peak
Sweep time: auto
Allow trace to fully stabilize. Then use the peak marker function to determine the maximum amplitude level.

Test Mode

Please refer to the clause 2.4.

Test Result

Note: This test item not applicable.



3.8. Duty Cycle

Limit

None, for report purposes only.

Test Configuration

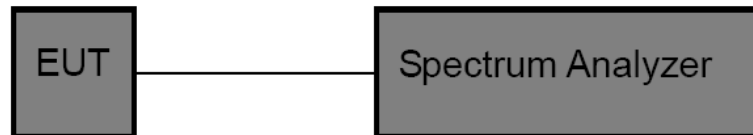

Test Procedure

1. The EUT was directly connected to the spectrum analyzer and antenna output port as show in the block diagram above.
2. The EUT was directly connected to the Spectrum Analyzer and antenna output port as show in the block diagram above. The measurement according to section 10.2 of KDB 558074 D01 DTS Meas Guidance v05r02.
3. Spectrum Setting:
Set analyzer center frequency to test channel center frequency.
Set the span to 0Hz
Set the RBW to 10MHz
Set the VBW to 10MHz
Detector: Peak
Sweep time: Auto
Allow trace to fully stabilize. Then use the peak marker function to determine the maximum amplitude level.

Test Mode

Please refer to the clause 2.4.

Test Result

Note: This test item not applicable.



3.9. Antenna requirement

Requirement

FCC CFR Title 47 Part 15 Subpart C Section 15.203:

An intentional radiator shall be designed to ensure that no antenna other than that furnished by the responsible party shall be used with the device. The use of a permanently attached antenna or of antenna that uses a unique coupling to the intentional radiator, the manufacturer may design the unit so that a broken antenna can be replaced by the user, but the use of a standard antenna jack or electrical connector is prohibited.

FCC CFR Title 47 Part 15 Subpart C Section 15.247(c) (1)(i):

(i) Systems operating in the 2400~2483.5 MHz band that is used exclusively for fixed. Point-to-point operations may employ transmitting antennas with directional gain greater than 6dBi provided the maximum conducted output power of the intentional radiator is reduced by 1 dB for every 3 dB that the directional gain of the antenna exceeds 6dBi.

Test Result

The directional gain of the antenna less than 6dBi, please refer to the EUT internal photographs antenna photo.

*****THE END*****