

**ELECTROMAGNETIC EMISSIONS COMPLIANCE REPORT
INTENTIONAL RADIATOR CERTIFICATION TO
FCC PART 15 SUBPARTC REQUIREMENT**

OF

Automotive Diagnosis Computer

MODEL No.: MAXGO

FCC ID: XUJMAXG

Trademark: MATCO TOOLS

REPORT NO.: ES140319173E1

ISSUE DATE: April 17, 2014

Prepared for

Launch Tech Co., Ltd.

**Launch Industrial Park, North of Wuhe Rd., Banxuegang, Longgang,
Shenzhen, China**

Prepared by

SHENZHEN EMTEK CO., LTD

**Bldg 69, Majialong Industry Zone, Nanshan District,
Shenzhen, Guangdong, China**

TEL: 86-755-26954280

FAX: 86-755-26954282

VERIFICATION OF COMPLIANCE

Applicant:	Launch Tech Co., Ltd. Launch Industrial Park, North of Wuhe Rd., Banxuegang, Longgang, Shenzhen, China
Manufacturer:	Launch Tech Co., Ltd. Launch Industrial Park, North of Wuhe Rd., Banxuegang, Longgang, Shenzhen, China
Product Description:	Automotive Diagnosis Computer
Model Number:	MAXGO
File Number:	ES140319173E1
Date of Test:	March 19, 2014 to March 31, 2014

We hereby certify that:

The above equipment was tested by SHENZHEN EMTEK CO., LTD. The test data, data evaluation, test procedures, and equipment configurations shown in this report were made in accordance with the procedures given in ANSI C63.4 (2009) and the energy emitted by the sample EUT tested as described in this report is in compliance with conducted and radiated emission limits of FCC Rules Part 15.247.

The test results of this report relate only to the tested sample identified in this report.

Date of Test : March 19, 2014 to March 31, 2014

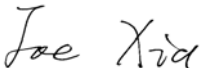
Prepared by : 
Joe Xia/Editor

Reviewer : 
June xie/Supervisor

Approve & Authorized Signer : 
Lisa Wang/Manager

Table of Contents

1	GENERAL INFORMATION	5
1.1	PRODUCT DESCRIPTION	5
1.2	RELATED SUBMITTAL(S) / GRANT (S).....	5
1.3	TEST METHODOLOGY	5
1.4	SPECIAL ACCESSORIES.....	5
1.5	EQUIPMENT MODIFICATIONS	5
1.6	TEST FACILITY	6
2.	SYSTEM TEST CONFIGURATION.....	7
2.1	EUT CONFIGURATION	7
2.2	EUT EXERCISE	7
2.3	TEST PROCEDURE.....	7
2.4	LIMITATION	7
2.5	CONFIGURATION OF TESTED SYSTEM	11
2.6	DESCRIPTION OF TEST MODES.....	12
3.	SUMMARY OF TEST RESULTS	13
4.	CONDUCTED EMISSIONS TEST	14
4.1	MEASUREMENT PROCEDURE:	14
4.2	TEST SET-UP (BLOCK DIAGRAM OF CONFIGURATION).....	14
4.3	MEASUREMENT EQUIPMENT USED:	14
4.4	CONDUCTED EMISSION LIMIT	14
4.5	MEASUREMENT RESULT:	15
5.	RADIATED EMISSION TEST	16
5.1	MEASUREMENT PROCEDURE.....	16
5.2	TEST SET-UP (BLOCK DIAGRAM OF CONFIGURATION).....	17
5.3	MEASUREMENT EQUIPMENT USED:	18
5.4	MEASUREMENT RESULT	19
6.	CHANNEL SEPARATION TEST	24
6.1	MEASUREMENT PROCEDURE.....	24
6.2	TEST SET-UP (BLOCK DIAGRAM OF CONFIGURATION).....	24
6.3	MEASUREMENT EQUIPMENT USED:	24
6.4	MEASUREMENT RESULTS:	24
7.	20DB BANDWIDTH TEST	31
7.1	MEASUREMENT PROCEDURE.....	31
7.2	TEST SET-UP (BLOCK DIAGRAM OF CONFIGURATION).....	31
7.3	MEASUREMENT EQUIPMENT USED:	31
7.4	MEASUREMENT RESULTS:	31

8.	QUANTITY OF HOPPING CHANNEL TEST	38
8.1	MEASUREMENT PROCEDURE.....	38
8.2	TEST SET-UP (BLOCK DIAGRAM OF CONFIGURATION).....	38
8.3	MEASUREMENT EQUIPMENT USED:	38
8.4	MEASUREMENT RESULTS:	38
9.	TIME OF OCCUPANCY (DWELL TIME) TEST.....	40
9.1	MEASUREMENT PROCEDURE.....	40
9.2	TEST SET-UP (BLOCK DIAGRAM OF CONFIGURATION).....	40
9.3	MEASUREMENT EQUIPMENT USED:	40
9.4	MEASUREMENT RESULTS:	40
10.	MAXIMUM PEAK OUTPUT POWER TEST.....	43
10.1	MEASUREMENT PROCEDURE	43
10.2	TEST SET-UP (BLOCK DIAGRAM OF CONFIGURATION).....	43
10.3	MEASUREMENT EQUIPMENT USED:.....	43
10.4	MEASUREMENT RESULTS:.....	43
11.	BAND EDGE TEST	45
11.1	MEASUREMENT PROCEDURE	45
11.2	TEST SET-UP (BLOCK DIAGRAM OF CONFIGURATION).....	45
11.3	MEASUREMENT EQUIPMENT USED:.....	45
11.4	MEASUREMENT RESULTS:.....	45
12.	ANTENNA PORT EMISSION	48
12.1	TEST EQUIPMENT	48
12.2	MEASURING INSTRUMENTS AND SETTING.....	48
12.3	TEST PROCEDURES	48
12.4	BLOCK DIAGRAM OF TEST SETUP.....	48
12.5	TEST RESULT.....	48
13.	ANTENNA APPLICATION.....	52
13.1	ANTENNA REQUIREMENT.....	52
13.2	RESULT	52

1 GENERAL INFORMATION

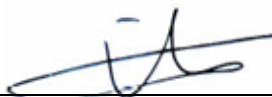
1.1 Product Description

A major technical descriptions of EUT is described as following:

- A). Operation Frequency: Bluetooth module: 2402-2480MHz;
Wifi module: 802.11b/g/n HT20: 2412-2462MHz;
802.11n HT40: 2422-2452MHz;
- B). Modulation: Bluetooth module: GFSK, 1/4π-DQPSK, 8DPSK;
Wifi module: OFDM with BPSK/QPSK/16QAM/64QAM for 802.11g/n,
DSSS with DBPSK/DQPSK/CCK for 802.11b
- C). Number of Channel: Bluetooth module: 79 channels;
Wifi module: 802.11b/g/n HT20: 11Channels;
802.11n HT40: 7 Channels
- D). RF Output Power: Bluetooth module: 2.20 dBm;
Wifi module: 18.34dBm(802.11b), 18.61dBm(802.11g),
18.72dBm(802.11n HT20), 12.78dBm(802.11n HT40)
- E). Antenna Type: Chip antenna
- F). Antenna GAIN: 1dBi
- G). Power Supply: 3.7V (Internal rechargeable lithium battery) or DC 5V from AC
120V, 60Hz with AC Adapter or DC 5V from PC.
- H). Adapter: Model: HKA01205024-2F
Input: AC 100-240V 50/60Hz 0.5A
Output: DC 5.0V 2.4A

1.2 Related Submittal(s) / Grant (s)

This submittal(s) (test report) is intended for FCC ID: XUJMAXG filing to comply with Section 15.247 of the FCC Part 15 Subpart C Rules. The composite system is compliance with Subpart B is authorized under a DOC procedure.

1.3 Test Methodology

Both conducted and radiated testing was performed according to the procedures in ANSI C63.4 (2009) and FCC Public Notice DA 00-705. Radiated testing was performed at an antenna to EUT distance 3 meters.

1.4 Special Accessories

Not available for this EUT intended for grant.

1.5 Equipment Modifications

Not available for this EUT intended for grant.

1.6 Test Facility

Site Description	:	
EMC Lab.	:	Accredited by CNAS, 2013.10.29 The certificate is valid until 2016.10.28 The Laboratory has been assessed and proved to be in compliance with CNAS/CL01:2006(identical to ISO/IEC17025:2005) The Certificate Registration Number is L2291 Accredited by TUV Rheinland Shenzhen 2010.5.25 The Laboratory has been assessed according to the requirements ISO/IEC 17025 Accredited by FCC, April 17, 2013 The Certificate Registration Number is 406365. Accredited by Industry Canada, March 5, 2010 The Certificate Registration Number is 4480A-2.
Name of Firm	:	SHENZHEN EMTEK CO., LTD
Site Location	:	Bldg 69, Majialong Industry Zone, Nanshan District, Shenzhen, Guangdong, China

2. System Test Configuration

2.1 EUT Configuration

The EUT configuration for testing is installed on RF field strength measurement to meet the Commissions requirement and operating in a manner which intends to maximize its emission characteristics in a continuous normal application.

2.2 EUT Exercise

The Transmitter was operated in the normal operating mode. The TX frequency was fixed which was for the purpose of the measurements.

2.3 Test Procedure

2.3.1 Conducted Emissions

The EUT is a placed on as turn table which is 0.8 m above ground plane. According to the requirements in Section 13.1.4.1 of ANSI C63.4-2009 Conducted emissions from the EUT measured in the frequency range between 0.15 MHz and 30MHz using CISPR Quasi-Peak and average detector mode.

2.3.2 Radiated Emissions

The EUT is a placed on as turn table which is 0.8 m above ground plane. The turn table shall rotate 360 degrees to determine the position of maximum emission level. EUT is set 3m away from the receiving antenna which varied from 1m to 4m to find out the highest emission. And also, each emission was to be maximized by changing the polarization of receiving antenna both horizontal and vertical. In order to find out the max. emission, the relative positions of this hand-held transmitter(EUT) was rotated through three orthogonal axes according to the requirements in Section 13.1.4.1 of ANSI C63.4-2009.

2.4 Limitation

(1) Channel Separation test

FCC Part 15, Subpart C Section 15.247(a)(1) Frequency hopping systems shall have hopping channel carrier frequencies separated by a minimum of 25kHz or the 20 Bandwidth of the hopping channel, whichever is greater.

Frequency Range (MHz)	Limit(kHz)
902-928	>25kHz
2400-2483.5	>25kHz
5725-5850	>25kHz

(2)

Frequency Range(MHz)	Quantity of Hopping Channel	20dB Bandwidth Limit(kHz)			
		50	25	15	75
902-928		<250	>250	NA	NA
2400-2483.5		NA	NA	>1000	<1000

(3) Quantity of Hopping Channel

FCC Part 15, Subpart C Section 15.247

Frequency Range (MHz)	Limit(Quantity of Hopping Channel)			
	20dB bandwidth <250kHz	20dB bandwidth >250kHz	20dB bandwidth <1MHz	20dB bandwidth >1MHz
902-928	50	25	NA	NA
2400-2483.5	NA	NA	75	15
5725-5850	NA	NA	75	NA

(4) Time of Occupancy(Dwell Time)

FCC Part 15, Subpart C Section 15.247

Frequency Range (MHz)	LIMIT(rms)		
	20dB bandwidth <250kHz(50Channel)	20dB bandwidth >250kHz(25Channel)	20dB bandwidth <1MHz(75Channel)
902-928	400(20S)	400(10S)	NA
2400-2483.5	NA	NA	400(30S)
5725-5850	NA	NA	400(30S)

Note: The “()”is all channel’s average time of occupancy.

(5) Maximum Peak Output Power

FCC Part 15, Subpart C Section 15.247

Frequency Range (MHz)	Quantity of Hopping Channel	LIMIT(W)			
		50	25	15	75
902-928		1(30dBm)	0.125(21dBm)	NA	NA
2400-2483.5		NA	NA	0.125(21dBm)	1(30dBm)
5725-5850		NA	NA	NA	1(30dBm)

(6) Band edge

FCC Part15, Subpart C Section 15.247, In any 100kHz bandwidth outside the frequency band in with the spread spectrum intentional radiator is operating, the radio frequency power that is produced by the intentional radiator shall be at least 20dB below that in the 100kHz bandwidth within the band that contains the highest level of the desired power, based on either an RF conducted or a radiated measurement, attenuation below the general limits specified in section 15.209(a) is not required. In addition, radiated emissions which fall in the restricted bands, as defined in section 15.205(a), must also comply with the radiated emission limits specified in section 15.209(a).

Operating Frequency Range(MHz)	Spurious emission frequency	Limit	
		Peak power ration to emission(dBc)	Emission level(dBuV/m)
902-928	<902	>20	NA
	>928	>20	NA
	960-1240	NA	54
2400-2483.5	<2400	>20	NA
	>2483.5-2500	NA	54
5725-5850	<5350-5460	NA	54
	<5725	>20	NA
	>5850	>20	NA

(7) Conducted Emission

Frequency(MHz)	Quasi-peak	Average
0.15-0.5	66-56	56-46
0.5-5.0	56	46
5.0-30.0	60	50

Note:

1. The lower limit shall apply at the transition frequencies
- 2.The limit decreases in line with the logarithm of the frequency in the range of 0.15 to 0.50MHz.

(8) Radiated Emission

FCC Part 15, Subpart C Section 15.209 limit of radiated emission for frequency below 1000GHz. The emissions from an intentional radiator shall not exceed the field strength level specified in the following table:

Frequency (MHz)	Field strength $\mu\text{V}/\text{m}$	Distance(m)	Field strength at 3m $\text{dB}\mu\text{V}/\text{m}$
0.009~0.490	2400/F(KHz)	300	
0.490~1.705	2400/F(KHz)	30	See the remark
1.705~30.0	30	30	
30-88	100	3	40
88-216	150	3	43.5
216-960	200	3	46
Above 960	500	3	54

- Remark 1. Emission level in $\text{dB}\mu\text{V}/\text{m}=20 \log (\mu\text{V}/\text{m})$
 : 2. Measurement was performed at an antenna to the closed point of EUT distance of meters.
 3. Distance extrapolation factor $=40\log(\text{Specific distance}/ \text{test distance})(\text{dB})$;
 Limit line= $\text{Specific limits}(\text{dB}\mu\text{V}) + \text{distance extrapolation factor}$.

2.5 Configuration of Tested System

Fig. 2-1 Configuration of Tested System

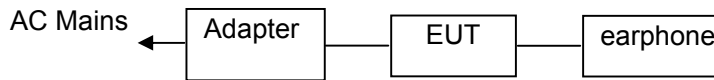

Table 2-1 Equipment Used in Tested System

Item	Equipment	Mfr/Brand	Model/Type No.	FCC ID	Series No.	Note
1.	AUTOMOTIVE DIAGNOSIS COMPUTER	MATCO TOOLS	MAXGO	XUJMAXG	N/A	EUT
2.	Earphone	N/A	N/A	N/A	N/A	

Note:

- (1) Unless otherwise denoted as EUT in 『Remark』 column, device(s) used in tested system is a support equipment.

2.6 Description of test modes

The EUT has been tested under TX operating condition.

This EUT is a FHSS system, were conducted to determine the final configuration from all possible combinations. We use software control the EUT, Let EUT hopping on and transmit with highest power, All the modes GFSK, 1/4Π-DQPSK, 8DPSK have been tested and the result was reported. 79 Channels are provided by EUT. The 3 channels of lower, medium and higher were chosen for test.

Channel	Frequency(MHz)
1	2402
40	2441
79	2480

3. Summary of Test Results

FCC Rule	Description Of Test	Result
15.247(a)(1)	Channel Separation test	Pass
15.247(a)(1)	20dB Bandwidth	Pass
15.247(a)(1)	Quantity of Hopping Channel	Pass
15.247(a)(1)	Time of Occupancy (Dwell Time)	Pass
15.247(b)(1)	Max Peak output Power test	Pass
15.247(d)	Band edge test	Pass
15.207	AC Power Conducted Emission	Pass
15.247(d)	Radiated Emission	Pass
§15.247(d)	Antenna Port Emission	Pass
15.203&15.247(b)	Antenna Application	Pass

4. Conducted Emissions Test

4.1 Measurement Procedure:

1. The EUT was placed on a table which is 0.8m above ground plane.
2. Maximum procedure was performed on the six highest emissions to ensure EUT compliance.
3. Repeat above procedures until all frequency measured were complete.

4.2 Test SET-UP (Block Diagram of Configuration)

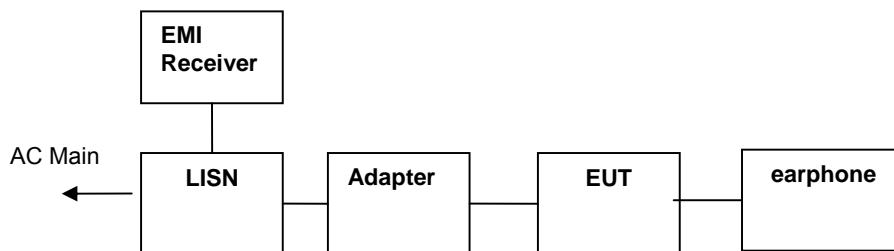

4.3 Measurement Equipment Used:

Conducted Emission Test Site # 4					
EQUIPMENT TYPE	MFR	MODEL NUMBER	SERIAL NUMBER	LAST CAL.	CAL DUE.
Test Receiver	Rohde & Schwarz	ESCS30	828985/018	05/29/2013	05/28/2014
L.I.S.N	Rohde & Schwarz	ESH2-Z5	834549/005	05/29/2013	05/28/2014
50ΩCoaxial Switch	Anritsu	MP59B	M20531	05/29/2013	05/28/2014

4.4 Conducted Emission Limit

(7) Conducted Emission

Frequency(MHz)	Quasi-peak	Average
0.15-0.5	66-56	56-46
0.5-5.0	56	46
5.0-30.0	60	50

Note:

1. The lower limit shall apply at the transition frequencies
2. The limit decreases in line with the logarithm of the frequency in the range of 0.15 to 0.50MHz.

4.5 Measurement Result:

Date of Test: March 20, 2014 Temperature: 28
 Frequency Detector: 0.15~30MHz Humidity: 60%
 Test Result: PASS Test Mode: TX Mode

Test Line	Frequency MHz	Emission Level QP dB(μ V)	Emission Level AV dB(μ V)	Limits QP dB(μ V)	Limits AV dB(μ V)	Over QP dB(μ V)	Over AV dB(μ V)
Line	0.60	46.26	27.87	56.00	46.00	-9.74	-18.13
	0.68	49.36	32.56	56.00	46.00	-6.64	-13.44
	0.77	48.49	29.62	56.00	46.00	-7.51	-16.38
	5.23	48.01	29.37	60.00	50.00	-11.99	-20.63
	12.15	50.70	36.90	60.00	50.00	-9.30	-13.10
	15.60	53.00	42.47	60.00	50.00	-7.00	-7.53
Neutral	0.65	45.11	27.46	56.00	46.00	-10.89	-18.54
	0.80	43.67	23.47	56.00	46.00	-12.33	-22.53
	5.36	45.14	28.17	60.00	50.00	-14.86	-21.83
	11.40	52.10	33.53	60.00	50.00	-7.90	-16.47
	15.18	52.10	41.62	60.00	50.00	-7.90	-8.38
	17.05	54.30	43.90	60.00	50.00	-5.70	-6.10

5. Radiated Emission Test

5.1 Measurement Procedure

1. The EUT was placed on a turn table which is 0.8m above ground plane.
2. Maximum procedure was performed on the six highest emissions to ensure EUT compliance.
3. And also, each emission was to be maximized by changing the polarization of receiving antenna both horizontal and vertical.
4. Repeat above procedures until all frequency measured was complete.

When spectrum scanned from 30 MHz to 1GHz setting resolution bandwidth 100 kHz and video bandwidth 300kHz. And spectrum scanned above 1GHz setting resolution bandwidth 1MHz, video bandwidth 3MHz.

5.2 Test SET-UP (Block Diagram of Configuration)

(A) Radiated Emission Test Set-Up, Frequency Below 30MHz

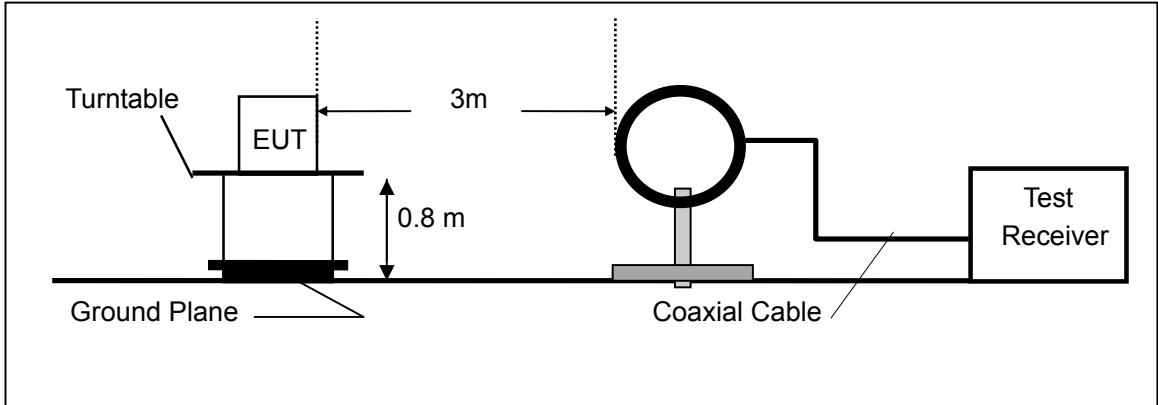

(B) Radiated Emission Test Set-Up, Frequency Below 1000MHz

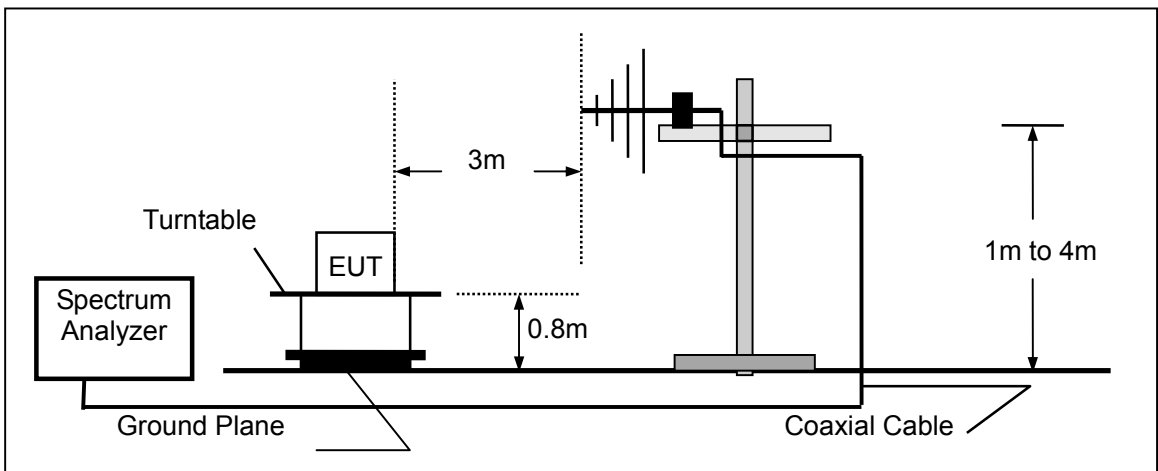

(C) Radiated Emission Test Set-Up, Frequency above 1000MHz

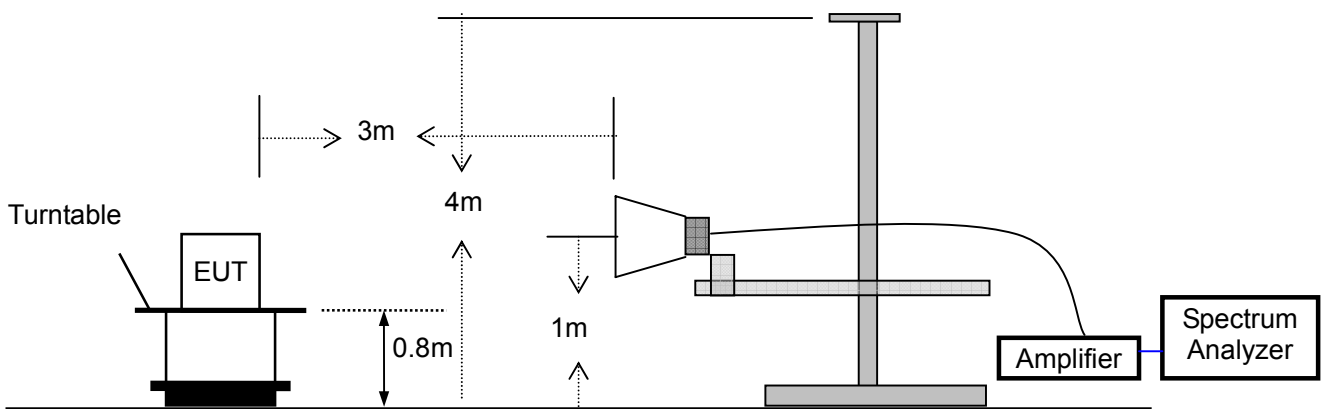

5.3 Measurement Equipment Used:

EQUIPMENT TYPE	MFR	MODEL NUMBER	SERIAL NUMBER	LAST CAL.	CAL DUE.
Spectrum Analyzer	Rohde & Schwarz	FSP7	839511/010	05/29/2013	05/28/2014
Spectrum Analyzer	HP	E4407B	839840481	05/29/2013	05/28/2014
EMI Test Receiver	Rohde & Schwarz	ESCS30	828985/018	05/29/2013	05/28/2014
Pre-Amplifier	HP	8447D	2944A07999	05/29/2013	05/28/2014
Bilog Antenna	Schwarzbeck	VULB9163	142	05/11/2013	05/10/2014
Loop Antenna	ARA	PLA-1030/B	1029	05/11/2013	05/10/2014
Horn Antenna	Schwarzbeck	BBHA 9170	BBHA9170399	05/11/2013	05/10/2014
Horn Antenna	Schwarzbeck	BBHA 9120	D143	05/11/2013	05/10/2014

5.4 Measurement Result

All the modulation modes were tested the data of the worst mode (GFSK) are recorded in the following pages and all modulation methods do not exceed the limits.

Operation Mode: Bluetooth Mode Test Date : March 22, 2014
 Frequency Range: 9KHz~30MHz Temperature : 28
 Test Result: PASS Humidity : 60 %
 Measured Distance: 3m Test By: WOLF

Freq. (MHz)	Ant.Pol. H/V	Emission Level (dBuV/m)	Limit 3m (dBuV/m)	Over (dB)
--	--	--	--	--

Note: the amplitude of spurious emission that is attenuated by more than 20dB below the permissible limit has no need to be reported.

Operation Mode: 2402MHz Test Date : March 22, 2014
 Frequency Range: 30~1000MHz Temperature : 28
 Test Result: PASS Humidity : 60 %
 Measured Distance: 3m Test By: WOLF
 Test mode: GFSK

Freq. (MHz)	Ant.Pol. H/V	Emission Level (dBuV/m)	Limit 3m (dBuV/m)	Margin (dB)	Note
31.55	V	36.05	40.00	-3.95	QP
71.97	V	31.34	40.00	-8.66	QP
171.46	V	33.15	43.50	-10.35	QP
249.18	V	32.96	46.00	-13.04	QP
474.58	V	37.61	46.00	-8.39	QP
600.50	V	36.37	46.00	-9.63	QP
31.55	H	32.37	40.00	-7.63	QP
180.79	H	34.81	43.50	-8.69	QP
249.18	H	42.17	46.00	-3.83	QP
270.95	H	36.80	46.00	-9.20	QP
474.58	H	37.80	46.00	-8.20	QP
679.78	H	36.24	46.00	-9.76	QP

- Note:**
- (1) All Readings are Peak Value.
 - (2) Emission Level= Reading Level+Probe Factor +Cable Loss.
 - (3) The average measurement was not performed when the peak measured data under the limit of average detection.
 - (4) EUT stood on the table position is the worst case result in the report.

Operation Mode: 2441MHz Test Date : March 22, 2014
 Frequency Range: 30~1000MHz Temperature : 28
 Test Result: PASS Humidity : 60 %
 Measured Distance: 3m Test By: WOLF
 Test mode: GFSK

Freq. (MHz)	Ant.Pol. H/V	Emission Level (dBuV/m)	Limit 3m (dBuV/m)	Margin (dB)	Note
31.55	V	34.90	40.00	-5.10	QP
71.97	V	30.18	40.00	-9.82	QP
171.46	V	31.98	43.50	-11.52	QP
249.18	V	31.83	46.00	-14.17	QP
474.58	V	36.45	46.00	-9.55	QP
600.50	V	35.22	46.00	-10.78	QP
31.55	H	31.23	40.00	-8.77	QP
180.79	H	33.64	43.50	-9.86	QP
249.18	H	40.99	46.00	-5.01	QP
270.95	H	35.65	46.00	-10.35	QP
474.58	H	36.69	46.00	-9.31	QP
679.78	H	35.12	46.00	-10.88	QP

- Note:**
- (1) All Readings are Peak Value.
 - (2) Emission Level= Reading Level+Probe Factor +Cable Loss.
 - (3) The average measurement was not performed when the peak measured data under the limit of average detection.
 - (4) EUT stood on the table position is the worst case result in the report.

Operation Mode: 2480MHz Test Date : March 22, 2014
 Frequency Range: 30~1000MHz Temperature : 28
 Test Result: PASS Humidity : 60 %
 Measured Distance: 3m Test By: WOLF
 Test mode: GFSK

Freq. (MHz)	Ant.Pol. H/V	Emission Level (dBuV/m)	Limit 3m (dBuV/m)	Margin (dB)	Note
31.55	V	33.72	40.00	-6.28	QP
71.97	V	29.03	40.00	-10.97	QP
171.46	V	30.87	43.50	-12.63	QP
249.18	V	30.71	46.00	-15.29	QP
474.58	V	35.29	46.00	-10.71	QP
600.50	V	34.09	46.00	-11.91	QP
31.55	H	30.08	40.00	-9.92	QP
180.79	H	32.52	43.50	-10.98	QP
249.18	H	39.86	46.00	-6.14	QP
270.95	H	34.49	46.00	-11.51	QP
474.58	H	35.55	46.00	-10.45	QP
679.78	H	33.95	46.00	-12.05	QP

- Note:**
- (1) All Readings are Peak Value.
 - (2) Emission Level= Reading Level+Probe Factor +Cable Loss.
 - (3) The average measurement was not performed when the peak measured data under the limit of average detection.
 - (4) EUT stood on the table position is the worst case result in the report.

Operation Mode: 2402MHz Test Date : March 22, 2014
 Frequency Range: 1-25GHz Temperature : 28
 Test Result: PASS Humidity : 60 %
 Measured Distance: 3m Test By: WOLF
 Test mode: GFSK

Freq. (MHz)	Ant.Pol. H/V	Emission Level(dBuV/m)		Limit 3m(dBuV/m)		Margin(dB)	
		PK	AV	PK	AV	PK	AV
4717.95	V	50.39	30.90	74.00	54.00	-23.61	-23.10
5326.92	V	49.52	30.66	74.00	54.00	-24.48	-23.34
5911.86	V	51.20	32.42	74.00	54.00	-22.80	-21.58
4717.95	H	51.75	32.47	74.00	54.00	-22.25	-21.53
4958.33	H	52.13	33.08	74.00	54.00	-21.87	-20.92
5134.62	H	51.15	32.06	74.00	54.00	-22.85	-21.94

No others harmonics emissions are higher than 20dB below the limits of 47 CFR Part 15.247.

Note: (1) All Readings are Peak Value and AV.
 (2) Emission Level= Reading Level+Probe Factor +Cable Loss.
 (3) Data of measurement within this frequency range shown “ -- ” in the table above means the reading of emissions are attenuated more than 20dB below the permissible limits or the field strength is too small to be measured.

Operation Mode: 2441MHz Test Date : March 22, 2014
 Frequency Range: 1-25GHz Temperature : 28
 Test Result: PASS Humidity : 60 %
 Measured Distance: 3m Test By: WOLF
 Test mode: GFSK

Freq. (MHz)	Ant.Pol. H/V	Emission Level(dBuV/m)		Limit 3m(dBuV/m)		Margin(dB)	
		PK	AV	PK	AV	PK	AV
4719.02	V	50.11	30.73	74.00	54.00	-23.89	-23.27
5325.55	V	49.29	30.54	74.00	54.00	-24.71	-23.46
5912.90	V	50.95	32.27	74.00	54.00	-23.05	-21.73
4719.00	H	51.54	32.31	74.00	54.00	-22.46	-21.69
4956.99	H	51.87	32.95	74.00	54.00	-22.13	-21.05
5135.68	H	50.91	31.86	74.00	54.00	-23.09	-22.14

No others harmonics emissions are higher than 20dB below the limits of 47 CFR Part 15.247.

Note: (1) All Readings are Peak Value and AV.
 (2) Emission Level= Reading Level+Probe Factor +Cable Loss.
 (3) Data of measurement within this frequency range shown “ -- ” in the table above means the reading of emissions are attenuated more than 20dB below the permissible limits or the field strength is too small to be measured.

Operation Mode: 2480MHz Test Date : March 22, 2014
 Frequency Range: 1-25GHz Temperature : 28
 Test Result: PASS Humidity : 60 %
 Measured Distance: 3m Test By: WOLF
 Test mode: GFSK

Freq. (MHz)	Ant.Pol. H/V	Emission Level(dBuV/m)		Limit 3m(dBuV/m)		Margin(dB)	
		PK	AV	PK	AV	PK	AV
4720.12	V	49.85	30.51	74.00	54.00	-24.15	-23.49
5324.12	V	49.14	30.26	74.00	54.00	-24.86	-23.74
5913.88	V	50.82	32.04	74.00	54.00	-23.18	-21.96
4717.56	H	51.38	32.06	74.00	54.00	-22.62	-21.94
4955.47	H	51.73	32.74	74.00	54.00	-22.27	-21.26
5136.69	H	50.72	31.57	74.00	54.00	-23.28	-22.43

No others harmonics emissions are higher than 20dB below the limits of 47 CFR Part 15.247.

- Note:**
- (1) All Readings are Peak Value and AV.
 - (2) Emission Level= Reading Level+Probe Factor +Cable Loss.
 - (3) Data of measurement within this frequency range shown “ -- ” in the table above means the reading of emissions are attenuated more than 20dB below the permissible limits or the field strength is too small to be measured.

6. Channel Separation test

6.1 Measurement Procedure

The EUT was operating in hopping mode or could be controlled its channel. Printed out the test result from the spectrum by hard copy function.

6.2 Test SET-UP (Block Diagram of Configuration)



6.3 Measurement Equipment Used:

EQUIPMENT TYPE	MFR	MODEL NUMBER	SERIAL NUMBER	LAST CAL.	CAL DUE.
Spectrum Analyzer	Agilent	E4407B	88156318	05/29/2013	05/28/2014

6.4 Measurement Results:

The following table is the setting of spectrum analyzer.

EMI Test Receiver	Setting
Attenuation	Auto
RB	100kHz
VB	300kHz
Detector	Peak
Trace	Max hold

All the modes GFSK, 1/4Π-DQPSK,8DPSK have been tested and the result recorded refer to attached data chart.

Spectrum Detector: PK Test Date : March 22, 2014
 Test By: Jack Temperature : 25
 Test Result: PASS Humidity : 55 %
 Modulation: GFSK

Channel number	Channel frequency (MHz)	Separation Read Value (kHz)	Separation Limit 20dB Down BW(kHz)
1	2402	1000.00	>837.935
40	2441	1000.00	>839.810
79	2480	1000.00	>813.513

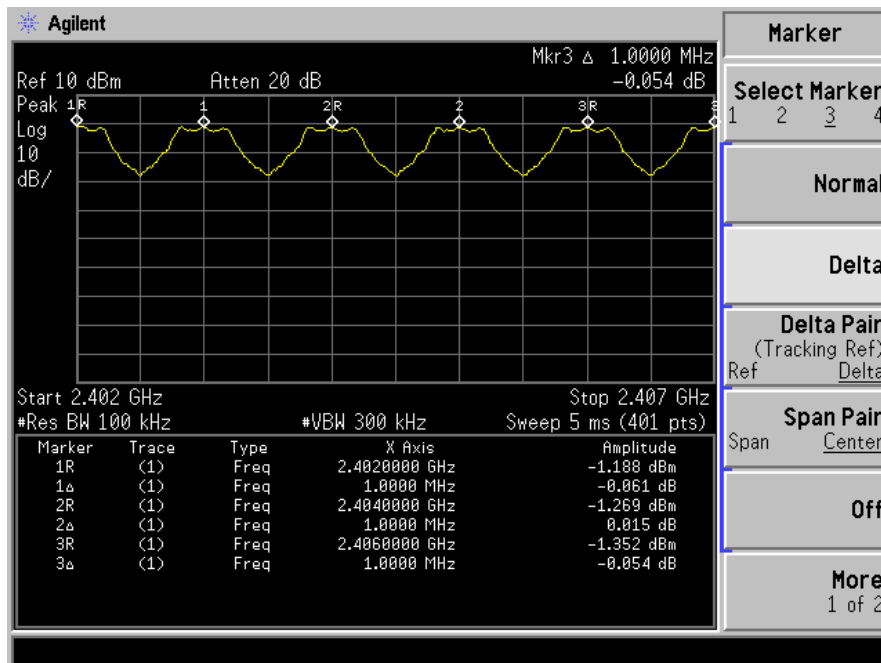

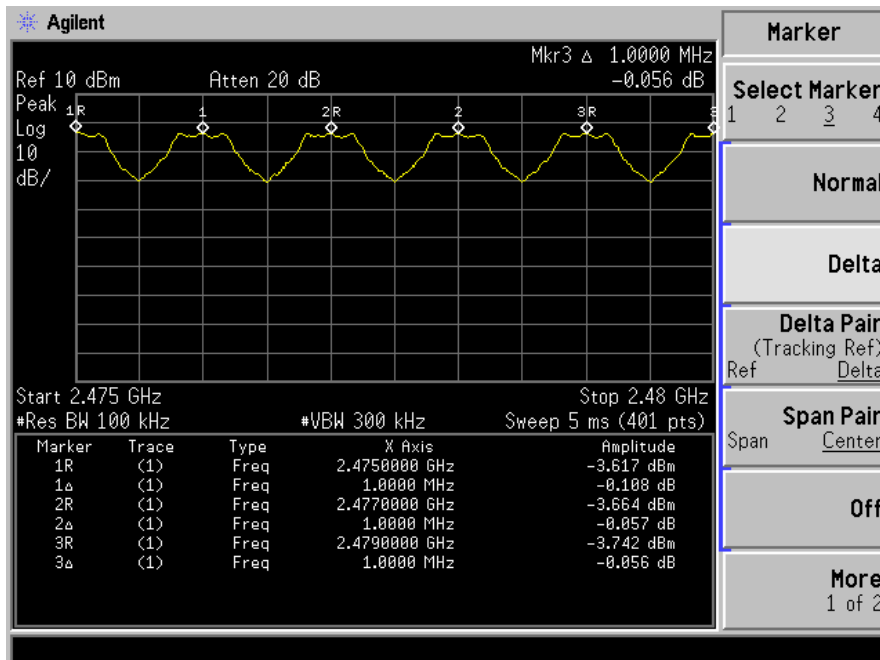
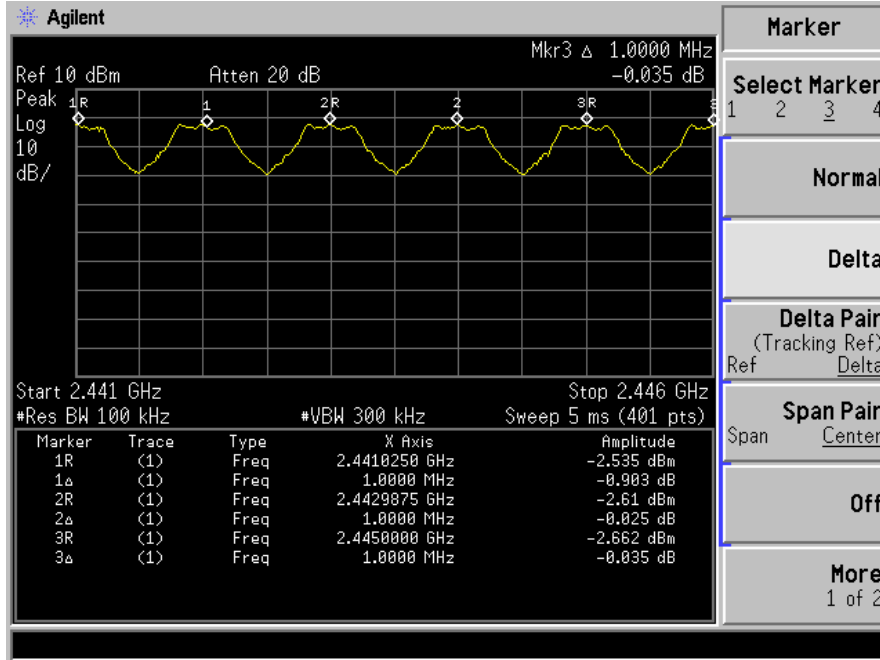

Spectrum Detector: PK Test Date : March 22, 2014
 Test By: Jack Temperature : 25
 Test Result: PASS Humidity : 55 %
 Modulation: 1/4πDQPSK

Channel number	Channel frequency (MHz)	Separation Read Value (kHz)	Separation Limit 2/3 20dB Down BW(kHz)
1	2402	1000.00	>826.67
40	2441	1000.00	>804.00
79	2480	1000.00	>798.00

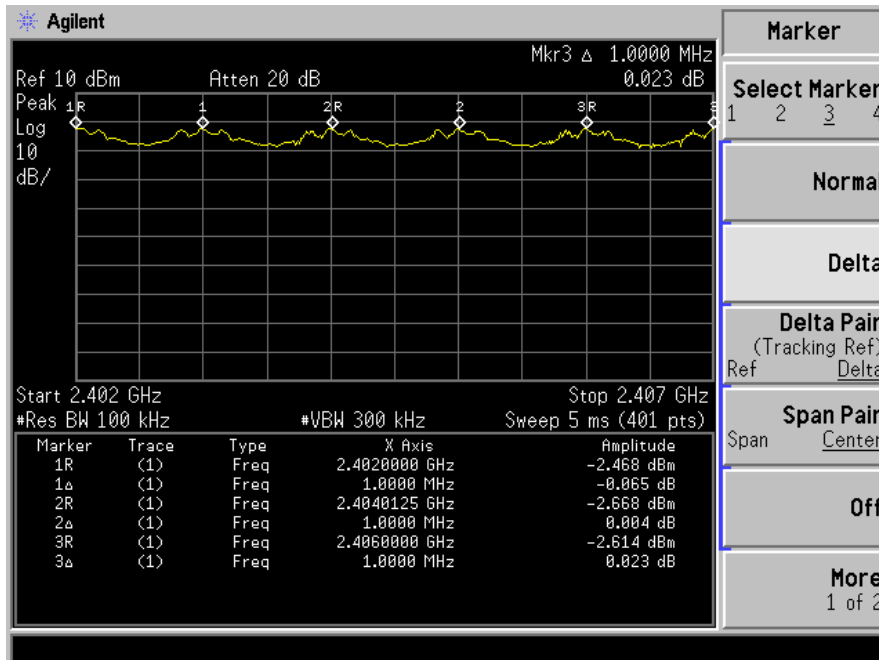

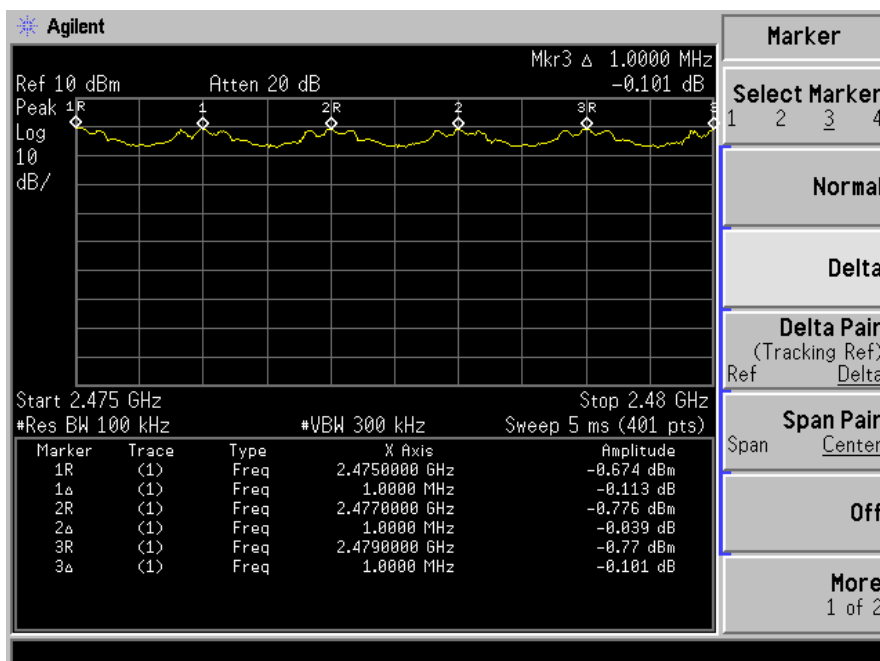
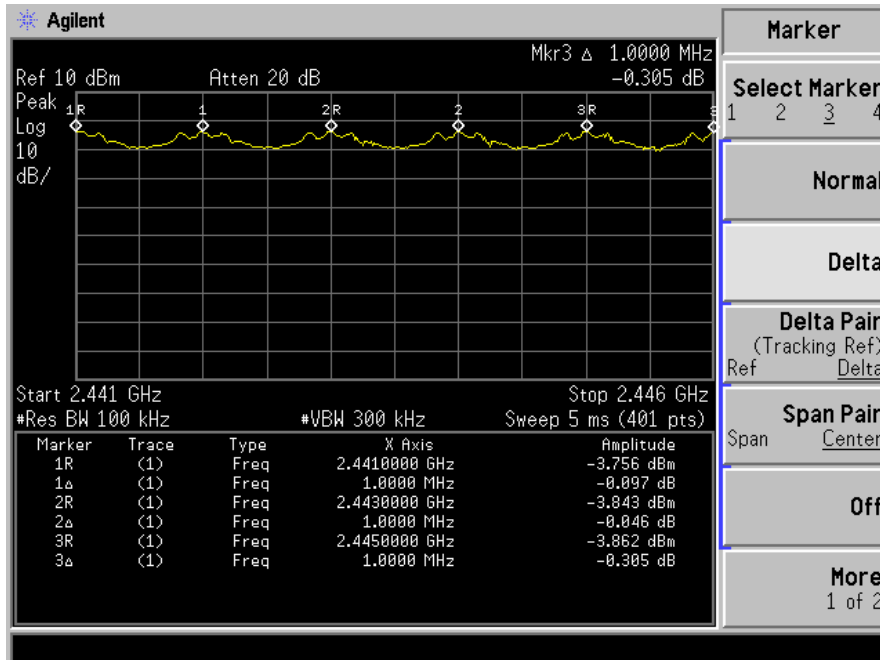

Spectrum Detector: PK Test Date : March 22, 2014
 Test By: Jack Temperature : 25
 Test Result: PASS Humidity : 55 %
 Modulation: 8DPSK

Channel number	Channel frequency (MHz)	Separation Read Value (kHz)	Separation Limit 2/3 20dB Down BW(kHz)
1	2402	1000.00	>809.33
40	2441	1000.00	>806.67
79	2480	1000.00	>802.67

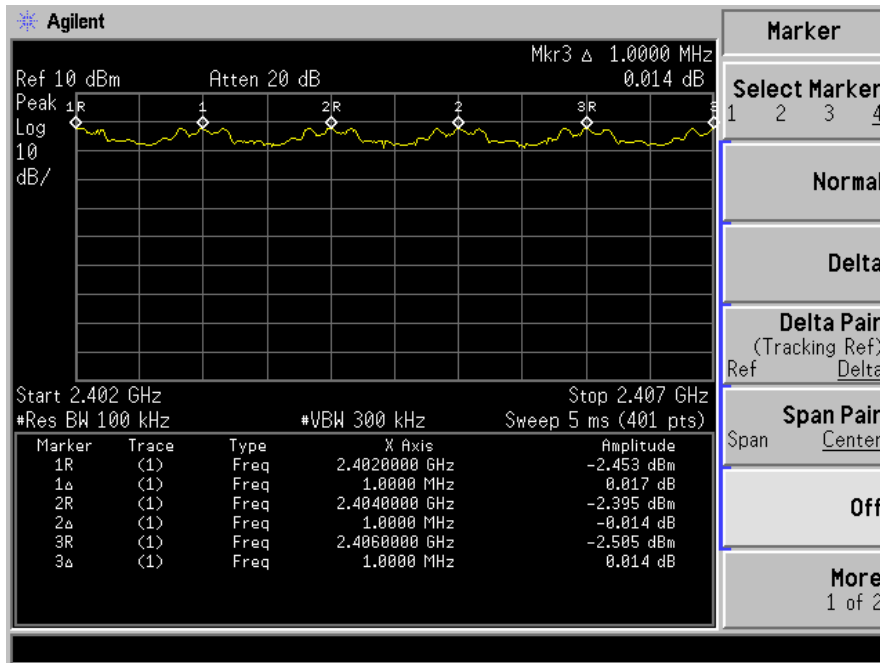

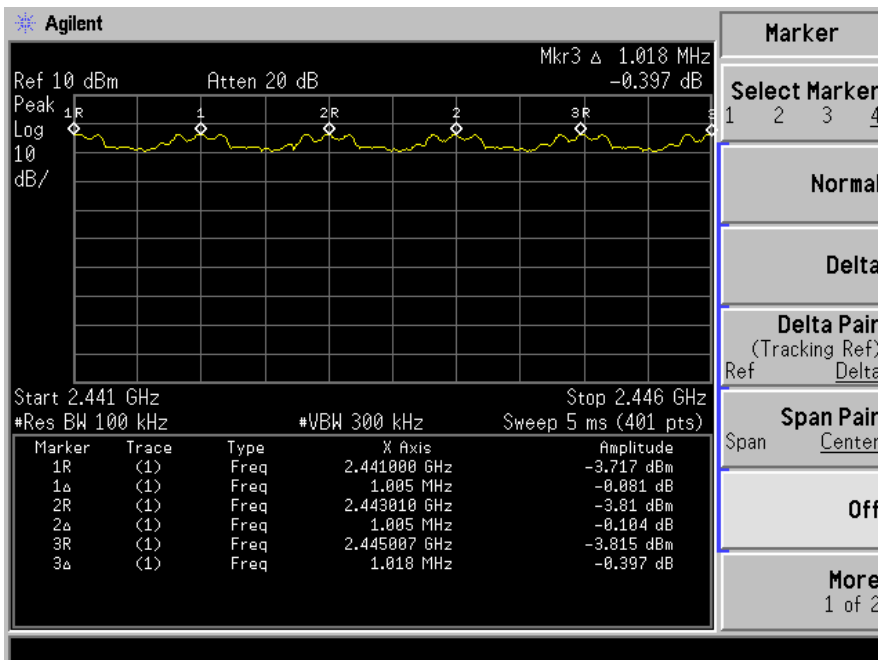
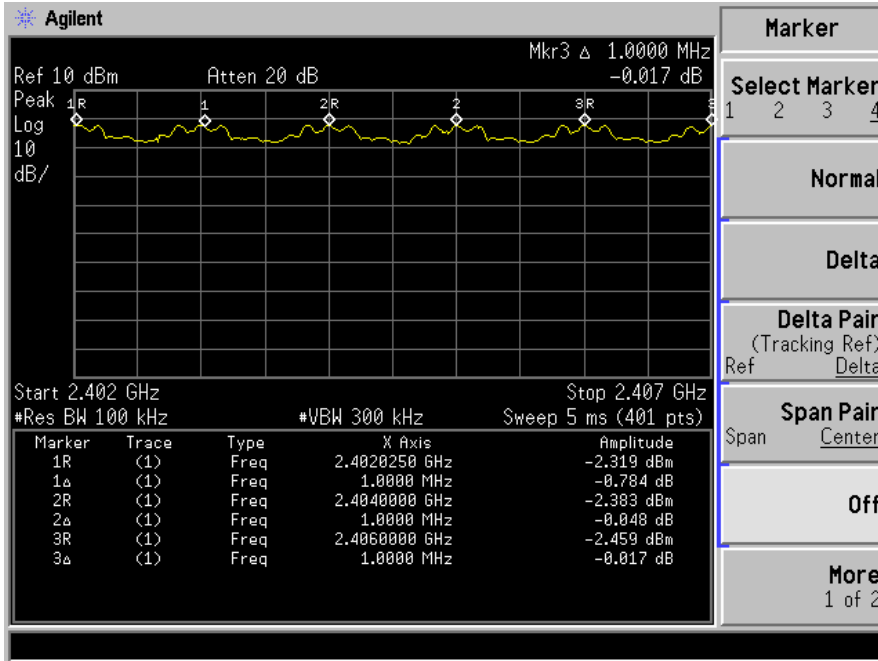

7. 20dB Bandwidth test

7.1 Measurement Procedure

The EUT was operating in hopping mode or could be controlled its channel. Printed out the test result from the spectrum by hard copy function.

7.2 Test SET-UP (Block Diagram of Configuration)

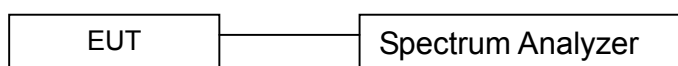

7.3 Measurement Equipment Used:

EQUIPMENT TYPE	MFR	MODEL NUMBER	SERIAL NUMBER	LAST CAL.	CAL DUE.
Spectrum Analyzer	Agilent	E4407B	88156318	05/29/2013	05/28/2014

7.4 Measurement Results:

The following table is the setting of spectrum analyzer.

EMI Test Receiver	Setting
Attenuation	Auto
Span	3MHz
RB	30kHz
VB	100kHz
Detector	Peak
Trace	Max hold

All the modes GFSK, 1/4Π-DQPSK,8DPSK have been tested and the result recorded in the following pages.

7.4.1. 20dB Bandwidth test data Chart:

Refer to attached data chart.

Spectrum Detector:	PK	Test Date :	March 22, 2014
Test By:	Jack	Temperature :	25
Test Result:	PASS	Humidity :	55 %
Modulation:	GFSK		

Channel number	Channel frequency (MHz)	20dB Down BW(kHz)
1	2402	837.935
40	2441	839.810
79	2480	813.513

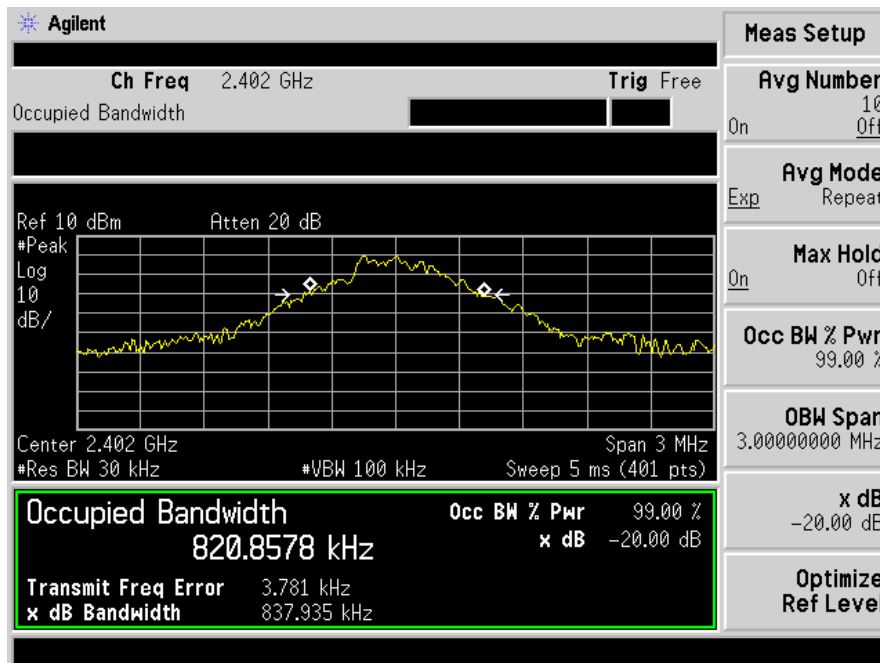

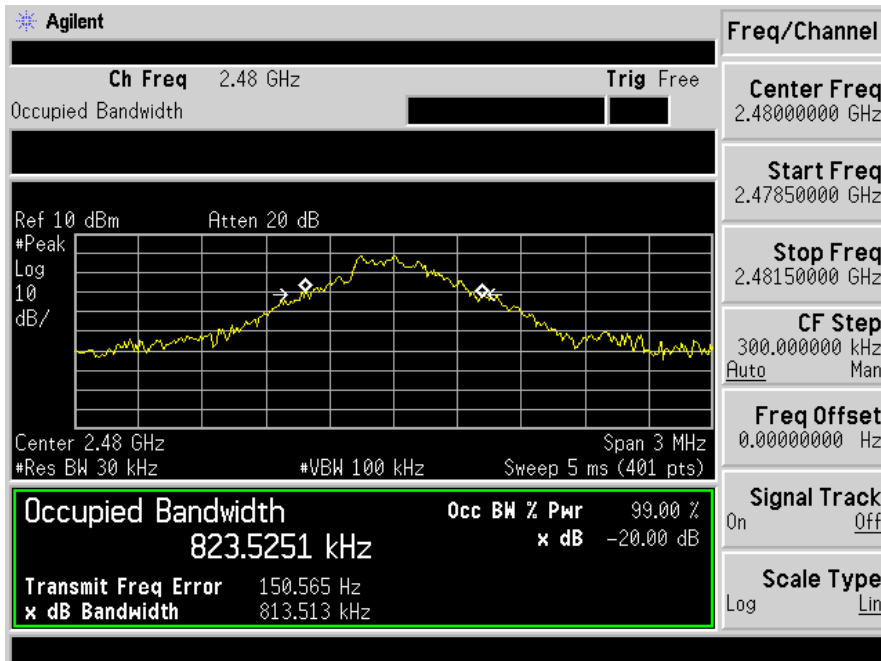
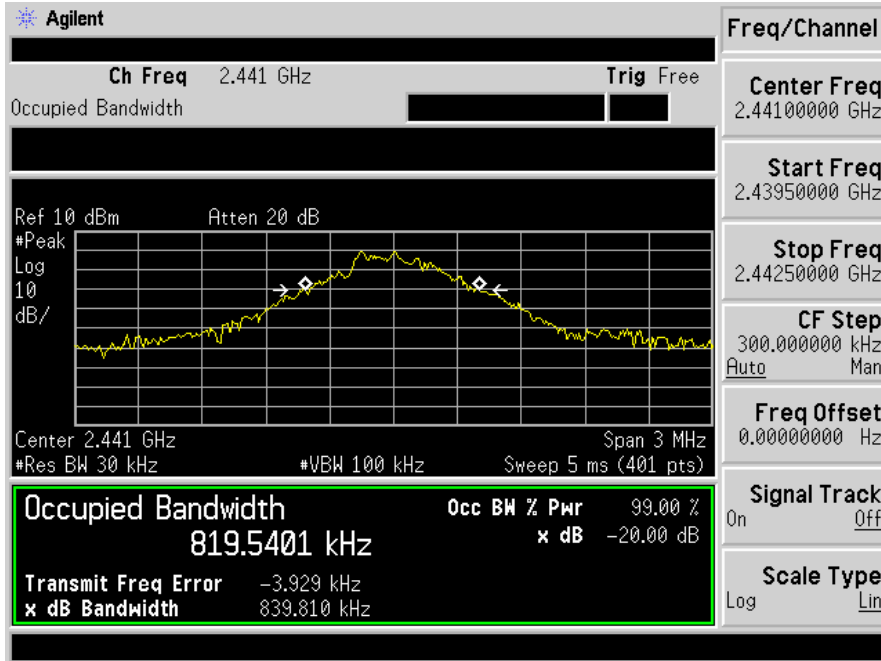

Spectrum Detector: PK Test Date : March 22, 2014
 Test By: Jack Temperature : 25
 Test Result: PASS Humidity : 55 %
 Modulation: 1/4Π-DQPSK

Channel number	Channel frequency (MHz)	20dB Down BW(kHz)
1	2402	1240.00
40	2441	1206.00
79	2480	1197.00

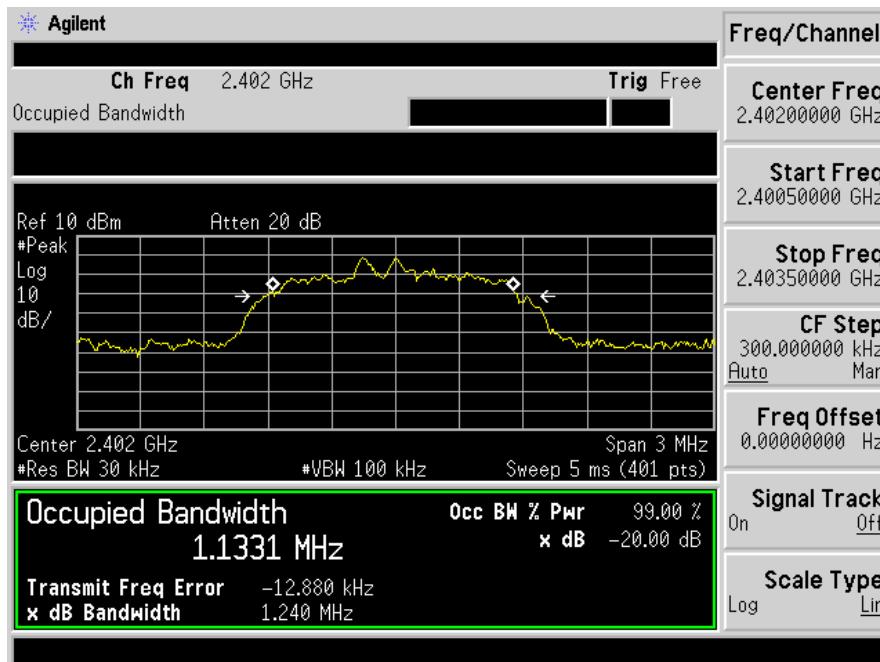

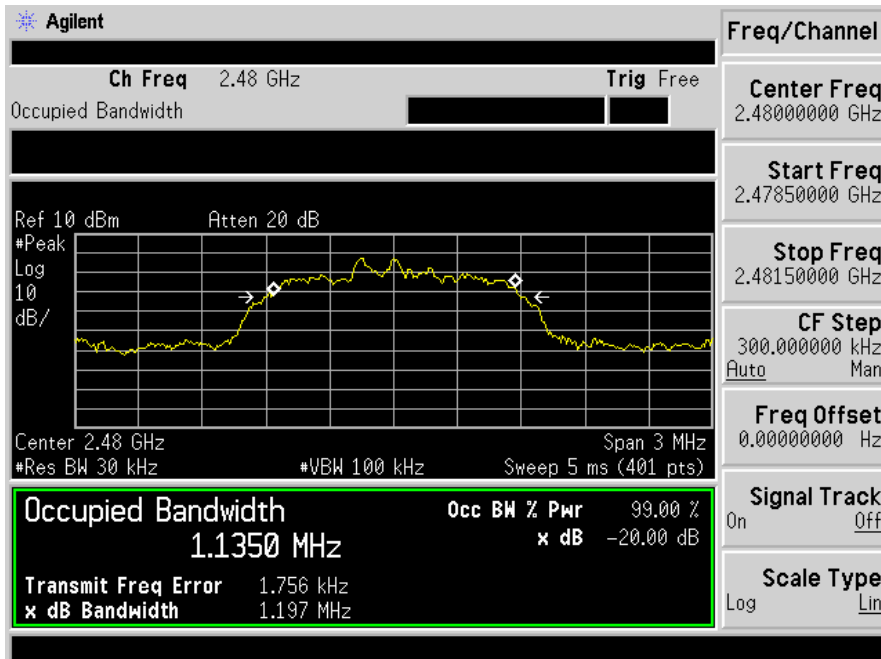
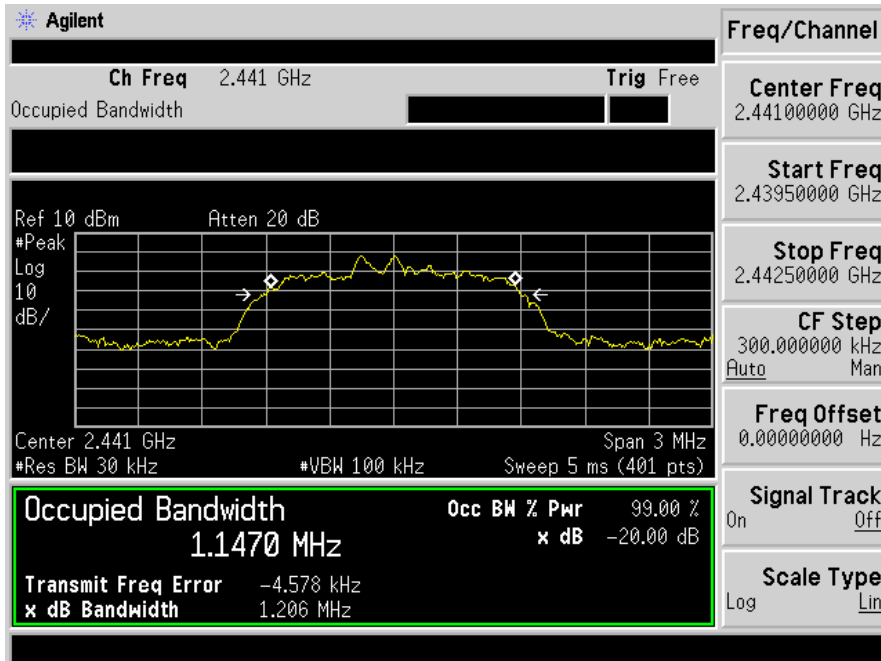

Spectrum Detector: PK Test Date : March 22, 2014
 Test By: Jack Temperature : 25
 Test Result: PASS Humidity : 55 %
 Modulation: 8DPSK

Channel number	Channel frequency (MHz)	20dB Down BW(kHz)
1	2402	1214.00
40	2441	1210.00
79	2480	1204.00

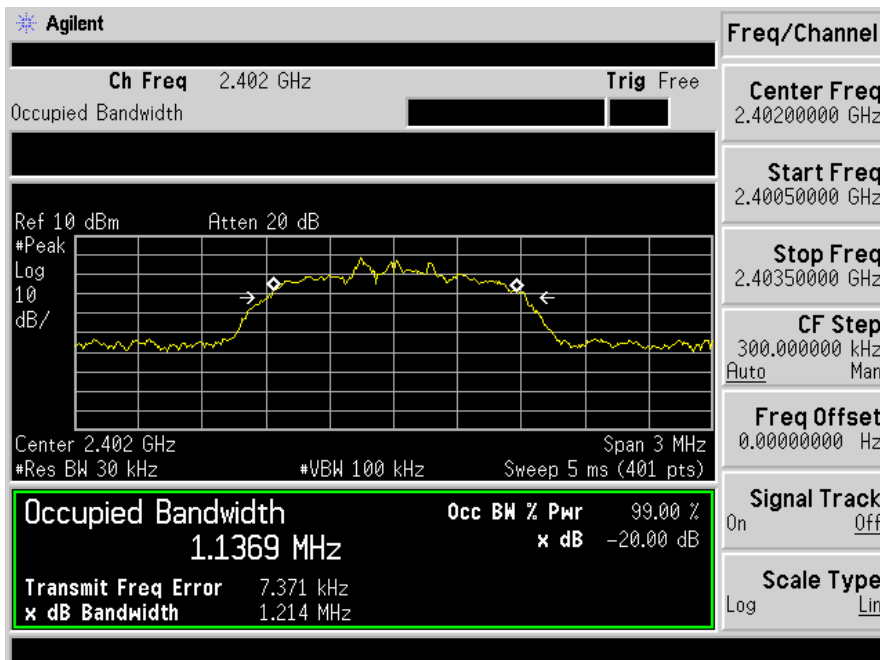

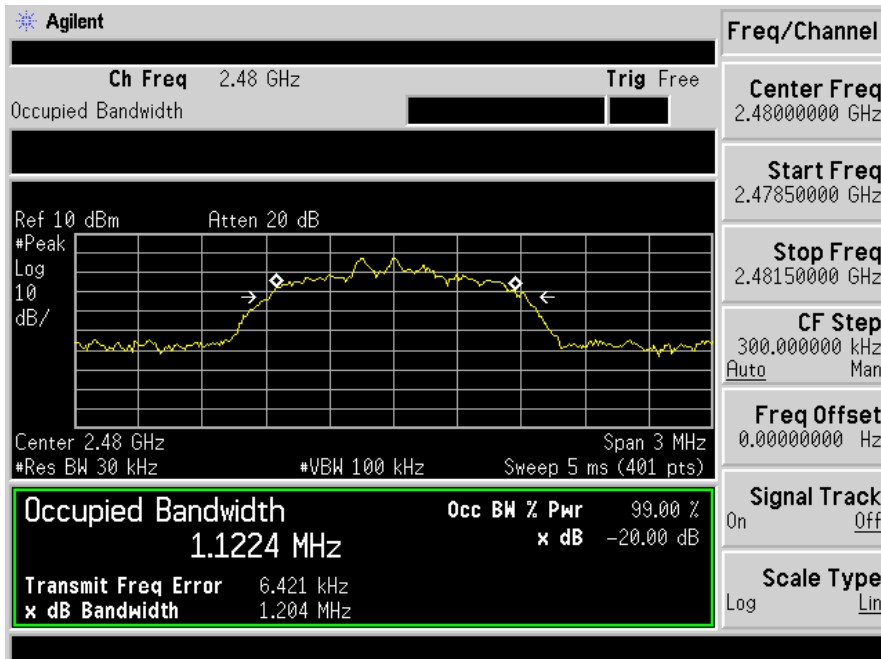
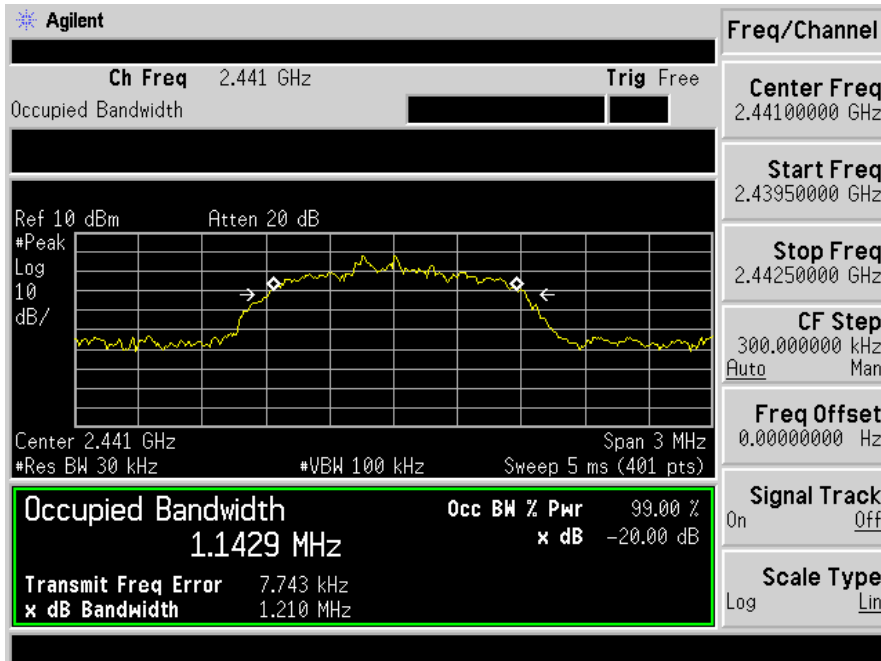

8. Quantity of Hopping Channel Test

8.1 Measurement Procedure

The EUT was operating in hopping mode or could be controlled its channel. Printed out the test result from the spectrum by hard copy function.

8.2 Test SET-UP (Block Diagram of Configuration)

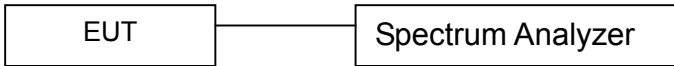

8.3 Measurement Equipment Used:

EQUIPMENT TYPE	MFR	MODEL NUMBER	SERIAL NUMBER	LAST CAL.	CAL DUE.
Spectrum Analyzer	Agilent	E4407B	88156318	05/29/2013	05/28/2014

8.4 Measurement Results:

All the modulation modes were tested the data of the worst mode (GFSK) are recorded in the following pages and the others modulation methods do not exceed the above mentioned limits.

Spectrum Detector: PK Test Date : March 24, 2014
 Test By: Jack Temperature : 25
 Test Result: PASS Humidity : 55 %

Hopping Channel Frequency Range	Quantity of Hopping Channel	Quantity of Hopping Channel limit
2402-2480	79	> 15

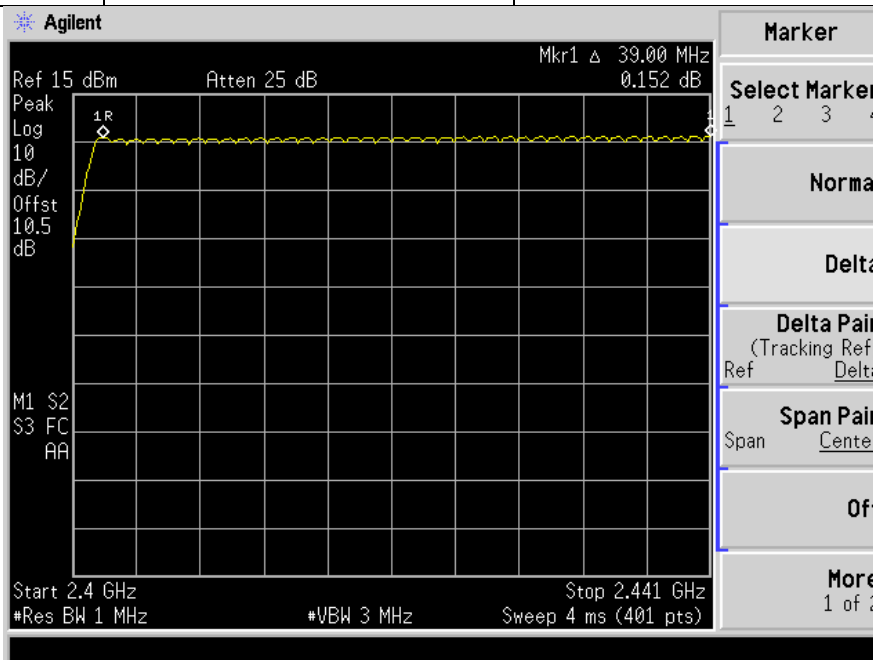

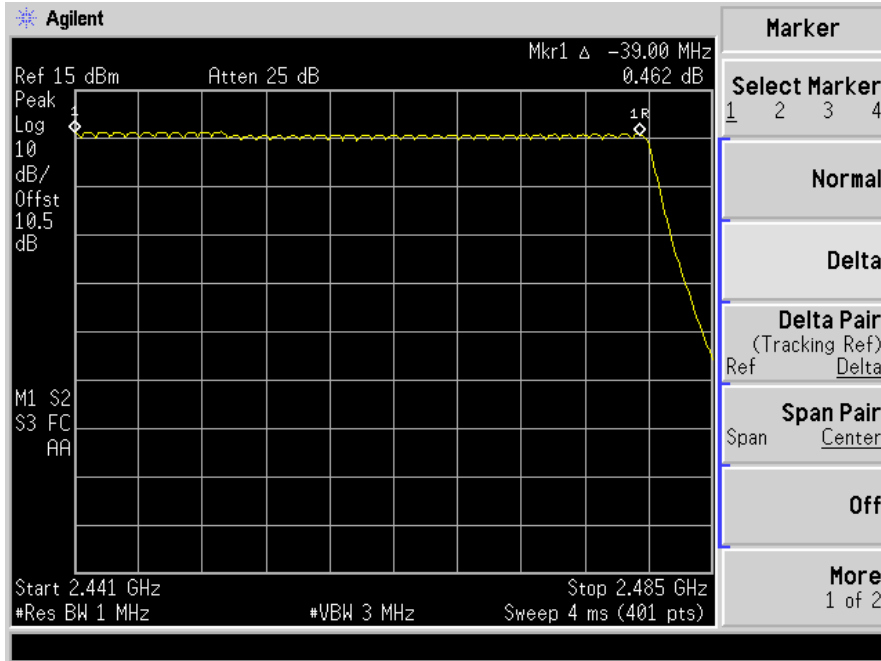

9. Time of Occupancy (Dwell Time) test

9.1 Measurement Procedure

- Check the calibration of the measuring instrument(SA) using either an internal calibrator or a known signal from an external generator.
- Turn on the EUT and connect its antenna terminal to measurement via a low loss cable. Then set it to any one measured frequency within its operating range and make sure the instrument is operated in its linear range.
- Adjust the center frequency of SA on any frequency be measured and set SA to zero span mode. And then, set RBW and VBW of spectrum analyzer to proper value.
- Measure the time duration of one transmission on the measured frequency. And then plot the result with time difference of this time duration.
- Repeat above procedures until all different time-slot modes have been completed.

9.2 Test SET-UP (Block Diagram of Configuration)

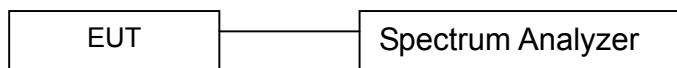

9.3 Measurement Equipment Used:

EQUIPMENT TYPE	MFR	MODEL NUMBER	SERIAL NUMBER	LAST CAL.	CAL DUE.
Spectrum Analyzer	Agilent	E4407B	88156318	05/29/2013	05/28/2014

9.4 Measurement Results:

All the modulation modes were tested and the data of the GFSK mode are recorded in the following pages. Low, Middle and Highest channels have been tested, the worst test data channel 2402 was recorded in this report.

Spectrum Detector: PK Test Date : March 24, 2014
 Test By: Jack Temperature : 25
 Test Result: PASS Humidity : 55 %

Mode	Number of transmission in a 31.6(79 Hopping*0.4)	Length of transmissions time(msec)	Result (msec)	Limit (msec)
DH1	$1600/(2*79) \times 31.6 = 320$	0.400	128.00	400
DH3	$1600/(4*79) \times 31.6 = 160$	1.650	264.00	400
DH5	$1600/(6*79) \times 31.6 = 106.67$	2.875	306.78	400

DH1

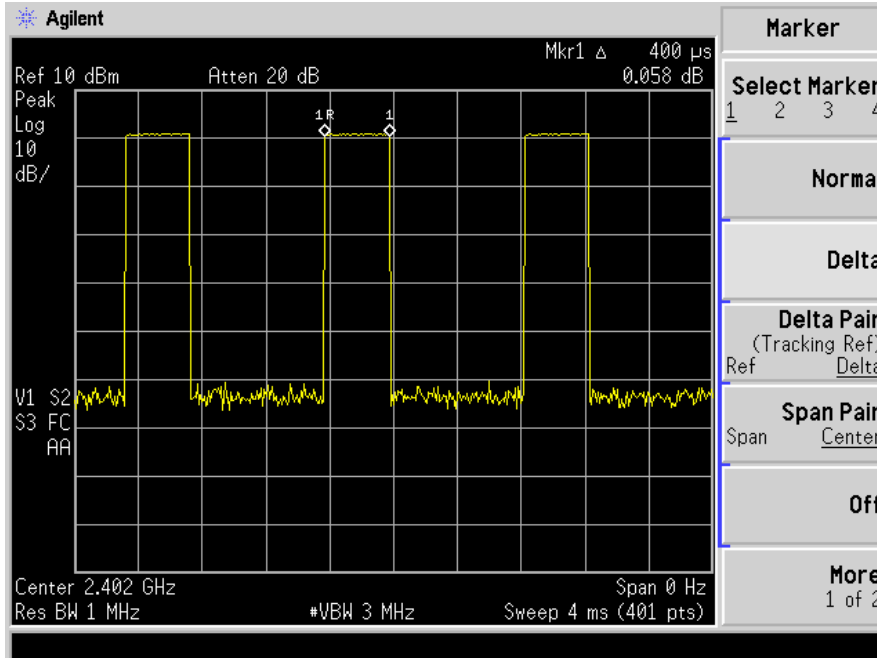

DH3

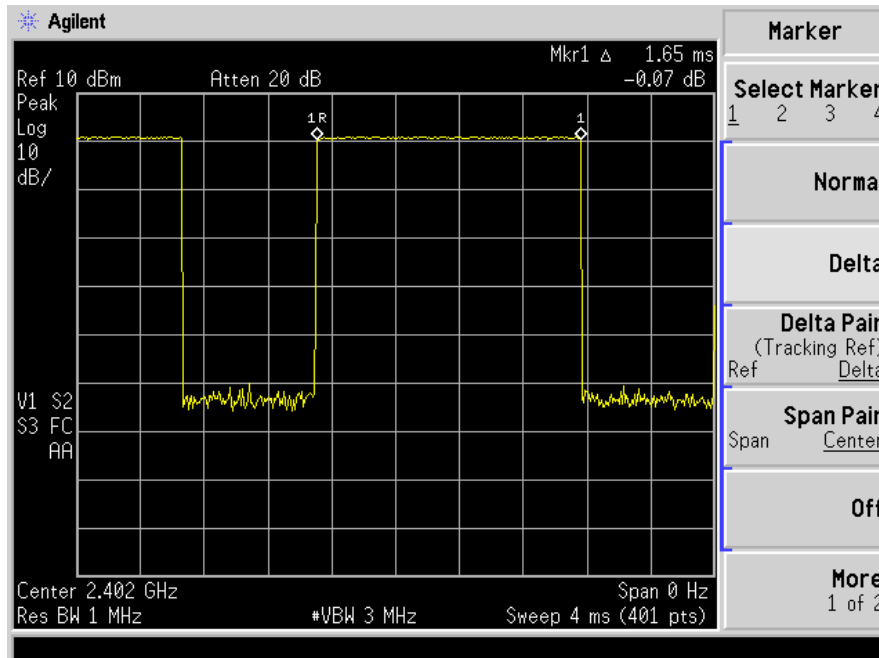

DH5

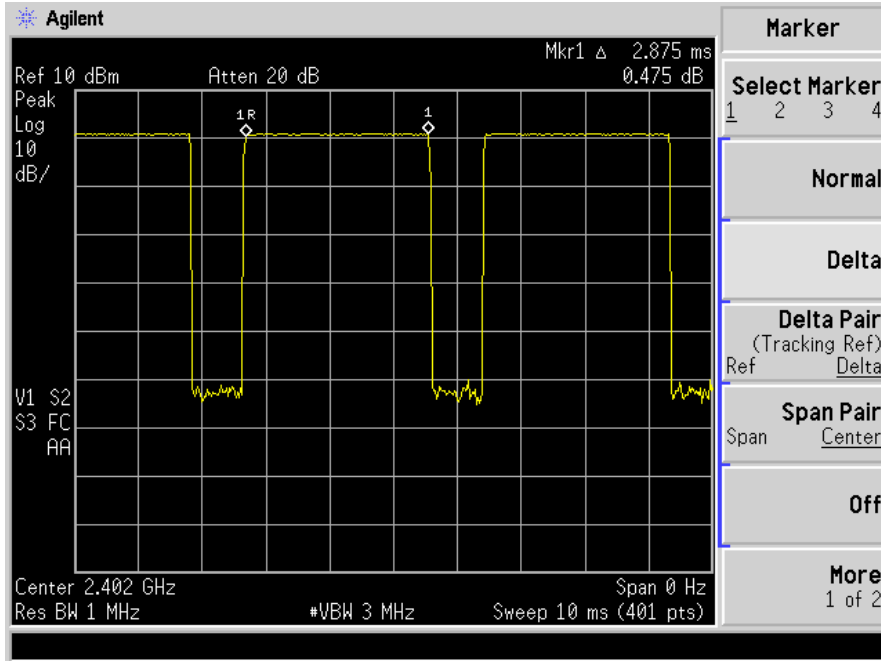

10. MAXIMUM PEAK OUTPUT POWER TEST

10.1 Measurement Procedure

- Check the calibration of the measuring instrument(Power meter) using either an internal calibrator or a known signal from an external generator.
- Turn on the EUT and connect it to measurement instrument. Then set it to any one convenient frequency within its operating range. Set a reference level on the measuring instrument equal to the highest peak value.
- The center frequency of the spectrum analyzer is set to the fundamental frequency and using proper RBW and VBW setting.
- Measure the captured power within the band and recording the plot.
- Repeat above procedures until all frequencies required were complete.

10.2 Test SET-UP (Block Diagram of Configuration)

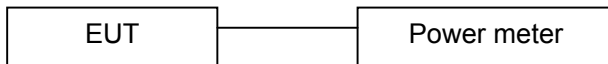

10.3 Measurement Equipment Used:

EQUIPMENT TYPE	MFR	MODEL NUMBER	SERIAL NUMBER	LAST CAL.	CAL DUE.
Power meter	Boonton	4232A	29001	05/29/2013	05/28/2014
Power sensor	Boonton	51011-EMC	31184	05/29/2013	05/28/2014

10.4 Measurement Results:

All the modes GFSK, 1/4π-DQPSK,8DPSK have been tested and the result recorded in the following pages and the others modulation methods do not exceed the limits.

Spectrum Detector: PK Test Date : March 24, 2014
 Test By: Jack Temperature : 25
 Test Result: PASS Humidity : 55 %
 Modulation: GFSK

Channel number	Channel Frequency (MHz)	Peak Power output(dBm)	Peak Power Limit(mW)	Pass/Fail
1	2402.00	2.20	1000mW	PASS
40	2441.00	2.02	1000mW	PASS
79	2480.00	1.74	1000mW	PASS

Spectrum Detector: PK Test Date : March 24, 2014
Test By: Jack Temperature : 25
Test Result: PASS Humidity : 55 %
Modulation: 1/4Π-DQPSK

Channel number	Channel Frequency (MHz)	Peak Power output(dBm)	Peak Power Limit(mW)	Pass/Fail
1	2402.00	1.82	125mW	PASS
40	2441.00	1.53	125mW	PASS
79	2480.00	1.38	125mW	PASS

Spectrum Detector: PK Test Date : March 24, 2014
Test By: Jack Temperature : 25
Test Result: PASS Humidity : 55 %
Modulation: 8DPSK

Channel number	Channel Frequency (MHz)	Peak Power output(dBm)	Peak Power Limit(mW)	Pass/Fail
1	2402.00	1.68	125mW	PASS
40	2441.00	1.20	125mW	PASS
79	2480.00	1.12	125mW	PASS

11. Band EDGE test

11.1 Measurement Procedure

1. The EUT was Operating in hopping mode or could be controlled its channel. Printed out test result from the spectrum by hard copy function.
2. The EUT was placed on a turn table which is 0.8m above ground plane.
3. Maximum procedure was performed on the six highest emissions to ensure EUT compliance.
4. And also, each emission was to be maximized by changing the polarization of receiving antenna both horizontal and vertical.
5. Repeat above procedures until all frequency measured were complete.

11.2 Test SET-UP (Block Diagram of Configuration)

As 5.2 Test set up (B) and (C)

11.3 Measurement Equipment Used:

Same as 5.3 Radiated Emission Measurement.

11.4 Measurement Results:

All the modes GFSK, 1/4Π-DQPSK,8DPSK and hopping mode have been tested and the result recorded in the following pages and the others modulation methods do not exceed the limits.

Spectrum Detector:	PK/AV	Test Date :	March 24, 2014
Test By:	Jack	Temperature :	25
Test channel:	00	Humidity :	55 %
Modulation:	GFSK		

Frequency (MHz)	Polarity	Level (dBuV/m)		Limited (dBuV/m)	
		PK	AV	PK	AV
2379.18	H	51.47	41.59	74	54
2385.34	V	51.78	41.88	74	54

Spectrum Detector: PK/AV Test Date : March 24, 2014
 Test By: Jack Temperature : 25
 Test channel: 78 Humidity : 55 %
 Modulation: GFSK

Frequency (MHz)	Polarity	Level (dBuV/m)		Limited (dBuV/m)	
		PK	AV	PK	AV
2484.24	H	51.55	41.71	74	54
2489.88	V	51.75	41.65	74	54

Spectrum Detector: PK/AV Test Date : March 24, 2014
 Test By: Jack Temperature : 25
 Test channel: 00 Humidity : 55 %
 Modulation: 1/4Π-DQPSK

Frequency (MHz)	Polarity	Level (dBuV/m)		Limited (dBuV/m)	
		PK	AV	PK	AV
2336.48	H	51.96	41.74	74	54
2355.29	V	51.88	41.58	74	54

Spectrum Detector: PK/AV Test Date : March 24, 2014
 Test By: Jack Temperature : 25
 Test channel: 78 Humidity : 55 %
 Modulation: 1/4Π-DQPSK

Frequency (MHz)	Polarity	Level (dBuV/m)		Limited (dBuV/m)	
		PK	AV	PK	AV
2485.59	H	51.66	41.48	74	54
2490.21	V	51.65	41.34	74	54

Spectrum Detector: PK/AV Test Date : March 24, 2014
 Test By: Jack Temperature : 25
 Test channel: 00 Humidity : 55 %
 Modulation: 8DPSK

Frequency (MHz)	Polarity	Level (dBuV/m)		Limited (dBuV/m)	
		PK	AV	PK	AV
2315.27	H	51.17	41.19	74	54
2380.10	V	51.38	41.43	74	54

Spectrum Detector: PK/AV Test Date : March 24, 2014
 Test By: Jack Temperature : 25
 Test channel: 78 Humidity : 55 %
 Modulation: 8DPSK

Frequency (MHz)	Polarity	Level (dBuV/m)		Limited (dBuV/m)	
		PK	AV	PK	AV
2486.48	H	51.71	41.42	74	54
2491.26	V	51.70	41.43	74	54

Spectrum Detector: PK/AV Test Date : March 24, 2014
 Test By: Jack Temperature : 25
 Mode: Hopping mode Humidity : 55 %

Frequency (MHz)	Polarity	Level (dBuV/m)		Limited (dBuV/m)	
		PK	AV	PK	AV
2390.0	H	51.90	41.35	74	54
2390.0	V	52.35	41.68	74	54
2483.5	H	52.06	41.46	74	54
2483.5	V	51.96	41.45	74	54

12. Antenna Port Emission

12.1 Test Equipment

EQUIPMENT TYPE	MFR	MODEL NUMBER	SERIAL NUMBER	LAST CAL.	CAL DUE.
Spectrum Analyzer	Agilent	E4407B	88156318	05/29/2013	05/28/2014

12.2 Measuring Instruments and setting

All the modulation modes were tested and the data of the GFSK mode are recorded in the following pages and the others modulation methods do not exceed the limits.

The following table is the setting of spectrum analyzer.

EMI Test Receiver	Setting
Attenuation	Auto
RB	100kHz
VB	300kHz
Detector	Peak
Trace	Max hold

12.3 Test Procedures

The conducted spurious emissions were measured conducted using a spectrum analyzer at low, mid, and hi channels, the limit was determined by attenuation 20dB of the RF peak power output.

12.4 Block Diagram of Test setup

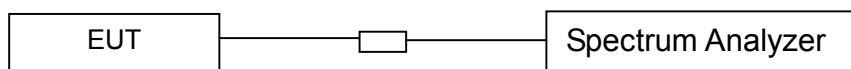

12.5 Test Result

PASS.

All the modes GFSK, 1/4Π-DQPSK,8DPSK and hopping mode have been tested and the worst result recorded in the following pages

TX 2402MHz

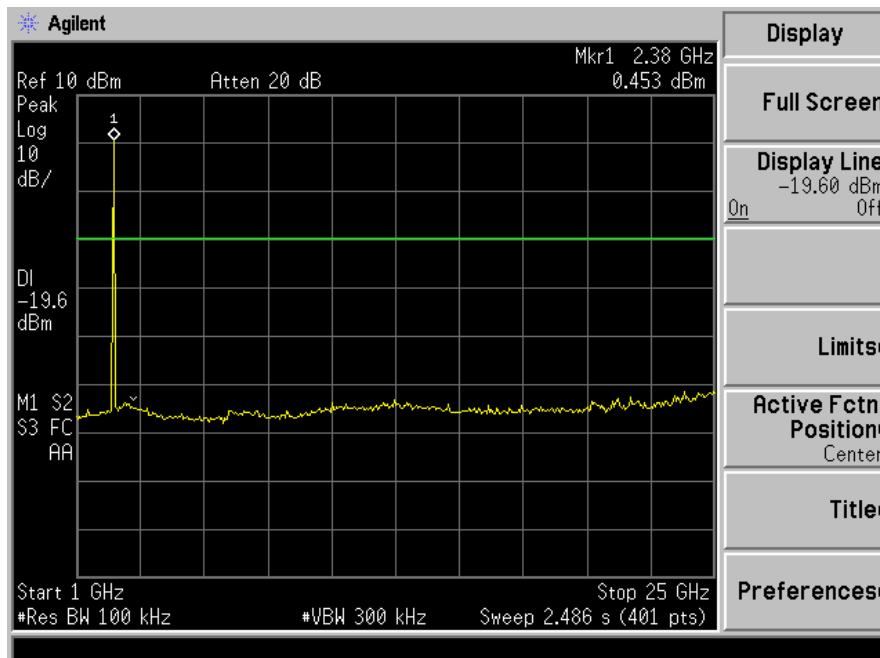
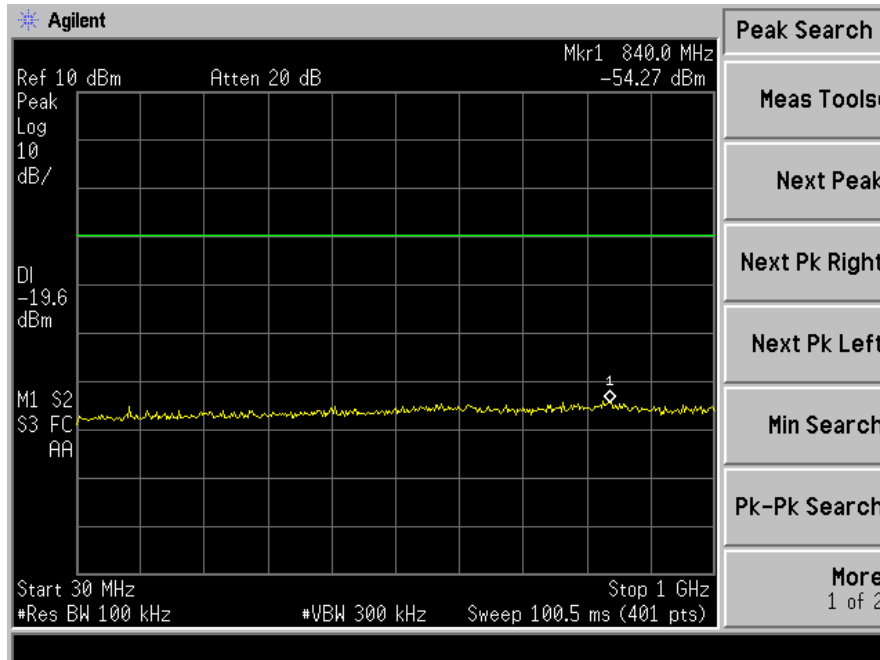

TX 2441MHz

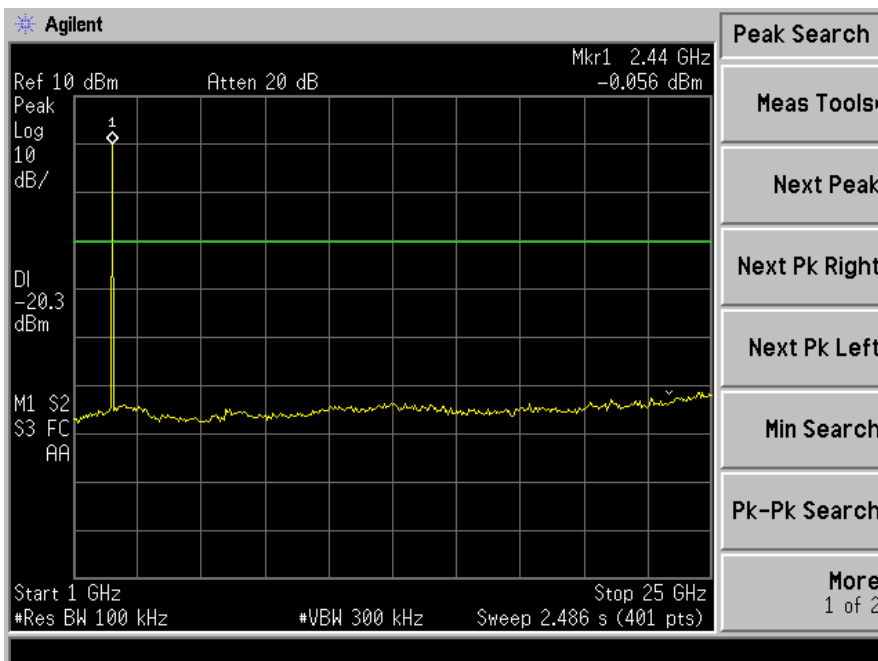
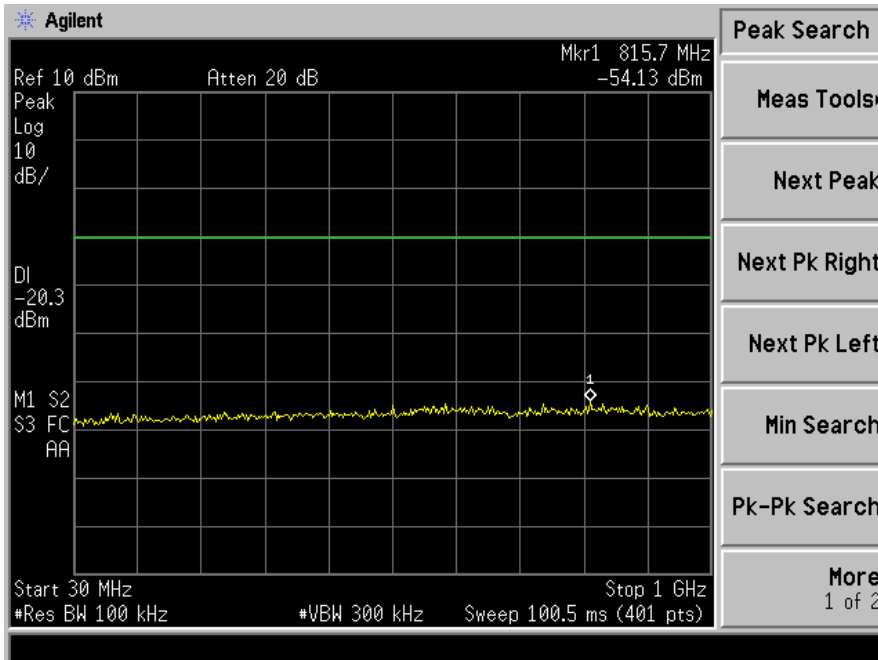

TX 2480MHz

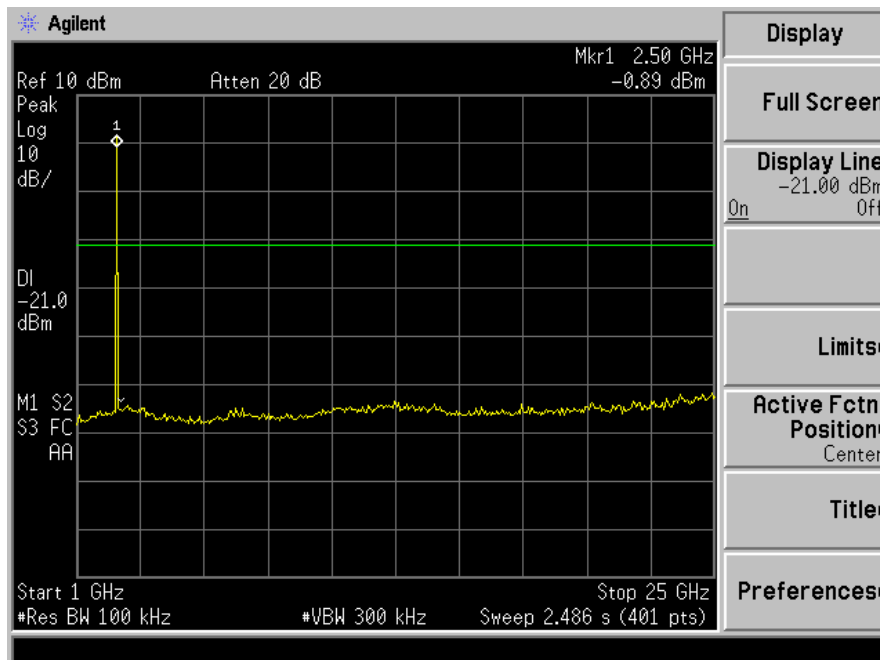
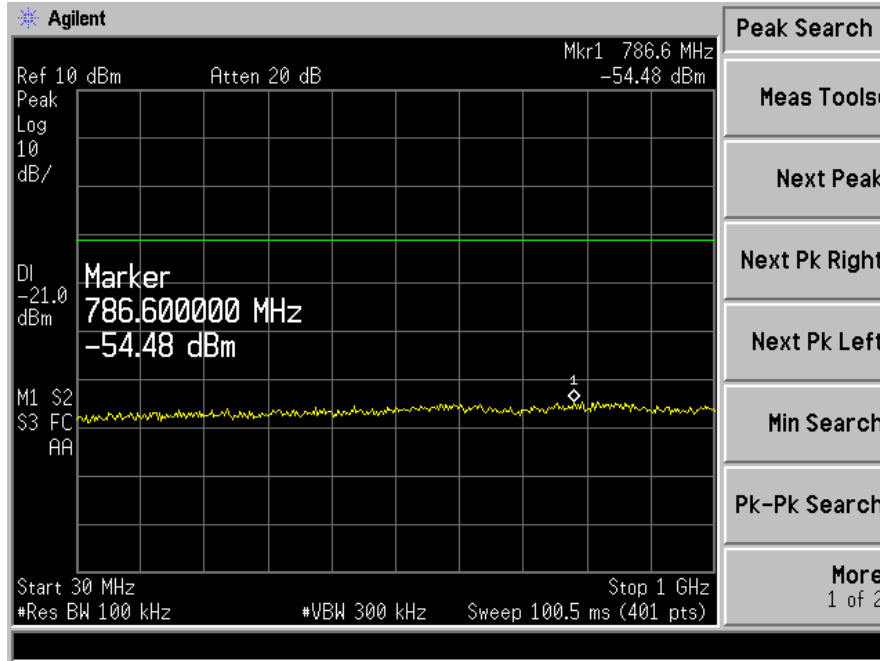

13. Antenna Application

13.1 Antenna requirement

The EUT'S antenna is met the requirement of FCC part 15C section 15.203 and 15.247

FCC part 15C section 15.247 requirements:

Systems operating in the 2402-2480MHz band that are used exclusively for fixed, point-to-point operations may employ transmitting antennas with directional gain greater than 6dBi provided the maximum peak output power of the intentional radiator is reduced by 1dB for every 3dB that the directional gain of the antenna exceeds 6dBi.

13.2 Result

The EUT'S antenna is Chip antenna. The antenna's gain is 1dBi and meets the requirement.