



# CTC Laboratories, Inc.

1-2/F., Building 2, Jiaquan Building, Guanlan High-Tech Park, Shenzhen, Guangdong, China  
Tel: +86-755- 27521059 Fax: +86-755- 27521011 Http://www.sz-ctc.org.cn

## TEST REPORT

**Report No.** .....: **CTC20231520E02**

**FCC ID**.....: **XUJITPMS**

**Applicant** .....: **Launch Tech Co., Ltd.**

Address.....: Launch Industrial Park, North of Wuhe Rd, Banxuegang, Longgang, Shenzhen, Guangdong, P.R. China

Manufacturer.....: Launch Tech Co., Ltd.

Address.....: Launch Industrial Park, North of Wuhe Rd, Banxuegang, Longgang, Shenzhen, Guangdong, P.R. China

**Product Name** .....: **Modular activation programming tool**

Trade Mark .....: LAUNCH

Model/Type reference.....: i-TPMS

Listed Model(s) .....: /

**Standard** .....: **FCC CFR Title 47 Part 15 Subpart C**

Date of receipt of test sample.....: Jul. 11, 2023

Date of testing.....: Jul. 12, 2023 ~ Jul. 31, 2023

Date of issue.....: Jul. 31, 2023

**Result**.....: **PASS**

Compiled by:		
(Printed name + signature)	Terry Su	
Supervised by:		
( Printed name + signature)	Eric Zhang	
Approved by:		
( Printed name + signature)	Totti Zhao	

**Testing Laboratory Name** .....: **CTC Laboratories, Inc.**

Address.....: 1-2/F., Building 2, Jiaquan Building, Guanlan High-Tech Park, Shenzhen, Guangdong, China

This test report may be duplicated completely for legal use with the approval of the applicant. It should not be reproduced except in full, without the written approval of our laboratory. The client should not use it to claim product endorsement by CTC. The test results in the report only apply to the tested sample. The test report shall be invalid without all the signatures of testing engineers, reviewer and approver. Any objections must be raised to CTC within 15 days since the date when the report is received. It will not be taken into consideration beyond this limit. The test report merely correspond to the test sample.



Table of Contents

Page

<b>1. TEST SUMMARY</b> .....	<b>3</b>
1.1. TEST STANDARDS .....	3
1.2. REPORT VERSION .....	3
1.3. TEST DESCRIPTION .....	4
1.4. TEST FACILITY .....	5
1.5. MEASUREMENT UNCERTAINTY .....	5
1.6. ENVIRONMENTAL CONDITIONS .....	6
1.7. EUT OPERATION STATE .....	6
<b>1. GENERAL INFORMATION</b> .....	<b>7</b>
1.1. CLIENT INFORMATION .....	7
1.2. GENERAL DESCRIPTION OF EUT .....	7
1.3. ACCESSORY EQUIPMENT INFORMATION.....	7
1.4. MEASUREMENT INSTRUMENTS LIST .....	8
<b>2. TEST ITEM AND RESULTS</b> .....	<b>10</b>
2.1. CONDUCTED EMISSION .....	10
2.2. RADIATED EMISSION.....	13
2.3. OCCUPIED BANDWIDTH 20 dB BANDWIDTH.....	21
2.4. FIELD STRENGTH OF THE FUNDAMENTAL .....	23
2.5. ANTENNA REQUIREMENT.....	26



# 1. TEST SUMMARY

## 1.1. Test Standards

The tests were performed according to following standards:

[FCC Rules Part 15C](#): Intentional Radiators

[ANSI C63.10-2013](#): American National Standard for Testing Unlicensed Wireless Devices.

## 1.2. Report version

Revised No.	Date of issue	Description
01	Jul. 31, 2023	Original



### 1.3. Test Description

FCC Part 15 Subpart C			
Test Item	Standard Section	Result	Test Engineer
Conducted Emission	15.207	Pass	Eva Feng
Radiated Emissions	15.209	Pass	Terry Su
Field Strength of the Fundamental	15.209	Pass	Terry Su
Occupied Bandwidth and 20dB Bandwidth	15.215	Pass	Terry Su
Antenna requirement	15.203	Pass	Terry Su

Note: N/A: Not applicable.

The measurement uncertainty is not included in the test result.



## 1.4. Test Facility

### Address of the report laboratory

**CTC Laboratories, Inc.**

Add: 1-2/F., Building 2, Jiaquan Building, Guanlan High-Tech Park, Shenzhen, Guangdong, China

### Laboratory accreditation

The test facility is recognized, certified, or accredited by the following organizations:

#### **A2LA-Lab Cert. No.: 4340.01**

CTC Laboratories, Inc. EMC Laboratory has been accredited by A2LA for technical competence in the field of electrical testing, and proved to be in compliance with ISO/IEC 17025:2017 General Requirements for the Competence of Testing and Calibration Laboratories and any additional program requirements in the identified field of testing.

#### **Industry Canada (Registration No.: 9783A, CAB Identifier: CN0029)**

CTC Laboratories, Inc. EMC Laboratory has been registered by Certification and Engineer Bureau of Industry Canada for the performance of with Registration NO.: 9783A on Jan, 2016.

#### **FCC (Registration No.: 951311, Designation Number CN1208)**

CTC Laboratories, Inc. EMC Laboratory has been registered and fully described in a report filed with the (FCC) Federal Communications Commission. The acceptance letter from the FCC is maintained in our files. Registration 951311, Aug 26, 2017.

## 1.5. Measurement Uncertainty

The data and results referenced in this document are true and accurate. The reader is cautioned that there may be errors within the calibration limits of the equipment and facilities. The measurement uncertainty was calculated for all measurements listed in this test report acc. to TR-100028-01 "Electromagnetic compatibility and Radio spectrum Matters (ERM);Uncertainties in the measurement of mobile radio equipment characteristics; Part 1" and TR-100028-02 "Electromagnetic compatibility and Radio spectrum Matters (ERM);Uncertainties in the measurement of mobile radio equipment characteristics; Part 2 " and is documented in the CTC Laboratories, Inc. quality system acc. to DIN EN ISO/IEC 17025. Furthermore, component and process variability of devices similar to that tested may result in additional deviation. The manufacturer has the sole responsibility of continued compliance of the device.

Below is the best measurement capability for CTC Laboratories, Inc.



Test Items	Measurement Uncertainty	Notes
Transmitter power conducted	0.42 dB	(1)
Transmitter power Radiated	2.14 dB	(1)
Conducted spurious emissions 9kHz~40GHz	1.60 dB	(1)
Radiated spurious emissions 9kHz~40GHz	2.20 dB	(1)
Conducted Emissions 9kHz~30MHz	3.20 dB	(1)
Radiated Emissions 30~1000MHz	4.70 dB	(1)
Radiated Emissions 1~18GHz	5.00 dB	(1)
Radiated Emissions 18~40GHz	5.54 dB	(1)
Occupied Bandwidth	-----	(1)

**Note (1):** This uncertainty represents an expanded uncertainty expressed at approximately the 95% confidence level using a coverage factor of  $k=1.96$ .

## 1.6. Environmental conditions

During the measurement the environmental conditions were within the listed ranges:

Temperature:	15~35°C
Relative Humidity:	30~60 %
Air Pressure:	101kPa

## 1.7. EUT Operation state

The EUT has been tested under typical operating condition. The Applicant provides software to control the EUT for staying in continuous transmitting mode for testing.



# 1. GENERAL INFORMATION

## 1.1. Client Information

Applicant:	Launch Tech Co., Ltd.
Address:	Launch Industrial Park, North of Wuhe Rd, Banxuegang, Longgang, Shenzhen, Guangdong, P.R. China
Manufacturer:	Launch Tech Co., Ltd.
Address:	Launch Industrial Park, North of Wuhe Rd, Banxuegang, Longgang, Shenzhen, Guangdong, P.R. China

## 1.2. General Description of EUT

Product Name:	Modular activation programming tool
Model/Type reference:	LAUNCH
Marketing Name:	i-TPMS
Listed Model(s):	/
Power supply:	5Vdc from USB Cable 3.7Vdc from 2000mAh Li-ion Battery
Hardware version:	/
Software version:	/
<b>RF Parameter</b>	
Operation frequency:	125KHz
Antenna type:	Internal Antenna

## 1.3. Accessory Equipment information

Equipment Information			
Name	Model	S/N	Manufacturer
AC/DC Adapter	A2167	---	Apple
Cable Information			
Name	Shielded Type	Ferrite Core	Length
/	/	/	/
Test Software Information			
Name	/	/	/
/	/	/	/



## 1.4. Measurement Instruments List

Tonscend JS0806-2 Test system					
Item	Test Equipment	Manufacturer	Model No.	Serial No.	Calibrated until
1	MXA Signal Analyzer	Keysight	N9020A	MY46471737	Dec. 16, 2023
2	Spectrum Analyzer	R&S	FSU26	100105	Dec. 16, 2023
3	Spectrum Analyzer	R&S	FSV40-N	101331	Mar. 14, 2024
4	MXG Vector Signal Generator	Agilent	N5182A	MY47420864	Dec. 16, 2023
5	PSG Analog Signal Generator	Agilent	E8257D	MY46521908	Dec. 16, 2023
6	Power Sensor	Keysight	U2021XA	MY55130004	Mar. 14, 2024
7	Power Sensor	Keysight	U2021XA	MY55130006	Mar. 14, 2024
8	Wideband Radio Communication Tester	R&S	CMW500	102414	Dec. 16, 2023
9	High and low temperature box	ESPEC	MT3035	/	Mar. 24, 2024
10	JS1120 RF Test system	TONSCEND	v2.6	/	/

Radiated emission(3m chamber 2)					
Item	Test Equipment	Manufacturer	Model No.	Serial No.	Calibrated Until
1	Trilog-Broadband Antenna	Schwarzbeck	VULB 9168	9168-1013	Dec. 07, 2024
2	Horn Antenna	Schwarzbeck	BBHA 9120D	9120D-647	Dec. 07, 2024
3	Loop Antenna	LAPLAC	RF300	9138	Dec. 16, 2023
4	Spectrum Analyzer	R&S	FSU26	100105	Dec. 16, 2023
5	Spectrum Analyzer	R&S	FSV40-N	101331	Mar. 14, 2024
6	Pre-Amplifier	SONOMA	310	186194	Dec. 16, 2023
7	Low Noise Pre-Amplifier	EMCI	EMC051835	980075	Dec. 16, 2023
8	Test Receiver	R&S	ESC17	100967	Dec. 16, 2023
9	3m chamber 2	Frankonia	EE025	/	Oct. 23, 2024

Radiated emission(3m chamber 3)					
Item	Test Equipment	Manufacturer	Model No.	Serial No.	Calibrated Until
1	Trilog-Broadband Antenna	Schwarzbeck	VULB 9163	01026	Dec. 18, 2024
2	Horn Antenna	Schwarzbeck	BBHA 9120D	9120D-647	Dec. 01, 2024
3	Test Receiver	Keysight	N9038A	MY56400071	Dec. 16, 2023
4	Broadband Premplifier	SCHWARZBECK	BBV9743B	259	Dec. 16, 2023
5	Mirowave Broadband Amplifier	SCHWARZBECK	BBV9718C	111	Dec. 16, 2023
6	Pre-Amplifier	R&S	SCU-26	10033	Dec. 16, 2023
7	Pre-Amplifier	R&S	SCU-40	10030	Dec. 16, 2023
8	Board-Band Horn Antenna	Schwarzbeck	BBHA 9170	BBHA 9170-497	Dec. 16, 2023
9	3m chamber 3	YIHENG	EE106	/	Sep. 09, 2023

CTC Laboratories, Inc.

1-2/F., Building 2, Jiaquan Building, Guanlan High-Tech Park, Shenzhen, Guangdong, China

Tel.: (86)755-27521059

Fax: (86)755-27521011

Http://www.sz-ctc.org.cn



中国国家认证认可监督管理委员会  
Certification and Accreditation Administration of the People's Republic of China

For anti-fake verification, please visit the official website of Certification and

Accreditation Administration of the People's Republic of China : <http://yz.cnca.cn>





Conducted Emission					
Item	Test Equipment	Manufacturer	Model No.	Serial No.	Calibrated until
1	LISN	R&S	ENV216	101112	Dec. 16, 2023
2	LISN	R&S	ENV216	101113	Dec. 16, 2023
3	EMI Test Receiver	R&S	ESCS30	100353	Dec. 16, 2023

Note: 1. The Cal. Interval was one year.

2. The Cal. Interval was three year of the chamber

3. The cable loss has calculated in test result which connection between each test instruments.

## 2. TEST ITEM AND RESULTS

### 2.1. Conducted Emission

#### Limit

FCC CFR Title 47 Part 15 Subpart C Section 15.207/ RSS-Gen 7.2:

Frequency range (MHz)	Limit (dBuV)	
	Quasi-peak	Average
0.15-0.5	66 to 56*	56 to 46*
0.5-5	56	46
5-30	60	50

Notes:

- (1) \*Decreasing linearly with logarithm of the frequency.
- (2) The lower limit shall apply at the transition frequencies.
- (3) The limit decrease in line with the logarithm of the frequency in the range of 0.15 to 0.50MHz.

#### Test Configuration

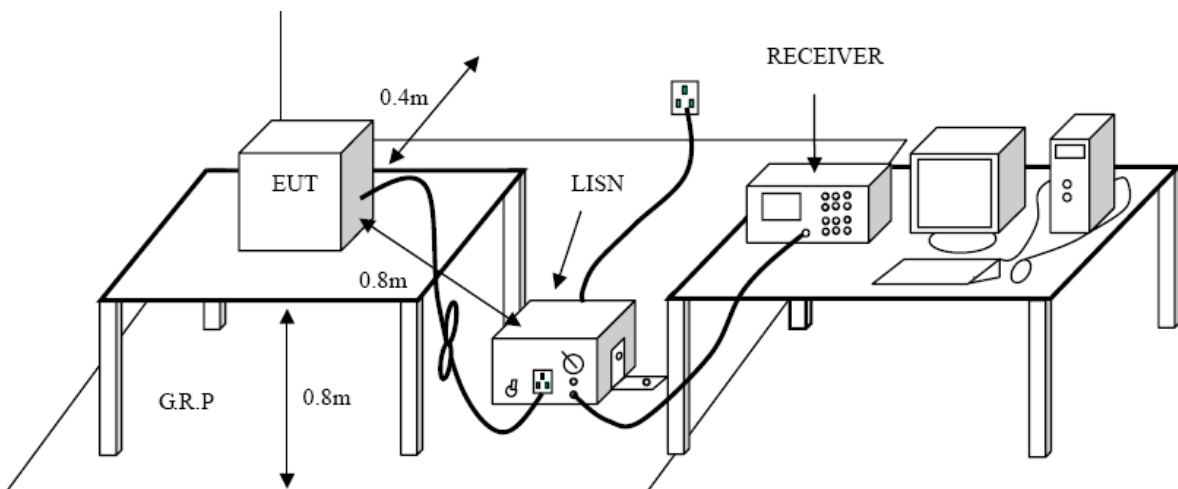

#### Test Procedure

1. The EUT was setup according to ANSI C63.10:2013 requirements.
2. The EUT was placed on a platform of nominal size, 1 m by 1.5 m, raised 80 cm above the conducting ground plane. The vertical conducting plane was located 40 cm to the rear of the EUT. All other surfaces of EUT were at least 80 cm from any other grounded conducting surface.
3. The EUT and simulators are connected to the main power through a line impedances stabilization network (LISN). The LISN provides a 50ohm /50uH coupling impedance for the measuring equipment. The peripheral devices are also connected to the main power through a LISN. (Please refer to the block diagram of the test setup and photographs)
4. Each current-carrying conductor of the EUT power cord, except the ground (safety) conductor, was individually connected through a LISN to the input power source.
5. The excess length of the power cord between the EUT and the LISN receptacle were folded back and forth at the center of the lead to form a bundle not exceeding 40 cm in length.
6. Conducted Emissions were investigated over the frequency range from 0.15MHz to 30MHz using a receiver bandwidth of 9 kHz.
7. During the above scans, the emissions were maximized by cable manipulation.



**Test Mode:**

Please refer to the clause 1.7.

**Test Results**

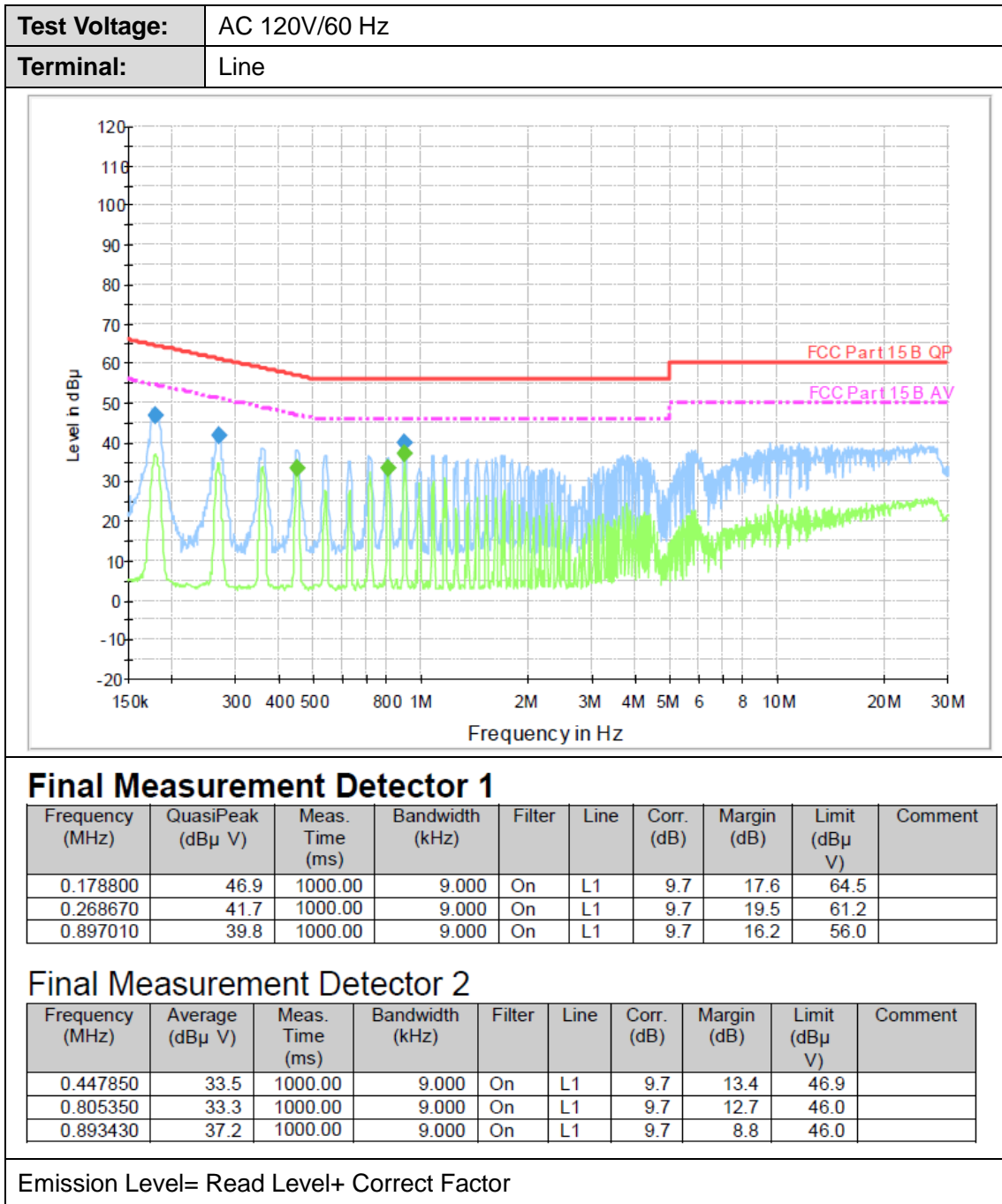



<b>Test Voltage:</b>	AC 120V/60 Hz
<b>Terminal:</b>	Neutral

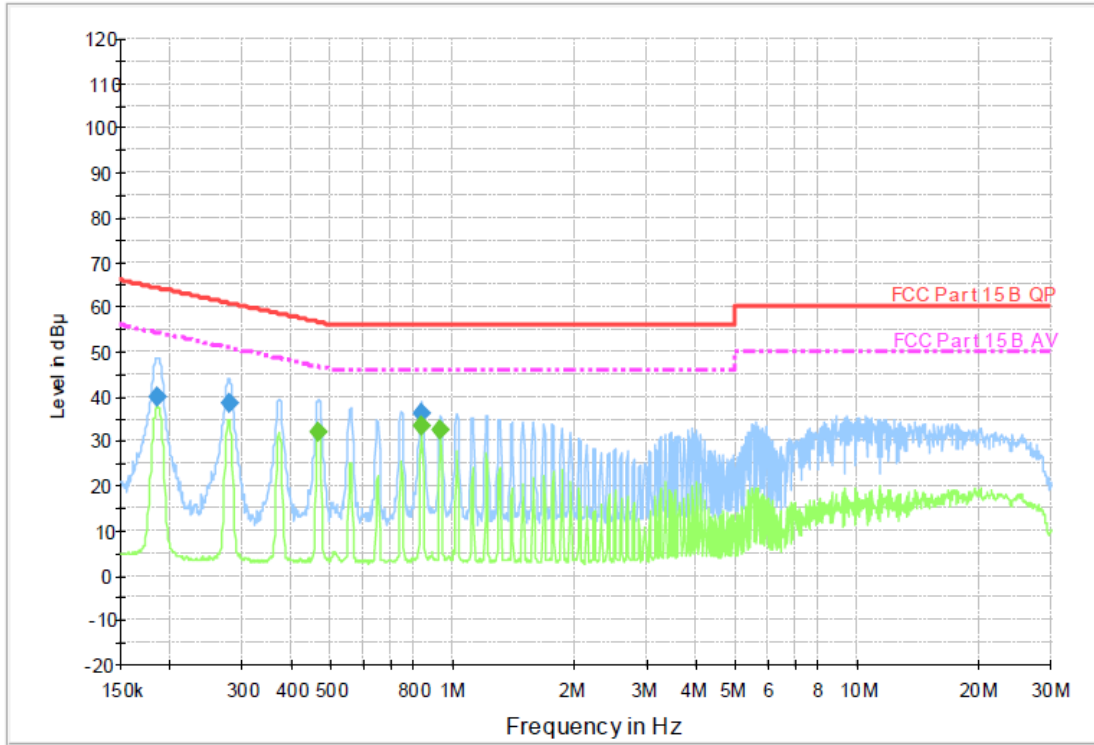

### Final Measurement Detector 1

Frequency (MHz)	QuasiPeak (dBµ V)	Meas. Time (ms)	Bandwidth (kHz)	Filter	Line	Corr. (dB)	Margin (dB)	Limit (dBµ V)	Comment
0.185340	40.0	1000.00	9.000	On	N	10.0	24.2	64.2	
0.278490	38.5	1000.00	9.000	On	N	10.0	22.4	60.9	
0.831480	36.4	1000.00	9.000	On	N	10.0	19.6	56.0	

### Final Measurement Detector 2

Frequency (MHz)	Average (dBµ V)	Meas. Time (ms)	Bandwidth (kHz)	Filter	Line	Corr. (dB)	Margin (dB)	Limit (dBµ V)	Comment
0.464230	32.0	1000.00	9.000	On	N	10.0	14.6	46.6	
0.834810	33.5	1000.00	9.000	On	N	10.0	13.1	46.0	
0.926110	32.6	1000.00	9.000	On	N	10.0	14.0	46.0	

Emission Level= Read Level+ Correct Factor

## 2.2. Radiated Emission

### FCC Limit

#### Radiated Emission Limits (9 kHz~1000 MHz)

Frequency (MHz)	Field Strength (microvolt/meter)	Measurement Distance (meters)
0.009~0.490	2400/F(KHz)	300
0.490~1.705	24000/F(KHz)	30
1.705~30.0	30	30
30~88	100	3
88~216	150	3
216~960	200	3
Above 960	500	3

#### Radiated Emission Limit (Above 1000MHz)

Frequency (MHz)	Distance Meters(at 3m)	
	Peak	Average
Above 1000	74	54

**Note:**

- (1) The tighter limit applies at the band edges.
- (2) Emission Level (dBuV/m)=20log Emission Level (uV/m).

### Test Configuration

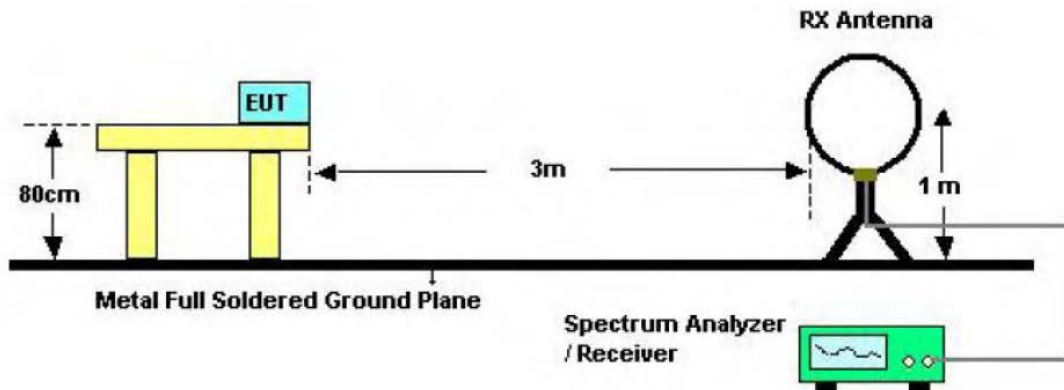

Below 30MHz Test Setup

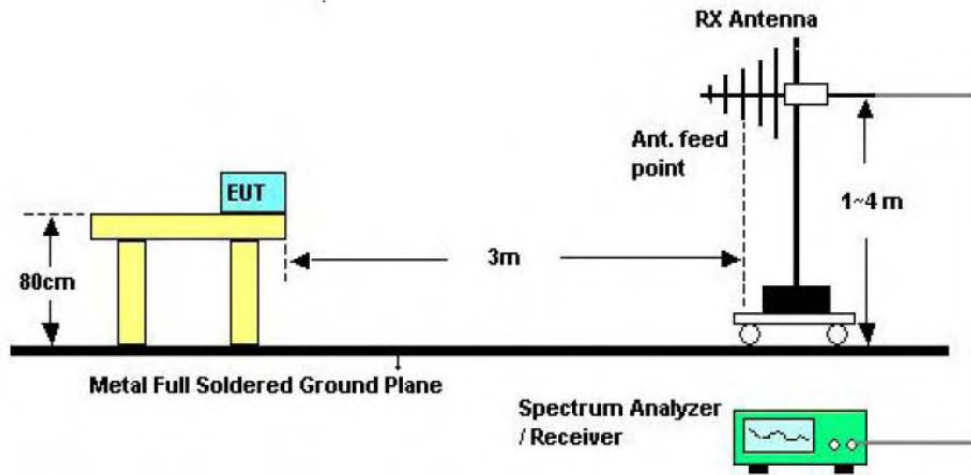

Below 1000MHz Test Setup

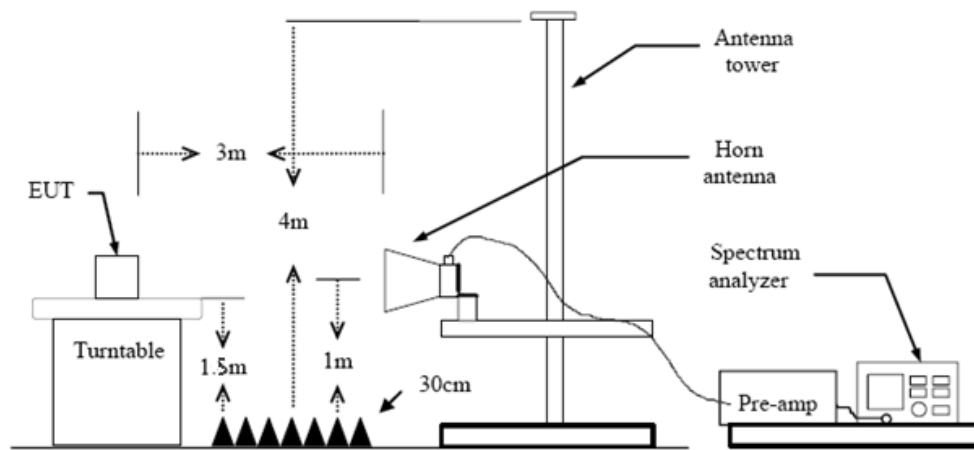

Above 1GHz Test Setup

## Test Procedure

1. The EUT was setup and tested according to ANSI C63.10:2013
2. The EUT is placed on a turn table which is 0.8 meter above ground for below 1 GHz, and 1.5 m for above 1 GHz. The turn table is rotated 360 degrees to determine the position of the maximum emission level.
3. The EUT was set 3 meters from the receiving antenna, which was mounted on the top of a variable height antenna tower.
4. For each suspected emission, the EUT was arranged to its worst case and then tune the Antenna tower (from 1 m to 4 m) and turntable (from 0 degree to 360 degrees) to find the maximum reading. A pre-amp and a high pass filter are used for the test in order to get better signal level to comply with the guidelines.
5. Set to the maximum power setting and enable the EUT transmit continuously.
6. Use the following spectrum analyzer settings
  - (1) Span shall wide enough to fully capture the emission being measured;
  - (2) Below 1 GHz:  
RBW=120 kHz, VBW=300 kHz, Sweep=auto, Detector function=peak, Trace=max hold;If the emission level of the EUT measured by the peak detector is 3 dB lower than the applicable limit, the peak emission level will be reported. Otherwise, the emission measurement will be repeated using the quasi-peak detector and reported.



(3) From 1 GHz to 10<sup>th</sup> harmonic:  
 RBW=1MHz, VBW=3MHz Peak detector for Peak value.  
 RBW=1MHz, VBW=3MHz RMS detector for Average value.

**Test Mode**

Please refer to the clause 1.7.

**Test Result**

**9 KHz ~ 150 KHz**

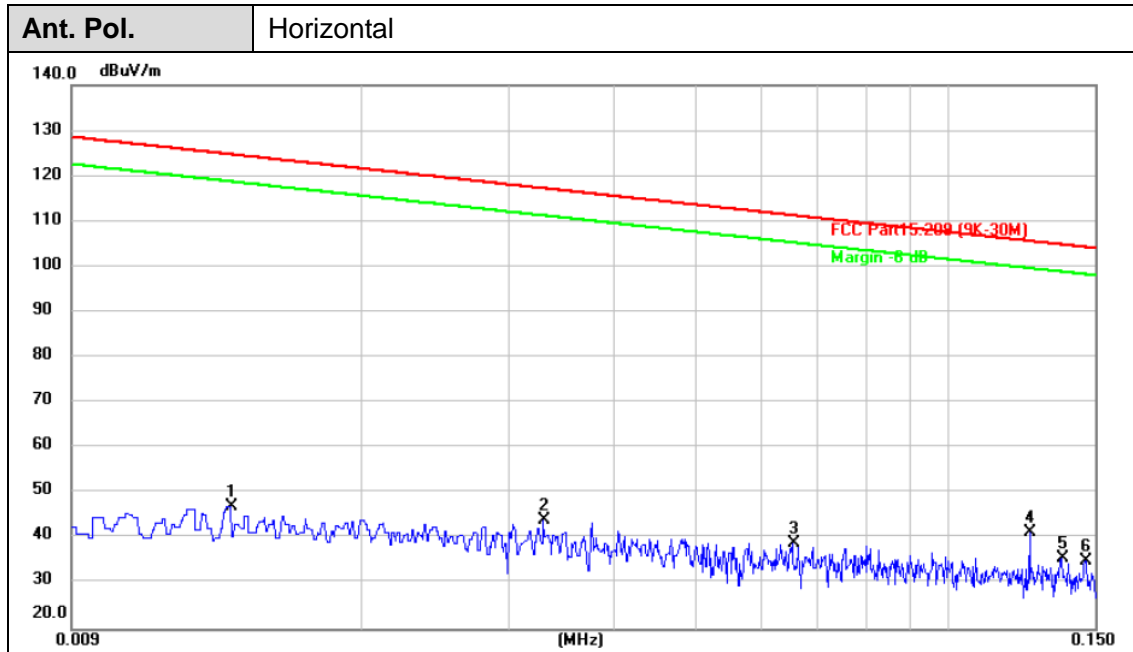

No.	Frequency (MHz)	Reading (dBuV)	Factor (dB/m)	Level (dBuV/m)	Limit (dBuV/m)	Margin (dB)	Detector
1	0.0139	54.24	-7.19	47.05	124.73	-77.68	peak
2	0.0330	55.55	-11.40	44.15	117.22	-73.07	peak
3	0.0653	51.29	-12.26	39.03	111.30	-72.27	peak
4 *	0.1250	55.95	-14.42	41.53	105.66	-64.13	peak
5	0.1365	50.06	-14.46	35.60	104.90	-69.30	peak
6	0.1459	49.71	-14.54	35.17	104.32	-69.15	peak

Remarks:

- Factor (dB/m) = Antenna Factor (dB/m)+Cable Factor (dB)-Pre-amplifier Factor
- Margin value = Level -Limit value



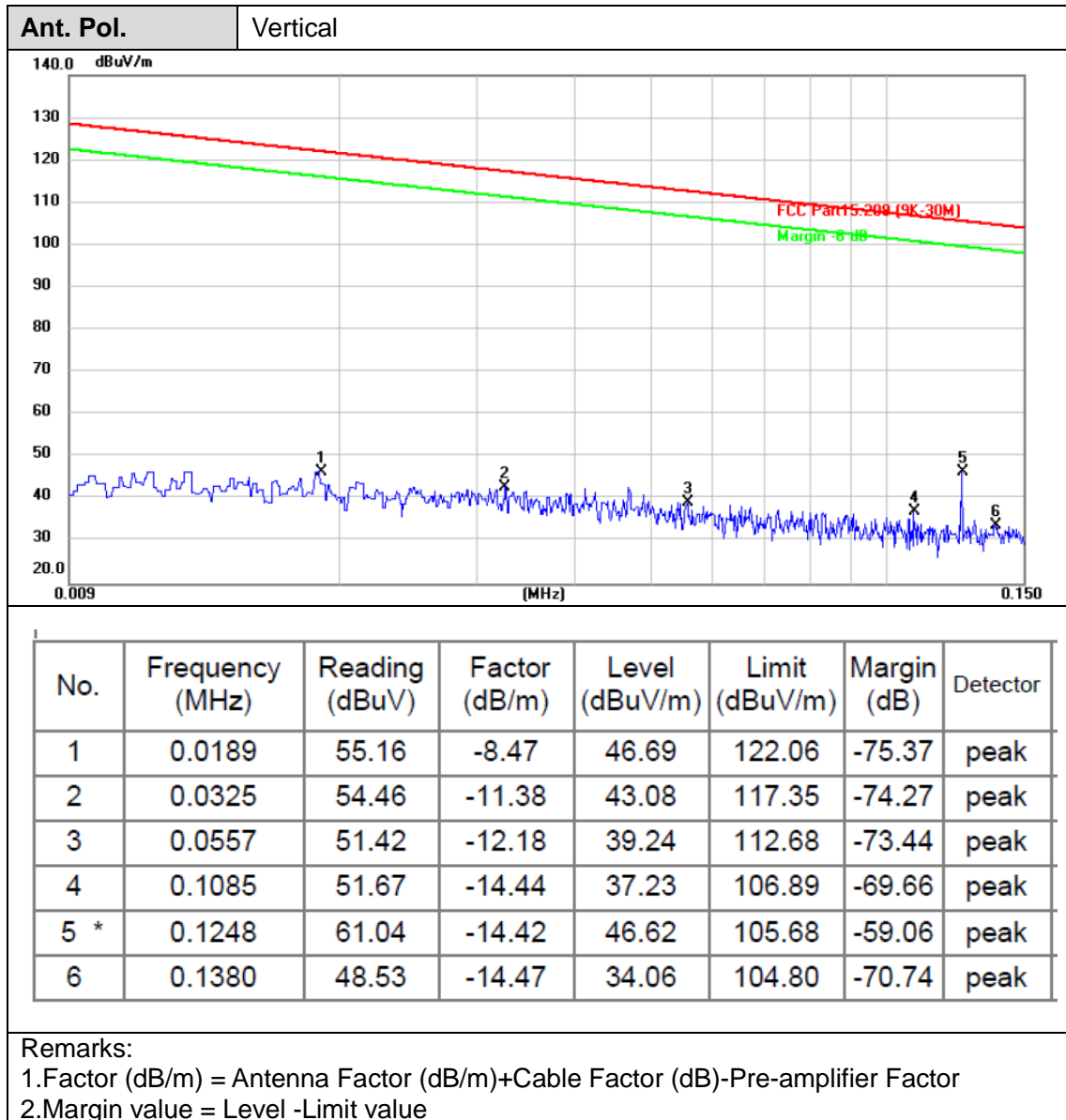





150 KHz ~ 30 MHz

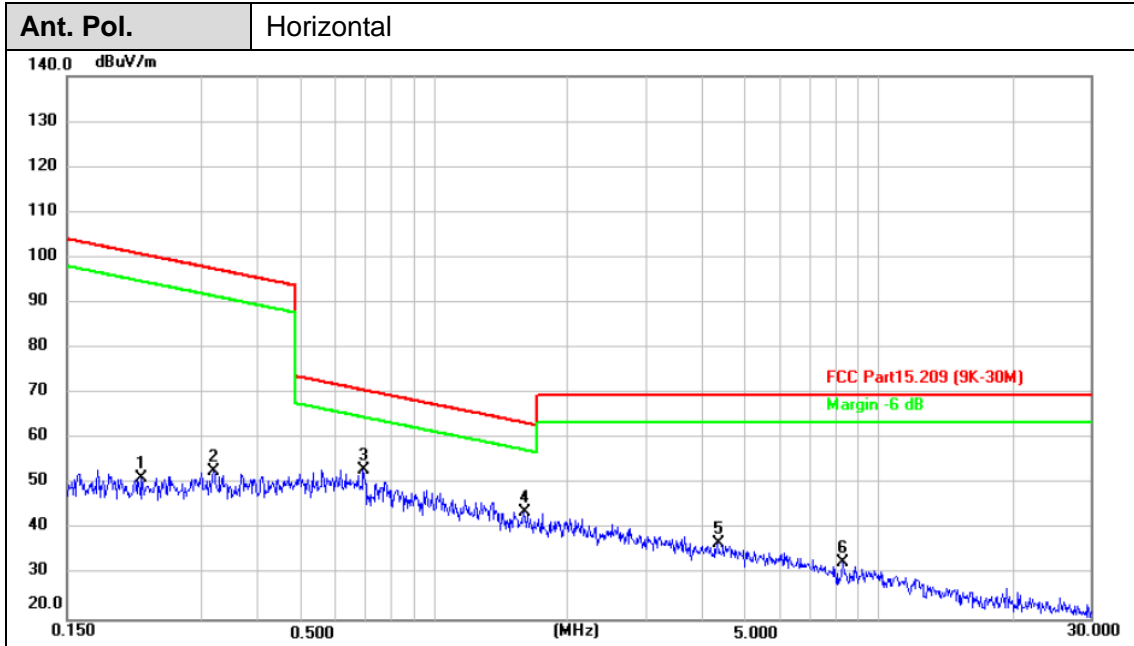

No.	Frequency (MHz)	Reading (dBuV)	Factor (dB/m)	Level (dBuV/m)	Limit (dBuV/m)	Margin (dB)	Detector
1	0.2208	66.33	-14.84	51.49	100.72	-49.23	peak
2	0.3200	68.10	-15.14	52.96	97.50	-44.54	peak
3 *	0.6936	68.18	-15.16	53.02	70.79	-17.77	peak
4	1.5935	58.88	-15.12	43.76	63.59	-19.83	peak
5	4.3376	51.92	-15.00	36.92	69.50	-32.58	peak
6	8.3228	47.99	-15.19	32.80	69.50	-36.70	peak

Remarks:

1. Factor (dB/m) = Antenna Factor (dB/m)+Cable Factor (dB)-Pre-amplifier Factor
2. Margin value = Level -Limit value

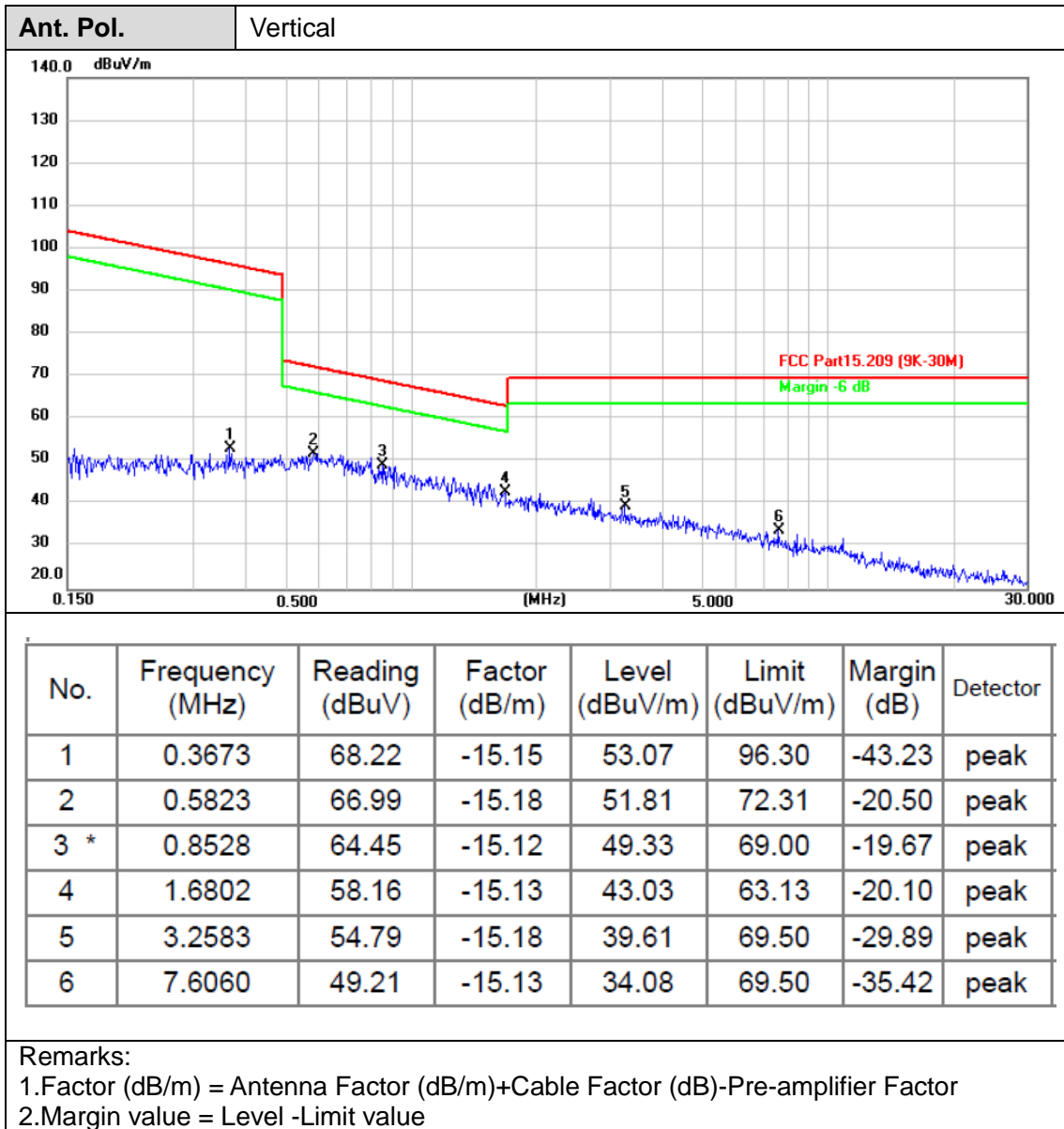



30MHz-1GHz

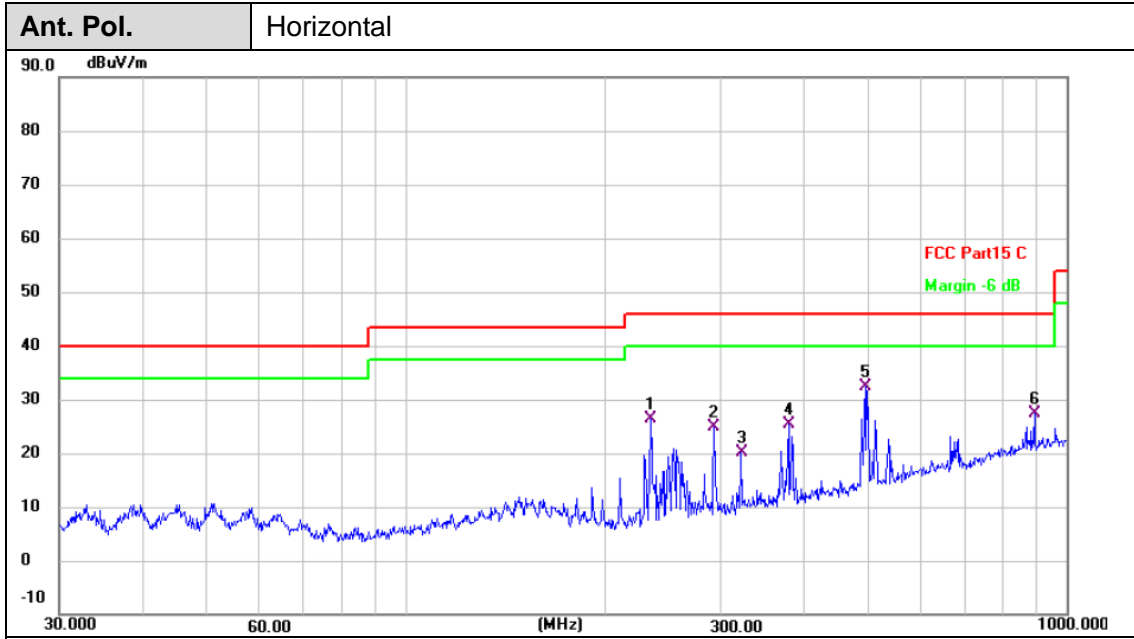

No.	Frequency (MHz)	Reading (dBuV)	Factor (dB/m)	Level (dBuV/m)	Limit (dBuV/m)	Margin (dB)	Detector
1	234.9909	45.60	-19.13	26.47	46.00	-19.53	QP
2	293.0842	42.19	-17.37	24.82	46.00	-21.18	QP
3	322.1885	36.73	-16.65	20.08	46.00	-25.92	QP
4	379.9141	40.63	-15.30	25.33	46.00	-20.67	QP
5 *	495.9344	45.10	-12.72	32.38	46.00	-13.62	QP
6	893.8566	33.29	-5.97	27.32	46.00	-18.68	QP

Remarks:  
 1. Factor (dB/m) = Antenna Factor (dB/m)+Cable Factor (dB)-Pre-amplifier Factor  
 2. Margin value = Level -Limit value

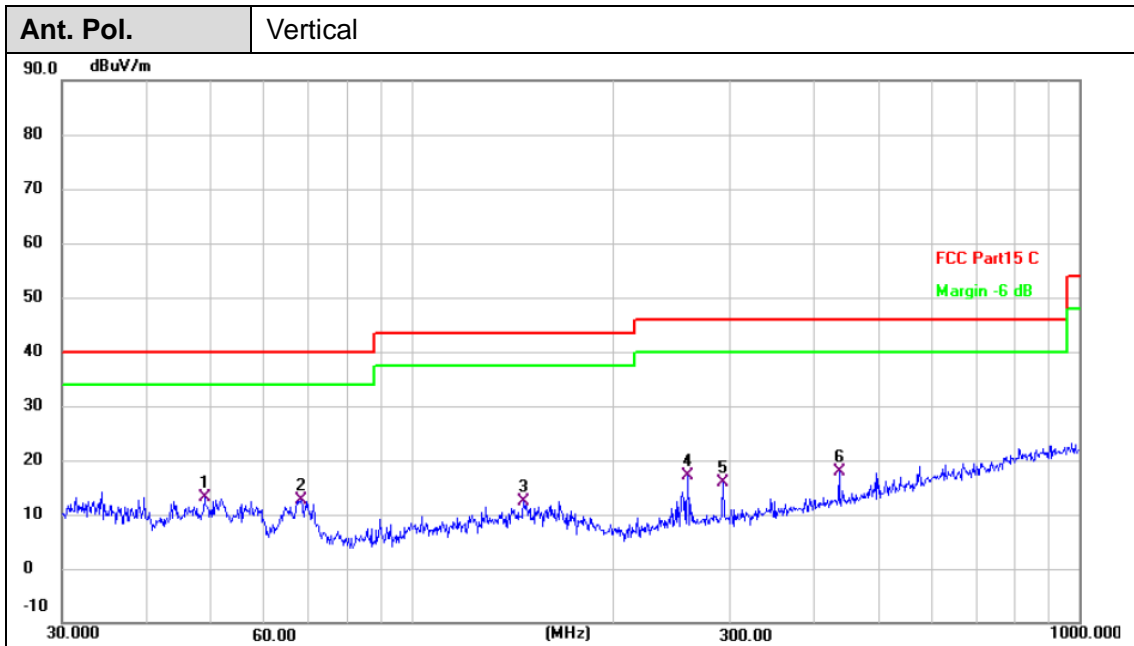

No.	Frequency (MHz)	Reading (dBuV)	Factor (dB/m)	Level (dBuV/m)	Limit (dBuV/m)	Margin (dB)	Detector
1 *	49.0145	30.73	-17.72	13.01	40.00	-26.99	QP
2	68.3908	32.84	-20.18	12.66	40.00	-27.34	QP
3	147.4036	29.03	-16.58	12.45	43.50	-31.05	QP
4	259.2338	35.51	-18.33	17.18	46.00	-28.82	QP
5	293.0842	33.31	-17.37	15.94	46.00	-30.06	QP
6	437.1199	31.61	-13.78	17.83	46.00	-28.17	QP

Remarks:

- 1. Factor (dB/m) = Antenna Factor (dB/m)+Cable Factor (dB)-Pre-amplifier Factor
- 2. Margin value = Level -Limit value



## 2.3. Occupied Bandwidth 20 dB Bandwidth

### Limit

#### FCC CFR Title 47 Part 15 Subpart C Section 15.215

Intentional radiators must be designed to ensure that the 20dB emission bandwidth in the specific band.

### Test Configuration

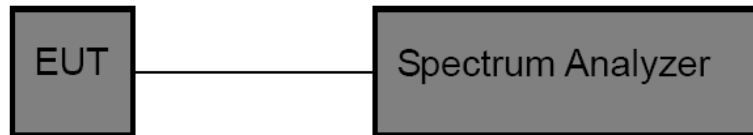

### Test Procedure

1. The EUT was directly connected to the spectrum analyzer and antenna output port as show in the block diagram above.
2. Spectrum Setting:
  - (1) Set RBW  $\geq$  1% of the 20 dB bandwidth.
  - (2) Set the video bandwidth (VBW)  $\geq$  RBW.
  - (3) Detector = Peak.
  - (4) Trace mode = Max hold.
  - (5) Sweep = Auto couple.

### Test Mode

Please refer to the clause 1.7.

### Test Results



Channel Frequency(kHz)	Occupied Bandwidth (kHz)	20dB Bandwidth (kHz)	Result
125	6.22	7.38	PASS

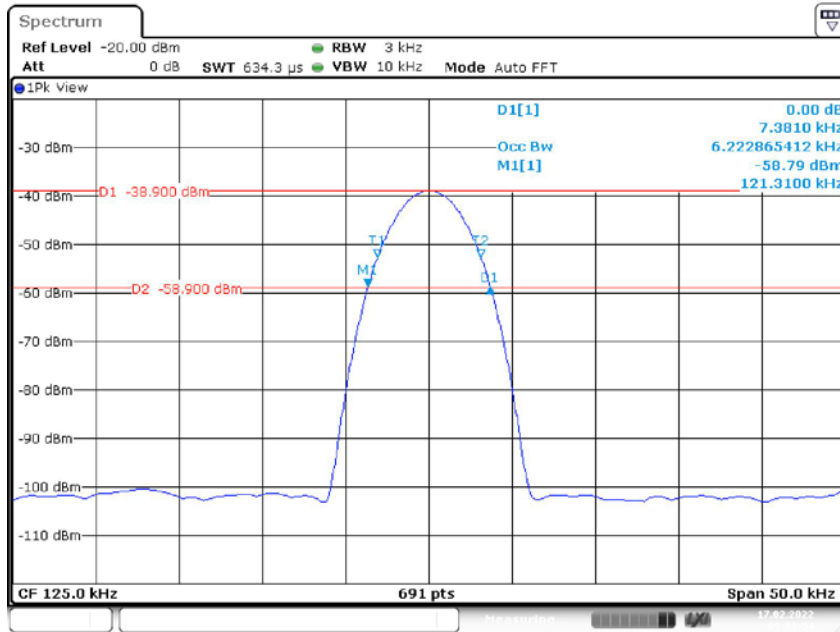

Date: 31.JUL.2023 09:31:54

## 2.4. Field Strength of the Fundamental

### Limit

#### FCC CFR Title 47 Part 15 Subpart C Section 15.209

Limit for frequency below 30MHz:

Frequency	Limit (uV/m)	Measurement Distance(m)	Remark
0.009~0.490	2400/F(kHz)	300	Quasi-peak
0.490~1.705	24000/F(kHz)	30	Quasi-peak
1.705~30.0	30	30	Quasi-peak

Note: Limit dBuV/m @3m = Limit dBuV/m @300m + 40\*log(300/3)= Limit dBuV/m @300m + 80,  
 Limit dBuV/m @3m = Limit dBuV/m @30m +40\*log(30/3)= Limit dBuV/m @30m + 40.

### Test Configuration

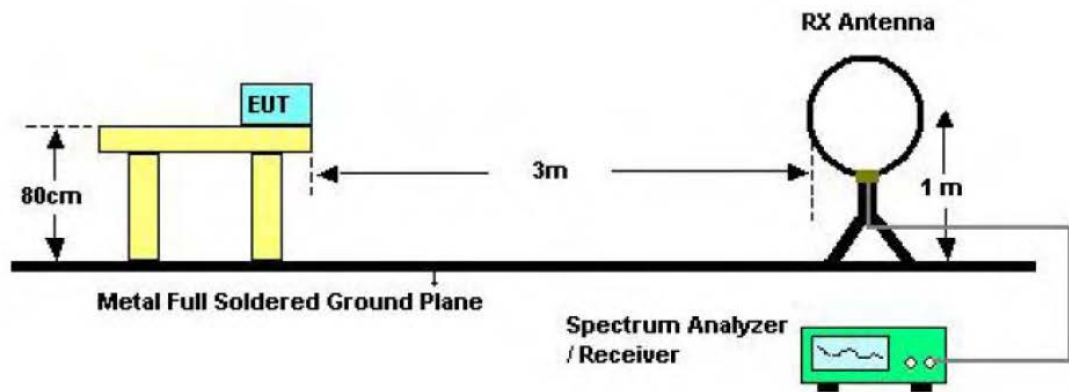

Below 30MHz Test Setup

### Test Procedure

1. The EUT was setup and tested according to ANSI C63.10:2013 requirements.
2. The EUT is placed on a turn table which is 0.8 meter above ground. The turn table is rotated 360 degrees to determine the position of the maximum emission level.
3. The EUT was positioned such that the distance from antenna to the EUT was 3 meters.
4. The antenna is scanned from 1 meter to 4 meters to find out the maximum emission level. This is repeated for both horizontal and vertical polarization of the antenna. In order to find the maximum emission, all of the interface cables were manipulated according to ANSI C63.10:2013 on radiated measurement.

### Test Mode

Please refer to the clause 1.7.



Test Result

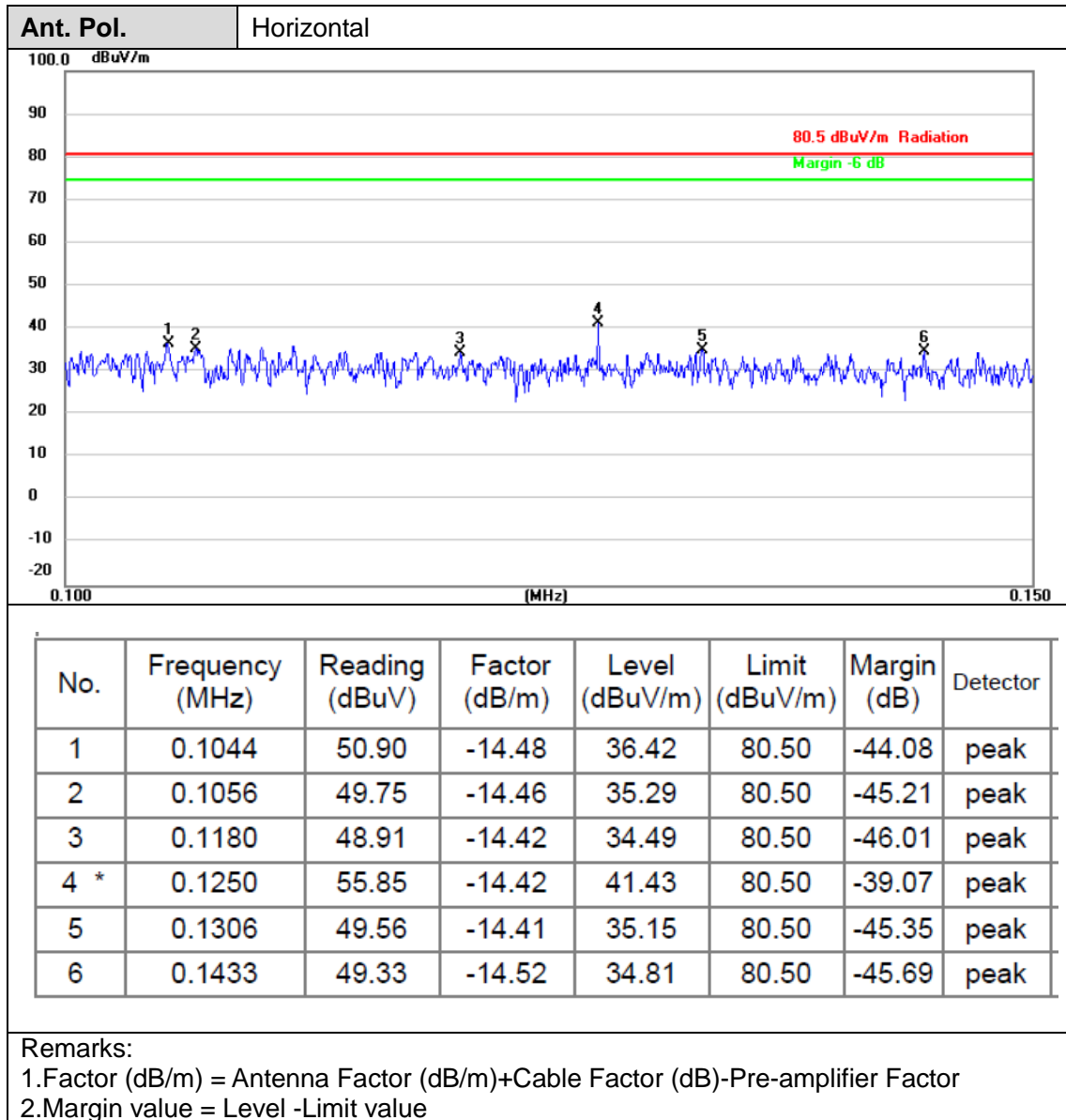



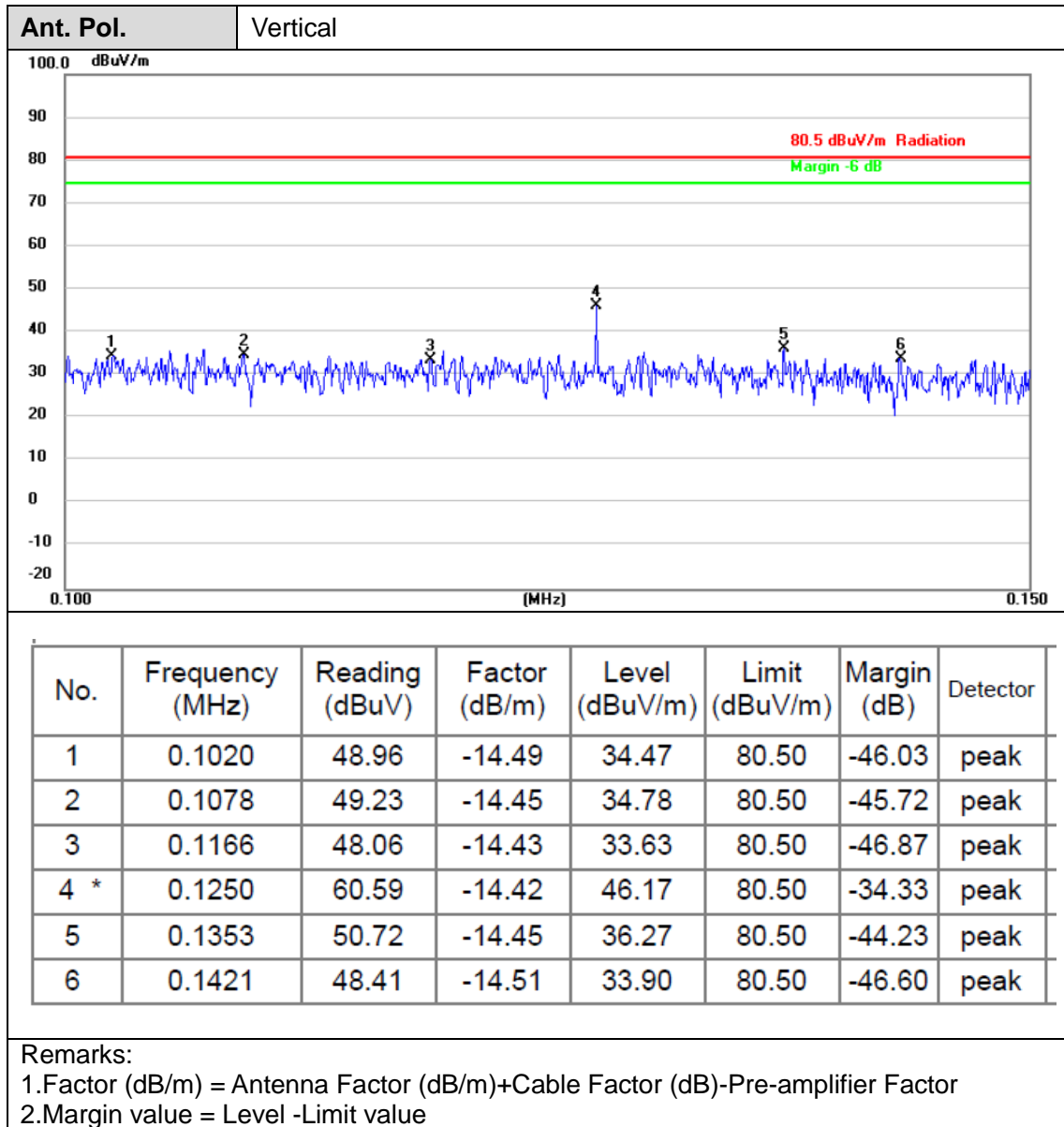



## 2.5. Antenna requirement

### Requirement

#### **FCC CFR Title 47 Part 15 Subpart C Section 15.203:**

An intentional radiator shall be designed to ensure that no antenna other than that furnished by the responsible party shall be used with the device. The use of a permanently attached antenna or of an antenna that uses a unique coupling to the intentional radiator, the manufacturer may design the unit so that a broken antenna can be replaced by the user, but the use of a standard antenna jack or electrical connector is prohibited.

#### **Refer to statement below for compliance.**

The manufacturer may design the unit so that the user can replace a broken antenna, but the use of a standard antenna jack or electrical connector is prohibited. Further, this requirement does not apply to intentional radiators that must be professionally installed.

The directional gain of the antenna less than 6dBi, please refer to the below antenna photo.

\*\*\*\*\*THE END\*\*\*\*\*