

FCC

RF

TEST REPORT

ISSUED BY
Shenzhen BALUN Technology Co., Ltd.



FOR
Automotive Diagnosis Terminal

ISSUED TO
Launch Tech Co., Ltd

Launch Industrial Park, North of Wuhe Road, Banxuegang Industrial Zone, Longgang District, Shenzhen City, Guangdong Province, China



Tested by: *Zou Liu*

Zou Liu
(Engineer)

Date: *Sep. 21, 2017*

Approved by: *[Signature]*

Wei Yanquan
(Chief Engineer)

Date: *Sep. 21, 2017*



Report No.: BL-SZ1790067-601

EUT Name: Automotive Diagnosis Terminal

Model Name: DS401

Brand Name: LAUNCH

Test Standard: 47 CFR Part 15 Subpart C

FCC ID: XUJDS401

Test conclusion: Pass

Test Date: Sep. 13, 2017 ~ Sep. 20, 2017

Date of Issue: Sep. 21, 2017

NOTE: This test report of test results only related to testing samples, which can be duplicated completely for the legal use with the approval of the applicant; it shall not be reproduced except in full, without the written approval of Shenzhen BALUN Technology Co., Ltd. BALUN Laboratory. Any objections should be raised within thirty days from the date of issue. To validate the report, please contact us.

Revision History

<u>Version</u>	<u>Issue Date</u>	<u>Revisions Content</u>
<u>Rev. 01</u>	<u>Sep. 21, 2017</u>	<u>Initial Issue</u>

TABLE OF CONTENTS

1	ADMINISTRATIVE DATA (GENERAL INFORMATION)	6
1.1	Identification of the Testing Laboratory	6
1.2	Identification of the Responsible Testing Location	6
1.3	Laboratory Condition	6
1.4	Announce	6
2	PRODUCT INFORMATION	7
2.1	Applicant Information	7
2.2	Manufacturer Information	7
2.3	Factory Information	7
2.4	General Description for Equipment under Test (EUT)	7
2.5	Ancillary Equipment	7
2.6	Technical Information	8
2.7	Additional Instructions	9
3	SUMMARY OF TEST RESULTS	10
3.1	Test Standards	10
3.2	Verdict	11
4	GENERAL TEST CONFIGURATIONS	12
4.1	Test Environments	12
4.2	Test Equipment List	12
4.3	Measurement Uncertainty	14
4.4	Description of Test Setup	14
4.4.1	For Antenna Port Test	14
4.4.2	For AC Power Supply Port Test	15
4.4.3	For Radiated Test (Below 30 MHz)	15

4.4.4	For Radiated Test (30 MHz-1 GHz)	16
4.4.5	For Radiated Test (Above 1 GHz).....	16
4.5	Measurement Results Explanation Example.....	17
4.5.1	For conducted test items:	17
4.5.2	For radiated band edges and spurious emission test:.....	17
5	TEST ITEMS.....	18
5.1	Antenna Requirements.....	18
5.1.1	Standard Applicable	18
5.1.2	Antenna Anti-Replacement Construction	18
5.1.3	Antenna Gain	19
5.2	Number of Hopping Frequencies	20
5.2.1	Limit.....	20
5.2.2	Test Setup	20
5.2.3	Test Procedure	20
5.2.4	Test Result	20
5.3	Peak Output Power and E.I.R.P.....	21
5.3.1	Test Limit.....	21
5.3.2	Test Setup	21
5.3.3	Test Procedure	21
5.3.4	Test Result	21
5.4	Occupied Bandwidth	22
5.4.1	Limit.....	22
5.4.2	Test Setup	22
5.4.3	Test Procedure	22
5.4.4	Test Result	22
5.5	Carrier Frequency Separation	23
5.5.1	Limit.....	23
5.5.2	Test Setup	23
5.5.3	Test Procedure	23
5.5.4	Test Result	23

5.6	Time of Occupancy (Dwell time)	24
5.6.1	Limit.....	24
5.6.2	Test Setup	24
5.6.3	Test Procedure	24
5.6.4	Test Result	24
5.7	Conducted Spurious Emission & Authorized-band band-edge	25
5.7.1	Limit.....	25
5.7.2	Test Setup	25
5.7.3	Test Procedure	25
5.7.4	Test Result	25
5.8	Conducted Emission	26
5.8.1	Limit.....	26
5.8.2	Test Setup	26
5.8.3	Test Procedure	26
5.8.4	Test Result	26
5.9	Radiated Spurious Emission	27
5.9.1	Limit.....	27
5.9.2	Test Setup	27
5.9.3	Test Procedure	27
5.9.4	Test Result	28
5.10	Band Edge (Restricted-band band-edge).....	29
5.10.1	Limit.....	29
5.10.2	Test Setup	29
5.10.3	Test Procedure	29
5.10.4	Test Result	29
ANNEX A	TEST RESULT	30
A.1	Number of Hopping Frequency	30
A.2	Peak Output Power and E.I.R.P	31
A.3	20 dB and 99% bandwidth	34
A.4	Hopping Frequency Separation.....	37

A.5	Average Time of Occupancy	38
A.6	Conducted Spurious Emissions & Authorized-band band-edge	40
A.7	Conducted Emissions.....	47
A.8	Radiated Spurious Emission	49
A.9	Band Edge (Restricted-band band-edge).....	58
ANNEX B	TEST SETUP PHOTOS	61
ANNEX C	EUT EXTERNAL PHOTOS	61
ANNEX D	EUT INTERNAL PHOTOS	61

1 ADMINISTRATIVE DATA (GENERAL INFORMATION)

1.1 Identification of the Testing Laboratory

Company Name	Shenzhen BALUN Technology Co., Ltd.
Address	Block B, 1st FL, Baisha Science and Technology Park, Shahe Xi Road, Nanshan District, Shenzhen, Guangdong Province, P. R. China
Phone Number	+86 755 6685 0100

1.2 Identification of the Responsible Testing Location

Test Location	Shenzhen BALUN Technology Co., Ltd.
Address	Block B, 1st FL, Baisha Science and Technology Park, Shahe Xi Road, Nanshan District, Shenzhen, Guangdong Province, P. R. China
Accreditation Certificate	The laboratory has been listed by Industry Canada to perform electromagnetic emission measurements. The recognition numbers of test site are 11524A-1. The laboratory has been listed by US Federal Communications Commission to perform electromagnetic emission measurements. The recognition numbers of test site are 832625. The laboratory is a testing organization accredited by China National Accreditation Service for Conformity Assessment (CNAS) according to ISO/IEC 17025. The accreditation certificate number is L6791.
Description	All measurement facilities used to collect the measurement data are located at Block B, FL 1, Baisha Science and Technology Park, Shahe Xi Road, Nanshan District, Shenzhen, Guangdong Province, P. R. China 518055

1.3 Laboratory Condition

Ambient Temperature	20 to 25°C
Ambient Relative Humidity	45% - 55%
Ambient Pressure	100 kPa - 102 kPa

1.4 Announce

- (1) The test report reference to the report template version v5.8.
- (2) The test report is invalid if not marked with the signatures of the persons responsible for preparing and approving the test report.
- (3) The test report is invalid if there is any evidence and/or falsification.
- (4) The results documented in this report apply only to the tested sample, under the conditions and modes of operation as described herein.
- (5) This document may not be altered or revised in any way unless done so by BALUN and all revisions are duly noted in the revisions section.
- (6) Content of the test report, in part or in full, cannot be used for publicity and/or promotional purposes without prior written approval from the laboratory.

2 PRODUCT INFORMATION

2.1 Applicant Information

Applicant	Launch Tech Co., Ltd
Address	Launch Industrial Park, North of Wuhe Road, Banxuegang Industrial Zone, Longgang District, Shenzhen City, Guangdong Province, China

2.2 Manufacturer Information

Manufacturer	Launch Tech Co., Ltd
Address	Launch Industrial Park, North of Wuhe Road, Banxuegang Industrial Zone, Longgang District, Shenzhen City, Guangdong Province, China

2.3 Factory Information

Factory	N/A
Address	N/A

2.4 General Description for Equipment under Test (EUT)

EUT Type	Automotive Diagnosis Terminal
Model Name Under Test	DS401
Series Model Name	N/A
Description of Model name differentiation	N/A
Hardware Version	N/A
Software Version	N/A
Dimensions (Approx.)	N/A
Weight (Approx.)	N/A
Network and Wireless connectivity	Bluetooth 3.0, Bluetooth 4.2 Low Energy (BLE)

2.5 Ancillary Equipment

Note: Not applicable.

2.6 Technical Information

The requirement for the following technical information of the EUT was tested in this report:

Modulation Technology	FHSS
Modulation Type	GFSK, $\pi/4$ -DQPSK, 8-DPSK
Product Type	<input type="checkbox"/> Mobile <input type="checkbox"/> Portable <input checked="" type="checkbox"/> Fix Location
Transfer Rate	DH5: 1 Mbps 2DH5: 2 Mbps 3DH5: 3 Mbps
Frequency Range	The frequency range used is 2400 MHz to 2483.5 MHz.
Number of channel	79 (at intervals of 1 MHz)
Tested Channel	0 (2402 MHz), 39 (2441 MHz), 78 (2480 MHz)
Antenna Type	Ceramic Antenna
Antenna Gain	0 dBi (All involve the antenna gain test item, has been included in the final results)
Antenna System(MIMO Smart Antenna)	N/A

All channel was listed on the following table:

Channel number	Freq. (MHz)	Channel number	Freq. (MHz)	Channel number	Freq. (MHz)	Channel number	Freq. (MHz)
0	2402	21	2423	42	2444	63	2465
1	2403	22	2424	43	2445	64	2466
2	2404	23	2425	44	2446	65	2467
3	2405	24	2426	45	2447	66	2468
4	2406	25	2427	46	2448	67	2469
5	2407	26	2428	47	2449	68	2470
6	2408	27	2429	48	2450	69	2471
7	2409	28	2430	49	2451	70	2472
8	2410	29	2431	50	2452	71	2473
9	2411	30	2432	51	2453	72	2474
10	2412	31	2433	52	2454	73	2475
11	2413	32	2434	53	2455	74	2476
12	2414	33	2435	54	2456	75	2477
13	2415	34	2436	55	2457	76	2478
14	2416	35	2437	56	2458	77	2479
15	2417	36	2438	57	2459	78	2480
16	2418	37	2439	58	2460	-	-
17	2419	38	2440	59	2461	-	-
18	2420	39	2441	60	2462	-	-
19	2421	40	2442	61	2463	-	-
20	2422	41	2443	62	2464	-	-

2.7 Additional Instructions

EUT Software Settings:

Mode	<input checked="" type="checkbox"/> Special software is used. The software provided by client to enable the EUT under transmission condition continuously at specific channel frequencies individually.
------	--

Power level setup in software			
Test Software Version	ISRT		
Support Units (Software installation media)	Description	Manufacturer	Model
	Laptop	Lenovo	X220
Mode	Channel	Frequency (MHz)	Soft Set
DH5	CH0	2402	TX LEVEL is built-in set parameters and cannot be changed and selected.
	CH39	2441	
	CH78	2480	
2DH5	CH0	2402	
	CH39	2441	
	CH78	2480	
3DH5	CH0	2402	
	CH39	2441	
	CH78	2480	

Run Software:

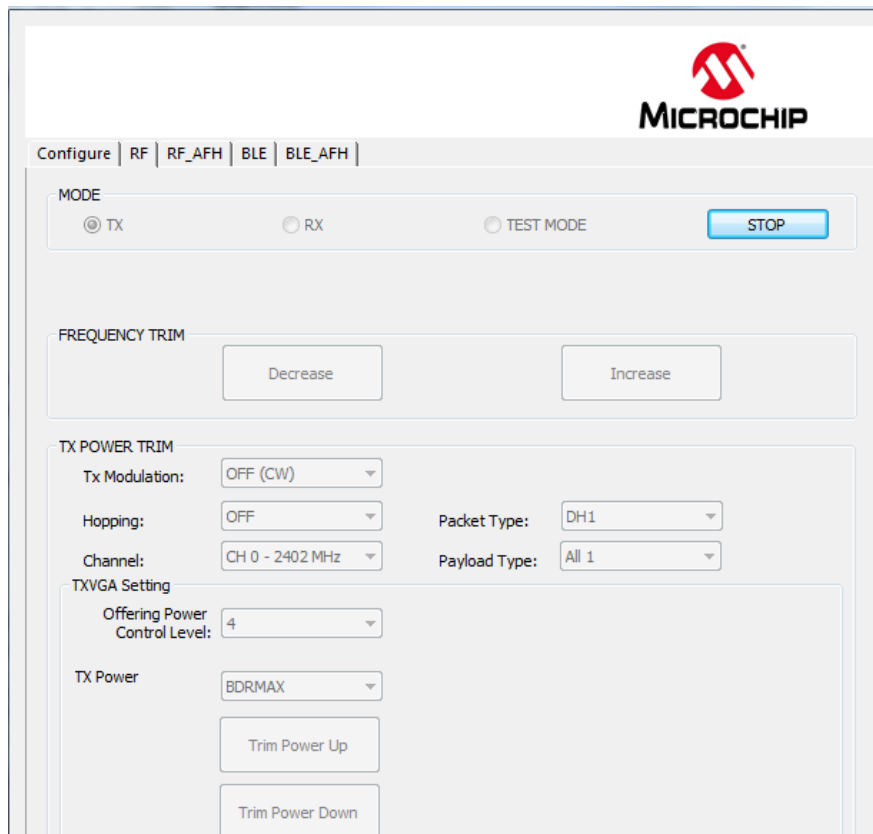

3 SUMMARY OF TEST RESULTS

3.1 Test Standards

No.	Identity	Document Title
1	47 CFR Part 15, Subpart C (10-1-15 Edition)	Miscellaneous Wireless Communications Services
2	FCC PUBLIC NOTICE DA 00-705 (Mar. 30, 2000)	Filling and Measurement Guidelines for Frequency Hopping Spread Spectrum Systems
3	ANSI C63.10-2013	American National Standard for Testing Unlicensed Wireless Devices

3.2 Verdict

No.	Description	FCC Part No.	ISED Part No.	Channel	Test Result	Verdict	Remark
1	Antenna Requirement	15.203	RSS-247, 5.4 (6)	N/A	--	Pass	Note ¹
2	Number of Hopping Frequencies	15.247(a)	RSS-247, 5.1 (4)	Hopping Mode	ANNEX A.1	Pass	Note ²
3	Peak Output Power and E.I.R.P	15.247(b)	RSS-247, 5.4 (2)	Low/Middle/High	ANNEX A.2	Pass	--
4	Occupied Bandwidth	15.247(a)	RSS-247, 5.1 (1)	Low/Middle/High	ANNEX A.3	Pass	Note ²
5	Carrier Frequency Separation	15.247(a)	RSS-247, 5.1 (2)	Hopping Mode	ANNEX A.4	Pass	Note ²
6	Time of Occupancy (Dwell time)	15.247(a)	RSS-247, 5.1 (4)	Hopping Mode	ANNEX A.5	Pass	Note ²
7	Conducted Spurious Emission & Authorized-band band-edge	15.247(d)	RSS-247, 5.5	Low/Middle/High	ANNEX A.6	Pass	Note ²
8	Conducted Emission	15.207	RSS-GEN, 8.8	Low/Middle/High	ANNEX A.7	Pass	Note ²
9	Radiated Spurious Emission	15.209 15.247(d)	RSS-247, 5.5	Hopping Mode, Low/Middle/High	ANNEX A.8	Pass	Note ²
10	Band Edge(Restricted-band band-edge)	15.209 15.247(d)	RSS-247, 5.5	Hopping Mode, Low/Middle/High	ANNEX A.9	Pass	Note ²
11	Receiver Spurious Emissions	--	RSS-Gen, 7.1.2	--	--	N/A	Note ³

Note ¹: Please refer to section 5.1

Note ²: Because of the modulation of $\Pi/4$ -DQPSK same as 8-DPSK, and the test results are basically the same with them, so we chose 8-DPSK as a typical representative to appear on the report. Another we will show all the modes on the RF output power test item

Note ³: Only radio communication receivers operating in stand-alone mode within the band 30-960 MHz, as well as scanner receivers, are subject to Industry Canada requirements, so this test is not applicable.

4 GENERAL TEST CONFIGURATIONS

4.1 Test Environments

During the measurement, the normal environmental conditions were within the listed ranges:

Relative Humidity	45% - 55%	
Atmospheric Pressure	100 kPa - 102 kPa	
Temperature	NT (Normal Temperature)	+22°C to +25°C
Working Voltage of the EUT	NV (Normal Voltage)	5 V

4.2 Test Equipment List

Description	Manufacturer	Model	Serial No.	Cal. Date	Cal. Due
Spectrum Analyzer	ROHDE&SCHWARZ	FSV-30	103118	2017.06.22	2018.06.21
Switch Unit with OSP-B157	ROHDE&SCHWARZ	OSP120	101270	2017.06.22	2018.06.21
EMI Receiver	KEYSIGHT	N9038A	MY53220118	2016.09.09	2017.09.08
EMI Receiver	ROHDE&SCHWARZ	ESRP	101036	2017.06.22	2018.06.21
LISN	SCHWARZBECK	NSLK 8127	8127-687	2017.06.22	2018.06.21
Bluetooth Tester	ROHDE&SCHWARZ	CBT	101005	2017.06.22	2018.06.21
Power Splitter	KMW	DCPD-LDC	1305003215	--	--
Power Sensor	ROHDE&SCHWARZ	NRP-Z21	103971	2017.06.22	2018.06.21
Attenuator (20 dB)	KMW	ZA-S1-201	110617091	--	--
Attenuator (6 dB)	KMW	ZA-S1-61	1305003189	--	--
DC Power Supply	ROHDE&SCHWARZ	HMP2020	018141664	2017.06.22	2018.06.21
Temperature Chamber	ANGELANTIONI SCIENCE	NTH64-40A	1310	2017.06.22	2018.06.21
Test Antenna-Loop(9 kHz-30 MHz)	SCHWARZBECK	FMZB 1519	1519-037	2017.06.22	2018.06.21
Test Antenna-Bi-Log(30 MHz-3 GHz)	SCHWARZBECK	VULB 9163	9163-624	2017.06.22	2018.06.21
Test Antenna-Horn(1-18 GHz)	SCHWARZBECK	BBHA 9120D	9120D-1148	2017.06.22	2018.06.21
Test Antenna-Horn(15-26.5 GHz)	SCHWARZBECK	BBHA 9170	9170-305	2017.06.22	2018.06.21
Anechoic Chamber	RAINFORD	9m*6m*6m	N/A	2017.02.24	2019.02.23
Anechoic Chamber	EMC Electronic Co., Ltd	20.10*11.60*7.35m	N/A	2016.08.09	2018.08.08
Shielded Enclosure	ChangNing	CN-130701	130703	--	--
Signal Generator	ROHDE&SCHWARZ	SMB100A	177746	2017.06.22	2018.06.21
Power Amplifier	OPHIR RF	5225F	1037	2017.02.17	2018.02.16
Power Amplifier	OPHIR RF	5273F	1016	2017.02.17	2018.02.16

Description	Manufacturer	Model	Serial No.	Cal. Date	Cal. Due
Directional Coupler	Werlantone	C5982-10	109275	N/A	N/A
Directional Coupler	Werlantone	CHP-273E	S00801z-01	N/A	N/A
Feld Strength Meter	Narda	EP601	511WX5112 9	2017.02.23	2018.02.22
Mouth Simulator	B&K	4227	2423931	2016.11.15	2017.11.14
Sound Calibrator	B&K	4231	2430337	2016.11.09	2017.11.08
Sound Level Meter	B&K	NL-20	00844023	2016.11.11	2017.11.10
Ear Simulator	B&K	4185	2409449	2016.11.15	2017.11.14
Ear Simulator	B&K	4195	2418189	2016.11.15	2017.11.14
Audio analyzer	B&K	UPL 16	100129	2016.11.08	2017.11.07

4.3 Measurement Uncertainty

The following measurement uncertainty levels have been estimated for tests performed on the EUT as specified in CISPR 16-4-2.

This uncertainty represents an expanded uncertainty expressed at approximately the 95% confidence level using a coverage factor of k=2.

Measurement	Value
Occupied Channel Bandwidth	±4%
RF output power, conducted	±1.4 dB
Power Spectral Density, conducted	±2.5 dB
Unwanted Emissions, conducted	±2.8 dB
All emissions, radiated	±5.4 dB
Temperature	±1°C
Humidity	±4%

4.4 Description of Test Setup

4.4.1 For Antenna Port Test

Conducted value (dBm) = Measurement value (dBm) + cable loss (dB)

For example: the measurement value is 10 dBm and the cable 0.5dBm used, then the final result of EUT:

Conducted value (dBm) = 10 dBm + 0.5 dB = 10.5 dBm

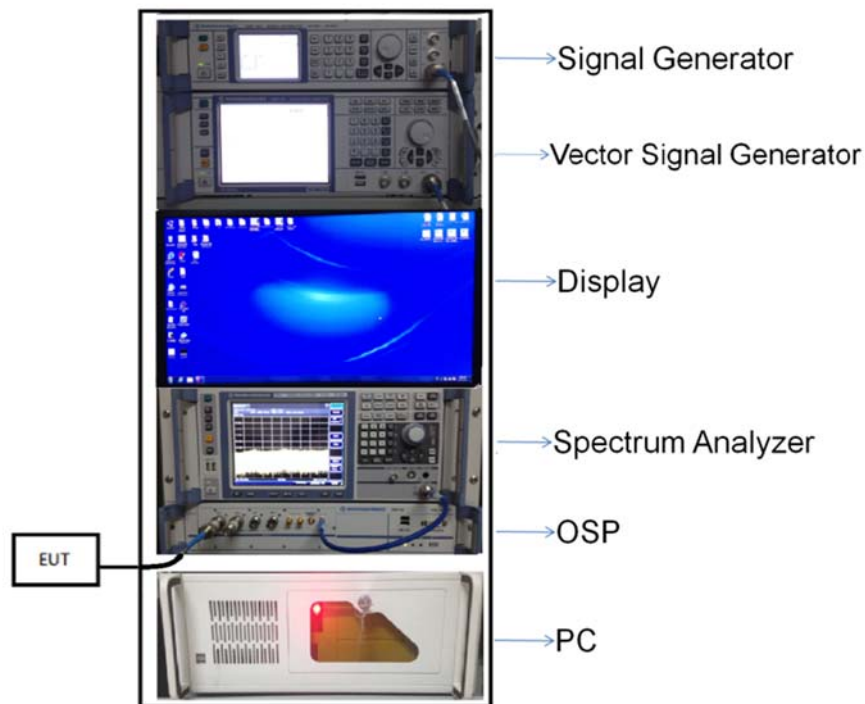

(Diagram 1)

4.4.2 For AC Power Supply Port Test

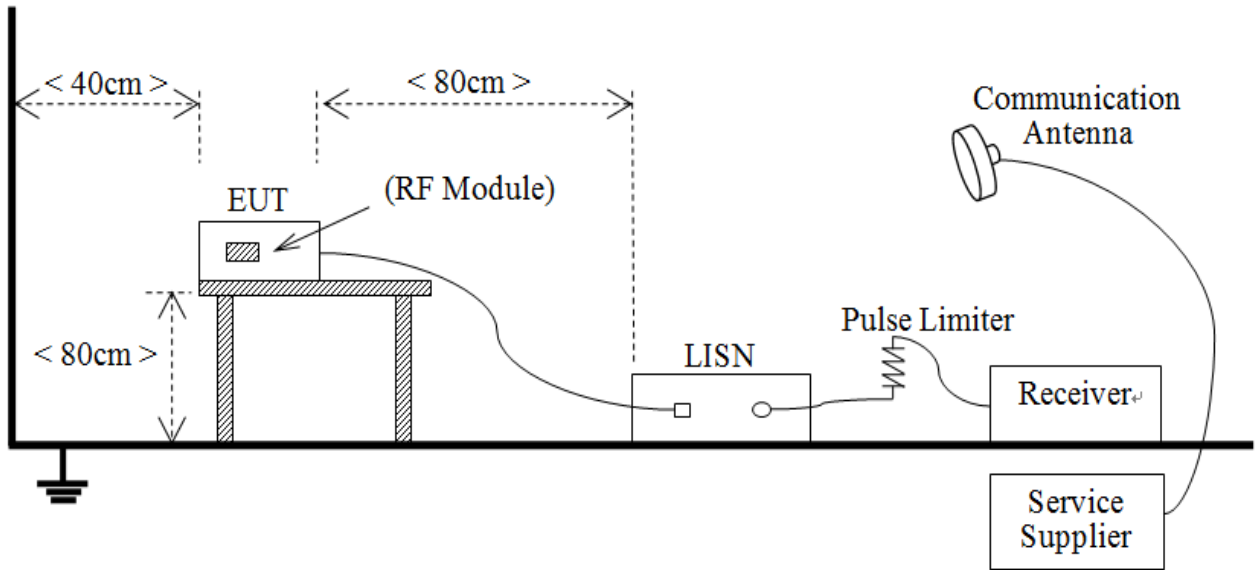

(Diagram 2)

4.4.3 For Radiated Test (Below 30 MHz)

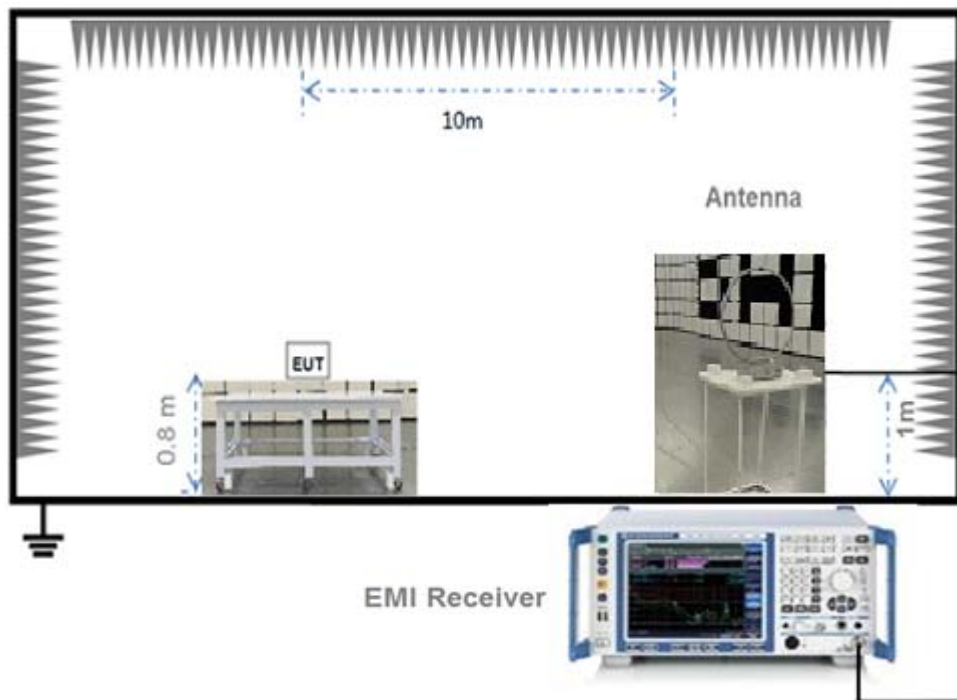

(Diagram 3)

4.4.4 For Radiated Test (30 MHz-1 GHz)

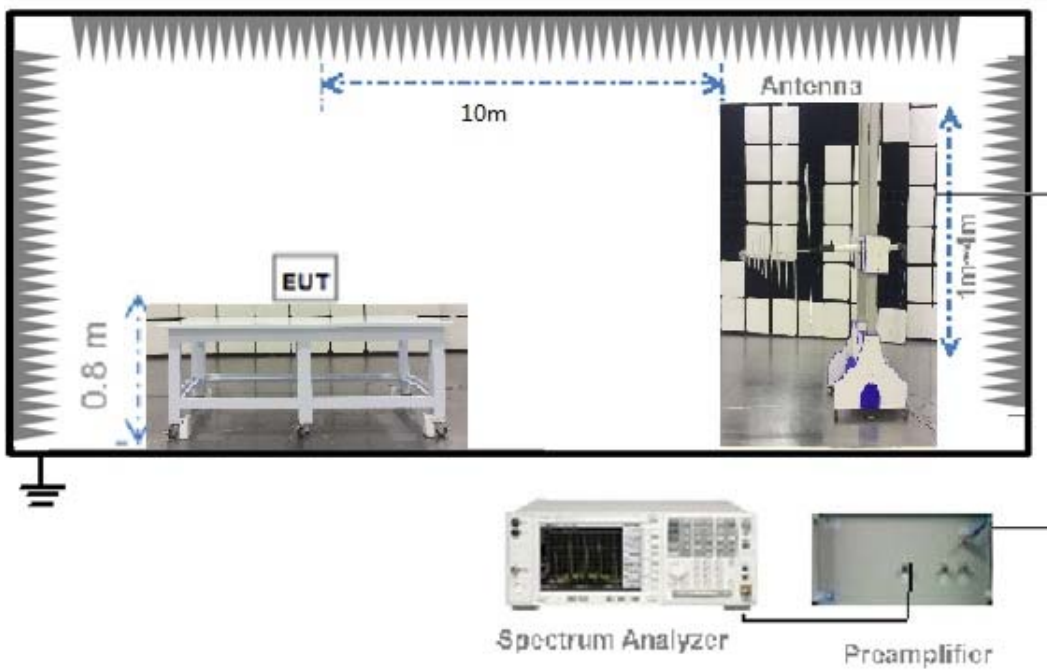

(Diagram 4)

4.4.5 For Radiated Test (Above 1 GHz)

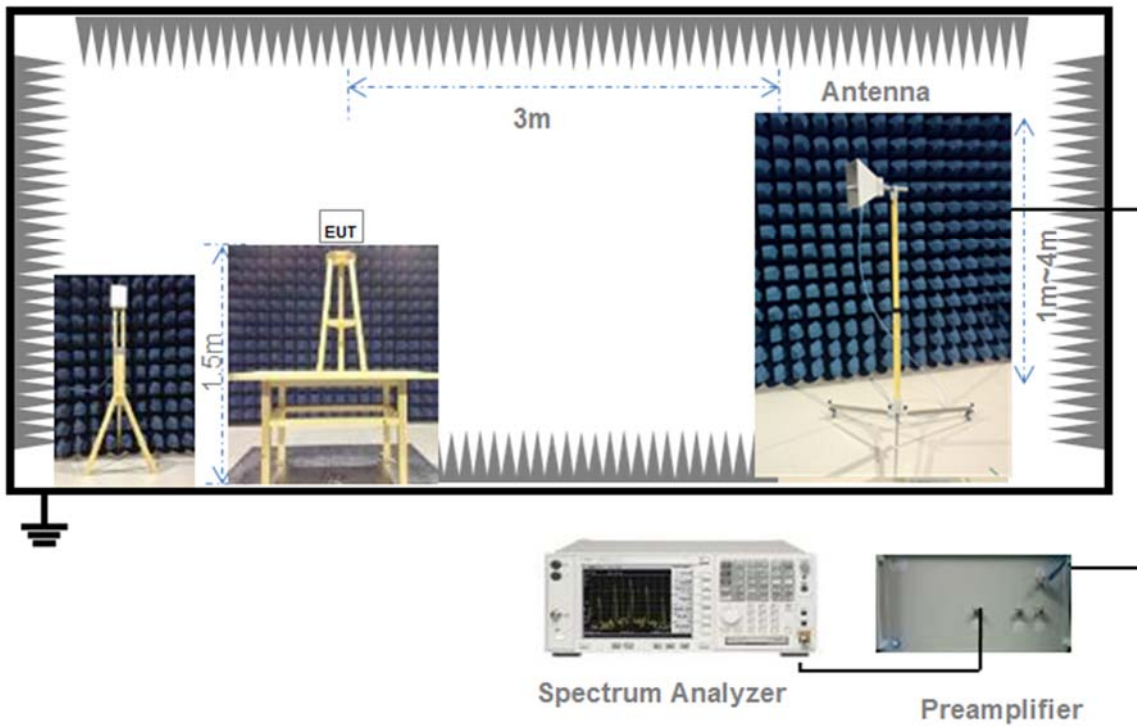

(Diagram 5)

4.5 Measurement Results Explanation Example

4.5.1 For conducted test items:

The offset level is set in the spectrum analyzer to compensate the RF cable loss and attenuator between EUT conducted output port and spectrum analyzer. With the offset compensation, the spectrum analyzer reading level is exactly the EUT RF output level.

The spectrum analyzer offset is derived from RF cable loss and attenuator factor.

Offset = RF cable loss + attenuator factor.

4.5.2 For radiated band edges and spurious emission test:

Per part 15.35(c), the EUT Bluetooth average emission level could be determined by the peak emission level applying duty cycle correction factor, to represent averaging over the whole pulse train.

The average level is derived from the peak level corrected with "Duty cycle correction factor".

Average Emission Level (dBuV/m) = Peak Emission Level (dBuV/m) + Duty cycle correction factor (dB)

Duty cycle correction factor (dB) = $20 * \log(\text{Duty cycle})$.

Duty cycle = on time / 100 milliseconds

On time = dwell time * hopping number in 100 ms

For example: bluetooth with dwell time 2.9 ms and 3 hops in 100 ms, then

Duty cycle correction factor (dB) = $20 * \log((2.9 * 3) / 100) = -21.21 \text{ dB}$

Following shows an average computation example with duty cycle correction factor = -21.21 dB, and the peak emission level is 45.61 dBuV/m.

Example:

Average Emission Level (dBuV/m) = Peak Emission Level (dBuV/m) + duty cycle correction factor (dB)
= $45.61 + (-21.21) = 24.4 \text{ (dBuV/m)}$

5 TEST ITEMS

5.1 Antenna Requirements

5.1.1 Standard Applicable

FCC §15.203 & 15.247(b); RSS-247, 5.4 (6)

An intentional radiator shall be designed to ensure that no antenna other than that furnished by the responsible party shall be used with the device. The use of a permanently attached antenna or of an antenna that uses a unique coupling to the intentional radiator shall be considered sufficient to comply with the provisions of this section. The manufacturer may design the unit so that a broken antenna can be replaced by the user, but the use of a standard antenna jack or electrical connector is prohibited. This requirement does not apply to carrier current devices or to devices operated under the provisions of § 15.211, § 15.213, § 15.217, § 15.219, or § 15.221. Further, this requirement does not apply to intentional radiators that must be professionally installed, such as perimeter protection systems and some field disturbance sensors, or to other intentional radiators which, in accordance with § 15.31(d), must be measured at the installation site. However, the installer shall be responsible for ensuring that the proper antenna is employed so that the limits in this part are not exceeded.

If directional gain of transmitting antennas is greater than 6 dBi, the power shall be reduced by the same level in dB comparing to gain minus 6 dBi. For the fixed point-to-point operation, the power shall be reduced by one dB for every 3 dB that the directional gain of the antenna exceeds 6 dBi. The use of a permanently attached antenna or of an antenna that uses a unique coupling to the intentional radiator shall be considered sufficient to comply with the FCC rule.

5.1.2 Antenna Anti-Replacement Construction

The Antenna Anti-Replacement as following method:

Protected Method	Description
The antenna is An embedded-in	The antenna is welded on the mainboard, can't be replaced by the consumer

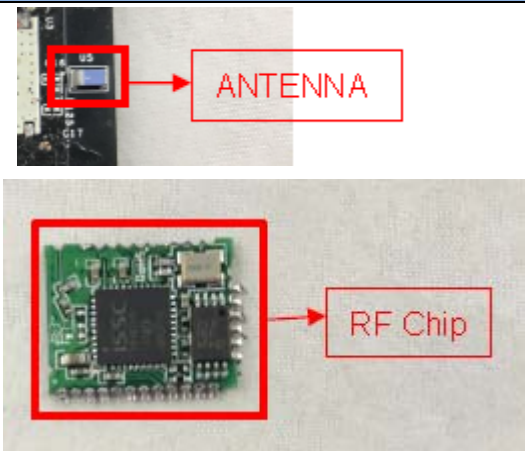
Reference Documents	Item
Photo	

5.1.3 Antenna Gain

The antenna peak gain of EUT is less than 6 dBi. Therefore, it is not necessary to reduce maximum peak output power limit.

5.2 Number of Hopping Frequencies

5.2.1 Limit

FCC §15.247(a) (1) (iii); RSS-247, 5.1 (4)

Frequency hopping systems operating in the 2400 MHz to 2483.5 MHz bands shall use at least 15 hopping frequencies.

5.2.2 Test Setup

See section 4.4.1 for test setup description for the antenna port. The photo of test setup please refer to ANNEX B.

5.2.3 Test Procedure

The EUT must have its hopping function enabled. Use the following spectrum analyzer settings:

Span = the frequency band of operation

RBW \geq 1% of the span

VBW \geq RBW

Sweep = auto

Detector function = peak

Trace = max hold

Allow the trace to stabilize

5.2.4 Test Result

Please refer to ANNEX A.1.

5.3 Peak Output Power and E.I.R.P

5.3.1 Test Limit

FCC § 15.247(b)

For frequency hopping systems operating in the 2400-2483.5 MHz band employing at least 75 non-overlapping hopping channels. For all other frequency hopping systems in the 2400-2483.5 MHz band: 0.125 watts.

RSS-247, 5.4 (2)

For FHSs operating in the band 2400-2483.5 MHz, the maximum peak conducted output power shall not exceed 1.0 W and the e.i.r.p. shall not exceed 4 W if the hopset uses 75 or more hopping channels; the maximum peak conducted output power shall not exceed 0.125 W and the e.i.r.p. shall not exceed 0.5 W if the hopset uses less than 75 hopping channels (see Section 5.4(5) for exceptions).

5.3.2 Test Setup

See section 4.4.1 for test setup description for the antenna port. The photo of test setup please refer to ANNEX B.

5.3.3 Test Procedure

The Module operates at hopping-off test mode. The lowest, middle and highest channels are selected to perform testing to verify the conducted RF output peak power of the Module.

Use the following spectrum analyzer settings:

Span = approximately 5 times the 20 dB bandwidth, centered on a hopping channel

RBW > the 20 dB bandwidth of the emission being measured

VBW \geq RBW

Sweep = auto

Detector function = peak

Trace = max hold

Allow the trace to stabilize.

5.3.4 Test Result

Please refer to ANNEX A.2.

5.4 Occupied Bandwidth

5.4.1 Limit

FCC §15.247(a); RSS-247, 5.1 (1)

Measurement of the 20dB bandwidth of the modulated signal.

5.4.2 Test Setup

See section 4.4.1 for test setup description for the antenna port. The photo of test setup please refer to ANNEX B.

5.4.3 Test Procedure

Use the following spectrum analyzer settings:

Span = approximately 2 to 3 times the 20 dB bandwidth, centered on a hopping channel

RBW = in the range of 1% to 5% of the OBW

VBW \geq RBW

Sweep = auto

Detector function = peak

Trace = max hold

The EUT should be transmitting at its maximum data rate, Allow the trace to stabilize.

5.4.4 Test Result

Please refer to ANNEX A.3.

5.5 Carrier Frequency Separation

5.5.1 Limit

FCC §15.247(a); RSS-247, 5.1 (2)

Frequency hopping systems shall have hopping channel carrier frequencies separated by a minimum of 25 kHz or the 20 dB bandwidth of the hopping channel, whichever is greater. Alternatively, Frequency hopping systems shall have hopping channel carrier frequencies separated by a minimum of 25 kHz or two-thirds of the 20 dB bandwidth of the hopping channel, whichever is greater, provided the systems operate with an output power no greater than 125 mW.

5.5.2 Test Setup

See section 4.4.1 for test setup description for the antenna port. The photo of test setup please refer to ANNEX B.

5.5.3 Test Procedure

The EUT must have its hopping function enabled. Use the following spectrum analyzer settings:

Span = wide enough to capture the peaks of two adjacent channels

Resolution (or IF) Bandwidth (RBW) \geq 1% of the span

Video (or Average) Bandwidth (VBW) \geq RBW

Sweep = auto

Detector function = peak

Trace = max hold

Allow the trace to stabilize. Use the marker-delta function to determine the separation between the peaks of the adjacent channels.

5.5.4 Test Result

Please refer to ANNEX A.4.

5.6 Time of Occupancy (Dwell time)

5.6.1 Limit

FCC §15.247(a); RSS-247, 5.1 (4)

Frequency hopping systems in the 2400 MHz - 2483.5 MHz band shall use at least 15 non-overlapping channels. The average time of occupancy on any channel shall not be greater than 0.4 seconds within a period of 0.4 seconds multiplied by the number of hopping channels employed. Frequency hopping systems may avoid or suppress transmissions on a particular hopping frequency provided that a minimum of 15 channels are used.

5.6.2 Test Setup

See section 4.4.1 for test setup description for the antenna port. The photo of test setup please refer to ANNEX B.

5.6.3 Test Procedure

The average time of occupancy on any channel within the Period can be calculated with formulas:

For DH1 package type

$$\begin{aligned}\{\text{Total of Dwell}\} &= \{\text{Pulse Time}\} * (1600 / 2) / \{\text{Number of Hopping Frequency}\} * \{\text{Period}\} \\ \{\text{Period}\} &= 0.4 \text{ s} * \{\text{Number of Hopping Frequency}\}\end{aligned}$$

For DH3 package type

$$\begin{aligned}\{\text{Total of Dwell}\} &= \{\text{Pulse Time}\} * (1600 / 4) / \{\text{Number of Hopping Frequency}\} * \{\text{Period}\} \\ \{\text{Period}\} &= 0.4 \text{ s} * \{\text{Number of Hopping Frequency}\}\end{aligned}$$

For DH5 package type

$$\begin{aligned}\{\text{Total of Dwell}\} &= \{\text{Pulse Time}\} * (1600 / 6) / \{\text{Number of Hopping Frequency}\} * \{\text{Period}\} \\ \{\text{Period}\} &= 0.4 \text{ s} * \{\text{Number of Hopping Frequency}\}\end{aligned}$$

The lowest, middle and highest channels are selected to perform testing to record the dwell time of each occupation measured in this channel, which is called Pulse Time here.

5.6.4 Test Result

Please refer to ANNEX A.5

5.7 Conducted Spurious Emission & Authorized-band band-edge

5.7.1 Limit

FCC §15.247(d); RSS-247, 5.5

In any 100 kHz bandwidth outside the frequency band in which the spread spectrum or digitally modulated intentional radiator is operating, the radio frequency power that is produced by the intentional radiator shall be at least 20 dB below that in the 100 kHz bandwidth within the band that contains the highest level of the desired power, based on either an RF conducted or a radiated measurement.

5.7.2 Test Setup

See section 4.4.1 for test setup description for the antenna port. The photo of test setup please refer to ANNEX B.

5.7.3 Test Procedure

Use the following spectrum analyzer settings:

Span = wide enough to capture the peak level of the in-band emission and all spurious emissions (e.g., harmonics) from the lowest frequency generated in the EUT up through the 10th harmonic. Typically, several plots are required to cover this entire span.

RBW = 100 kHz

VBW \geq RBW

Sweep = auto

Detector function = peak

Trace = max hold

Allow the trace to stabilize

5.7.4 Test Result

Please refer to ANNEX A.6.

5.8 Conducted Emission

5.8.1 Limit

FCC §15.207; RSS-GEN, 8.8

For an intentional radiator that is designed to be connected to the public utility (AC) power line, the radio frequency voltage that is conducted back onto the AC power line on any frequency within the band 150 kHz to 30 MHz shall not exceed the limits in the following table, as measured using a 50 μ H/50 Ω line impedance stabilization network (LISN).

Frequency range (MHz)	Conducted Limit (dB μ V)	
	Quai-peak	Average
0.15 - 0.50	66 to 56	56 to 46
0.50 - 5	56	46
0.50 - 30	60	50

5.8.2 Test Setup

See section 4.4.2 for test setup description for the AC power supply port. The photo of test setup please refer to ANNEX B.

5.8.3 Test Procedure

The maximum conducted interference is searched using Peak (PK), if the emission levels more than the AV and QP limits, and that have narrow margins from the AV and QP limits will be re-measured with AV and QP detectors. Tests for both L phase and N phase lines of the power mains connected to the EUT are performed. Refer to recorded points and plots below.

Devices subject to Part 15 must be tested for all available U.S. voltages and frequencies (such as a nominal 120 VAC, 50/60 Hz and 240 VAC, 50/60 Hz) for which the device is capable of operation. A device rated for 50/60 Hz operation need not be tested at both frequencies provided the radiated and line conducted emissions are the same at both frequencies.

5.8.4 Test Result

Please refer to ANNEX A.7.

5.9 Radiated Spurious Emission

5.9.1 Limit

FCC §15.209&15.247(d); RSS-247, 5.5

Radiated emission outside the frequency band attenuation below the general limits specified in FCC section 15.209(a) is not required. In addition, radiated emissions which fall in the restricted bands, as defined in FCC section 15.205(a), must also comply with the radiated emission limits specified in FCC section 15.209(a).

According to FCC section 15.209 (a), except as provided elsewhere in this subpart, the emissions from an intentional radiator shall not exceed the field strength levels specified in the following table:

Frequency (MHz)	Field Strength ($\mu\text{V}/\text{m}$)	Measurement Distance (m)
0.009 - 0.490	2400/F(kHz)	300
0.490 - 1.705	24000/F(kHz)	30
1.705 - 30.0	30	30
30 - 88	100	3
88 - 216	150	3
216 - 960	200	3
Above 960	500	3

Note:

1. Field Strength (dB $\mu\text{V}/\text{m}$) = 20*log[Field Strength ($\mu\text{V}/\text{m}$)].
2. In the emission tables above, the tighter limit applies at the band edges.
3. For Above 1000 MHz, the emission limit in this paragraph is based on measurement instrumentation employing an average detector, measurement using instrumentation with a peak detector function, corresponding to 20dB above the maximum permitted average limit.
4. For above 1000 MHz, limit field strength of harmonics: 54dB $\mu\text{V}/\text{m}$ @3m (AV) and 74dB $\mu\text{V}/\text{m}$ @3m (PK).

5.9.2 Test Setup

See section 4.4.3 to 4.4.5 for test setup description for the antenna port. The photo of test setup please refer to ANNEX B.

5.9.3 Test Procedure

The measurement frequency range is from 9 kHz to the 10th harmonic of the fundamental frequency. The Turn Table is actuated to turn from 0° to 360°, and both horizontal and vertical polarizations of the Test Antenna are used to find the maximum radiated power. Mid channels on all channel bandwidth verified. Only the worst RB size/offset presented.

The power of the EUT transmitting frequency should be ignored.

All Spurious Emission tests were performed in X, Y, Z axis direction. And only the worst axis test condition was recorded in this test report.

Use the following spectrum analyzer settings:

Span = wide enough to fully capture the emission being measured

RBW = 1 MHz for $f \geq 1$ GHz, 100 kHz for $f < 1$ GHz

VBW \geq RBW

Sweep = auto

Detector function = peak

Trace = max hold

For measurement below 1GHz, If the emission level of the EUT measured by the peak detector is 3 dB lower than the applicable limit, the peak emission level will be reported, Otherwise, the emission measurement will be repeated using the quasi-peak detector and reported.

5.9.4 Test Result

Please refer to ANNEX A.8.

5.10 Band Edge (Restricted-band band-edge)

5.10.1 Limit

FCC §15.209&15.247(d)

Radiated emission outside the frequency band attenuation below the general limits specified in FCC section 15.209(a) is not required. In addition, radiated emissions which fall in the restricted bands, as defined in FCC section 15.205(a), must also comply with the radiated emission limits specified in FCC section 15.209(a).

5.10.2 Test Setup

See section 4.4.3 to 4.4.5 for test setup description for the antenna port. The photo of test setup please refer to ANNEX B.

5.10.3 Test Procedure

The measurement frequency range is from 9 kHz to the 10th harmonic of the fundamental frequency. The Turn Table is actuated to turn from 0° to 360°, and both horizontal and vertical polarizations of the Test Antenna are used to find the maximum radiated power. Mid channels on all channel bandwidth verified. Only the worst RB size/offset presented.

The power of the EUT transmitting frequency should be ignored.

All Spurious Emission tests were performed in X, Y, Z axis direction. And only the worst axis test condition was recorded in this test report.

Use the following spectrum analyzer settings:

Span = wide enough to fully capture the emission being measured

RBW = 1 MHz for $f \geq 1$ GHz, 100 kHz for $f < 1$ GHz

VBW \geq RBW

Sweep = auto

Detector function = peak

Trace = max hold

For measurement below 1GHz, If the emission level of the EUT measured by the peak detector is 3 dB lower than the applicable limit, the peak emission level will be reported, Otherwise, the emission measurement will be repeated using the quasi-peak detector and reported.

5.10.4 Test Result

Please refer to ANNEX A.9.

ANNEX A TEST RESULT

A.1 Number of Hopping Frequency

Test Data

Test Mode	Frequency Block (MHz)	Measured Channel Numbers	Min. Limit	Verdict
GFSK	2400 - 2483.5	79	15	Pass
8-DPSK	2400 - 2483.5	79	15	Pass

Test plots

GFSK 2.4 GHz ~ 2.4415 GHz

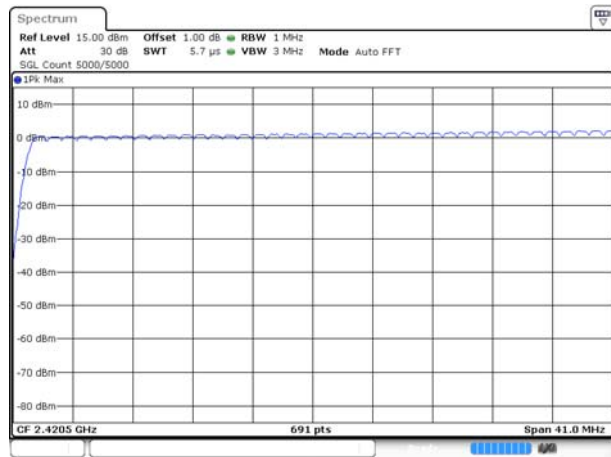

GFSK 2.4415 GHz ~ 2.4835 GHz

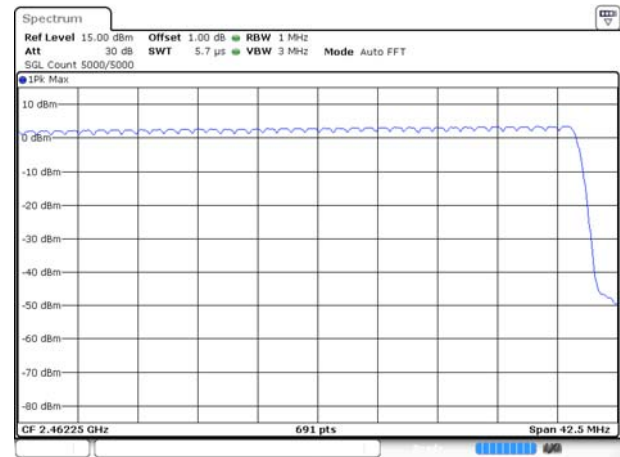

8-DPSK 2.4 GHz ~ 2.4415 GHz

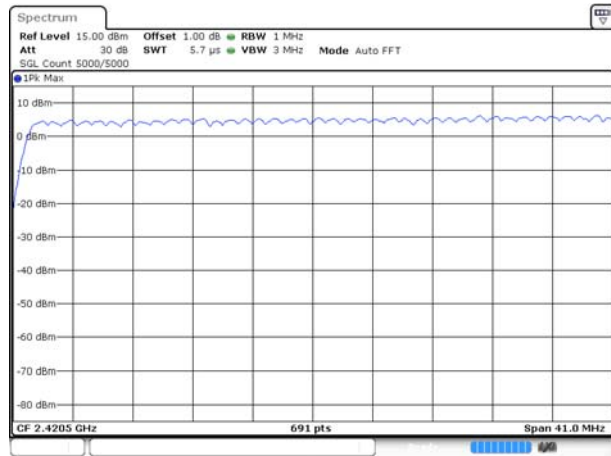

8-DPSK 2.4415 GHz ~ 2.4835 GHz

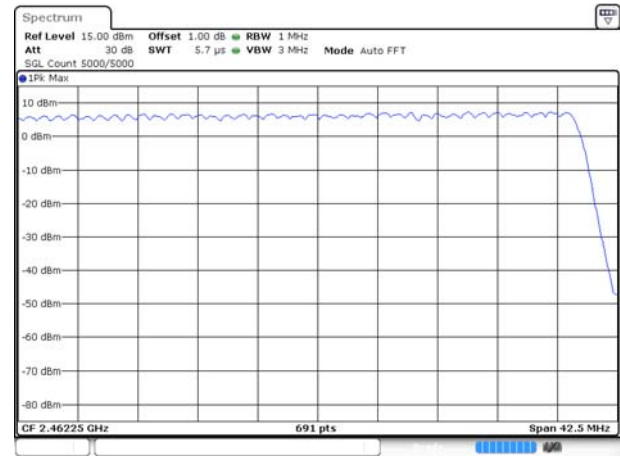

A.2 Peak Output Power and E.I.R.P

Peak Power Test Data

Channel	Measured Output Peak Power		Limit		Verdict
	GFSK		dBm	mW	
	dBm	mW			
Low	0.57	1.14	30	1000	Pass
Middle	2.26	1.68			Pass
High	3.96	2.49			Pass

Channel	Measured Output Peak Power				Limit		Verdict
	π/4-DQPSK		8-DPSK		dBm	mW	
	dBm	mW	dBm	mW			
Low	2.07	1.61	2.61	1.82	21	125	Pass
Middle	3.72	2.36	4.22	2.64			Pass
High	5.00	3.16	5.43	3.49			Pass

Test plots

GFSK LOW CHANNEL

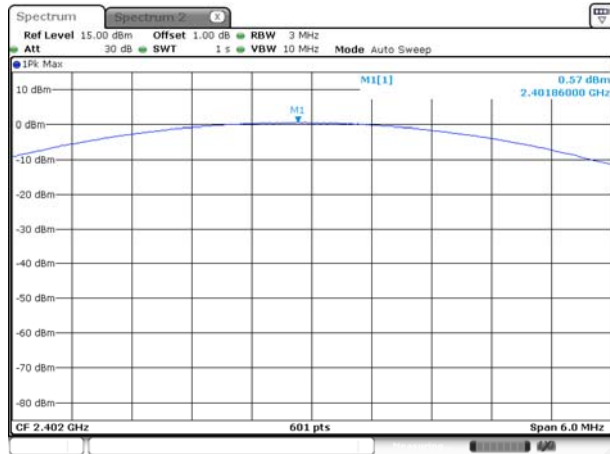

Date: 11 JUL 2017 16:19:03

GFSK MIDDLE CHANNEL

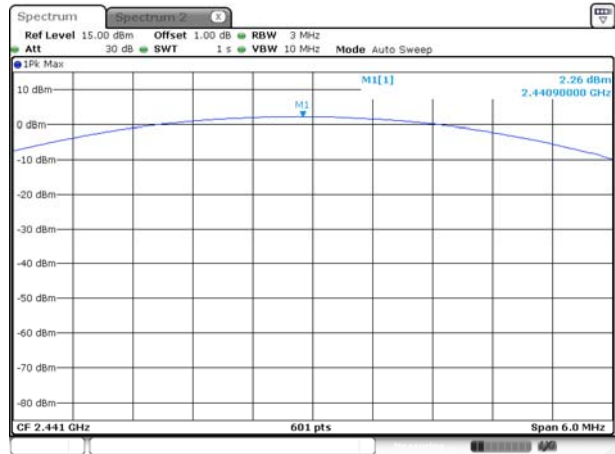

Date: 11 JUL 2017 16:22:41

GFSK HIGH CHANNEL

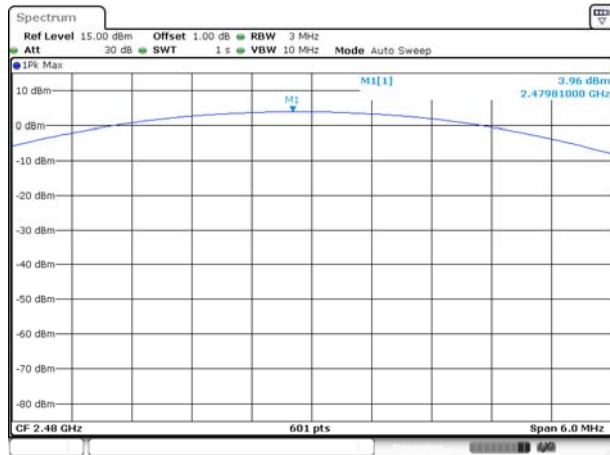

Date: 11 JUL 2017 16:36:19

II/4-DQPSK LOW CHANNEL

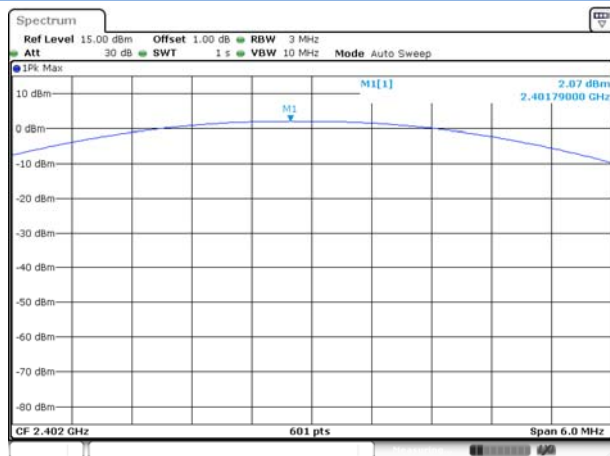

Date: 11 JUL 2017 16:41:32

II/4-DQPSK MIDDLE CHANNEL

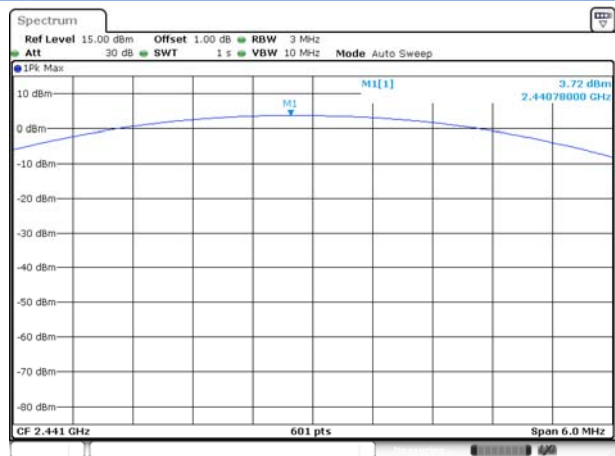

Date: 11 JUL 2017 16:42:00

Π/4-DQPSK HIGH CHANNEL

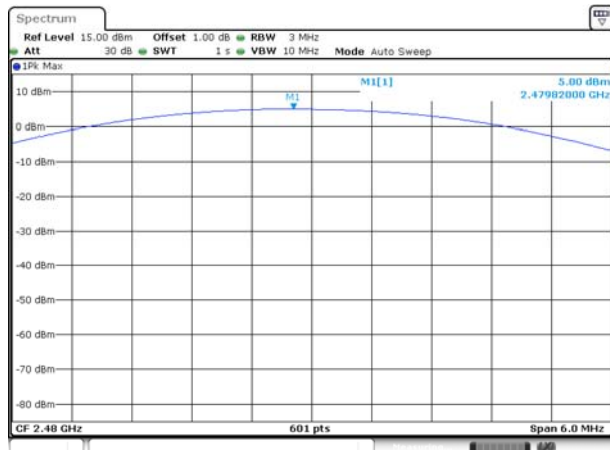

Date: 11 JUL 2017 16:42:36

8-DPSK LOW CHANNEL

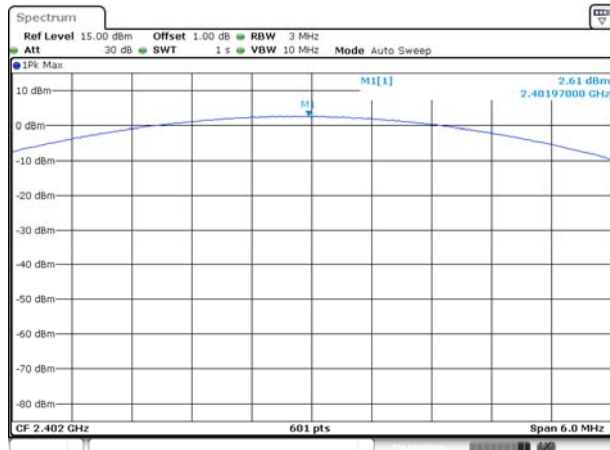

Date: 11 JUL 2017 16:43:50

8-DPSK MIDDLE CHANNEL

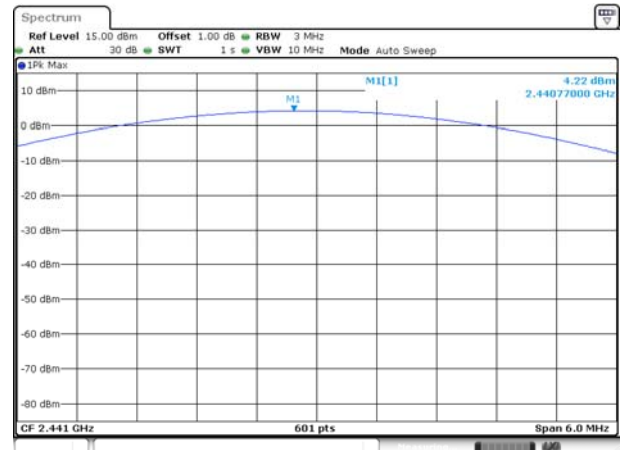

Date: 11 JUL 2017 16:47:44

8-DPSK HIGH CHANNEL

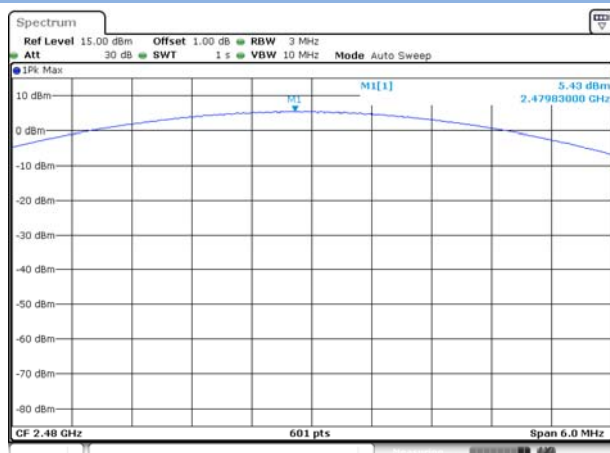

Date: 11 JUL 2017 16:51:57

A.3 20 dB and 99% bandwidth

Test Data

GFSK		
Channel	20 dB Bandwidth (MHz)	99% Bandwidth (MHz)
Low	0.995605	0.924747
Middle	1.000000	0.920405
High	0.93042	0.859624
8-DPSK		
Channel	20 dB Bandwidth (MHz)	99% Bandwidth (MHz)
Low	1.295654	1.180897
Middle	1.295654	1.176556
High	1.295654	1.180897

Test plots

20 dB Bandwidth

GFSK LOW CHANNEL

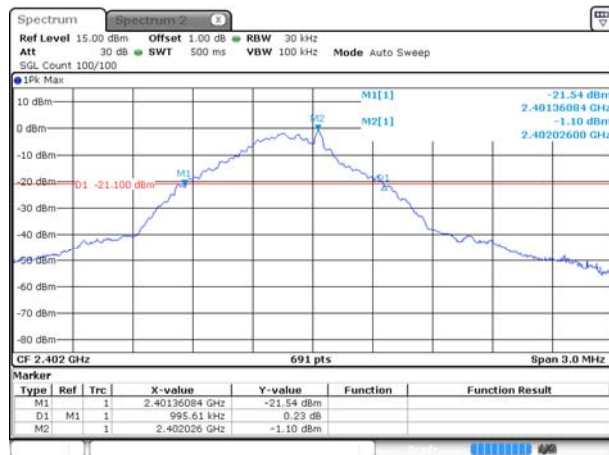

Date: 11 JUL 2017 16:20:00

GFSK MIDDLE CHANNEL

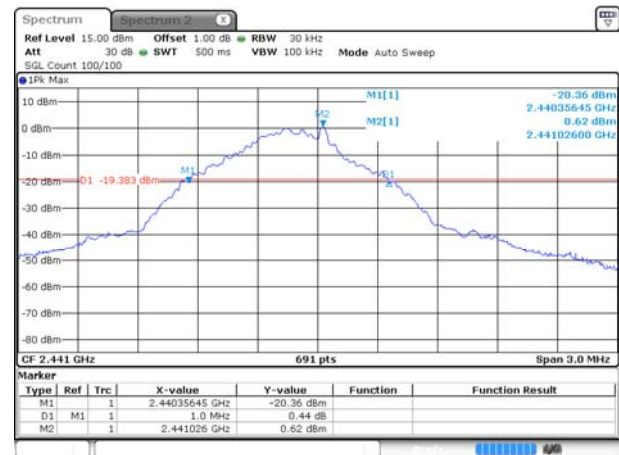

Date: 11 JUL 2017 16:23:38

GFSK HIGH CHANNEL



Date: 11 JUL 2017 16:37:15

8-DPSK LOW CHANNEL

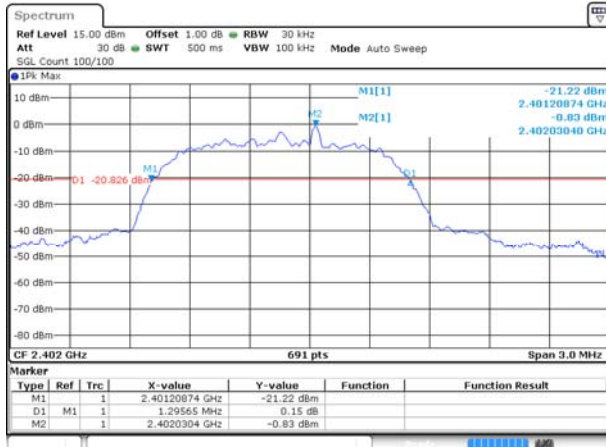

Date: 11 JUL 2017 16:44:46

8-DPSK MIDDLE CHANNEL

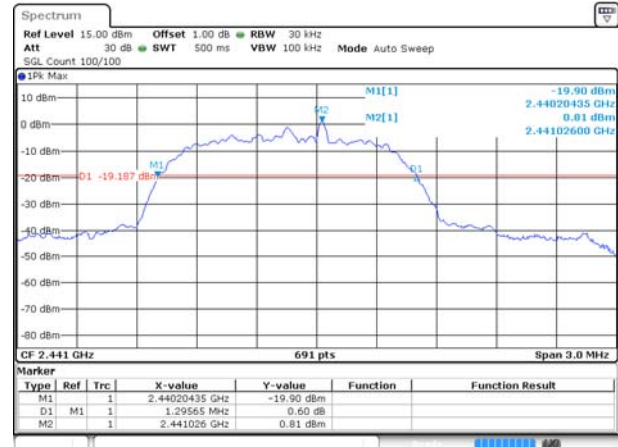

Date: 11 JUL 2017 16:48:40

8-DPSK HIGH CHANNEL

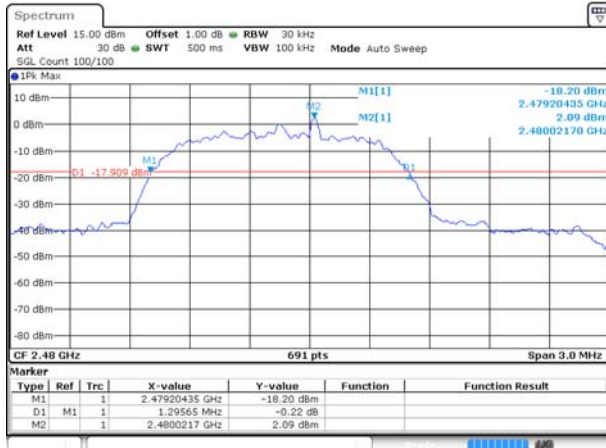

Date: 11 JUL 2017 16:52:53

99% Bandwidth

GFSK LOW CHANNEL



Date: 11 JUL 2017 16:20:56

GFSK MIDDLE CHANNEL

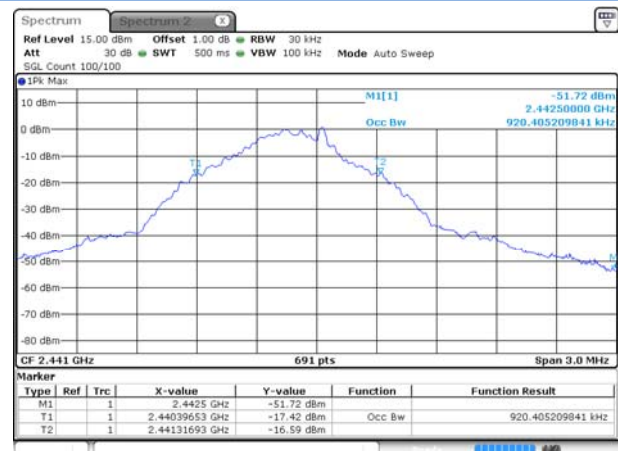

Date: 11 JUL 2017 16:24:34

GFSK HIGH CHANNEL

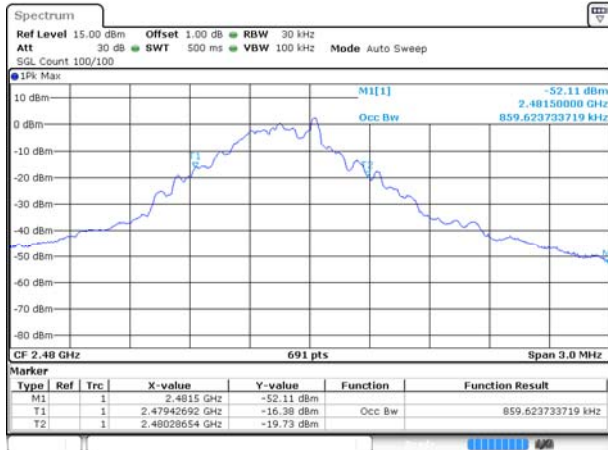

8-DPSK LOW CHANNEL

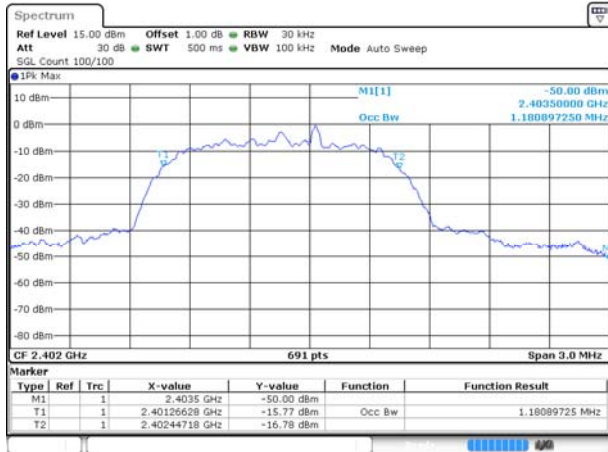

8-DPSK MIDDLE CHANNEL

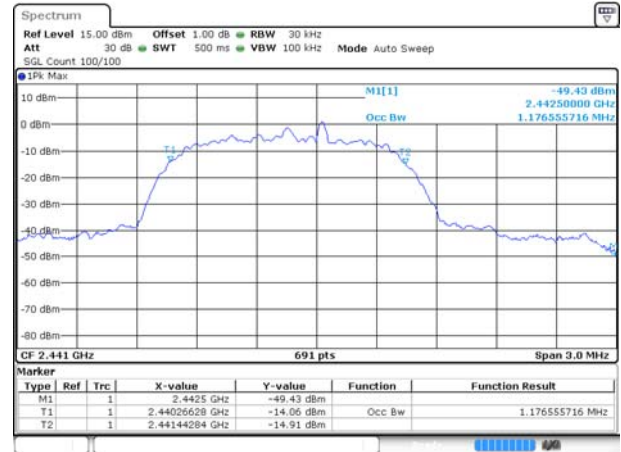

8-DPSK HIGH CHANNEL

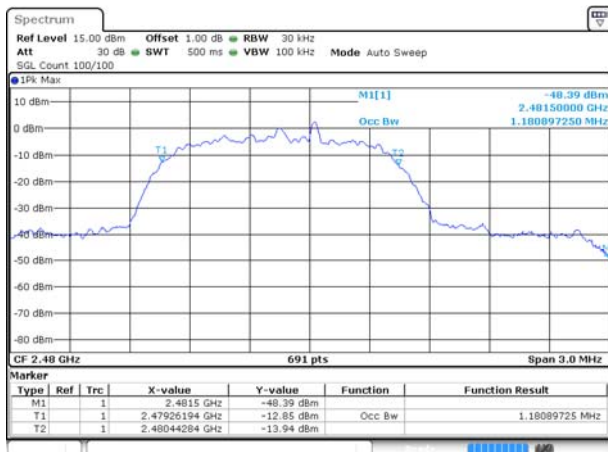

A.4 Hopping Frequency Separation

Test Data

Note: The systems operate with an output power no greater than 125 mw, The data provided in the section A.2.

Mode	Frequency separation (MHz)	Max 20 dB Bandwidth (MHz)	Two-thirds of the 20 dB bandwidth (MHz)	Verdict
GFSK	1.0033	1.000	0.667	Pass
8-DPSK	0.9933	1.296	0.864	Pass

Test Plots

GFSK

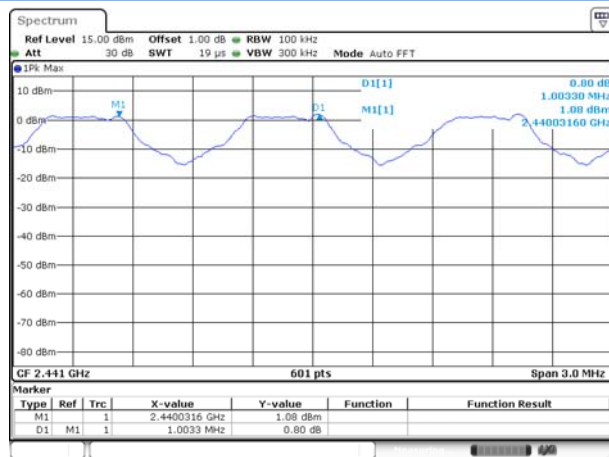

Date: 11 JUL 2017 16:57:08

8-DPSK

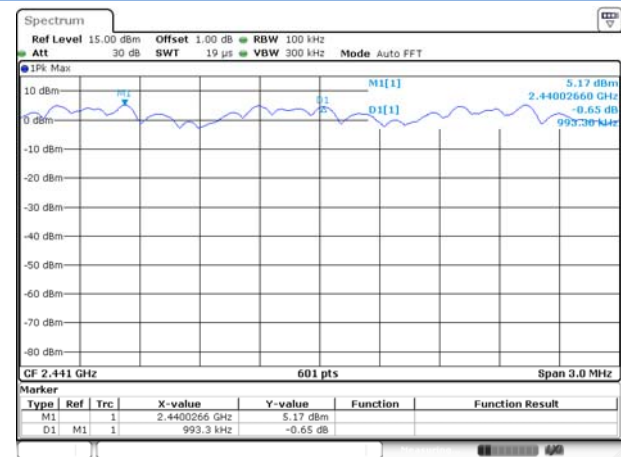

Date: 11 JUL 2017 17:02:45

A.5 Average Time of Occupancy

Test Data

GFSK				
DH Packet	Pulse Width (ms)	Total of Dwell (ms)	Limit (sec)	Verdict
DH 1	0.38083	121.869	0.4	Pass
DH 3	1.64617	263.395	0.4	Pass
DH 5	2.89120	308.404	0.4	Pass
8-DPSK				
DH Packet	Pulse Width (ms)	Total of Dwell (ms)	Limit (sec)	Verdict
DH 1	0.39667	126.938	0.4	Pass
DH 3	1.63303	261.293	0.4	Pass
DH 5	2.88000	307.210	0.4	Pass

Test Plots

GFSK DH1

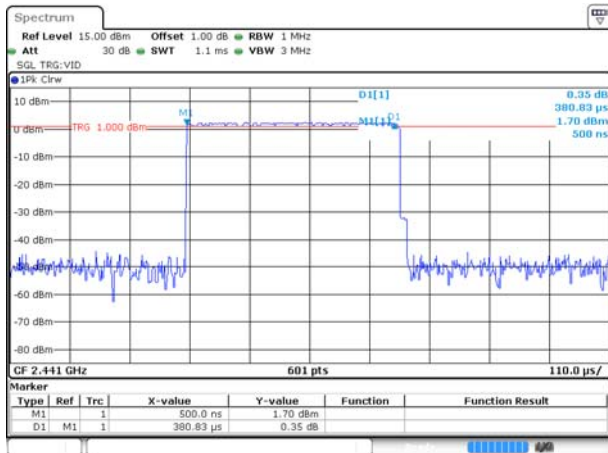

Date: 11 JUL 2017 17:05:56

GFSK DH3

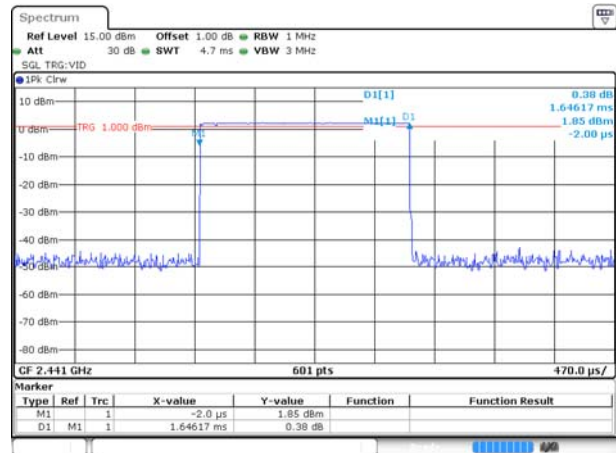

Date: 11 JUL 2017 17:06:29

GFSK DH5

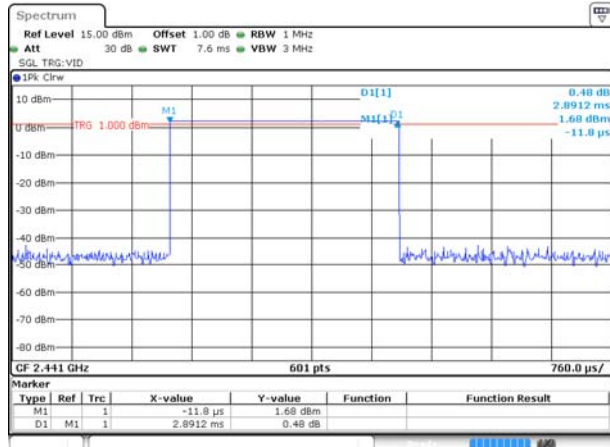

Date: 11 JUL 2017 17:07:00

8-DPSK DH1

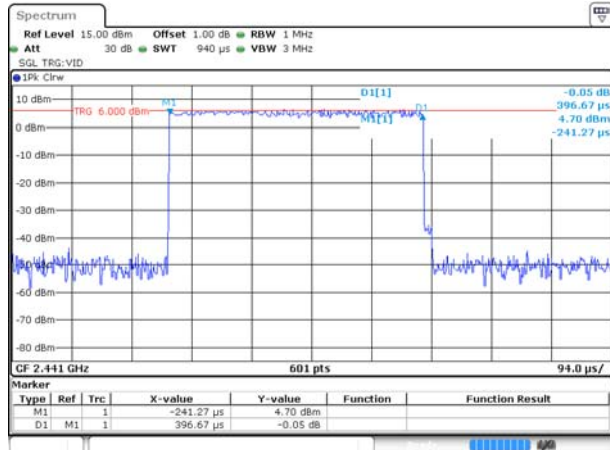

Date: 11 JUL 2017 17:07:58

8-DPSK DH3

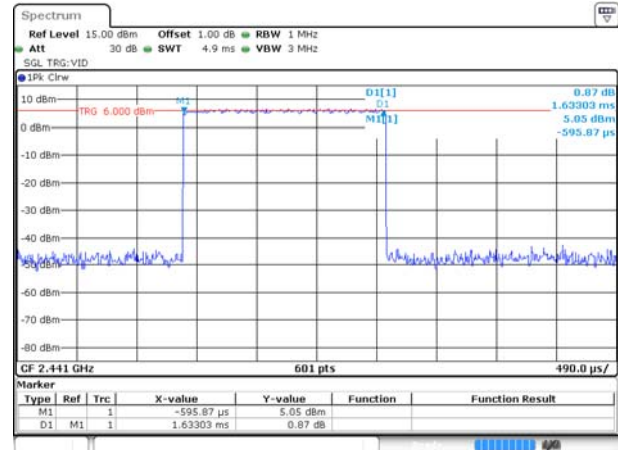

Date: 11 JUL 2017 17:08:30

8-DPSK DH5

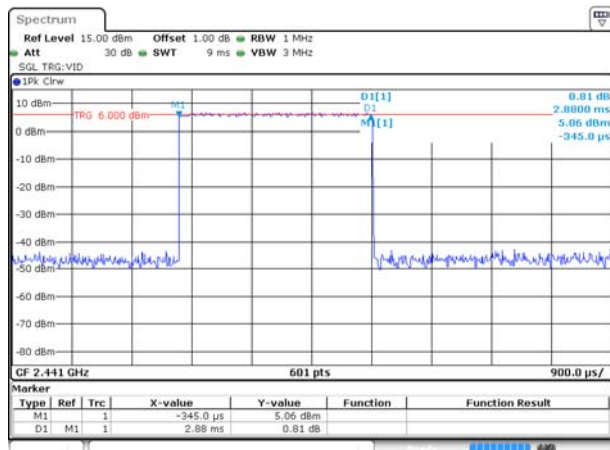

Date: 11 JUL 2017 17:09:04

A.6 Conducted Spurious Emissions & Authorized-band band-edge

Test Data

GFSK				
Channel	Measured Max. Out of Band Emission (dBm)	Limit (dBm)		Verdict
		Carrier Level	Calculated 20 dBc Limit	
Low	-43.84	-0.01	-20.01	Pass
Middle	-48.12	1.68	-18.32	Pass
High	-48.51	3.26	-16.74	Pass
8-DPSK				
Channel	Measured Max. Out of Band Emission (dBm)	Limit (dBm)		Verdict
		Carrier Level	Calculated 20 dBc Limit	
Low	-43.90	0.23	-19.77	Pass
Middle	-48.74	1.85	-18.15	Pass
High	-48.29	3.18	-16.82	Pass
Hopping Mode				
Mode	Measured Max. Out of Band Emission (dBm)	Limit (dBm)		Verdict
		Carrier Level	Calculated 20 dBc Limit	
GFSK	-48.08	2.19	-17.81	Pass
8-DPSK	-45.36	5.73	-14.27	Pass

Test Plots

GFSK LOW CHANNEL, CARRIER LEVEL

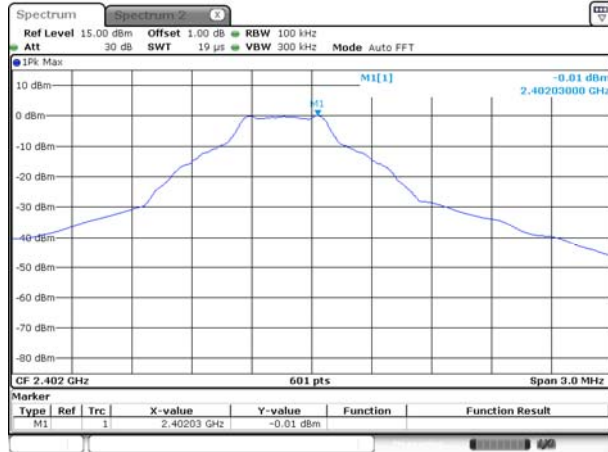

Date: 11 JUL 2017 16:21:08

GFSK LOW CHANNEL, BAND EDGE

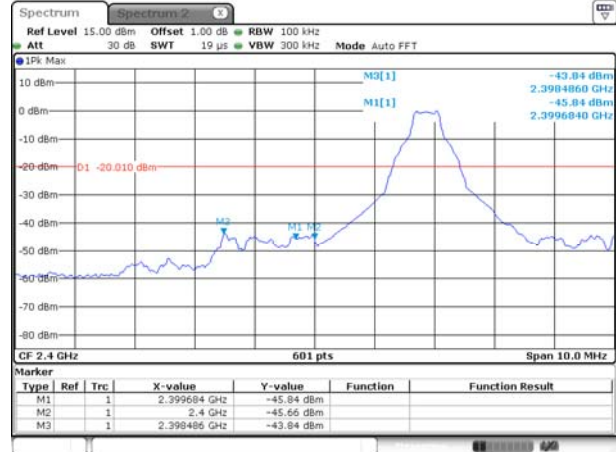

Date: 11 JUL 2017 16:22:07

GFSK LOW CHANNEL, SPURIOUS 30 MHz ~ 3 GHz

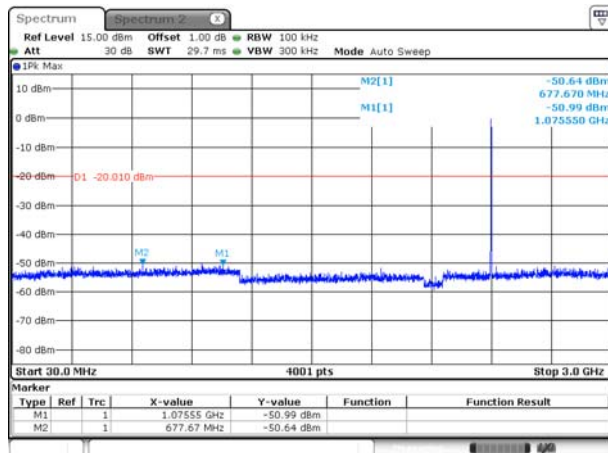

Date: 11 JUL 2017 16:21:31

GFSK LOW CHANNEL, SPURIOUS 3 GHz ~ 25 GHz

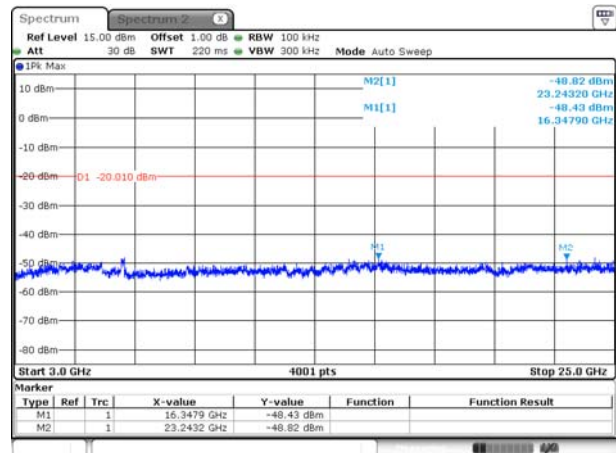

Date: 11 JUL 2017 16:21:44

GFSK MIDDLE CHANNEL, CARRIER LEVEL

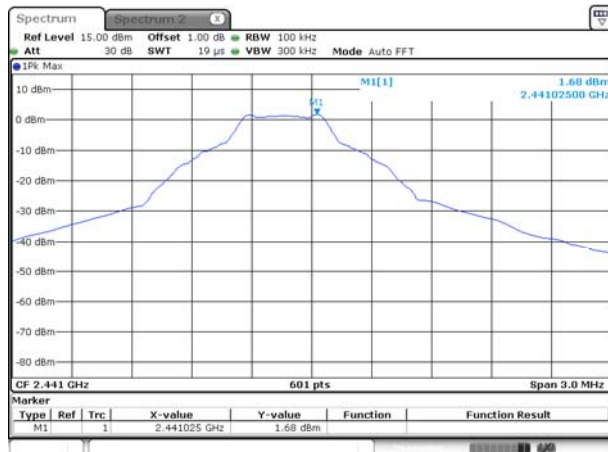

Date: 11 JUL 2017 16:24:45

GFSK MIDDLE CHANNEL , SPURIOUS 30 MHz ~ 3 GHz

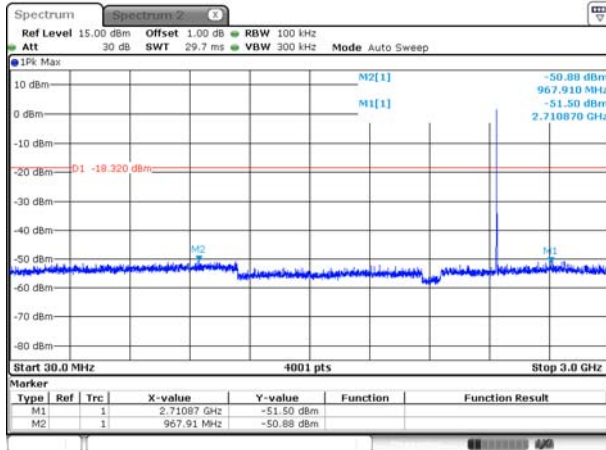

Date: 11.JUL.2017 16:25:13

GFSK MIDDLE CHANNEL , SPURIOUS 3 GHz ~ 25 GHz

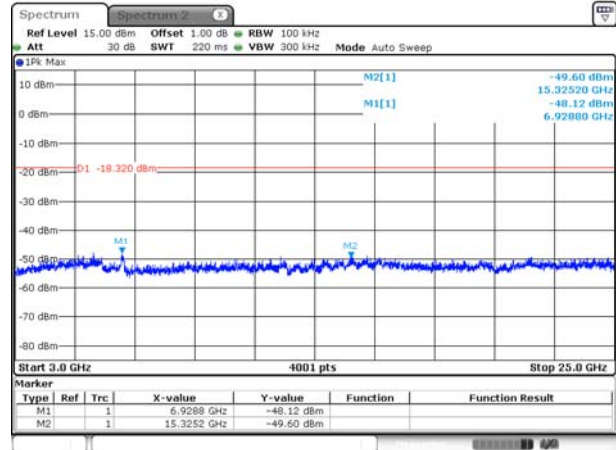

Date: 11.JUL.2017 16:25:25

GFSK HIGH CHANNEL, CARRIER LEVEL

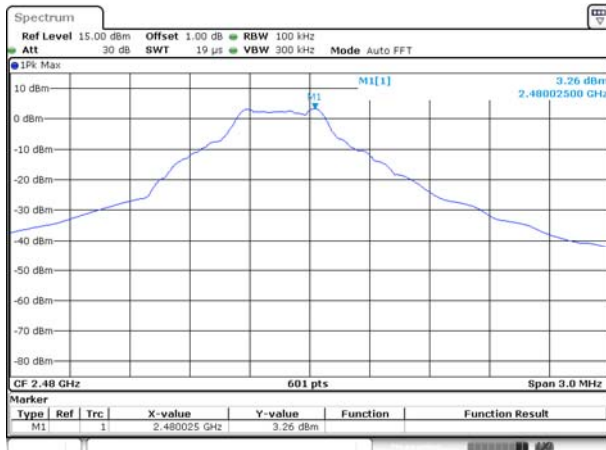

Date: 11.JUL.2017 16:38:24

GFSK HIGH CHANNEL , BAND EDGE

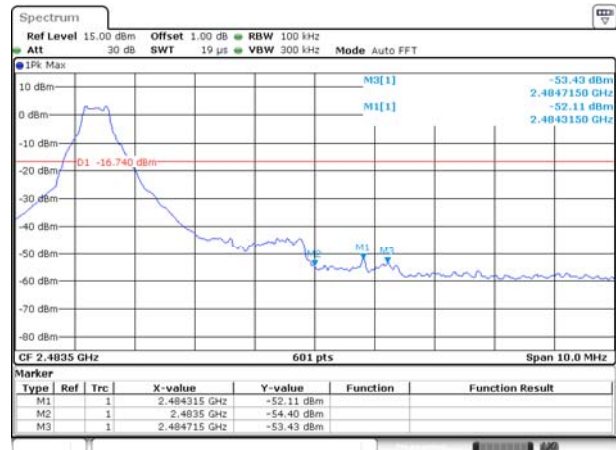

Date: 11.JUL.2017 16:39:33

GFSK HIGH CHANNEL , SPURIOUS 30 MHz ~ 3 GHz

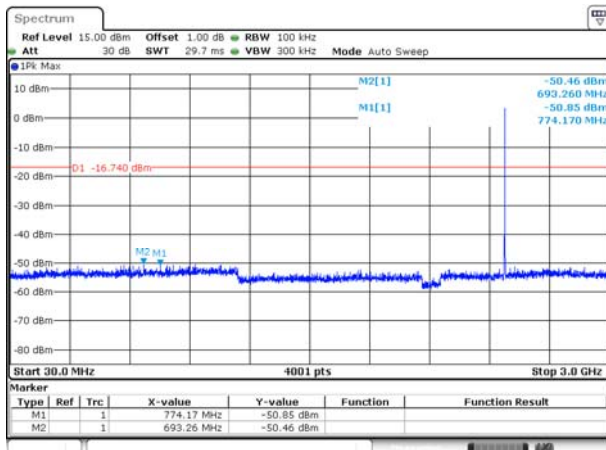

Date: 11.JUL.2017 16:38:50

GFSK HIGH CHANNEL , SPURIOUS 3 GHz ~ 25 GHz

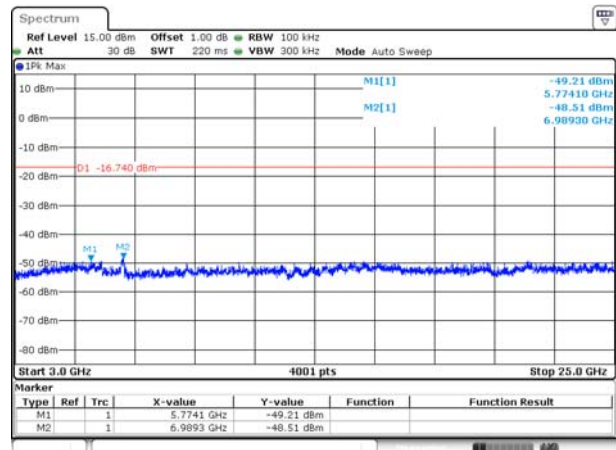

Date: 11.JUL.2017 16:39:03

8-DPSK LOW CHANNEL, CARRIER LEVEL

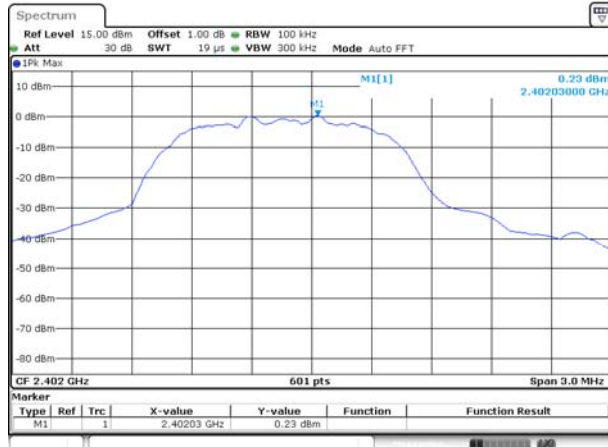

Date: 11 JUL 2017 16:45:56

8-DPSK LOW CHANNEL, BAND EDGE

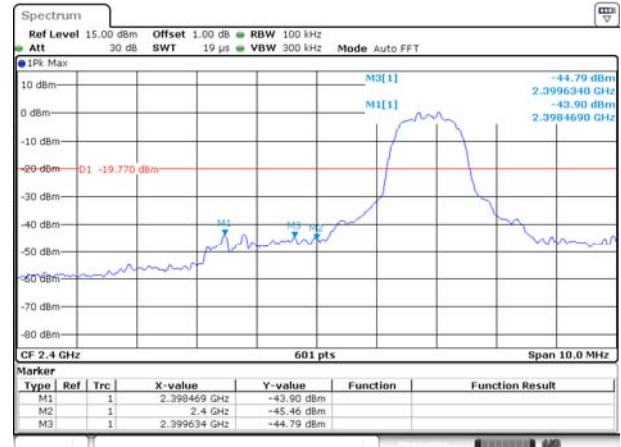

Date: 11 JUL 2017 16:47:09

8-DPSK LOW CHANNEL, SPURIOUS 30 MHz ~ 3 GHz

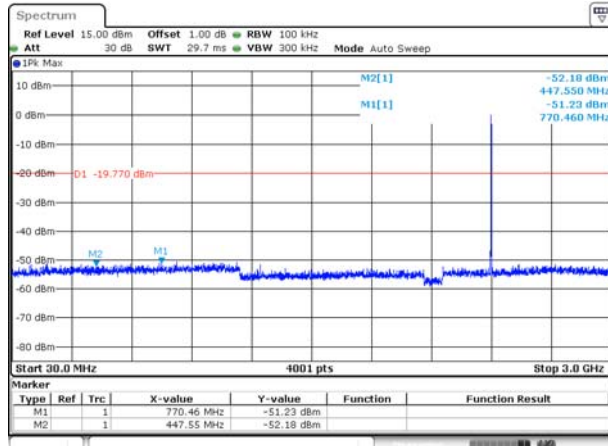

Date: 11 JUL 2017 16:46:22

8-DPSK LOW CHANNEL, SPURIOUS 3 GHz ~ 25 GHz

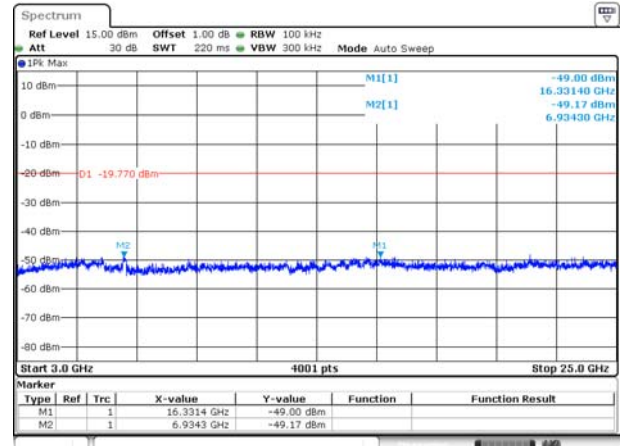

Date: 11 JUL 2017 16:46:37

8-DPSK MIDDLE CHANNEL, CARRIER LEVEL

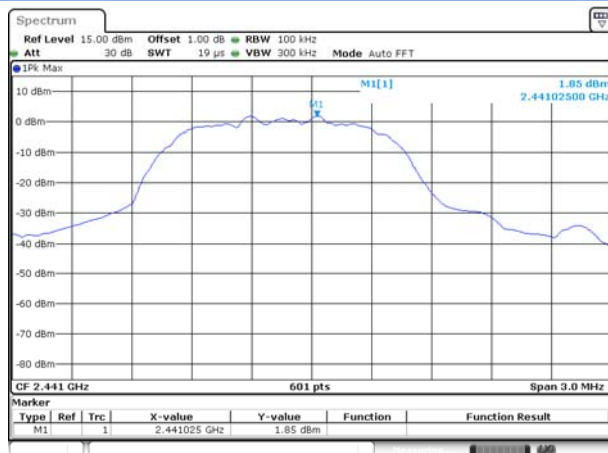

Date: 11 JUL 2017 16:49:50

8-DPSK MIDDLE CHANNEL, SPURIOUS 30 MHz ~ 3 GHz

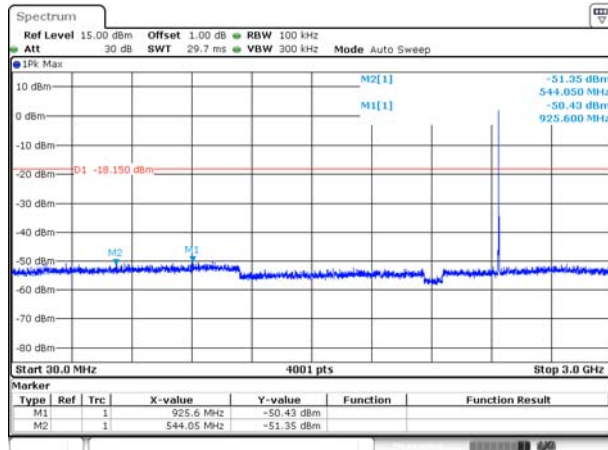

Date: 11 JUL 2017 16:50:38

8-DPSK MIDDLE CHANNEL, SPURIOUS 3 GHz ~ 25 GHz

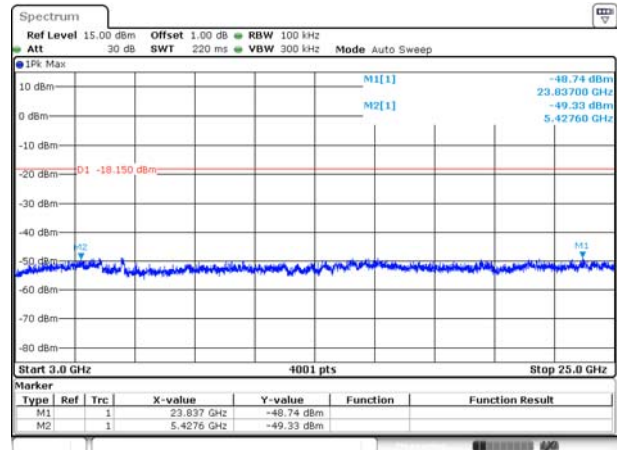

Date: 11 JUL 2017 16:50:50

8-DPSK HIGH CHANNEL, CARRIER LEVEL

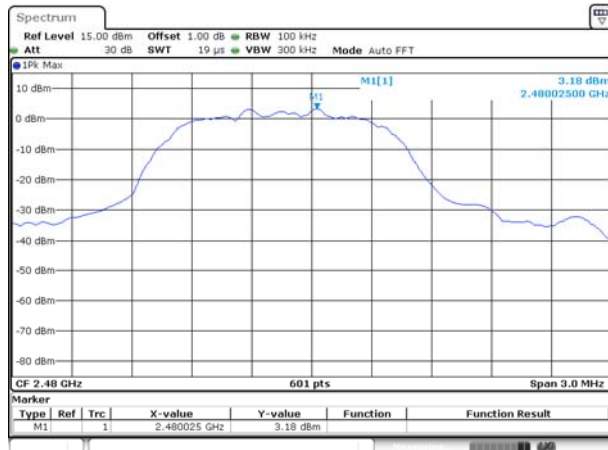

Date: 11 JUL 2017 16:54:01

8-DPSK HIGH CHANNEL, BAND EDGE

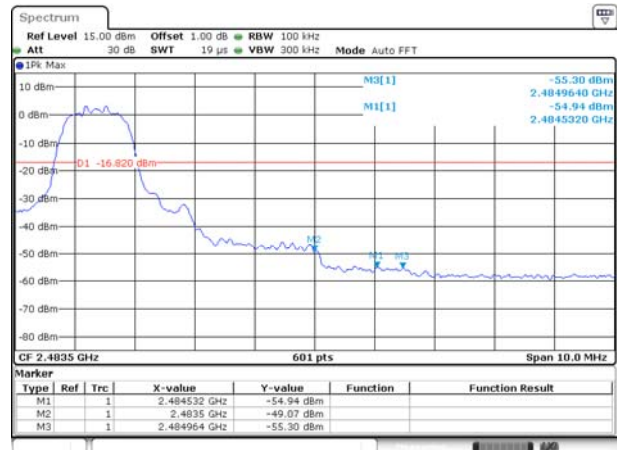

Date: 11 JUL 2017 16:55:08

8-DPSK HIGH CHANNEL, SPURIOUS 30 MHz ~ 3 GHz

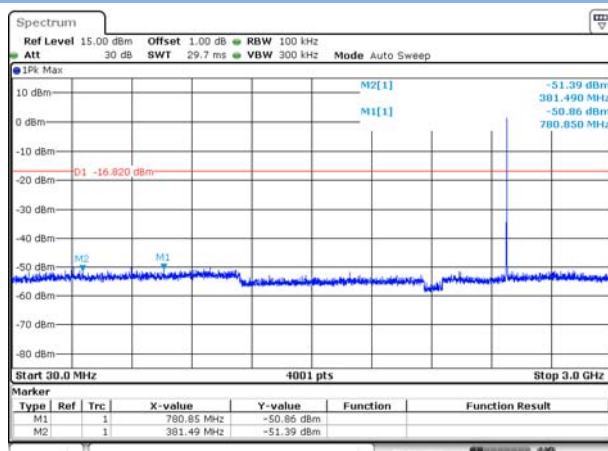

Date: 11 JUL 2017 16:54:29

8-DPSK HIGH CHANNEL, SPURIOUS 3 GHz ~ 25 GHz

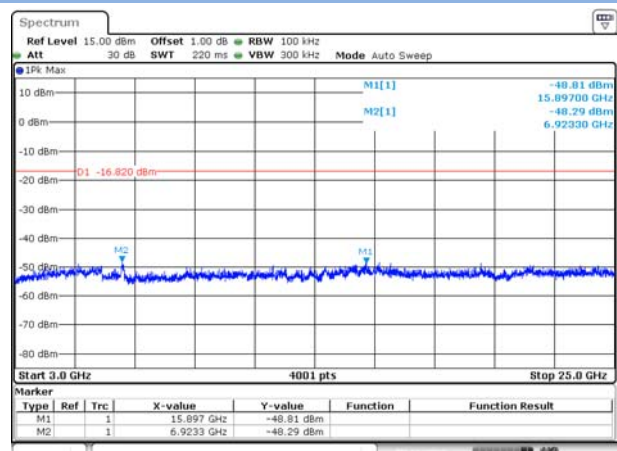

Date: 11 JUL 2017 16:54:42

GFSK HOPPING, CARRIER LEVEL

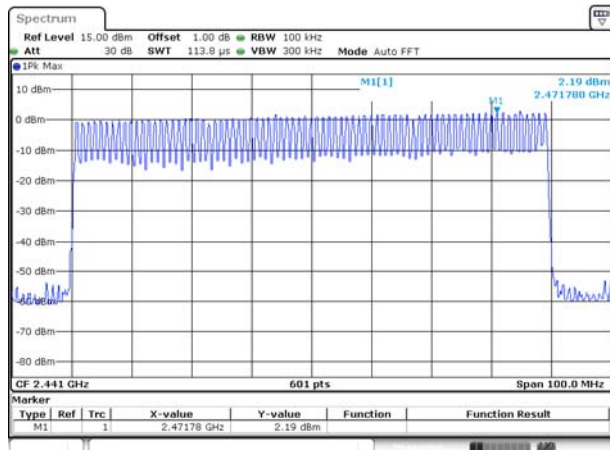

Date: 11 JUL 2017 16:57:30

GFSK HOPPING BAND EDGE (LOW)



Date: 11 JUL 2017 16:59:05

GFSK HOPPING BAND EDGE (HIGH)

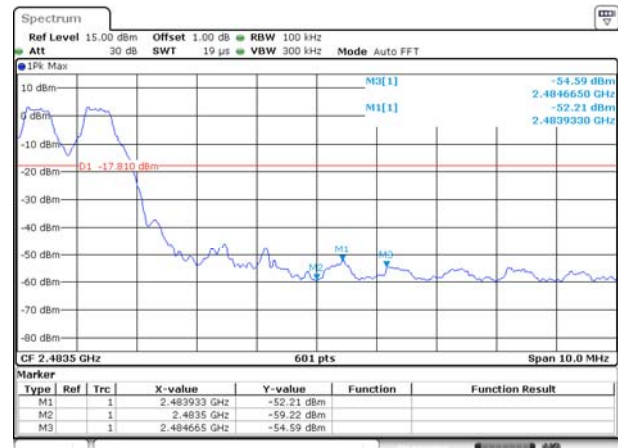

Date: 11 JUL 2017 16:59:29

GFSK Hopping Mode, SPURIOUS 30 MHz ~ 3 GHz

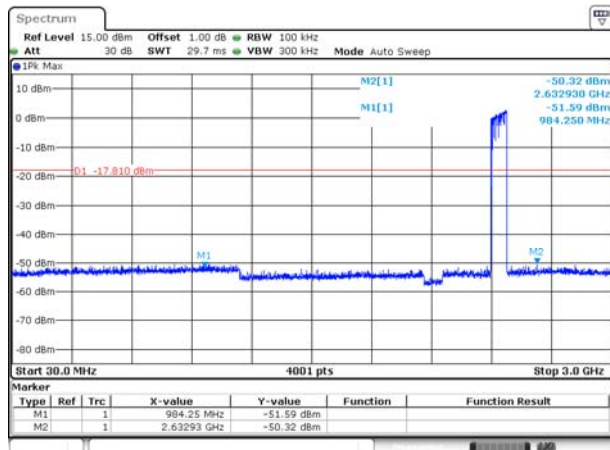

Date: 11 JUL 2017 16:58:22

GFSK Hopping Mode, SPURIOUS 30 3GHz ~ 25 GHz

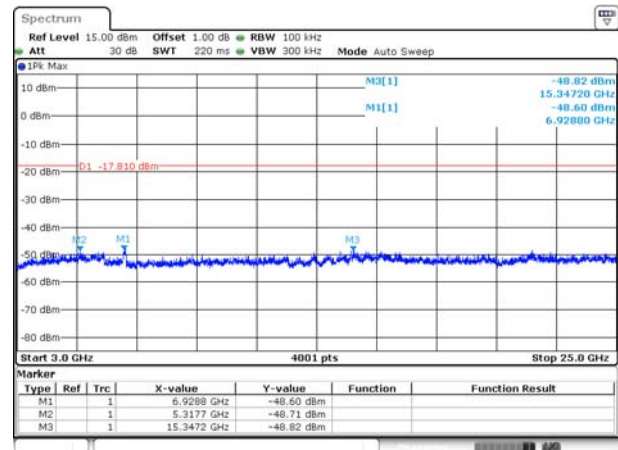

Date: 11 JUL 2017 16:58:39

8-DPSK HOPPING, CARRIER LEVEL

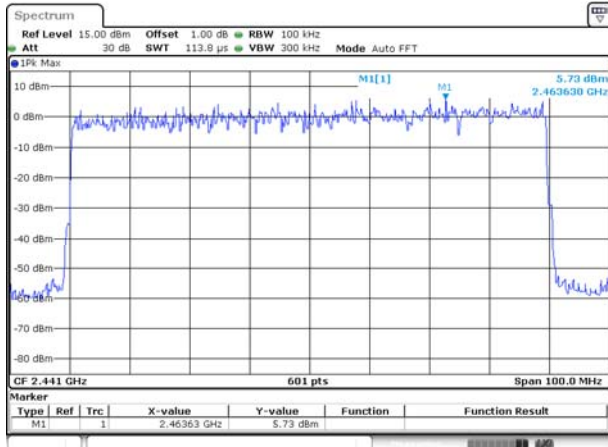

Date: 11 JUL 2017 17:03:00

8-DPSK Hopping BAND EDGE (LOW)



Date: 11 JUL 2017 17:04:20

8-DPSK Hopping BAND EDGE (HIGH)



Date: 11 JUL 2017 17:04:41

8-DPSK Hopping Mode, SPURIOUS 30 MHz ~ 3 GHz

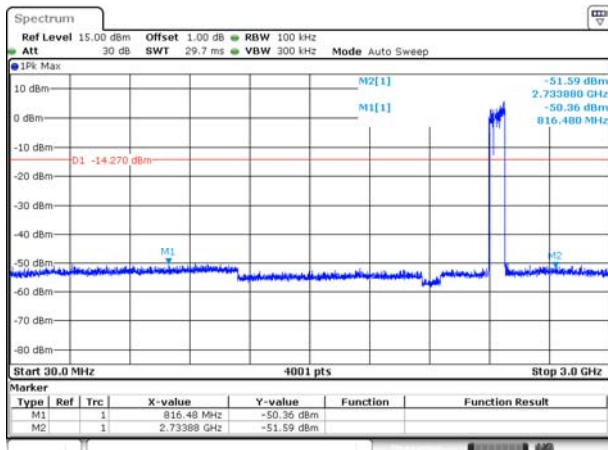

Date: 11 JUL 2017 17:03:44

8-DPSK Hopping Mode, SPURIOUS 30 GHz ~ 25 GHz

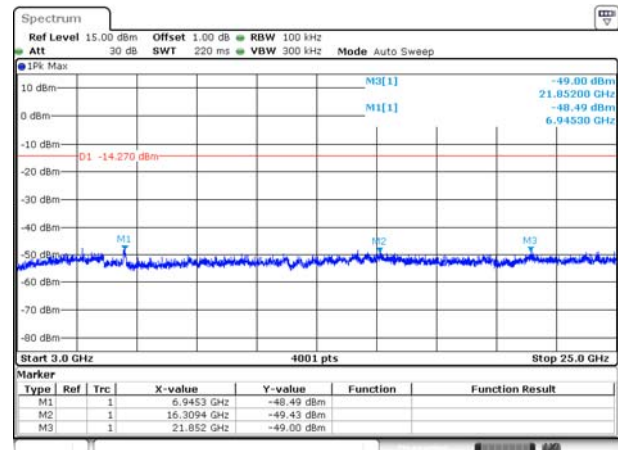

Date: 11 JUL 2017 17:03:57

A.7 Conducted Emissions

Note: The EUT is working in the Normal link mode.

Test Data and Plots

PHASE L

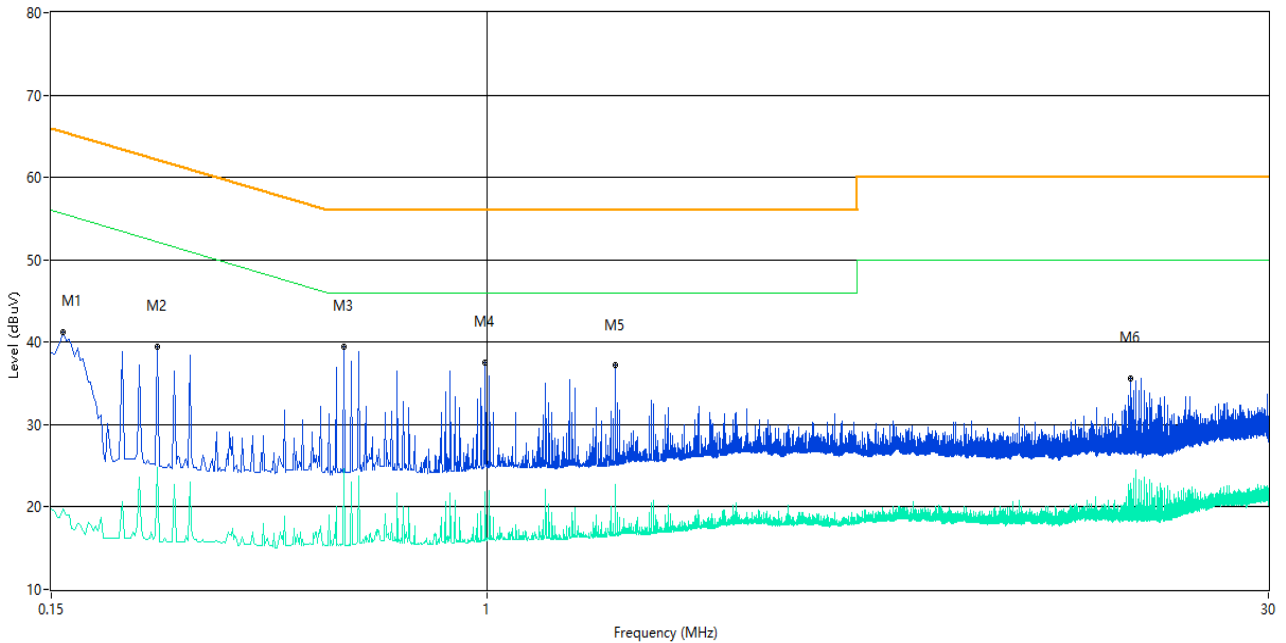

No.	Frequency (MHz)	Results (dBuV)	Factor (dB)	Limit (dBuV)	Margin (dB)	Detector	Line	Verdict
1	0.158	41.2	10.41	65.6	24.40	Peak	L Line	Pass
1**	0.158	19.7	10.41	55.6	35.90	AV	L Line	Pass
2	0.238	39.5	10.00	62.2	22.70	Peak	L Line	Pass
2**	0.238	24.9	10.00	52.2	27.30	AV	L Line	Pass
3	0.536	39.4	9.34	56.0	16.60	Peak	L Line	Pass
3**	0.536	24.7	9.34	46.0	21.30	AV	L Line	Pass
4	0.992	37.6	9.67	56.0	18.40	Peak	L Line	Pass
4**	0.992	21.9	9.67	46.0	24.10	AV	L Line	Pass
5	1.746	37.3	10.07	56.0	18.70	Peak	L Line	Pass
5**	1.746	22.7	10.07	46.0	23.30	AV	L Line	Pass
6	16.476	35.5	11.36	60.0	24.50	Peak	L Line	Pass
6**	16.476	22.9	11.36	50.0	27.10	AV	L Line	Pass

PHASE N

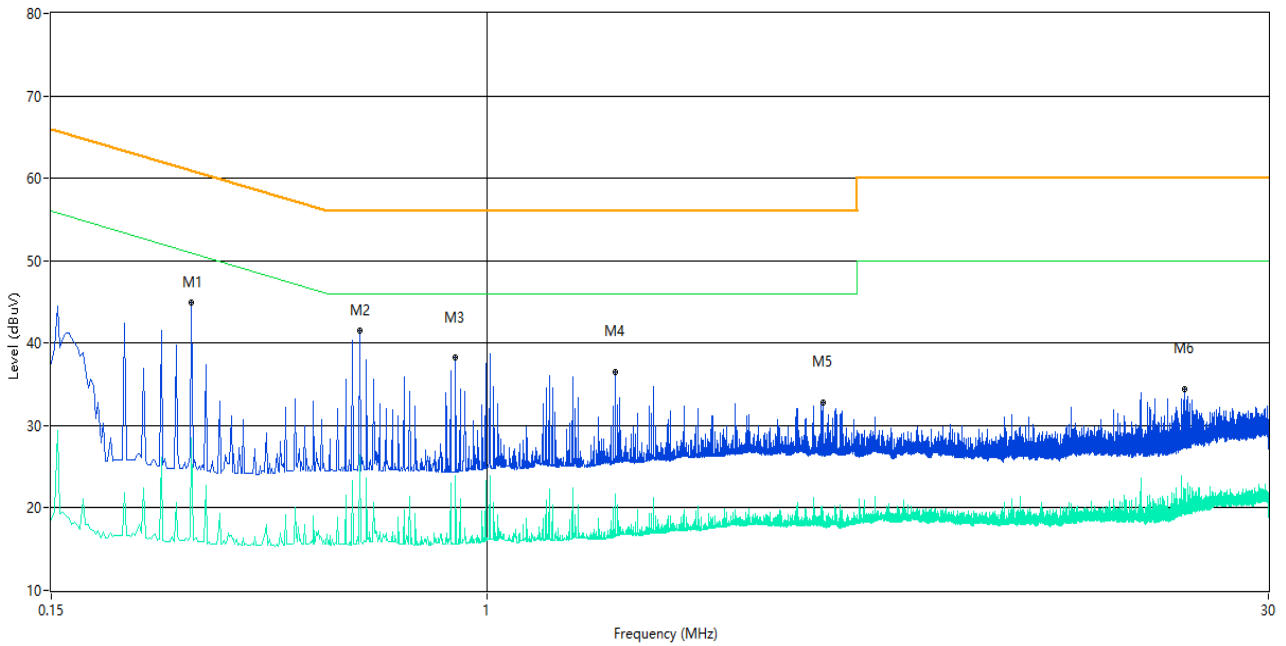

No.	Frequency (MHz)	Results (dBuV)	Factor (dB)	Limit (dBuV)	Margin (dB)	Detector	Line	Verdict
1	0.276	44.9	10.67	60.9	16.00	Peak	N Line	Pass
1**	0.276	28.6	10.67	50.9	22.30	AV	N Line	Pass
2	0.574	41.5	10.39	56.0	14.50	Peak	N Line	Pass
2**	0.574	26.4	10.39	46.0	19.60	AV	N Line	Pass
3	0.872	38.2	9.78	56.0	17.80	Peak	N Line	Pass
3**	0.872	23.8	9.78	46.0	22.20	AV	N Line	Pass
4	1.748	36.4	10.01	56.0	19.60	Peak	N Line	Pass
4**	1.748	21.6	10.01	46.0	24.40	AV	N Line	Pass
5	4.322	32.8	9.96	56.0	23.20	Peak	N Line	Pass
5**	4.322	19.6	9.96	46.0	26.40	AV	N Line	Pass
6	20.802	34.4	10.89	60.0	25.60	Peak	N Line	Pass
6**	20.802	22.3	10.89	50.0	27.70	AV	N Line	Pass

A.8 Radiated Spurious Emission

Duty cycle correction factor for average measurement.

Note:

1. Duty cycle = on time/100 milliseconds = $3 * 2.891 / 100 = 8.67\%$
2. Duty cycle correction factor = $20 * \log(\text{Duty cycle}) = -21.24 \text{ dB}$
3. DH5 has the highest duty cycle and is reported.

DH5 on time/100 ms (One Pulse) Plot on Channel 39

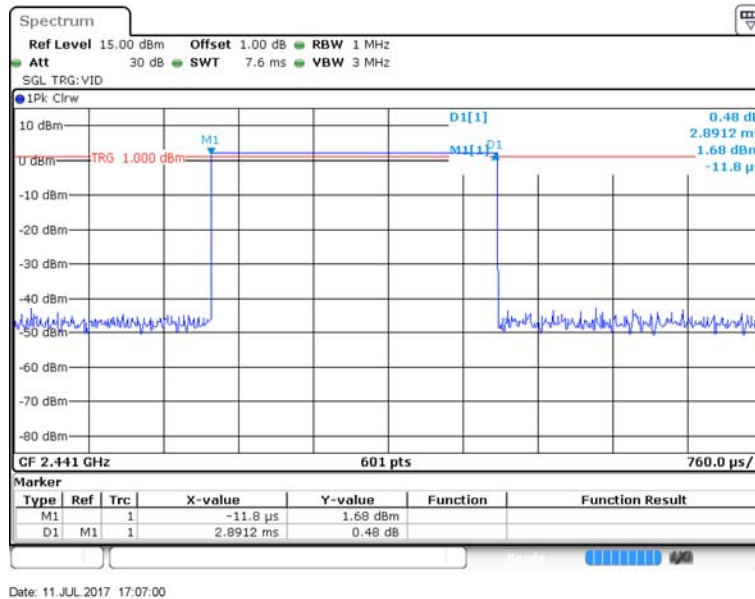

DH5 on time/100 ms (Count Pulses) Plot on Channel 39

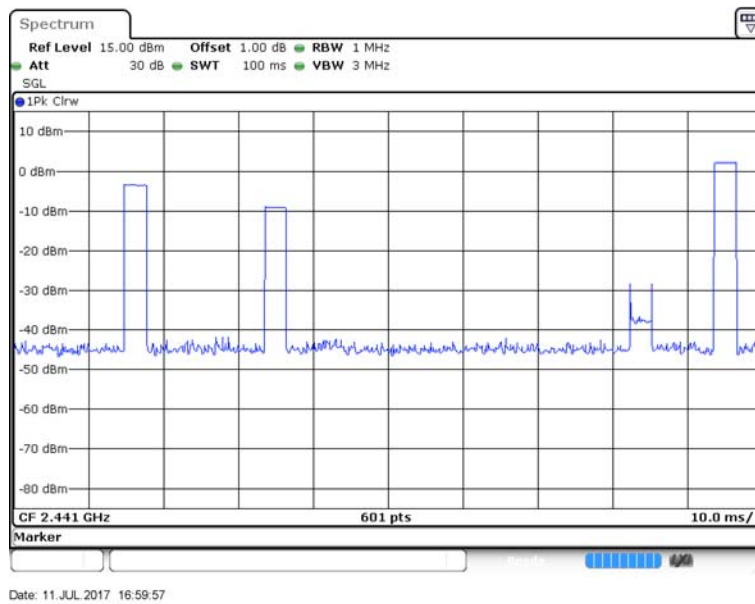

Test Data and Plots

Note 1: The symbol of "--" in the table which means not application.

Note 2: For the test data above 1 GHz, according to the ANSI C63.10-2013, where limits are specified for both average and peak (or quasi-peak) detector functions, if the peak (or quasi-peak) measured value complies with the average limit, it is unnecessary to perform an average measurement.

Note 3: The EUT is working in the Normal link mode below 1 GHz.

The low frequency, which started from 9 kHz to 30 MHz, was pre-scanned and the result which was 20 dB lower than the limit line per 15.31(o) was not reported.

30 MHz to 1 GHz, ANT V

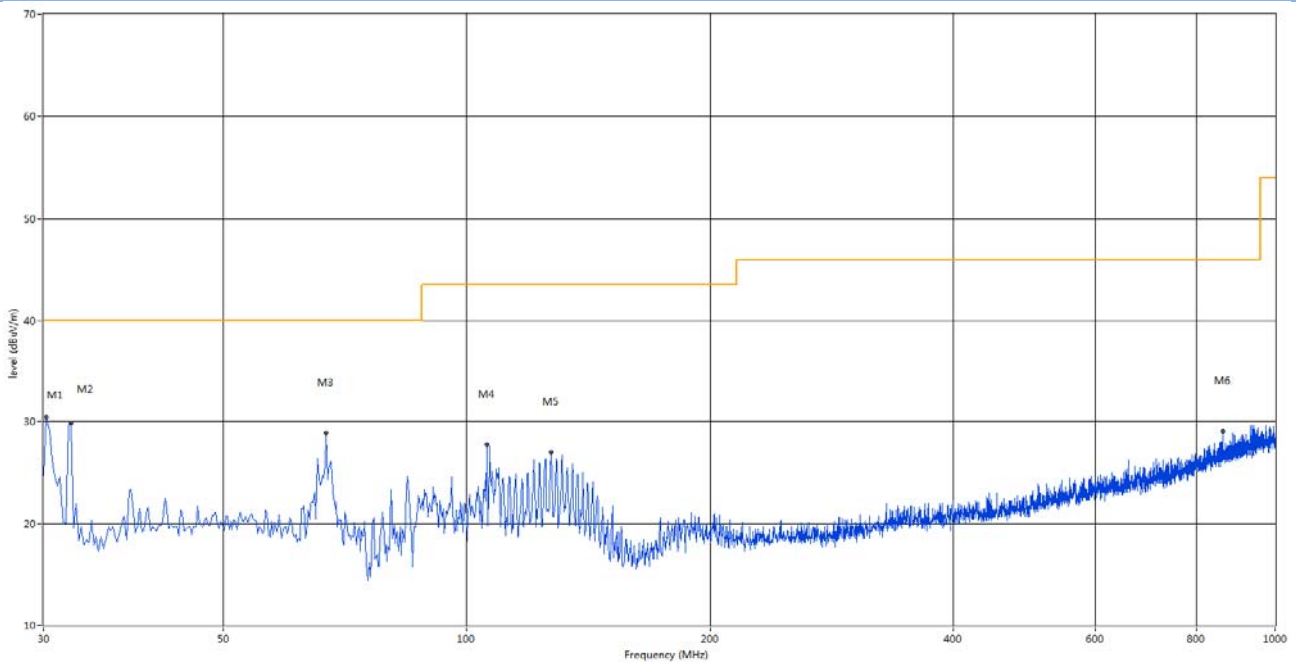

No.	Frequency (MHz)	Results (dBuV/m)	Factor (dB)	Limit (dBuV/m)	Margin (dB)	Detector	Table (o)	Height (cm)	ANT	Verdict
1	30.242	20.46	-22.38	30.0	9.54	Peak	360.00	200	Vertical	Pass
2	32.425	19.89	-22.46	30.0	10.11	Peak	360.00	100	Vertical	Pass
3	67.103	18.90	-22.09	30.0	11.10	Peak	355.80	100	Vertical	Pass
4	105.902	17.71	-20.90	33.5	15.79	Peak	322.70	100	Vertical	Pass
5	127.243	17.00	-23.71	33.5	16.50	Peak	71.80	100	Vertical	Pass
6	861.047	19.04	-7.30	36.0	16.96	Peak	294.00	300	Vertical	Pass

30 MHz to 1 GHz, ANT H

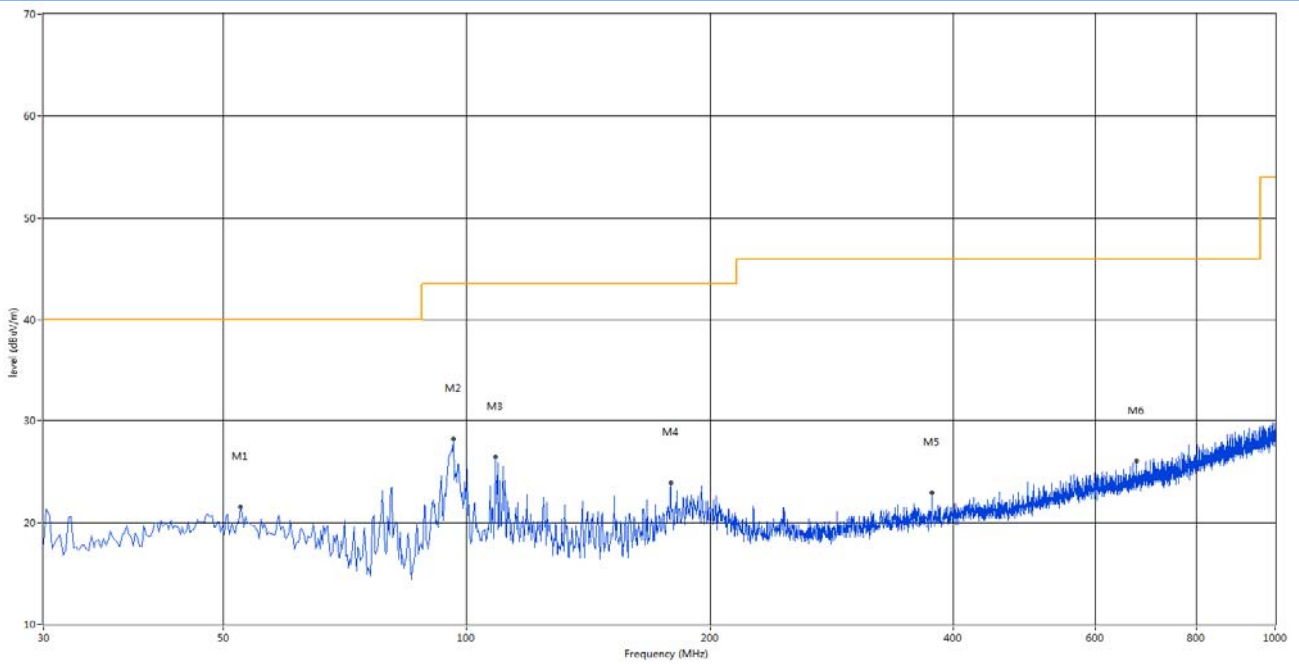

No.	Frequency (MHz)	Results (dBuV/m)	Factor (dB)	Limit (dBuV/m)	Margin (dB)	Detector	Table (o)	Height (cm)	ANT	Verdict
1	52.553	11.52	-19.29	30.0	18.48	Peak	360.50	200	Horizontal	Pass
2	96.445	18.20	-21.40	33.5	15.30	Peak	360.00	200	Horizontal	Pass
3	108.570	16.41	-20.96	33.5	17.09	Peak	29.20	200	Horizontal	Pass
4	178.895	13.86	-23.00	33.5	19.64	Peak	30.40	100	Horizontal	Pass
5	376.290	12.94	-16.79	36.0	23.06	Peak	326.00	100	Horizontal	Pass
6	674.322	16.00	-10.72	36.0	20.00	Peak	197.60	100	Horizontal	Pass

Test Data and Plots (1 GHz ~ 10th Harmonic)

Note: The marked spikes near 2400 MHz with circle should be ignored because they are Fundamental signal.

1 GHz to 25 GHz, ANT V GFSK Low Channel										
No.	Frequency (MHz)	Results (dBuV/m)	Factor (dB)	Limit (dBuV/m)	Margin (dB)	Detector	Table (o)	Height (cm)	ANT	Verdict
1	1994.16	51.14	-3.90	74	22.86	Peak	298.2	150	Vertical	Pass
2	2402.07	85.92	-2.21	74	-11.92	Peak	152.6	150	Vertical	N/A
3	5679.83	52.83	12.43	74	21.17	Peak	320.7	150	Vertical	Pass
4	9796.17	47.36	15.41	74	26.64	Peak	156.8	150	Vertical	Pass
5	16940.93	45.07	9.05	74	28.93	Peak	163	150	Vertical	Pass
6	20996.67	46.45	13.64	74	27.55	Peak	286.6	150	Vertical	Pass

1 GHz to 25 GHz, ANT H GFSK Low Channel										
No.	Frequency (MHz)	Results (dBuV/m)	Factor (dB)	Limit (dBuV/m)	Margin (dB)	Detector	Table (o)	Height (cm)	ANT	Verdict
1	1994.48	47.93	-3.88	74	26.07	Peak	141	150	Horizontal	Pass
2	2402.53	89.48	-2.21	74	-15.48	Peak	239.5	150	Horizontal	N/A
3	5064.74	52.67	13.15	74	21.33	Peak	69.2	150	Horizontal	Pass
4	6595.26	46.40	20.03	74	27.60	Peak	106.3	150	Horizontal	Pass
5	13405.16	47.70	20.65	74	26.30	Peak	309.6	150	Horizontal	Pass
6	18594.43	43.80	11.35	74	30.20	Peak	295.8	150	Horizontal	Pass

1 GHz to 25 GHz, ANT V GFSK Middle Channel										
No.	Frequency (MHz)	Results (dBuV/m)	Factor (dB)	Limit (dBuV/m)	Margin (dB)	Detector	Table (o)	Height (cm)	ANT	Verdict
1	1996.04	52.09	-3.90	74	21.91	Peak	143.7	150	Vertical	Pass
2	2440.17	85.49	-2.18	74	-11.49	Peak	26.8	150	Vertical	N/A
3	5682.44	51.87	12.40	74	22.13	Peak	127.4	150	Vertical	Pass
4	8976.29	42.44	14.31	74	31.56	Peak	280.4	150	Vertical	Pass
5	13706.74	47.44	12.58	74	26.56	Peak	54.5	150	Vertical	Pass
6	21136.44	46.69	10.96	74	27.31	Peak	221.6	150	Vertical	Pass

1 GHz to 25 GHz, ANT H GFSK Middle Channel

No.	Frequency (MHz)	Results (dBuV/m)	Factor (dB)	Limit (dBuV/m)	Margin (dB)	Detector	Table (o)	Height (cm)	ANT	Verdict
1	1995.40	47.04	-3.88	74	26.96	Peak	269.9	150	Horizontal	Pass
2	2440.43	88.44	-2.18	74	-14.44	Peak	198.4	150	Horizontal	N/A
3	5066.03	52.90	13.10	74	21.10	Peak	77.2	150	Horizontal	Pass
4	8796.59	46.41	20.49	74	27.59	Peak	107	150	Horizontal	Pass
5	13259.57	43.53	9.62	74	30.47	Peak	42.2	150	Horizontal	Pass
6	20627.29	48.03	12.37	74	25.98	Peak	196.5	150	Horizontal	Pass

1 GHz to 25 GHz, ANT V GFSK High Channel

No.	Frequency (MHz)	Results (dBuV/m)	Factor (dB)	Limit (dBuV/m)	Margin (dB)	Detector	Table (o)	Height (cm)	ANT	Verdict
1	1995.24	52.20	-3.88	74	21.80	Peak	270.9	150	Vertical	Pass
2	2480.41	86.15	-2.20	74	-12.15	Peak	185.5	150	Vertical	N/A
3	5680.36	52.91	12.41	74	21.09	Peak	109.3	150	Vertical	Pass
4	8044.09	51.84	14.29	74	22.16	Peak	239.9	150	Vertical	Pass
5	15485.03	46.66	11.73	74	27.34	Peak	94.6	150	Vertical	Pass
6	19469.22	44.43	11.20	74	29.58	Peak	337.3	150	Vertical	Pass

1 GHz to 25 GHz, ANT H GFSK High Channel

No.	Frequency (MHz)	Results (dBuV/m)	Factor (dB)	Limit (dBuV/m)	Margin (dB)	Detector	Table (o)	Height (cm)	ANT	Verdict
1	1994.92	46.88	-3.88	74	27.12	Peak	324.6	150	Horizontal	Pass
2	2480.67	89.32	-2.21	74	-15.32	Peak	157.4	150	Horizontal	N/A
3	5067.28	52.76	13.09	74	21.24	Peak	74.5	150	Horizontal	Pass
4	7943.01	44.87	13.67	74	29.14	Peak	117.9	150	Horizontal	Pass
5	12457.99	45.97	9.86	74	28.03	Peak	139.4	150	Horizontal	Pass
6	21995.01	46.65	11.21	74	27.35	Peak	319	150	Horizontal	Pass

1 GHz to 25 GHz, ANT V 8-DPSK Low Channel

No.	Frequency (MHz)	Results (dBuV/m)	Factor (dB)	Limit (dBuV/m)	Margin (dB)	Detector	Table (o)	Height (cm)	ANT	Verdict
1	1998.49	51.20	-3.88	74	22.80	Peak	243.6	150	Vertical	Pass
2	2402.09	85.41	-2.21	74	-11.41	Peak	115.6	150	Vertical	N/A
3	5681.61	51.81	12.45	74	22.19	Peak	193.8	150	Vertical	Pass
4	10829.45	46.60	14.48	74	27.40	Peak	304	150	Vertical	Pass
5	16493.76	49.73	8.71	74	24.27	Peak	231.5	150	Vertical	Pass
6	24790.35	45.69	13.93	74	28.31	Peak	99.2	150	Vertical	Pass

1 GHz to 25 GHz, ANT H 8-DPSK Low Channel

No.	Frequency (MHz)	Results (dBuV/m)	Factor (dB)	Limit (dBuV/m)	Margin (dB)	Detector	Table (o)	Height (cm)	ANT	Verdict
1	1993.40	48.18	-3.83	74	25.82	Peak	104	150	Horizontal	Pass
2	2402.55	88.50	-2.21	74	-14.50	Peak	236.6	150	Horizontal	N/A
3	5065.48	51.27	13.10	74	22.73	Peak	143	150	Horizontal	Pass
4	10368.97	45.45	14.19	74	28.55	Peak	188.4	150	Horizontal	Pass
5	17866.47	47.33	9.79	74	26.67	Peak	198.8	150	Horizontal	Pass
6	23772.05	47.71	9.29	74	26.29	Peak	67	150	Horizontal	Pass

1 GHz to 25 GHz, ANT V 8-DPSK Middle Channel

No.	Frequency (MHz)	Results (dBuV/m)	Factor (dB)	Limit (dBuV/m)	Margin (dB)	Detector	Table (o)	Height (cm)	ANT	Verdict
1	1995.38	51.16	-3.88	74	22.84	Peak	241.1	150	Vertical	Pass
2	2440.94	85.57	-2.23	74	-11.57	Peak	177.1	150	Vertical	N/A
3	5680.98	52.56	12.44	74	21.44	Peak	106.3	150	Vertical	Pass
4	7336.52	45.23	20.14	74	28.77	Peak	108.7	150	Vertical	Pass
5	13873.13	44.49	20.64	74	29.51	Peak	302.4	150	Vertical	Pass
6	18719.22	46.66	12.90	74	27.34	Peak	38	150	Vertical	Pass

1 GHz to 25 GHz, ANT H 8-DPSK Middle Channel

No.	Frequency (MHz)	Results (dBuV/m)	Factor (dB)	Limit (dBuV/m)	Margin (dB)	Detector	Table (o)	Height (cm)	ANT	Verdict
1	1992.82	47.24	-3.88	74	26.76	Peak	28.1	150	Horizontal	Pass
2	2440.33	87.90	-2.21	74	-13.90	Peak	101	150	Horizontal	N/A
3	5065.19	51.86	13.10	74	22.14	Peak	21.5	150	Horizontal	Pass
4	11278.70	44.93	20.13	74	29.07	Peak	159.2	150	Horizontal	Pass
5	13727.54	44.01	19.96	74	29.99	Peak	330.7	150	Horizontal	Pass
6	20237.94	45.08	12.87	74	28.92	Peak	70	150	Horizontal	Pass

1 GHz to 25 GHz, ANT V 8-DPSK High Channel

No.	Frequency (MHz)	Results (dBuV/m)	Factor (dB)	Limit (dBuV/m)	Margin (dB)	Detector	Table (o)	Height (cm)	ANT	Verdict
1	1996.58	50.78	-3.90	74	23.22	Peak	282.8	150	Vertical	Pass
2	2480.65	86.22	-2.21	74	-12.22	Peak	321.3	150	Vertical	N/A
3	5680.60	52.01	12.45	74	21.99	Peak	337.6	150	Vertical	Pass
4	9930.95	43.51	16.90	74	30.50	Peak	69.2	150	Vertical	Pass
5	16732.95	44.55	10.71	74	29.45	Peak	186.3	150	Vertical	Pass
6	22823.63	43.27	14.12	74	30.74	Peak	259.6	150	Vertical	Pass

1 GHz to 25 GHz, ANT H 8-DPSK High Channel

No.	Frequency (MHz)	Results (dBuV/m)	Factor (dB)	Limit (dBuV/m)	Margin (dB)	Detector	Table (o)	Height (cm)	ANT	Verdict
1	1995.98	47.89	-3.88	74	26.11	Peak	311.1	150	Horizontal	Pass
2	2480.21	88.02	-2.18	74	-14.02	Peak	305.8	150	Horizontal	N/A
3	5063.59	52.43	13.10	74	21.57	Peak	178.2	150	Horizontal	Pass
4	11233.78	47.06	20.21	74	26.94	Peak	136.4	150	Horizontal	Pass
5	15360.23	42.72	9.42	74	31.28	Peak	307.8	150	Horizontal	Pass
6	18771.22	47.54	13.76	74	26.46	Peak	44.1	150	Horizontal	Pass

Hopping Mode:
1 GHz to 25 GHz, ANT V GFSK(Hopping) Channel

No.	Frequency (MHz)	Results (dBuV/m)	Factor (dB)	Limit (dBuV/m)	Margin (dB)	Detector	Table (o)	Height (cm)	ANT	Verdict
1	1994.16	50.50	-3.88	74	23.50	Peak	172.9	150	Vertical	Pass
2	2441.06	86.12	-2.18	74	-12.12	Peak	187.3	150	Vertical	N/A
3	5683.61	52.79	12.46	74	21.21	Peak	28.9	150	Vertical	Pass
4	11907.65	46.20	18.92	74	27.80	Peak	278.1	150	Vertical	Pass
5	13602.75	46.36	9.62	74	27.64	Peak	56.7	150	Vertical	Pass
6	22683.86	43.18	12.31	74	30.82	Peak	78	150	Vertical	Pass

1 GHz to 25 GHz, ANT H GFSK(Hopping) Channel

No.	Frequency (MHz)	Results (dBuV/m)	Factor (dB)	Limit (dBuV/m)	Margin (dB)	Detector	Table (o)	Height (cm)	ANT	Verdict
1	1995.59	48.26	-3.88	74	25.74	Peak	27.9	150	Horizontal	Pass
2	2440.60	89.26	-2.23	74	-15.26	Peak	157.9	150	Horizontal	N/A
3	5066.39	51.80	13.10	74	22.20	Peak	357.2	150	Horizontal	Pass
4	7662.23	45.71	17.02	74	28.29	Peak	150.6	150	Horizontal	Pass
5	17887.27	43.62	9.77	74	30.38	Peak	1.7	150	Horizontal	Pass
6	23642.26	44.87	9.75	74	29.13	Peak	215.7	150	Horizontal	Pass

1 GHz to 25 GHz, ANT V 8-DPSK(Hopping) Channel

No.	Frequency (MHz)	Results (dBuV/m)	Factor (dB)	Limit (dBuV/m)	Margin (dB)	Detector	Table (o)	Height (cm)	ANT	Verdict
1	1996.98	51.59	-3.88	74	22.41	Peak	98.5	150	Vertical	Pass
2	2441.07	86.25	-2.23	74	-12.25	Peak	55.1	150	Vertical	N/A
3	5679.68	51.59	12.46	74	22.41	Peak	262.5	150	Vertical	Pass
4	9594.01	45.95	20.40	74	28.05	Peak	49.7	150	Vertical	Pass
5	17169.72	45.28	8.72	74	28.72	Peak	318.5	150	Vertical	Pass
6	24740.43	41.76	9.66	74	32.24	Peak	345.5	150	Vertical	Pass

1 GHz to 25 GHz, ANT H 8-DPSK(Hopping) Channel

No.	Frequency (MHz)	Results (dBuV/m)	Factor (dB)	Limit (dBuV/m)	Margin (dB)	Detector	Table (o)	Height (cm)	ANT	Verdict
1	1994.75	47.09	-3.86	74	26.91	Peak	170.7	150	Horizontal	Pass
2	2440.50	88.31	-2.23	74	-14.31	Peak	358	150	Horizontal	N/A
3	5065.42	52.19	13.10	74	21.81	Peak	328.4	150	Horizontal	Pass
4	8762.90	45.44	14.34	74	28.57	Peak	356.7	150	Horizontal	Pass
5	12822.80	43.66	8.74	74	30.34	Peak	350	150	Horizontal	Pass
6	22104.83	47.25	9.90	74	26.75	Peak	148.8	150	Horizontal	Pass

A.9 Band Edge (Restricted-band band-edge)

Note¹: The lowest and highest channels are tested to verify the band edge emissions. Please refer to the following the plots for emissions values.

Note²: The test data all are tested in the vertical and horizontal antenna which the trace is max hold. So these plots have shown the worst case.

Note³: According the ANSI C63.10-2013, where limits are specified for both average and peak (or quasi-peak) detector functions, if the peak (or quasi-peak) measured value complies with the average limit, it is unnecessary to perform an average measurement.

Test Mode	Test Channel	Frequency (MHz)	Level (dBuV/m)	Limit Line (dBuV/m)	Margin (dB)	Remark	Verdict
GFSK	Low	2390.00	44.40	74	29.60	PEAK	Pass
		2390.00	N/A	54	N/A	AVERAGE	Pass
GFSK	HIGH	2483.50	46.86	74	27.14	PEAK	Pass
		2483.50	N/A	54	N/A	AVERAGE	Pass
8-DPSK	Low	2390.00	43.63	74	30.38	PEAK	Pass
		2390.00	N/A	54	N/A	AVERAGE	Pass
8-DPSK	HIGH	2483.50	43.73	74	30.27	PEAK	Pass
		2483.50	N/A	54	N/A	AVERAGE	Pass
GFSK(Hopping)	Low	2390.00	44.88	74	29.12	PEAK	Pass
		2390.00	N/A	54	N/A	AVERAGE	Pass
GFSK(Hopping)	HIGH	2483.50	42.58	74	31.42	PEAK	Pass
		2483.50	N/A	54	N/A	AVERAGE	Pass
8-DPSK (Hopping)	Low	2390.00	44.34	74	29.67	PEAK	Pass
		2390.00	N/A	54	N/A	AVERAGE	Pass
8-DPSK (Hopping)	HIGH	2483.50	43.85	74	30.15	PEAK	Pass
		2483.50	N/A	54	N/A	AVERAGE	Pass

Test Plots

GFSK LOW CHANNEL , PEAK

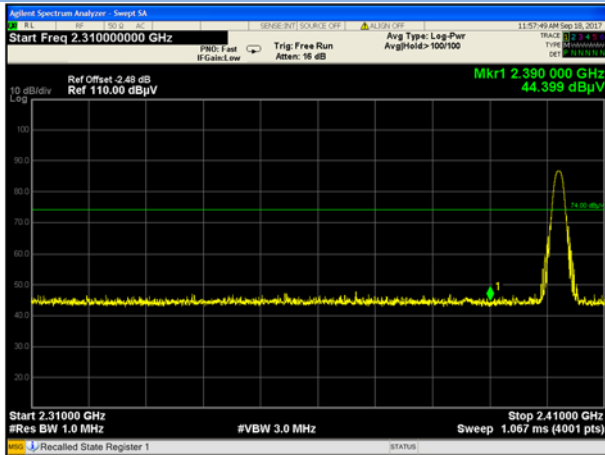

GFSK HIGH CHANNEL , PEAK

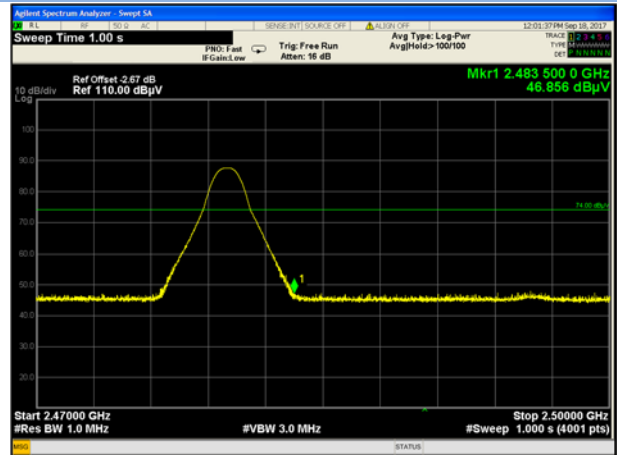

8-DPSK LOW CHANNEL , PEAK

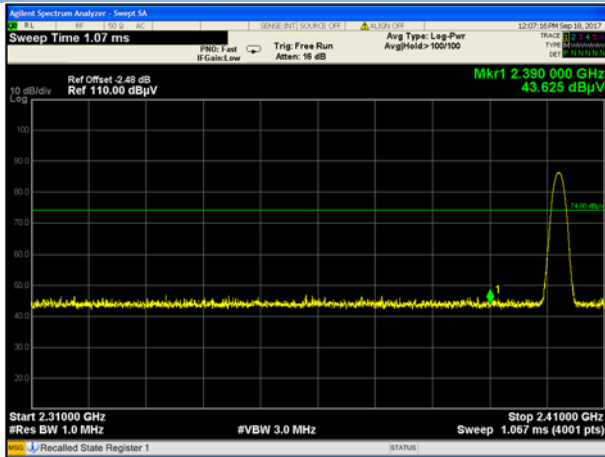

8-DPSK HIGH CHANNEL , PEAK

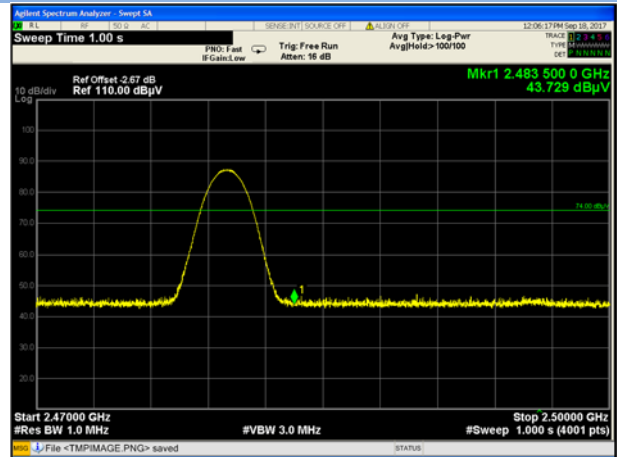

Hopping Mode:

GFSK LOW FREQUENCY BAND, PEAK

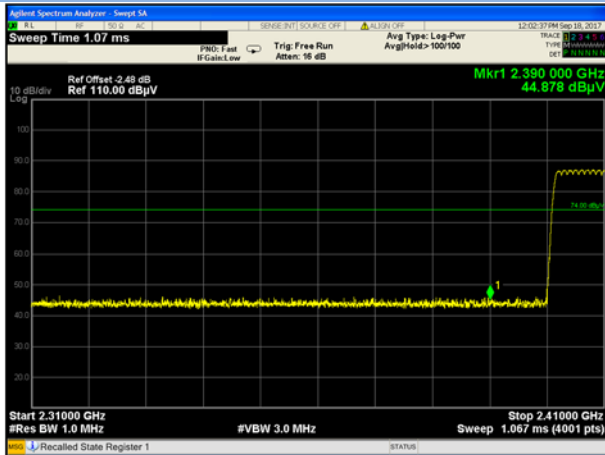

GFSK HIGH FREQUENCY BAND, PEAK

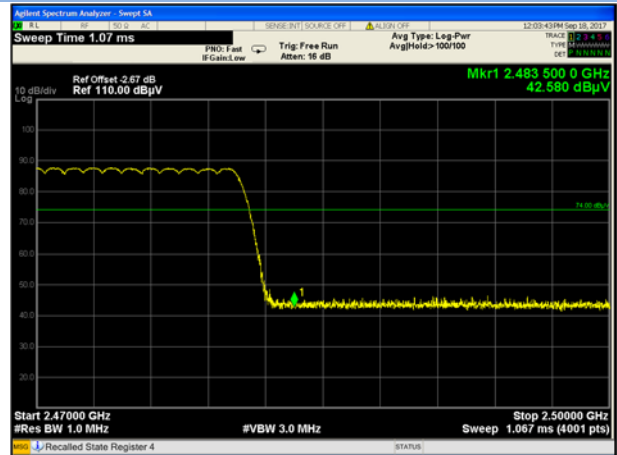

8-DPSK LOW FREQUENCY BAND, PEAK

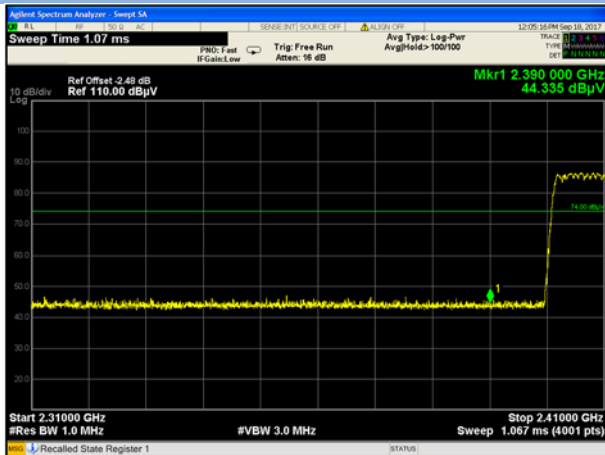

8-DPSK HIGH FREQUENCY BAND, PEAK

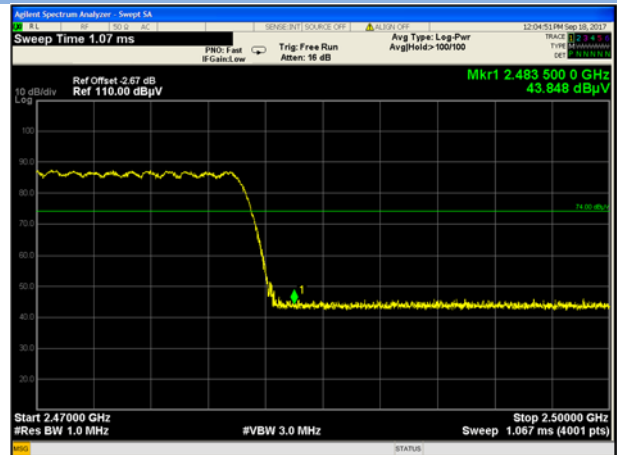

ANNEX B TEST SETUP PHOTOS

Please refer the document “BL-SZ1790067-AR.PDF”.

ANNEX C EUT EXTERNAL PHOTOS

Please refer the document “BL- SZ1790067-AW.PDF”.

ANNEX D EUT INTERNAL PHOTOS

Please refer the document “BL- SZ1790067-AI.PDF”.

--END OF REPORT--