

Launch Tech Co., Ltd.

Automotive diagnosis computer

Main Model: Creader professional229
Serial Model: CRP221, CRP223, CRP225, CRP226,
CRP228, CRP229



June 18, 2014

Report No.: 14070260-FCC-R1
(This report supersedes none)



Modifications made to the product : None

This Test Report is Issued Under the Authority of:

		
Herith Shi Compliance Engineer	Alex Liu Technical Manager	

This test report may be reproduced in full only.
Test result presented in this test report is applicable to the representative sample only.

RF Test Report

To: FCC Part 15.247: 2013, ANSI C63.4: 2009

SIEMIC, INC.

Accessing global markets



Laboratory Introduction

SIEMIC, headquartered in the heart of Silicon Valley, with superior facilities in US and Asia, is one of the leading independent testing and certification facilities providing customers with one-stop shop services for Compliance Testing and Global Certifications.



In addition to [testing](#) and [certification](#), SIEMIC provides initial design reviews and [compliance management](#) through out a project. Our extensive experience with [China](#), [Asia Pacific](#), [North America](#), [European](#), and [international](#) compliance requirements, assures the fastest, most cost effective way to attain regulatory compliance for the [global markets](#).

SIEMIC (Shenzhen - China) Laboratories Accreditations for Conformity Assessment

Country/Region	Scope
USA	EMC , RF/Wireless , Telecom
Canada	EMC, RF/Wireless , Telecom
Taiwan	EMC, RF, Telecom , Safety
Hong Kong	RF/Wireless ,Telecom
Australia	EMC, RF, Telecom , Safety
Korea	EMI, EMS, RF , Telecom, Safety
Japan	EMI, RF/Wireless, Telecom
Singapore	EMC , RF , Telecom
Europe	EMC, RF, Telecom , Safety



SIEMIC, INC.

Accessing global markets

Title: RF Test Report for Automotive diagnosis computer
Main Model: Creader professional229
Serial Model: CRP221, CRP223, CRP225, CRP226, CRP228, CRP229
To: FCC Part 15.247: 2013, ANSI C63.4: 2009

Report No.: 14070260-FCC-R1
Issue Date: June 18, 2014
Page: 3 of 76
www.siemic.com
www.siemic.com.cn

This page has been left blank intentionally.

CONTENTS

1	EXECUTIVE SUMMARY & EUT INFORMATION	5
2	TECHNICAL DETAILS	6
3	MODIFICATION.....	7
4	TEST SUMMARY.....	8
5	MEASUREMENTS, EXAMINATION AND DERIVED RESULTS	9
	ANNEX A. TEST INSTRUMENT & METHOD	55
	ANNEX B. EUT AND TEST SETUP PHOTOGRAPHS	60
	ANNEX C. TEST SETUP AND SUPPORTING EQUIPMENT.....	71
	ANNEX D. USER MANUAL / BLOCK DIAGRAM / SCHEMATICS / PART LIST	75
	ANNEX E. DECLARATION OF SIMILARITY	76

1 EXECUTIVE SUMMARY & EUT INFORMATION

The purpose of this test programme was to demonstrate compliance of the Launch Tech Co., Ltd., Automotive diagnosis computer and model: Creader professional229 against the current Stipulated Standards. The Automotive diagnosis computer has demonstrated compliance with the FCC Part 15.247: 2013, ANSI C63.4: 2009.

EUT Information

EUT Description : Automotive diagnosis computer

Main Model : Creader professional229

Serial Model : CRP221, CRP223, CRP225, CRP226, CRP228, CRP229 (The difference between Main Model and Serial Model are Label and Color)

Antenna Gain : WIFI: 2.5 dBi

Input Power :

- Adapter:**
- Model:** HKC0055010-3A
- Input:** 100-240V; 50/60Hz
- Output:** 5V; 1000mA
- Battery:**
- Model:** CRP229
- Spec:** 3.8V 3000mAh
- Limited charger voltage:** 4.35V

Classification Per Stipulated Test Standard : FCC Part 15.247: 2013, ANSI C63.4: 2009



SIEMIC, INC.

Accessing global markets

Title: RF Test Report for Automotive diagnosis computer
Main Model: Creader professional229
Serial Model: CRP221, CRP223, CRP225, CRP226, CRP228, CRP229
To: FCC Part 15.247: 2013, ANSI C63.4: 2009

Report No.: 14070260-FCC-R1
Issue Date: June 18, 2014
Page: 6 of 76
www.siemic.com
www.siemic.com.cn

2 TECHNICAL DETAILS

Purpose	Compliance testing of Automotive diagnosis computer with stipulated standard
Applicant / Client	Launch Tech Co., Ltd. Launch Industrial Park, North of Wuhe Rd., Banxuegang, Longgang, Shenzhen, China
Manufacturer	Launch Tech Co., Ltd. Launch Industrial Park, North of Wuhe Rd., Banxuegang, Longgang, Shenzhen, China
Laboratory performing the tests	SIEMIC (Shenzhen - China) Laboratories Zone A, Floor 1, Building 2, Wan Ye Long Technology Park, South Side of Zhoushi Road, Bao'an District, Shenzhen, Guangdong, China Tel: +86-0755-2601 4629 / 2601 4953 Fax: +86-0755-2601 4953-810 Email: China@siemic.com.cn
Test report reference number	14070260-FCC-R1
Date EUT received	May 22, 2014
Standard applied	FCC Part 15.247: 2013, ANSI C63.4: 2009
Dates of test (from – to)	May 26 to June 18, 2014
No of Units :	#1
Equipment Category :	DTS
Trade Name :	LAUNCH
RF Operating Frequency (ies)	802.11b/g/n(HT20): 2412-2462 MHz
Number of Channels	802.11b/g/n(HT20): 11CH
Modulation	802.11b/g/n: DSSS/OFDM
FCC ID	XUJCRP229A



SIEMIC, Inc.

Accessing global markets

Title: RF Test Report for Automotive diagnosis computer
Main Model: Creader professional229
Serial Model: CRP221, CRP223, CRP225, CRP226, CRP228, CRP229
To: FCC Part 15.247: 2013, ANSI C63.4: 2009

Report No.: 14070260-FCC-R1
Issue Date: June 18, 2014
Page: 7 of 76
www.siemic.com
www.siemic.com.cn

3 MODIFICATION

NONE

4 TEST SUMMARY

The product was tested in accordance with the following specifications.
 All testing has been performed according to below product classification:

Test Results Summary

FCC Rules	Description of Test	Result
§15.203	Antenna Requirement	Compliance
§15.247 (a)(2)	DTS (6 dB&20 dB) CHANNEL BANDWIDTH	Compliance
§15.247(b)(3)	Conducted Maximum Output Power	Compliance
§15.247(e)	Power Spectral Density	Compliance
§15.247(d)	Band-Edge & Unwanted Emissions into Non-Restricted Frequency Bands	Compliance
§15.207 (a),	AC Power Line Conducted Emissions	Compliance
§15.205, §15.209, §15.247(d)	Radiated Spurious Emissions & Unwanted Emissions into Restricted Frequency Bands	Compliance

5 MEASUREMENTS, EXAMINATION AND DERIVED RESULTS

5.1 §15.203 - ANTENNA REQUIREMENT

Applicable Standard

According to § 15.203, an intentional radiator shall be designed to ensure that no antenna other than that furnished by the responsible party shall be used with the device. The use of a permanently attached antenna or of an antenna that uses a unique coupling to the intentional radiator shall be considered sufficient to comply with the provisions of this section. The manufacturer may design the unit so that a broken antenna can be replaced by the user, but the user of a standard antenna jack or electrical connector is prohibited. The structure and application of the EUT were analyzed to determine compliance with section §15.203 of the rules. §15.203 state that the subject device must meet the following criteria:

- a. Antenna must be permanently attached to the unit.
- b. Antenna must use a unique type of connector to attach to the EUT.

Unit must be professionally installed, and installer shall be responsible for verifying that the correct antenna is employed with the unit.

And according to FCC 47 CFR section 15.247 (b), if the transmitting antennas of directional gain greater than 6dBi are used, the power shall be reduced by the amount in dB that the directional gain of the antenna exceeds 6 dBi.

Antenna Connector Construction

The EUT has one antenna: a PIFA antenna for WIFI, the gain is 2.5 dBi for WIFI.

which in accordance to section 15.203, please refer to the internal photos.

Test Result: Pass

5.2 §15.247(a) (2) –DTS (6 dB& 20dB) CHANNEL BANDWIDTH

1. Conducted Measurement
EUT was set for low, mid, high channel with modulated mode and highest RF output power.
The spectrum analyzer was connected to the antenna terminal.
2. Environmental Conditions

Temperature	24°C
Relative Humidity	56%
Atmospheric Pressure	1020mbar
3. Conducted Emissions Measurement Uncertainty
All test measurements carried out are traceable to national standards. The uncertainty of the measurement at a confidence level of approximately 95% (in the case where distributions are normal), with a coverage factor of 2, in the range 30MHz – 40GHz is ±1.5dB.
4. Test date : May 27, 2014
Tested By : Herith Shi

Requirement(s): The minimum 6 dB bandwidth of a DTS transmission shall be at least 500 kHz. Within this document, this bandwidth is referred to as the DTS bandwidth. The procedures provided herein for measuring the maximum peak conducted output power assume the use of the DTS bandwidth.

Procedures:

1. Set RBW = 100 kHz.
2. Set the video bandwidth (VBW) $\geq 3 \times$ RBW.
3. Detector = Peak.
4. Trace mode = max hold.
5. Sweep = auto couple.
6. Allow the trace to stabilize.
7. Measure the maximum width of the emission that is constrained by the frequencies associated with the two outermost amplitude points (upper and lower) that are attenuated by 6 dB relative to the maximum level measured in the fundamental emission.

Test Result: Pass.

Please refer to the following tables and plots.

Note:

B: 802.11b
 G: 802.11g
 N20: 802.11n (HT20)

1: Low Channel
 6: Middle Channel
 11: High Channel

6dB bandwidth:

Channel	Channel Frequency (MHz)	Data Rate (Mbps)	Measured 6dB Bandwidth (MHz)	FCC Part 15.247 Limit (kHz)
802.11b mode				
Low	2412	1	10.088	> 500
Middle	2437	1	10.093	> 500
High	2462	1	10.084	> 500
802.11g mode				
Low	2412	6	16.585	> 500
Middle	2437	6	16.588	> 500
High	2462	6	16.576	> 500
802.11n(HT20) mode				
Low	2412	MCS0	17.870	> 500
Middle	2437	MCS0	17.885	> 500
High	2462	MCS0	17.868	> 500



SIEMIC, INC.

Accessing global markets

Title: RF Test Report for Automotive diagnosis computer
Main Model: Creader professional229
Serial Model: CRP221, CRP223, CRP225, CRP226, CRP228, CRP229
To: FCC Part 15.247: 2013, ANSI C63.4: 2009

Report No.: 14070260-FCC-R1
Issue Date: June 18, 2014
Page: 12 of 76
www.siemec.com
www.siemec.com.cn

Agilent 07:15:12 May 27, 2014 R T

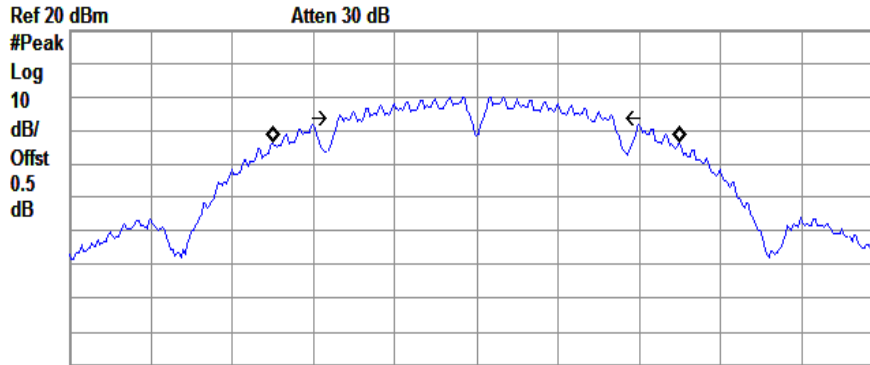

Center 2.412 GHz Span 30 MHz
#Res BW 100 kHz #VBW 300 kHz Sweep 4 ms (401 pts)

Occupied Bandwidth 14.9890 MHz Occ BW % Pwr 99.00 %
x dB -6.00 dB

Transmit Freq Error -5.120 kHz
x dB Bandwidth 10.088 MHz



B-1 6dB

Agilent 07:27:43 May 27, 2014 R T

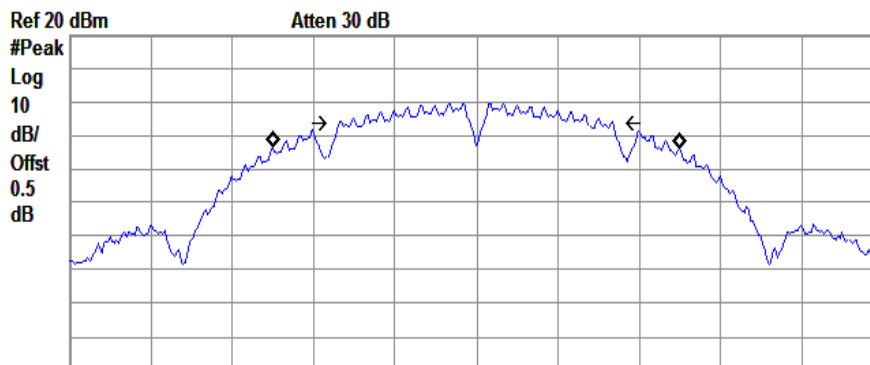

Center 2.437 GHz Span 30 MHz
#Res BW 100 kHz #VBW 300 kHz Sweep 4 ms (401 pts)

Occupied Bandwidth 14.9920 MHz Occ BW % Pwr 99.00 %
x dB -6.00 dB

Transmit Freq Error -3.825 kHz
x dB Bandwidth 10.093 MHz



B-6 6dB



SIEMIC, INC.

Accessing global markets

Title: RF Test Report for Automotive diagnosis computer
Main Model: Creader professional229
Serial Model: CRP221, CRP223, CRP225, CRP226, CRP228, CRP229
To: FCC Part 15.247: 2013, ANSI C63.4: 2009

Report No.: 14070260-FCC-R1
Issue Date: June 18, 2014
Page: 13 of 76
www.siemec.com
www.siemec.com.cn

Agilent 07:22:26 May 27, 2014 R T

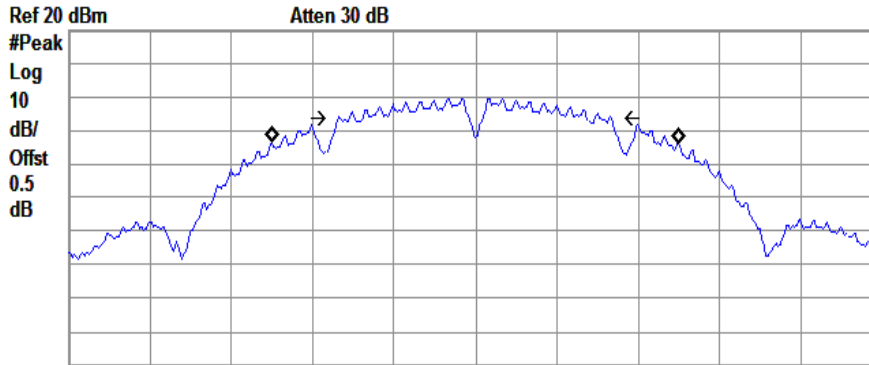

Center 2.462 GHz Span 30 MHz
#Res BW 100 kHz #VBW 300 kHz Sweep 4 ms (401 pts)

Occupied Bandwidth	Occ BW % Pwr	99.00 %
14.9918 MHz	x dB	-6.00 dB

Transmit Freq Error	-8.131 kHz
x dB Bandwidth	10.084 MHz



B-11 6dB

Agilent 07:30:42 May 27, 2014 R T

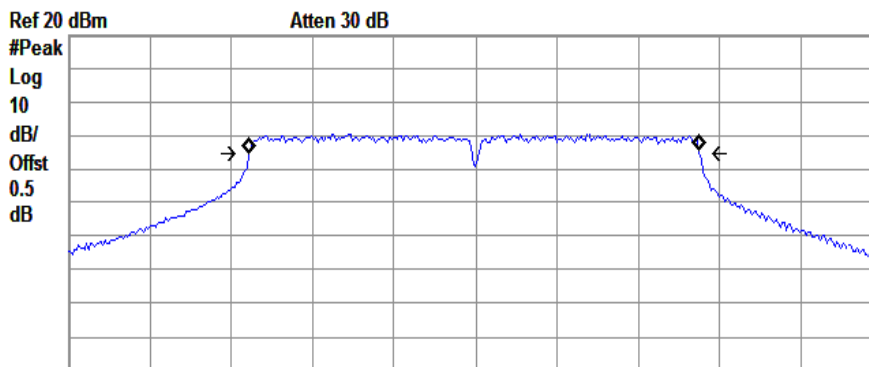

Center 2.412 GHz Span 30 MHz
#Res BW 100 kHz #VBW 300 kHz Sweep 4 ms (401 pts)

Occupied Bandwidth	Occ BW % Pwr	99.00 %
16.5603 MHz	x dB	-6.00 dB

Transmit Freq Error	-39.027 kHz
x dB Bandwidth	16.585 MHz



G-1 6dB



SIEMIC, INC.

Accessing global markets

Title: RF Test Report for Automotive diagnosis computer
Main Model: Creader professional229
Serial Model: CRP221, CRP223, CRP225, CRP226, CRP228, CRP229
To: FCC Part 15.247: 2013, ANSI C63.4: 2009

Report No.: 14070260-FCC-R1
Issue Date: June 18, 2014
Page: 14 of 76
www.siemec.com
www.siemec.com.cn

Agilent 07:33:30 May 27, 2014 R T

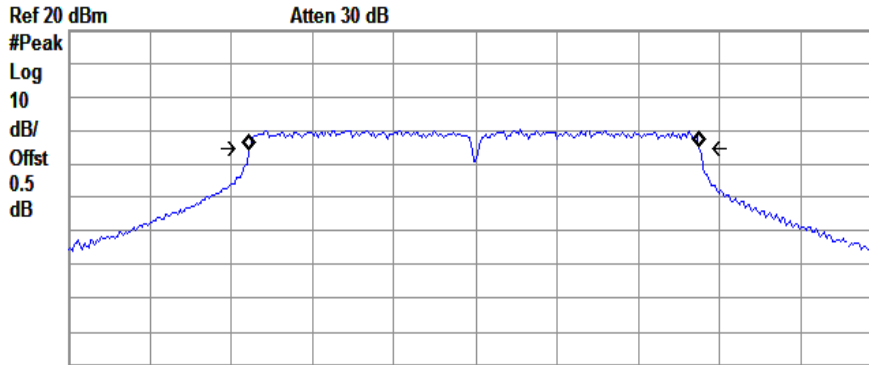

Center 2.437 GHz Span 30 MHz
#Res BW 100 kHz #VBW 300 kHz Sweep 4 ms (401 pts)

Occupied Bandwidth	Occ BW % Pwr	99.00 %
16.5602 MHz	x dB	-6.00 dB

Transmit Freq Error	-39.654 kHz
x dB Bandwidth	16.588 MHz



G-6 6dB

Agilent 07:34:42 May 27, 2014 R T

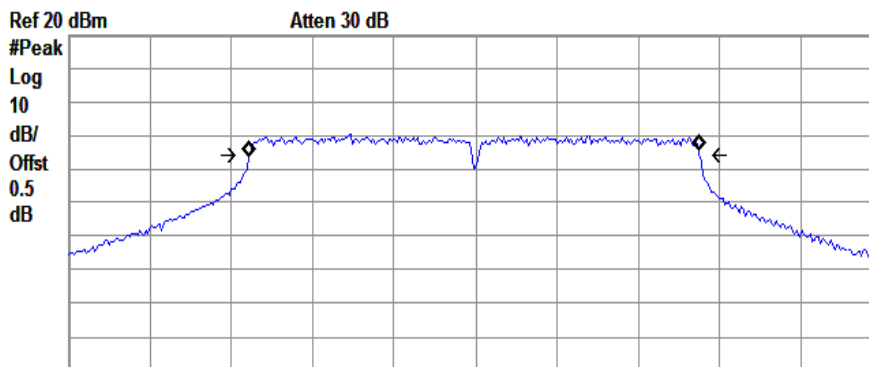

Center 2.462 GHz Span 30 MHz
#Res BW 100 kHz #VBW 300 kHz Sweep 4 ms (401 pts)

Occupied Bandwidth	Occ BW % Pwr	99.00 %
16.5544 MHz	x dB	-6.00 dB

Transmit Freq Error	-45.729 kHz
x dB Bandwidth	16.576 MHz



G-11 6dB



SIEMIC, INC.

Accessing global markets

Title: RF Test Report for Automotive diagnosis computer
Main Model: Creader professional229
Serial Model: CRP221, CRP223, CRP225, CRP226, CRP228, CRP229
To: FCC Part 15.247: 2013, ANSI C63.4: 2009

Report No.: 14070260-FCC-R1
Issue Date: June 18, 2014
Page: 15 of 76
www.siemec.com
www.siemec.com.cn

Agilent 07:40:08 May 27, 2014 R T

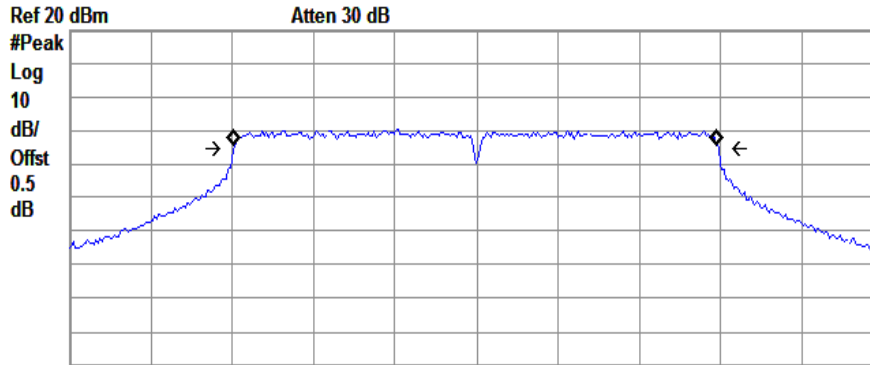

Center 2.412 GHz Span 30 MHz
#Res BW 100 kHz #VBW 300 kHz Sweep 4 ms (401 pts)

Occupied Bandwidth 17.7678 MHz Occ BW % Pwr 99.00 %
x dB -6.00 dB

Transmit Freq Error -4.887 kHz
x dB Bandwidth 17.870 MHz



N20-1 6dB

Agilent 07:38:22 May 27, 2014 R T

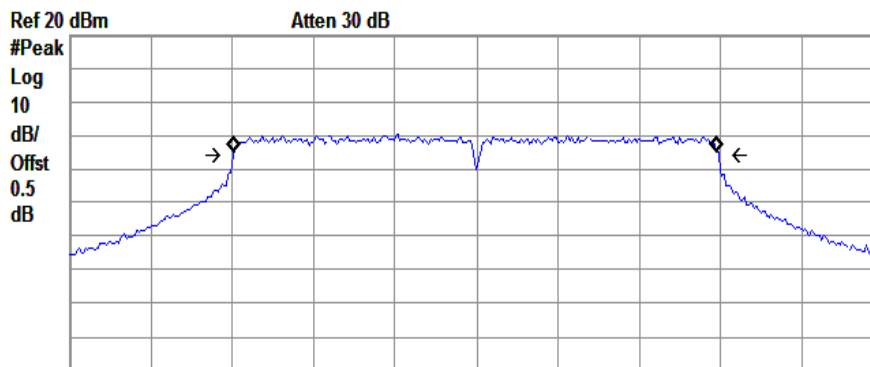

Center 2.437 GHz Span 30 MHz
#Res BW 100 kHz #VBW 300 kHz Sweep 4 ms (401 pts)

Occupied Bandwidth 17.7752 MHz Occ BW % Pwr 99.00 %
x dB -6.00 dB

Transmit Freq Error -8.911 kHz
x dB Bandwidth 17.885 MHz



N20-6 6dB



SIEMIC, INC.

Accessing global markets

Title: RF Test Report for Automotive diagnosis computer
Main Model: Creader professional229
Serial Model: CRP221, CRP223, CRP225, CRP226, CRP228, CRP229
To: FCC Part 15.247: 2013, ANSI C63.4: 2009

Report No.: 14070260-FCC-R1
Issue Date: June 18, 2014
Page: 16 of 76
www.siemec.com
www.siemec.com.cn

Agilent 07:37:00 May 27, 2014 R T



Center 2.462 GHz Span 30 MHz
#Res BW 100 kHz #VBW 300 kHz Sweep 4 ms (401 pts)

Occupied Bandwidth
17.7731 MHz

Occ BW % Pwr 99.00 %
x dB -6.00 dB

Transmit Freq Error -8.266 kHz
x dB Bandwidth 17.868 MHz



N20-11 6dB



SIEMIC, INC.

Accessing global markets

Title: RF Test Report for Automotive diagnosis computer
Main Model: Creader professional229
Serial Model: CRP221, CRP223, CRP225, CRP226, CRP228, CRP229
To: FCC Part 15.247: 2013, ANSI C63.4: 2009

Report No.: 14070260-FCC-R1
Issue Date: June 18, 2014
Page: 17 of 76
www.siemec.com
www.siemec.com.cn

The 20dB bandwidth:

Agilent 07:14:04 May 27, 2014 R T

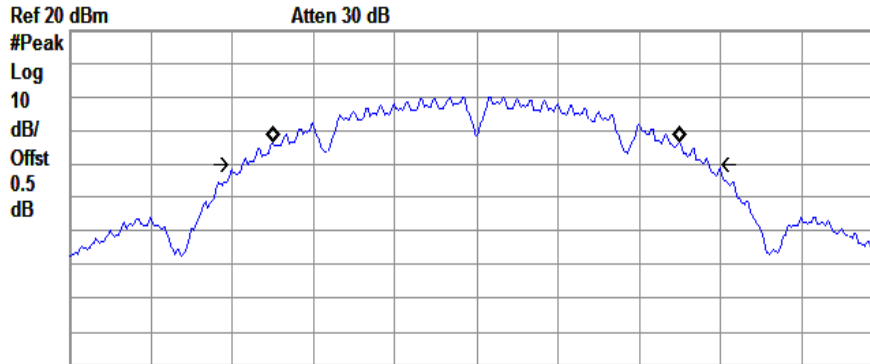

Center 2.412 GHz Span 30 MHz
#Res BW 100 kHz #VBW 300 kHz Sweep 4 ms (401 pts)

Occupied Bandwidth
14.9936 MHz

Occ BW % Pwr 99.00 %
x dB -20.00 dB

Transmit Freq Error -4.532 kHz
x dB Bandwidth 17.180 MHz



B-1 20dB

Agilent 07:26:50 May 27, 2014 R T

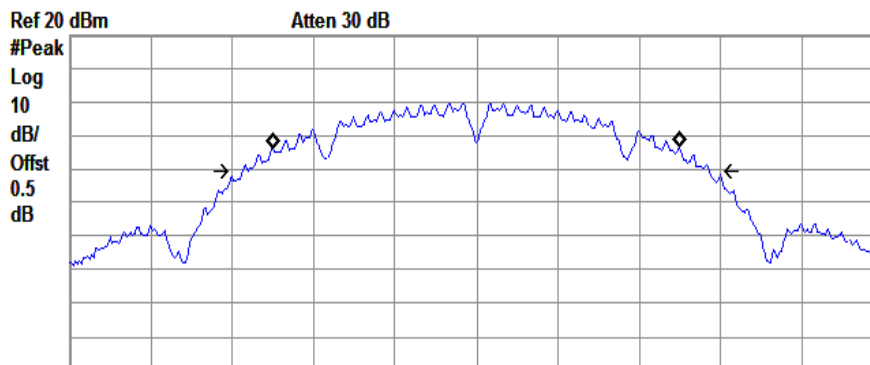

Center 2.437 GHz Span 30 MHz
#Res BW 100 kHz #VBW 300 kHz Sweep 4 ms (401 pts)

Occupied Bandwidth
15.0013 MHz

Occ BW % Pwr 99.00 %
x dB -20.00 dB

Transmit Freq Error -4.173 kHz
x dB Bandwidth 17.188 MHz



B-6 20dB



SIEMIC, INC.

Accessing global markets

Title: RF Test Report for Automotive diagnosis computer
Main Model: Creader professional229
Serial Model: CRP221, CRP223, CRP225, CRP226, CRP228, CRP229
To: FCC Part 15.247: 2013, ANSI C63.4: 2009

Report No.: 14070260-FCC-R1
Issue Date: June 18, 2014
Page: 18 of 76
www.siemec.com
www.siemec.com.cn

Agilent 07:22:56 May 27, 2014 R T

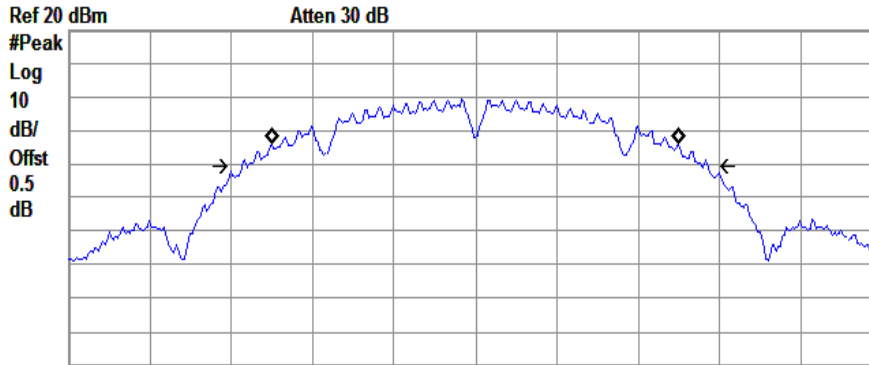

Center 2.462 GHz Span 30 MHz
#Res BW 100 kHz #VBW 300 kHz Sweep 4 ms (401 pts)

Occupied Bandwidth 14.9976 MHz
Occ BW % Pwr 99.00 %
x dB -20.00 dB

Transmit Freq Error -5.404 kHz
x dB Bandwidth 17.173 MHz



B-11 20dB

Agilent 07:31:26 May 27, 2014 R T

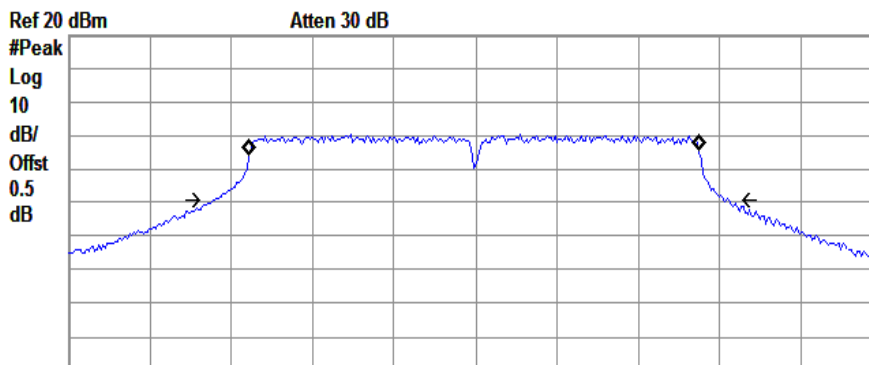

Center 2.412 GHz Span 30 MHz
#Res BW 100 kHz #VBW 300 kHz Sweep 4 ms (401 pts)

Occupied Bandwidth 16.5441 MHz
Occ BW % Pwr 99.00 %
x dB -20.00 dB

Transmit Freq Error -36.472 kHz
x dB Bandwidth 19.072 MHz



G-1 20dB



SIEMIC, INC.

Accessing global markets

Title: RF Test Report for Automotive diagnosis computer
Main Model: Creader professional229
Serial Model: CRP221, CRP223, CRP225, CRP226, CRP228, CRP229
To: FCC Part 15.247: 2013, ANSI C63.4: 2009

Report No.: 14070260-FCC-R1
Issue Date: June 18, 2014
Page: 19 of 76
www.siemec.com
www.siemec.com.cn

Agilent 07:33:05 May 27, 2014 R T

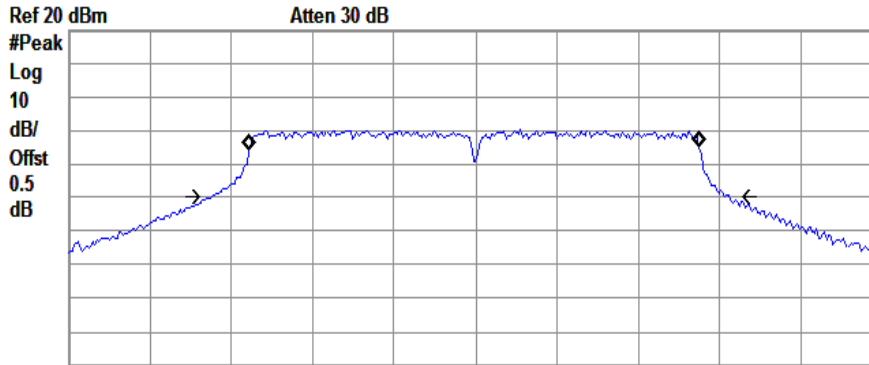

Center 2.437 GHz Span 30 MHz
#Res BW 100 kHz #VBW 300 kHz Sweep 4 ms (401 pts)

Occupied Bandwidth 16.5572 MHz
Occ BW % Pwr 99.00 %
x dB -20.00 dB

Transmit Freq Error -40.477 kHz
x dB Bandwidth 19.082 MHz



G-6 20dB

Agilent 07:35:47 May 27, 2014 R T

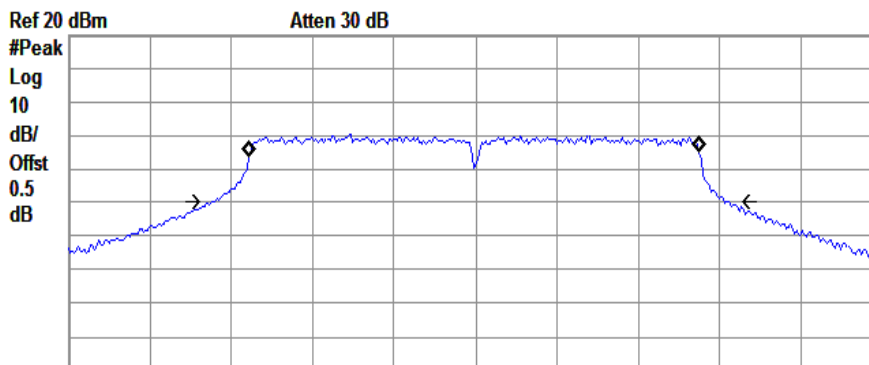

Center 2.462 GHz Span 30 MHz
#Res BW 100 kHz #VBW 300 kHz Sweep 4 ms (401 pts)

Occupied Bandwidth 16.5667 MHz
Occ BW % Pwr 99.00 %
x dB -20.00 dB

Transmit Freq Error -41.196 kHz
x dB Bandwidth 19.059 MHz



G-11 20dB



SIEMIC, INC.

Accessing global markets

Title: RF Test Report for Automotive diagnosis computer
Main Model: Creader professional229
Serial Model: CRP221, CRP223, CRP225, CRP226, CRP228, CRP229
To: FCC Part 15.247: 2013, ANSI C63.4: 2009

Report No.: 14070260-FCC-R1
Issue Date: June 18, 2014
Page: 20 of 76
www.siemec.com
www.siemec.com.cn

Agilent 07:43:40 May 27, 2014 R T

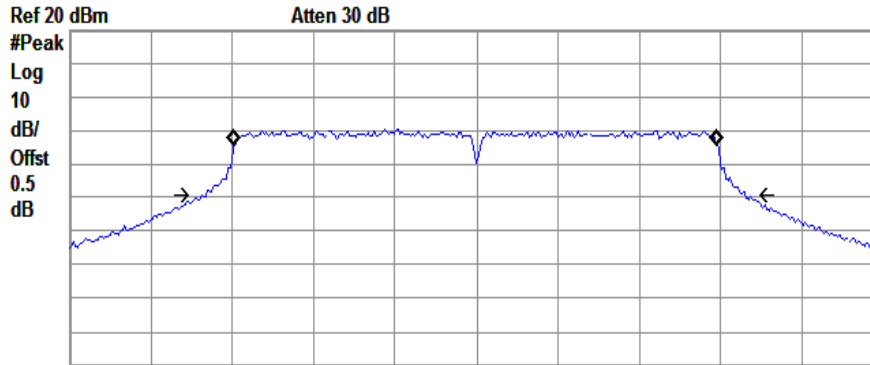

Center 2.412 GHz Span 30 MHz
#Res BW 100 kHz #VBW 300 kHz Sweep 4 ms (401 pts)

Occupied Bandwidth
17.7778 MHz

Occ BW % Pwr 99.00 %
x dB -20.00 dB

Transmit Freq Error -7.985 kHz
x dB Bandwidth 20.083 MHz



N20-1 20dB

Agilent 07:38:39 May 27, 2014 R T

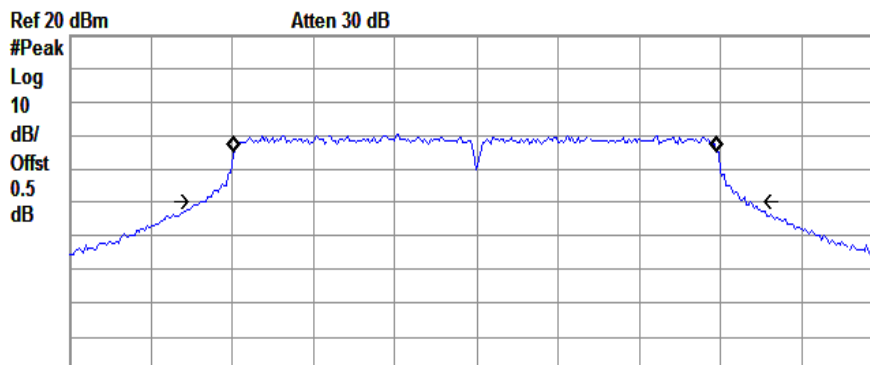

Center 2.437 GHz Span 30 MHz
#Res BW 100 kHz #VBW 300 kHz Sweep 4 ms (401 pts)

Occupied Bandwidth
17.7751 MHz

Occ BW % Pwr 99.00 %
x dB -20.00 dB

Transmit Freq Error -8.848 kHz
x dB Bandwidth 20.273 MHz



N20-6 20dB



SIEMIC, INC.

Accessing global markets

Title: RF Test Report for Automotive diagnosis computer
Main Model: Creader professional229
Serial Model: CRP221, CRP223, CRP225, CRP226, CRP228, CRP229
To: FCC Part 15.247: 2013, ANSI C63.4: 2009

Report No.: 14070260-FCC-R1
Issue Date: June 18, 2014
Page: 21 of 76
www.siemec.com
www.siemec.com.cn

Agilent 07:36:43 May 27, 2014 R T

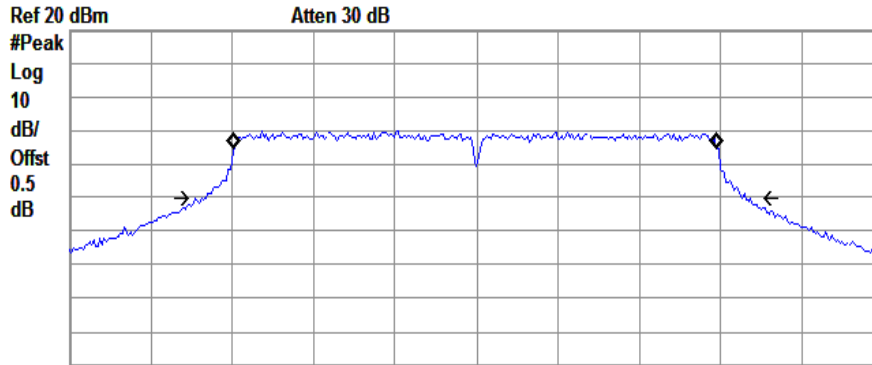

Center 2.462 GHz Span 30 MHz
#Res BW 100 kHz #VBW 300 kHz Sweep 4 ms (401 pts)

Occupied Bandwidth
17.7739 MHz

Occ BW % Pwr 99.00 %
x dB -20.00 dB

Transmit Freq Error -9.240 kHz
x dB Bandwidth 20.264 MHz



N20-11 20dB

5.3 §15.247(b) (3) - Conducted Maximum Output Power

1. Conducted Measurement
EUT was set for low, mid, high channel with modulated mode and highest RF output power.
The spectrum analyzer was connected to the antenna terminal.
2. Conducted Emissions Measurement Uncertainty
All test measurements carried out are traceable to national standards. The uncertainty of the measurement at a confidence level of approximately 95% (in the case where distributions are normal), with a coverage factor of 2, in the range 30MHz – 40GHz is ± 1.5 dB.
3. Environmental Conditions

Temperature	23°C
Relative Humidity	57%
Atmospheric Pressure	1020mbar
4. Test date : May 30, 2014
Tested By : Herith Shi

Standard Requirement:

Maximum Peak Conducted Output Power

The following procedures can be used to determine the maximum peak conducted output power of a DTS EUT.

Maximum Conducted Output Power

§15.247(b)(3) permits the maximum (average) conducted output power to be measured as an alternative to the maximum peak conducted output power for demonstrating compliance to the limit. When these procedures are utilized, the power is referenced to the emission bandwidth (EBW) rather than the DTS bandwidth (see Section 2.0 for definitions).

When using a spectrum/signal analyzer to perform these measurements, it must be capable of utilizing a number of measurement points in each sweep that is greater than or equal to twice the span/RBW in order to ensure bin-to-bin spacing of $\leq RBW/2$ so that narrowband signals are not lost between frequency bins.

The ideal method for measuring the maximum (average) conducted output power is with the EUT is configured to transmit continuously (duty cycle $\geq 98\%$) at its maximum power control level. However, when this condition cannot be realized, video triggering or signal gating can be used to ensure that the measurements are performed only during periods when the EUT is transmitting at its maximum power control level. An option is also provided that can be used when none of the above requirements can be met with the available measurement instrumentation.

Procedures:

Measurement Procedure PK:

This procedure should only be used when the maximum available RBW of the spectrum/signal analyzer is less than the DTS bandwidth.

1. Set the RBW = maximum available (at least 1 MHz).
2. Set the VBW = 3 x RBW or maximum available setting (must be $\geq RBW$).
3. Set the span to fully encompass the DTS bandwidth.
4. Detector = peak.
5. Sweep time = auto couple.
6. Trace mode = max hold.
7. Allow trace to fully stabilize.
8. Use the spectrum analyzer's band/channel power measurement function with the band limits set equal to the DTS bandwidth edges (for some analyzers, this may require a manual override to ensure use of peak detector). If the spectrum analyzer does not have a band power function, sum the spectrum levels (in linear power units) at intervals equal to the RBW extending across the DTS channel bandwidth.

Measurement Procedure AVG:

This procedure should be used with an RMS power averaging detector; however, a sample detector can be used when an RMS detector is not available. This is the baseline method for measuring the maximum (average) conducted output power.

1. Set the analyzer span to a minimum of 1.5 times the EBW.
2. Set the RBW = 1 MHz.
3. Set the VBW ≥ 3 MHz.
4. Ensure that the number of measurement points in the sweep ≥ 2 x span/RBW.

5. Sweep time = auto couple.
6. Detector = power averaging (RMS) or sample detector when RMS not available.
7. Employ trace averaging in power averaging (RMS) mode over a minimum of 100 traces.
8. Use the spectrum analyzer's band power measurement function with band limits set equal to the EBW band edges.

Note: If the analyzer does not have a band power function, sum the spectral levels (in linear power units) at 1 MHz intervals extending across the entire EBW.

Test Result: Pass.

Please refer to the following tables and plots.

Note:

B: 802.11b
G: 802.11g
N: 802.11n (HT20)

1: Low Channel
6: Middle Channel
11: High Channel

The Peak/Average Power

Channel	Channel Frequency (MHz)	Data Rate (Mbps)	PK Output Power (dBm)	AV Output Power (dBm)	Limit (dBm)
802.11b mode					
Low	2412	1	13.91	10.02	30
Middle	2437	1	13.49	10.17	30
High	2462	1	12.94	10.42	30
802.11g mode					
Low	2412	6	13.28	8.50	30
Middle	2437	6	13.37	8.31	30
High	2462	6	12.73	8.32	30
802.11n(HT20) mode					
Low	2412	MCS0	13.34	8.39	30
Middle	2437	MCS0	13.52	8.22	30
High	2462	MCS0	13.17	8.32	30



SIEMIC, INC.

Accessing global markets

Title: RF Test Report for Automotive diagnosis computer
Main Model: Creader professional229
Serial Model: CRP221, CRP223, CRP225, CRP226, CRP228, CRP229
To: FCC Part 15.247: 2013, ANSI C63.4: 2009

Report No.: 14070260-FCC-R1
Issue Date: June 18, 2014
Page: 24 of 76
www.siemec.com
www.siemec.com.cn

The Peak Power

Agilent 06:34:31 May 30, 2014 R T

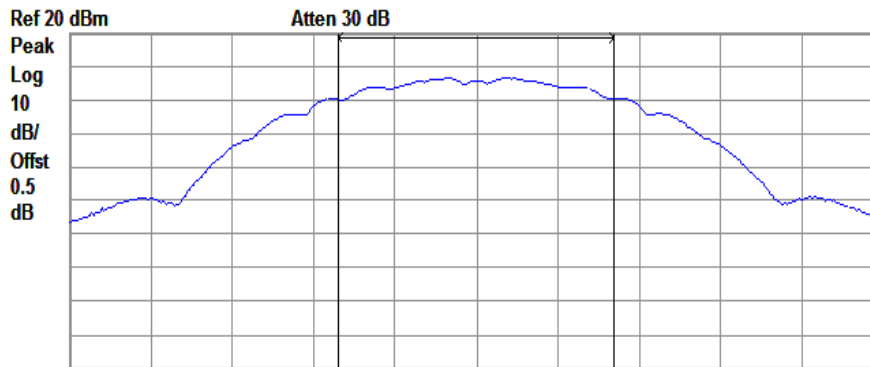

Center 2.412 GHz #Res BW 1 MHz #VBW 3 MHz Sweep 4 ms (401 pts)

Channel Power 13.91 dBm / 10.0880 MHz
Power Spectral Density -56.13 dBm/Hz



B-1 PK

Agilent 06:36:07 May 30, 2014 R T

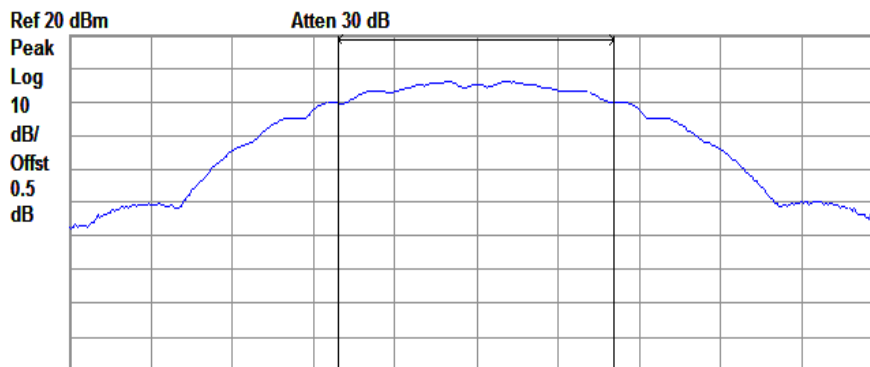

Center 2.437 GHz #Res BW 1 MHz #VBW 3 MHz Sweep 4 ms (401 pts)

Channel Power 13.49 dBm / 10.0930 MHz
Power Spectral Density -56.55 dBm/Hz



B-6 PK



SIEMIC, INC.

Accessing global markets

Title: RF Test Report for Automotive diagnosis computer
Main Model: Creader professional229
Serial Model: CRP221, CRP223, CRP225, CRP226, CRP228, CRP229
To: FCC Part 15.247: 2013, ANSI C63.4: 2009

Report No.: 14070260-FCC-R1
Issue Date: June 18, 2014
Page: 25 of 76
www.siemec.com
www.siemec.com.cn

Agilent 06:39:48 May 30, 2014 R T

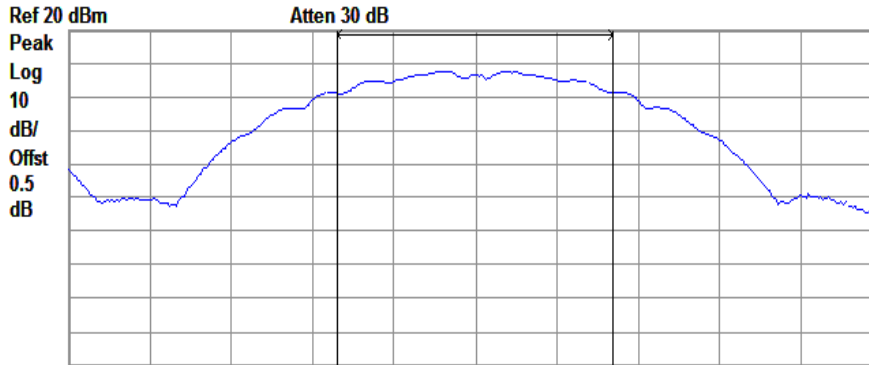

Center 2.462 GHz #VBW 3 MHz Sweep 4 ms (401 pts)
#Res BW 1 MHz

Channel Power Power Spectral Density
12.94 dBm / 10.0840 MHz -57.10 dBm/Hz



B-11 PK

Agilent 07:00:53 May 30, 2014 R T

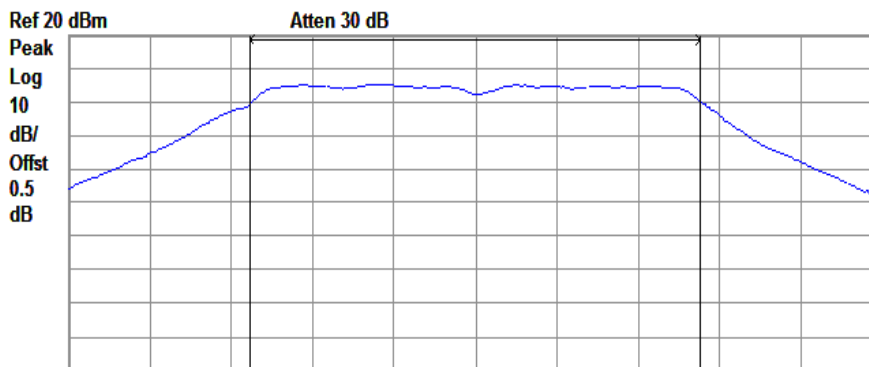

Center 2.412 GHz #VBW 3 MHz Sweep 4 ms (401 pts)
#Res BW 1 MHz

Channel Power Power Spectral Density
13.28 dBm / 16.5885 MHz -58.91 dBm/Hz



G-1 PK



SIEMIC, INC.

Accessing global markets

Title: RF Test Report for Automotive diagnosis computer
Main Model: Creader professional229
Serial Model: CRP221, CRP223, CRP225, CRP226, CRP228, CRP229
To: FCC Part 15.247: 2013, ANSI C63.4: 2009

Report No.: 14070260-FCC-R1
Issue Date: June 18, 2014
Page: 26 of 76
www.siemec.com
www.siemec.com.cn

Agilent 06:55:39 May 30, 2014 R T

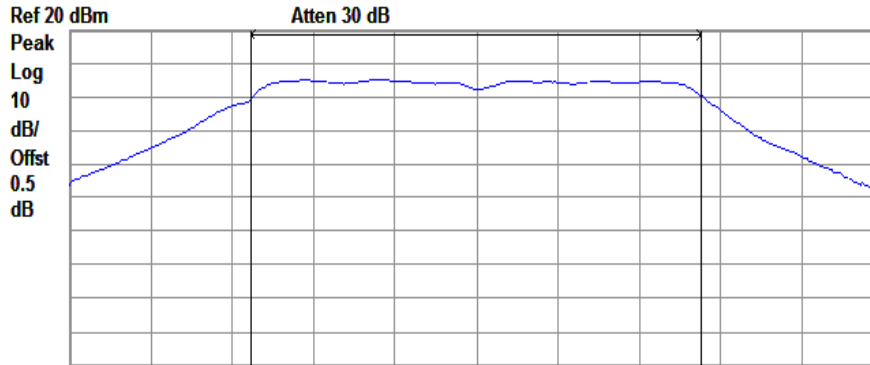

Center 2.437 GHz #VBW 3 MHz Sweep 4 ms (401 pts)
#Res BW 1 MHz

Channel Power Power Spectral Density
13.37 dBm / 16.5880 MHz -58.83 dBm/Hz



G-6 PK

Agilent 06:42:08 May 30, 2014 R T

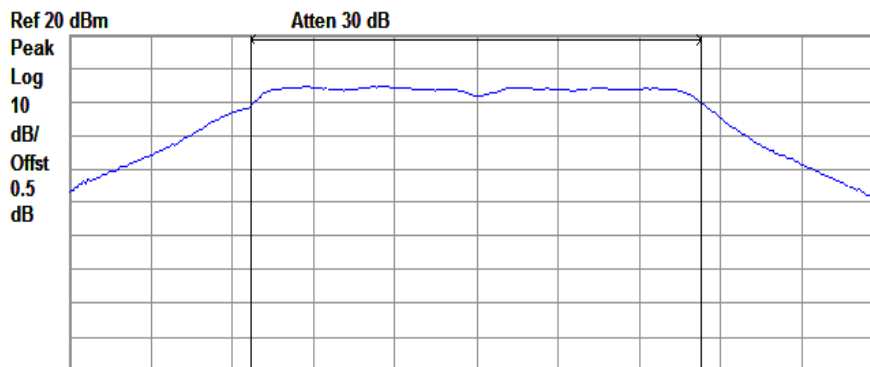

Center 2.462 GHz #VBW 3 MHz Sweep 4 ms (401 pts)
#Res BW 1 MHz

Channel Power Power Spectral Density
12.73 dBm / 16.5760 MHz -59.47 dBm/Hz



G-11 PK



SIEMIC, Inc.

Accessing global markets

Title: RF Test Report for Automotive diagnosis computer
Main Model: Creader professional229
Serial Model: CRP221, CRP223, CRP225, CRP226, CRP228, CRP229
To: FCC Part 15.247: 2013, ANSI C63.4: 2009

Report No.: 14070260-FCC-R1
Issue Date: June 18, 2014
Page: 27 of 76
www.siemec.com
www.siemec.com.cn

Agilent 07:06:06 May 30, 2014 R T

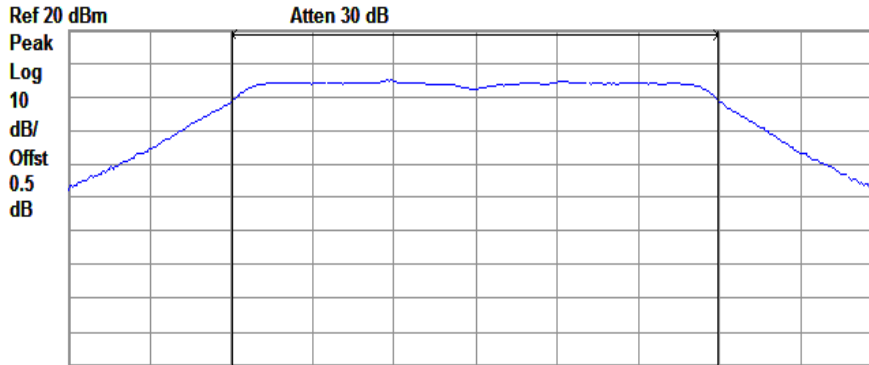

Center 2.412 GHz Span 30 MHz
#Res BW 1 MHz #VBW 3 MHz Sweep 4 ms (401 pts)

Channel Power Power Spectral Density
13.34 dBm / 17.8700 MHz -59.18 dBm/Hz



N-1 PK

Agilent 07:08:58 May 30, 2014 R T

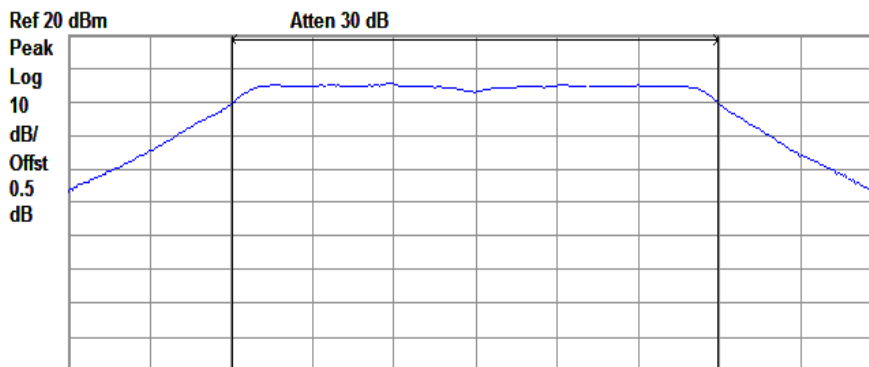

Center 2.437 GHz Span 30 MHz
#Res BW 1 MHz #VBW 3 MHz Sweep 4 ms (401 pts)

Channel Power Power Spectral Density
13.52 dBm / 17.8850 MHz -59.00 dBm/Hz



N-6 PK



SIEMIC, INC.

Accessing global markets

Title: RF Test Report for Automotive diagnosis computer
Main Model: Creader professional229
Serial Model: CRP221, CRP223, CRP225, CRP226, CRP228, CRP229
To: FCC Part 15.247: 2013, ANSI C63.4: 2009

Report No.: 14070260-FCC-R1
Issue Date: June 18, 2014
Page: 28 of 76
www.siemec.com
www.siemec.com.cn

Agilent 07:11:33 May 30, 2014 R T

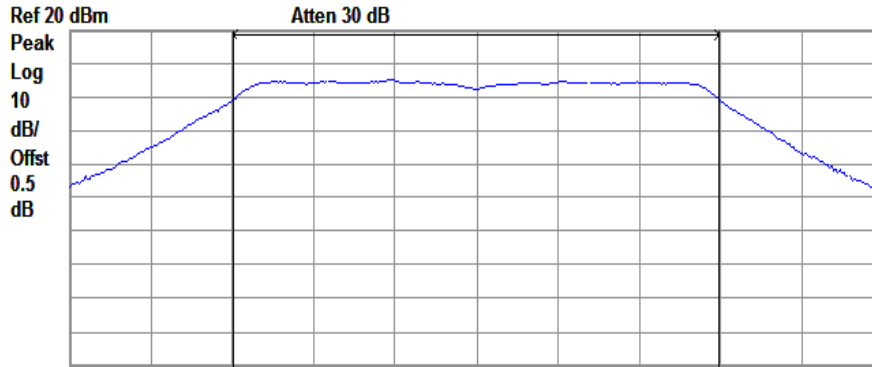

Center 2.462 GHz Span 30 MHz
#Res BW 1 MHz #VBW 3 MHz Sweep 4 ms (401 pts)

Channel Power

13.17 dBm / 17.8680 MHz

Power Spectral Density

-59.35 dBm/Hz



N-11 PK



SIEMIC, INC.

Accessing global markets

Title: RF Test Report for Automotive diagnosis computer
Main Model: Creader professional229
Serial Model: CRP221, CRP223, CRP225, CRP226, CRP228, CRP229
To: FCC Part 15.247: 2013, ANSI C63.4: 2009

Report No.: 14070260-FCC-R1
Issue Date: June 18, 2014
Page: 29 of 76
www.siemec.com
www.siemec.com.cn

The Average Power

Agilent 04:38:03 May 30, 2014 R T

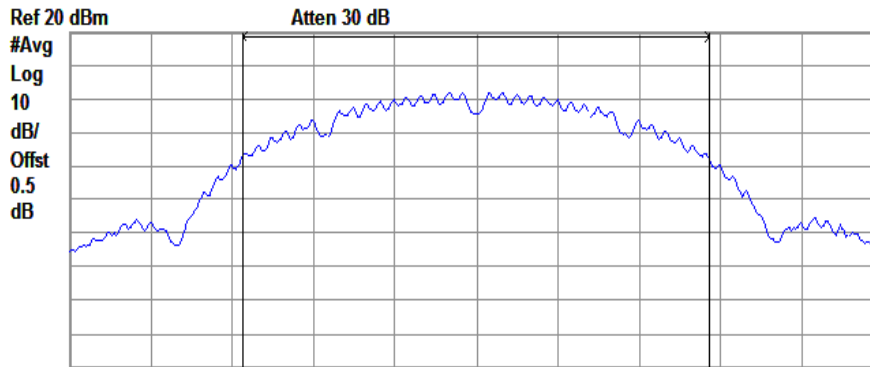

Center 2.412 GHz Span 30 MHz
#Res BW 300 kHz #VBW 1 MHz Sweep 8 ms (401 pts)

Channel Power

10.02 dBm / 17.1800 MHz

Power Spectral Density

-62.33 dBm/Hz



B-1 AV

Agilent 04:43:02 May 30, 2014 R T

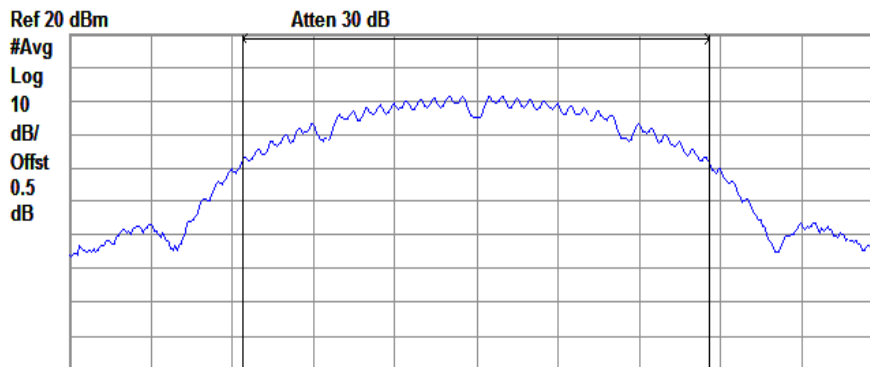

Center 2.437 GHz Span 30 MHz
#Res BW 300 kHz #VBW 1 MHz Sweep 8 ms (401 pts)

Channel Power

10.17 dBm / 17.1880 MHz

Power Spectral Density

-62.18 dBm/Hz



B-6 AV



SIEMIC, INC.

Accessing global markets

Title: RF Test Report for Automotive diagnosis computer
Main Model: Creader professional229
Serial Model: CRP221, CRP223, CRP225, CRP226, CRP228, CRP229
To: FCC Part 15.247: 2013, ANSI C63.4: 2009

Report No.: 14070260-FCC-R1
Issue Date: June 18, 2014
Page: 30 of 76
www.siemec.com
www.siemec.com.cn

Agilent 04:59:37 May 30, 2014 R T

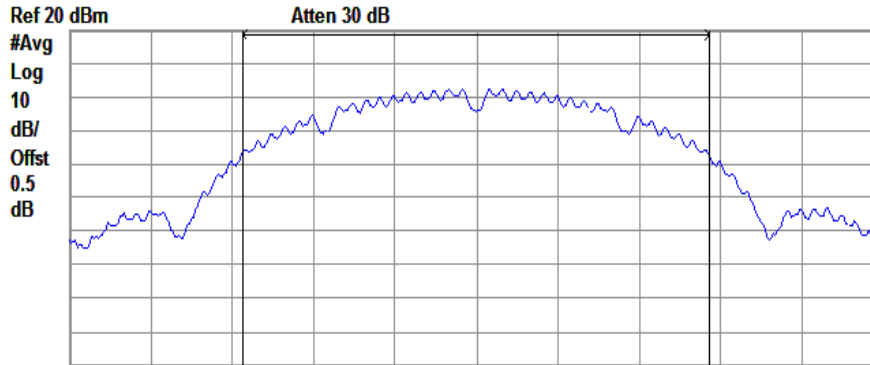

Center 2.462 GHz Span 30 MHz
#Res BW 300 kHz #VBW 1 MHz Sweep 8 ms (401 pts)

Channel Power Power Spectral Density
10.42 dBm / 17.1730 MHz -61.93 dBm/Hz



B-11 AV

Agilent 05:13:36 May 30, 2014 R T

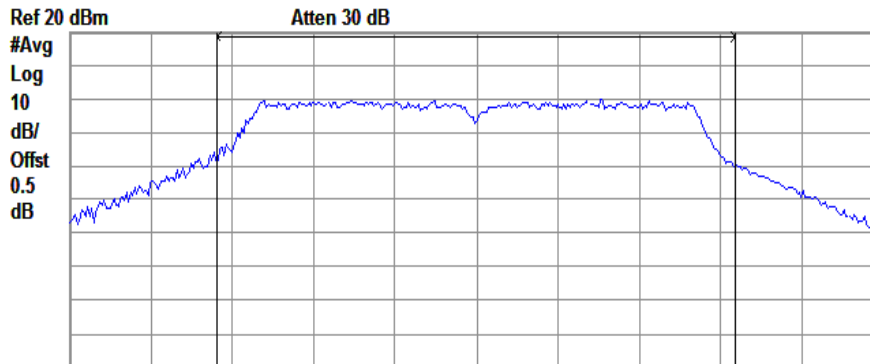

Center 2.412 GHz Span 30 MHz
#Res BW 300 kHz #VBW 1 MHz Sweep 8 ms (401 pts)

Channel Power Power Spectral Density
8.50 dBm / 19.0720 MHz -64.30 dBm/Hz



G-1 AV



SIEMIC, INC.

Accessing global markets

Title: RF Test Report for Automotive diagnosis computer
Main Model: Creader professional229
Serial Model: CRP221, CRP223, CRP225, CRP226, CRP228, CRP229
To: FCC Part 15.247: 2013, ANSI C63.4: 2009

Report No.: 14070260-FCC-R1
Issue Date: June 18, 2014
Page: 31 of 76
www.siemec.com
www.siemec.com.cn

Agilent 05:32:37 May 30, 2014 R T

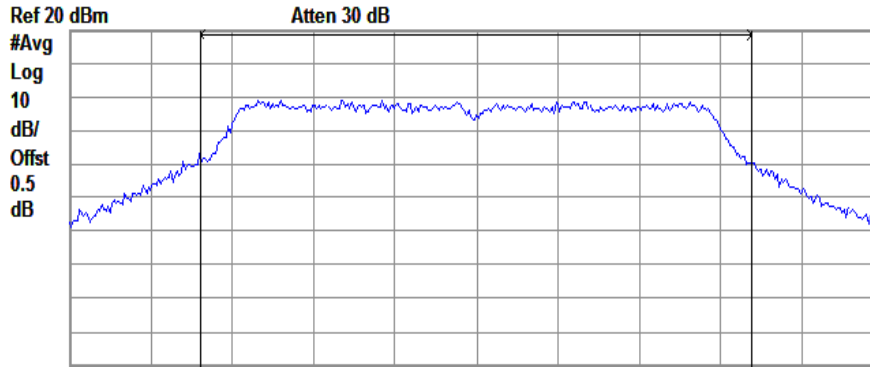

Center 2.437 GHz Span 30.01 MHz
#Res BW 300 kHz #VBW 1 MHz Sweep 8 ms (401 pts)

Channel Power Power Spectral Density
8.31 dBm / 20.2730 MHz -64.76 dBm/Hz



G-6 AV

Agilent 05:22:53 May 30, 2014 R T

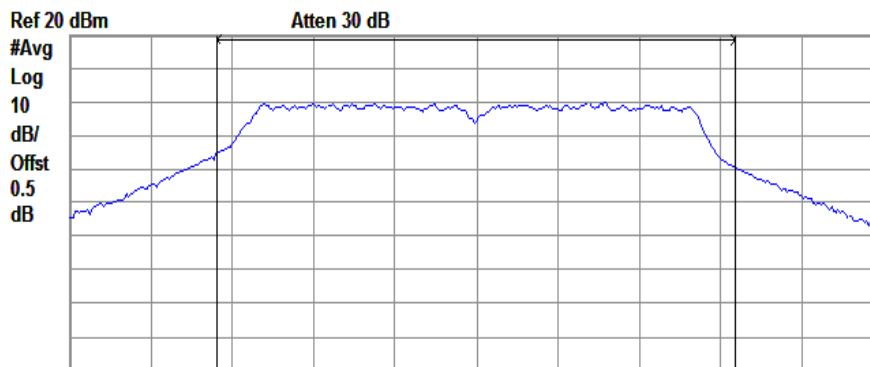

Center 2.462 GHz Span 30 MHz
#Res BW 300 kHz #VBW 1 MHz Sweep 8 ms (401 pts)

Channel Power Power Spectral Density
8.32 dBm / 19.0590 MHz -64.48 dBm/Hz



G-11 AV



SIEMIC, INC.

Accessing global markets

Title: RF Test Report for Automotive diagnosis computer
Main Model: Creader professional229
Serial Model: CRP221, CRP223, CRP225, CRP226, CRP228, CRP229
To: FCC Part 15.247: 2013, ANSI C63.4: 2009

Report No.: 14070260-FCC-R1
Issue Date: June 18, 2014
Page: 32 of 76
www.siemec.com
www.siemec.com.cn

Agilent 05:35:10 May 30, 2014 R T

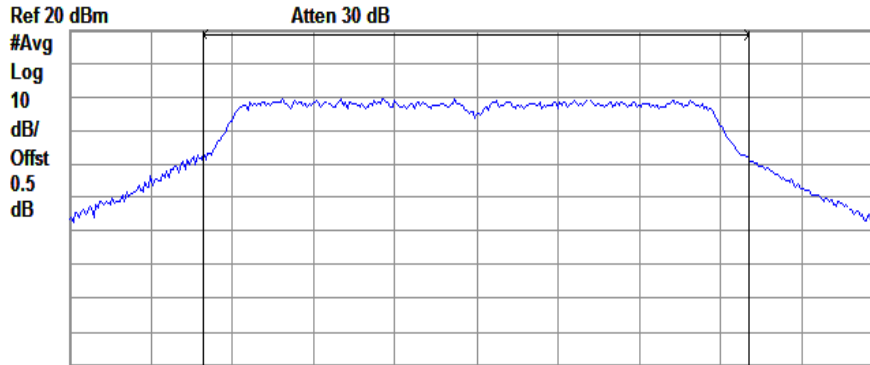

Center 2.412 GHz Span 30 MHz
#Res BW 300 kHz #VBW 1 MHz Sweep 8 ms (401 pts)

Channel Power Power Spectral Density
8.39 dBm / 20.0830 MHz -64.64 dBm/Hz



N-1 AV

Agilent 07:16:51 May 30, 2014 R T

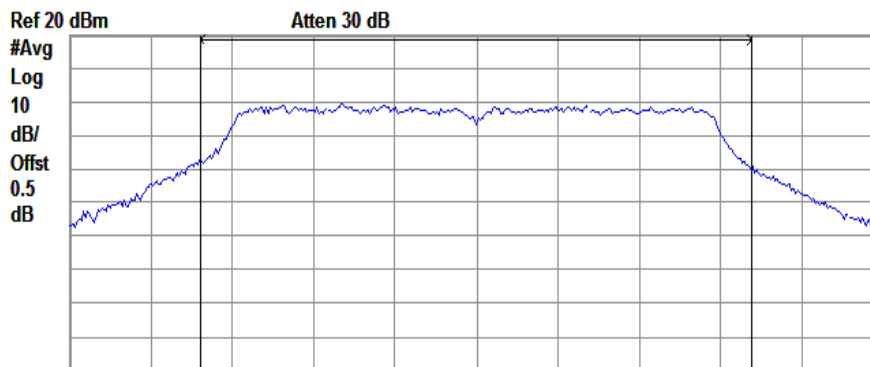

Center 2.437 GHz Span 30 MHz
#Res BW 300 kHz #VBW 1 MHz Sweep 8 ms (401 pts)

Channel Power Power Spectral Density
8.22 dBm / 20.2730 MHz -64.85 dBm/Hz



N-6 AV



SIEMIC, INC.

Accessing global markets

Title: RF Test Report for Automotive diagnosis computer
Main Model: Creader professional229
Serial Model: CRP221, CRP223, CRP225, CRP226, CRP228, CRP229
To: FCC Part 15.247: 2013, ANSI C63.4: 2009

Report No.: 14070260-FCC-R1
Issue Date: June 18, 2014
Page: 33 of 76
www.siemec.com
www.siemec.com.cn

Agilent 05:30:26 May 30, 2014

R T

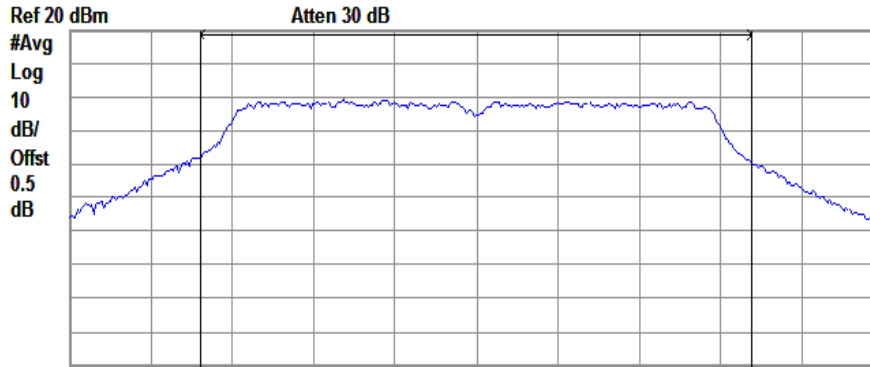

Center 2.462 GHz Span 30 MHz
#Res BW 300 kHz #VBW 1 MHz Sweep 8 ms (401 pts)

Channel Power

Power Spectral Density

8.32 dBm / 20.2640 MHz

-64.75 dBm/Hz

N-11 AV

5.4 §15.247(e) - Power Spectral Density

1. **Conducted Measurement**
EUT was set for low, mid, high channel with modulated mode and highest RF output power.
The spectrum analyzer was connected to the antenna terminal.
2. **Environmental Conditions**

Temperature	23°C
Relative Humidity	57%
Atmospheric Pressure	1020mbar
3. **Conducted Emissions Measurement Uncertainty**
All test measurements carried out are traceable to national standards. The uncertainty of the measurement at a confidence level of approximately 95% (in the case where distributions are normal), with a coverage factor of 2, in the range 30MHz – 40GHz is ±1.5dB.
4. **Test date :** May 30, 2014
Tested By : Herith Shi

Requirement(s):

A conducted power spectral density (PSD) limit of 8 dBm in any 3 kHz band segment within the DTS bandwidth is specified during any time interval of continuous transmission. By rule, the same method as used to determine the conducted output power shall be used to determine the power spectral density (i.e., if maximum peak conducted output power was measured then the peak PSD procedure shall be used and if maximum conducted output power was measured then the average PSD procedure shall be used).

If the average PSD is measured with a power averaging (RMS) detector or a sample detector, then the spectrum analyzer must be capable of utilizing a number of measurement points in each sweep that is greater than or equal to twice the span/RBW in order to ensure bin-to-bin spacing of $\leq \text{RBW}/2$ so that narrowband signals are not lost between frequency bins.

Procedures:

This procedure must be used if maximum peak conducted output power was used to demonstrate compliance to the fundamental output power limit, and is optional if the maximum (average) conducted output power was used to demonstrate compliance.

1. Set analyzer center frequency to DTS channel center frequency.
2. Set the span to 1.5 times the DTS channel bandwidth.
3. Set the RBW ≥ 3 kHz.
4. Set the VBW $\geq 3 \times$ RBW.
5. Detector = peak.
6. Sweep time = auto couple.
7. Trace mode = max hold.
8. Allow trace to fully stabilize.
9. Use the peak marker function to determine the maximum amplitude level.
10. If measured value exceeds limit, reduce RBW (no less than 3 kHz) and repeat.

Test Result: Pass.

Please refer to the following tables and plots.

Note:

B: 802.11b
G: 802.11g
N20: 802.11n (HT20)

1: Low Channel
6: Middle Channel
11: High Channel

Channel	Frequency (MHz)	Data Rate	PSD (dBm)	Limit (dBm)
802.11b mode				
Low	2412	1	1.648	8
Middle	2437	1	1.196	8
High	2462	1	0.690	8
802.11g mode				
Low	2412	6	-4.511	8
Middle	2437	6	-5.322	8
High	2462	6	-5.957	8
802.11n(HT20) mode				
Low	2412	MCS0	-5.156	8
Middle	2437	MCS0	-5.805	8
High	2462	MCS0	-5.968	8



SIEMIC, INC.

Accessing global markets

Title: RF Test Report for Automotive diagnosis computer
Main Model: Creader professional229
Serial Model: CRP221, CRP223, CRP225, CRP226, CRP228, CRP229
To: FCC Part 15.247: 2013, ANSI C63.4: 2009

Report No.: 14070260-FCC-R1
Issue Date: June 18, 2014
Page: 36 of 76
www.siemic.com
www.siemic.com.cn

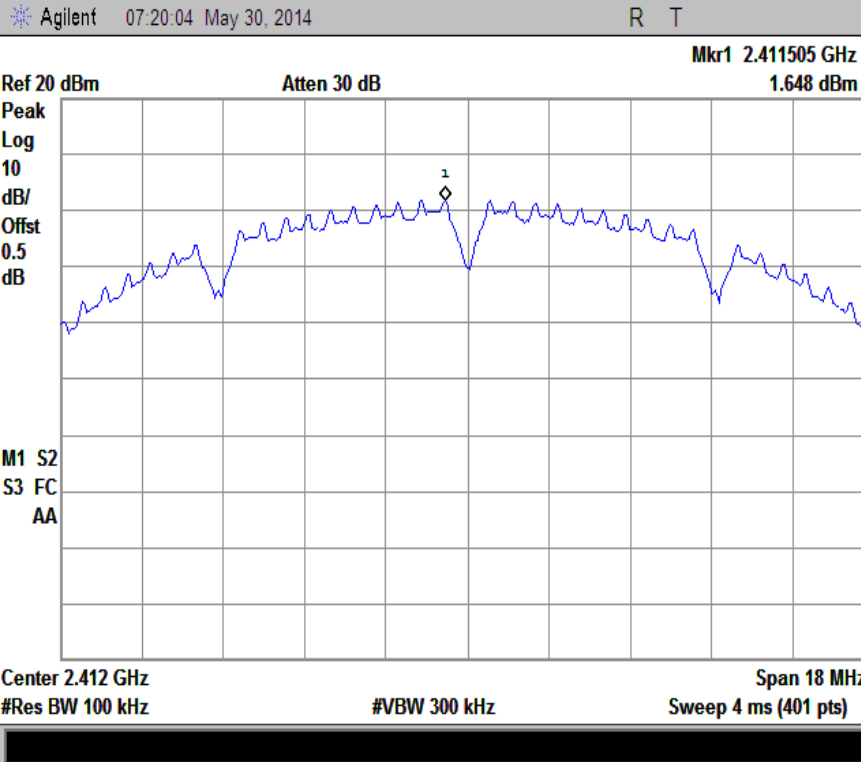

B-1

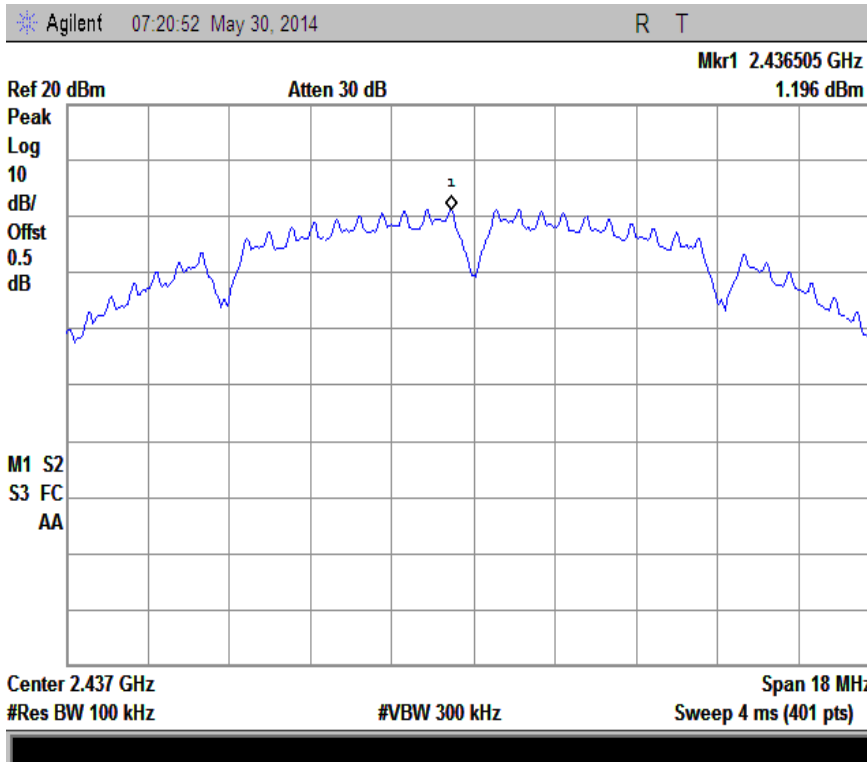

B-6



SIEMIC, INC.

Accessing global markets

Title: RF Test Report for Automotive diagnosis computer
Main Model: Creader professional229
Serial Model: CRP221, CRP223, CRP225, CRP226, CRP228, CRP229
To: FCC Part 15.247: 2013, ANSI C63.4: 2009

Report No.: 14070260-FCC-R1
Issue Date: June 18, 2014
Page: 37 of 76
www.siemec.com
www.siemec.com.cn

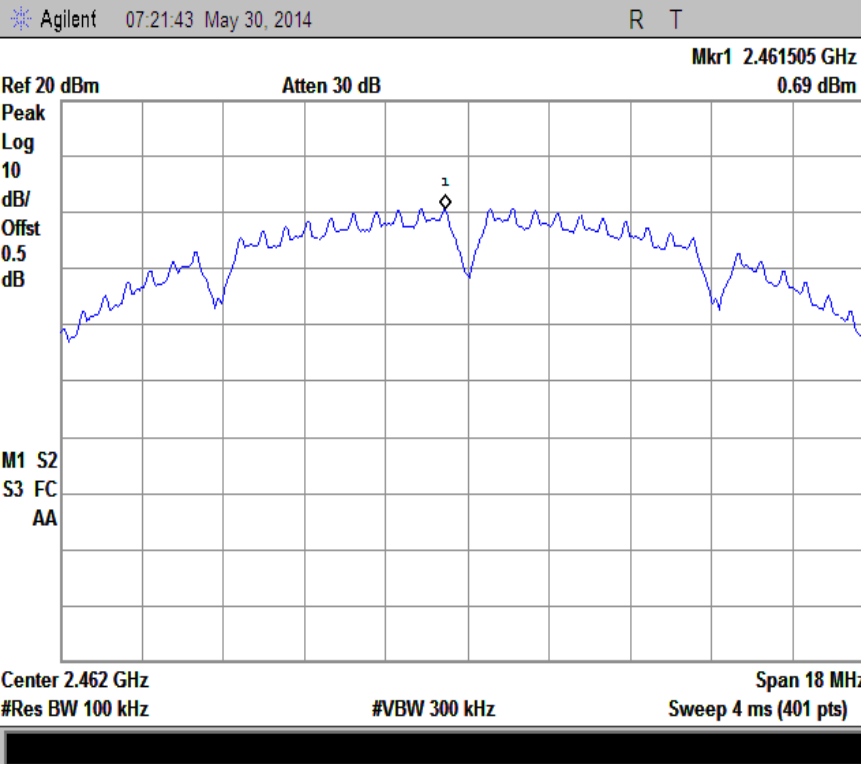

B-11

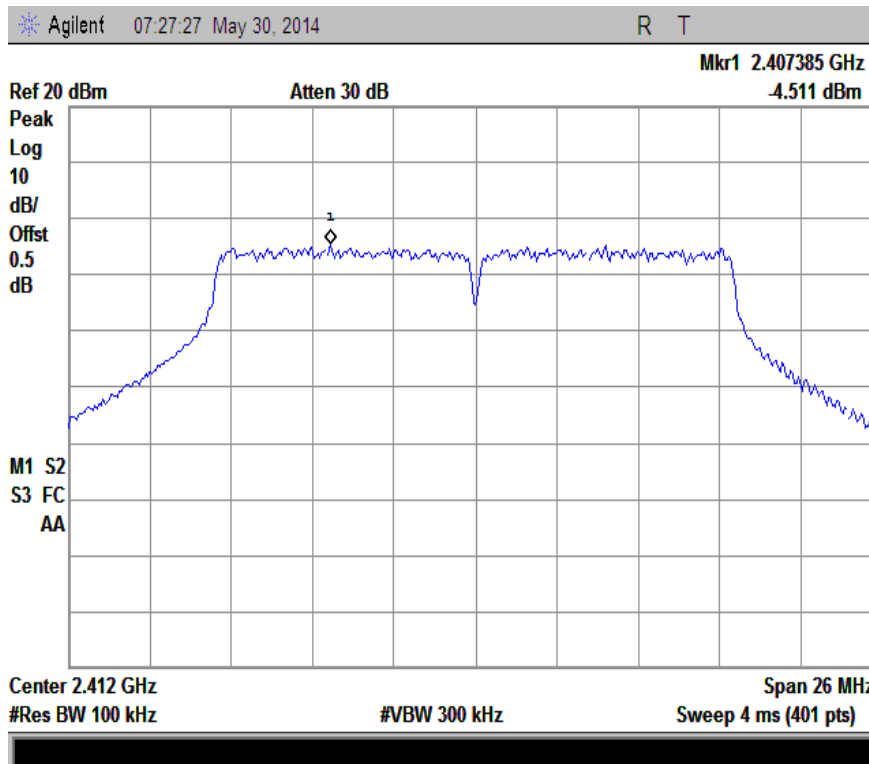

G-1



SIEMIC, INC.

Accessing global markets

Title: RF Test Report for Automotive diagnosis computer
Main Model: Creader professional229
Serial Model: CRP221, CRP223, CRP225, CRP226, CRP228, CRP229
To: FCC Part 15.247: 2013, ANSI C63.4: 2009

Report No.: 14070260-FCC-R1
Issue Date: June 18, 2014
Page: 38 of 76
www.siemec.com
www.siemec.com.cn

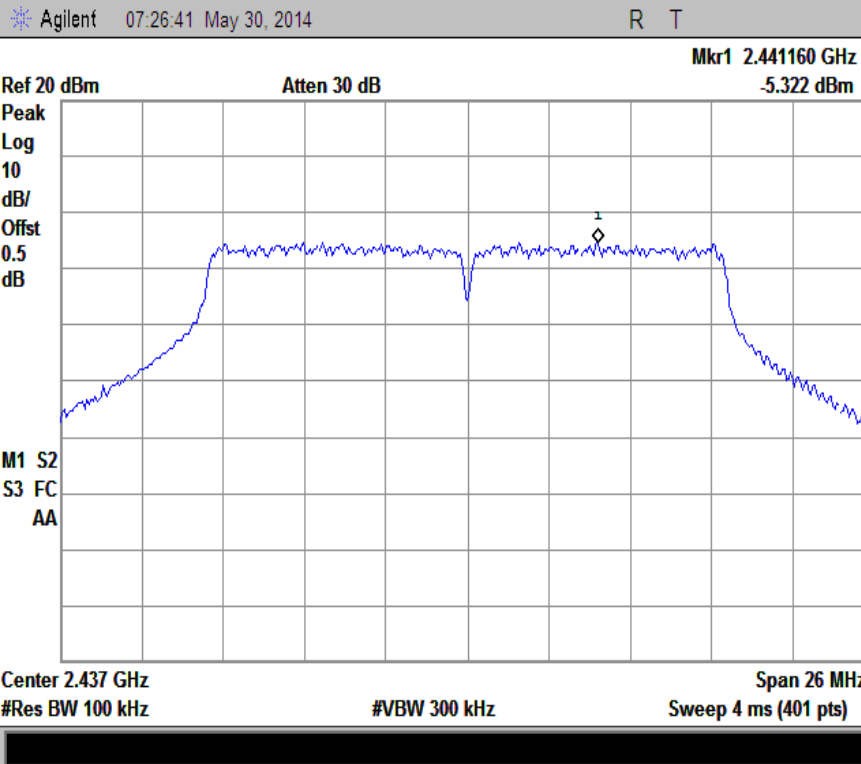

G-6

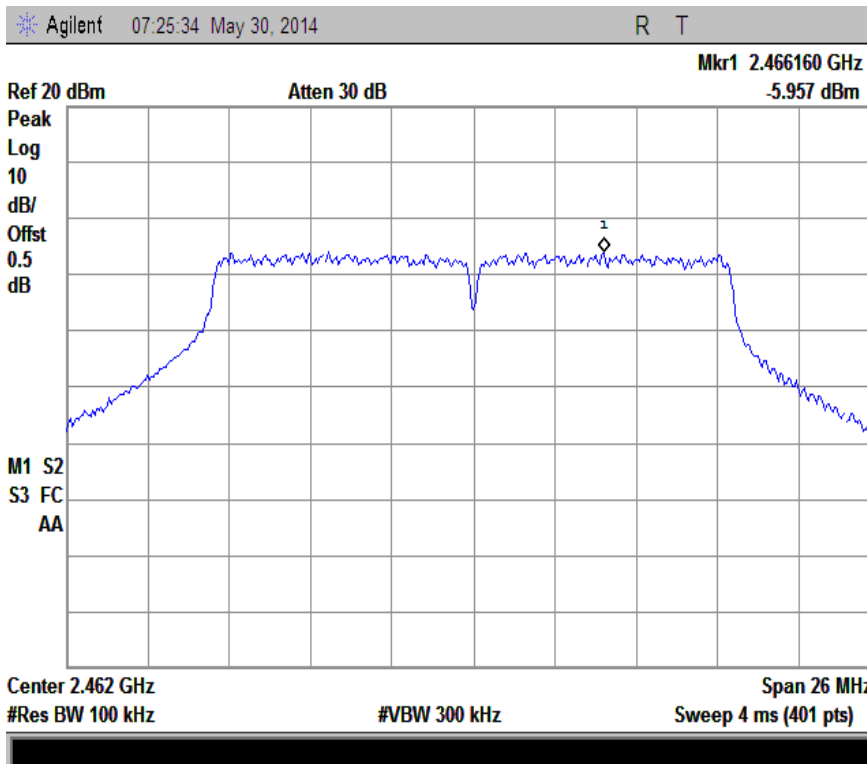

G-11



SIEMIC, INC.

Accessing global markets

Title: RF Test Report for Automotive diagnosis computer
Main Model: Creader professional229
Serial Model: CRP221, CRP223, CRP225, CRP226, CRP228, CRP229
To: FCC Part 15.247: 2013, ANSI C63.4: 2009

Report No.: 14070260-FCC-R1
Issue Date: June 18, 2014
Page: 39 of 76
www.siemec.com
www.siemec.com.cn

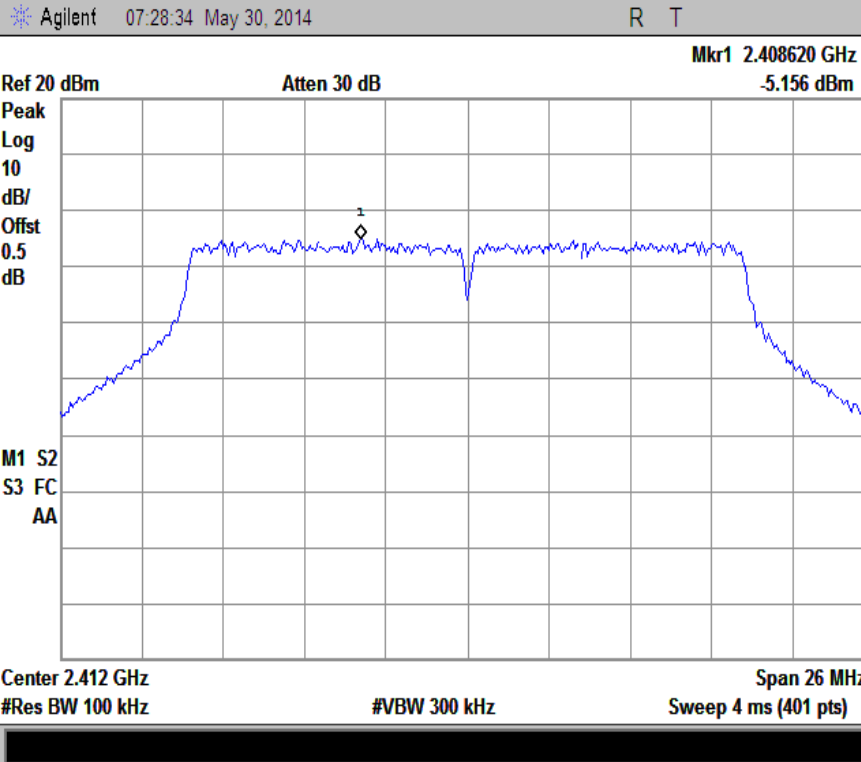

N20-1

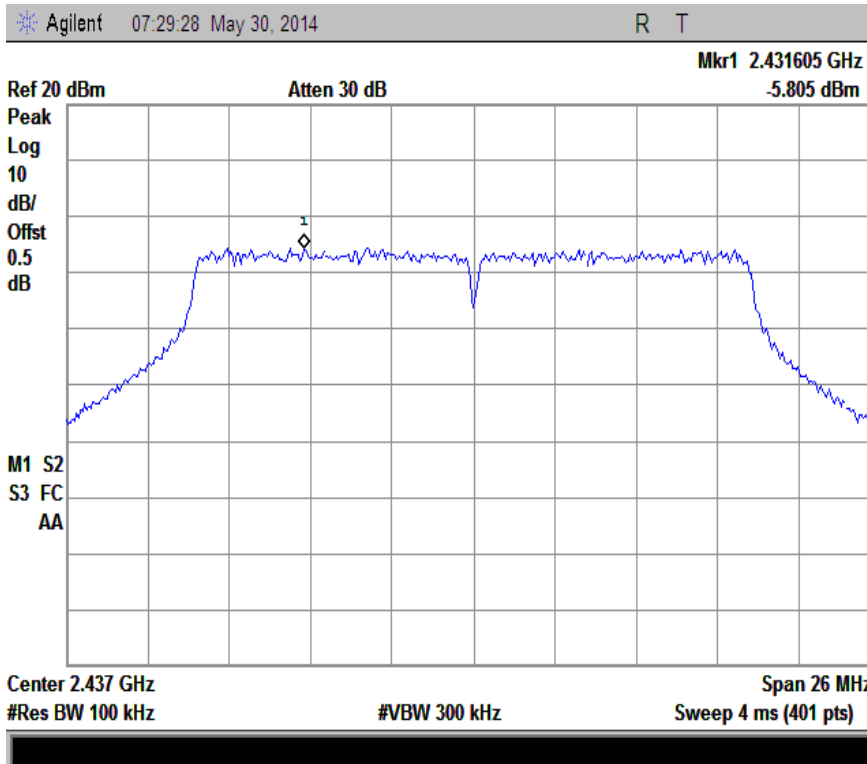

N20-6



SIEMIC, INC.

Accessing global markets

Title: RF Test Report for Automotive diagnosis computer
Main Model: Creader professional229
Serial Model: CRP221, CRP223, CRP225, CRP226, CRP228, CRP229
To: FCC Part 15.247: 2013, ANSI C63.4: 2009

Report No.: 14070260-FCC-R1
Issue Date: June 18, 2014
Page: 40 of 76
www.siemec.com
www.siemec.com.cn

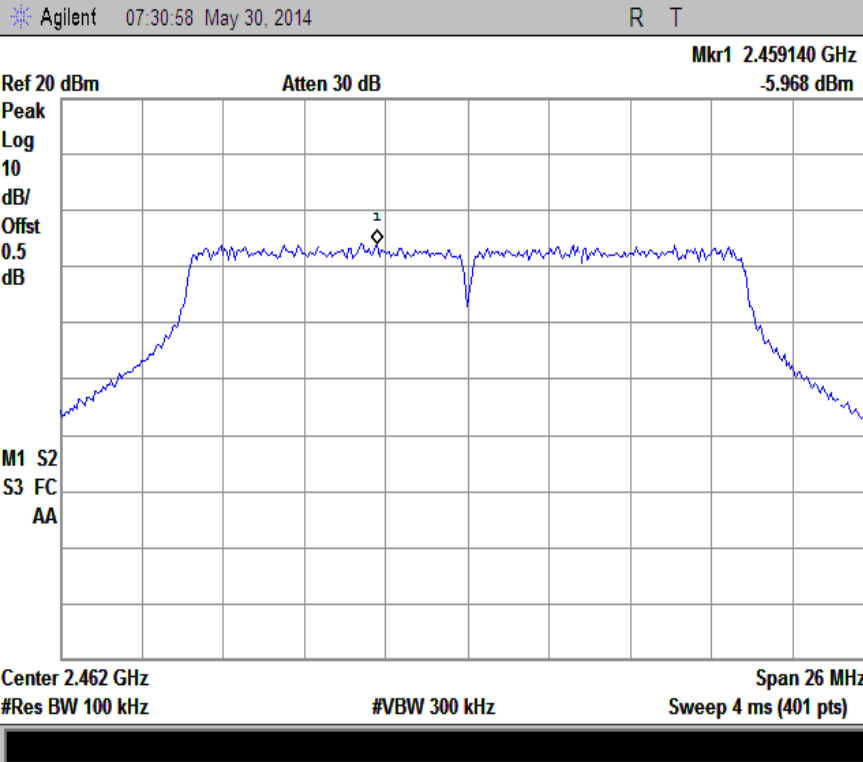

N20-11

5.5 §15.247(d) –Band-Edge & Unwanted Emissions into Non-Restricted Frequency Bands

1. In any 100 kHz bandwidth outside the frequency band in which the spread spectrum or digitally modulated intentional radiator is operating, the radio frequency power that is produced by the intentional radiator shall be at least 20 dB below that in the 100 kHz bandwidth within the band that contains the highest level of the desired power, based on either an RF conducted or a radiated measurement, provided the transmitter demonstrates compliance with the peak conducted power limits. If the transmitter complies with the conducted power limits based on the use of RMS averaging over a time interval, as permitted under paragraph (b)(3) of this section, the attenuation required under this paragraph shall be 30 dB instead of 20 dB. Attenuation below the general limits specified in §15.209(a) is not required. In addition, radiated emissions which fall in the restricted bands, as defined in §15.205(a), must also comply with the radiated emission limits specified in §15.209(a) (see §15.205(c))
2. Environmental Conditions

Temperature	24°C
Relative Humidity	59%
Atmospheric Pressure	1010mbar
3. Test date : June 18, 2014
Tested By : Herith Shi

Requirement(s):

Band-Edge Measurements

An additional consideration when performing conducted measurements of restricted band emissions is that unwanted emissions radiating from the EUT cabinet, control circuits, power leads, or intermediate circuit elements will likely go undetected in a conducted measurement configuration. To address this concern, a radiated test shall be performed to ensure that emissions emanating from the EUT cabinet (rather than the antenna port) also comply with the applicable limits.

For these cabinet radiated spurious emission measurements the EUT transmit antenna may be replaced with a termination matching the nominal impedance of the antenna. Procedures for performing radiated measurements are specified in ANSI C63.10. All detected emissions shall comply with the applicable limits.

Procedures: (Radiated Method Only)

1. Check the calibration of the measuring instrument using either an internal calibrator or a known signal from an external generator.
2. Position the EUT without connection to measurement instrument. Put it on the Rotated table and turn on the EUT and make it operate in transmitting mode. Then set it to Low Channel and High Channel within its operating range, and make sure the instrument is operated in its linear range.
3. First, set both RBW and VBW of spectrum analyzer to 100 kHz with a convenient frequency span including 100kHz bandwidth from band edge, check the emission of EUT, if pass then set Spectrum Analyzer as below:
 - a. The resolution bandwidth and video bandwidth of test receiver/spectrum analyzer is 120 kHz for Quasiy Peak detection at frequency below 1GHz.
 - b. The resolution bandwidth of test receiver/spectrum analyzer is 1MHz and video bandwidth is 3MHz for Peak detection at frequency above 1GHz.
 - c. The resolution bandwidth of test receiver/spectrum analyzer is 1MHz and the video bandwidth for Average detection (AV) as below at frequency above 1GHz.

<input type="checkbox"/> 1 kHz (Duty cycle < 98%)	<input checked="" type="checkbox"/> 10 Hz (Duty cycle > 98%)
---	--
4. Measure the highest amplitude appearing on spectral display and set it as a reference level. Plot the graph with marking the highest point and edge frequency.
5. Repeat above procedures until all measured frequencies were complete.

Note:

For Hopping device, should test hopping mode and CW Tx mode separately. For hopping mode, find out the worst points outside the frequency band firstly, then set the worst points as the center frequency, use above average 3 (c) spectrum analyzer set, find out the final worst average value separately.

Test Result: Pass.

Please refer to the following tables and plots.

Note:

B: 802.11b

G: 802.11g

N: 802.11n (HT20)

l: Left Side

ll: Right Side



SIEMIC, INC.

Accessing global markets

Title: RF Test Report for Automotive diagnosis computer
Main Model: Creader professional229
Serial Model: CRP221, CRP223, CRP225, CRP226, CRP228, CRP229
To: FCC Part 15.247: 2013, ANSI C63.4: 2009

Report No.: 14070260-FCC-R1
Issue Date: June 18, 2014
Page: 43 of 76
www.siemec.com
www.siemec.com.cn

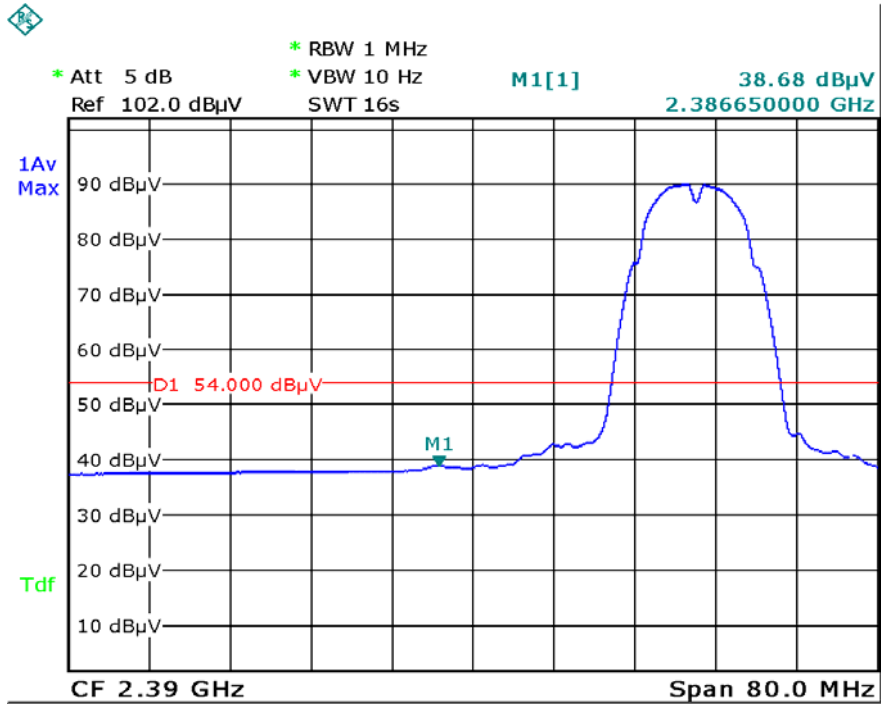

Date: 18.JUN.2014 16:42:10

B-1 AV

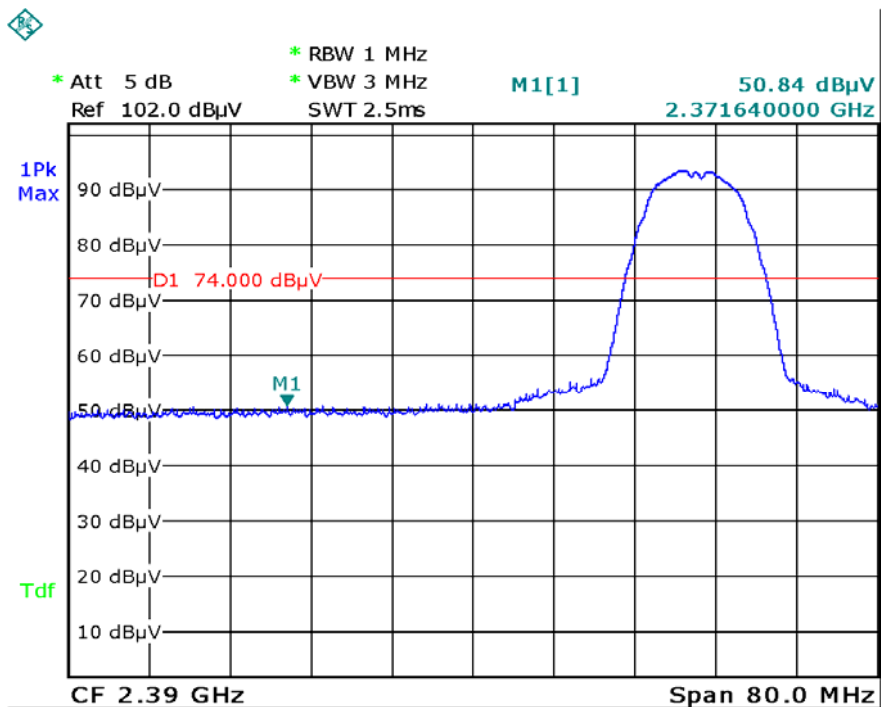

Date: 18.JUN.2014 16:41:05

B-1 PK



SIEMIC, INC.

Accessing global markets

Title: RF Test Report for Automotive diagnosis computer
Main Model: Creader professional229
Serial Model: CRP221, CRP223, CRP225, CRP226, CRP228, CRP229
To: FCC Part 15.247: 2013, ANSI C63.4: 2009

Report No.: 14070260-FCC-R1
Issue Date: June 18, 2014
Page: 44 of 76
www.siemec.com
www.siemec.com.cn

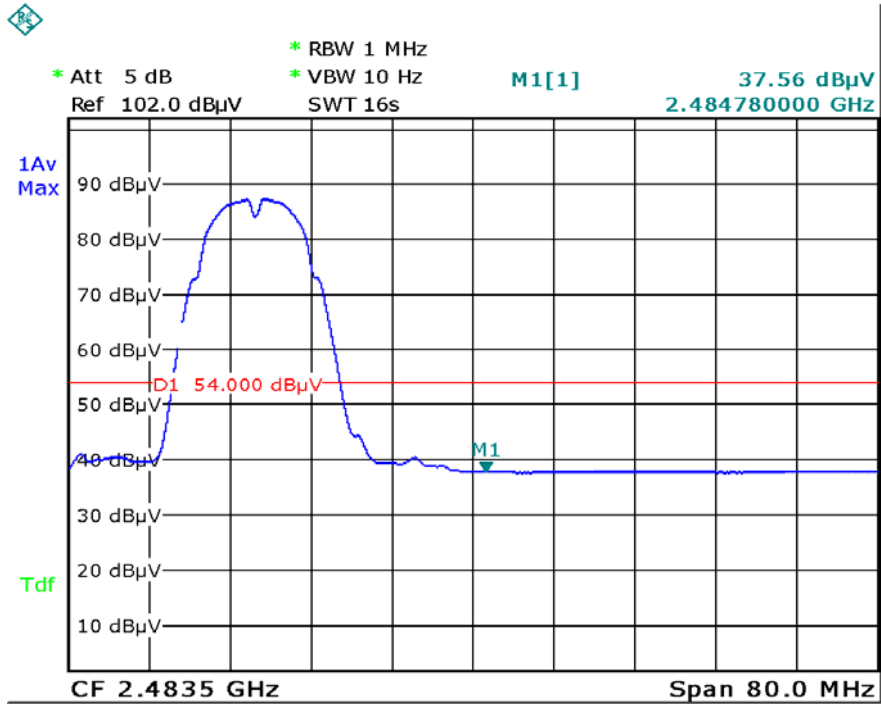

Date: 18.JUN.2014 16:46:29

B-11 AV

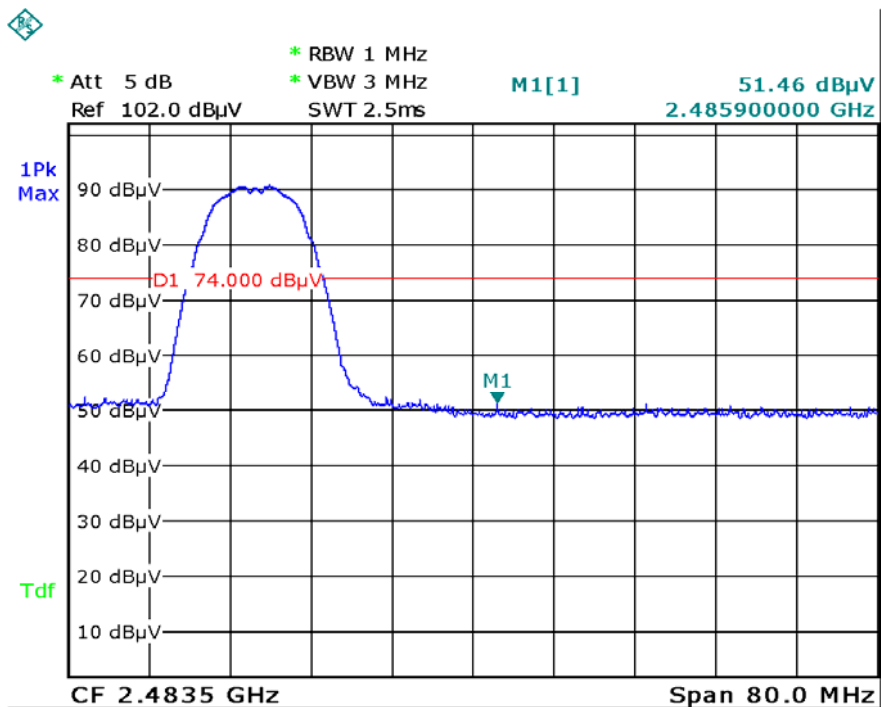

Date: 18.JUN.2014 16:47:58

B-11 PK



SIEMIC, INC.

Accessing global markets

Title: RF Test Report for Automotive diagnosis computer
Main Model: Creader professional229
Serial Model: CRP221, CRP223, CRP225, CRP226, CRP228, CRP229
To: FCC Part 15.247: 2013, ANSI C63.4: 2009

Report No.: 14070260-FCC-R1
Issue Date: June 18, 2014
Page: 45 of 76
www.siemic.com
www.siemic.com.cn

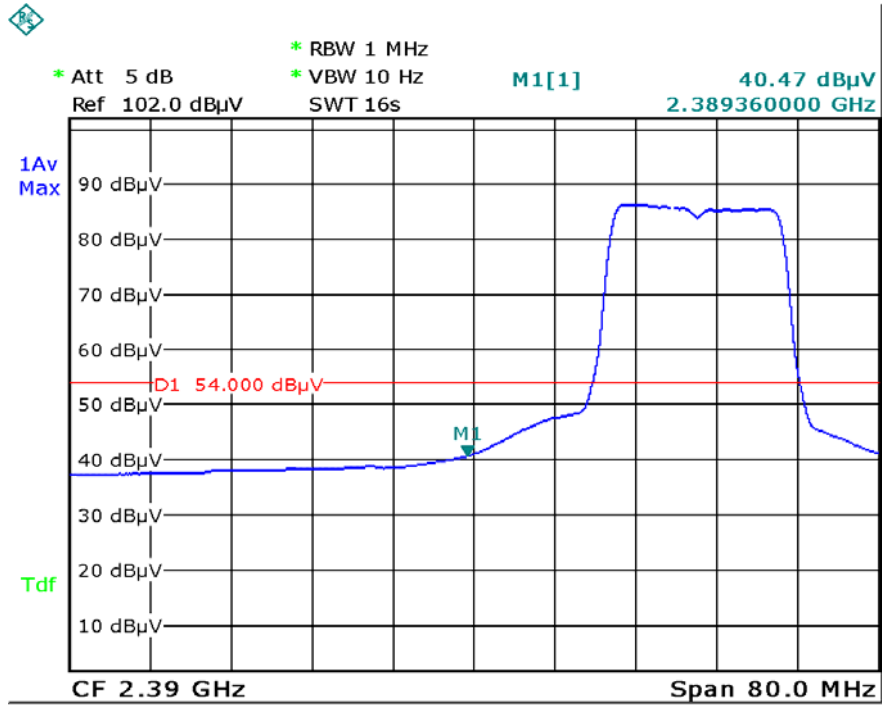

Date: 18.JUN.2014 15:58:49

G-1 AV

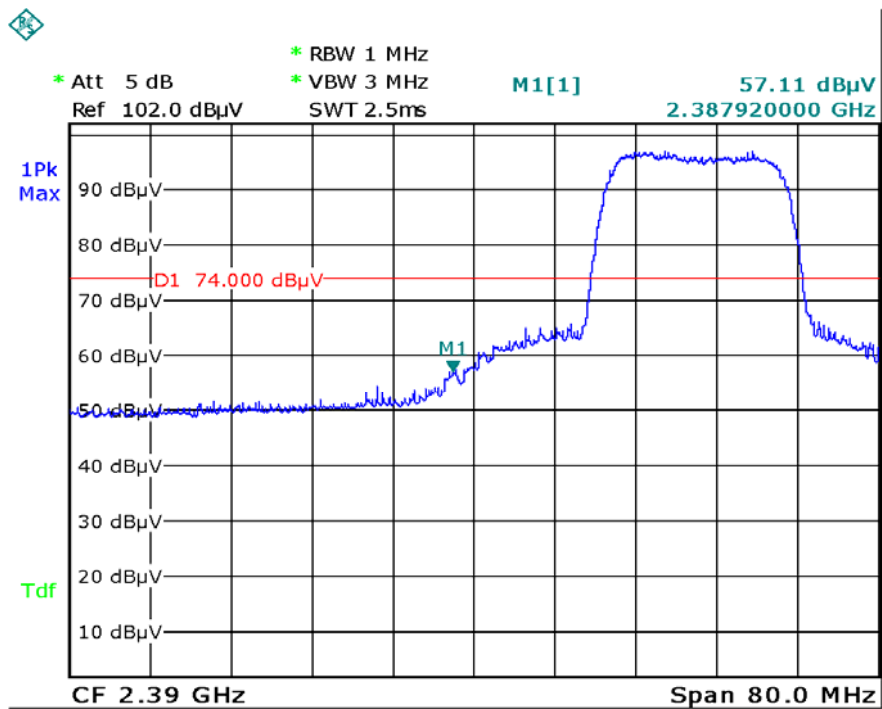

Date: 18.JUN.2014 16:02:05

G-1 PK



SIEMIC, INC.

Accessing global markets

Title: RF Test Report for Automotive diagnosis computer
Main Model: Creader professional229
Serial Model: CRP221, CRP223, CRP225, CRP226, CRP228, CRP229
To: FCC Part 15.247: 2013, ANSI C63.4: 2009

Report No.: 14070260-FCC-R1
Issue Date: June 18, 2014
Page: 46 of 76
www.siemec.com
www.siemec.com.cn

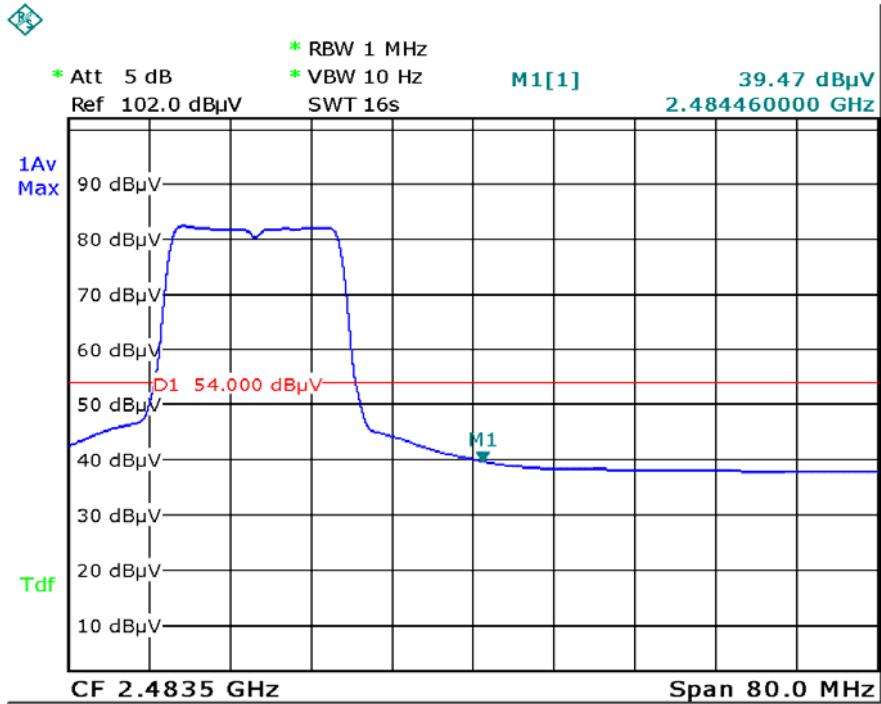

Date: 18.JUN.2014 15:55:13

G-11 AV

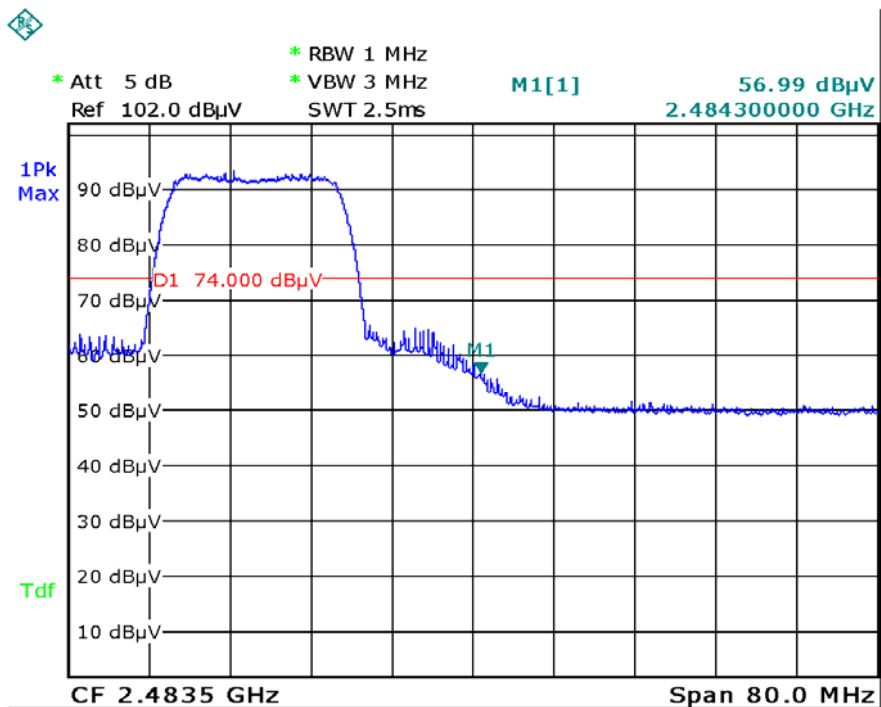

Date: 18.JUN.2014 15:53:51

G-11 PK



SIEMIC, INC.

Accessing global markets

Title: RF Test Report for Automotive diagnosis computer
Main Model: Creader professional229
Serial Model: CRP221, CRP223, CRP225, CRP226, CRP228, CRP229
To: FCC Part 15.247: 2013, ANSI C63.4: 2009

Report No.: 14070260-FCC-R1
Issue Date: June 18, 2014
Page: 47 of 76
www.siemec.com
www.siemec.com.cn

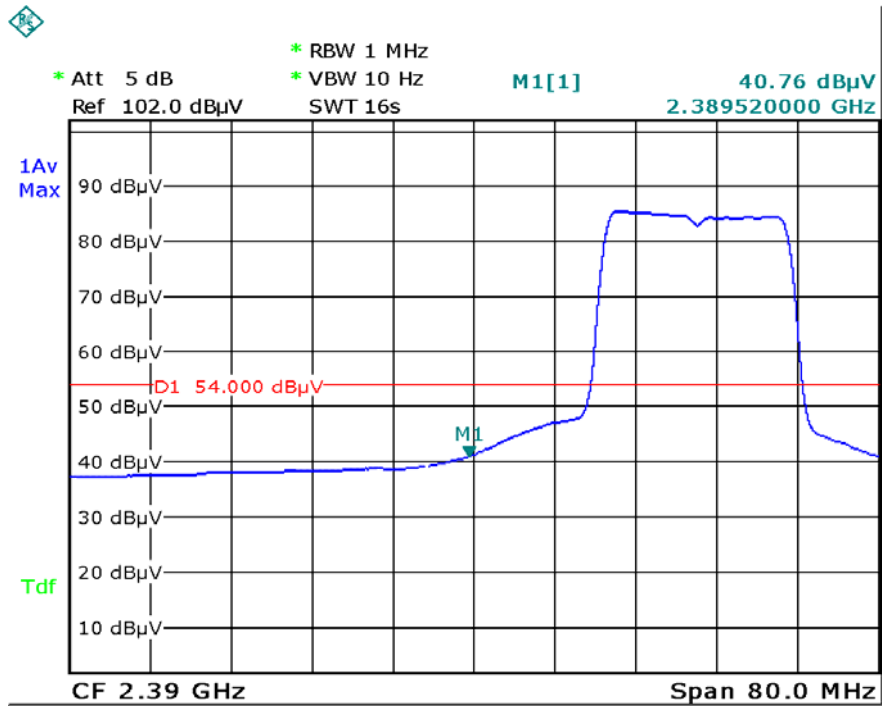

Date: 18.JUN.2014 16:06:14

N-1 AV

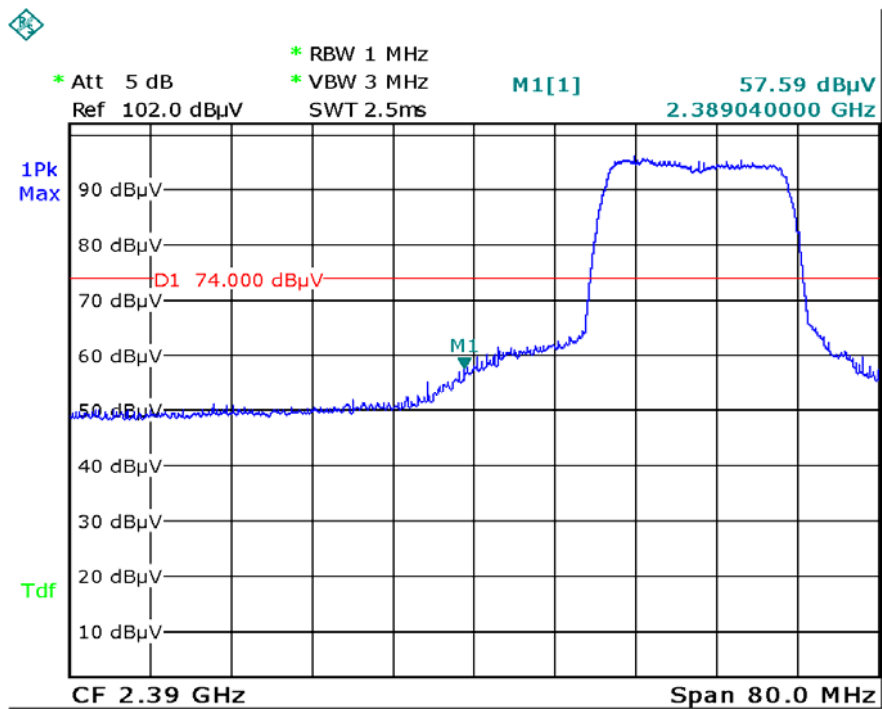

Date: 18.JUN.2014 16:04:55

N-1 PK



SIEMIC, INC.

Accessing global markets

Title: RF Test Report for Automotive diagnosis computer
Main Model: Creader professional229
Serial Model: CRP221, CRP223, CRP225, CRP226, CRP228, CRP229
To: FCC Part 15.247: 2013, ANSI C63.4: 2009

Report No.: 14070260-FCC-R1
Issue Date: June 18, 2014
Page: 48 of 76
www.siemec.com
www.siemec.com.cn

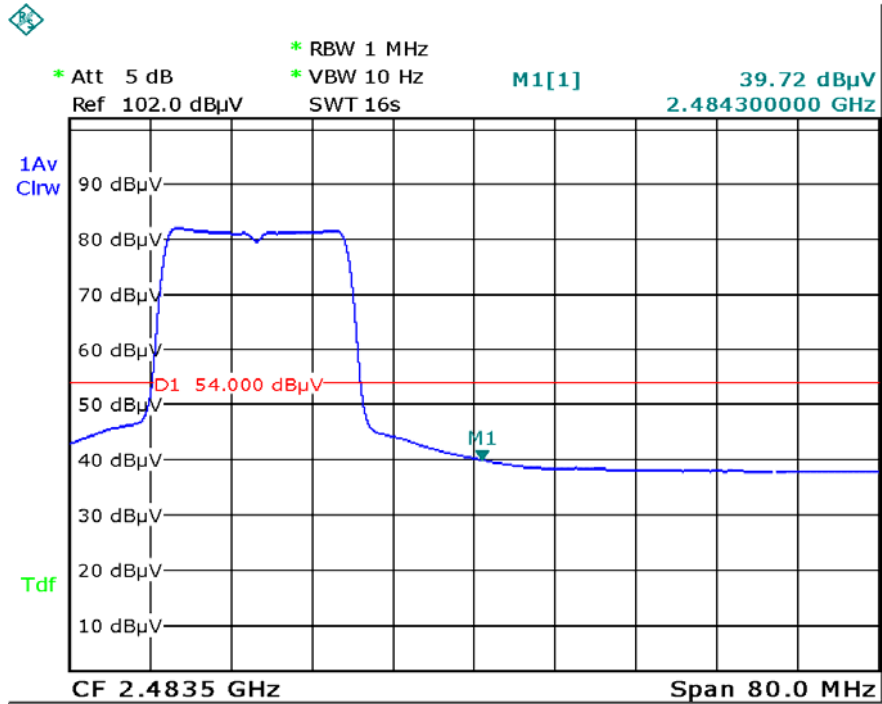

Date: 18.JUN.2014 16:09:26

N-11 AV

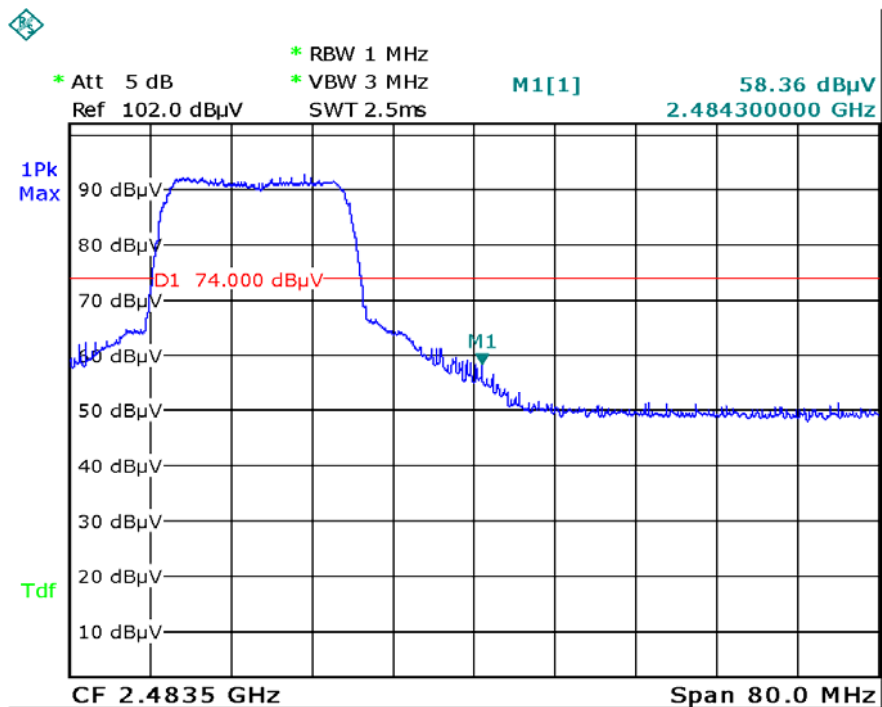

Date: 18.JUN.2014 16:11:00

N-11 PK

5.6 §15.207 (a) - AC Power Line Conducted Emissions

Requirement:

Frequency of emission (MHz)	Conducted limit (dBμV)	
	Quasi-peak	Average
0.15–0.5	66 to 56*	56 to 46*
0.5–5	56	46
5–30	60	50

*Decreases with the logarithm of the frequency.

Procedures:

1. All possible modes of operation were investigated. Only the 6 worst case emissions measured, using the correct CISPR and Average detectors, are reported. All other emissions were relatively insignificant.
2. A "-ve" margin indicates a PASS as it refers to the margin present below the limit line at the particular frequency.
3. Conducted Emissions Measurement Uncertainty
 All test measurements carried out are traceable to national standards. The uncertainty of the measurement at a confidence level of approximately 95% (in the case where distributions are normal), with a coverage factor of 2, in the range 9kHz – 30MHz (Average & Quasi-peak) is ±3.5dB.
4. Environmental Conditions

Temperature	23°C
Relative Humidity	55%
Atmospheric Pressure	1019 mbar
5. Test date: May 26, 2014
 Tested By : Herith Shi

Test Mode:	Transmitting Mode(Worse Case)
-------------------	--------------------------------------

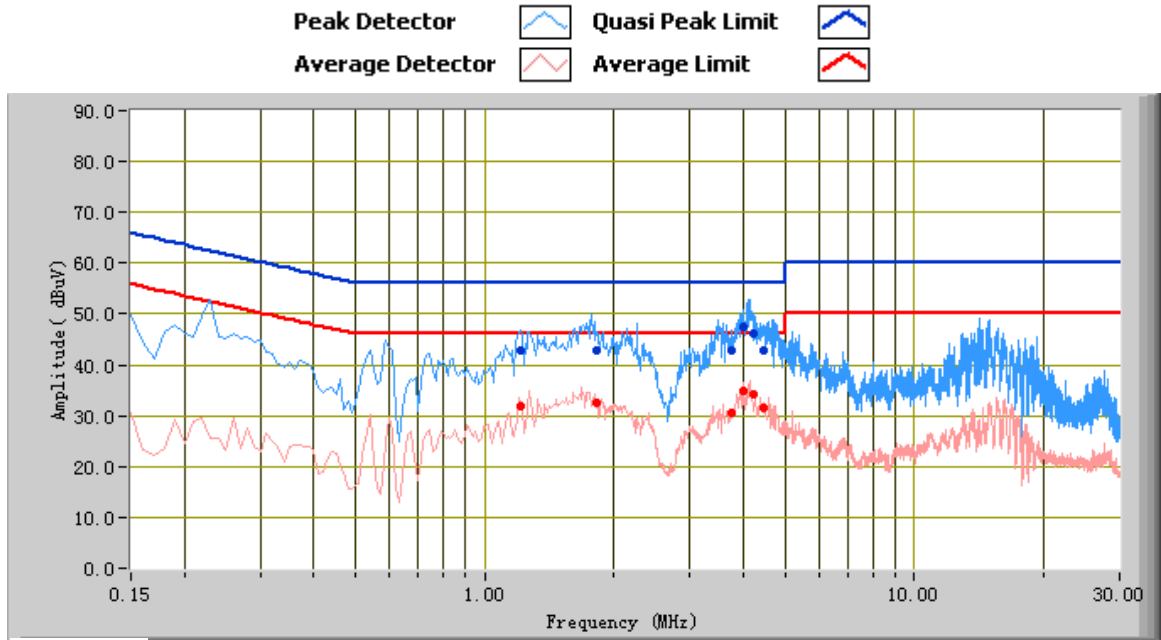

Test Data

Phase Line Plot at 120Vac, 60Hz

Frequency (MHz)	Quasi Peak (dBuV)	Limit (dBuV)	Margin (dB)	Average (dBuV)	Limit (dBuV)	Margin (dB)	Factors (dB)
3.98	47.42	56.00	-8.58	34.93	46.00	-11.07	10.81
4.46	42.72	56.00	-13.28	31.63	46.00	-14.37	10.90
1.21	42.74	56.00	-13.26	31.96	46.00	-14.04	10.30
3.74	42.68	56.00	-13.32	30.45	46.00	-15.55	10.76
1.82	42.87	56.00	-13.13	32.53	46.00	-13.47	10.41
4.22	46.15	56.00	-9.85	34.13	46.00	-11.87	10.85

Test Mode:	Transmitting Mode(Worse Case)
-------------------	--------------------------------------

Peak Detector		Quasi Peak Limit	
Average Detector		Average Limit	

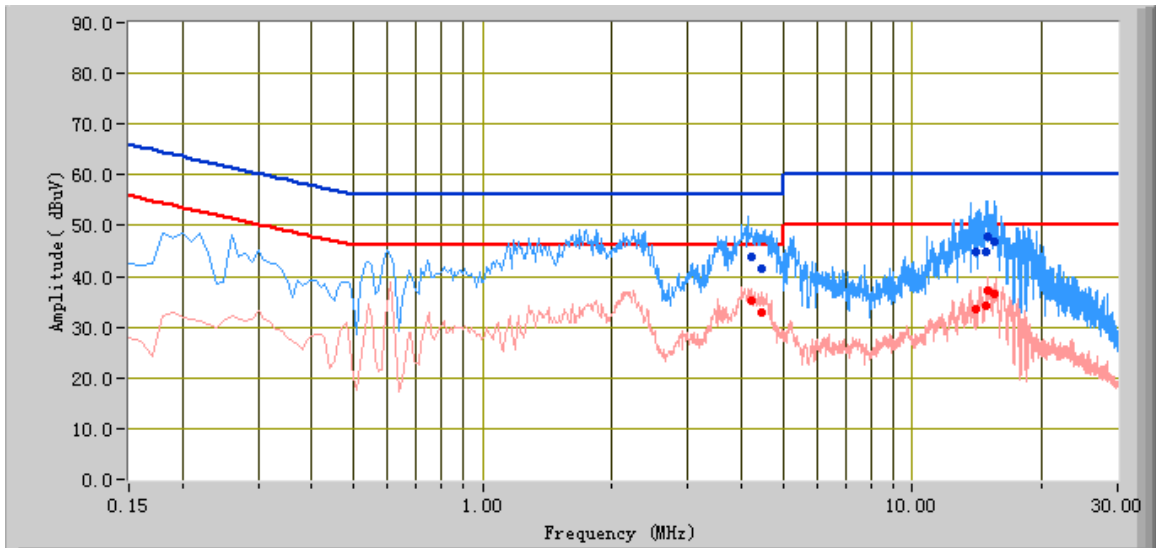

Test Data

Phase Neutral Plot at 120Vac, 60Hz

Frequency (MHz)	Quasi Peak (dBuV)	Limit (dBuV)	Margin (dB)	Average (dBuV)	Limit (dBuV)	Margin (dB)	Factors (dB)
15.50	46.74	60.00	-13.26	36.60	50.00	-13.40	13.57
4.22	43.77	56.00	-12.23	35.32	46.00	-10.68	10.85
14.78	44.74	60.00	-15.26	34.37	50.00	-15.63	13.32
14.06	44.93	60.00	-15.07	33.47	50.00	-16.53	13.09
15.02	47.69	60.00	-12.31	37.35	50.00	-12.65	13.38
4.46	41.55	56.00	-14.45	32.82	46.00	-13.18	10.90

5.7 §15.209, §15.205 & §15.247(d) - Radiated Spurious Emissions & Unwanted Emissions into Restricted Frequency Bands

1. All possible modes of operation were investigated. Only the 6 worst case emissions measured, using the correct CISPR detectors, are reported. All other emissions were relatively insignificant.
2. A "-ve" margin indicates a PASS as it refers to the margin present below the limit line at the particular frequency.
3. Radiated Emissions Measurement Uncertainty
All test measurements carried out are traceable to national standards. The uncertainty of the measurement at a confidence level of approximately 95% (in the case where distributions are normal), with a coverage factor of 2, in the range 30MHz – 1GHz & 1GHz above (3m & 10m) is +/-6dB.
4. Environmental Conditions

Temperature	24°C
Relative Humidity	58%
Atmospheric Pressure	1019mbar
5. Test date : May 29, 2014
Tested By : Herith Shi

Requirement:

In any 100 kHz bandwidth outside the frequency band in which the spread spectrum or digitally modulated intentional radiator is operating, the radio frequency power that is produced by the intentional radiator shall be at least 20 dB below that in the 100 kHz bandwidth within the band that contains the highest level of the desired power, based on either an RF conducted or a radiated measurement, provided the transmitter demonstrates compliance with the peak conducted power limits. If the transmitter complies with the conducted power limits based on the use of RMS averaging over a time interval, as permitted under paragraph (b)(3) of this section, the attenuation required under this paragraph shall be 30 dB instead of 20 dB. Attenuation below the general limits specified in §15.209(a) is not required. In addition, radiated emissions which fall in the restricted bands, as defined in §15.205(a), must also comply with the radiated emission limits specified in §15.209(a) (see §15.205(c)).

Procedures:

1. The EUT was switched on and allowed to warm up to its normal operating condition.
2. The test was carried out at the selected frequency points obtained from the EUT characterisation. Maximization of the emissions was carried out by rotating the EUT, changing the antenna polarization, and adjusting the antenna height in the following manner:
 - a. Vertical or horizontal polarisation (whichever gave the higher emission level over a full rotation of the EUT) was chosen.
 - b. The EUT was then rotated to the direction that gave the maximum emission.
 - c. Finally, the antenna height was adjusted to the height that gave the maximum emission.
3. A Quasi-peak measurement was then made for that frequency point for below 1GHz test, PK and AV for above 1GHz emission test.
 - a. The resolution bandwidth and video bandwidth of test receiver/spectrum analyzer is 120 kHz for Quasiy Peak detection at frequency below 1GHz.
 - b. The resolution bandwidth of test receiver/spectrum analyzer is 1MHz and video bandwidth is 3MHz for Peak detection at frequency above 1GHz.
 - c. The resolution bandwidth of test receiver/spectrum analyzer is 1MHz and the video bandwidth for Average detection (AV) as below at frequency above 1GHz.

☐ 1 kHz (Duty cycle < 98%) ■ 10 Hz (Duty cycle > 98%)

4. Steps 2 and 3 were repeated for the next frequency point, until all selected frequency points were measured.

Test Result: Pass

Test Mode:	Transmitting Mode(Worse Case)
-------------------	--------------------------------------

(Below 1GHz)

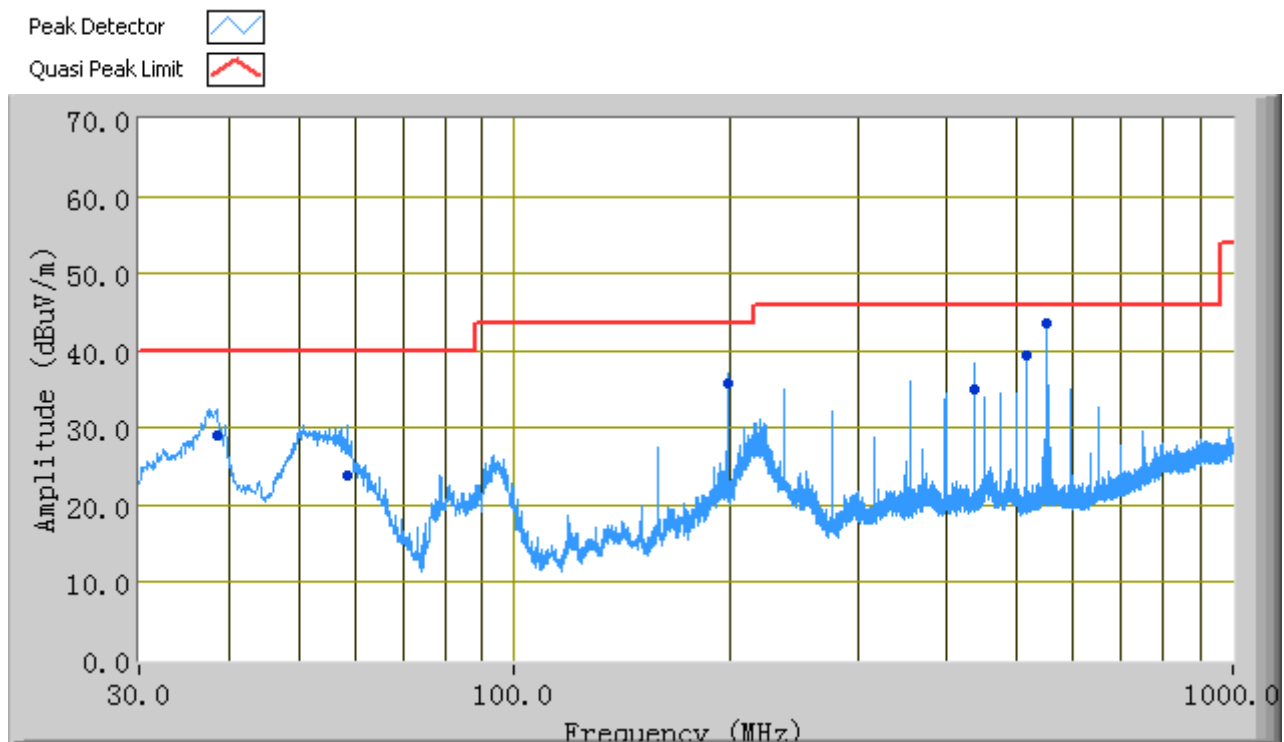

Test Data

Vertical & Horizontal Polarity Plot @3m

Frequency (MHz)	Quasi Peak (dBuV/m)	Azimuth	Polarity(H/V)	Height (cm)	Factors (dB)	Limit (dBuV)	Margin (dB)
549.99	43.47	0.00	H	210.00	-1.58	46.00	-2.53
514.81	39.42	208.00	H	100.00	-1.84	46.00	-6.58
197.98	35.71	280.00	H	175.00	-8.20	43.52	-7.81
435.55	35.06	257.00	V	100.00	-2.63	46.00	-10.94
38.52	29.15	253.00	V	112.00	-6.50	40.00	-10.85
58.32	23.75	169.00	V	127.00	-13.99	40.00	-16.25

Above 1 GHz:

Test Mode: Transmitting

Note: Other modes were verified, only the result of worst case basic rate mode was presented.

Mode: 802.11b
 Low Channel (2412 MHz)

Frequency (MHz)	Substituted level (dBµV/m)	Detector (PK/AV)	Polarity (H/V)	Ant. Factor (dB/m)	Cable Loss (dB)	Pre-Amp. Gain (dB)	Cord. Amp. (dBµV/m)	Limit (dBµV/m)	Margin (dB)
4824	37.69	AV	V	34.0	4.87	26.79	49.77	54	-4.23
4824	37.51	AV	H	33.8	4.87	26.79	49.39	54	-4.61
4824	48.25	PK	V	34.0	4.87	26.79	60.33	74	-13.67
4824	49.11	PK	H	33.8	4.87	26.79	60.99	74	-13.01

Middle Channel (2437 MHz)

Frequency (MHz)	Substituted level (dBµV/m)	Detector (PK/AV)	Polarity (H/V)	Ant. Factor (dB/m)	Cable Loss (dB)	Pre-Amp. Gain (dB)	Cord. Amp. (dBµV/m)	Limit (dBµV/m)	Margin (dB)
4874	37.54	AV	V	33.6	4.87	26.78	49.23	54	-4.77
4874	37.39	AV	H	33.8	4.87	26.78	49.28	54	-4.72
4874	47.96	PK	V	33.6	4.87	26.78	59.65	74	-14.35
4874	48.88	PK	H	33.8	4.87	26.78	60.77	74	-13.23

High Channel (2462 MHz)

Frequency (MHz)	Substituted level (dBµV/m)	Detector (PK/AV)	Polarity (H/V)	Ant. Factor (dB/m)	Cable Loss (dB)	Pre-Amp. Gain (dB)	Cord. Amp. (dBµV/m)	Limit (dBµV/m)	Margin (dB)
4924	36.91	AV	V	34.6	4.87	26.75	49.63	54	-4.37
4924	38.14	AV	H	34.7	4.87	26.75	50.96	54	-3.04
4924	48.09	PK	V	34.6	4.87	26.75	60.81	74	-13.19
4924	49.05	PK	H	34.7	4.87	26.75	61.87	74	-12.13

Annex A. TEST INSTRUMENT & METHOD

Annex A.i. TEST INSTRUMENTATION & GENERAL PROCEDURES

Instrument	Model	Serial #	Calibration Date	Calibration Due Date
AC Line Conducted Emissions				
EMI test receiver	ESCS30	8471241027	05/27/2014	05/26/2015
Line Impedance Stabilization Network	LI-125A	191106	11/14/2013	11/13/2014
Line Impedance Stabilization Network	LI-125A	191107	11/14/2013	11/13/2014
LISN	ISN T800	34373	01/11/2014	01/10/2015
Double Ridge Horn Antenna (1 ~18GHz)	AH-118	71283	11/20/2013	11/19/2014
Transient Limiter	LIT-153	531118	09/02/2013	09/01/2014
RF conducted test				
Agilent ESA-E SERIES SPECTRUM ANALYZER	E4407B	MY45108319	09/17/2013	09/16/2014
Power Splitter	1#	1#	09/02/2013	09/01/2014
DC Power Supply	E3640A	MY40004013	09/17/2013	09/16/2014
Wireless Connectivity Test Set	N4010A	GB44440198	03/20/2014	03/19/2015
Radiated Emissions				
EMI test receiver	ESL6	100262	11/23/2013	11/22/2014
Positioning Controller	UC3000	MF780208282	11/19/2013	11/19/2014
OPT 010 AMPLIFIER (0.1-1300MHz)	8447E	2727A02430	09/02/2013	09/01/2014
Microwave Preamplifier (0.5 ~18GHz)	PAM-118	443008	09/02/2013	09/01/2014
Bilog Antenna (30MHz~6GHz)	JB6	A110712	09/23/2013	09/22/2014
Double Ridge Horn Antenna (1 ~18GHz)	AH-118	71283	11/20/2013	11/19/2014
Universal Radio Communication Tester	CMU200	121393	09/17/2013	09/16/2014

Annex A.ii. CONDUCTED EMISSIONS TEST DESCRIPTION

Test Set-up

1. The EUT and supporting equipment were set up in accordance with the requirements of the standard on top of a 1.5m x 1m x 0.8m high, non-metallic table, as shown in Annex B.
2. The power supply for the EUT was fed through a 50Ω/50μH EUT LISN, connected to filtered mains.
3. The RF OUT of the EUT LISN was connected to the EMI test receiver via a low-loss coaxial cable.
4. All other supporting equipments were powered separately from another main supply.

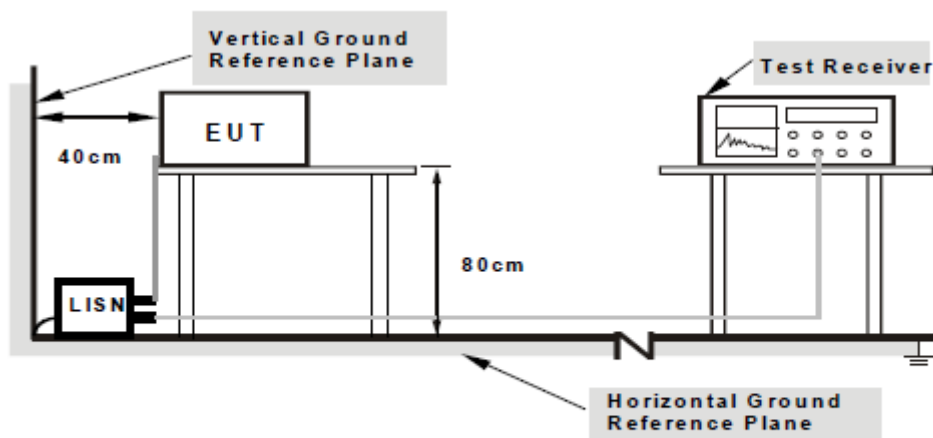

**Note: 1. Support units were connected to second LISN.
 2. Both of LISNs (AMN) are 80cm from EUT and at least 80cm from other units and other metal planes support units.**

For the actual test configuration, please refer to the related item – Photographs of the Test Configuration1.

Test Method

1. The EUT was switched on and allowed to warm up to its normal operating condition.
2. A scan was made on the NEUTRAL line (for AC mains) or Earth line (for DC power) over the required frequency range using an EMI test receiver.
3. High peaks, relative to the limit line, were then selected.
4. The EMI test receiver was then tuned to the selected frequencies and the necessary measurements made with a receiver bandwidth setting of 10 kHz. For FCC tests, only Quasi-peak measurements were made; while for CISPR/EN tests, both Quasi-peak and Average measurements were made.
5. Steps 2 to 4 were then repeated for the LIVE line (for AC mains) or DC line (for DC power).

Description of Conducted Emission Program

This EMC Measurement software run LabView automation software and offers a common user interface for electromagnetic interference (EMI) measurements. This software is a modern and powerful tool for controlling and monitoring EMI test receivers and EMC test systems. It guarantees reliable collection, evaluation, and documentation of measurement results. Basically, this program will run a pre-scan measurement before it proceeds with the final measurement. The pre-scan routine will run the common scan range from 150 kHz to 30 MHz; the program will first start a peak and average scan on selectable measurement time and step size. After the program complete the pre-scan, this program will perform the Quasi Peak and Average measurement, based on the pre-scan peak data reduction result.



SIEMIC, INC.

Accessing global markets

Title: RF Test Report for Automotive diagnosis computer
Main Model: Creader professional229
Serial Model: CRP221, CRP223, CRP225, CRP226, CRP228, CRP229
To: FCC Part 15.247: 2013, ANSI C63.4: 2009

Report No.: 14070260-FCC-R1
Issue Date: June 18, 2014
Page: 57 of 76
www.siemec.com
www.siemec.com.cn

Sample Calculation Example

At 20 MHz

limit = $250 \mu\text{V} = 47.96 \text{ dB}\mu\text{V}$

Transducer factor of LISN, pulse limiter & cable loss at 20 MHz = 11.20 dB

Q-P reading obtained directly from EMI Receiver = $40.00 \text{ dB}\mu\text{V}$
(Calibrated for system losses)

Therefore, Q-P margin = $47.96 - 40.00 = 7.96$ i.e. **7.96 dB below limit**

Annex A. iii RADIATED EMISSIONS TEST DESCRIPTION

EUT Characterisation

EUT characterisation, over the frequency range from 30MHz to 10th Harmonic , was done in order to minimise radiated emissions testing time while still maintaining high confidence in the test results.

The EUT was placed in the chamber, at a height of about 0.8m on a turntable. Its radiated emissions frequency profile was observed, using a spectrum analyzer /receiver with the appropriate broadband antenna placed 3m away from the EUT. Radiated emissions from the EUT were maximised by rotating the turntable manually, changing the antenna polarisation and manipulating the EUT cables while observing the frequency profile on the spectrum analyzer / receiver. Frequency points at which maximum emissions occurred, clock frequencies and operating frequencies were then noted for the formal radiated emissions test at the Open Area Test Site (OATS).

Test Set-up

1. The EUT and supporting equipment were set up in accordance with the requirements of the standard on top of a 1.5m X 1.0m X 0.8m high, non-metallic table.
2. The filtered power supply for the EUT and supporting equipment were tapped from the appropriate power sockets located on the turntable.
3. The relevant broadband antenna was set at the required test distance away from the EUT and supporting equipment boundary.

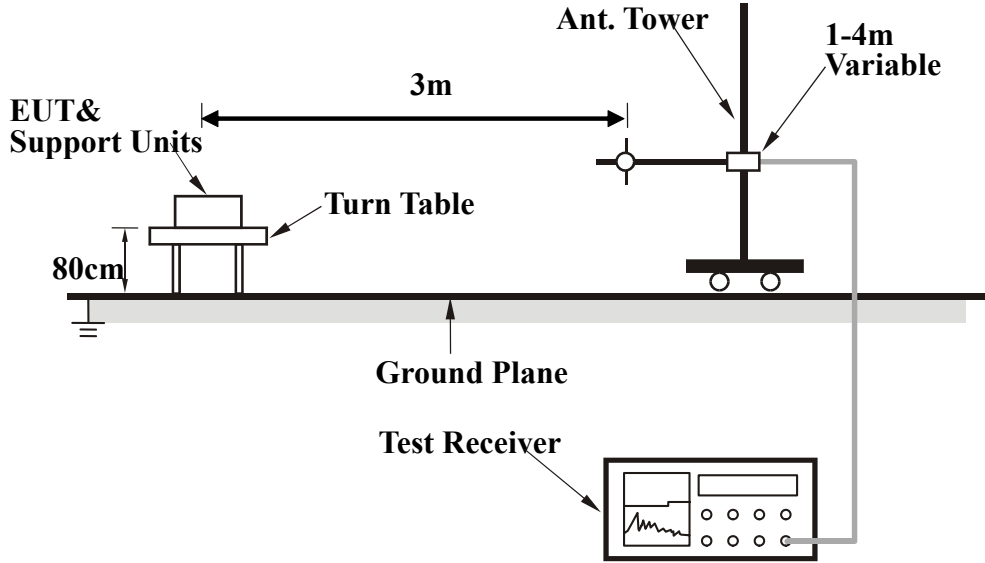

Test Method

The following procedure was performed to determine the maximum emission axis of EUT:

1. With the receiving antenna is H polarization, rotate the EUT in turns with three orthogonal axes to determine the axis of maximum emission.
2. With the receiving antenna is V polarization, rotate the EUT in turns with three orthogonal axes to determine the axis of maximum emission.
3. Compare the results derived from above two steps. So, the axis of maximum emission from EUT was determined and the configuration was used to perform the final measurement.

Final Radiated Emission Measurement

1. Setup the configuration according to figure 1. Turn on EUT and make sure that it is in normal function.
2. For emission frequencies measured below 1 GHz, a pre-scan is performed in a shielded chamber to determine the accurate frequencies of higher emissions will be checked on a open test site. As the same purpose, for emission frequencies measured above 1 GHz, a pre-scan also be performed with a 1 meter measuring distance before final test.
3. For emission frequencies measured below and above 1 GHz, set the spectrum analyzer on a 100 kHz and 1 MHz resolution bandwidth respectively for each frequency measured in step 2.
4. The search antenna is to be raised and lowered over a range from 1 to 4 meters in horizontally polarized orientation. Position the highness when the highest value is indicated on spectrum analyzer, then change the orientation of EUT on test table over a range from 0 ° to 360 ° with a speed as slow as possible, and keep the azimuth that highest emission is indicated on the spectrum analyzer. Vary the antenna position again and record the highest value as a final reading.
5. Repeat step 4 until all frequencies need to be measured was complete.
6. Repeat step 5 with search antenna in vertical polarized orientations.

During the radiated emission test, the Spectrum Analyzer was set with the following configurations:

Frequency Band (MHz)	Function	Resolution bandwidth	Video Bandwidth
30 to 1000	Peak	100 kHz	100 kHz
Above 1000	Peak	1 MHz	1 MHz
	Average	1 MHz	10 Hz

Sample Calculation Example

The field strength is calculated by adding the Antenna Factor and Cable Factor, and subtracting the Amplifier Gain (if any) from the measured reading. For the limit is employed average value, therefore the peak value can be transferred to average value by subtracting the duty factor. The basic equation with a sample calculation is as follows:

$$\text{Peak} = \text{Reading} + \text{Corrected Factor}$$

where

$$\text{Corr. Factor} = \text{Antenna Factor} + \text{Cable Factor} - \text{Amplifier Gain (if any)}$$

And the average value is

$$\text{Average} = \text{Peak Value} + \text{Duty Factor or}$$

$$\text{Set RBW} = 1\text{MHz, VBW} = 10\text{Hz.}$$

Note :

If the measured frequencies are fall in the restricted frequency band, the limit employed must be quasi peak value when frequencies are below or equal to 1 GHz. And the measuring instrument is set to quasi peak detector function.

Annex B. EUT AND TEST SETUP PHOTOGRAPHS

Annex B.i. Photograph 1: EUT External Photo



Whole Package - Top View

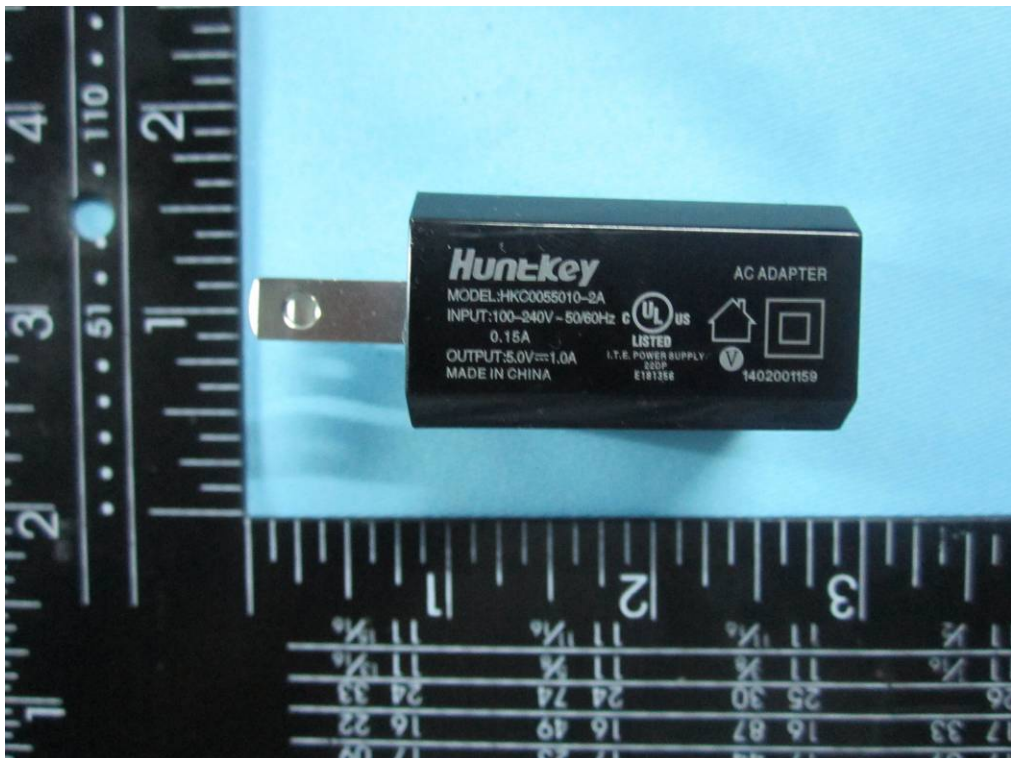

Adapter – Front View



EUT - Front View



EUT - Rear View



EUT - Top View



EUT - Bottom View



EUT - Left View



EUT - Right View

Annex B.i. Photograph 2: EUT Internal Photo

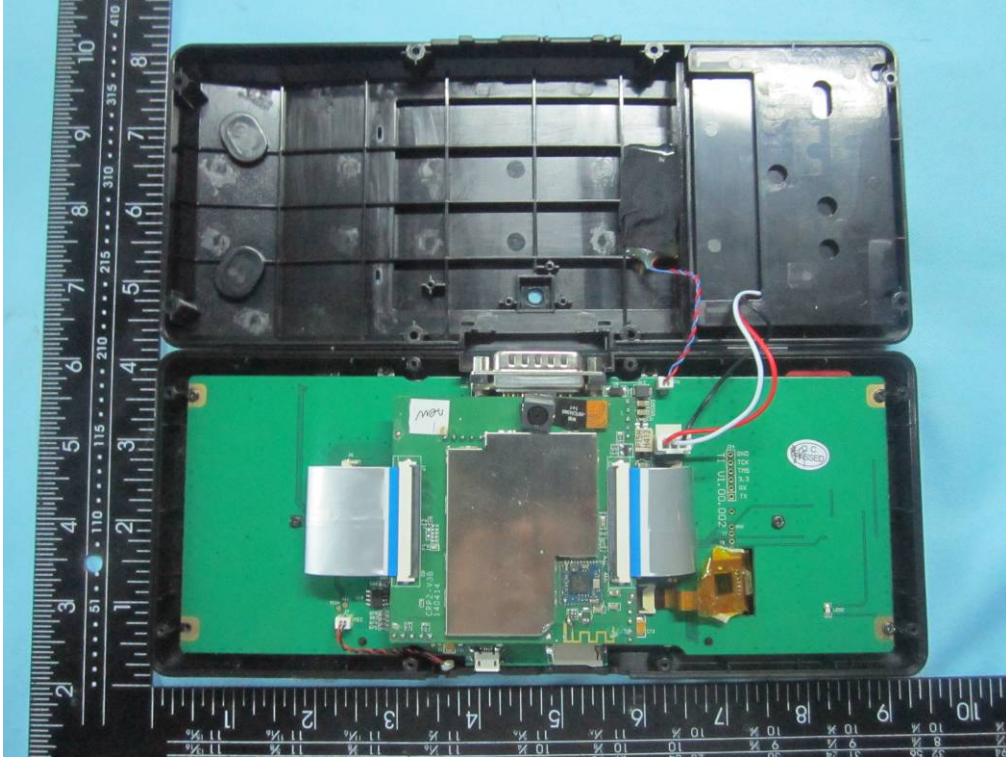

Cover Off - Top View

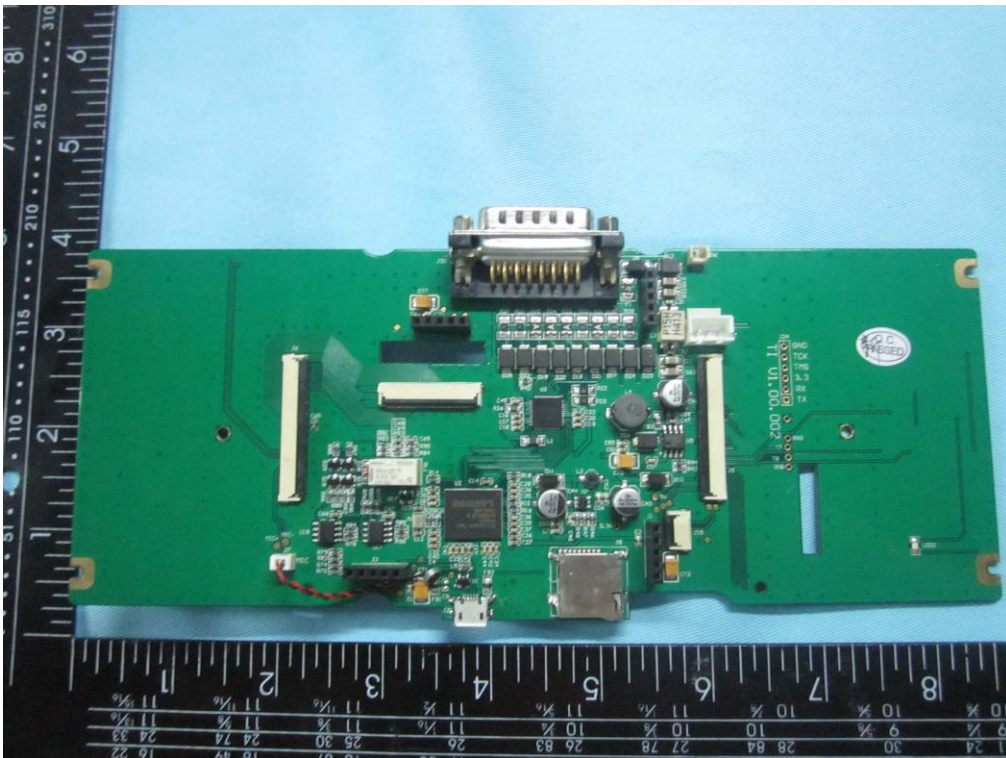

Mainboard - Top View

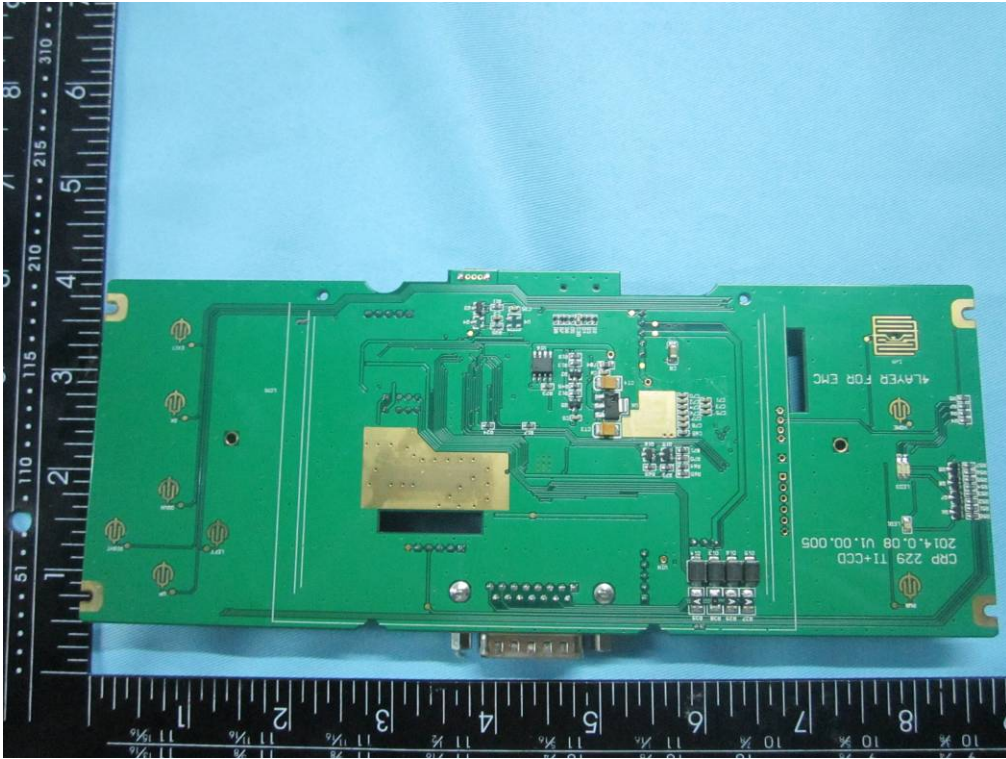

Mainboard - Rear View

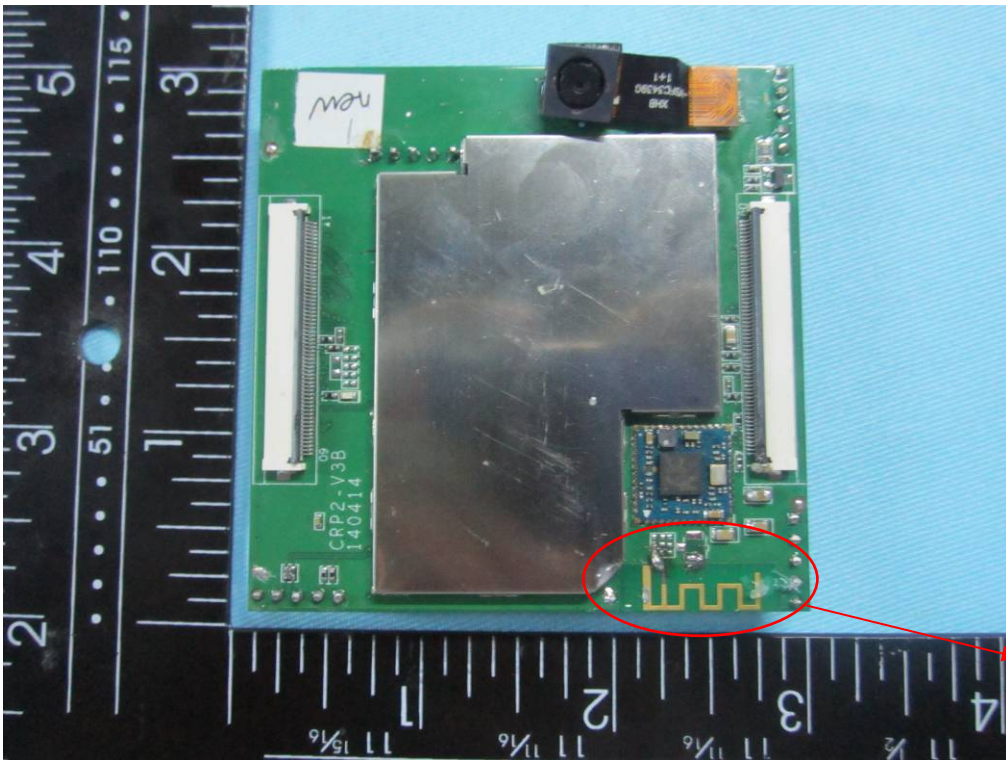

Antenna View

RF PCB with Shielding- Top View

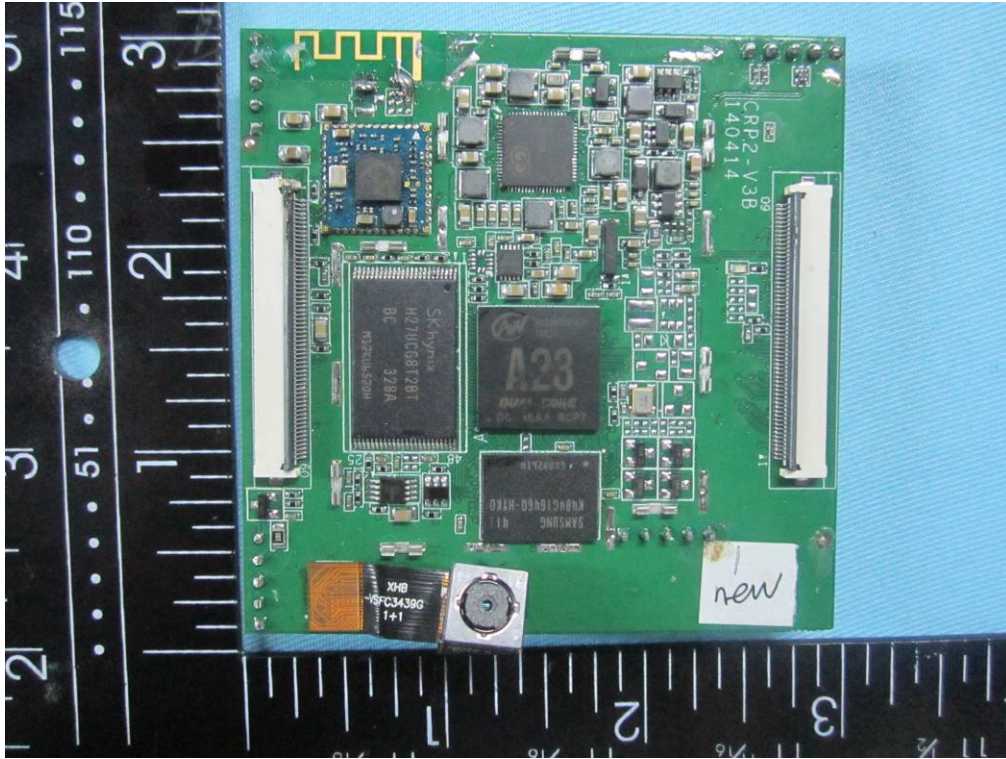

RF PCB without Shielding- Top View

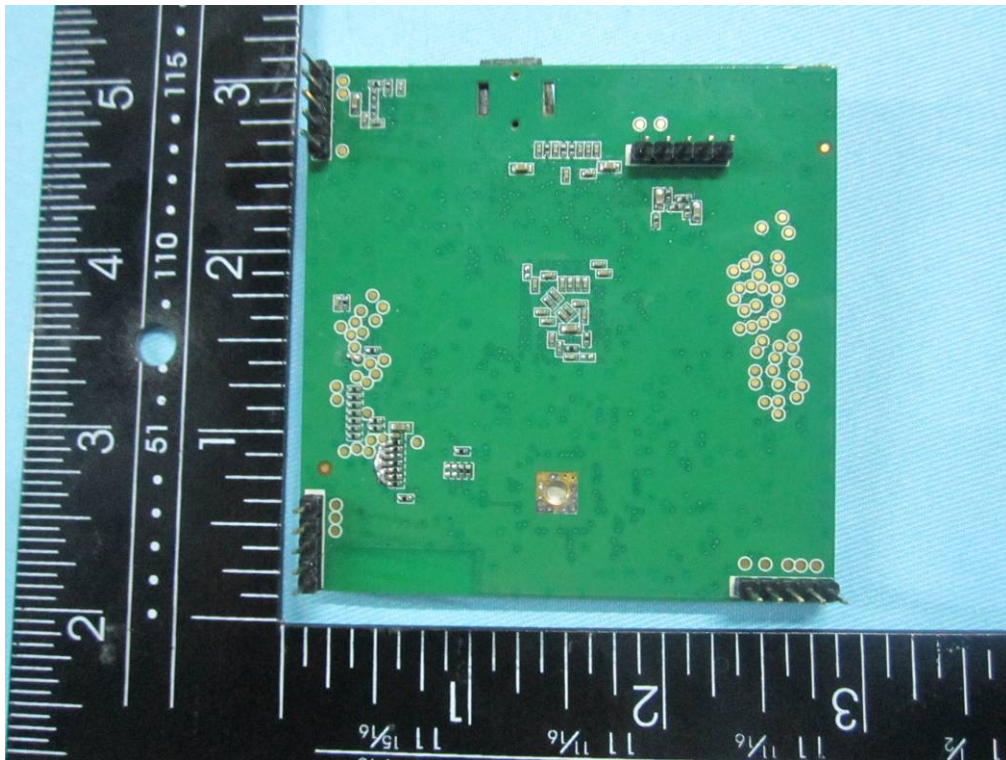

RF PCB - Rear View



LCD Board – Front View

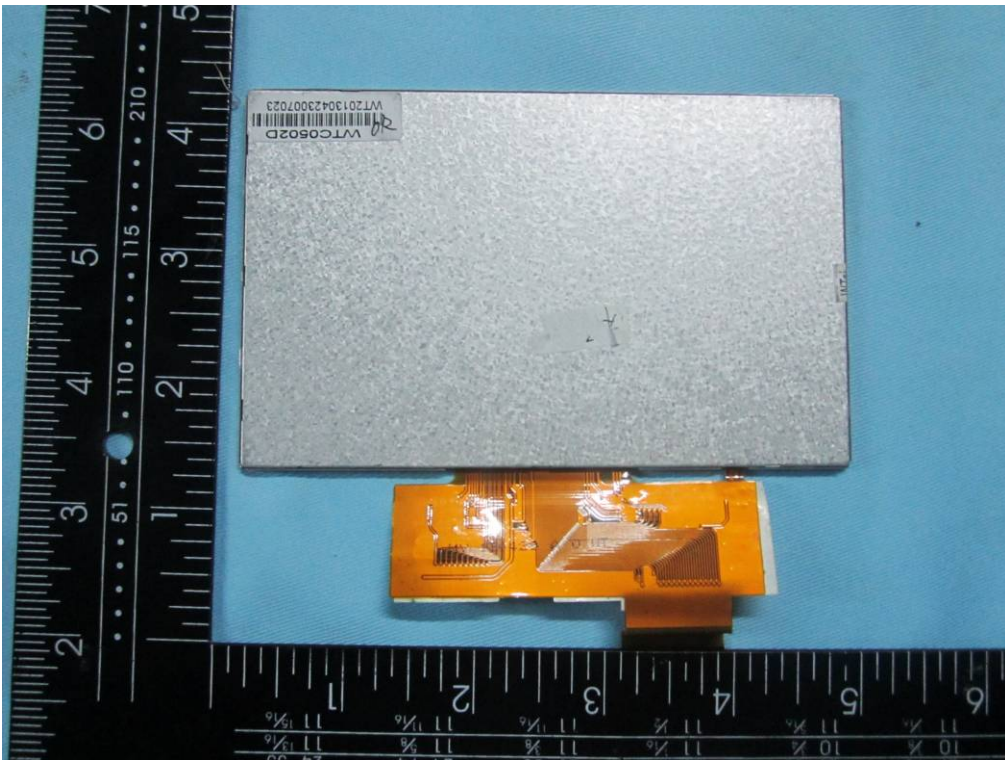

LCD Board – Rear View



Battery - Front View



Battery - Rear View

Annex B.iii. Photograph 1: Test Setup Photo



Conducted Emissions Test Setup Front View



Conducted Emissions Test Setup Side View

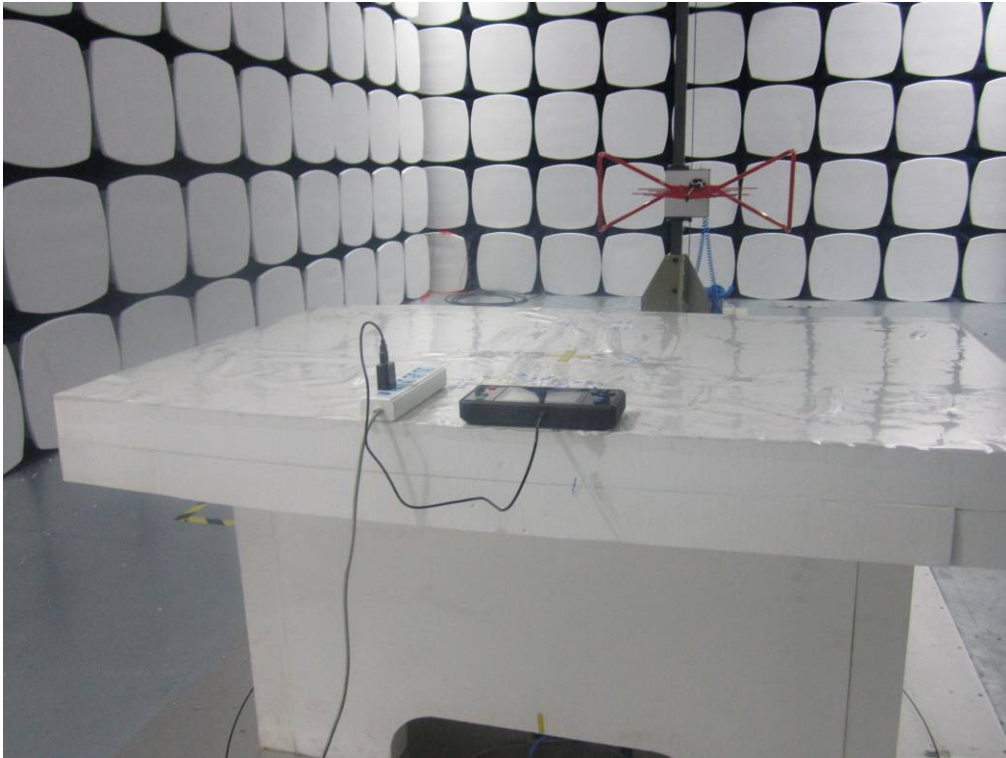

Radiated Spurious Emissions Test Setup Below 1GHz - Front View

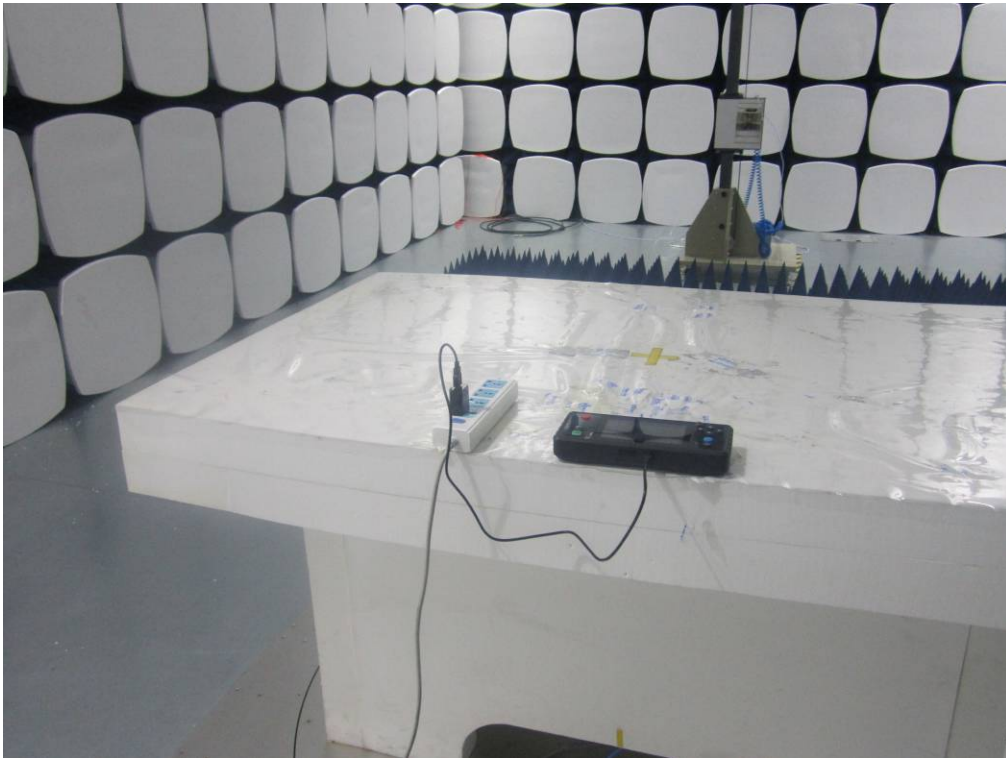

Radiated Spurious Emissions Test Setup Above 1GHz - Front View

Annex C. TEST SETUP AND SUPPORTING EQUIPMENT

EUT TEST CONDITIONS

Annex C. i. SUPPORTING EQUIPMENT DESCRIPTION

The following is a description of supporting equipment and details of cables used with the EUT.

Equipment Description (Including Brand Name)	Model & Serial Number	Cable Description (List Length, Type & Purpose)
N/A	N/A	N/A

Block Configuration Diagram for AC Line Conducted Emissions

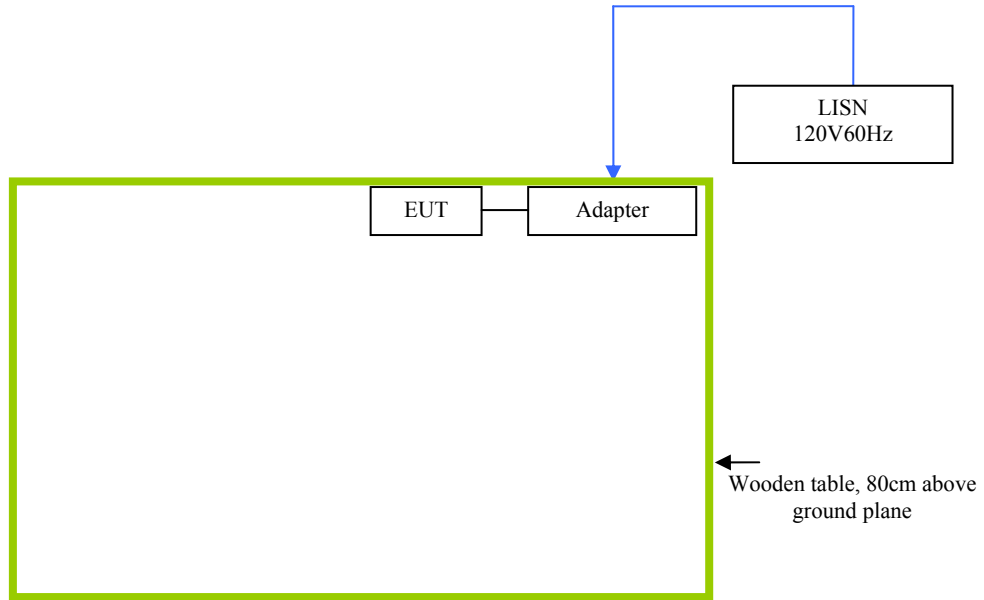



SIEMIC, INC.

Accessing global markets

Title: RF Test Report for Automotive diagnosis computer
Main Model: Creader professional229
Serial Model: CRP221, CRP223, CRP225, CRP226, CRP228, CRP229
To: FCC Part 15.247: 2013, ANSI C63.4: 2009

Report No.: 14070260-FCC-R1
Issue Date: June 18, 2014
Page: 73 of 76
www.siemic.com
www.siemic.com.cn

Block Configuration Diagram for Radiated Emissions

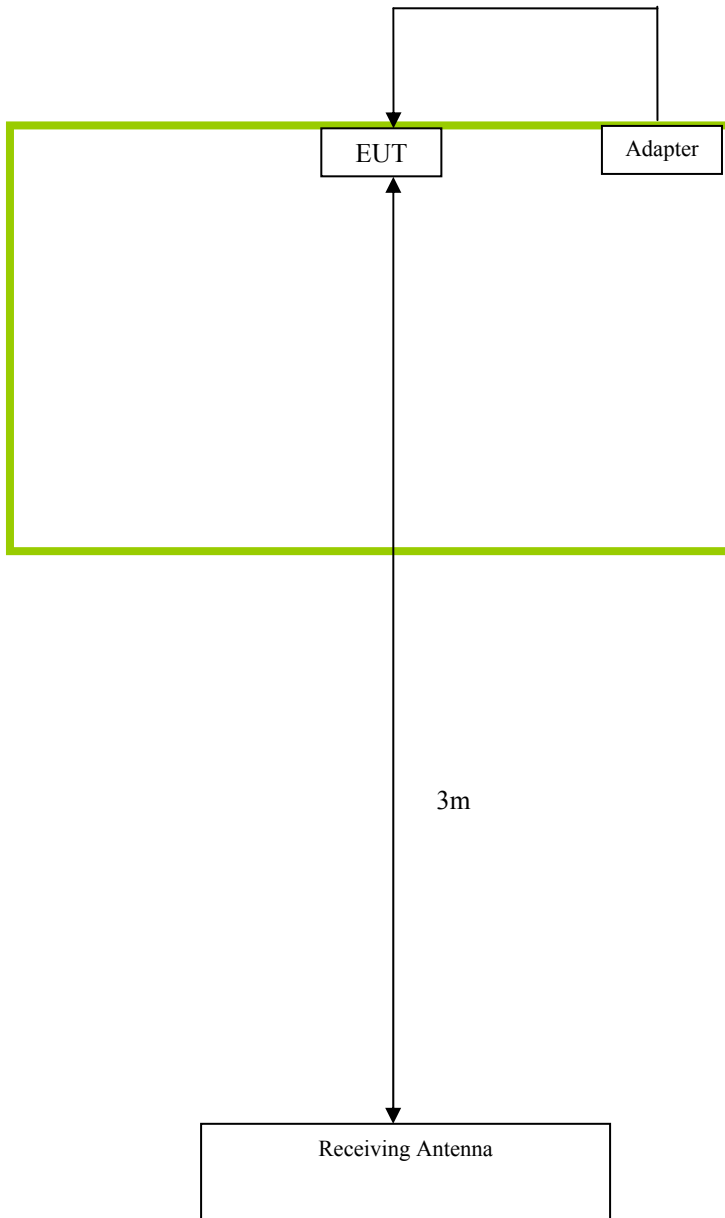

Annex C.ii. EUT OPERATING CONDITIONS

The following is the description of how the EUT is exercised during testing.

Test	Description Of Operation
Emissions Testing	The EUT was continuously transmitting to stimulate the worst case.



SIEMIC, INC.

Accessing global markets

Title: RF Test Report for Automotive diagnosis computer
Main Model: Creader professional229
Serial Model: CRP221, CRP223, CRP225, CRP226, CRP228, CRP229
To: FCC Part 15.247: 2013, ANSI C63.4: 2009

Report No.: 14070260-FCC-R1
Issue Date: June 18, 2014
Page: 75 of 76
www.siemec.com
www.siemec.com.cn

Annex D. USER MANUAL / BLOCK DIAGRAM / SCHEMATICS / PART LIST

Please see attachment



SIEMIC, INC.

Accessing global markets

Title: RF Test Report for Automotive diagnosis computer
Main Model: Creader professional229
Serial Model: CRP221, CRP223, CRP225, CRP226, CRP228, CRP229
To: FCC Part 15.247: 2013, ANSI C63.4: 2009

Report No.: 14070260-FCC-R1
Issue Date: June 18, 2014
Page: 76 of 76
www.siemic.com
www.siemic.com.cn

Annex E. DECLARATION OF SIMILARITY

Launch Tech Co., Ltd.

To: SIEMIC , 775 Montague Expressway, Milpitas, CA 95035,USA

Declaration Letter

Dear Sir,

For our business issue and marketing requirement, we would like to list the following model numbers on The FCC certificates and reports, as following:

Model No.: Creader professional229, CRP229, CRP221, CRP223, CRP225, CRP226, CRP228

We declare that the difference of these is listed as below:

Main Model No	Serial Model No	Difference
Creader professional229	CRP229, CRP221, CRP223, CRP225, CRP226, CRP228	1. Label 2. Color of gum cover 3. Without some adaptors 4. Without USB cable

Thank you!

Client's signature : *Zheng Zhang*

Client's name / title : Zheng Zhang / Product Certification Engineer

Contact information / address : Launch Industrial Park, North of Wuhe Rd., Banxuegang, Longgang, Shenzhen, China