

## FCC Test Report

**Report No.:** RF150424E08

**FCC ID:** XU8TVIP745SIC

**Test Model:** TV-IP745SIC

**Received Date:** Apr. 24, 2015

**Test Date:** May 19 to July 29, 2015

**Issued Date:** July 30, 2015

**Applicant:** TRENDnet, INC

**Address:** 20675 Manhattan Place, Torrance, CA 90501 U.S.A.

**Issued By:** Bureau Veritas Consumer Products Services (H.K.) Ltd., Taoyuan Branch  
Hsin Chu Laboratory

**Lab Address:** No. 81-1, Lu Liao Keng, 9th Ling, Wu Lung Tsuen, Chiung Lin Hsiang, Hsin  
Chu Hsien 307, Taiwan R.O.C.

**Test Location (1):** No. 81-1, Lu Liao Keng, 9th Ling, Wu Lung Tsuen, Chiung Lin Hsiang, Hsin  
Chu Hsien 307, Taiwan R.O.C.

**Test Location (2):** No. 49, Ln. 206, Wende Rd., Shangshan Tsuen, Chiung Lin Hsiang, Hsin  
Chu Hsien 307, Taiwan R.O.C.



This report is for your exclusive use. Any copying or replication of this report to or for any other person or entity, or use of our name or trademark, is permitted only with our prior written permission. This report sets forth our findings solely with respect to the test samples identified herein. The results set forth in this report are not indicative or representative of the quality or characteristics of the lot from which a test sample was taken or any similar or identical product unless specifically and expressly noted. Our report includes all of the tests requested by you and the results thereof based upon the information that you provided to us. You have 60 days from date of issuance of this report to notify us of any material error or omission caused by our negligence, provided, however, that such notice shall be in writing and shall specifically address the issue you wish to raise. A failure to raise such issue within the prescribed time shall constitute your unqualified acceptance of the completeness of this report, the tests conducted and the correctness of the report contents. Unless specific mention, the uncertainty of measurement has been explicitly taken into account to declare the compliance or non-compliance to the specification. The report must not be used by the client to claim product certification, approval, or endorsement by TAF or any government agencies.

**Table of Contents**

<b>Release Control Record</b> .....	<b>4</b>
<b>1 Certificate of Conformity</b> .....	<b>5</b>
<b>2 Summary of Test Results</b> .....	<b>6</b>
2.1 Measurement Uncertainty.....	6
2.2 Modification Record.....	6
<b>3 General Information</b> .....	<b>7</b>
3.1 General Description of EUT.....	7
3.2 Description of Test Modes.....	8
3.2.1 Test Mode Applicability and Tested Channel Detail.....	9
3.3 Duty Cycle of Test Signal.....	11
3.4 Description of Support Units.....	12
3.4.1 Configuration of System under Test.....	12
3.5 General Description of Applied Standards.....	13
<b>4 Test Types and Results</b> .....	<b>14</b>
4.1 Radiated Emission and Bandedge Measurement.....	14
4.1.1 Limits of Radiated Emission and Bandedge Measurement.....	14
4.1.2 Test Instruments.....	15
4.1.3 Test Procedures.....	16
4.1.4 Deviation from Test Standard.....	16
4.1.5 Test Setup.....	17
4.1.6 EUT Operating Conditions.....	17
4.1.7 Test Results.....	18
4.2 Conducted Emission Measurement.....	28
4.2.1 Limits of Conducted Emission Measurement.....	28
4.2.2 Test Instruments.....	28
4.2.3 Test Procedures.....	30
4.2.4 Deviation from Test Standard.....	30
4.2.5 Test Setup.....	30
4.2.6 EUT Operating Conditions.....	30
4.2.7 Test Results (Mode 1).....	31
4.2.8 Test Results (Mode 2).....	33
4.3 6dB Bandwidth Measurement.....	35
4.3.1 Limits of 6dB Bandwidth Measurement.....	35
4.3.2 Test Setup.....	35
4.3.3 Test Instruments.....	35
4.3.4 Test Procedure.....	35
4.3.5 Deviation from Test Standard.....	35
4.3.6 EUT Operating Conditions.....	35
4.3.7 Test Result.....	36
4.4 Conducted Output Power Measurement.....	38
4.4.1 Limits of Conducted Output Power Measurement.....	38
4.4.2 Test Setup.....	38
4.4.3 Test Instruments.....	38
4.4.4 Test Procedures.....	38
4.4.5 Deviation from Test Standard.....	38
4.4.6 EUT Operating Conditions.....	38
4.4.7 Test Results.....	39
4.5 Power Spectral Density Measurement.....	40
4.5.1 Limits of Power Spectral Density Measurement.....	40
4.5.2 Test Setup.....	40
4.5.3 Test Instruments.....	40
4.5.4 Test Procedure.....	40
4.5.5 Deviation from Test Standard.....	40



4.5.6 EUT Operating Condition .....	40
4.5.7 Test Results .....	41
4.6 Conducted Out of Band Emission Measurement.....	43
4.6.1 Limits of Conducted Out of Band Emission Measurement .....	43
4.6.2 Test Setup.....	43
4.6.3 Test Instruments .....	43
4.6.4 Test Procedure .....	43
4.6.5 Deviation from Test Standard .....	43
4.6.6 EUT Operating Condition .....	43
4.6.7 Test Results .....	43
<b>5 Pictures of Test Arrangements.....</b>	<b>47</b>
<b>Appendix – Information on the Testing Laboratories .....</b>	<b>48</b>



A D T

### Release Control Record

Issue No.	Description	Date Issued
RF150424E08	Original release.	July 30, 2015



### 1 Certificate of Conformity

**Product:** WiFi HD Baby Cam  
**Brand:** TRENDnet  
**Test Model:** TV-IP745SIC  
**Sample Status:** ENGINEERING SAMPLE  
**Applicant:** TRENDnet, INC  
**Test Date:** May 19 to July 29, 2015  
**Standards:** 47 CFR FCC Part 15, Subpart C (Section 15.247)  
ANSI C63.10:2009

The above equipment has been tested by **Bureau Veritas Consumer Products Services (H.K.) Ltd., Taoyuan Branch**, and found compliance with the requirement of the above standards. The test record, data evaluation & Equipment Under Test (EUT) configurations represented herein are true and accurate accounts of the measurements of the sample's EMC characteristics under the conditions specified in this report.

**Prepared by :** Phoenix Huang , **Date:** July 30, 2015  
Phoenix Huang / Specialist

**Approved by :** May Chen , **Date:** July 30, 2015  
May Chen / Manager

## 2 Summary of Test Results

47 CFR FCC Part 15, Subpart C (SECTION 15.247)			
FCC Clause	Test Item	Result	Remarks
15.207	AC Power Conducted Emission	PASS	Meet the requirement of limit. Minimum passing margin is -6.82dB at 0.42344MHz.
15.205 / 15.209 / 15.247(d)	Radiated Emissions and Band Edge Measurement	PASS	Meet the requirement of limit. Minimum passing margin is -3.2dB at 4824.00MHz & 2390.00MHz.
15.247(d)	Antenna Port Emission	PASS	Meet the requirement of limit.
15.247(a)(2)	6dB bandwidth	PASS	Meet the requirement of limit.
15.247(b)	Conducted power	PASS	Meet the requirement of limit.
15.247(e)	Power Spectral Density	PASS	Meet the requirement of limit.
15.203	Antenna Requirement	PASS	Antenna connector is I-pex not a standard connector.

### 2.1 Measurement Uncertainty

Where relevant, the following measurement uncertainty levels have been estimated for tests performed on the EUT as specified in CISPR 16-4-2:

Measurement	Frequency	Expanded Uncertainty (k=2) ( $\pm$ )
Conducted Emissions at mains ports	150kHz ~ 30MHz	2.86 dB
Radiated Emissions up to 1 GHz	30MHz ~ 1GHz	5.37 dB
Radiated Emissions above 1 GHz	1GHz ~ 6GHz	3.65 dB
	6GHz ~ 18GHz	3.88 dB
	18GHz ~ 40GHz	4.11 dB

### 2.2 Modification Record

There were no modifications required for compliance.

### 3 General Information

#### 3.1 General Description of EUT

Product	WiFi HD Baby Cam
Brand	TRENDnet
Test Model	TV-IP745SIC
Status of EUT	ENGINEERING SAMPLE
Power Supply Rating	DC 5V from power adapter
Modulation Type	CCK, DQPSK, DBPSK for DSSS 64QAM, 16QAM, QPSK, BPSK for OFDM
Modulation Technology	DSSS, OFDM
Transfer Rate	802.11b: up to 11Mbps 802.11g: up to 54Mbps 802.11n: up to 72.2Mbps
Operating Frequency	2412 ~ 2462MHz
Number of Channel	11
Output Power	71.614mW
Antenna Type	Please see NOTE
Antenna Connector	Please see NOTE
Accessory Device	Adapter x 1
Data Cable Supplied	NA

Note:

1. The antenna provided to the EUT, please refer to the following table:

Ant. Gain(dBi)	Frequency Range (GHz to GHz)	Ant. Type	Connector Type	Cable Length (mm)
2.93	2.4~2.5	PIFA	I-pex	55

2. The EUT must be supplied with a power adapter and following two different models could be chosen:

No.	Brand	Model No.	Spec.
1	AMIGO	AMS1-0501200FU	Input: 100-240V, 0.2A, 50-60Hz Output: 5V, 1.2A DC output cable (Unshielded, 3m)
2	AMIGO	AMS66-0501200FU	Input: 100-240V, 0.2A, 50-60Hz Output: 5V, 1.2A DC output cable (Unshielded, 3m)

For radiated test, the EUT was pre-tested with above adapters, the worse case was found in adapter 1. Therefore only the test data of the adapter was recorded in this report.

3. The EUT incorporates a SISO function.

MODULATION MODE	DATA RATE (MCS)	TX & RX CONFIGURATION	
<b>802.11b</b>	1 ~ 11Mbps	1TX	1RX
<b>802.11g</b>	6 ~ 54Mbps	1TX	1RX
<b>802.11n (HT20)</b>	MCS 0~7	1TX	1RX

4. The above EUT information is declared by manufacturer and for more detailed features description, please refer to the manufacturer's specifications or user's manual.

### 3.2 Description of Test Modes

11 channels are provided for 802.11b, 802.11g and 802.11n (HT20):

Channel	Frequency	Channel	Frequency
1	2412MHz	7	2442MHz
2	2417MHz	8	2447MHz
3	2422MHz	9	2452MHz
4	2427MHz	10	2457MHz
5	2432MHz	11	2462MHz
6	2437MHz		



### 3.2.1 Test Mode Applicability and Tested Channel Detail

EUT CONFIGURE MODE	APPLICABLE TO				DESCRIPTION
	RE $\geq$ 1G	RE<1G	PLC	APCM	
1	√	√	√	√	With adapter 1
2	-	-	√	-	With adapter 2

Where RE $\geq$ 1G: Radiated Emission above 1GHz & Bandedge Measurement  
 RE<1G: Radiated Emission below 1GHz  
 PLC: Power Line Conducted Emission  
 APCM: Antenna Port Conducted Measurement

**NOTE:** The EUT had been pre-tested on the positioned of each 2 axis. The worst case was found when positioned on **Y-plane**.  
**NOTE:** "-" means no effect.

#### **Radiated Emission Test (Above 1GHz):**

- Pre-Scan has been conducted to determine the worst-case mode from all possible combinations between available modulations, data rates and antenna ports (if EUT with antenna diversity architecture).
- Following channel(s) was (were) selected for the final test as listed below.

MODE	AVAILABLE CHANNEL	TESTED CHANNEL	MODULATION TECHNOLOGY	MODULATION TYPE	DATA RATE (Mbps)
802.11b	1 to 11	1, 6, 11	DSSS	DBPSK	1
802.11g	1 to 11	1, 6, 11	OFDM	BPSK	6
802.11n (HT20)	1 to 11	1, 6, 11	OFDM	BPSK	6.5

#### **Radiated Emission Test (Below 1GHz):**

- Pre-Scan has been conducted to determine the worst-case mode from all possible combinations between available modulations, data rates and antenna ports (if EUT with antenna diversity architecture).
- Following channel(s) was (were) selected for the final test as listed below.

MODE	AVAILABLE CHANNEL	TESTED CHANNEL	MODULATION TECHNOLOGY	MODULATION TYPE	DATA RATE (Mbps)
802.11g	1 to 11	6	OFDM	BPSK	6

#### **Power Line Conducted Emission Test:**

- Pre-Scan has been conducted to determine the worst-case mode from all possible combinations between available modulations, data rates and antenna ports (if EUT with antenna diversity architecture).
- Following channel(s) was (were) selected for the final test as listed below.

MODE	AVAILABLE CHANNEL	TESTED CHANNEL	MODULATION TECHNOLOGY	MODULATION TYPE	DATA RATE (Mbps)
802.11g	1 to 11	6	OFDM	BPSK	6

**Antenna Port Conducted Measurement:**

- This item includes all test value of each mode, but only includes spectrum plot of worst value of each mode.
- Pre-Scan has been conducted to determine the worst-case mode from all possible combinations between available modulations, data rates and antenna ports (if EUT with antenna diversity architecture).
- Following channel(s) was (were) selected for the final test as listed below.

MODE	AVAILABLE CHANNEL	TESTED CHANNEL	MODULATION TECHNOLOGY	MODULATION TYPE	DATA RATE (Mbps)
802.11b	1 to 11	1, 6, 11	DSSS	DBPSK	1
802.11g	1 to 11	1, 6, 11	OFDM	BPSK	6
802.11n (HT20)	1 to 11	1, 6, 11	OFDM	BPSK	6.5

**Test Condition:**

APPLICABLE TO	ENVIRONMENTAL CONDITIONS	INPUT POWER	TESTED BY
RE≥1G	25deg. C, 69%RH	120Vac, 60Hz	Tim Ho
RE<1G	26deg. C, 72%RH	120Vac, 60Hz	Gary Cheng
PLC	25deg. C, 70%RH 25deg. C, 63%RH	120Vac, 60Hz	Mike Hsieh JyunChun.Lin
APCM	25deg. C, 60%RH	120Vac, 60Hz	Andy Ho

### 3.3 Duty Cycle of Test Signal

Duty cycle of test signal is  $\geq 98\%$ , duty factor is not required.

**802.11b:** Duty cycle =  $12.506/12.524 = 0.999$

**802.11g:** Duty cycle =  $2.072/2.084 = 0.994$

**802.11n (HT20):** Duty cycle =  $1.94/1.964 = 0.988$

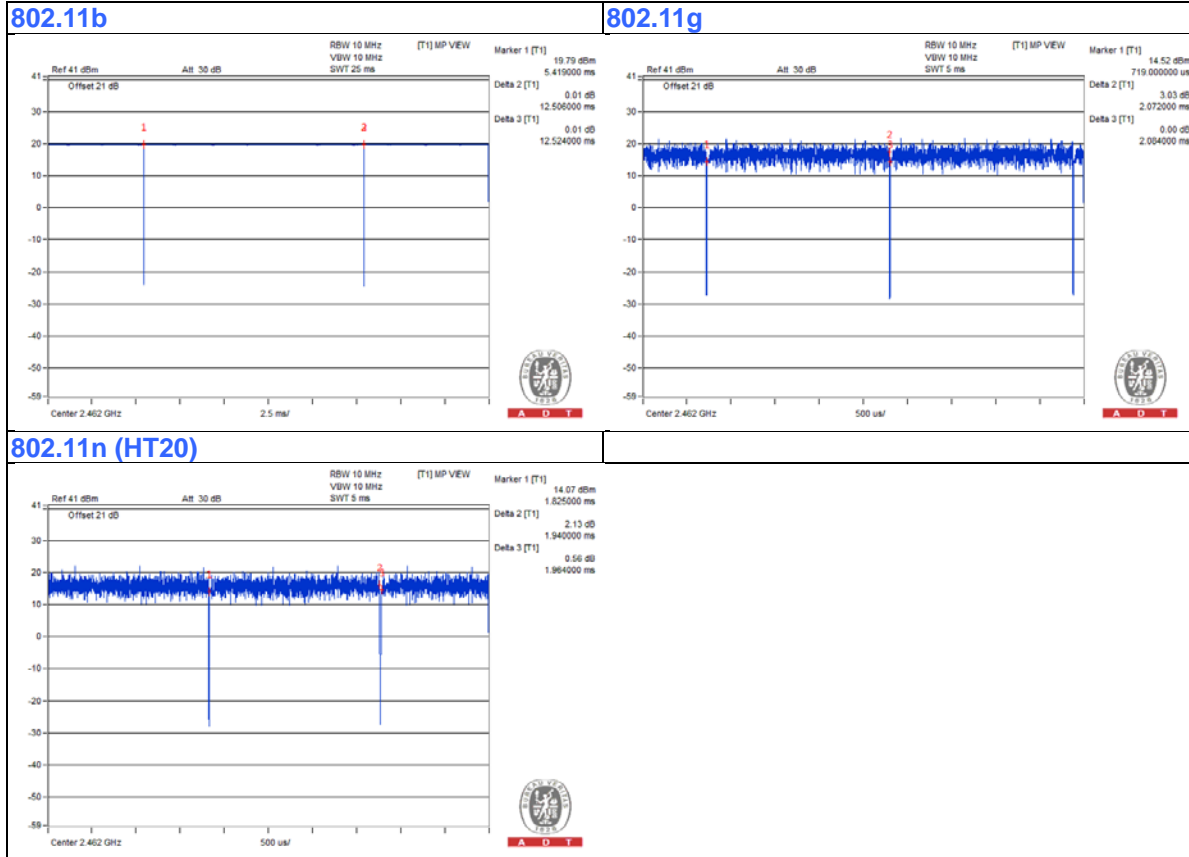

### 3.4 Description of Support Units

The EUT has been tested as an independent unit together with other necessary accessories or support units. The following support units or accessories were used to form a representative test configuration during the tests.

ID	Product	Brand	Model No.	Serial No.	FCC ID	Remarks
A.	Micro SD Card	NA	NA	3	NA	Provided by Lab

Note:

- All power cords of the above support units are non-shielded (1.8m).

ID	Descriptions	Qty.	Length (m)	Shielding (Yes/No)	Cores (Qty.)	Remarks
1.	USB	1	3	No	0	Supplied by Client

#### 3.4.1 Configuration of System under Test

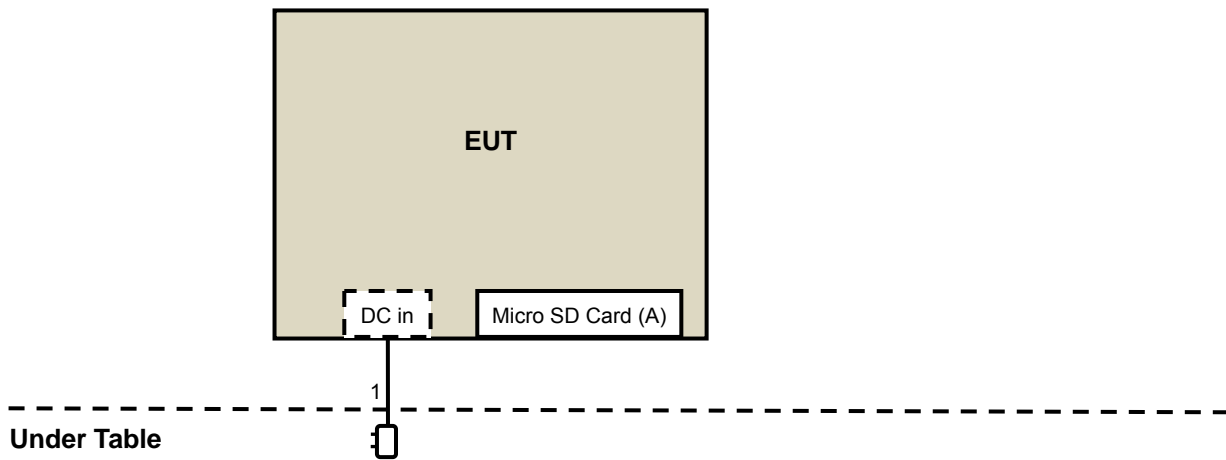

### 3.5 General Description of Applied Standards

The EUT is a RF Product. According to the specifications of the manufacturer, it must comply with the requirements of the following standards:

**FCC Part 15, Subpart C (15.247)**  
**558074 D01 DTS Meas Guidance v03r02**

ANSI C63.10-2009

All test items have been performed and recorded as per the above standards.

**NOTE:** The EUT has been verified to comply with the requirements of FCC Part 15, Subpart B, Class B (DoC). The test report has been issued separately.

## 4 Test Types and Results

### 4.1 Radiated Emission and Bandedge Measurement

#### 4.1.1 Limits of Radiated Emission and Bandedge Measurement

Radiated emissions which fall in the restricted bands must comply with the radiated emission limits specified as below table. Other emissions shall be at least 30dB below the highest level of the desired power:

Frequencies (MHz)	Field Strength (microvolts/meter)	Measurement Distance (meters)
0.009 ~ 0.490	2400/F(kHz)	300
0.490 ~ 1.705	24000/F(kHz)	30
1.705 ~ 30.0	30	30
30 ~ 88	100	3
88 ~ 216	150	3
216 ~ 960	200	3
Above 960	500	3

**NOTE:**

1. The lower limit shall apply at the transition frequencies.
2. Emission level (dBuV/m) = 20 log Emission level (uV/m).
3. For frequencies above 1000MHz, the field strength limits are based on average detector, however, the peak field strength of any emission shall not exceed the maximum permitted average limits, specified above by more than 20dB under any condition of modulation.

**4.1.2 Test Instruments**

<b>DESCRIPTION &amp; MANUFACTURER</b>	<b>MODEL NO.</b>	<b>SERIAL NO.</b>	<b>CALIBRATED DATE</b>	<b>CALIBRATED UNTIL</b>
Test Receiver Agilent	N9038A	MY51210105	July 21, 2014	July 20, 2015
Pre-Amplifier Mini-Circuits	ZFL-1000VH2 B	AMP-ZFL-03	Nov. 12, 2014	Nov. 11, 2015
Trilog Broadband Antenna SCHWARZBECK	VULB 9168	9168-360	Feb. 06, 2015	Feb. 05, 2016
RF Cable	NA	CHGCAB_001	Oct. 04, 2014	Oct. 03, 2015
Horn_Antenna AISI	AIH.8018	0000320091110	Feb. 09, 2015	Feb. 08, 2016
Pre-Amplifier Agilent	8449B	3008A02578	June 24, 2014	June 23, 2015
RF Cable	NA	131205 131216 131217 SNMY23684/4	Jan. 16, 2015	Jan. 15, 2016
Spectrum Analyzer R&S	FSV40	100964	July 05, 2014	July 04, 2015
Pre-Amplifier SPACEK LABS	SLKKa-48-6	9K16	Dec. 12, 2014	Dec. 11, 2015
Horn_Antenna SCHWARZBECK	BBHA 9170	9170-424	Feb. 05, 2015	Feb. 04, 2016
RF Cable	NA	329751/4 RF104-204	Dec. 11, 2014	Dec. 10, 2015
Antenna Tower & Turn Table CT	NA	NA	NA	NA
Spectrum Analyzer R&S	FSP 40	100060	May 08, 2015	May 07, 2016
Power meter Anritsu	ML2495A	1014008	Apr. 28, 2015	Apr. 27, 2016
Power sensor Anritsu	MA2411B	0917122	Apr. 28, 2015	Apr. 27, 2016

**Note:**

1. The calibration interval of the above test instruments is 12 months and the calibrations are traceable to NML/ROC and NIST/USA.
2. The test was performed in 966 Chamber No. G.
3. The FCC Site Registration No. is 966073.
4. The VCCI Site Registration No. is G-137.
5. The CANADA Site Registration No. is IC 7450H-2.
6. Tested Date: May 19 to July 29, 2015

#### 4.1.3 Test Procedures

- a. The EUT was placed on the top of a rotating table 0.8 meters above the ground at 3 meter chamber room for test. The table was rotated 360 degrees to determine the position of the highest radiation.
- b. The EUT was set 3 meters away from the interference-receiving antenna, which was mounted on the top of a variable-height antenna tower.
- c. The height of antenna is varied from one meter to four meters above the ground to determine the maximum value of the field strength. Both horizontal and vertical polarizations of the antenna are set to make the measurement.
- d. For each suspected emission, the EUT was arranged to its worst case and then the antenna was tuned to heights from 1 meter to 4 meters and the rotatable table was turned from 0 degrees to 360 degrees to find the maximum reading.
- e. The test-receiver system was set to quasi-peak detect function and specified bandwidth with maximum hold mode when the test frequency is below 1 GHz.
- f. The test-receiver system was set to peak and average detect function and specified bandwidth with maximum hold mode when the test frequency is above 1 GHz. If the peak reading value also meets average limit, measurement with the average detector is unnecessary.

#### Note:

1. For emission measurements above 1 GHz, the EUT shall be placed at a height of 1.5 m above the ground at 3 meter chamber room for test
2. The resolution bandwidth and video bandwidth of test receiver/spectrum analyzer is 120kHz for Quasi-peak detection (QP) at frequency below 1GHz.
3. The resolution bandwidth of test receiver/spectrum analyzer is 1 MHz and the video bandwidth is 3 MHz for Peak detection (PK) at frequency above 1GHz.
4. The resolution bandwidth of test receiver/spectrum analyzer is 1MHz and the video bandwidth is 3MHz for RMS Average (Duty cycle < 98%) for Average detection (AV) at frequency above 1GHz, then the measurement results was added to a correction factor ( $10 \log(1/\text{duty cycle})$ ).
5. The resolution bandwidth of test receiver/spectrum analyzer is 1MHz and the video bandwidth is 10Hz (Duty cycle  $\geq 98\%$ ) for Average detection (AV) at frequency above 1GHz.
6. All modes of operation were investigated and the worst-case emissions are reported.

#### 4.1.4 Deviation from Test Standard

No deviation.



4.1.5 Test Setup

**<Frequency Range below 1GHz>**

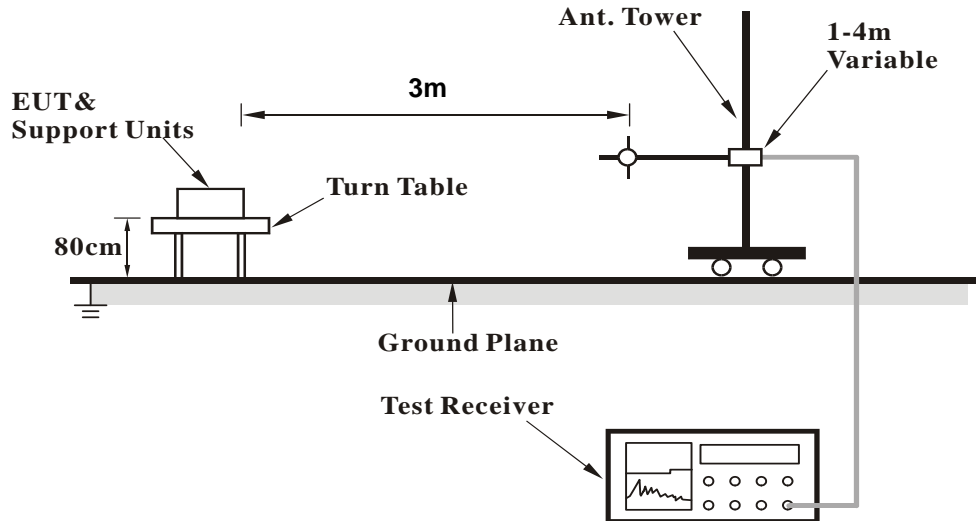

**<Frequency Range above 1GHz>**

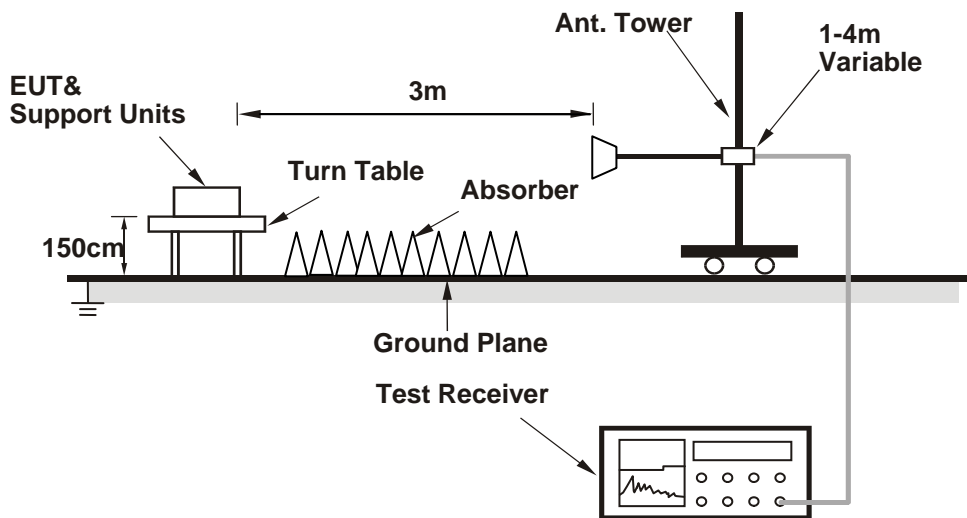

For the actual test configuration, please refer to the attached file (Test Setup Photo).

4.1.6 EUT Operating Conditions

1. The EUT which is placed on a testing table.
2. The communication partner run test program "MT7601USB.exe" to enable EUT under transmission/receiving condition continuously at specific channel frequency.

4.1.7 Test Results

Above 1GHz Data

802.11b

<b>CHANNEL</b>	TX Channel 1	<b>DETECTOR FUNCTION</b>	Peak (PK)
<b>FREQUENCY RANGE</b>	1GHz ~ 25GHz		Average (AV)

**ANTENNA POLARITY & TEST DISTANCE: HORIZONTAL AT 3 M**

NO.	FREQ. (MHz)	EMISSION LEVEL (dBuV/m)	LIMIT (dBuV/m)	MARGIN (dB)	ANTENNA HEIGHT (m)	TABLE ANGLE (Degree)	RAW VALUE (dBuV)	CORRECTION FACTOR (dB/m)
1	2390.00	51.7 PK	74.0	-22.3	1.54 H	26	51.86	-0.16
2	2390.00	42.5 AV	54.0	-11.5	1.54 H	26	42.66	-0.16
3	*2412.00	101.0 PK			1.59 H	18	101.10	-0.10
4	*2412.00	96.3 AV			1.59 H	18	96.40	-0.10
5	4824.00	53.4 PK	74.0	-20.6	2.25 H	186	44.64	8.76
6	4824.00	48.5 AV	54.0	-5.5	2.25 H	186	39.74	8.76

**ANTENNA POLARITY & TEST DISTANCE: VERTICAL AT 3 M**

NO.	FREQ. (MHz)	EMISSION LEVEL (dBuV/m)	LIMIT (dBuV/m)	MARGIN (dB)	ANTENNA HEIGHT (m)	TABLE ANGLE (Degree)	RAW VALUE (dBuV)	CORRECTION FACTOR (dB/m)
1	2390.00	56.4 PK	74.0	-17.6	1.81 V	284	56.56	-0.16
2	2390.00	45.9 AV	54.0	-8.1	1.81 V	284	46.06	-0.16
3	*2412.00	109.7 PK			1.81 V	284	109.80	-0.10
4	*2412.00	106.2 AV			1.81 V	284	106.30	-0.10
5	4824.00	54.5 PK	74.0	-19.5	1.59 V	261	45.74	8.76
6	4824.00	50.8 AV	54.0	-3.2	1.59 V	261	42.04	8.76

**REMARKS:**

1. Emission Level(dBuV/m) = Raw Value(dBuV) + Correction Factor(dB/m)
2. Correction Factor(dB/m) = Antenna Factor(dB/m) + Cable Factor(dB) – Pre-Amplifier Factor(dB)
3. The other emission levels were very low against the limit.
4. Margin value = Emission Level – Limit value
5. " \* ": Fundamental frequency.

<b>CHANNEL</b>	TX Channel 6	<b>DETECTOR FUNCTION</b>	Peak (PK)
<b>FREQUENCY RANGE</b>	1GHz ~ 25GHz		Average (AV)

**ANTENNA POLARITY & TEST DISTANCE: HORIZONTAL AT 3 M**

NO.	FREQ. (MHz)	EMISSION LEVEL (dBuV/m)	LIMIT (dBuV/m)	MARGIN (dB)	ANTENNA HEIGHT (m)	TABLE ANGLE (Degree)	RAW VALUE (dBuV)	CORRECTION FACTOR (dB/m)
1	2390.00	49.2 PK	74.0	-24.8	1.58 H	9	49.36	-0.16
2	2390.00	39.5 AV	54.0	-14.5	1.58 H	9	39.66	-0.16
3	*2437.00	101.1 PK			1.58 H	9	101.13	-0.03
4	*2437.00	96.2 AV			1.58 H	9	96.23	-0.03
5	2483.50	47.1 PK	74.0	-26.9	1.58 H	9	46.99	0.11
6	2483.50	36.3 AV	54.0	-17.7	1.58 H	9	36.19	0.11
7	4874.00	53.2 PK	74.0	-20.8	2.24 H	170	44.29	8.91
8	4874.00	48.5 AV	54.0	-5.5	2.24 H	170	39.59	8.91
9	7311.00	56.8 PK	74.0	-17.2	1.10 H	315	40.35	16.45
10	7311.00	45.3 AV	54.0	-8.7	1.10 H	315	28.85	16.45

**ANTENNA POLARITY & TEST DISTANCE: VERTICAL AT 3 M**

NO.	FREQ. (MHz)	EMISSION LEVEL (dBuV/m)	LIMIT (dBuV/m)	MARGIN (dB)	ANTENNA HEIGHT (m)	TABLE ANGLE (Degree)	RAW VALUE (dBuV)	CORRECTION FACTOR (dB/m)
1	2390.00	56.0 PK	74.0	-18.0	1.69 V	285	56.16	-0.16
2	2390.00	45.1 AV	54.0	-8.9	1.69 V	285	45.26	-0.16
3	*2437.00	109.9 PK			1.69 V	285	109.93	-0.03
4	*2437.00	106.3 AV			1.69 V	285	106.33	-0.03
5	2483.50	54.8 PK	74.0	-19.2	1.69 V	285	54.69	0.11
6	2483.50	42.6 AV	54.0	-11.4	1.69 V	285	42.49	0.11
7	4874.00	54.5 PK	74.0	-19.5	1.62 V	262	45.59	8.91
8	4874.00	50.7 AV	54.0	-3.3	1.62 V	262	41.79	8.91
9	7311.00	55.9 PK	74.0	-18.1	1.00 V	248	39.45	16.45
10	7311.00	44.5 AV	54.0	-9.5	1.00 V	248	28.05	16.45

**REMARKS:**

1. Emission Level(dBuV/m) = Raw Value(dBuV) + Correction Factor(dB/m)
2. Correction Factor(dB/m) = Antenna Factor(dB/m) + Cable Factor(dB) – Pre-Amplifier Factor(dB)
3. The other emission levels were very low against the limit.
4. Margin value = Emission Level – Limit value
5. " \* ": Fundamental frequency.

<b>CHANNEL</b>	TX Channel 11	<b>DETECTOR FUNCTION</b>	Peak (PK)
<b>FREQUENCY RANGE</b>	1GHz ~ 25GHz		Average (AV)

**ANTENNA POLARITY & TEST DISTANCE: HORIZONTAL AT 3 M**

NO.	FREQ. (MHz)	EMISSION LEVEL (dBuV/m)	LIMIT (dBuV/m)	MARGIN (dB)	ANTENNA HEIGHT (m)	TABLE ANGLE (Degree)	RAW VALUE (dBuV)	CORRECTION FACTOR (dB/m)
1	*2462.00	102.0 PK			1.53 H	11	101.95	0.05
2	*2462.00	97.7 AV			1.53 H	11	97.65	0.05
3	2483.50	51.5 PK	74.0	-22.5	1.53 H	11	51.39	0.11
4	2483.50	42.2 AV	54.0	-11.8	1.53 H	11	42.09	0.11
5	4924.00	53.3 PK	74.0	-20.7	2.28 H	177	44.21	9.09
6	4924.00	48.8 AV	54.0	-5.2	2.28 H	177	39.71	9.09
7	7386.00	56.4 PK	74.0	-17.6	1.11 H	299	39.80	16.60
8	7386.00	44.9 AV	54.0	-9.1	1.11 H	299	28.30	16.60

**ANTENNA POLARITY & TEST DISTANCE: VERTICAL AT 3 M**

NO.	FREQ. (MHz)	EMISSION LEVEL (dBuV/m)	LIMIT (dBuV/m)	MARGIN (dB)	ANTENNA HEIGHT (m)	TABLE ANGLE (Degree)	RAW VALUE (dBuV)	CORRECTION FACTOR (dB/m)
1	*2462.00	111.1 PK			1.71 V	283	111.05	0.05
2	*2462.00	107.7 AV			1.71 V	283	107.65	0.05
3	2483.50	59.4 PK	74.0	-14.6	1.71 V	283	59.29	0.11
4	2483.50	47.9 AV	54.0	-6.1	1.71 V	283	47.79	0.11
5	4924.00	54.2 PK	74.0	-19.8	1.94 V	247	45.11	9.09
6	4924.00	50.7 AV	54.0	-3.3	1.94 V	247	41.61	9.09
7	7386.00	56.0 PK	74.0	-18.0	1.02 V	262	39.40	16.60
8	7386.00	44.3 AV	54.0	-9.7	1.02 V	262	27.70	16.60

**REMARKS:**

1. Emission Level(dBuV/m) = Raw Value(dBuV) + Correction Factor(dB/m)
2. Correction Factor(dB/m) = Antenna Factor(dB/m) + Cable Factor(dB) – Pre-Amplifier Factor(dB)
3. The other emission levels were very low against the limit.
4. Margin value = Emission Level – Limit value
5. " \* ": Fundamental frequency.

802.11g

<b>CHANNEL</b>	TX Channel 1	<b>DETECTOR FUNCTION</b>	Peak (PK)
<b>FREQUENCY RANGE</b>	1GHz ~ 25GHz		Average (AV)

**ANTENNA POLARITY & TEST DISTANCE: HORIZONTAL AT 3 M**

NO.	FREQ. (MHz)	EMISSION LEVEL (dBuV/m)	LIMIT (dBuV/m)	MARGIN (dB)	ANTENNA HEIGHT (m)	TABLE ANGLE (Degree)	RAW VALUE (dBuV)	CORRECTION FACTOR (dB/m)
1	2390.00	61.2 PK	74.0	-12.8	1.53 H	34	61.36	-0.16
2	2390.00	45.5 AV	54.0	-8.5	1.53 H	34	45.66	-0.16
3	*2412.00	101.2 PK			1.53 H	34	101.30	-0.10
4	*2412.00	92.1 AV			1.53 H	34	92.20	-0.10
5	4824.00	47.2 PK	74.0	-26.8	2.33 H	191	38.44	8.76
6	4824.00	40.2 AV	54.0	-13.8	2.33 H	191	31.44	8.76

**ANTENNA POLARITY & TEST DISTANCE: VERTICAL AT 3 M**

NO.	FREQ. (MHz)	EMISSION LEVEL (dBuV/m)	LIMIT (dBuV/m)	MARGIN (dB)	ANTENNA HEIGHT (m)	TABLE ANGLE (Degree)	RAW VALUE (dBuV)	CORRECTION FACTOR (dB/m)
1	2390.00	66.9 PK	74.0	-7.1	1.82 V	280	67.06	-0.16
2	2390.00	50.4 AV	54.0	-3.6	1.82 V	280	50.56	-0.16
3	*2412.00	111.1 PK			1.82 V	280	111.20	-0.10
4	*2412.00	102.6 AV			1.82 V	280	102.70	-0.10
5	4824.00	49.8 PK	74.0	-24.2	1.26 V	212	41.04	8.76
6	4824.00	41.4 AV	54.0	-12.6	1.26 V	212	32.64	8.76

**REMARKS:**

1. Emission Level(dBuV/m) = Raw Value(dBuV) + Correction Factor(dB/m)
2. Correction Factor(dB/m) = Antenna Factor(dB/m) + Cable Factor(dB) – Pre-Amplifier Factor(dB)
3. The other emission levels were very low against the limit.
4. Margin value = Emission Level – Limit value
5. " \* ": Fundamental frequency.

<b>CHANNEL</b>	TX Channel 6	<b>DETECTOR FUNCTION</b>	Peak (PK)
<b>FREQUENCY RANGE</b>	1GHz ~ 25GHz		Average (AV)

**ANTENNA POLARITY & TEST DISTANCE: HORIZONTAL AT 3 M**

NO.	FREQ. (MHz)	EMISSION LEVEL (dBuV/m)	LIMIT (dBuV/m)	MARGIN (dB)	ANTENNA HEIGHT (m)	TABLE ANGLE (Degree)	RAW VALUE (dBuV)	CORRECTION FACTOR (dB/m)
1	2390.00	59.4 PK	74.0	-14.6	1.48 H	21	59.56	-0.16
2	2390.00	43.4 AV	54.0	-10.6	1.48 H	21	43.56	-0.16
3	*2437.00	107.5 PK			1.53 H	36	107.53	-0.03
4	*2437.00	97.9 AV			1.53 H	36	97.93	-0.03
5	2483.50	59.8 PK	74.0	-14.2	1.53 H	26	59.69	0.11
6	2483.50	43.5 AV	54.0	-10.5	1.53 H	26	43.39	0.11
7	4874.00	52.2 PK	74.0	-21.8	2.25 H	175	43.29	8.91
8	4874.00	45.2 AV	54.0	-8.8	2.25 H	175	36.29	8.91
9	7311.00	53.2 PK	74.0	-20.8	1.11 H	306	36.75	16.45
10	7311.00	41.1 AV	54.0	-12.9	1.11 H	306	24.65	16.45

**ANTENNA POLARITY & TEST DISTANCE: VERTICAL AT 3 M**

NO.	FREQ. (MHz)	EMISSION LEVEL (dBuV/m)	LIMIT (dBuV/m)	MARGIN (dB)	ANTENNA HEIGHT (m)	TABLE ANGLE (Degree)	RAW VALUE (dBuV)	CORRECTION FACTOR (dB/m)
1	2390.00	64.3 PK	74.0	-9.7	1.54 V	275	64.46	-0.16
2	2390.00	49.1 AV	54.0	-4.9	1.54 V	275	49.26	-0.16
3	*2437.00	117.5 PK			1.54 V	275	117.53	-0.03
4	*2437.00	108.9 AV			1.54 V	275	108.93	-0.03
5	2483.50	65.5 PK	74.0	-8.5	1.54 V	275	65.39	0.11
6	2483.50	49.5 AV	54.0	-4.5	1.54 V	275	49.39	0.11
7	4874.00	52.1 PK	74.0	-21.9	1.16 V	218	43.19	8.91
8	4874.00	48.2 AV	54.0	-5.8	1.16 V	218	39.29	8.91
9	7311.00	55.4 PK	74.0	-18.6	1.00 V	215	38.95	16.45
10	7311.00	43.0 AV	54.0	-11.0	1.00 V	215	26.55	16.45

**REMARKS:**

1. Emission Level(dBuV/m) = Raw Value(dBuV) + Correction Factor(dB/m)
2. Correction Factor(dB/m) = Antenna Factor(dB/m) + Cable Factor(dB) – Pre-Amplifier Factor(dB)
3. The other emission levels were very low against the limit.
4. Margin value = Emission Level – Limit value
5. " \* ": Fundamental frequency.

<b>CHANNEL</b>	TX Channel 11	<b>DETECTOR FUNCTION</b>	Peak (PK)
<b>FREQUENCY RANGE</b>	1GHz ~ 25GHz		Average (AV)

**ANTENNA POLARITY & TEST DISTANCE: HORIZONTAL AT 3 M**

NO.	FREQ. (MHz)	EMISSION LEVEL (dBuV/m)	LIMIT (dBuV/m)	MARGIN (dB)	ANTENNA HEIGHT (m)	TABLE ANGLE (Degree)	RAW VALUE (dBuV)	CORRECTION FACTOR (dB/m)
1	*2462.00	101.5 PK			1.48 H	36	101.45	0.05
2	*2462.00	92.4 AV			1.48 H	36	92.35	0.05
3	2483.50	61.8 PK	74.0	-12.2	1.52 H	27	61.69	0.11
4	2483.50	45.8 AV	54.0	-8.2	1.52 H	27	45.69	0.11
5	4924.00	46.5 PK	74.0	-27.5	2.32 H	172	37.41	9.09
6	4924.00	39.7 AV	54.0	-14.3	2.32 H	172	30.61	9.09
7	7386.00	52.4 PK	74.0	-21.6	1.09 H	307	35.80	16.60
8	7386.00	40.7 AV	54.0	-13.3	1.09 H	307	24.10	16.60

**ANTENNA POLARITY & TEST DISTANCE: VERTICAL AT 3 M**

NO.	FREQ. (MHz)	EMISSION LEVEL (dBuV/m)	LIMIT (dBuV/m)	MARGIN (dB)	ANTENNA HEIGHT (m)	TABLE ANGLE (Degree)	RAW VALUE (dBuV)	CORRECTION FACTOR (dB/m)
1	*2462.00	110.8 PK			1.76 V	284	110.75	0.05
2	*2462.00	103.0 AV			1.76 V	284	102.95	0.05
3	2483.50	67.6 PK	74.0	-6.4	1.76 V	284	67.49	0.11
4	2483.50	50.5 AV	54.0	-3.5	1.76 V	284	50.39	0.11
5	4924.00	50.3 PK	74.0	-23.7	1.25 V	213	41.21	9.09
6	4924.00	41.7 AV	54.0	-12.3	1.25 V	213	32.61	9.09
7	7386.00	55.1 PK	74.0	-18.9	1.00 V	209	38.50	16.60
8	7386.00	42.9 AV	54.0	-11.1	1.00 V	209	26.30	16.60

**REMARKS:**

1. Emission Level(dBuV/m) = Raw Value(dBuV) + Correction Factor(dB/m)
2. Correction Factor(dB/m) = Antenna Factor(dB/m) + Cable Factor(dB) – Pre-Amplifier Factor(dB)
3. The other emission levels were very low against the limit.
4. Margin value = Emission Level – Limit value
5. " \* ": Fundamental frequency.

802.11n (HT20)

<b>CHANNEL</b>	TX Channel 1	<b>DETECTOR FUNCTION</b>	Peak (PK)
<b>FREQUENCY RANGE</b>	1GHz ~ 25GHz		Average (AV)

**ANTENNA POLARITY & TEST DISTANCE: HORIZONTAL AT 3 M**

NO.	FREQ. (MHz)	EMISSION LEVEL (dBuV/m)	LIMIT (dBuV/m)	MARGIN (dB)	ANTENNA HEIGHT (m)	TABLE ANGLE (Degree)	RAW VALUE (dBuV)	CORRECTION FACTOR (dB/m)
1	2390.00	61.0 PK	74.0	-13.0	1.52 H	33	61.16	-0.16
2	2390.00	45.5 AV	54.0	-8.5	1.52 H	33	45.66	-0.16
3	*2412.00	100.7 PK			1.56 H	49	100.80	-0.10
4	*2412.00	91.0 AV			1.56 H	49	91.10	-0.10
5	4824.00	47.4 PK	74.0	-26.6	2.26 H	190	38.64	8.76
6	4824.00	40.6 AV	54.0	-13.4	2.26 H	190	31.84	8.76

**ANTENNA POLARITY & TEST DISTANCE: VERTICAL AT 3 M**

NO.	FREQ. (MHz)	EMISSION LEVEL (dBuV/m)	LIMIT (dBuV/m)	MARGIN (dB)	ANTENNA HEIGHT (m)	TABLE ANGLE (Degree)	RAW VALUE (dBuV)	CORRECTION FACTOR (dB/m)
1	2390.00	67.9 PK	74.0	-6.1	1.83 V	264	68.06	-0.16
2	2390.00	50.8 AV	54.0	-3.2	1.83 V	264	50.96	-0.16
3	*2412.00	109.7 PK			1.83 V	264	109.80	-0.10
4	*2412.00	101.3 AV			1.83 V	264	101.40	-0.10
5	4824.00	49.8 PK	74.0	-24.2	1.28 V	215	41.04	8.76
6	4824.00	41.4 AV	54.0	-12.6	1.28 V	215	32.64	8.76

**REMARKS:**

1. Emission Level(dBuV/m) = Raw Value(dBuV) + Correction Factor(dB/m)
2. Correction Factor(dB/m) = Antenna Factor(dB/m) + Cable Factor(dB) – Pre-Amplifier Factor(dB)
3. The other emission levels were very low against the limit.
4. Margin value = Emission Level – Limit value
5. " \* ": Fundamental frequency.



<b>CHANNEL</b>	TX Channel 6	<b>DETECTOR FUNCTION</b>	Peak (PK)
<b>FREQUENCY RANGE</b>	1GHz ~ 25GHz		Average (AV)

**ANTENNA POLARITY & TEST DISTANCE: HORIZONTAL AT 3 M**

NO.	FREQ. (MHz)	EMISSION LEVEL (dBuV/m)	LIMIT (dBuV/m)	MARGIN (dB)	ANTENNA HEIGHT (m)	TABLE ANGLE (Degree)	RAW VALUE (dBuV)	CORRECTION FACTOR (dB/m)
1	2390.00	59.2 PK	74.0	-14.8	1.52 H	39	59.36	-0.16
2	2390.00	43.5 AV	54.0	-10.5	1.52 H	39	43.66	-0.16
3	*2437.00	105.8 PK			1.50 H	39	105.83	-0.03
4	*2437.00	96.1 AV			1.50 H	39	96.13	-0.03
5	2483.50	59.7 PK	74.0	-14.3	1.58 H	42	59.59	0.11
6	2483.50	43.5 AV	54.0	-10.5	1.58 H	42	43.39	0.11
7	4874.00	52.6 PK	74.0	-21.4	2.28 H	166	43.69	8.91
8	4874.00	45.5 AV	54.0	-8.5	2.28 H	166	36.59	8.91
9	7311.00	52.6 PK	74.0	-21.4	1.15 H	312	36.15	16.45
10	7311.00	40.6 AV	54.0	-13.4	1.15 H	312	24.15	16.45

**ANTENNA POLARITY & TEST DISTANCE: VERTICAL AT 3 M**

NO.	FREQ. (MHz)	EMISSION LEVEL (dBuV/m)	LIMIT (dBuV/m)	MARGIN (dB)	ANTENNA HEIGHT (m)	TABLE ANGLE (Degree)	RAW VALUE (dBuV)	CORRECTION FACTOR (dB/m)
1	2390.00	61.3 PK	74.0	-12.7	1.80 V	278	61.46	-0.16
2	2390.00	50.2 AV	54.0	-3.8	1.80 V	278	50.36	-0.16
3	*2437.00	115.2 PK			1.80 V	278	115.23	-0.03
4	*2437.00	106.7 AV			1.80 V	278	106.73	-0.03
5	2483.50	62.8 PK	74.0	-11.2	1.80 V	278	62.69	0.11
6	2483.50	48.4 AV	54.0	-5.6	1.80 V	278	48.29	0.11
7	4874.00	52.6 PK	74.0	-21.4	1.21 V	210	43.69	8.91
8	4874.00	48.6 AV	54.0	-5.4	1.21 V	210	39.69	8.91
9	7311.00	54.8 PK	74.0	-19.2	1.02 V	222	38.35	16.45
10	7311.00	42.5 AV	54.0	-11.5	1.02 V	222	26.05	16.45

**REMARKS:**

1. Emission Level(dBuV/m) = Raw Value(dBuV) + Correction Factor(dB/m)
2. Correction Factor(dB/m) = Antenna Factor(dB/m) + Cable Factor(dB) – Pre-Amplifier Factor(dB)
3. The other emission levels were very low against the limit.
4. Margin value = Emission Level – Limit value
5. " \* ": Fundamental frequency.

<b>CHANNEL</b>	TX Channel 11	<b>DETECTOR FUNCTION</b>	Peak (PK)
<b>FREQUENCY RANGE</b>	1GHz ~ 25GHz		Average (AV)

**ANTENNA POLARITY & TEST DISTANCE: HORIZONTAL AT 3 M**

NO.	FREQ. (MHz)	EMISSION LEVEL (dBuV/m)	LIMIT (dBuV/m)	MARGIN (dB)	ANTENNA HEIGHT (m)	TABLE ANGLE (Degree)	RAW VALUE (dBuV)	CORRECTION FACTOR (dB/m)
1	*2462.00	100.4 PK			1.58 H	18	100.35	0.05
2	*2462.00	90.9 AV			1.58 H	18	90.85	0.05
3	2483.50	61.4 PK	74.0	-12.6	1.57 H	43	61.29	0.11
4	2483.50	45.9 AV	54.0	-8.1	1.57 H	43	45.79	0.11
5	4924.00	46.6 PK	74.0	-27.4	2.24 H	192	37.51	9.09
6	4924.00	39.9 AV	54.0	-14.1	2.24 H	192	30.81	9.09
7	7386.00	52.4 PK	74.0	-21.6	1.08 H	307	35.80	16.60
8	7386.00	40.7 AV	54.0	-13.3	1.08 H	307	24.10	16.60

**ANTENNA POLARITY & TEST DISTANCE: VERTICAL AT 3 M**

NO.	FREQ. (MHz)	EMISSION LEVEL (dBuV/m)	LIMIT (dBuV/m)	MARGIN (dB)	ANTENNA HEIGHT (m)	TABLE ANGLE (Degree)	RAW VALUE (dBuV)	CORRECTION FACTOR (dB/m)
1	*2462.00	110.8 PK			1.78 V	287	110.75	0.05
2	*2462.00	102.7 AV			1.78 V	287	102.65	0.05
3	2483.50	69.8 PK	74.0	-4.2	1.78 V	286	69.69	0.11
4	2483.50	50.2 AV	54.0	-3.8	1.78 V	286	50.09	0.11
5	4924.00	50.5 PK	74.0	-23.5	1.29 V	220	41.41	9.09
6	4924.00	41.8 AV	54.0	-12.2	1.29 V	220	32.71	9.09
7	7386.00	54.9 PK	74.0	-19.1	1.00 V	206	38.30	16.60
8	7386.00	42.8 AV	54.0	-11.2	1.00 V	206	26.20	16.60

**REMARKS:**

1. Emission Level(dBuV/m) = Raw Value(dBuV) + Correction Factor(dB/m)
2. Correction Factor(dB/m) = Antenna Factor(dB/m) + Cable Factor(dB) – Pre-Amplifier Factor(dB)
3. The other emission levels were very low against the limit.
4. Margin value = Emission Level – Limit value
5. " \* ": Fundamental frequency.

**Below 1GHz Data**

**802.11g**

<b>CHANNEL</b>	TX Channel 6	<b>DETECTOR FUNCTION</b>	Quasi-Peak (QP)
<b>FREQUENCY RANGE</b>	30MHz ~ 1GHz		

**ANTENNA POLARITY & TEST DISTANCE: HORIZONTAL AT 3 M**

NO.	FREQ. (MHz)	EMISSION LEVEL (dBuV/m)	LIMIT (dBuV/m)	MARGIN (dB)	ANTENNA HEIGHT (m)	TABLE ANGLE (Degree)	RAW VALUE (dBuV)	CORRECTION FACTOR (dB/m)
1	149.99	28.9 QP	43.5	-14.6	2.00 H	70	41.85	-12.92
2	250.00	35.4 QP	46.0	-10.7	1.00 H	96	49.36	-14.01
3	350.00	34.2 QP	46.0	-11.9	1.00 H	40	44.96	-10.81
4	400.01	37.1 QP	46.0	-8.9	1.00 H	56	46.48	-9.39
5	649.98	39.3 QP	46.0	-6.8	1.50 H	0	42.66	-3.41
6	799.99	41.9 QP	46.0	-4.1	1.00 H	130	42.55	-0.64

**ANTENNA POLARITY & TEST DISTANCE: VERTICAL AT 3 M**

NO.	FREQ. (MHz)	EMISSION LEVEL (dBuV/m)	LIMIT (dBuV/m)	MARGIN (dB)	ANTENNA HEIGHT (m)	TABLE ANGLE (Degree)	RAW VALUE (dBuV)	CORRECTION FACTOR (dB/m)
1	32.04	30.1 QP	40.0	-9.9	1.00 V	253	44.61	-14.47
2	82.14	29.6 QP	40.0	-10.4	1.00 V	323	47.73	-18.16
3	400.01	34.1 QP	46.0	-12.0	1.50 V	292	43.44	-9.39
4	550.02	36.9 QP	46.0	-9.1	1.00 V	360	42.76	-5.82
5	650.02	32.8 QP	46.0	-13.2	1.00 V	83	36.23	-3.41
6	799.98	42.6 QP	46.0	-3.4	1.12 V	355	43.22	-0.64

**REMARKS:**

1. Emission Level(dBuV/m) = Raw Value(dBuV) + Correction Factor(dB/m)
2. Correction Factor(dB/m) = Antenna Factor(dB/m) + Cable Factor(dB) – Pre-Amplifier Factor(dB)
3. The other emission levels were very low against the limit.
4. Margin value = Emission Level – Limit value

## 4.2 Conducted Emission Measurement

### 4.2.1 Limits of Conducted Emission Measurement

Frequency (MHz)	Conducted Limit (dBuV)	
	Quasi-peak	Average
0.15 - 0.5	66 - 56	56 - 46
0.50 - 5.0	56	46
5.0 - 30.0	60	50

Note: 1. The lower limit shall apply at the transition frequencies.

2. The limit decreases in line with the logarithm of the frequency in the range of 0.15 to 0.50MHz.

### 4.2.2 Test Instruments

#### For Mode 1

DESCRIPTION & MANUFACTURER	MODEL NO.	SERIAL NO.	CALIBRATED DATE	CALIBRATED UNTIL
Test Receiver ROHDE & SCHWARZ	ESCS 30	100375	May 06, 2015	May 05, 2016
Line-Impedance Stabilization Network (for EUT) SCHWARZBECK	NSLK-8127	8127-522	Sep. 15, 2014	Sep. 14, 2015
Line-Impedance Stabilization Network (for Peripheral) ROHDE & SCHWARZ	ENV216	100071	Nov. 10, 2014	Nov. 09, 2015
RF Cable (JYEBAO)	5D-FB	COCCAB-001	Mar. 09, 2015	Mar. 08, 2016
50 ohms Terminator	N/A	EMC-03	Sep. 22, 2014	Sep. 21, 2015
50 ohms Terminator	N/A	EMC-02	Sep. 30, 2014	Sep. 29, 2015
Software ADT	BV ADT_Cond_V7.3.7.3	NA	NA	NA

#### Note:

1. The calibration interval of the above test instruments is 12 months and the calibrations are traceable to NML/ROC and NIST/USA.
2. The test was performed in Shielded Room No. C.
3. The VCCI Con C Registration No. is C-3611.
4. Tested Date: May 19, 2015

**For Mode 2**

DESCRIPTION & MANUFACTURER	MODEL NO.	SERIAL NO.	CALIBRATED DATE	CALIBRATED UNTIL
Test Receiver R&S	ESCS 30	100375	May 06, 2015	May 05, 2016
Line-Impedance Stabilization Network (for EUT) SCHWARZBECK	NSLK-8127	8127-522	Sep. 15, 2014	Sep. 14, 2015
Line-Impedance Stabilization Network (for Peripheral) R&S	ENV216	100072	June 11, 2015	June 10, 2016
RF Cable	5D-FB	COCCAB-001	Mar. 09, 2015	Mar. 08, 2016
50 ohms Terminator	N/A	EMC-03	Sep. 22, 2014	Sep. 21, 2015
50 ohms Terminator	N/A	EMC-02	Sep. 30, 2014	Sep. 29, 2015
Software BVADT	BVADT_Cond_ V7.3.7.3	NA	NA	NA

**Note:**

1. The calibration interval of the above test instruments are 12 months and the calibrations are traceable to NML/ROC and NIST/USA.
2. The test was performed in Shielded Room No. C.
3. The VCCI Con C Registration No. is C-3611.
4. Tested Date: July 01, 2015

4.2.3 Test Procedures

- a. The EUT was placed 0.4 meters from the conducting wall of the shielded room with EUT being connected to the power mains through a line impedance stabilization network (LISN). Other support units were connected to the power mains through another LISN. The two LISNs provide 50 ohm/ 50uH of coupling impedance for the measuring instrument.
- b. Both lines of the power mains connected to the EUT were checked for maximum conducted interference.
- c. The frequency range from 150kHz to 30MHz was searched. Emission levels under (Limit - 20dB) was not recorded.

**NOTE:** The resolution bandwidth and video bandwidth of test receiver is 9kHz for quasi-peak detection (QP) and average detection (AV) at frequency 0.15MHz-30MHz.

4.2.4 Deviation from Test Standard

No deviation.

4.2.5 Test Setup

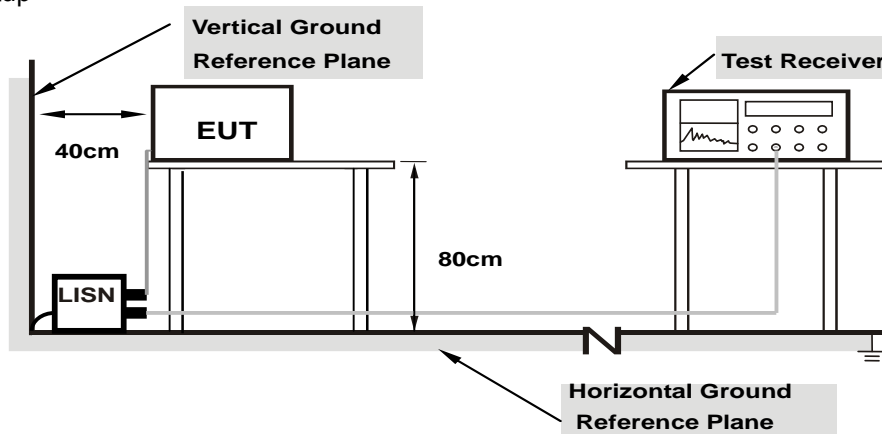

**Note:** 1.Support units were connected to second LISN.

For the actual test configuration, please refer to the attached file (Test Setup Photo).

4.2.6 EUT Operating Conditions

Same as 4.1.6.

4.2.7 Test Results (Mode 1)

Phase	Line (L)	Detector Function	Quasi-Peak (QP) / Average (AV)
-------	----------	-------------------	--------------------------------

No	Freq. [MHz]	Corr.	Reading Value		Emission Level		Limit		Margin	
		Factor	[dB (uV)]		[dB (uV)]		[dB (uV)]		(dB)	
	(dB)	Q.P.	AV.	Q.P.	AV.	Q.P.	AV.	Q.P.	AV.	
1	0.20078	0.09	29.53	18.56	29.62	18.65	63.58	53.58	-33.96	-34.93
2	0.42344	0.10	31.74	22.14	31.84	22.24	57.38	47.38	-25.54	-25.14
3	0.89219	0.12	26.28	16.23	26.40	16.35	56.00	46.00	-29.60	-29.65
4	1.58594	0.15	26.93	16.84	27.08	16.99	56.00	46.00	-28.92	-29.01
5	3.39844	0.20	31.96	23.04	32.16	23.24	56.00	46.00	-23.84	-22.76
6	12.92188	0.52	35.95	28.35	36.47	28.87	60.00	50.00	-23.53	-21.13

**REMARKS:**

1. Q.P. and AV. are abbreviations of quasi-peak and average individually.
2. The emission levels of other frequencies were very low against the limit.
3. Margin value = Emission level - Limit value
4. Correction factor = Insertion loss + Cable loss
5. Emission Level = Correction Factor + Reading Value.

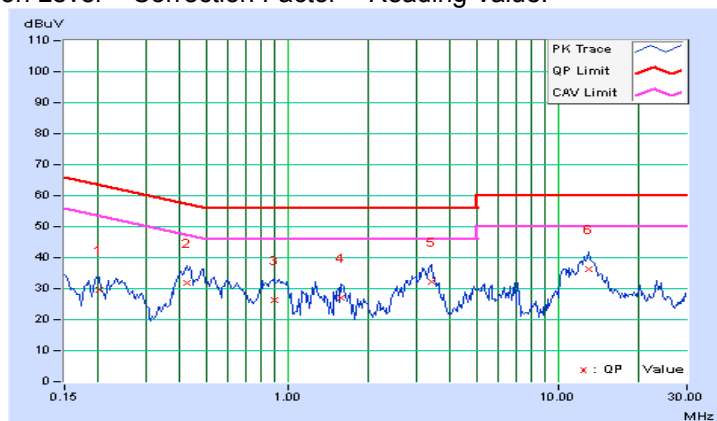

Phase	Neutral (N)	Detector Function	Quasi-Peak (QP) / Average (AV)
-------	-------------	-------------------	--------------------------------

No	Freq. [MHz]	Corr. Factor (dB)	Reading Value		Emission Level		Limit		Margin	
			[dB (uV)]		[dB (uV)]		[dB (uV)]		(dB)	
			Q.P.	AV.	Q.P.	AV.	Q.P.	AV.	Q.P.	AV.
1	0.15000	0.08	28.40	16.85	28.48	16.93	66.00	56.00	-37.52	-39.07
2	0.20078	0.08	27.27	16.93	27.35	17.01	63.58	53.58	-36.23	-36.57
3	0.41563	0.10	27.73	18.94	27.83	19.04	57.54	47.54	-29.70	-28.49
4	3.26172	0.21	27.82	18.77	28.03	18.98	56.00	46.00	-27.97	-27.02
5	13.27734	0.55	33.44	24.98	33.99	25.53	60.00	50.00	-26.01	-24.47
6	23.54297	0.83	24.85	12.08	25.68	12.91	60.00	50.00	-34.32	-37.09

**REMARKS:**

1. Q.P. and AV. are abbreviations of quasi-peak and average individually.
2. The emission levels of other frequencies were very low against the limit.
3. Margin value = Emission level - Limit value
4. Correction factor = Insertion loss + Cable loss
5. Emission Level = Correction Factor + Reading Value.

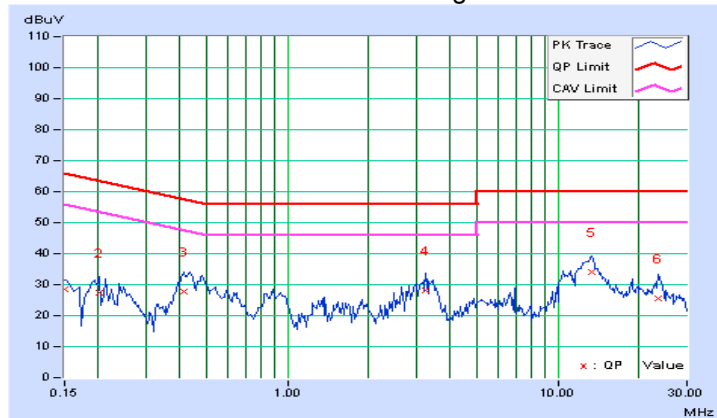



4.2.8 Test Results (Mode 2)

Phase	Line (L)	Detector Function	Quasi-Peak (QP) / Average (AV)
-------	----------	-------------------	--------------------------------

No	Freq. [MHz]	Corr.	Reading Value		Emission Level		Limit		Margin	
		Factor	[dB (uV)]		[dB (uV)]		[dB (uV)]		(dB)	
	(dB)	Q.P.	AV.	Q.P.	AV.	Q.P.	AV.	Q.P.	AV.	
1	0.42344	0.17	46.07	40.39	46.24	40.56	57.38	47.38	-11.14	-6.82
2	0.57188	0.18	39.24	32.46	39.42	32.64	56.00	46.00	-16.58	-13.36
3	0.66563	0.18	39.84	32.84	40.02	33.02	56.00	46.00	-15.98	-12.98
4	0.87656	0.19	41.68	34.35	41.87	34.54	56.00	46.00	-14.13	-11.46
5	1.21094	0.21	41.05	34.47	41.26	34.68	56.00	46.00	-14.74	-11.32
6	1.37109	0.22	40.46	33.60	40.68	33.82	56.00	46.00	-15.32	-12.18

REMARKS:

1. Q.P. and AV. are abbreviations of quasi-peak and average individually.
2. The emission levels of other frequencies were very low against the limit.
3. Margin value = Emission level - Limit value
4. Correction factor = Insertion loss + Cable loss
5. Emission Level = Correction Factor + Reading Value.

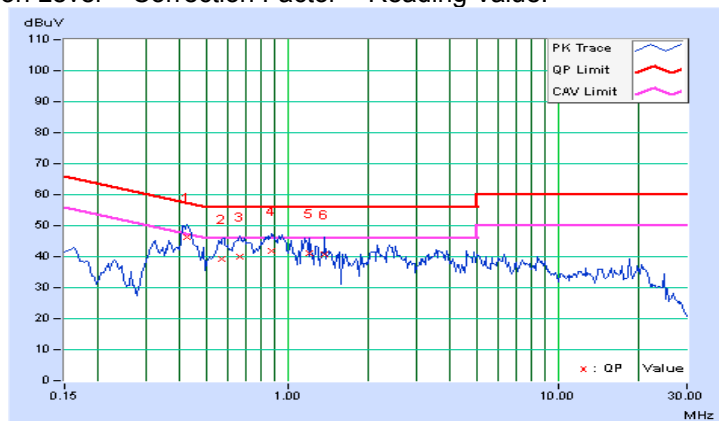

Phase	Neutral (N)	Detector Function	Quasi-Peak (QP) / Average (AV)
-------	-------------	-------------------	--------------------------------

No	Freq. [MHz]	Corr.	Reading Value		Emission Level		Limit		Margin	
		Factor	[dB (uV)]		[dB (uV)]		[dB (uV)]		(dB)	
		(dB)	Q.P.	AV.	Q.P.	AV.	Q.P.	AV.	Q.P.	AV.
1	0.42734	0.19	45.00	38.13	45.19	38.32	57.30	47.30	-12.11	-8.98
2	0.68125	0.21	39.73	30.07	39.94	30.28	56.00	46.00	-16.06	-15.72
3	0.97422	0.24	38.94	31.14	39.18	31.38	56.00	46.00	-16.82	-14.62
4	1.18359	0.25	38.86	31.02	39.11	31.27	56.00	46.00	-16.89	-14.73
5	1.42578	0.27	36.82	29.40	37.09	29.67	56.00	46.00	-18.91	-16.33
6	2.21875	0.31	37.08	29.44	37.39	29.75	56.00	46.00	-18.61	-16.25

**REMARKS:**

1. Q.P. and AV. are abbreviations of quasi-peak and average individually.
2. The emission levels of other frequencies were very low against the limit.
3. Margin value = Emission level - Limit value
4. Correction factor = Insertion loss + Cable loss
5. Emission Level = Correction Factor + Reading Value.

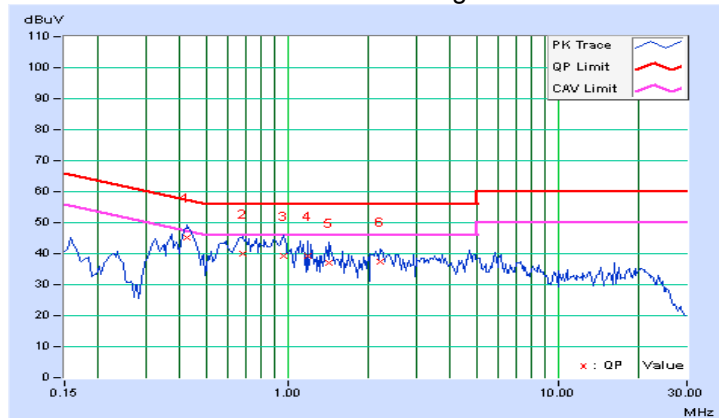

### 4.3 6dB Bandwidth Measurement

#### 4.3.1 Limits of 6dB Bandwidth Measurement

The minimum of 6dB Bandwidth Measurement is 0.5 MHz.

#### 4.3.2 Test Setup

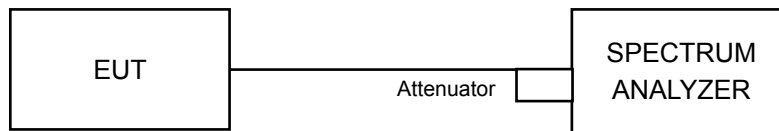

#### 4.3.3 Test Instruments

Refer to section 4.1.2 to get information of above instrument.

#### 4.3.4 Test Procedure

- a. Set resolution bandwidth (RBW) = 100kHz
- b. Set the video bandwidth (VBW)  $\geq 3 \times$  RBW, Detector = Peak.
- c. Trace mode = max hold.
- d. Sweep = auto couple.
- e. Measure the maximum width of the emission that is constrained by the frequencies associated with the two amplitude points (upper and lower) that are attenuated by 6 dB relative to the maximum level measured in the fundamental emission

#### 4.3.5 Deviation from Test Standard

No deviation.

#### 4.3.6 EUT Operating Conditions

The software provided by client to enable the EUT under transmission condition continuously at lowest, middle and highest channel frequencies individually.

## 4.3.7 Test Result

## 802.11b

Channel	Frequency (MHz)	6dB Bandwidth (MHz)	Minimum Limit (MHz)	Pass / Fail
1	2412	10.11	0.5	Pass
6	2437	10.09	0.5	Pass
11	2462	10.09	0.5	Pass

## 802.11g

Channel	Frequency (MHz)	6dB Bandwidth (MHz)	Minimum Limit (MHz)	Pass / Fail
1	2412	16.40	0.5	Pass
6	2437	16.39	0.5	Pass
11	2462	16.42	0.5	Pass

## 802.11n (HT20)

Channel	Frequency (MHz)	6dB Bandwidth (MHz)	Minimum Limit (MHz)	Pass / Fail
1	2412	17.36	0.5	Pass
6	2437	17.37	0.5	Pass
11	2462	17.36	0.5	Pass

### Spectrum Plot of Worst Value

#### 802.11b – channel 6

#### 802.11g – channel 6

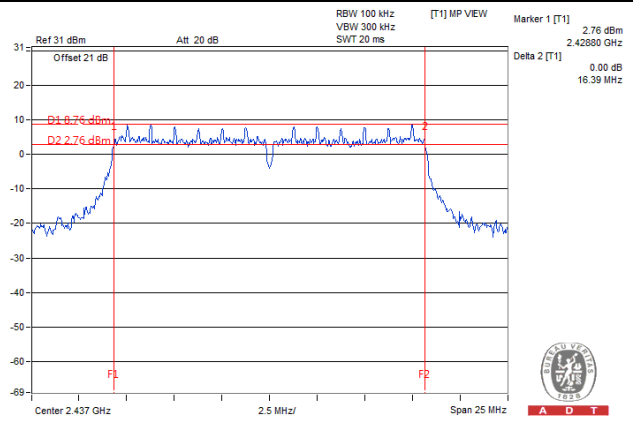
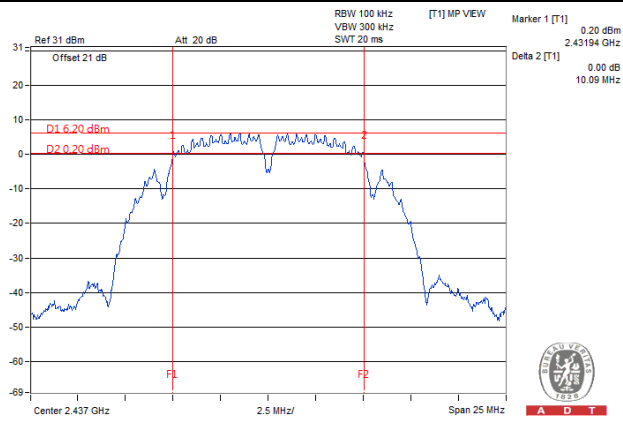

#### 802.11n (HT20) – channel 1

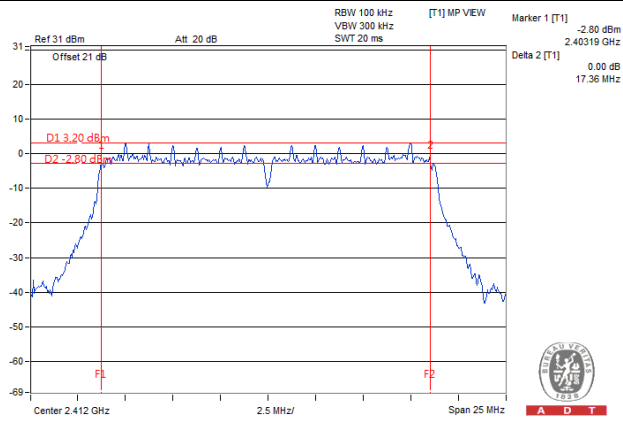

#### 4.4 Conducted Output Power Measurement

##### 4.4.1 Limits of Conducted Output Power Measurement

For systems using digital modulation in the 2400–2483.5 MHz bands: 1 Watt (30dBm)

##### 4.4.2 Test Setup

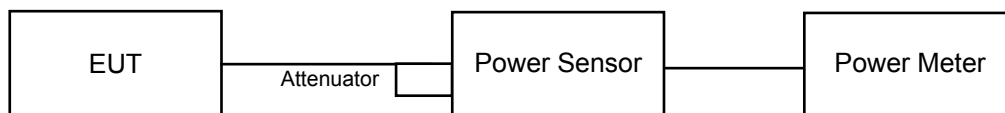

##### 4.4.3 Test Instruments

Refer to section 4.1.2 to get information of above instrument.

##### 4.4.4 Test Procedures

- a. Set span to at least 1.5 times the OBW.
- b. Set RBW = 1-5% of the OBW, not to exceed 1 MHz.
- c. Set VBW  $\geq 3 \times$  RBW.
- d. Number of points in sweep  $\geq 2 \times$  span / RBW
- e. Sweep time = auto.
- f. Detector = RMS (i.e., power averaging), or sample detector mode.
- g. If transmit duty cycle < 98 %, use a sweep trigger with the level set to enable triggering only on full power pulses. If the EUT transmits continuously (i.e., with no off intervals) or at duty cycle  $\geq 98$  %, and if each transmission is entirely at the maximum power control level, then the trigger shall be set to “free run”.
- h. Trace average at least 100 traces in power averaging (i.e., RMS) mode.

##### 4.4.5 Deviation from Test Standard

No deviation.

##### 4.4.6 EUT Operating Conditions

Same as Item 4.3.6.

#### 4.4.7 Test Results

##### 802.11b

Channel	Frequency (MHz)	Average Power (mW)	Average Power (dBm)	Limit (dBm)	Pass/Fail
1	2412	29.376	14.68	30	Pass
6	2437	29.717	14.73	30	Pass
11	2462	37.411	15.73	30	Pass

##### 802.11g

Channel	Frequency (MHz)	Average Power (mW)	Average Power (dBm)	Limit (dBm)	Pass/Fail
1	2412	28.379	14.53	30	Pass
6	2437	71.614	18.55	30	Pass
11	2462	19.055	12.80	30	Pass

##### 802.11n (HT20)

Channel	Frequency (MHz)	Average Power (mW)	Average Power (dBm)	Limit (dBm)	Pass/Fail
1	2412	20.045	13.02	30	Pass
6	2437	47.424	16.76	30	Pass
11	2462	15.136	11.80	30	Pass

## 4.5 Power Spectral Density Measurement

### 4.5.1 Limits of Power Spectral Density Measurement

The Maximum of Power Spectral Density Measurement is 8dBm.

### 4.5.2 Test Setup

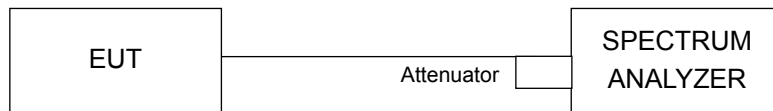

### 4.5.3 Test Instruments

Refer to section 4.1.2 to get information of above instrument.

### 4.5.4 Test Procedure

- a) Set instrument center frequency to DTS channel center frequency.
- b) Set span to at least 1.5 times the OBW.
- c) Set RBW to:  $3 \text{ kHz} \leq \text{RBW} \leq 100 \text{ kHz}$ .
- d) Set VBW  $\geq 3 \times \text{RBW}$ .
- e) Detector = power averaging (RMS) or sample detector (when RMS not available).
- f) Ensure that the number of measurement points in the sweep  $\geq 2 \times \text{span}/\text{RBW}$ .
- g) Sweep time = auto couple.
- h) Employ trace averaging (RMS) mode over a minimum of 100 traces.
- i) Use the peak marker function to determine the maximum amplitude level.

### 4.5.5 Deviation from Test Standard

No deviation.

### 4.5.6 EUT Operating Condition

Same as Item 4.3.6



## 4.5.7 Test Results

## 802.11b

Channel	Freq. (MHz)	PSD (dBm)	Limit (dBm)	Pass /Fail
1	2412	-12.43	8	Pass
6	2437	-11.89	8	Pass
11	2462	-11.05	8	Pass

## 802.11g

Channel	Freq. (MHz)	PSD (dBm)	Limit (dBm)	Pass /Fail
1	2412	-14.72	8	Pass
6	2437	-10.22	8	Pass
11	2462	-15.38	8	Pass

## 802.11n (HT20)

Channel	Freq. (MHz)	PSD (dBm)	Limit (dBm)	Pass /Fail
1	2412	-15.92	8	Pass
6	2437	-11.98	8	Pass
11	2462	-16.22	8	Pass

### Spectrum Plot of Worst Value

#### 802.11b – channel 11

#### 802.11g – channel 6

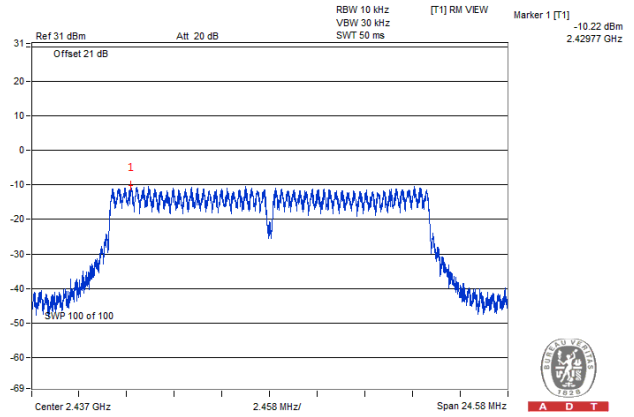
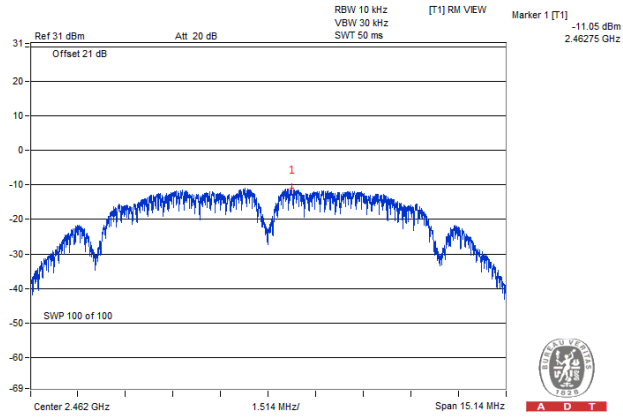

#### 802.11n (HT20) – channel 6

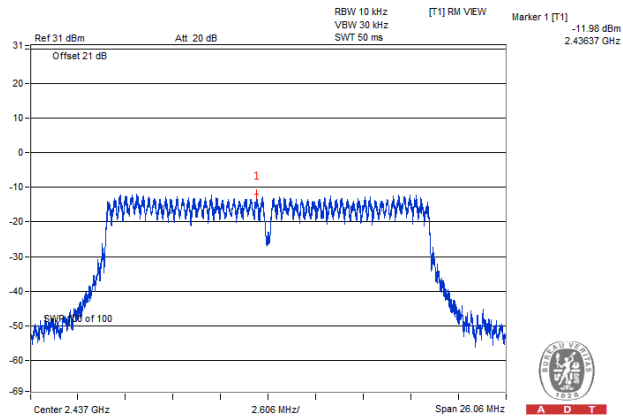

## 4.6 Conducted Out of Band Emission Measurement

### 4.6.1 Limits of Conducted Out of Band Emission Measurement

Below 30dB of the highest emission level of operating band (in 100kHz Resolution Bandwidth).

### 4.6.2 Test Setup

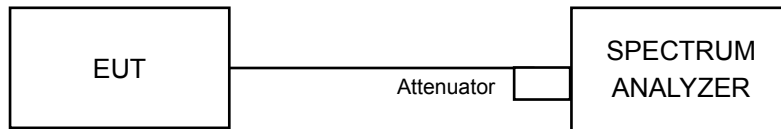

### 4.6.3 Test Instruments

Refer to section 4.1.2 to get information of above instrument.

### 4.6.4 Test Procedure

#### MEASUREMENT PROCEDURE REF

1. Set the RBW = 100 kHz.
2. Set the VBW  $\geq$  300 kHz.
3. Detector = peak.
4. Sweep time = auto couple.
5. Trace mode = max hold.
6. Allow trace to fully stabilize.
7. Use the peak marker function to determine the maximum power level in any 100 kHz band segment within the fundamental EBW.

#### MEASUREMENT PROCEDURE OOB

1. Set RBW = 100 kHz.
2. Set VBW  $\geq$  300 kHz.
3. Detector = peak.
4. Sweep = auto couple.
5. Trace Mode = max hold.
6. Allow trace to fully stabilize.
7. Use the peak marker function to determine the maximum amplitude level.

### 4.6.5 Deviation from Test Standard

No deviation.

### 4.6.6 EUT Operating Condition

Same as Item 4.3.6

### 4.6.7 Test Results

The spectrum plots are attached on the following pages. D1 line indicates the highest level, and D2 line indicates the 30dB offset below D1. It shows compliance with the requirement.

802.11b

CH 1

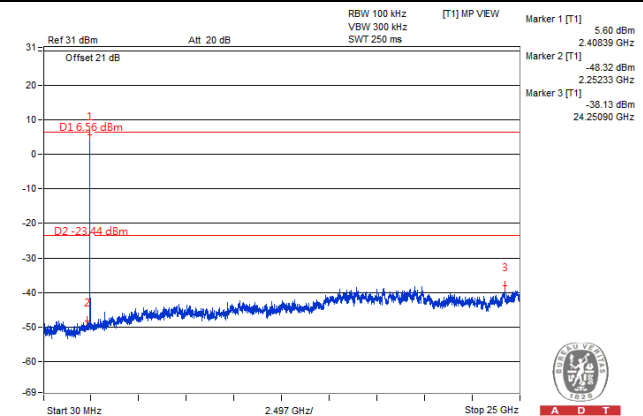
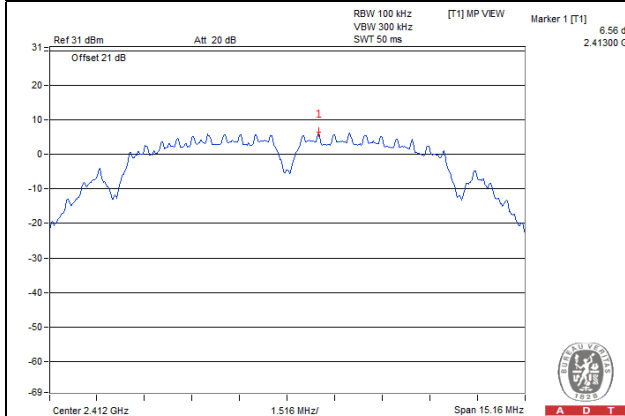

CH 6

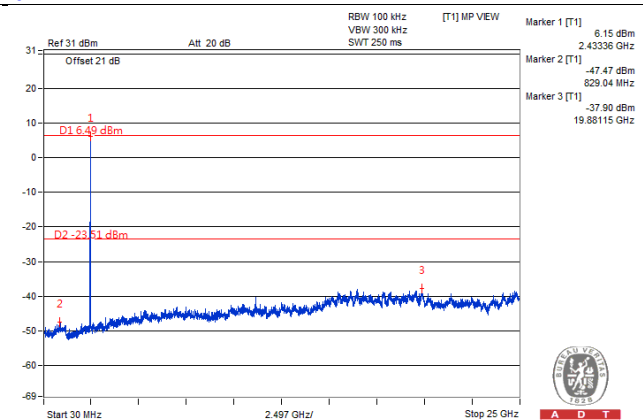
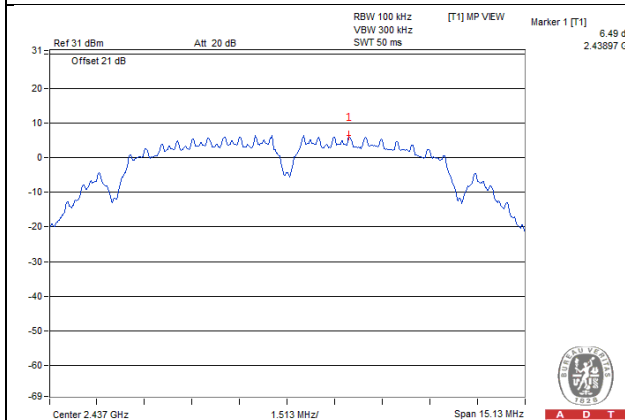

CH 11

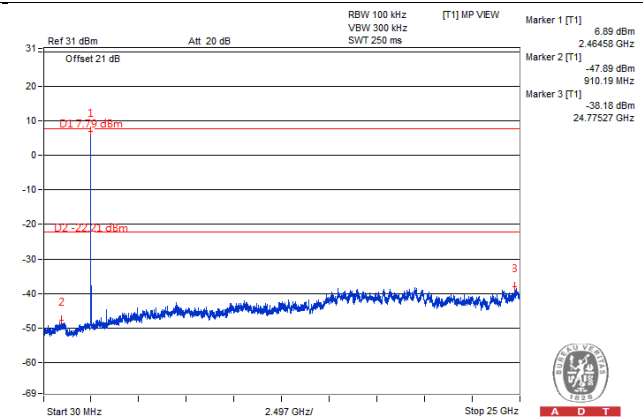
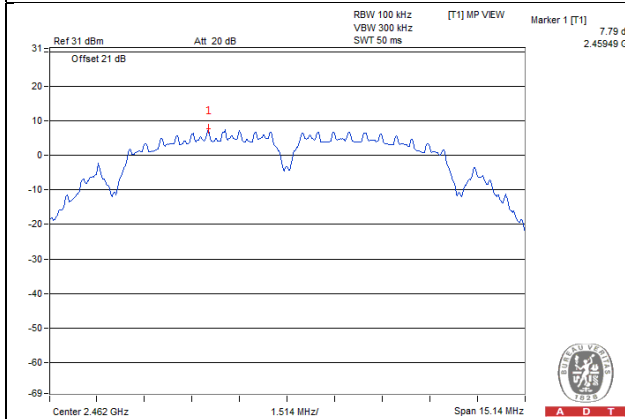

CH 1 Band edge

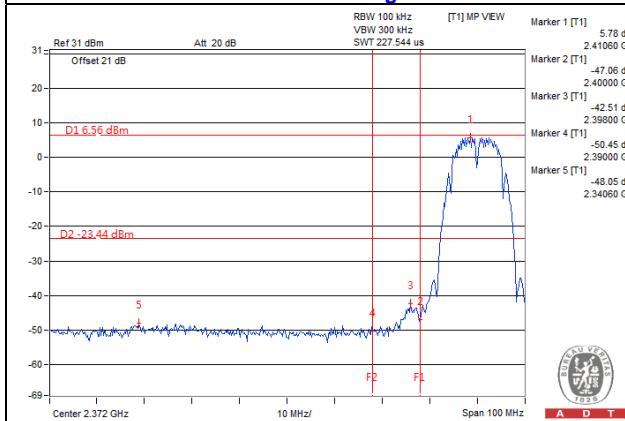

CH 11 Band edge

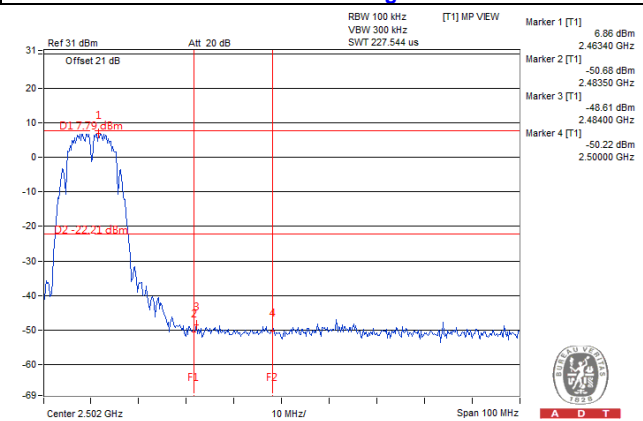

802.11g

CH 1

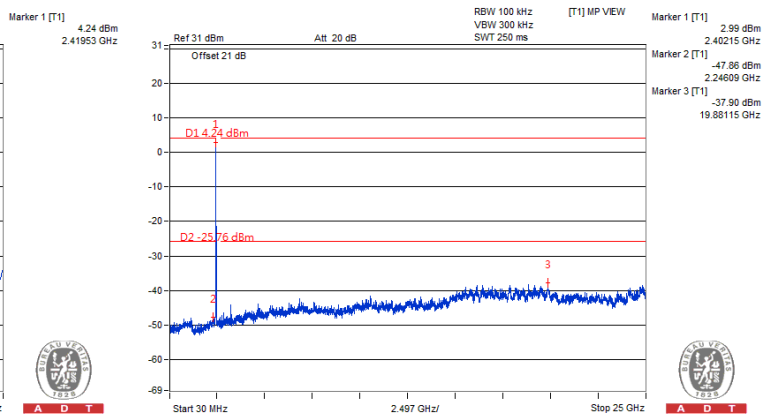
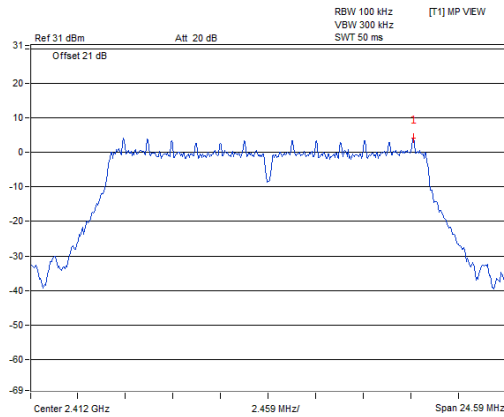

CH 6

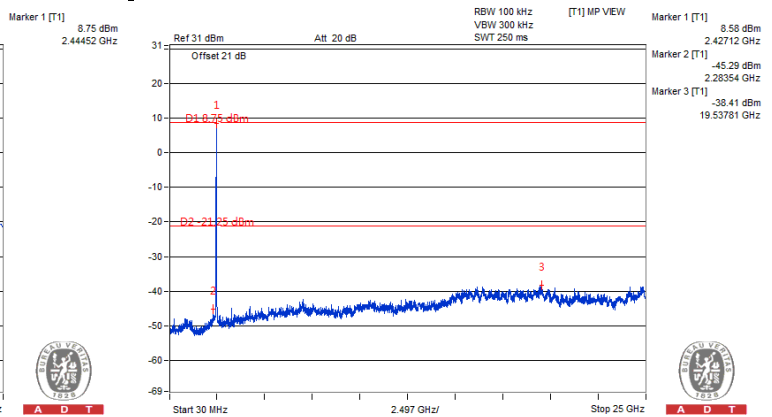
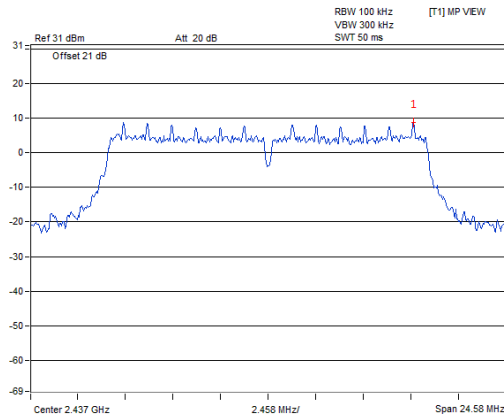

CH 11

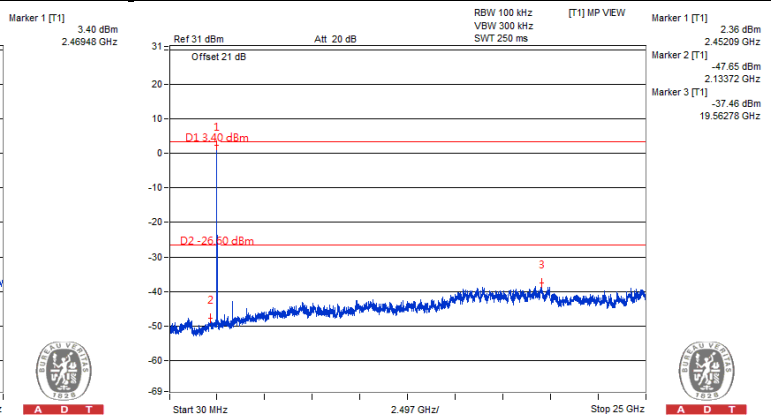
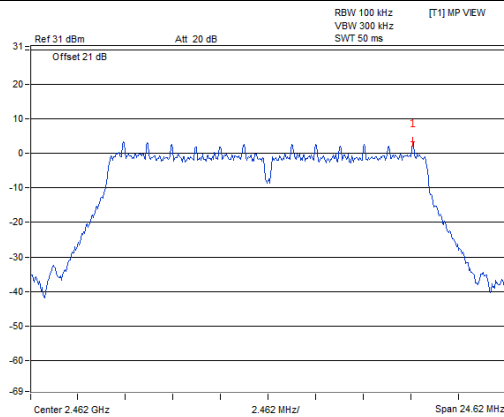

CH 1 Band edge

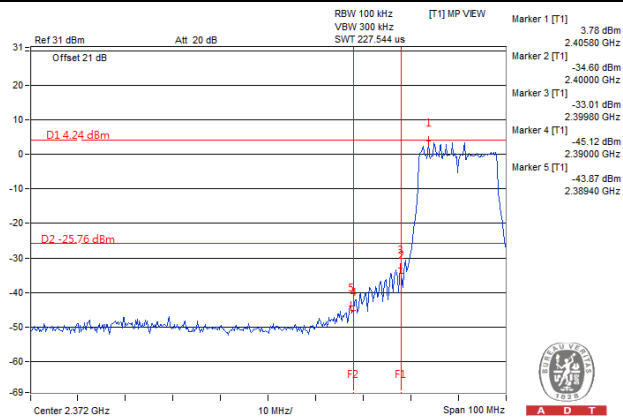

CH 11 Band edge

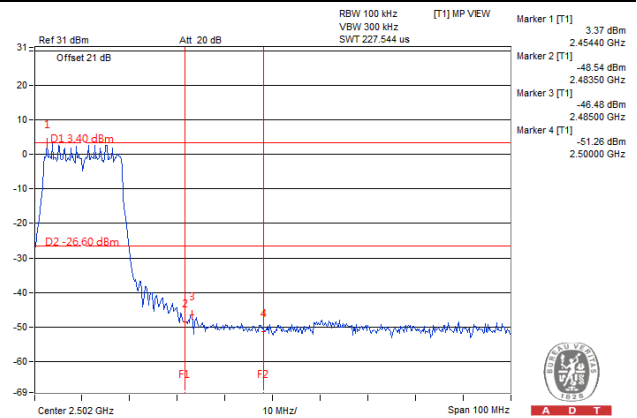

# 802.11n (HT20)

## CH 1

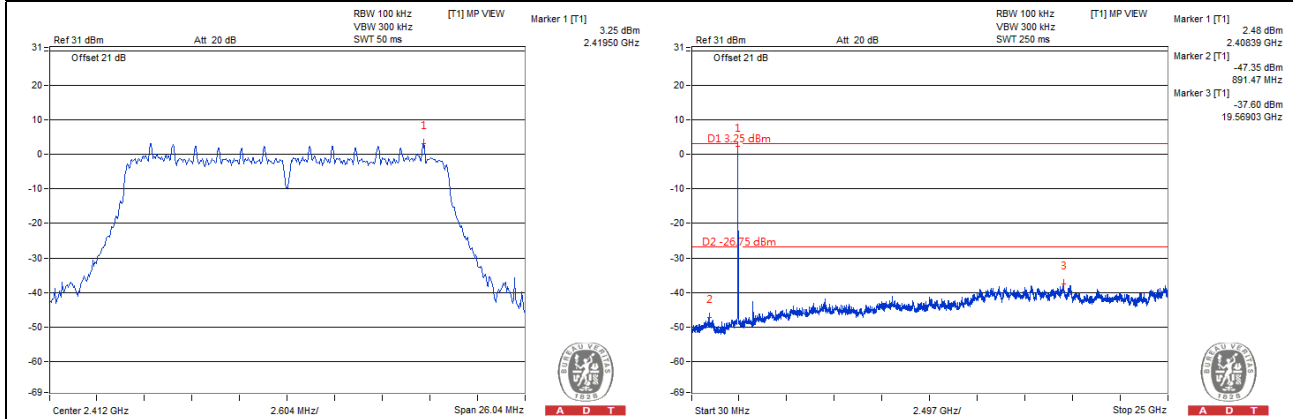

## CH 6

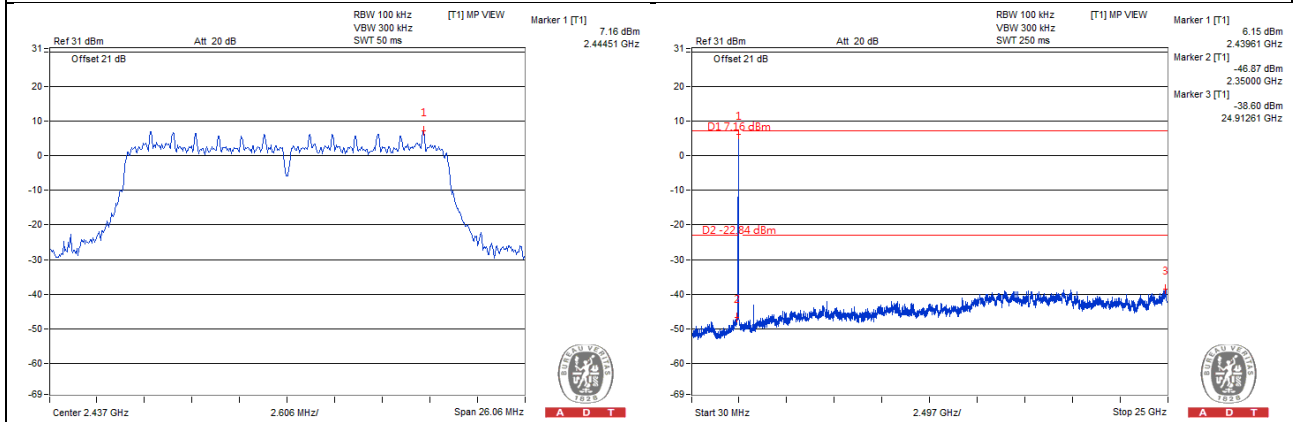

## CH 11

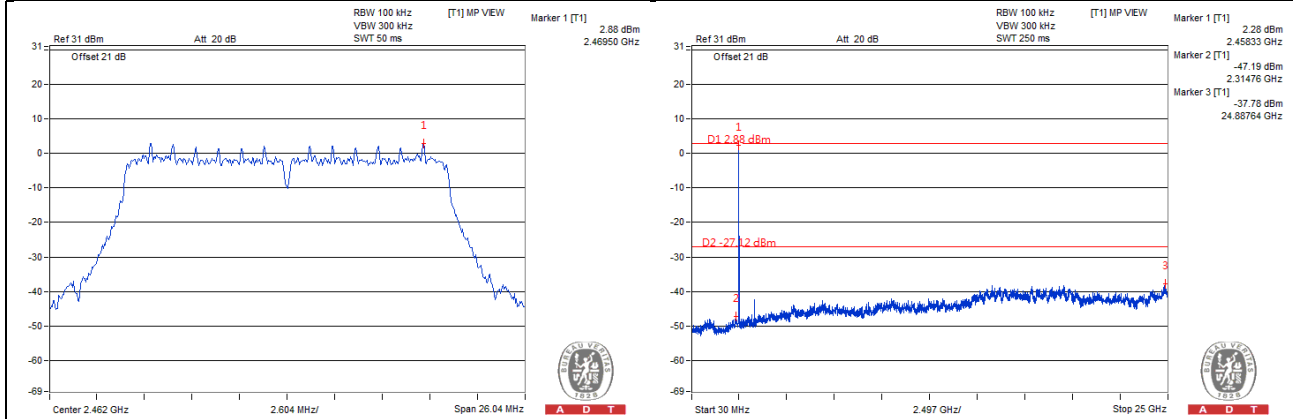

## CH 1 Band edge

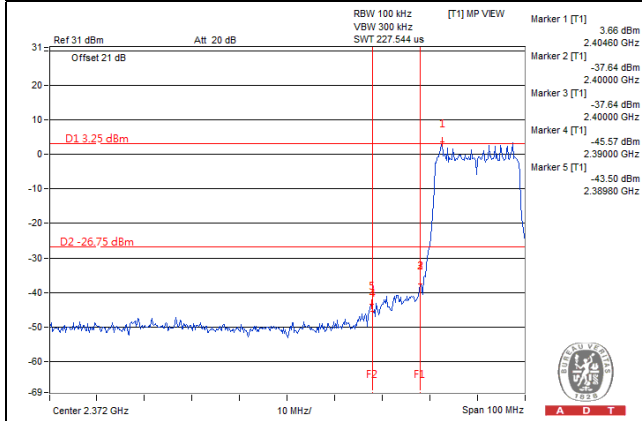

## CH 11 Band edge

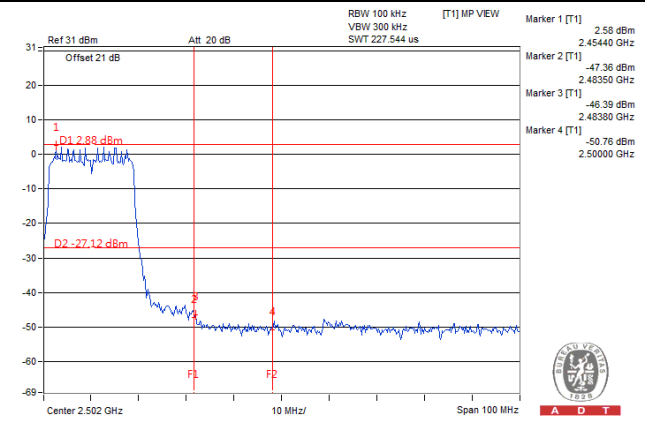

## 5 Pictures of Test Arrangements

Please refer to the attached file (Test Setup Photo).



## Appendix – Information on the Testing Laboratories

We, Bureau Veritas Consumer Products Services (H.K.) Ltd., Taoyuan Branch, were founded in 1988 to provide our best service in EMC, Radio, Telecom and Safety consultation. Our laboratories are accredited and approved according to ISO/IEC 17025.

If you have any comments, please feel free to contact us at the following:

**Linko EMC/RF Lab**

Tel: 886-2-26052180

Fax: 886-2-26051924

**Hsin Chu EMC/RF/Telecom Lab**

Tel: 886-3-5935343

Fax: 886-3-5935342

**Hwa Ya EMC/RF/Safety Lab**

Tel: 886-3-3183232

Fax: 886-3-3270892

**Email:** [service.adt@tw.bureauveritas.com](mailto:service.adt@tw.bureauveritas.com)

**Web Site:** [www.bureauveritas-adt.com](http://www.bureauveritas-adt.com)

The address and road map of all our labs can be found in our web site also.

--- END ---