



SGS-CSTC Standards Technical Services (Shanghai) Co., Ltd.

588 West Jindu Road, Songjiang District, Shanghai, China
Telephone: +86 (0) 21 6191 5666
Fax: +86 (0) 21 6191 5678
ee.shanghai@sgs.com

Report No.: SHEM150800299001
Page: 1 of 85

1 Cover Page

RF TEST REPORT

Application No.:	SHEM1508002990CR
Applicant:	TRENDNET INC
FCC ID:	XU8TVIP322WI
IC:	6337A-TVIP322WI
Equipment Under Test (EUT): NOTE: The following sample(s) was/were submitted and identified by the client as	
Product Name:	IR Network Camera
Model No.(EUT):	TV-IP322WI
Standards:	FCC PART 15 Subpart C: 2014 RSS-247 Issue 1 (May 2015) RSS-Gen Issue 4 (November 2014)
Date of Receipt:	July 06, 2015
Date of Test:	August 26, 2015 to August 28, 2015
Date of Issue:	September 10, 2015
Test Result:	Pass*

*In the configuration tested, the EUT detailed in this report complied with the standards specified above.

Parlam Zhan
E&E Section Manager
SGS-CSTC (Shanghai) Co., Ltd.



The manufacturer should ensure that all products in series production are in conformity with the product sample detailed in this report. If the product in this report is used in any configuration other than that detailed in the report, the manufacturer must ensure the new system complies with all relevant standards.

The report must not be used by the client to claim product certification, approval, or endorsement by NVLAP, NIST, or any agency of the federal government. All test results in this report can be traceable to National or International Standards.

This document is issued by the Company subject to its General Conditions of Service printed overleaf, available on request or accessible at www.sgs.com/terms_and_conditions.htm and, for electronic format documents, subject to Terms and Conditions for Electronic Documents at www.sgs.com/terms_e-document.htm. Attention is drawn to the limitation of liability, indemnification and jurisdiction issues defined therein. Any holder of this document is advised that information contained hereon reflects the Company's findings at the time of its intervention only and within the limits of Client's instructions, if any. The Company's sole responsibility is to its Client and this document does not exonerate parties to a transaction from exercising all their rights and obligations under the transaction documents. This document cannot be reproduced except in full, without prior written approval of the Company. Any unauthorized alteration, forgery or falsification of the content or appearance of this document is unlawful and offenders may be prosecuted to the fullest extent of the law. Unless otherwise stated the results shown in this test report refer only to the sample(s) tested and such sample(s) are retained for 90 days only.

2 Version

Revision Record				
Version	Chapter	Date	Modifier	Remark
00	/	September 10, 2015	/	Copy (Base on SHEM150700217302)

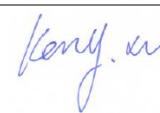
Authorized for issue by:				
Engineer		Eddy Zong _____ Print Name		
Clerk		Susie Liu _____ Print Name		
Reviewer		Keny Xu _____ Print Name		

3 Test Summary

Test Item	FCC Requirement	IC Requirement	Test method	Result
Antenna Requirement	FCC Part 15, Subpart C Section 15.203/15.247 (c)	RSS-Gen Section 8.1.3	---	PASS
AC Power Line Conducted Emission	FCC Part 15, Subpart C Section 15.207	RSS-Gen Clause 8.8	ANSI C63.10 (2013) Section 6.2	PASS
Minimum 6dB Bandwidth	FCC Part 15, Subpart C Section 15.247 (a)(2)	RSS-247 Clause 5.2(1)	ANSI C63.10 (2013) Section 11.8.1	PASS
Conducted Peak Output Power	FCC Part 15, Subpart C Section 15.247 (b)(3)	RSS-247 Clause 5.4(4)	ANSI C63.10 (2013) Section 11.9.1.2	PASS
Power Spectrum Density	FCC Part 15, Subpart C Section 15.247 (e)	RSS-247 Clause 5.2(2)	ANSI C63.10 (2013) Section 11.10.2	PASS
RF Conducted Spurious Emissions and Band-edge	FCC Part 15, Subpart C Section 15.247(d)	RSS-247 Clause 5.5	ANSI C63.10 (2013) Section 11.11&11.13.3.2	PASS
Radiated Spurious Emissions and Band-edge	FCC Part 15, Subpart C Section 15.209&15.205	RSS-247 Clause 5.5	ANSI C63.10 (2013) Section 6.4&6.5&6.6&6.10	PASS
99% Occupied bandwidth	---	RSS-Gen Clause 6.6	RSS-Gen Issue 4 section 6.6	PASS

Note: This report was an additional report copied from the report SHEM150700217302, just changing the applicant name, address of applicant, product name and model.



4 Contents

	Page
1 COVER PAGE	1
2 VERSION	2
3 TEST SUMMARY	3
4 CONTENTS	4
5 GENERAL INFORMATION	5
5.1 CLIENT INFORMATION	5
5.2 GENERAL DESCRIPTION OF E.U.T.	5
5.3 TECHNICAL SPECIFICATIONS	5
5.4 TEST MODE.....	6
5.5 TEST CHANNEL	6
5.6 DESCRIPTION OF SUPPORT UNITS	6
5.7 TEST LOCATION	6
5.8 TEST FACILITY	7
5.9 MEASUREMENT UNCERTAINTY	7
6 EQUIPMENTS USED DURING TEST	8
7 TEST RESULTS	9
7.1 E.U.T. TEST CONDITIONS	9
7.2 ANTENNA REQUIREMENT	10
7.3 CONDUCTED EMISSIONS ON MAINS TERMINALS	11
7.4 6dB OCCUPIED BANDWIDTH.....	15
7.5 CONDUCTED PEAK OUTPUT POWER	22
7.6 PEAK POWER SPECTRAL DENSITY.....	27
7.7 CONDUCTED SPURIOUS EMISSIONS AND BAND-EDGE	34
7.7.1 <i>Conducted spurious emission</i>	35
7.7.2 <i>Conducted Band-edge</i>	47
7.8 RADIATED SPURIOUS EMISSIONS AND BAND-EDGE.....	51
7.8.1 <i>Radiated Spurious Emissions</i>	54
7.8.2 <i>Radiated Band edge</i>	61
7.9 99% OCCUPIED BANDWIDTH	78
8 TEST SETUP PHOTOGRAPHS	85
9 EUT CONSTRUCTIONAL DETAILS	85

5 General Information

5.1 Client Information

Applicant:	TRENDNET INC
Address of Applicant:	20675 MANHATTAN PL TORRANCE, CA 90501 USA
Manufacturer:	Hangzhou Hikvision Digital Technology Co., Ltd.
Address of Manufacturer:	700 Dongliu Road, Binjiang, Hangzhou, 310052 Zhejiang, China
Factory:	Hangzhou Hikvision Digital Technology Co., Ltd.
Address of Factory:	700 Dongliu Road, Binjiang, Hangzhou, 310052 Zhejiang, China

5.2 General Description of E.U.T.

Product Description:	Fixed product with Ethernet port and WiFi monitor function		
Rated Input:	DC 12V via adapter		
Adapter:	Rated Input:	AC 100-240V 50/60Hz 0.8A	
	Rated Output:	DC 12V 2.0A	
	Cable Length:	AC port:	2 Wires
		DC port:	140cm

5.3 Technical Specifications

Operation Frequency:	802.11 b/g/n(HT20): 2412MHz-2462MHz 802.11 n(HT40): 2422MHz-2452MHz
Modulation Type:	802.11 b: DSSS(CCK, DQPSK, DBPSK) 802.11 g/n(HT20/HT40): OFDM(64QAM, 16QAM, QPSK, BPSK)
Number of Channel:	802.11 b/g/n(HT20): 11 Channels 802.11 n(HT40): 7 Channels
Data Rate:	802.11 b: 1/2/5.5/11Mbps 802.11 g: 6/9/12/18/24/36/48/54Mbps 802.11 n(HT20): 13/26/39/52/78/104/117/135Mbps 802.11 n(HT40): 27/54/81/108/162/216/243/270Mbps
Antenna Type:	Integral
Antenna Gain:	2.4 dBi

5.4 Test Mode

Test Mode	Description of Test Mode
Engineering mode	Using test software was control EUT work in continuous transmitter and mode.

5.5 Test Channel

	802.11 b/g/n20(HT20)					802.11 n40(HT40)		
	Channel	Frequency	Data rate			Channel	Frequency	Data rate
			b	g	n(HT20)			
lowest channel	CH01	2412MHz	1Mbps	6Mbps	13Mbps	CH03	2422MHz	27Mbps
Middle channel	CH06	2437MHz	1Mbps	6Mbps	13Mbps	CH06	2437MHz	27Mbps
Highest channel	CH11	2462MHz	1Mbps	6Mbps	13Mbps	CH09	2452MHz	27Mbps

Remark: Preliminary tests were performed in all tests in different data rata and antenna configurations at lowest channel, the data rates of worse case as above were chosen for final test.

5.6 Description of Support Units

The EUT has been tested with support equipments as below.

Description	Manufacturer	Model No.	Supplied By
Laptop	Lenovo	ThinkPad X 100e	SGS
AC to DC Adapter	/	FEF-0500150WU	SGS

Software name	Manufacturer	Software Vision	Supplied By
SSH Secure Shell	/	3.2.2.0	SGS

5.7 Test Location

All tests were performed at:

SGS-CSTC Standards Technical Services (Shanghai) Co., Ltd.

No.588 West Jindu Road, Songjiang District, Shanghai, China.201612.

Tel: +86 21 6191 5666

Fax: +86 21 6191 5678

5.8 Test Facility

The test facility is recognized, certified, or accredited by the following organizations:

- **CNAS (No. CNAS L0599)**

CNAS has accredited SGS-CSTC Standards Technical Services (Shanghai) Co., Ltd. to ISO/IEC 17025:2005 General Requirements for the Competence of Testing and Calibration Laboratories (CNAS-CL01 Accreditation Criteria for the Competence of Testing and Calibration Laboratories) for the competence in the field of testing. Date of expiry: 2017-07-14.

- **FCC – Registration No.: 402683**

SGS-CSTC Standards Technical Services (Shanghai) Co., Ltd. has been registered and fully described in a report filed with the Federal Communications Commission (FCC). The acceptance letter from the FCC is maintained in our files. Registration No.: 402683, Expiry Date: 2017-09-16.

- **Industry Canada (IC) – IC Assigned Code: 8617A**

The 3m Semi-anechoic chamber of SGS-CSTC Standards Technical Services (Shanghai) Co., Ltd. has been registered by Certification and Engineering Bureau of Industry Canada for radio equipment testing with Registration No.: 8617A-1. Expiry Date: 2017-06-18.

- **VCCI (Member No.: 3061)**

The 3m Semi-anechoic chamber and Shielded Room of SGS-CSTC Standards Technical Services (Shanghai) Co., Ltd. has been registered in accordance with the Regulations for Voluntary Control Measures with Registration No.: R-3868, C-4336, T-2221, G-830 respectively. Date of Expiry: 2017-11-16.

5.9 Measurement Uncertainty

No.	Parameter	Measurement Uncertainty
1	Radio Frequency	$< \pm 1 \times 10^{-5}$
2	Total RF power, conducted	$< \pm 1.5$ dB
3	RF power density, conducted	$< \pm 3$ dB
4	Spurious emissions, conducted	$< \pm 3$ dB
5	All emissions, radiated	$< \pm 6$ dB (Below 1GHz) $< \pm 6$ dB (Above 1GHz)
6	Temperature	$< \pm 1^{\circ}\text{C}$
7	Humidity	$< \pm 5$ %
8	DC and low frequency voltages	$< \pm 3$ %

6 Equipments Used during Test

Item	Test Equipment	Manufacturer	Model No.	Serial No.	Cal. Date	Cal. Due date
1	EMI test receiver	Rohde & Schwarz	ESCS30	100086	2015-01-22	2016-01-21
2	Line impedance stabilization network	SCHWARZBECK	NSLK8127	8127490	2015-01-22	2016-01-21
3	Line impedance stabilization network	ETS	3816/2	00034161	2015-01-22	2016-01-21
4	Spectrum Analyzer	Rohde & Schwarz	FSP-30	2705121009	2015-01-22	2016-01-21
5	EMI test receiver	Rohde & Schwarz	ESU40	100109	2015-02-13	2016-02-12
6	Active Loop Antenna (9kHz to 30MHz)	Schwarzbeck - Mess-Elektronik	FMZB 1519	1519-034	2015-02-07	2016-02-06
7	Broadband UHF-VHF ANTENNA (25MHz to 2GHz)	SCHWARZBECK	VULB9168	9168-313	2015-02-07	2016-02-06
8	Ultra broadband antenna (25MHz to 3GHz)	Rohde & Schwarz	HL562	100227	2014-08-30	2015-08-29
9	Horn Antenna (1GHz to 18GHz)	Rohde & Schwarz	HF906	100284	2015-02-07	2016-02-06
10	Horn Antenna (1GHz to 18GHz)	SCHWARZBECK	BBHA9120D	9120D-679	2015-02-07	2016-02-06
11	Horn Antenna (14GHz to 40GHz)	SCHWARZBECK	BBHA 9170	BBHA9170373	2015-02-13	2016-02-12
12	Pre-amplifier (9KHz – 2GHz)	LNA6900	TESEQ	71033	2014-12-27	2015-12-27
13	Pre-amplifier (1GHz – 26.5GHz)	Rohde & Schwarz	SCU-F0118-G40-BZ4-CSS(F)	10001	2015-01-22	2016-01-21
14	Pre-amplifier (14GHz – 40GHz)	Rohde & Schwarz	SCU-F1840-G35-BZ3-CSS(F)	10001	2015-01-22	2016-01-21
15	Tunable Notch Filter	Wainwright instruments GmbH	WRCT800.0/880.0-0.2/40-5SSK	9170397	/	/
16	High pass Filter	FSCW	HP 12/2800-5AA2	19A45-02	/	/
17	High-low temperature cabinet	Suzhou Zhihe	TL-40	50110050	2014-09-11	2015-09-10
18	AC power stabilizer	WOCEN	6100	51122	2015-01-02	2016-01-01
19	DC power	QJE	QJ30003SII	611145	2015-01-02	2016-01-01
20	Signal Generator (Interferer)	Agilent	SMR40	100555	2015-08-13	2016-08-12
21	Signal Generator (Blocker)	Rohde & Schwarz	SMJ100A	02.20.360.142	2015-01-22	2016-01-21
22	Splitter	Anritsu	MA1612A	M12265	/	/
23	Coupler	e-meca	803-S-1	900-M01	/	/

7 Test Results

7.1 E.U.T. test conditions

Requirements: 15.31(e) For intentional radiators, measurements of the variation of the input power or the radiated signal level of the fundamental frequency component of the emission, as appropriate, shall be performed with the supply voltage varied between 85% and 115% of the nominal rated supply voltage. For battery operated equipment, the equipment tests shall be performed using a new battery.

Operating Environment:	Temperature:	20.0 -25.0 °C
	Humidity:	35-75 % RH
	Atmospheric Pressure:	99.2 -102 kPa

Test frequencies: According to the 15.31(m) Measurements on intentional radiators or receivers, other than TV broadcast receivers, shall be performed and, if required, reported for each band in which the device can be operated with the device operating at the number of frequencies in each band specified in the following table:

Frequency range over which device operates	Number of frequencies	Location in the range of operation
1 MHz or less	1	Middle
1 to 10 MHz	2	1 near top and 1 near bottom
More than 10 MHz	3	1 near top, 1 near middle and 1 near bottom

Pursuant to Part 15.31(c) For swept frequency equipment, measurements shall be made with the frequency sweep stopped at those frequencies chosen for the measurements to be reported.

7.2 Antenna Requirement

Standard requirement:

An intentional radiator shall be designed to ensure that no antenna other than that furnished by the responsible party shall be used with the device. The use of a permanently attached antenna or of an antenna that uses a unique coupling to the intentional radiator, the manufacturer may design the unit so that a broken antenna can be replaced by the user, but the use of a standard antenna jack or electrical connector is prohibited

The conducted output power limit specified in paragraph (b) of this section is based on the use of antennas with directional gains that do not exceed 6 dBi. Except as shown in paragraph (c) of this section, if transmitting antennas of directional gain greater than 6 dBi are used, the conducted output power from the intentional radiator shall be reduced below the stated values in paragraphs (b)(1), (b)(2), and (b)(3) of this section, as appropriate, by the amount in dB that the directional gain of the antenna exceeds 6 dBi.

EUT Antenna:

The antenna is integral antenna and no consideration of replacement. The gain is less than 2.4 dBi.



7.3 Conducted Emissions on Mains Terminals

Frequency Range: 150 KHz to 30 MHz

Limit:

Frequency range MHz	Class B Limits: dB (µV)	
	Quasi-peak	Average
0.15 to 0.50	66 to 56	56 to 46
0.50 to 5	56	46
5 to 30	60	50

Note1: The limit decreases linearly with the logarithm of the frequency in the range 0.15 MHz to 0.50MHz.

Note2: The lower limit is applicable at the transition frequency.

Test Setup:

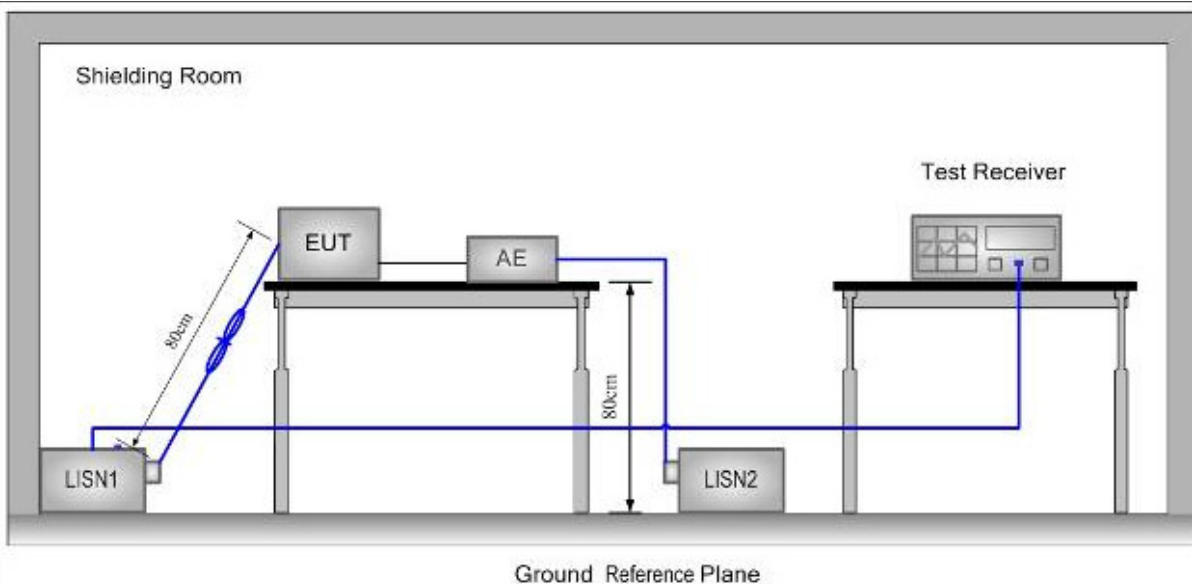

Test Procedure:

- 1) The mains terminal disturbance voltage was measured with the EUT in a shielded room.
- 2) The EUT was connected to AC power source through a LISN 1 (Line Impedance Stabilization Network) which provides 50Ω/50µH + 5Ω linear impedance. The power cables of all other units of the EUT were connected to a second LISN, which was bonded to the ground reference plane in the same way as the LISN for the unit being measured. A multiple socket outlet strip was used to connect multiple power cables to a single LISN provided the rating of the LISN was not exceeded
- 3) The tabletop EUT was placed upon a non-metallic table 0.8m above the ground reference plane. And for floor-standing arrangement, the EUT was placed on the horizontal ground reference plane, but separated from metallic contact with the ground reference plane by 0.1m of insulation.
- 4) The test was performed with a vertical ground reference plane. The rear of the EUT shall be 0.4 m from the vertical ground reference plane. The vertical ground reference plane was bonded to the horizontal ground reference plane. The LISN was placed 0.8 m from the boundary of the unit under test and bonded to a ground reference plane for LISN mounted on top of the ground reference plane. This distance was between the closest points of the LISN and the EUT. The mains lead of EUT excess 0.8m was folded back and forth parallel to the lead so as to form a horizontal bundle with a length between 0.3m and 0.4m. All other units of the EUT and associated equipment were at least 0.8 m from the LISN.



Remark: Pre-scan was performed with peak detected on all ports, Quasi-peak & average measurements were performed at the frequencies at which maximum peak emission level were detected. Pretest under all modes; choose the worst case mode (802.11b in Middle channel) record on the report. Please see the attached Quasi-peak and Average test results.

Test Result: Pass

Test Data:

Test Mode:	802.11b	Test Channel:	Middle
Test Port:	AC Live Line		

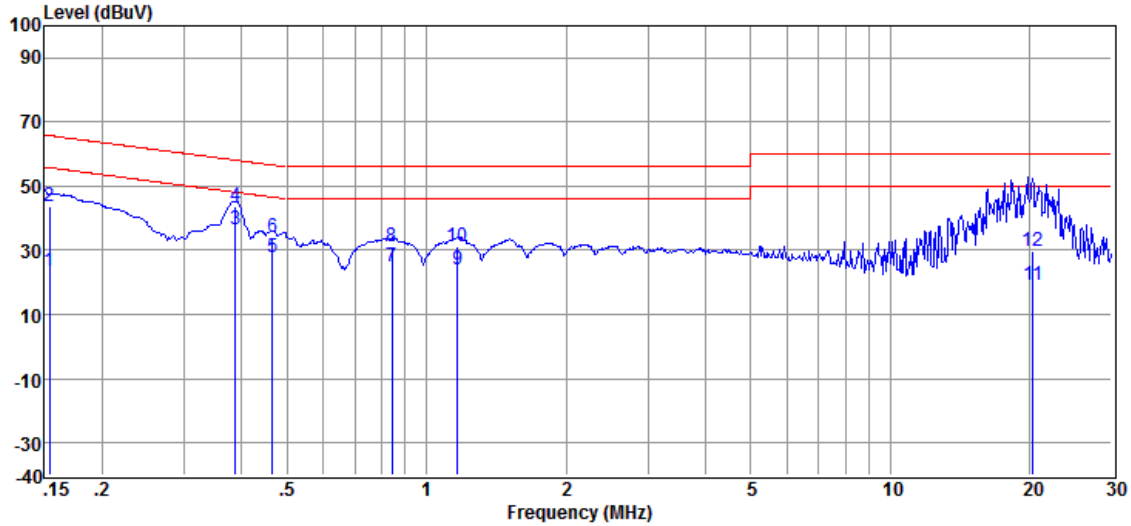

Item	Freq.	Read Level	LISN Factor	Cable Loss	Level	Limit Line	Over Limit	Detector
(Mark)	(MHz)	(dBμV)	(dB)	(dB)	(dBμV)	(dBμV)	(dB)	
1	0.154	13.44	0.32	9.86	23.62	55.78	-32.16	Average
2	0.154	33.60	0.32	9.86	43.78	65.78	-22.00	QP
3	0.387	26.32	0.25	9.86	36.43	48.12	-11.69	Average
4	0.387	33.62	0.25	9.86	43.73	58.12	-14.39	QP
5	0.466	17.79	0.25	9.86	27.90	46.58	-18.68	Average
6	0.466	23.93	0.25	9.86	34.04	56.58	-22.54	QP
7	0.844	15.00	0.19	9.87	25.06	46.00	-20.94	Average
8	0.844	21.30	0.19	9.87	31.36	56.00	-24.64	QP
9	1.166	13.84	0.21	9.87	23.92	46.00	-22.08	Average
10	1.166	21.09	0.21	9.87	31.17	56.00	-24.83	QP
11	20.270	8.81	0.42	9.96	19.19	50.00	-30.81	Average
12	20.270	19.59	0.42	9.96	29.97	60.00	-30.03	QP

Test Port: AC Neutral Line

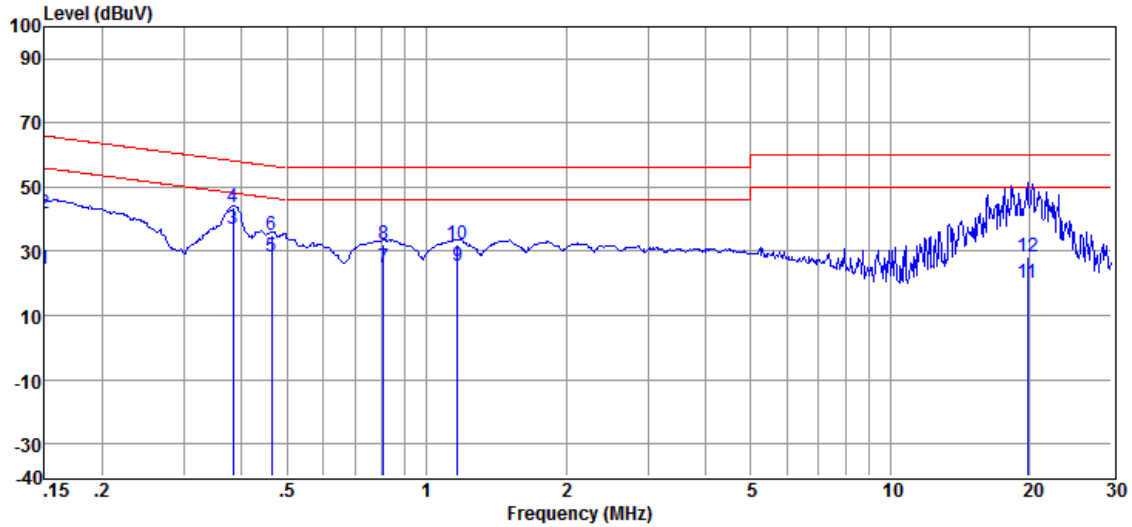

Item	Freq.	Read Level	LISN Factor	Cable Loss	Level	Limit Line	Over Limit	Detector
(Mark)	(MHz)	(dB μ V)	(dB)	(dB)	(dB μ V)	(dB μ V)	(dB)	
1	0.150	14.35	0.34	9.86	24.55	56.00	-31.45	Average
2	0.150	31.65	0.34	9.86	41.85	66.00	-24.15	QP
3	0.383	26.65	0.30	9.86	36.81	48.21	-11.40	Average
4	0.383	33.65	0.30	9.86	43.81	58.21	-14.40	QP
5	0.464	18.30	0.30	9.86	28.46	46.63	-18.17	Average
6	0.464	24.93	0.30	9.86	35.09	56.63	-21.54	QP
7	0.809	15.06	0.21	9.86	25.13	46.00	-20.87	Average
8	0.809	22.18	0.21	9.86	32.25	56.00	-23.75	QP
9	1.166	15.10	0.40	9.87	25.37	46.00	-20.63	Average
10	1.166	22.08	0.40	9.87	32.35	56.00	-23.65	QP
11	19.740	9.96	0.45	9.96	20.37	50.00	-29.63	Average
12	19.740	17.99	0.45	9.96	28.40	60.00	-31.60	QP

Remark: Level = Read Level + LISN/ISN Factor + Cable Loss.

7.4 6dB Occupied Bandwidth

Test Configuration:

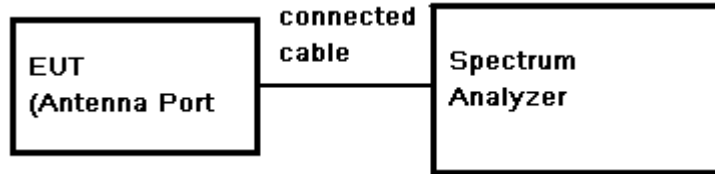

Test Procedure:

- 1) Place the EUT on the table and set it in transmitting mode.
- 2) Remove the antenna from the EUT and then connect a low loss RF cable from the antenna port to the spectrum analyzer.
- 3) Set the spectrum analyzer as RBW=300KHz, VBW≥3* RBW, Detector=Peak, Trace mode= Max hold, Sweep=Auto couple.
- 4) Mark the peak frequency and -6dB (upper and lower) frequency.
- 5) Repeat above procedures until all frequency measured was complete.

Limit: ≥ 500 kHz

Test Result: Pass

Test Data:

Test Mode	Test Frequency (MHz)	6dB Bandwidth (MHz)	Limit (KHz)	Result
802.11b	2412	9.39	500	Pass
	2437	9.42		Pass
	2462	9.42		Pass
802.11g	2412	16.56		Pass
	2437	16.56		Pass
	2462	16.56		Pass
802.11 n(HT20)	2412	17.76		Pass
	2437	17.76		Pass
	2462	17.76		Pass
802.11 n(HT40)	2422	36.32		Pass
	2437	36.24		Pass
	2452	36.34		Pass

Test plot as follows:

802.11 b	Channel: 2412
----------	---------------

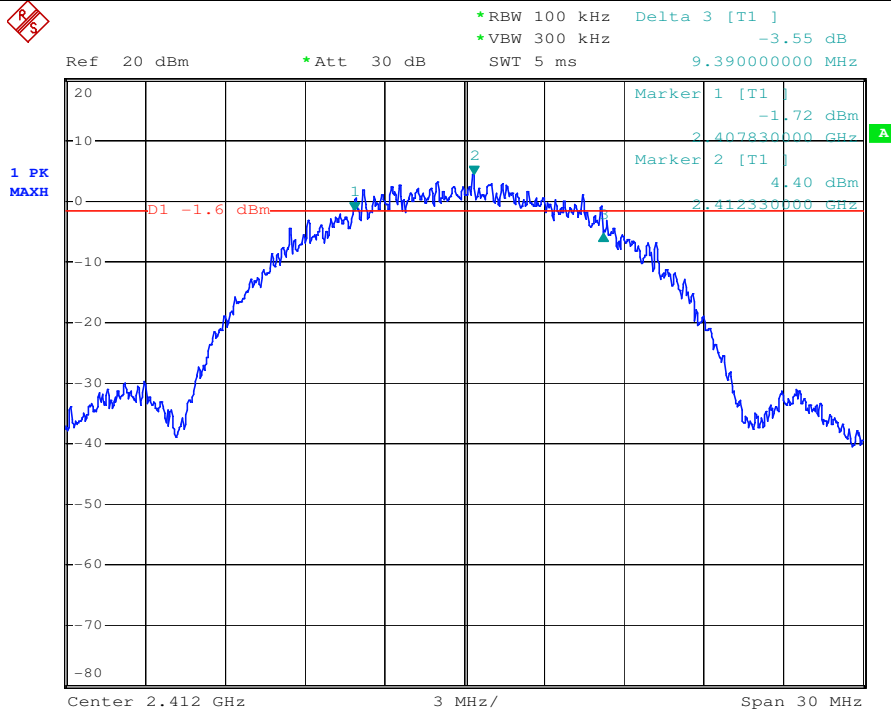

802.11 b	Channel: 2437
----------	---------------

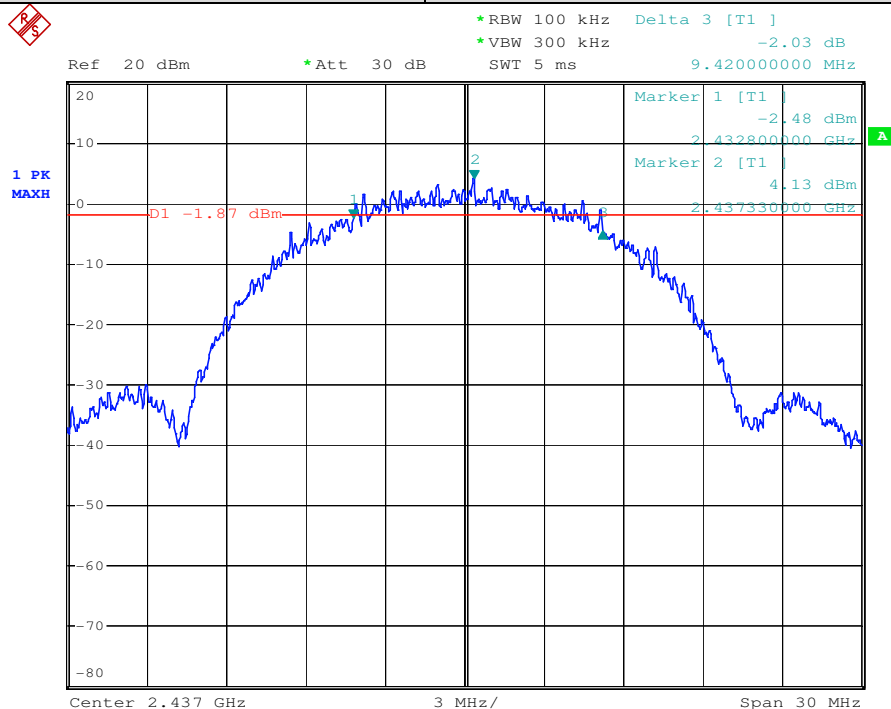



802.11 b Channel: 2462

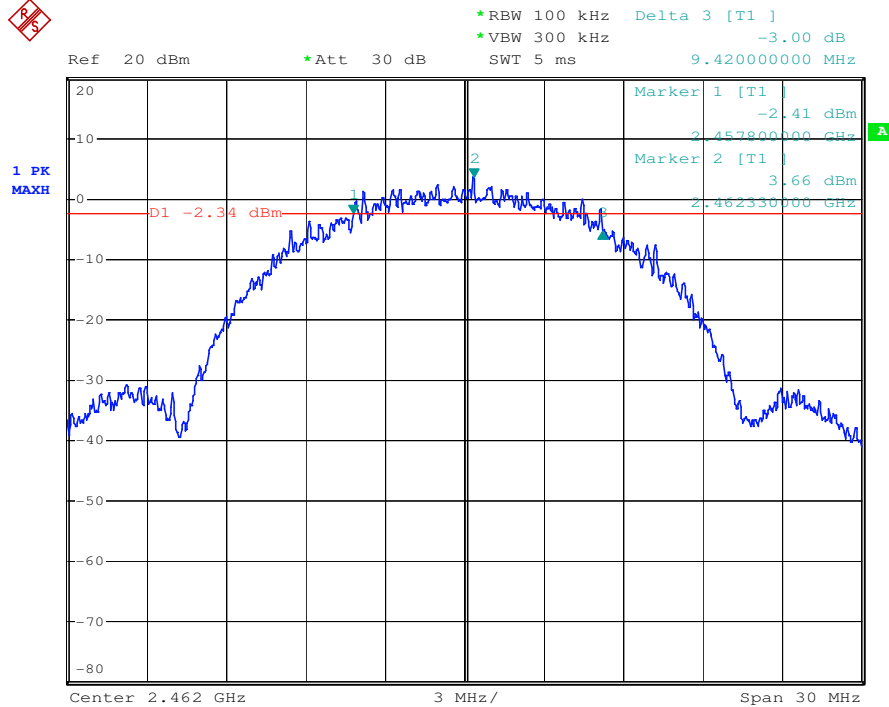

802.11 g Channel: 2412

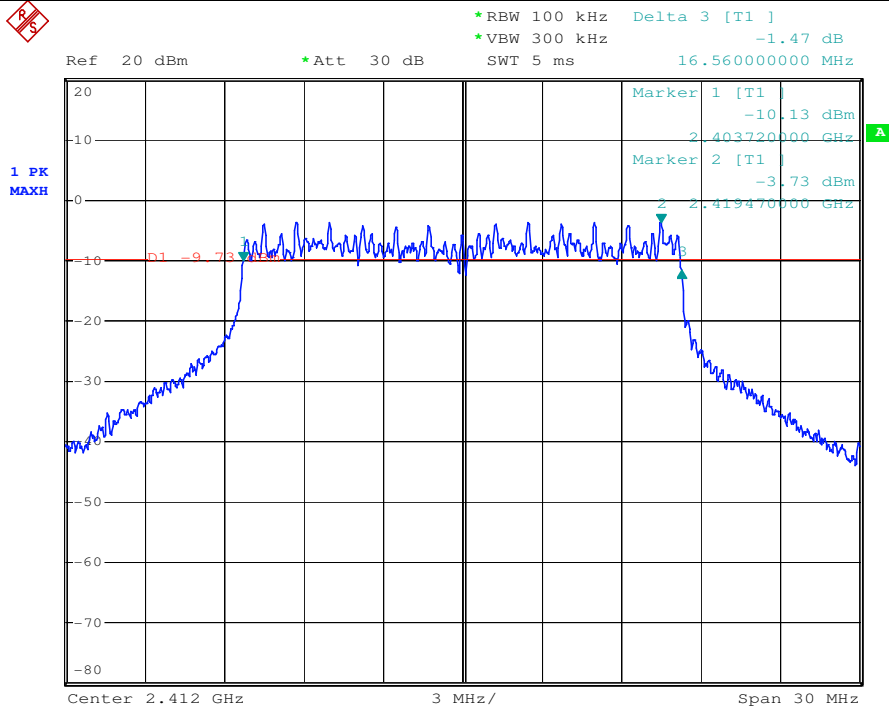

This document is issued by the Company subject to its General Conditions of Service printed overleaf, available on request or accessible at www.sgs.com/terms_and_conditions.htm and, for electronic format documents, subject to Terms and Conditions for Electronic Documents at www.sgs.com/terms_e-document.htm. Attention is drawn to the limitation of liability, indemnification and jurisdiction issues defined therein. Any holder of this document is advised that information contained hereon reflects the Company's findings at the time of its intervention only and within the limits of Client's instructions, if any. The Company's sole responsibility is to its Client and this document does not exonerate parties to a transaction from exercising all their rights and obligations under the transaction documents. This document cannot be reproduced except in full, without prior written approval of the Company. Any unauthorized alteration, forgery or falsification of the content or appearance of this document is unlawful and offenders may be prosecuted to the fullest extent of the law. Unless otherwise stated the results shown in this test report refer only to the sample(s) tested and such sample(s) are retained for 90 days only

802.11 g Channel: 2437

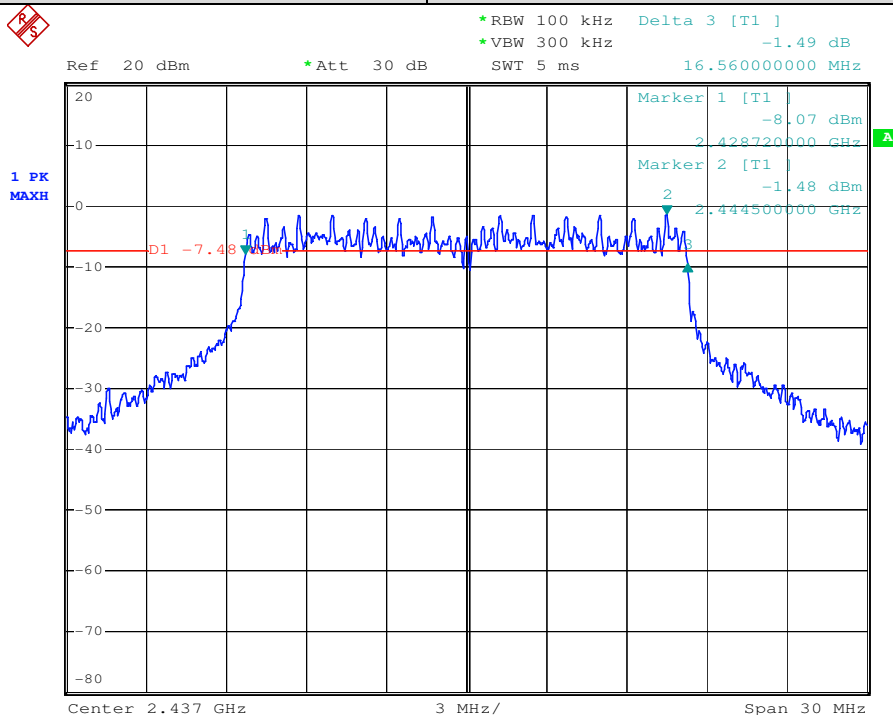

802.11 g Channel: 2462

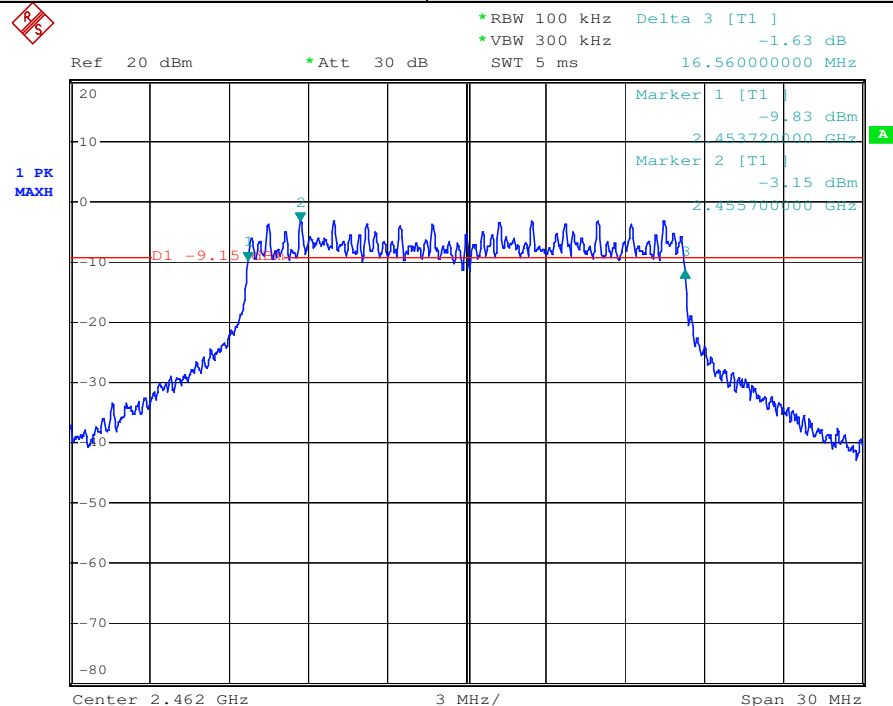



802.11 n (HT20) Channel: 2412

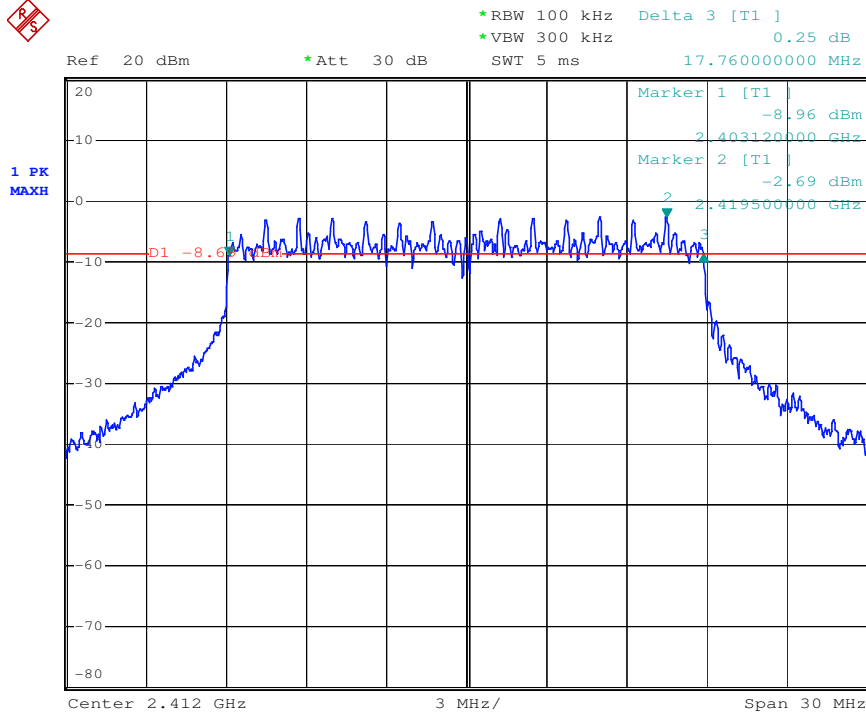

802.11 n (HT20) Channel: 2437

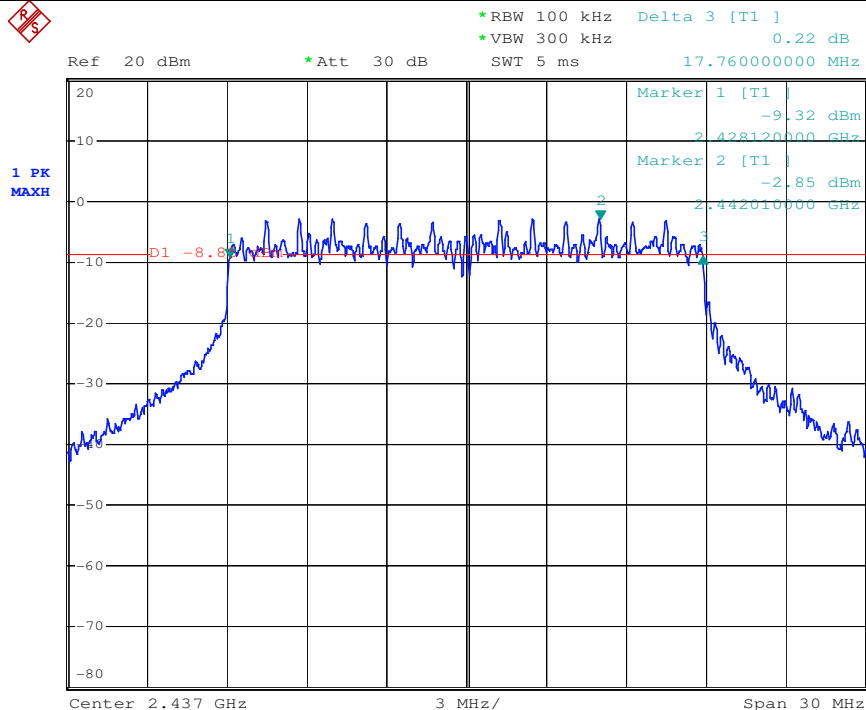



802.11 n (HT20) Channel: 2462

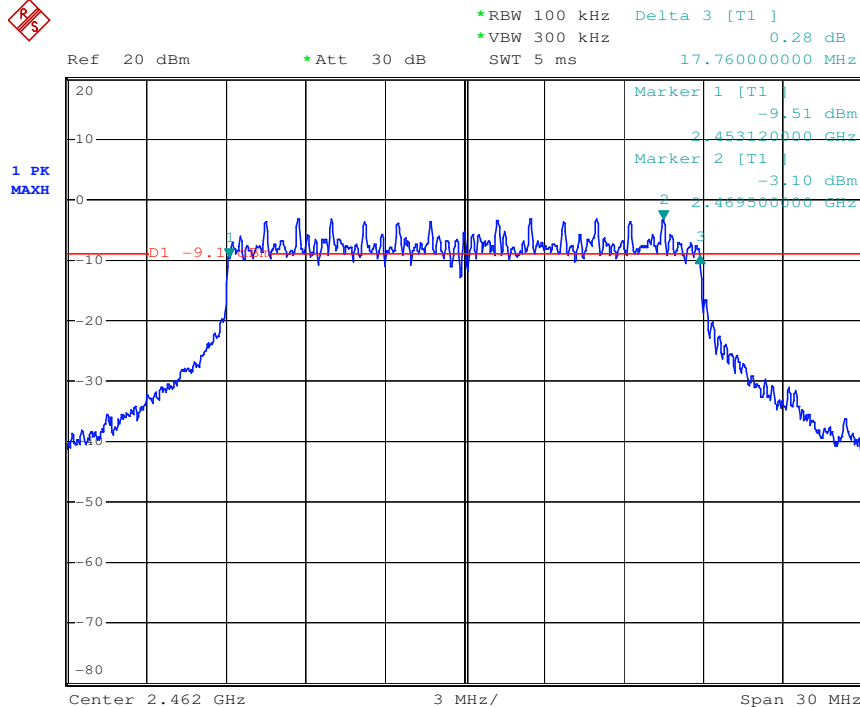

802.11 n (HT40) Channel: 2422

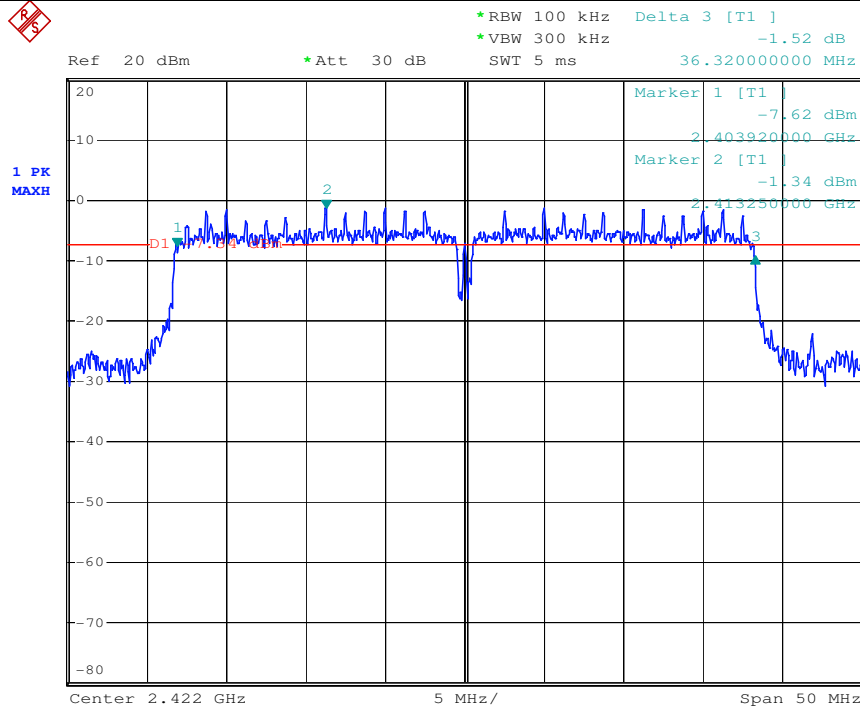

802.11 n (HT40)	Channel: 2437
-----------------	---------------

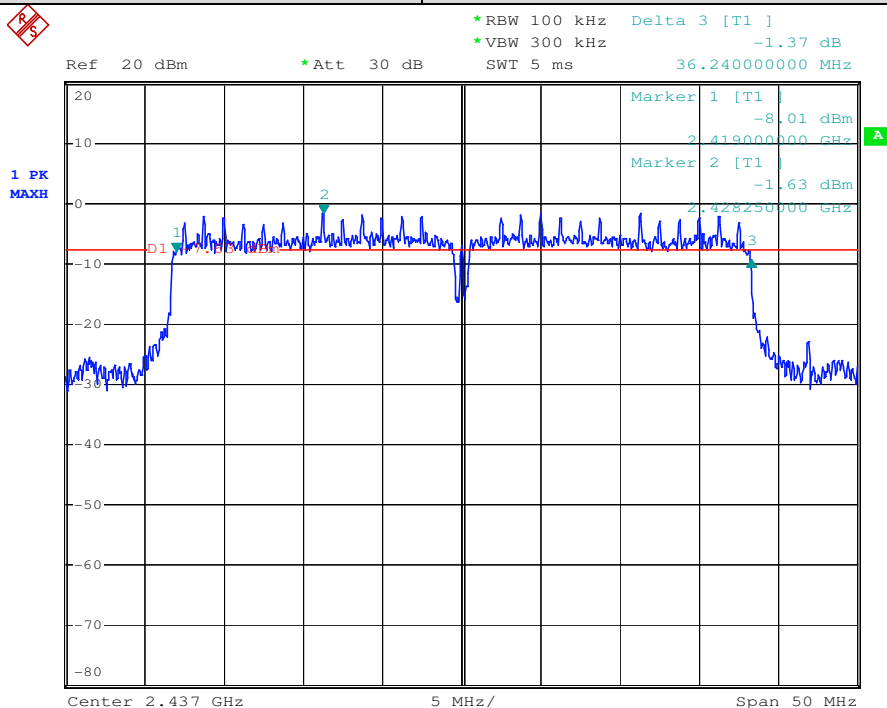

802.11 n (HT40)	Channel: 2452
-----------------	---------------

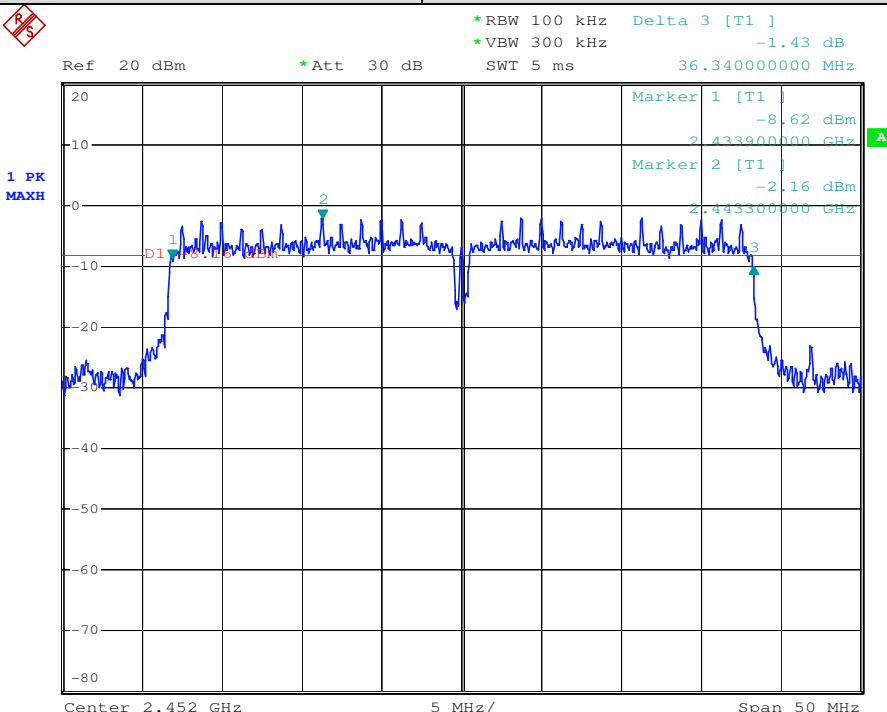

7.5 Conducted Peak Output Power

Test Configuration:

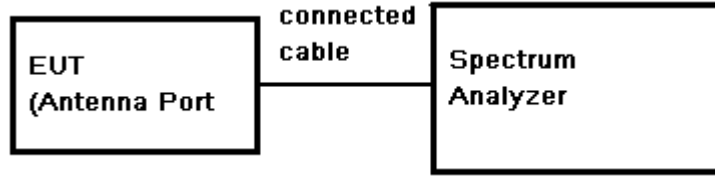

Test Procedure:

- 1) Place the EUT on the table and set it in transmitting mode.
- 2) Remove the antenna from the EUT and then connect a low loss RF cable from the antenna port to the spectrum.
- 3) Set the spectrum analyzer as RBW=1MHz, VBW≥3* RBW, Detector=Peak, Span≥1.5 × DTS bandwidth, Trace mode= Max hold, Sweep=Auto couple
- 4) Allow trace to fully stabilize.
- 5) Use the instrument's band/channel power measurement function with the band limits set equal to the DTS bandwidth edges
- 6) Record the max. Power channel reading.
- 7) Repeat above procedures until all the frequency measured were complete.

Test Limit: 30dBm

Test Result: Pass

Test Data:

Test mode	Test Channel	Reading Power (dBm)	Output Power (dBm)	Limit (dBm)	Result
802.11b	2412	18.27	18.77	30	Pass
	2437	18.01	18.51		Pass
	2462	17.48	17.98		Pass
802.11g	2412	18.19	18.69		Pass
	2437	17.85	18.35		Pass
	2462	17.46	17.96		Pass
802.11 n(HT20)	2412	16.34	16.84		Pass
	2437	16.07	16.57		Pass
	2462	15.81	16.31		Pass
802.11 n(HT40)	2422	15.98	16.48		Pass
	2437	15.51	16.01		Pass
	2452	15.15	15.65		Pass

Remark: 1) Output Peak Power = Reading Peak Power + Cable loss

2) Cable loss=0.5dB

Test plot as follows:

802.11 b	Channel: 2412
----------	---------------

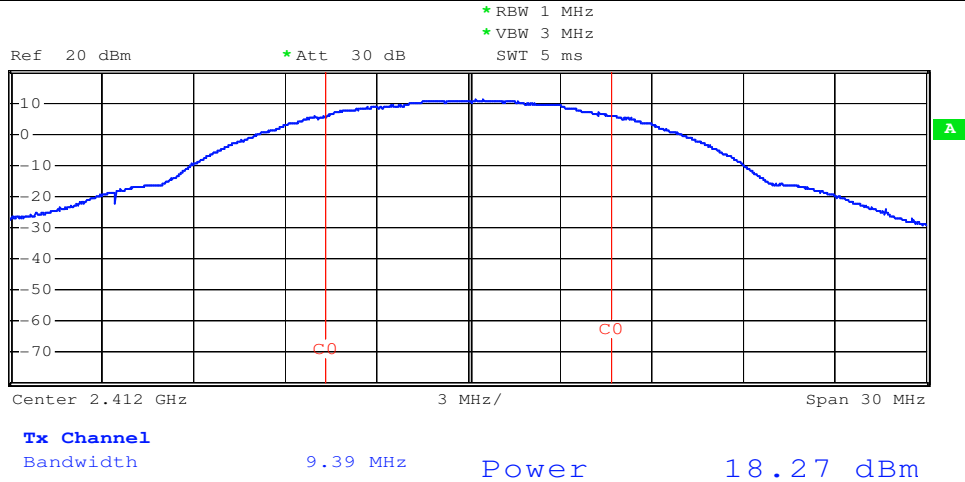

802.11 b	Channel: 2437
----------	---------------

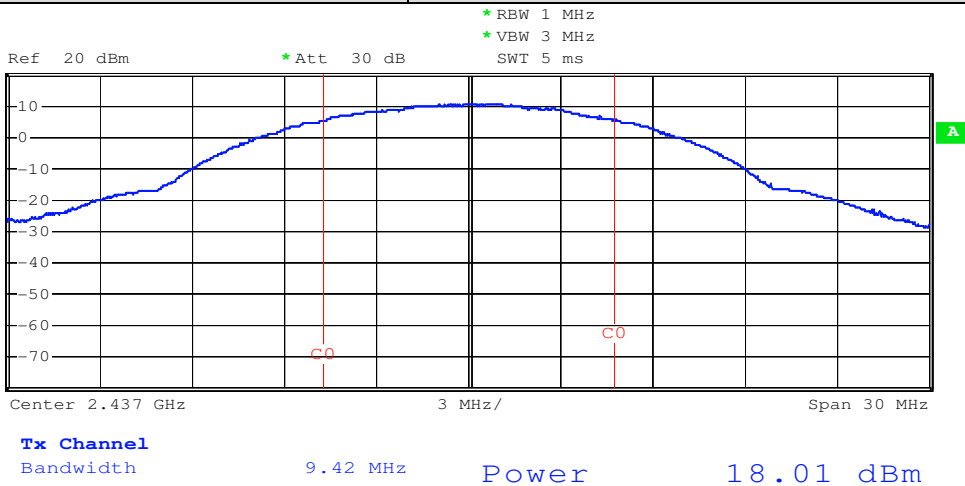

802.11 b	Channel: 2462
----------	---------------

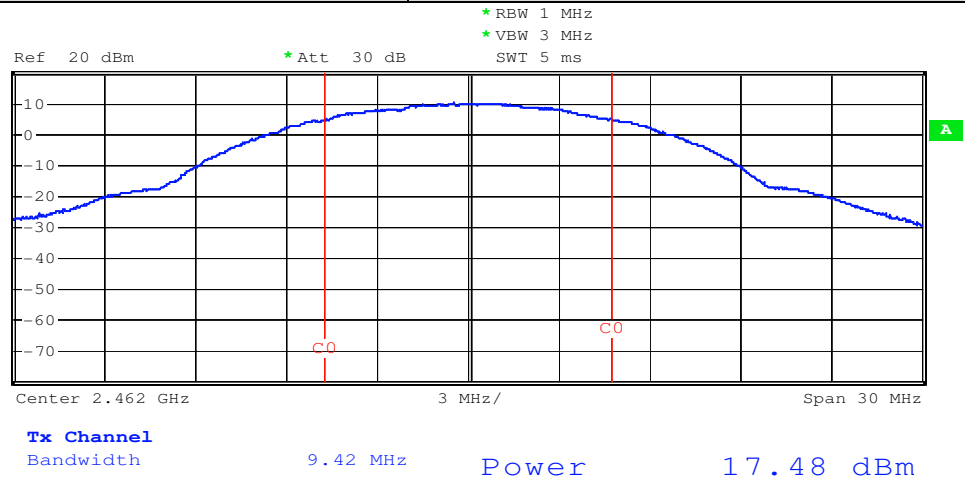

This document is issued by the Company subject to its General Conditions of Service printed overleaf, available on request or accessible at www.sgs.com/terms_and_conditions.htm and, for electronic format documents, subject to Terms and Conditions for Electronic Documents at www.sgs.com/terms_e-document.htm. Attention is drawn to the limitation of liability, indemnification and jurisdiction issues defined therein. Any holder of this document is advised that information contained hereon reflects the Company's findings at the time of its intervention only and within the limits of Client's instructions, if any. The Company's sole responsibility is to its Client and this document does not exonerate parties to a transaction from exercising all their rights and obligations under the transaction documents. This document cannot be reproduced except in full, without prior written approval of the Company. Any unauthorized alteration, forgery or falsification of the content or appearance of this document is unlawful and offenders may be prosecuted to the fullest extent of the law. Unless otherwise stated the results shown in this test report refer only to the sample(s) tested and such sample(s) are retained for 90 days only

802.11 g Channel: 2412

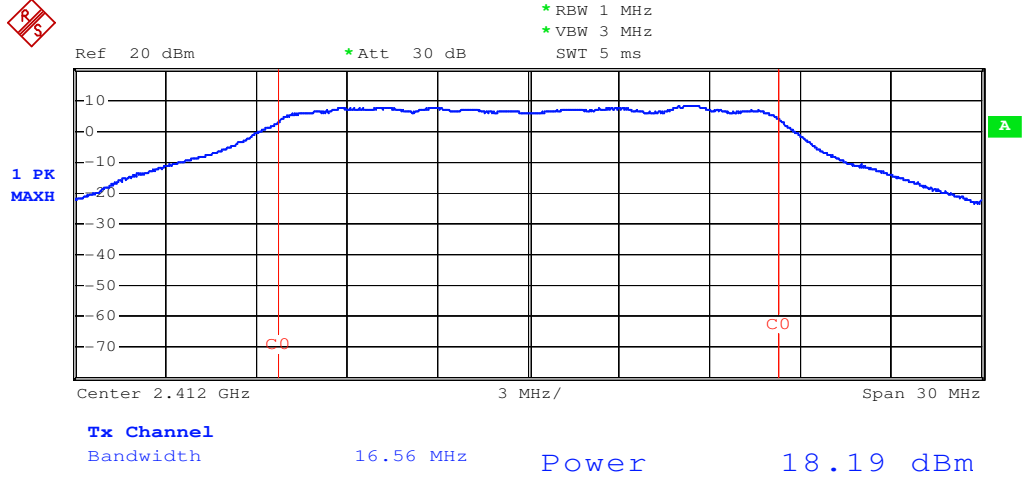

802.11 g Channel: 2437

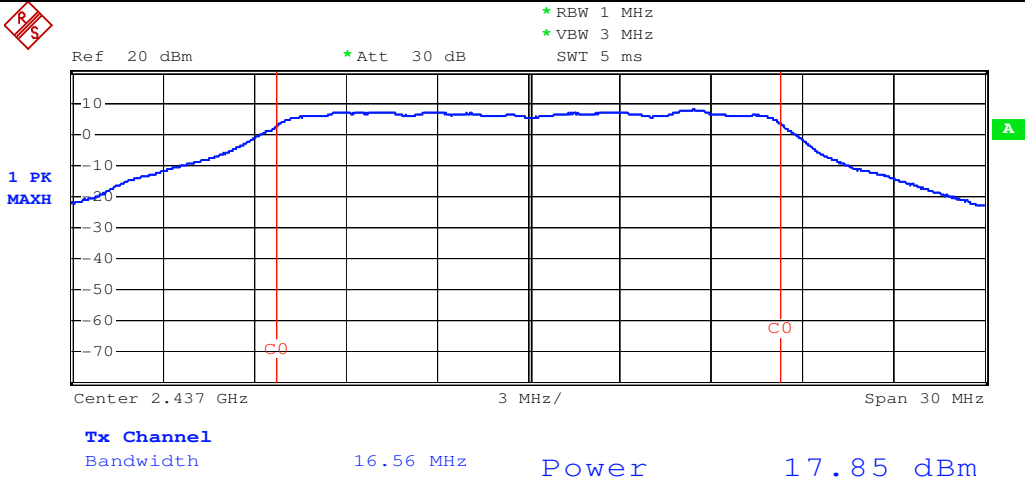

802.11 g Channel: 2462

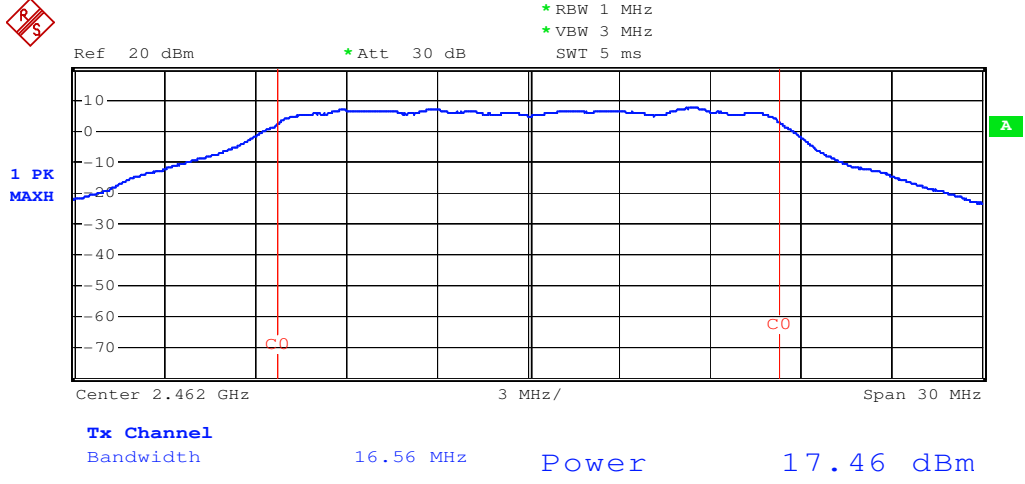

This document is issued by the Company subject to its General Conditions of Service printed overleaf, available on request or accessible at www.sgs.com/terms_and_conditions.htm and, for electronic format documents, subject to Terms and Conditions for Electronic Documents at www.sgs.com/terms_e-document.htm. Attention is drawn to the limitation of liability, indemnification and jurisdiction issues defined therein. Any holder of this document is advised that information contained hereon reflects the Company's findings at the time of its intervention only and within the limits of Client's instructions, if any. The Company's sole responsibility is to its Client and this document does not exonerate parties to a transaction from exercising all their rights and obligations under the transaction documents. This document cannot be reproduced except in full, without prior written approval of the Company. Any unauthorized alteration, forgery or falsification of the content or appearance of this document is unlawful and offenders may be prosecuted to the fullest extent of the law. Unless otherwise stated the results shown in this test report refer only to the sample(s) tested and such sample(s) are retained for 90 days only

802.11 n (HT20)	Channel: 2412
-----------------	---------------

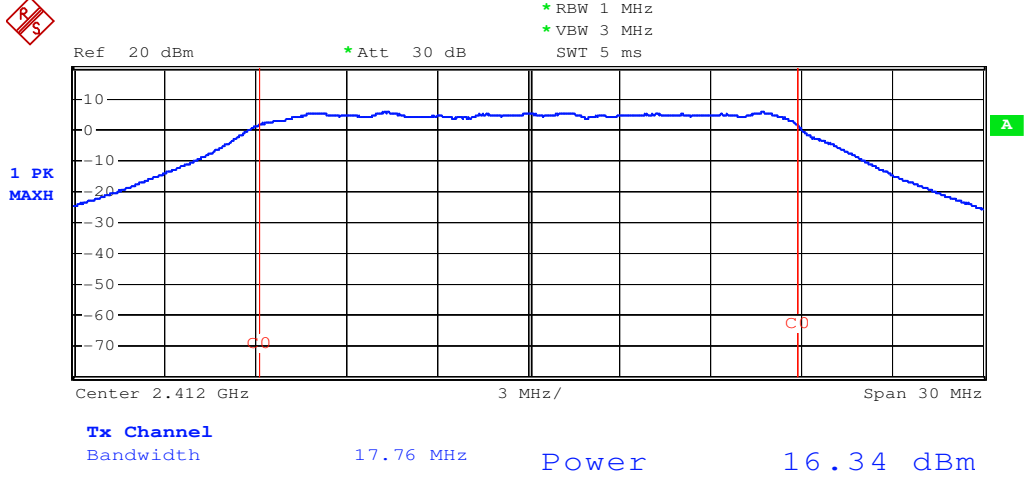

802.11 n (HT20)	Channel: 2437
-----------------	---------------

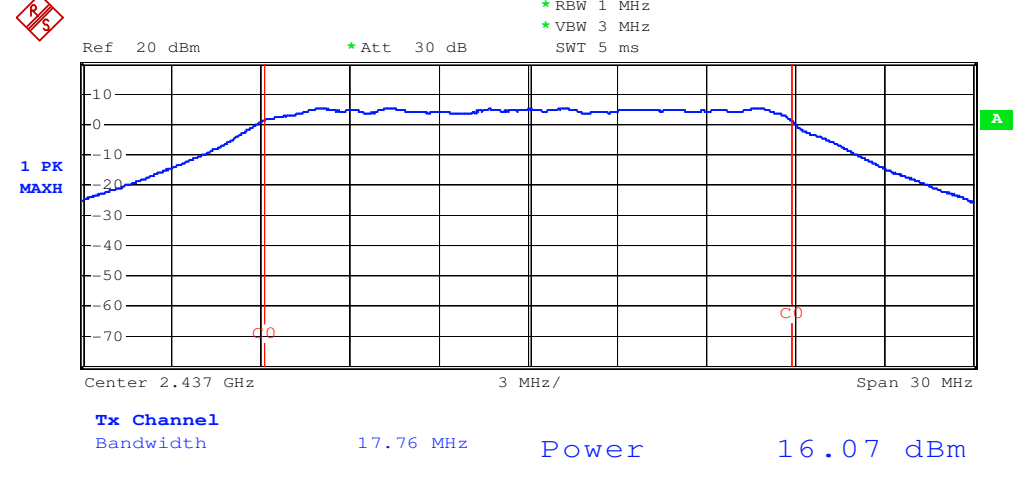

802.11 n (HT20)	Channel: 2462
-----------------	---------------

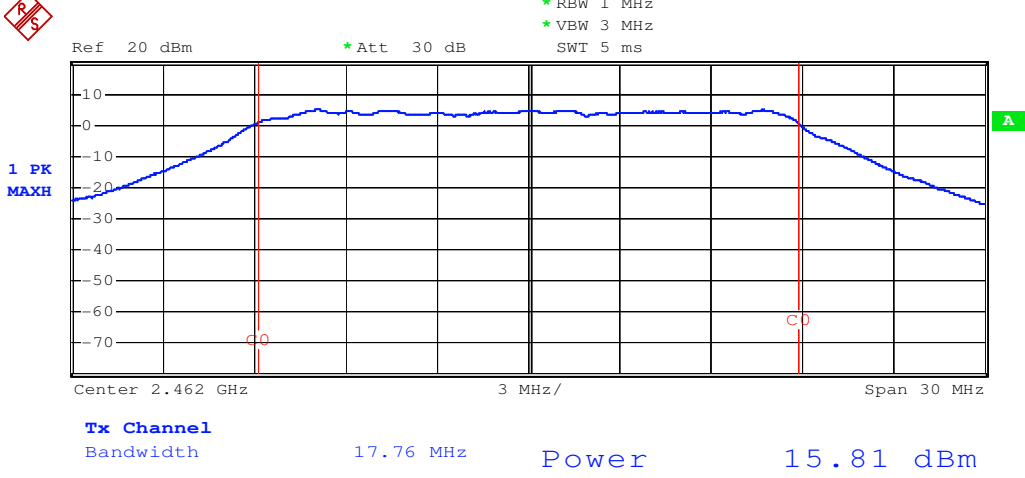

This document is issued by the Company subject to its General Conditions of Service printed overleaf, available on request or accessible at www.sgs.com/terms_and_conditions.htm and, for electronic format documents, subject to Terms and Conditions for Electronic Documents at www.sgs.com/terms_e-document.htm. Attention is drawn to the limitation of liability, indemnification and jurisdiction issues defined therein. Any holder of this document is advised that information contained hereon reflects the Company's findings at the time of its intervention only and within the limits of Client's instructions, if any. The Company's sole responsibility is to its Client and this document does not exonerate parties to a transaction from exercising all their rights and obligations under the transaction documents. This document cannot be reproduced except in full, without prior written approval of the Company. Any unauthorized alteration, forgery or falsification of the content or appearance of this document is unlawful and offenders may be prosecuted to the fullest extent of the law. Unless otherwise stated the results shown in this test report refer only to the sample(s) tested and such sample(s) are retained for 90 days only

802.11 n (HT40)	Channel: 2422
-----------------	---------------

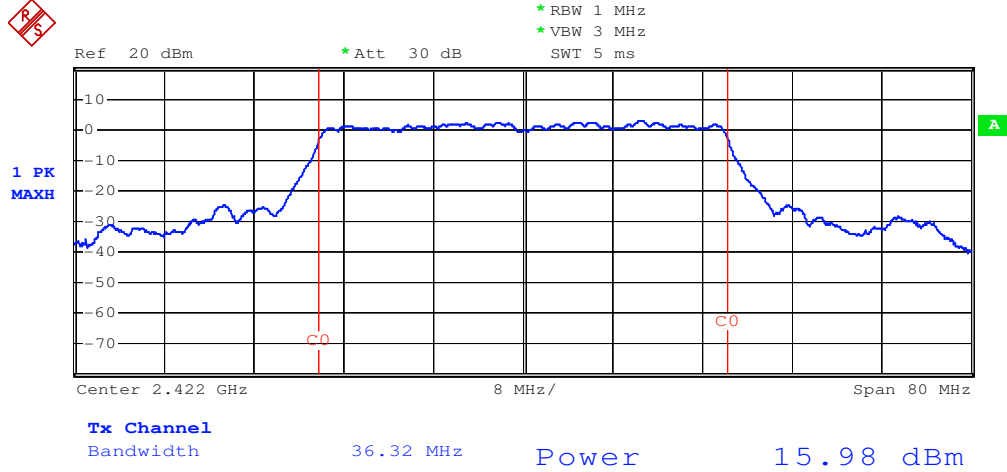

802.11 n (HT40)	Channel: 2437
-----------------	---------------

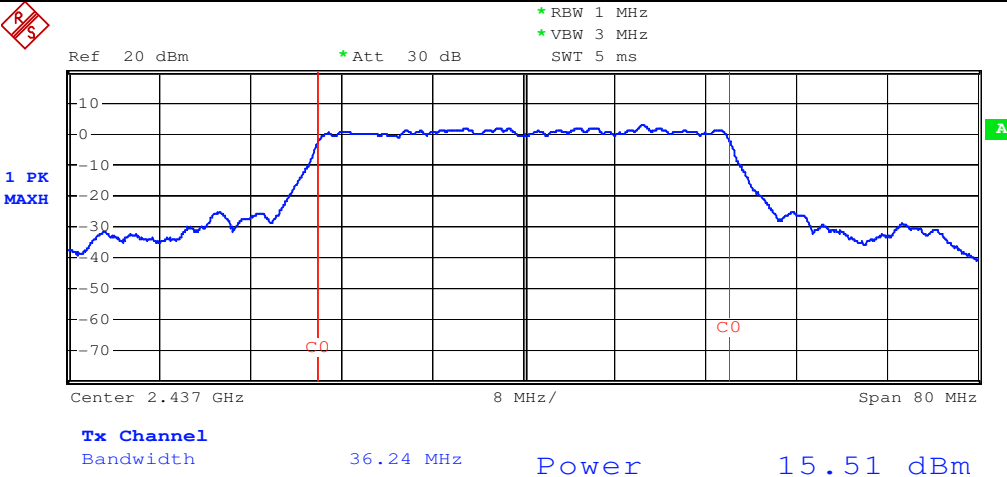

802.11 n (HT40)	Channel: 2452
-----------------	---------------

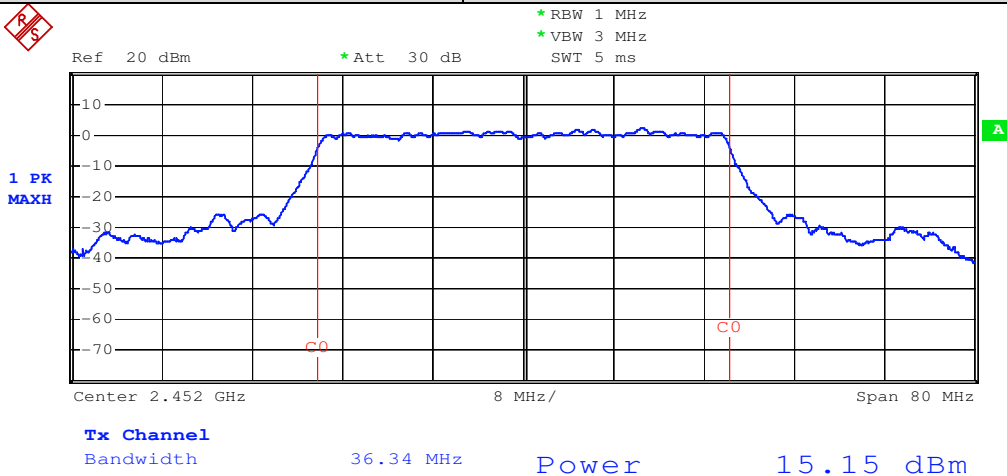

7.6 Peak Power Spectral Density

Test Configuration:

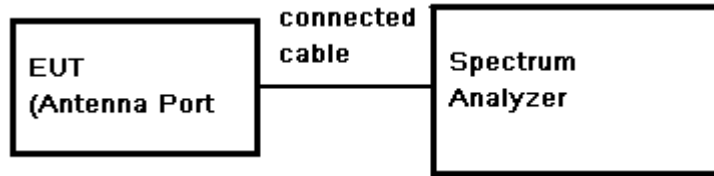

Test Procedure:

- 1) Remove the antenna from the EUT and then connect a low RF cable from the antenna port to the spectrum.
- 2) Set the spectrum analyzer: Center Frequency= Channel Frequency, RBW = 3 kHz VBW = 10 kHz. Span= 1.5 times the DTS bandwidth, Sweep = auto; Detector = Peak; Trace mode=max hold, Trace=Max hold.
- 3) Use the peak marker function to determine the maximum amplitude level within the RBW.
- 4) Record the marker level for the particular mode.
- 5) Repeat these steps for other channel and modes.

Test Limit: 8dBm/3kHz

Test Result: Pass

Test Data:

Test mode	Test Channel	Reading Value (dBm/3KHz)	PSD (dBm/3KHz)	Limit (dBm/3KHz)	Result
802.11 b	2412	-8.69	-8.19	8	Pass
	2437	-8.58	-8.08		Pass
	2462	-8.98	-8.48		Pass
802.11 g	2412	-8.86	-8.36		Pass
	2437	-8.83	-8.33		Pass
	2462	-8.50	-8.00		Pass
802.11 n(HT20)	2412	-8.96	-8.46		Pass
	2437	-8.46	-7.96		Pass
	2462	-8.74	-8.24		Pass
802.11 n(HT40)	2422	-19.69	-19.19		Pass
	2437	-19.74	-19.24		Pass
	2452	-19.81	-19.31		Pass

Remark: 1) Output Peak Power = Reading Peak Power + Cable loss

2) Cable loss=0.5dB

Test plot as follows:

802.11 b	Channel: 2412
----------	---------------



Ref 20 dBm *Att 30 dB *RBW 3 kHz Marker 1 [T1]
 *VBW 10 kHz -8.69 dBm
 SWT 1.6 s 2.411985915 GHz

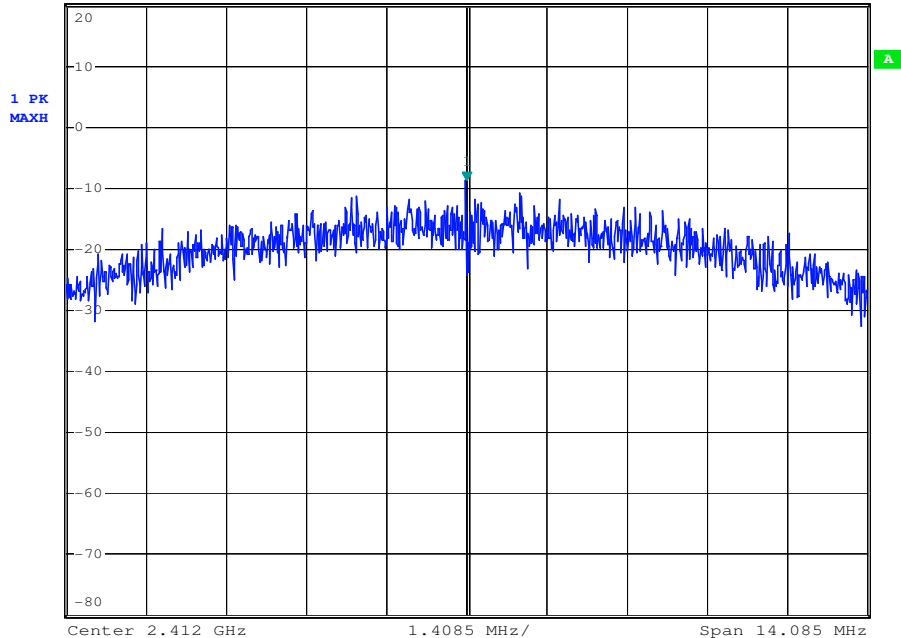

802.11 b	Channel: 2437
----------	---------------



Ref 20 dBm *Att 30 dB *RBW 3 kHz Marker 1 [T1]
 *VBW 10 kHz -8.58 dBm
 SWT 1.6 s 2.436985870 GHz

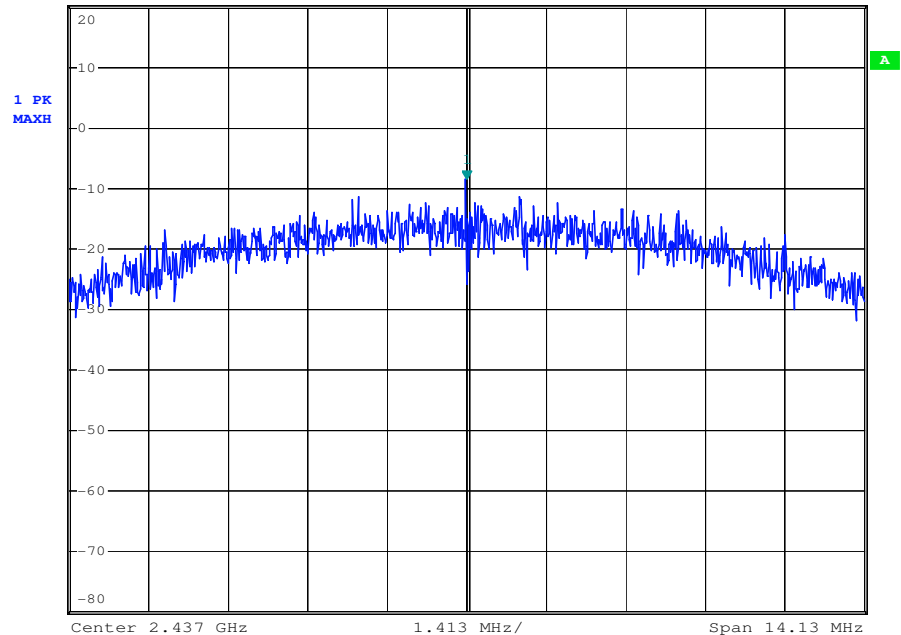



802.11 b Channel: 2462

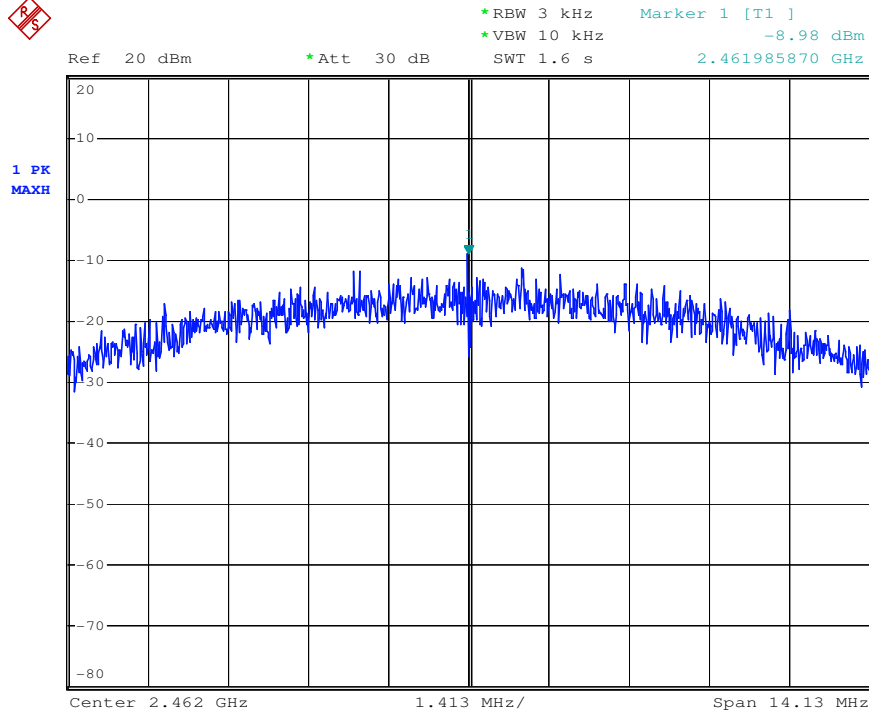

802.11 g Channel: 2412

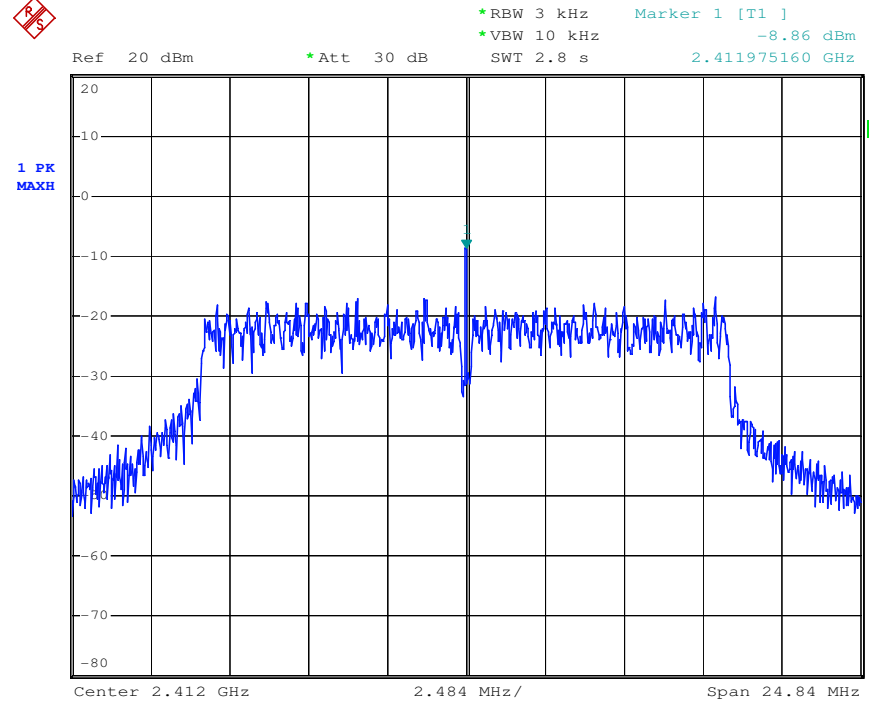

802.11 g Channel: 2437

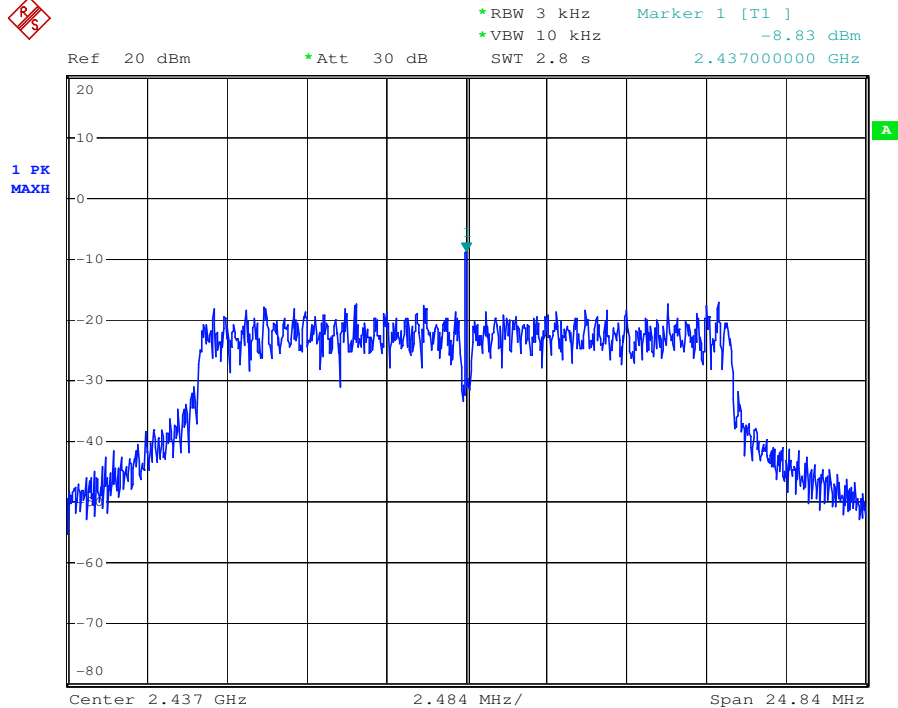

802.11 g Channel: 2462

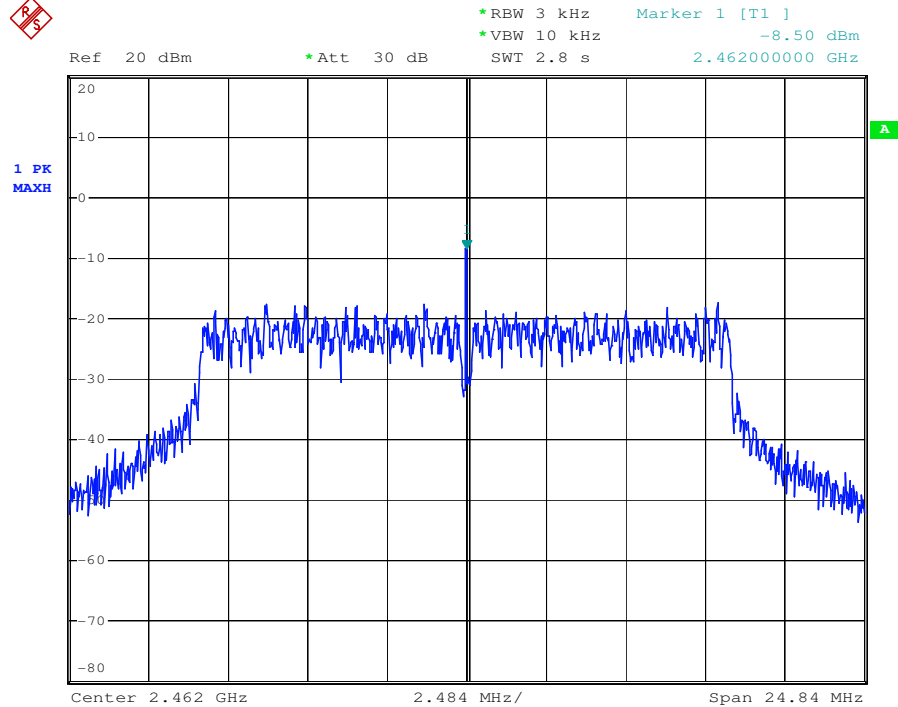

802.11 n (HT20) Channel: 2412

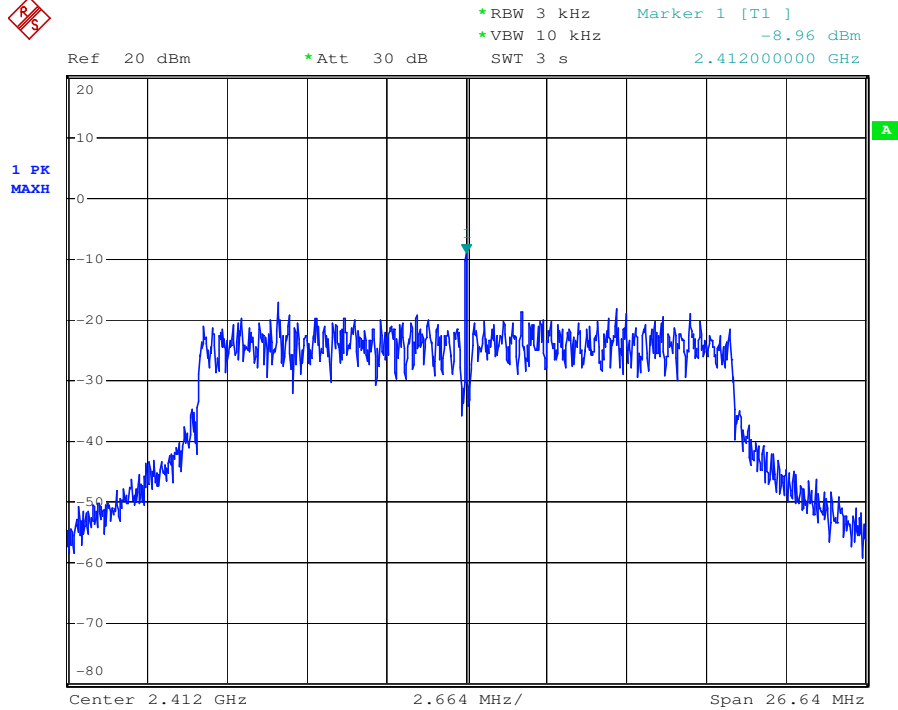

802.11 n (HT20) Channel: 2437

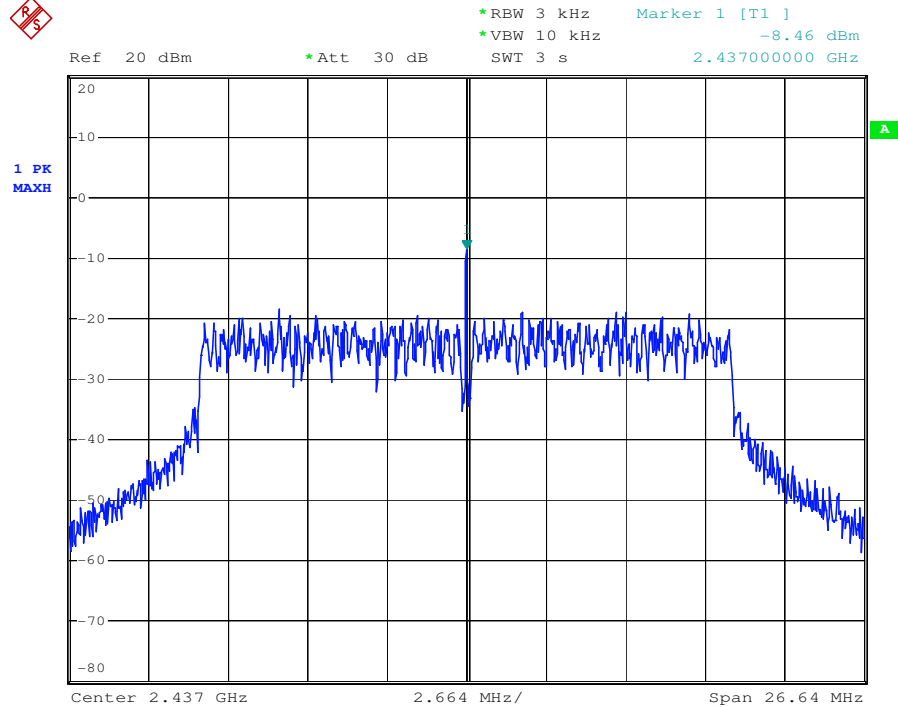

802.11 n (HT20)	Channel: 2462
-----------------	---------------

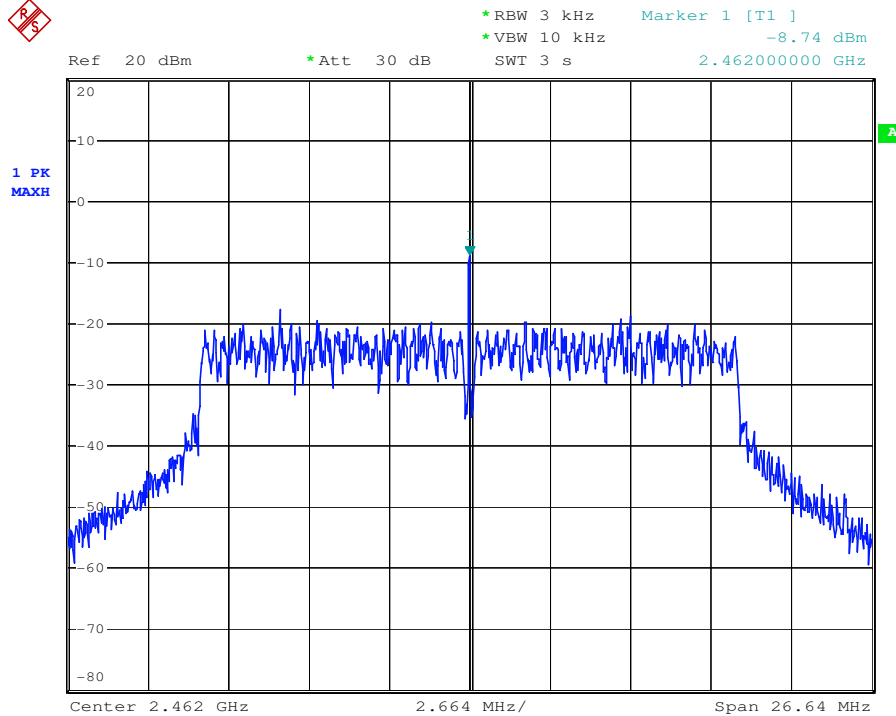

802.11 n (HT40)	Channel: 2422
-----------------	---------------

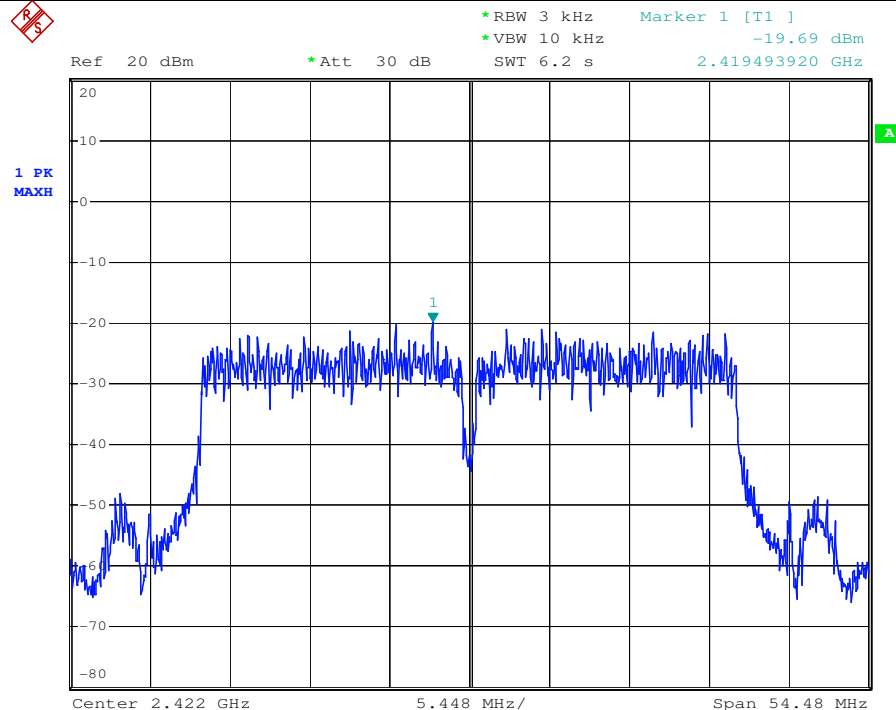

802.11 n (HT40)	Channel: 2437
-----------------	---------------

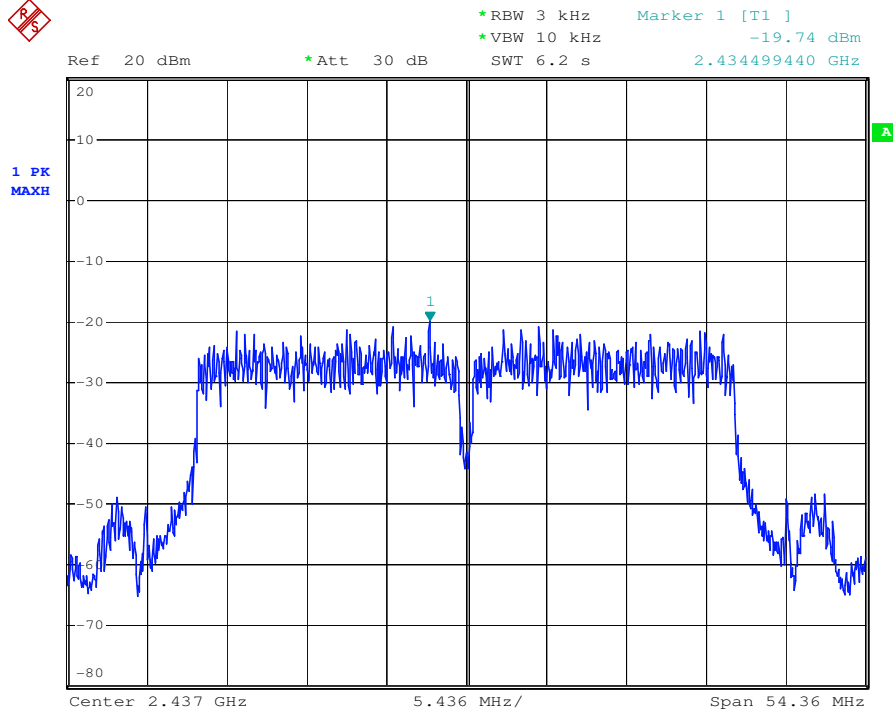

802.11 n (HT40)	Channel: 2452
-----------------	---------------

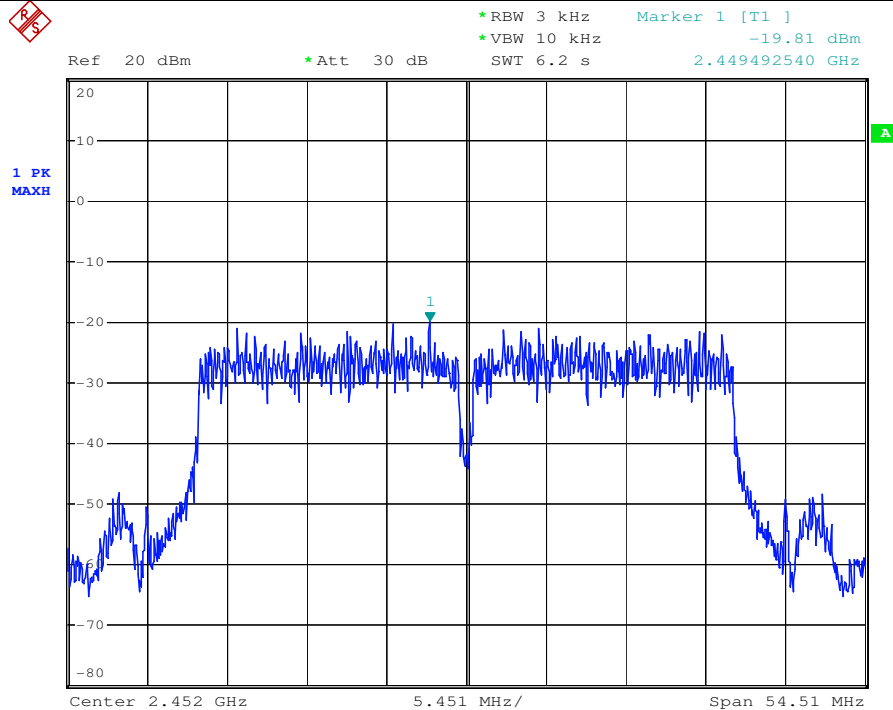

This document is issued by the Company subject to its General Conditions of Service printed overleaf, available on request or accessible at www.sgs.com/terms_and_conditions.htm and, for electronic format documents, subject to Terms and Conditions for Electronic Documents at www.sgs.com/terms_e-document.htm. Attention is drawn to the limitation of liability, indemnification and jurisdiction issues defined therein. Any holder of this document is advised that information contained hereon reflects the Company's findings at the time of its intervention only and within the limits of Client's instructions, if any. The Company's sole responsibility is to its Client and this document does not exonerate parties to a transaction from exercising all their rights and obligations under the transaction documents. This document cannot be reproduced except in full, without prior written approval of the Company. Any unauthorized alteration, forgery or falsification of the content or appearance of this document is unlawful and offenders may be prosecuted to the fullest extent of the law. Unless otherwise stated the results shown in this test report refer only to the sample(s) tested and such sample(s) are retained for 90 days only

7.7 Conducted Spurious Emissions and Band-edge

Test Configuration:

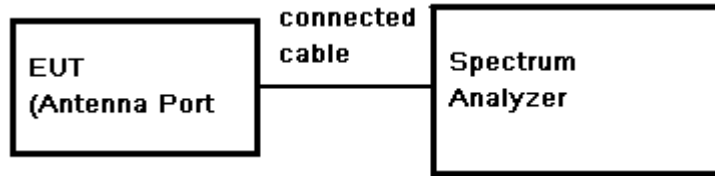

Test Procedure:

- 1) Remove the antenna from the EUT and then connect a low RF cable from the antenna port to the spectrum.
- 2) Set the spectrum analyzer: RBW = 100KHz. VBW = 300KHz. Sweep = auto; Detector Function = Peak (Max. hold).

Limit:

(d) In any 100 kHz bandwidth outside the frequency band in which the spread spectrum or digitally modulated intentional radiator is operating, the radio frequency power that is produced by the intentional radiator shall be at least 20 dB below that in the 100 kHz bandwidth within the band that contains the Highest level of the desired power, based on either an RF conducted or a radiated measurement, provided the transmitter demonstrates compliance with the peak conducted power limits.

Test Result:

Pass

7.7.1 Conducted spurious emission

Test plot as follows:

802.11 b	Channel: 2412
----------	---------------

30MHz-3GHz:

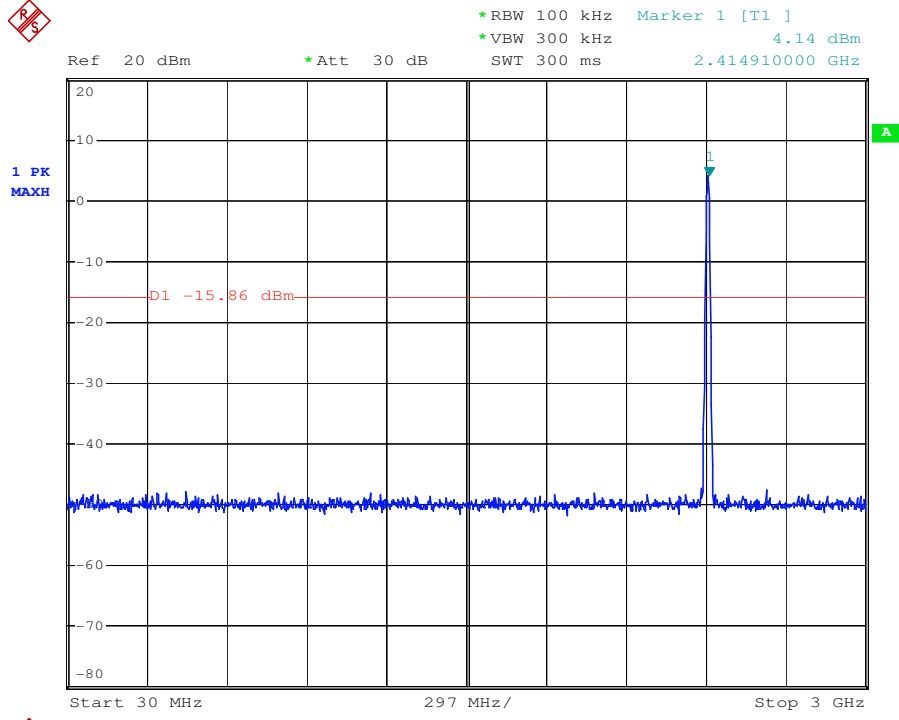

3GHz-25GHz:

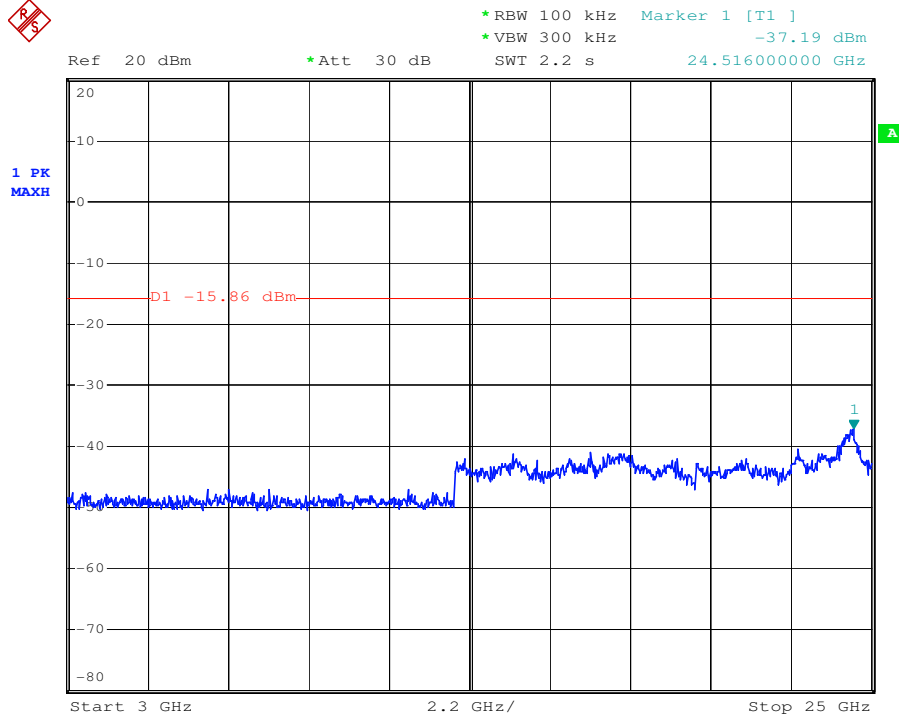

802.11 b Channel: 2437

30MHz-3GHz:

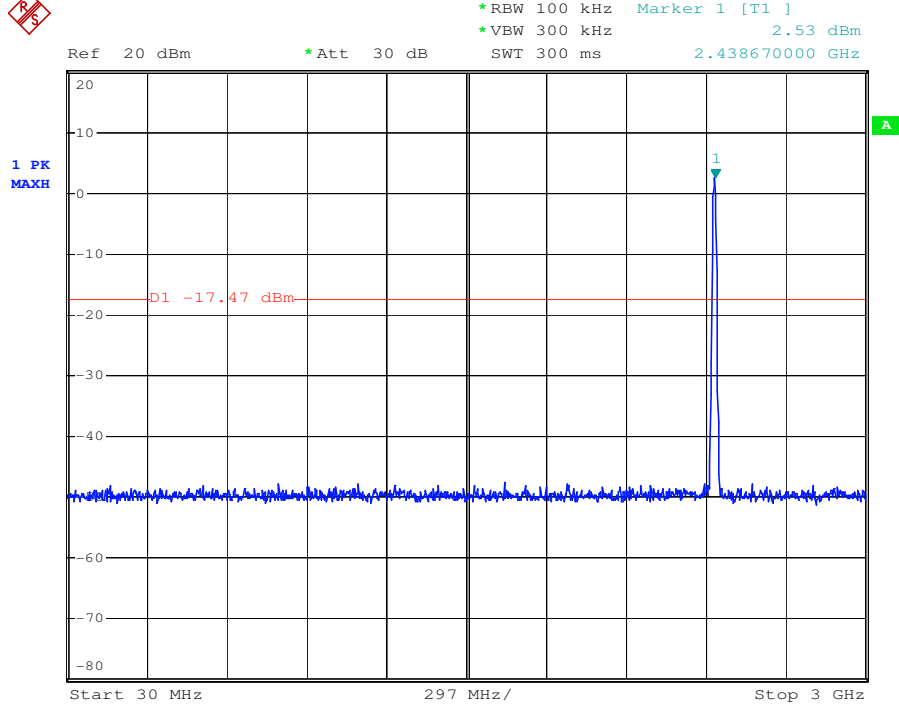

3GHz-25GHz:

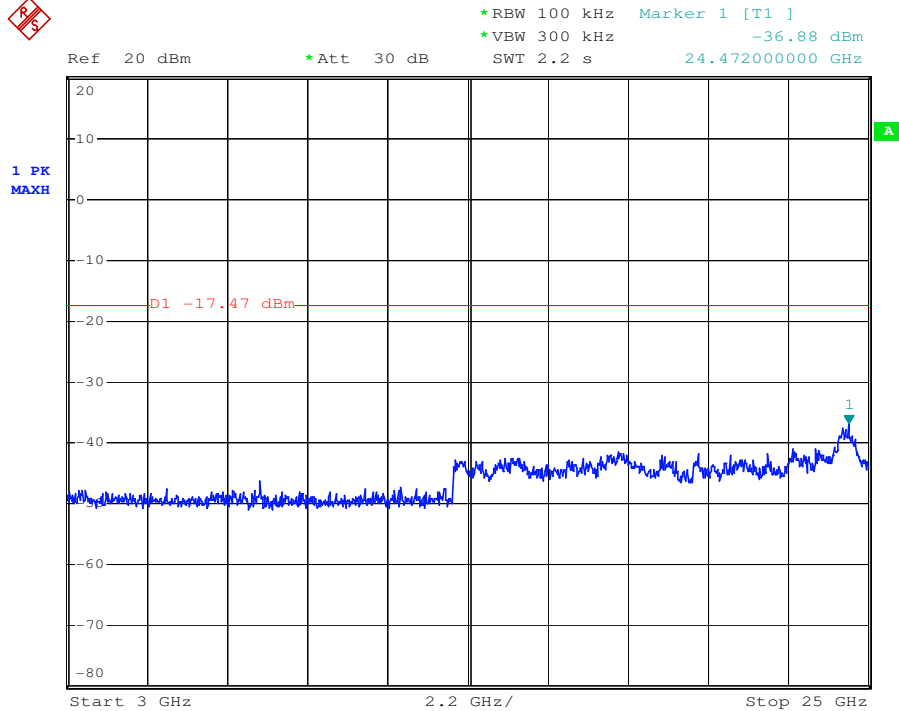

802.11 b Channel: 2462

30MHz-3GHz:



Ref 20 dBm *Att 30 dB *RBW 100 kHz Marker 1 [T1] 1.39 dBm
*VBW 300 kHz 2.462430000 GHz
SWT 300 ms

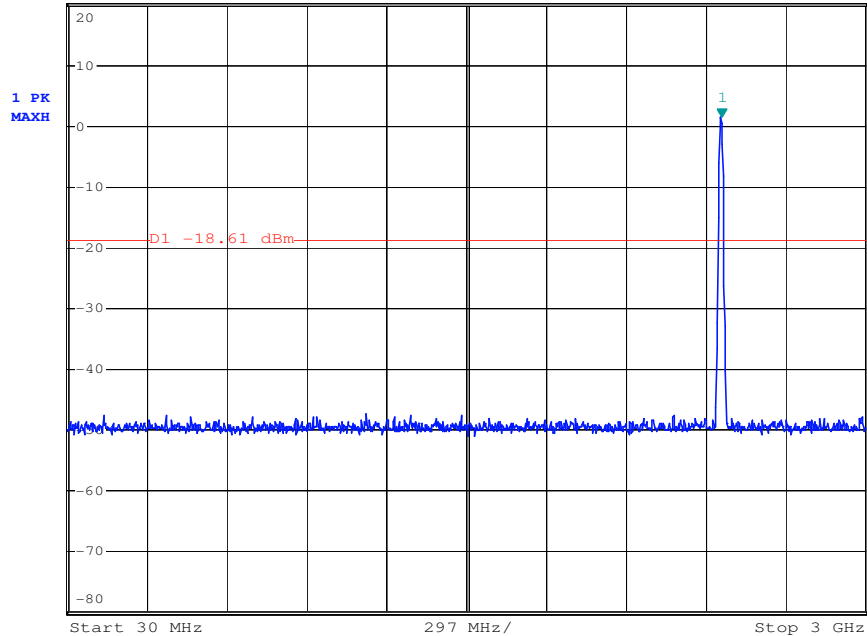

3GHz-25GHz:



Ref 20 dBm *Att 30 dB *RBW 100 kHz Marker 1 [T1] -36.05 dBm
*VBW 300 kHz 24.406000000 GHz
SWT 2.2 s

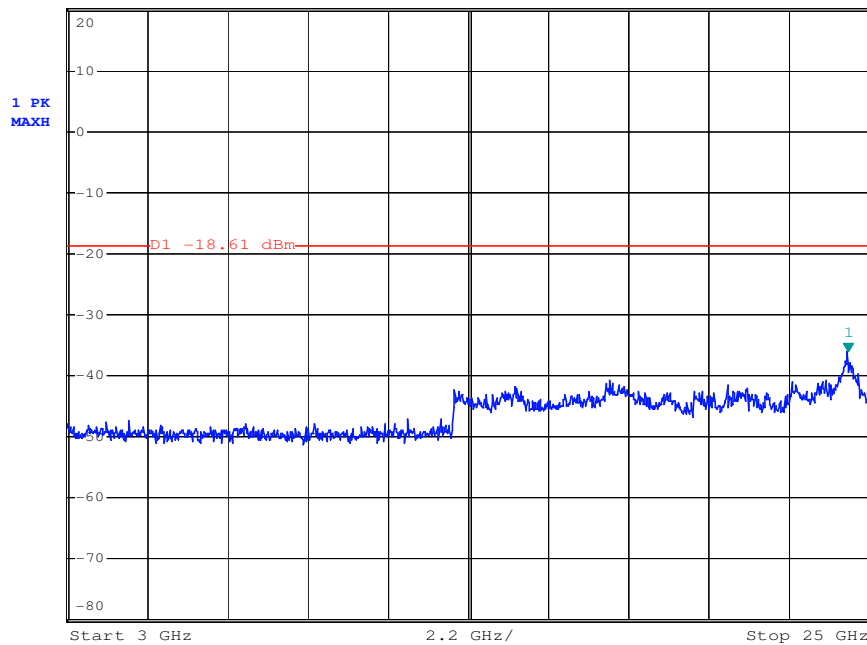

802.11 g Channel: 2412

30MHz-3GHz:

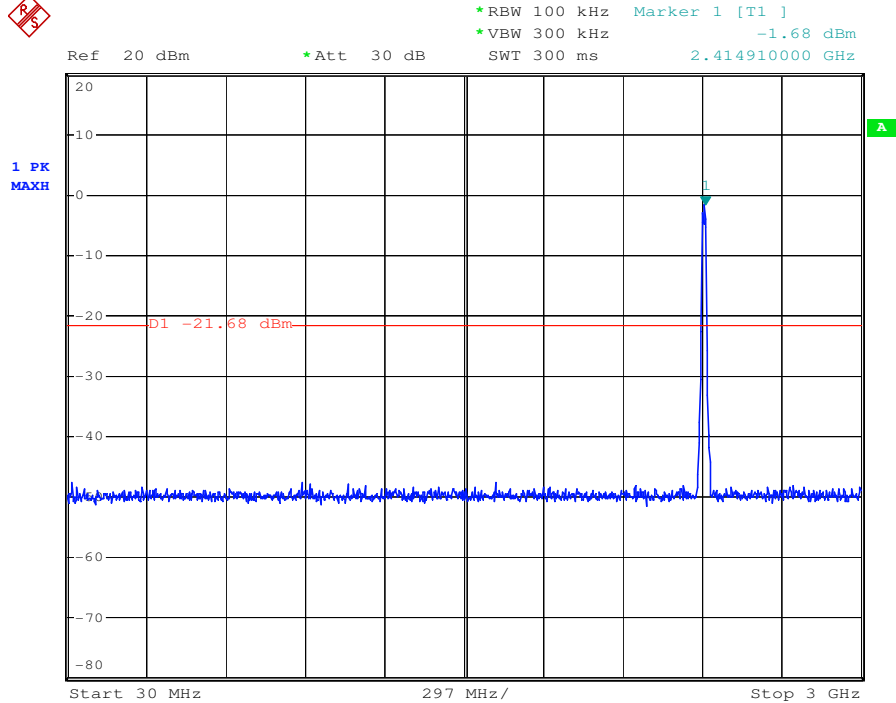

3GHz-25GHz:

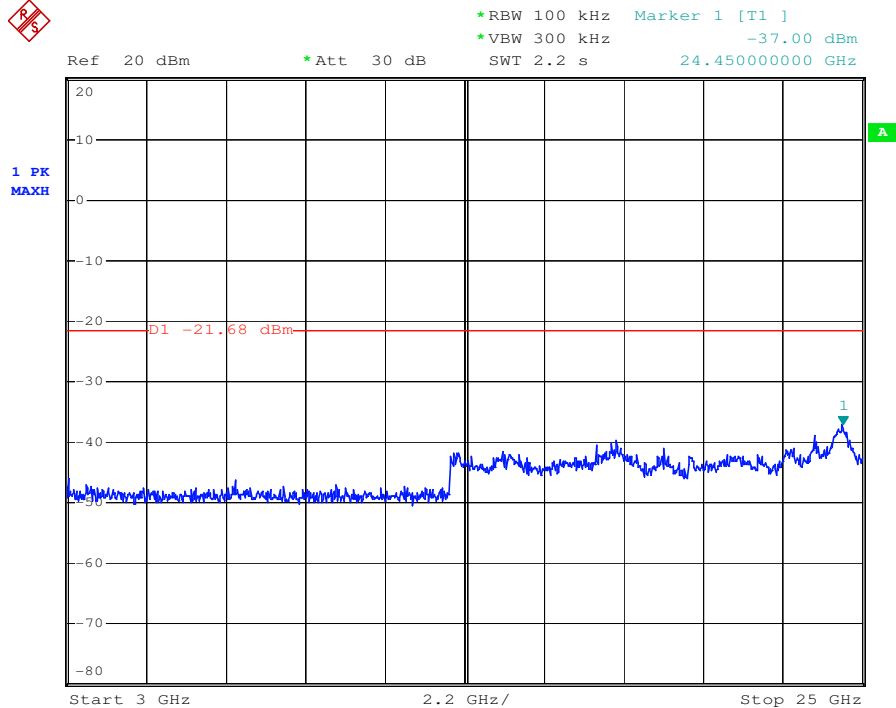

802.11 g Channel: 2437

30MHz-3GHz:

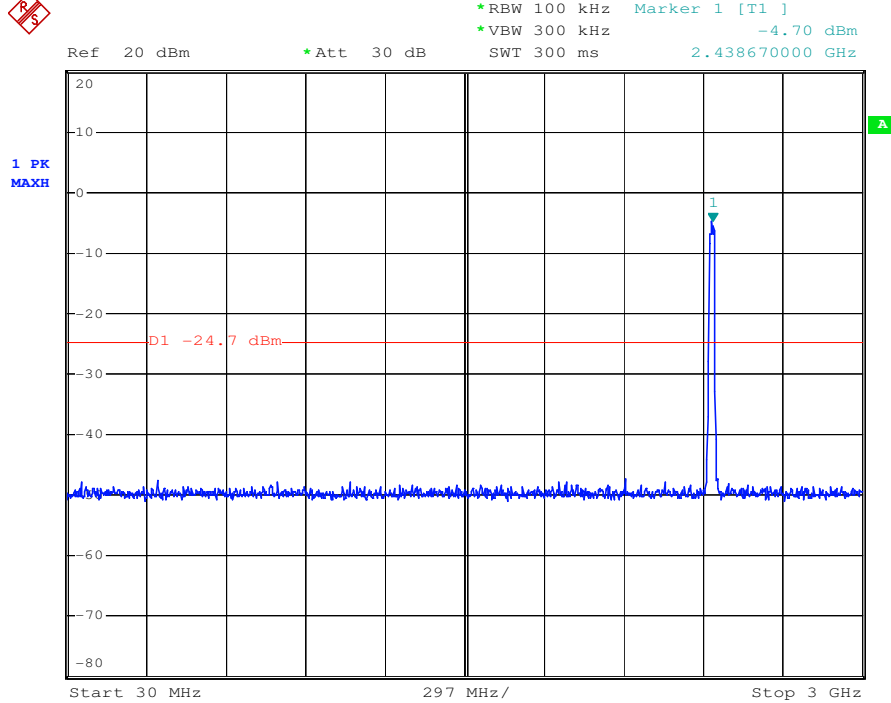

3GHz-25GHz:

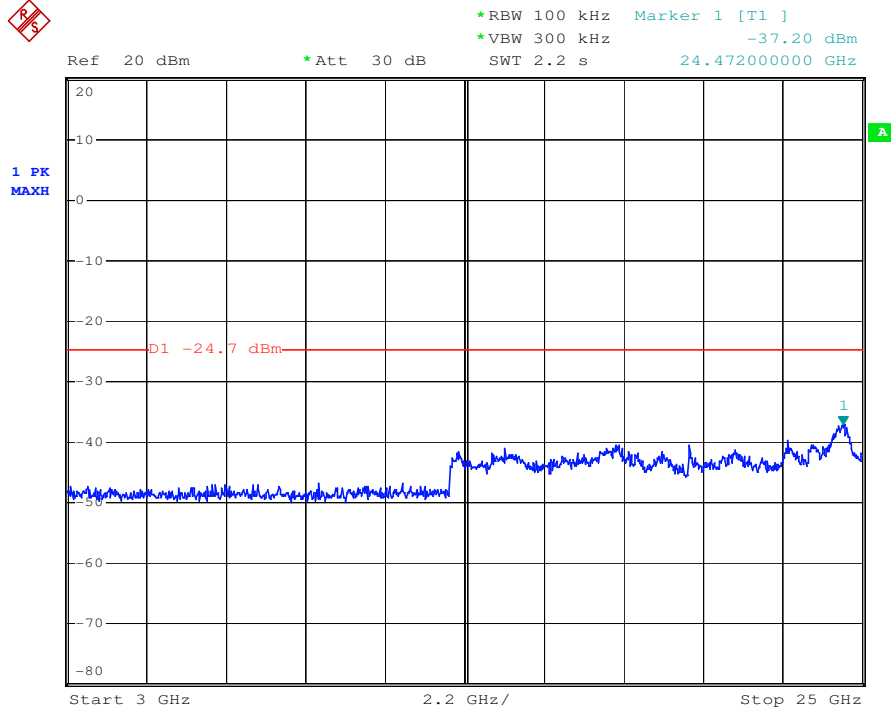

802.11 g Channel: 2462

30MHz-3GHz:

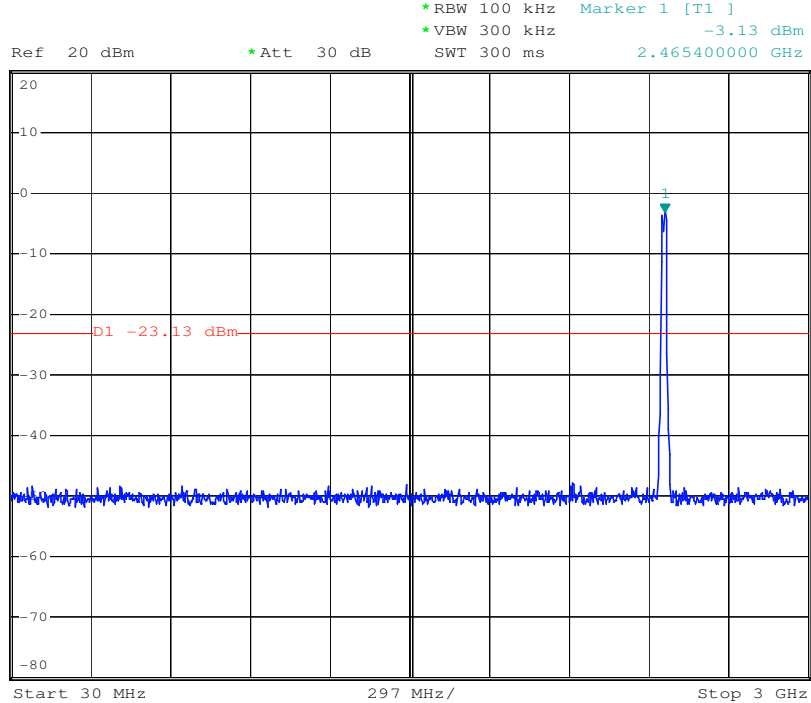

3GHz-25GHz:

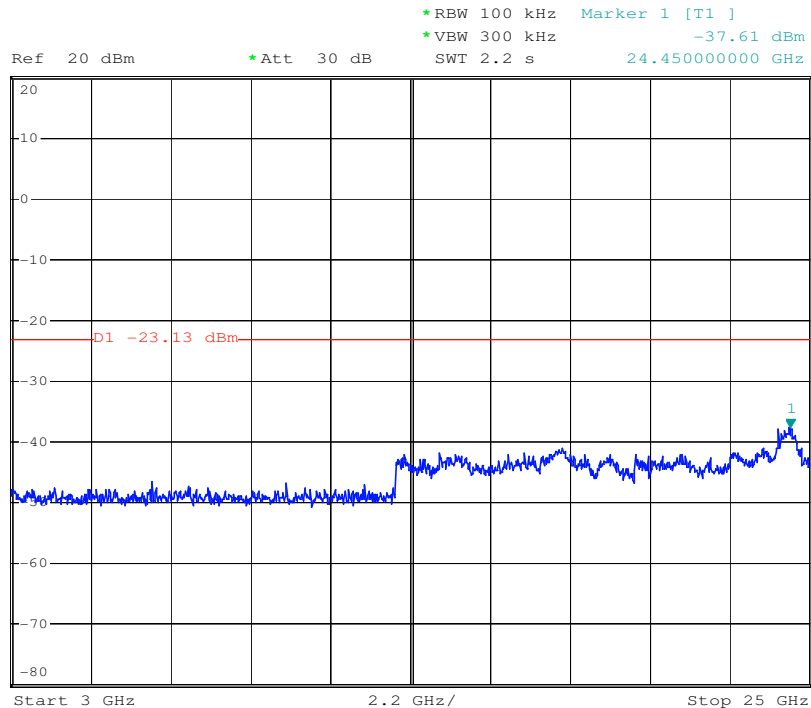

802.11 n(HT20)	Channel: 2412
----------------	---------------

30MHz-3GHz:

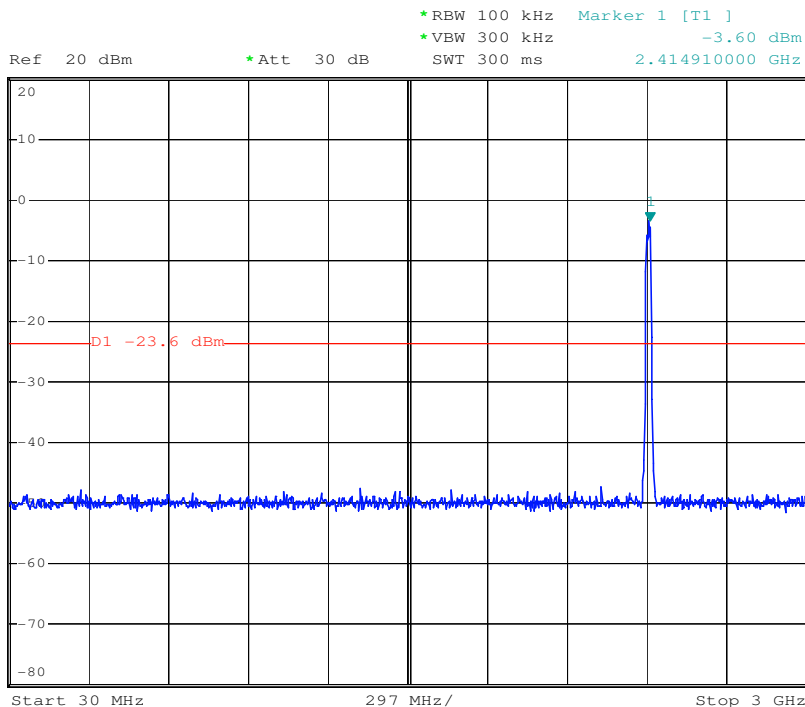

3GHz-25GHz:

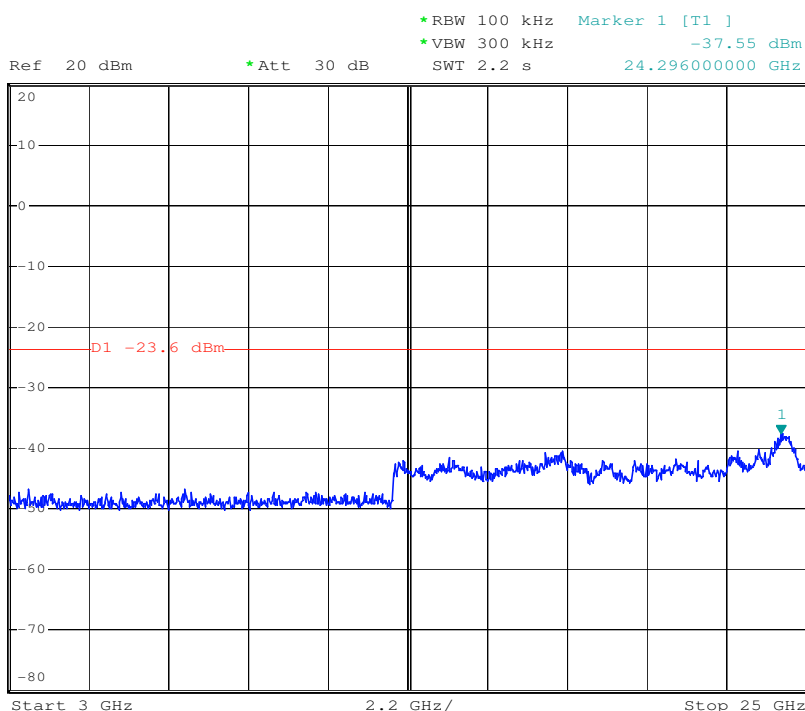

802.11 n(HT20) Channel: 2437

30MHz-3GHz:



Ref 20 dBm *Att 30 dB *RBW 100 kHz Marker 1 [T1] *VBW 300 kHz -3.71 dBm SWT 300 ms 2.429760000 GHz

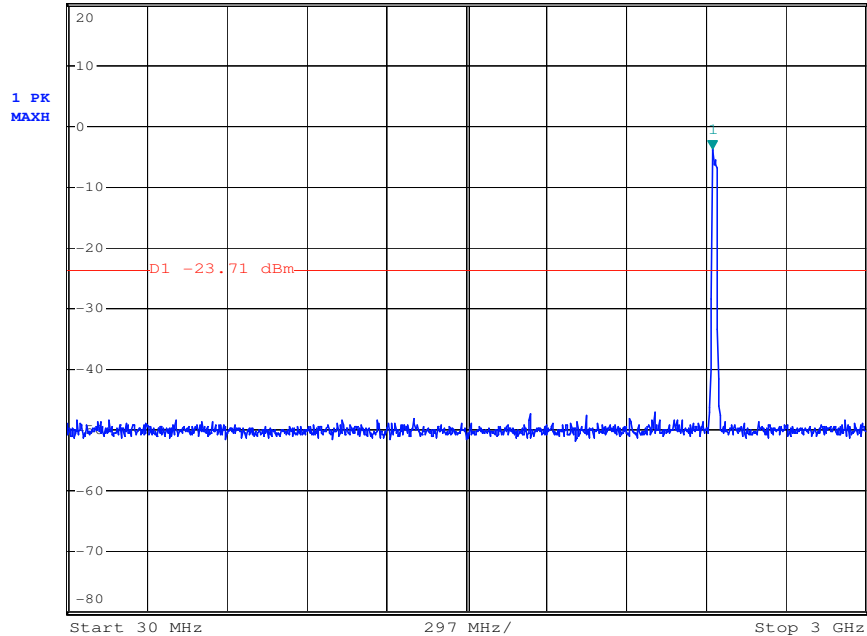

3GHz-25GHz:



Ref 20 dBm *Att 30 dB *RBW 100 kHz Marker 1 [T1] *VBW 300 kHz -36.84 dBm SWT 2.2 s 24.274000000 GHz

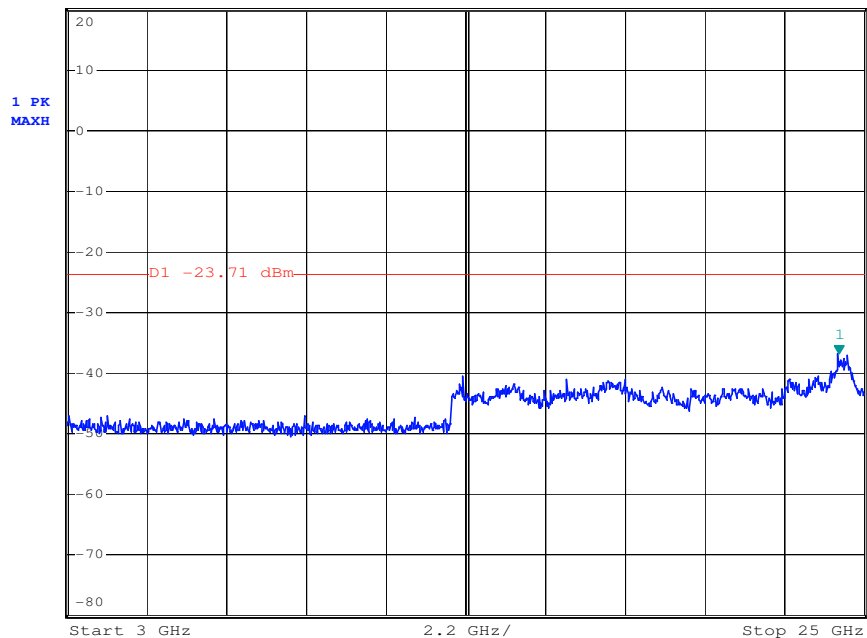

802.11 n(HT20) Channel: 2462

30MHz-3GHz:



Ref 20 dBm *Att 30 dB *RBW 100 kHz Marker 1 [T1] -4.04 dBm
*VBW 300 kHz 2.465400000 GHz
SWT 300 ms

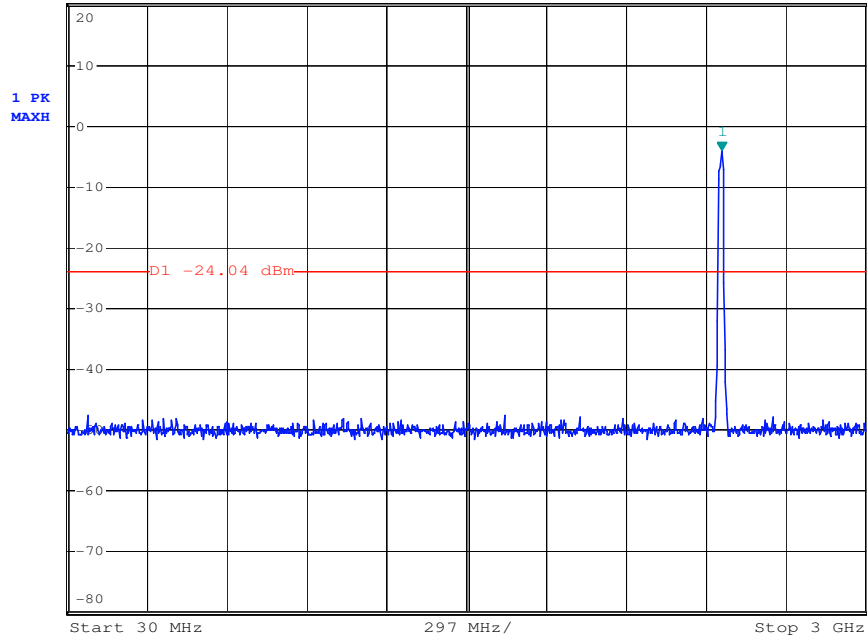

3GHz-25GHz:



Ref 20 dBm *Att 30 dB *RBW 100 kHz Marker 1 [T1] -36.66 dBm
*VBW 300 kHz 24.450000000 GHz
SWT 2.2 s

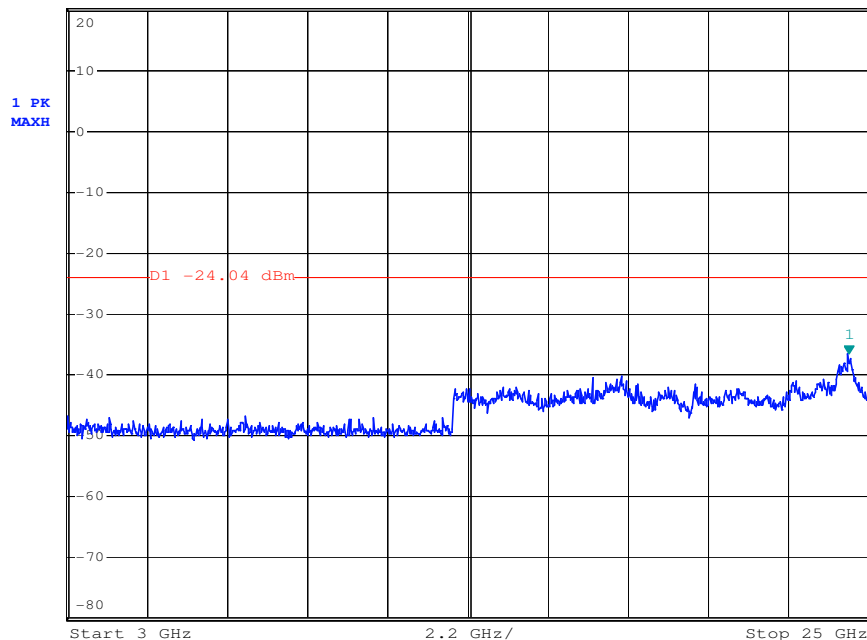

802.11 n(HT40) Channel: 2422

30MHz-3GHz:



Ref 20 dBm *Att 30 dB *RBW 100 kHz Marker 1 [T1] -6.15 dBm
*VBW 300 kHz 2.414910000 GHz
SWT 300 ms

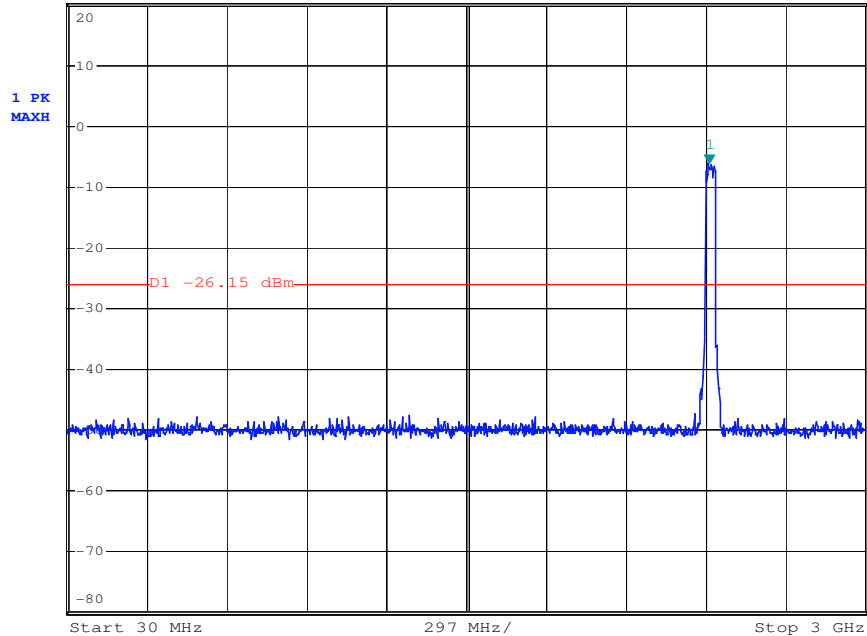

3GHz-25GHz:



Ref 20 dBm *Att 30 dB *RBW 100 kHz Marker 1 [T1] -37.28 dBm
*VBW 300 kHz 24.560000000 GHz
SWT 2.2 s

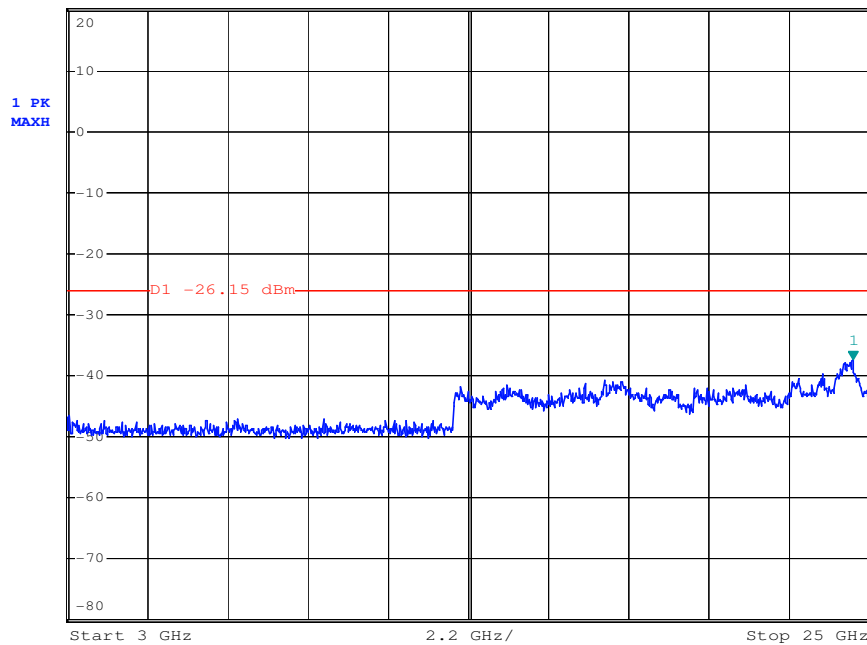

802.11 n(HT40) Channel: 2437

30MHz-3GHz:

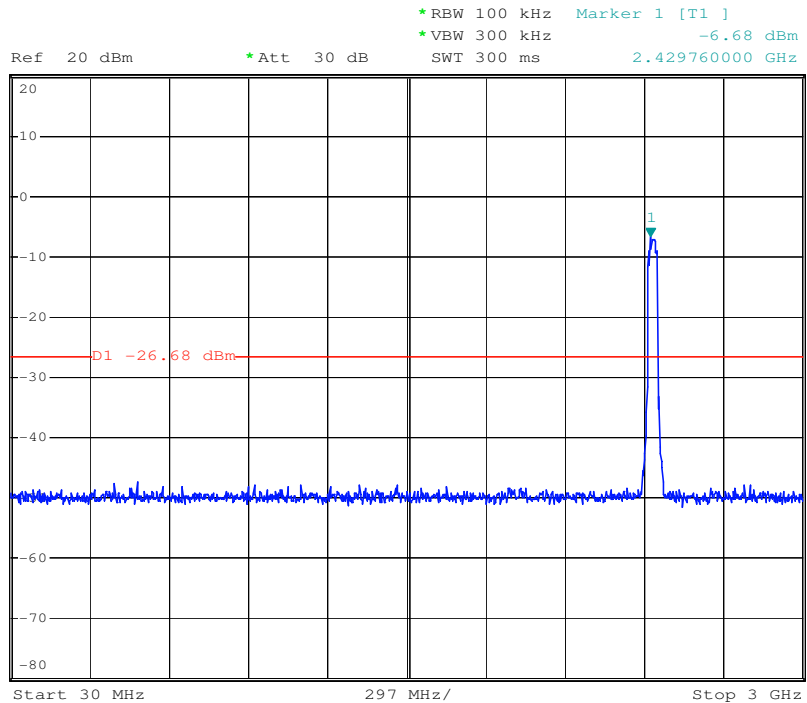

3GHz-25GHz:

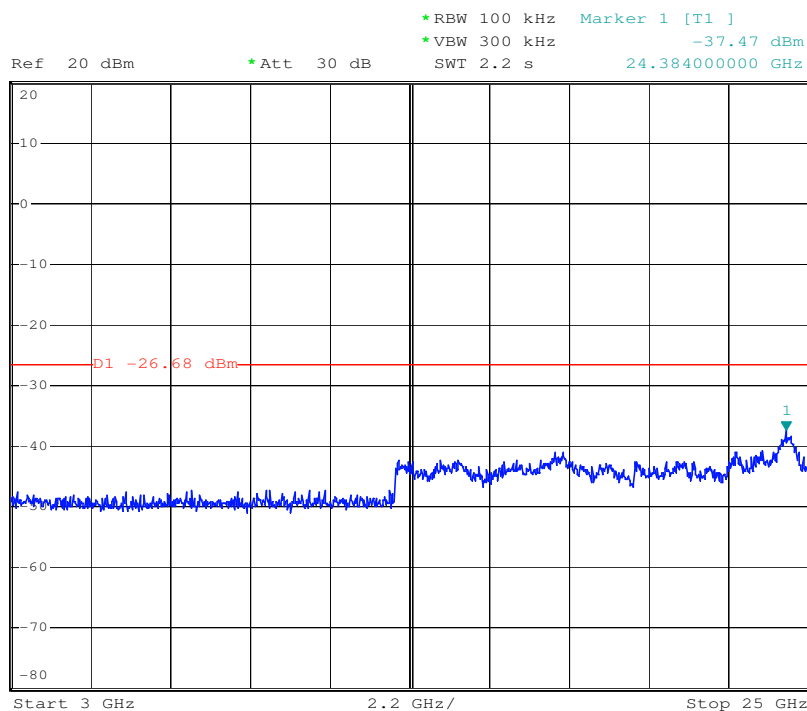

802.11 n(HT40) Channel: 2452

30MHz-3GHz:



Ref 20 dBm *Att 30 dB *RBW 100 kHz Marker 1 [T1] *VBW 300 kHz -6.92 dBm
SWT 300 ms 2.453520000 GHz

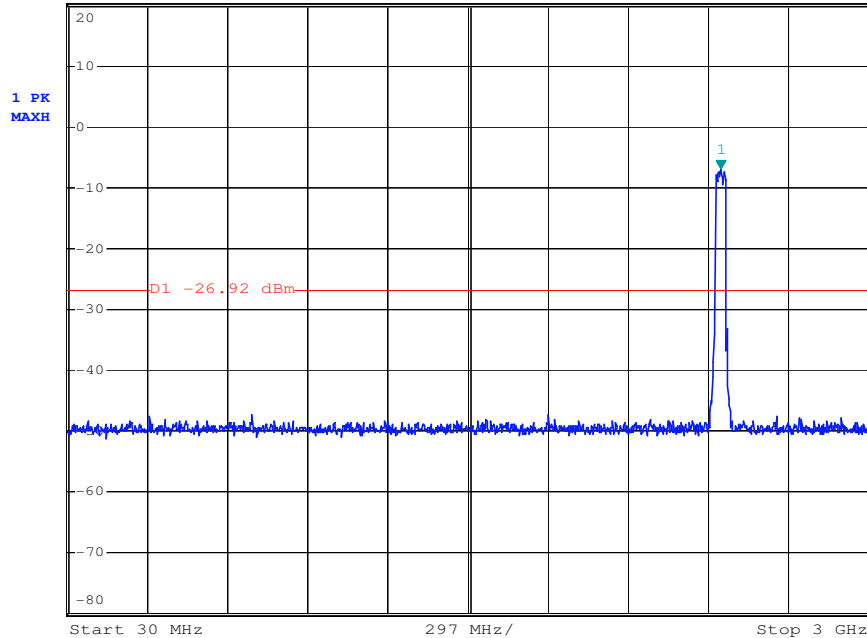

3GHz-25GHz:



Ref 20 dBm *Att 30 dB *RBW 100 kHz Marker 1 [T1] *VBW 300 kHz -36.84 dBm
SWT 2.2 s 24.472000000 GHz

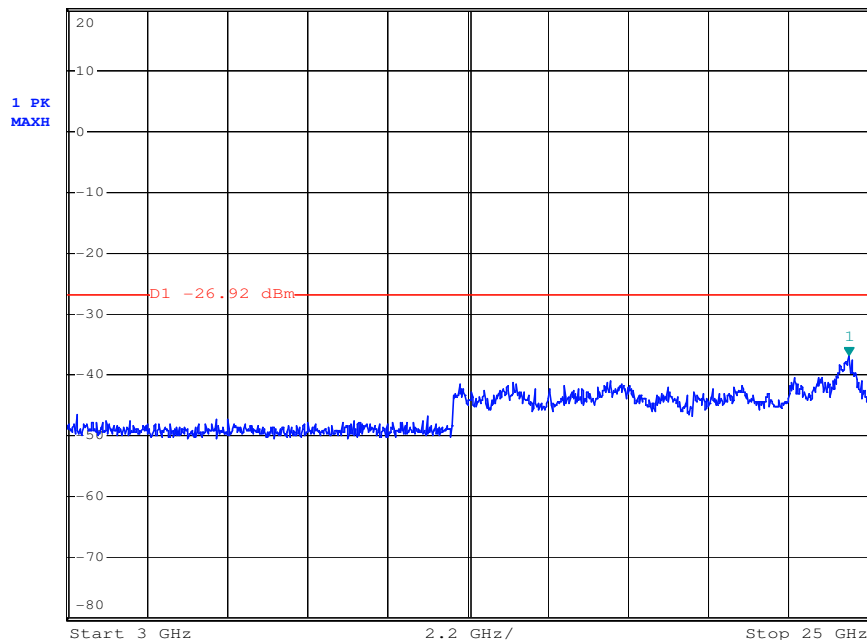

7.7.2 Conducted Band-edge

Test plot as follows:

802.11 b	Channel: 2412
----------	---------------

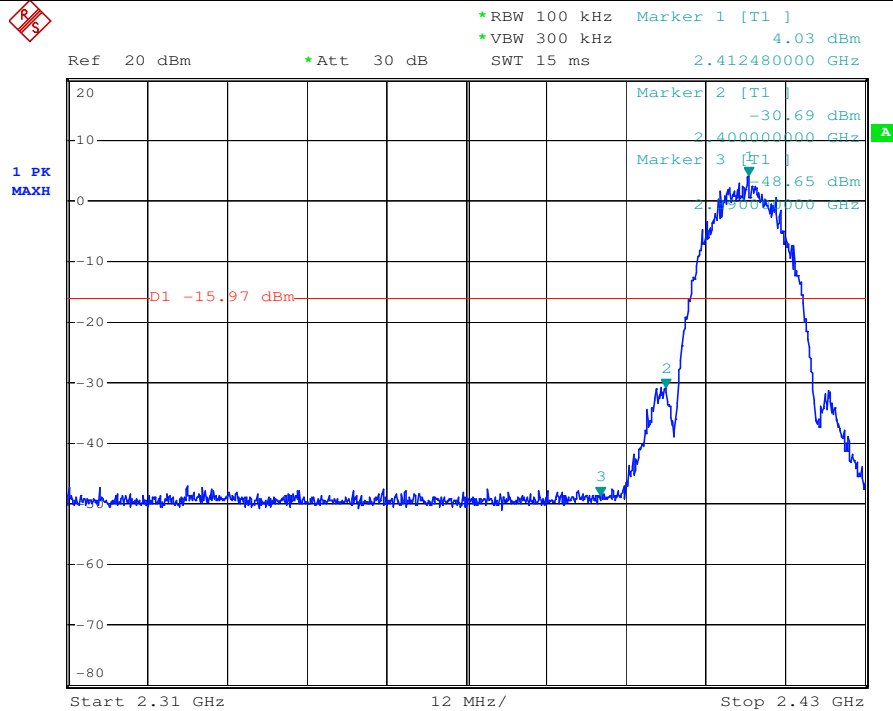

802.11 b	Channel: 2462
----------	---------------

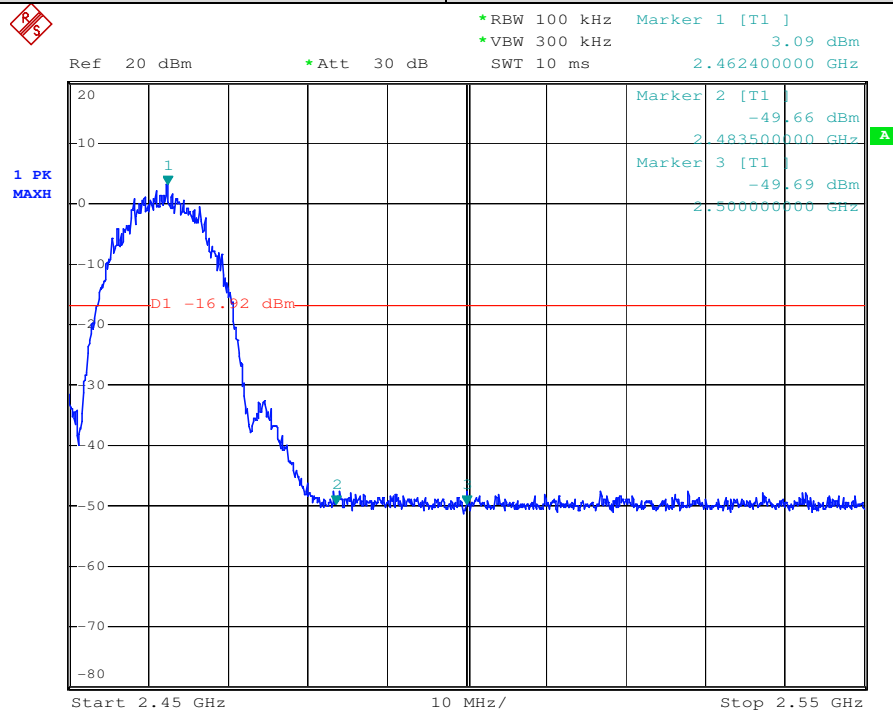

802.11 g Channel: 2412

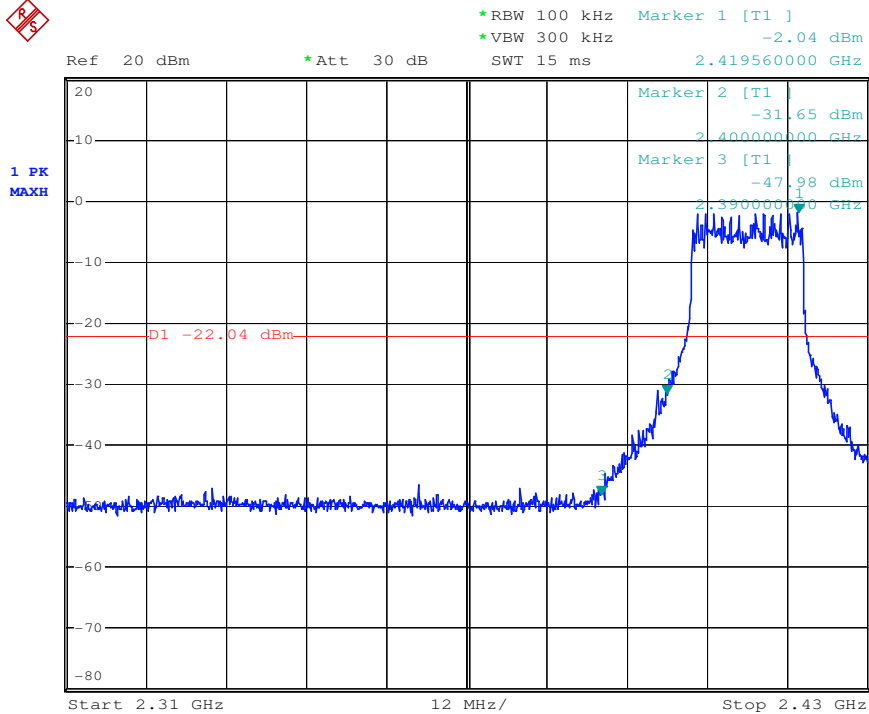

802.11 g Channel: 2462

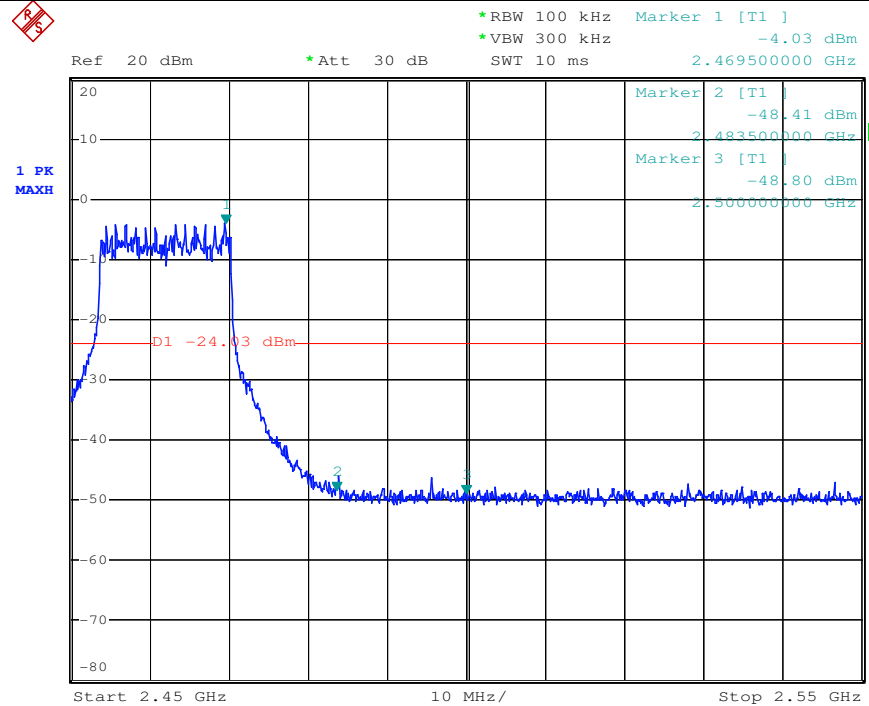

802.11 n(HT20) Channel: 2412

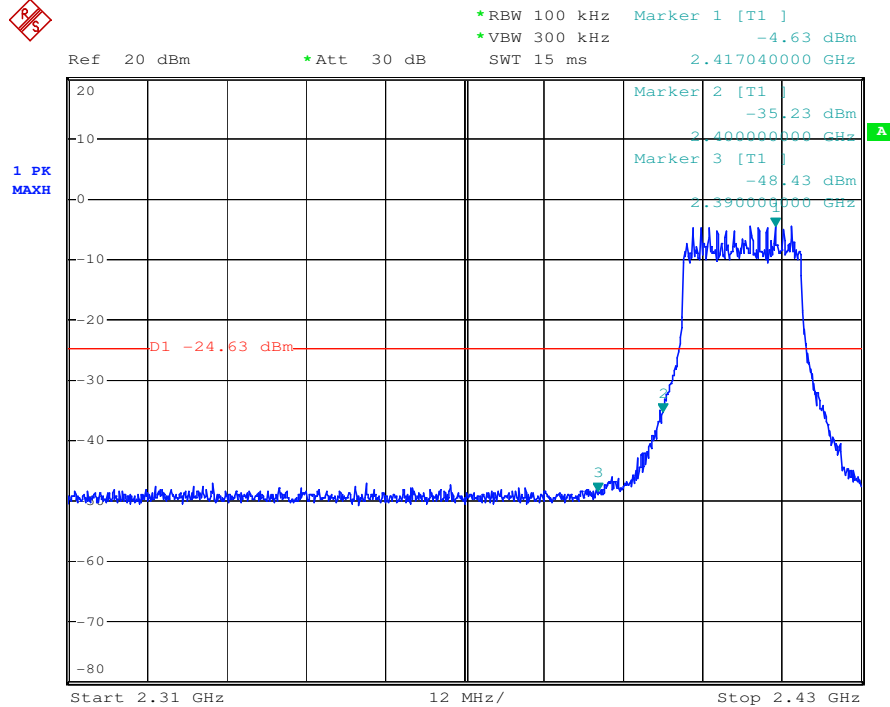

802.11 n(HT20) Channel: 2462

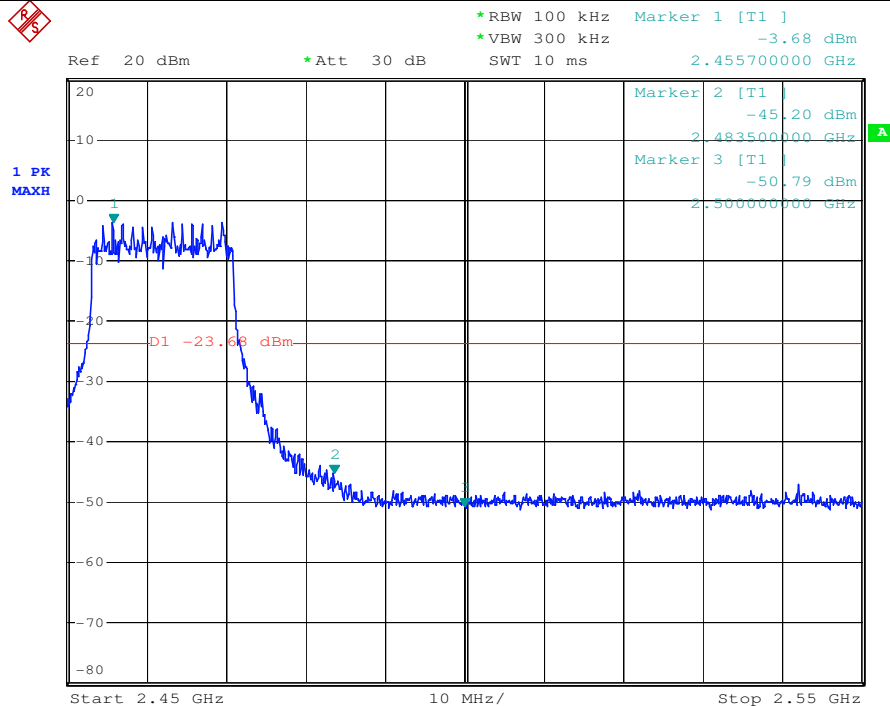

This document is issued by the Company subject to its General Conditions of Service printed overleaf, available on request or accessible at www.sgs.com/terms_and_conditions.htm and, for electronic format documents, subject to Terms and Conditions for Electronic Documents at www.sgs.com/terms_e-document.htm. Attention is drawn to the limitation of liability, indemnification and jurisdiction issues defined therein. Any holder of this document is advised that information contained hereon reflects the Company's findings at the time of its intervention only and within the limits of Client's instructions, if any. The Company's sole responsibility is to its Client and this document does not exonerate parties to a transaction from exercising all their rights and obligations under the transaction documents. This document cannot be reproduced except in full, without prior written approval of the Company. Any unauthorized alteration, forgery or falsification of the content or appearance of this document is unlawful and offenders may be prosecuted to the fullest extent of the law. Unless otherwise stated the results shown in this test report refer only to the sample(s) tested and such sample(s) are retained for 90 days only

802.11 n(HT40) Channel: 2422

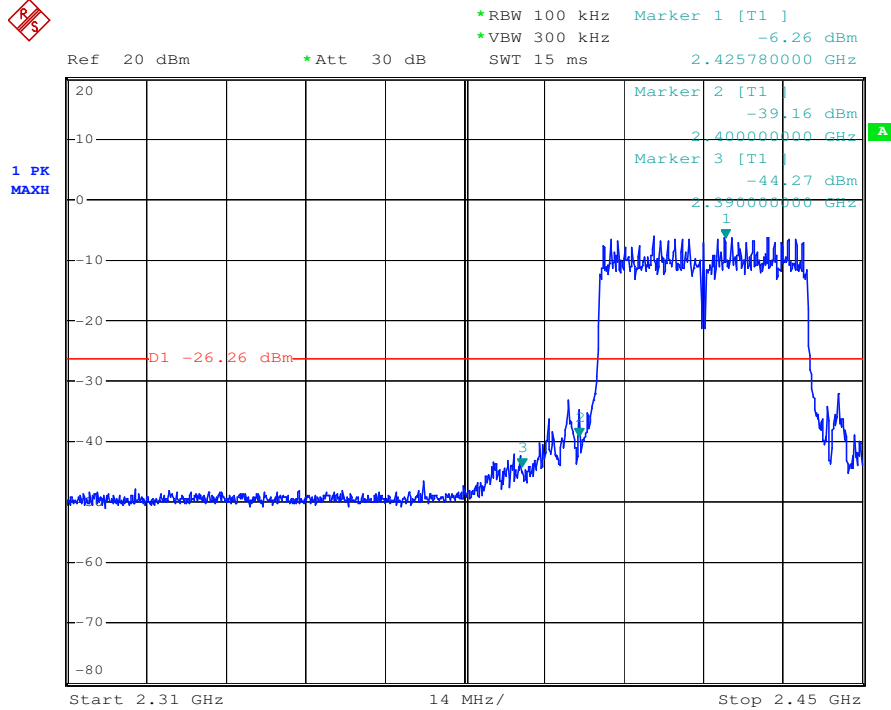

802.11 n(HT40) Channel: 2452

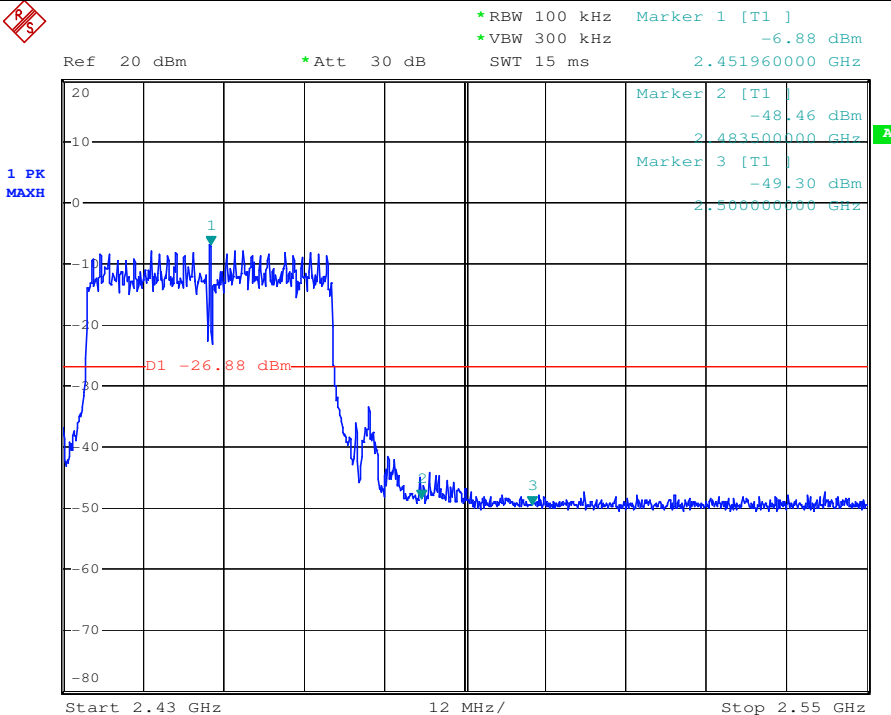

7.8 Radiated Spurious Emissions and Band-edge

Frequency Range: 9KHz to 25GHz

Test site/setup: Measurement Distance: 3m (Semi-Anechoic Chamber)
Test instrumentation set-up:

Frequency Range	Detector	RBW	VBW
0.009MHz-0.090MHz	Peak	10kHz	30kHz
0.009MHz-0.090MHz	Average	10kHz	30kHz
0.090MHz-0.110MHz	Quasi-peak	10kHz	30kHz
0.110MHz-0.490MHz	Peak	10kHz	30kHz
0.110MHz-0.490MHz	Average	10kHz	30kHz
0.490MHz -30MHz	Quasi-peak	10kHz	30kHz
30MHz-1GHz	Quasi-peak	100kHz	300kHz
Above 1GHz	Peak	RBW=1MHz	VBW≥RBW
	Average		VBW=10Hz

Sweep=Auto

15.209 Limit:

Frequency	Limit (dBuV/m)
0.009MHz-0.490MHz	128.5 ~ 93.8
0.490MHz-1.705MHz	73.8 ~63.0
1.705MHz-30MHz	69.5
30MHz-88MHz	40.0
88MHz-216MHz	43.5
216MHz-960MHz	46.0
960MHz-1GHz	54.0
Above 1GHz	54.0

Note: 15.35(b), Unless otherwise specified, the limit on peak radio frequency emissions is 20dB above the maximum permitted average emission limit applicable to the equipment under test. This peak limit applies to the total peak emission level radiated by the device.

Test Configuration:

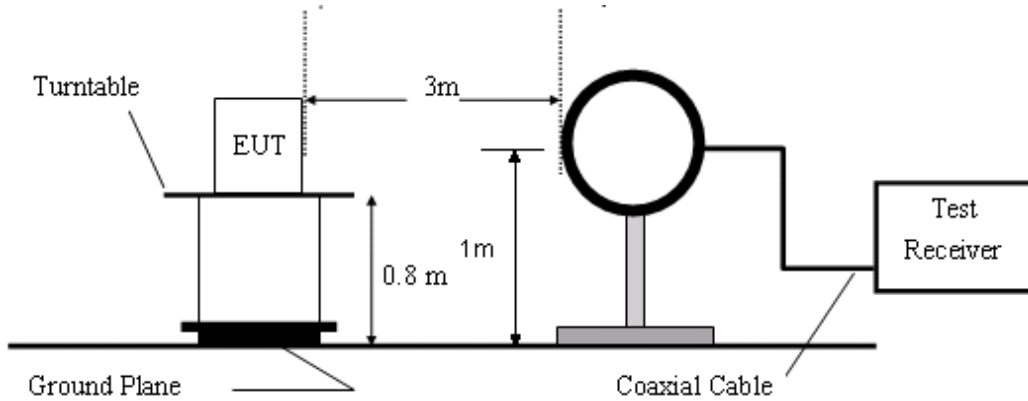

Figure1. Below 30MHz radiated emissions test configuration

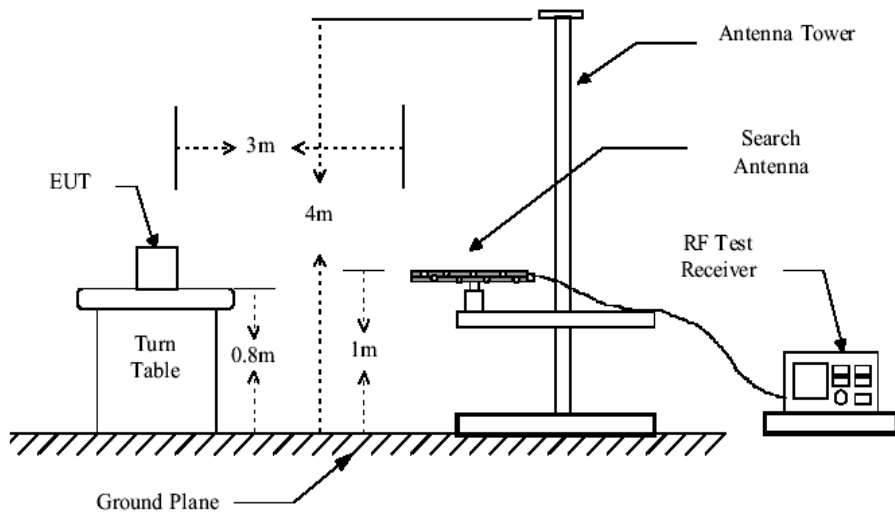

Figure2. 30MHz to 1GHz radiated emissions test configuration

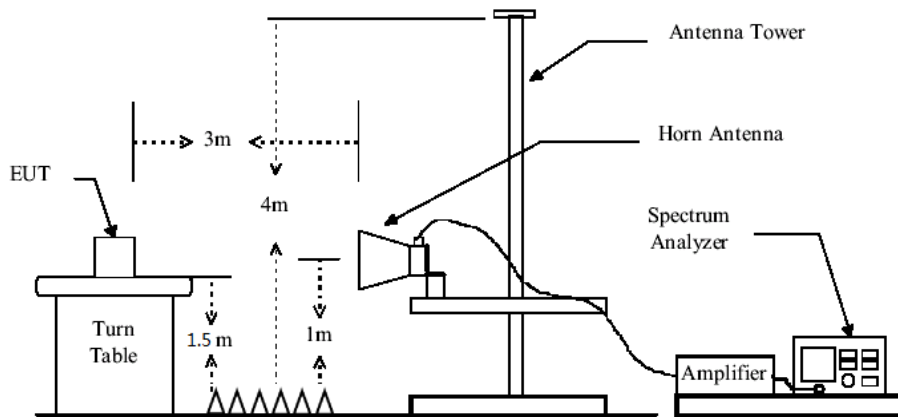

Figure3. Above 1GHz radiated emissions test configuration

- Test Procedure:**
- 1) The procedure used was ANSI Standard C63.10. The receiver was scanned from 9 KHz to 25GHz. When an emission was found, the table was rotated to produce the maximum signal strength. An initial pre-scan was performed for in peak detection mode using the receiver. The EUT was measured for both the Horizontal and Vertical polarities and performed a pre-test three orthogonal planes. For intentional radiators, measurements of the variation of the input power or the radiated signal level of the fundamental frequency component of the emission, as appropriate, shall be performed with the supply voltage varied between 85% and 115% of the nominal rated supply voltage. The worst case emissions were reported.
 - 2) Low noise amplifier was used below 1GHz, High pass Filter was used above 3GHz. We did not use any amplifier or filter between 1G and 3GHz.
 - 3) Test were performed for their spatial orthogonal(X, Y, Z), the worst test data (X orthogonal) was submitted.
 - a) For this intentional radiator operates below 25 GHz. the spectrum shall be investigated to the tenth harmonic of the highest fundamental frequency. And above the third harmonic of this intentional radiator, the disturbance is very low. So the test result only displays to 5rd harmonic.
 - b) As shown in Section, for frequencies above 1000MHz. the above field strength limits are based on average limits. However, the peak field strength of any emission shall not exceed the maximum permitted average limits specified above by more than 20 dB under any condition of modulation.
 - 4) Pretest under all modes below 1GHz; choose the worst case mode (802.11b) record on the report.
 - 5) No spurious emissions were detected within 20dB of limit below 30MHz.

Test Result: Pass

7.8.1 Radiated Spurious Emissions

30MHz-1GHz:

lowest Channel

Item	Freq.	Read Level	Antenna Factor	Preamp Factor	Cable Loss	Result Level	Limit Line	Over Limit	Detector	Polarization
(Mark)	(MHz)	(dB μ V)	(dB/m)	(dB)	(dB)	(dB μ V/m)	(dB μ V/m)	(dB)		
1	143.83	47.15	11.93	23.64	1.14	36.58	43.50	-6.92	QP	Horizontal
2	212.27	47.04	9.07	23.63	1.44	33.92	43.50	-9.58	QP	Horizontal
3	250.30	52.32	10.30	23.65	1.55	40.52	46.00	-5.48	QP	Horizontal
4	275.16	48.71	11.10	23.66	1.73	37.88	46.00	-8.12	QP	Horizontal
5	372.00	44.51	13.99	23.69	2.03	36.84	46.00	-9.16	QP	Horizontal
6	400.43	49.22	14.30	23.70	2.18	42.00	46.00	-4.00	QP	Horizontal
1	30.53	46.33	12.51	23.72	0.11	35.23	40.00	-4.77	QP	Vertical
2	43.66	46.51	13.10	23.70	0.31	36.22	40.00	-3.78	QP	Vertical
3	85.90	49.70	8.56	23.67	0.77	35.36	40.00	-4.64	QP	Vertical
4	250.30	49.98	10.30	23.65	1.55	38.18	46.00	-7.82	QP	Vertical
5	275.16	45.73	11.10	23.66	1.73	34.90	46.00	-11.10	QP	Vertical
6	408.95	41.61	14.62	23.71	2.22	34.74	46.00	-11.26	QP	Vertical

Middle Channel

Item	Freq.	Read Level	Antenna Factor	Preamp Factor	Cable Loss	Result Level	Limit Line	Over Limit	Detector	Polarization
(Mark)	(MHz)	(dB μ V)	(dB/m)	(dB)	(dB)	(dB μ V/m)	(dB μ V/m)	(dB)		
1	111.35	43.07	10.60	23.65	0.98	31.00	43.50	-12.50	QP	Horizontal
2	143.83	47.15	11.93	23.64	1.14	36.58	43.50	-6.92	QP	Horizontal
3	212.27	51.04	9.07	23.63	1.44	37.92	43.50	-5.58	QP	Horizontal
4	275.16	46.71	11.10	23.66	1.73	35.88	46.00	-10.12	QP	Horizontal
5	300.37	43.84	11.77	23.67	1.89	33.83	46.00	-12.17	QP	Horizontal
6	408.95	44.48	14.62	23.71	2.22	37.61	46.00	-8.39	QP	Horizontal
1	85.90	46.70	8.56	23.67	0.77	32.36	40.00	-7.64	QP	Vertical
2	185.79	40.01	11.72	23.62	1.36	29.47	43.50	-14.03	QP	Vertical
3	275.16	43.73	11.10	23.66	1.73	32.90	46.00	-13.10	QP	Vertical
4	300.37	41.56	11.77	23.67	1.89	31.55	46.00	-14.45	QP	Vertical
5	372.00	44.27	13.99	23.69	2.03	36.60	46.00	-9.40	QP	Vertical
6	408.95	43.61	14.62	23.71	2.22	36.74	46.00	-9.26	QP	Vertical



Highest Channel

Item	Freq.	Read Level	Antenna Factor	Preamp Factor	Cable Loss	Result Level	Limit Line	Over Limit	Detector	Polarization
(Mark)	(MHz)	(dB μ V)	(dB/m)	(dB)	(dB)	(dB μ V/m)	(dB μ V/m)	(dB)		
1	143.83	47.10	11.93	23.64	1.14	36.53	43.55	-6.92	QP	Horizontal
2	212.27	46.93	9.07	23.63	1.44	33.81	43.61	-9.58	QP	Horizontal
3	250.30	52.30	10.30	23.65	1.55	40.50	46.00	-5.50	QP	Horizontal
4	275.16	48.76	11.10	23.66	1.73	37.93	46.00	-8.07	QP	Horizontal
5	372.00	44.53	13.99	23.69	2.03	36.82	46.00	-9.18	QP	Horizontal
6	400.43	49.12	14.30	23.70	2.18	42.10	46.00	-3.90	QP	Horizontal
1	30.53	46.35	12.51	23.72	0.11	35.25	40.00	-4.75	QP	Vertical
2	43.66	46.41	13.10	23.70	0.31	36.12	40.00	-3.88	QP	Vertical
3	85.90	49.66	8.56	23.67	0.77	35.32	40.00	-4.68	QP	Vertical
4	250.30	49.95	10.30	23.65	1.55	38.15	46.00	-7.85	QP	Vertical
5	275.16	45.76	11.10	23.66	1.73	34.93	46.00	-11.07	QP	Vertical
6	408.95	41.66	14.62	23.71	2.22	34.79	46.00	-11.21	QP	Vertical

Result Level = Read Level + Antenna Factor + Cable loss - Preamp Factor

Below is the plot of worst case on lowest channel:
Vertical:

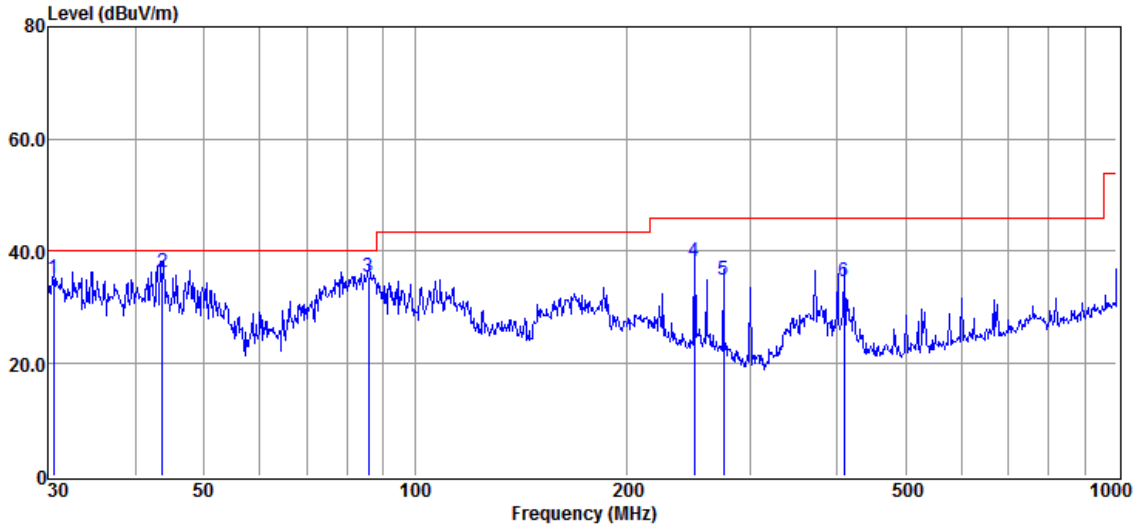

Horizontal:

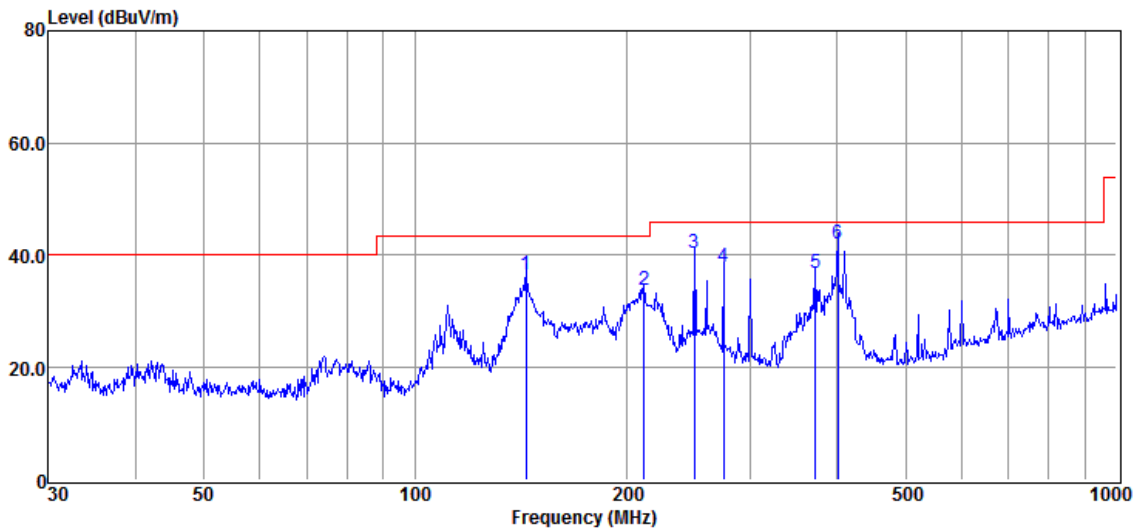

Above 1GHz:

Test mode: 802.11b

Channel: 2412

Mark	Frequency (MHz)	Reading (dBuV)	Factor (dB)	Emission (dBuV/m)	Limit (dBuV/m)	Over Limit (dB)	Detector	Polarization
1	4824	40.49	6.40	46.89	54	-7.11	peak	Horizontal
2	7236	39.13	10.76	49.89	54	-4.11	peak	Horizontal
3	9648	35.77	14.37	50.14	54	-3.86	peak	Horizontal
4	4824	40.40	6.40	46.80	54	-7.20	peak	Vertical
5	7236	39.22	10.76	49.98	54	-4.02	peak	Vertical
6	9648	35.29	14.37	49.66	54	-4.34	peak	Vertical

Test mode: 802.11b

Channel: 2437

Mark	Frequency (MHz)	Reading (dBuV)	Factor (dB)	Emission (dBuV/m)	Limit (dBuV/m)	Over Limit (dB)	Detector	Polarization
1	4874	39.71	6.92	46.63	54	-7.37	peak	Horizontal
2	7311	40.14	11.08	51.22	54	-2.78	peak	Horizontal
3	9748	37.89	14.36	52.25	54	-1.75	peak	Horizontal
4	4874	40.25	6.92	47.17	54	-6.83	peak	Vertical
5	7311	39.35	11.08	50.43	54	-3.57	peak	Vertical
6	9748	36.65	14.36	51.01	54	-2.99	peak	Vertical

Test mode: 802.11b

Channel: 2462

Mark	Frequency (MHz)	Reading (dBuV)	Factor (dB)	Emission (dBuV/m)	Limit (dBuV/m)	Over Limit (dB)	Detector	Polarization
1	4924	42.71	7.31	50.02	54	-3.98	peak	Horizontal
2	7386	38.77	11.41	50.18	54	-3.82	peak	Horizontal
3	9848	37.49	14.38	51.87	54	-2.13	peak	Horizontal
4	4924	41.20	7.31	48.51	54	-5.49	peak	Vertical
5	7386	38.17	11.41	49.58	54	-4.42	peak	Vertical
6	9848	37.15	14.38	51.53	54	-2.47	peak	Vertical

Test mode: 802.11g

Channel: 2412

Mark	Frequency (MHz)	Reading (dBuV)	Factor (dB)	Emission (dBuV/m)	Limit (dBuV/m)	Over Limit (dB)	Detector	Polarization
1	4824	40.57	6.40	46.97	54	-7.03	peak	Horizontal
2	7236	39.13	10.76	49.89	54	-4.11	peak	Horizontal
3	9648	35.66	14.37	50.03	54	-3.97	peak	Horizontal
4	4824	40.09	6.40	46.49	54	-7.51	peak	Vertical
5	7236	39.65	10.76	50.41	54	-3.59	peak	Vertical
6	9648	35.64	14.37	50.01	54	-3.99	peak	Vertical

Test mode: 802.11g

Channel: 2437

Mark	Frequency (MHz)	Reading (dBuV)	Factor (dB)	Emission (dBuV/m)	Limit (dBuV/m)	Over Limit (dB)	Detector	Polarization
1	4874	39.27	6.92	46.19	54	-7.81	peak	Horizontal
2	7311	39.74	11.08	50.82	54	-3.18	peak	Horizontal
3	9748	37.32	14.36	51.68	54	-2.32	peak	Horizontal
4	4874	39.33	6.92	46.25	54	-7.75	peak	Vertical
5	7311	39.78	11.08	50.86	54	-3.14	peak	Vertical
6	9748	37.22	14.36	51.58	54	-2.42	peak	Vertical

Test mode: 802.11g

Channel: 2462

Mark	Frequency (MHz)	Reading (dBuV)	Factor (dB)	Emission (dBuV/m)	Limit (dBuV/m)	Over Limit (dB)	Detector	Polarization
1	4924	39.57	7.31	46.88	54	-7.12	peak	Horizontal
2	7386	37.89	11.41	49.30	54	-4.70	peak	Horizontal
3	9848	37.56	14.38	51.94	54	-2.06	peak	Horizontal
4	4924	39.88	7.31	47.19	54	-6.81	peak	Vertical
5	7386	39.5	11.41	50.91	54	-3.09	peak	Vertical
6	9848	37.61	14.38	51.99	54	-2.01	peak	Vertical

Test mode: 802.11 n(HT20)

Channel: 2412

Mark	Frequency (MHz)	Reading (dBuV)	Factor (dB)	Emission (dBuV/m)	Limit (dBuV/m)	Over Limit (dB)	Detector	Polarization
1	4824	40.41	6.40	46.81	54	-7.19	peak	Horizontal
2	7236	40.14	10.76	50.90	54	-3.10	peak	Horizontal
3	9648	36.27	14.37	50.64	54	-3.36	peak	Horizontal
4	4824	39.98	6.40	46.38	54	-7.62	peak	Vertical
5	7236	39.52	10.76	50.28	54	-3.72	peak	Vertical
6	9648	35.96	14.37	50.33	54	-3.67	peak	Vertical

Test mode: 802.11 n(HT20)

Channel: 2437

Mark	Frequency (MHz)	Reading (dBuV)	Factor (dB)	Emission (dBuV/m)	Limit (dBuV/m)	Over Limit (dB)	Detector	Polarization
1	4874	40.07	6.92	46.99	54	-7.01	peak	Horizontal
2	7311	40.36	11.08	51.44	54	-2.56	peak	Horizontal
3	9748	37.47	14.36	51.83	54	-2.17	peak	Horizontal
4	4874	38.91	6.92	45.83	54	-8.17	peak	Vertical
5	7311	39.50	11.08	50.58	54	-3.42	peak	Vertical
6	9748	36.37	14.36	50.73	54	-3.27	peak	Vertical

Test mode: 802.11 n(HT20)

Channel: 2462

Mark	Frequency (MHz)	Reading (dBuV)	Factor (dB)	Emission (dBuV/m)	Limit (dBuV/m)	Over Limit (dB)	Detector	Polarization
1	4924	40.49	7.31	47.80	54	-6.20	peak	Horizontal
2	7386	38.82	11.41	50.23	54	-3.77	peak	Horizontal
3	9848	37.35	14.38	51.73	54	-2.27	peak	Horizontal
4	4924	40.68	7.31	47.99	54	-6.01	peak	Vertical
5	7386	39.29	11.41	50.70	54	-3.30	peak	Vertical
6	9848	37.50	14.38	51.88	54	-2.12	peak	Vertical

Test mode: 802.11 n(HT40)

Channel: 2422

Mark	Frequency (MHz)	Reading (dBuV)	Factor (dB)	Emission (dBuV/m)	Limit (dBuV/m)	Over Limit (dB)	Detector	Polarization
1	4844	39.53	6.60	46.13	54	-7.87	peak	Horizontal
2	7266	37.75	10.89	48.64	54	-5.36	peak	Horizontal
3	9688	36.53	14.35	50.88	54	-3.12	peak	Horizontal
4	4844	40.24	6.60	46.84	54	-7.16	peak	Vertical
5	7266	37.99	10.89	48.88	54	-5.12	peak	Vertical
6	9688	36.20	14.35	50.55	54	-3.45	peak	Vertical

Test mode: 802.11 n(HT40)

Channel: 2437

Mark	Frequency (MHz)	Reading (dBuV)	Factor (dB)	Emission (dBuV/m)	Limit (dBuV/m)	Over Limit (dB)	Detector	Polarization
1	4874	39.75	6.92	46.67	54	-7.33	peak	Horizontal
2	7311	39.52	11.08	50.60	54	-3.40	peak	Horizontal
3	9748	36.54	14.36	50.90	54	-3.10	peak	Horizontal
4	4874	38.85	6.92	45.77	54	-8.23	peak	Vertical
5	7311	40.24	11.08	51.32	54	-2.68	peak	Vertical
6	9748	36.75	14.36	51.11	54	-2.89	peak	Vertical

Test mode: 802.11 n(HT40)

Channel: 2452

Mark	Frequency (MHz)	Reading (dBuV)	Factor (dB)	Emission (dBuV/m)	Limit (dBuV/m)	Over Limit (dB)	Detector	Polarization
1	4904	39.34	7.22	46.56	54	-7.44	peak	Horizontal
2	7356	40.52	11.28	51.80	54	-2.20	peak	Horizontal
3	9808	38.07	14.37	52.44	54	-1.56	peak	Horizontal
4	4904	40.01	7.22	47.23	54	-6.77	peak	Vertical
5	7356	38.75	11.28	50.03	54	-3.97	peak	Vertical
6	9808	38.63	14.37	53.00	54	-1.00	peak	Vertical

Remark: 1) Emission = Receiver Reading + Factor

2) Factor = Antenna Factor + Cable Loss + Pre-amplifier Factor.

3) If the Peak value below the AV Limit, the AV test doesn't perform for this submission.

7.8.2 Radiated Band edge

Test Mode: 802.11b

Channel: 2412

MK.	Frequency (MHz)	Reading (dBuV/m)	Corrected factor(dB)	Result (dBuV/m)	Limit (dBuV/m)	Over Limit (dB)	Detector	Polarization
1	2390	52.65	-3.89	48.76	74	-25.24	Peak	Horizontal
2	2411.76	104.45	-3.93	100.52	74	26.52	Peak	Horizontal
1	2390	38.10	-3.89	34.21	54	-19.79	Average	Horizontal
2	2410.92	95.54	-3.92	91.62	54	37.62	Average	Horizontal

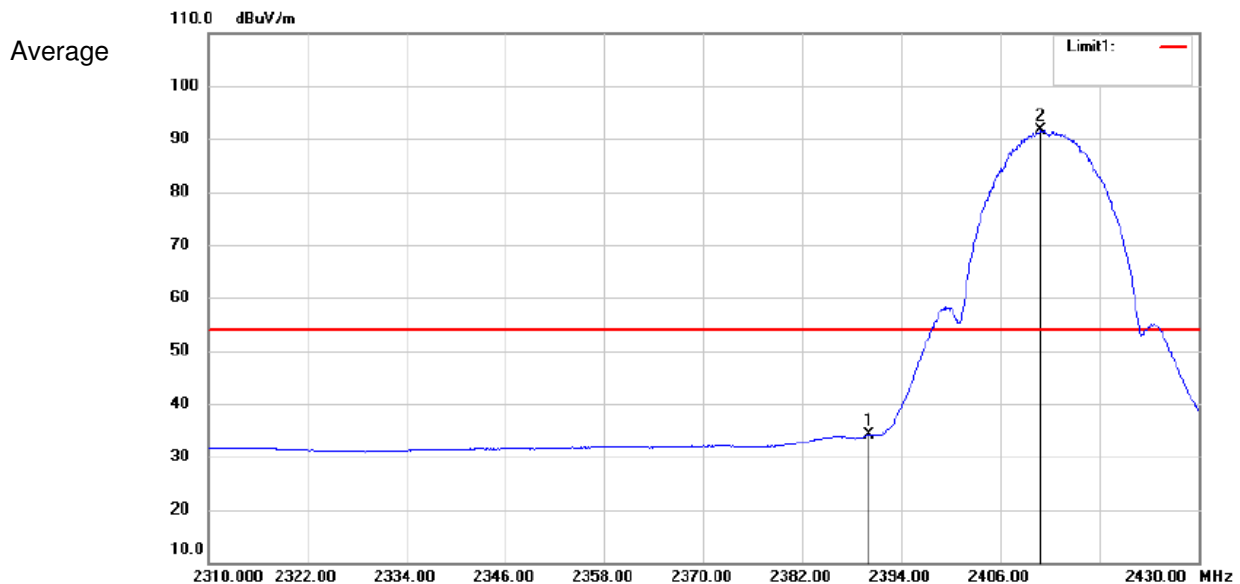
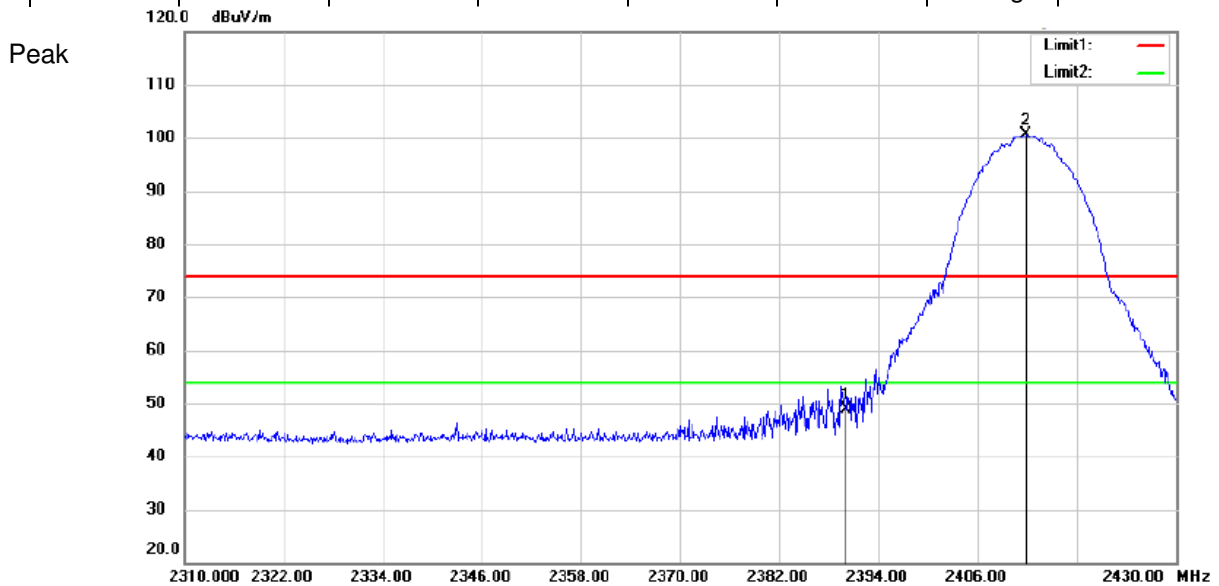



Test Mode: 802.11b

Channel: 2412

MK.	Frequency (MHz)	Reading (dBuV/m)	Corrected factor(dB)	Result (dBuV/m)	Limit (dBuV/m)	Over Limit (dB)	Detector	Polarization
1	2390	59.80	-3.89	55.91	74	-18.09	Peak	Vertical
2	2410.68	108.79	-3.93	104.86	74	30.86	Peak	Vertical
1	2390	40.77	-3.89	36.88	54	-17.12	Average	Vertical
2	2411.04	99.97	-3.93	96.04	54	42.04	Average	Vertical

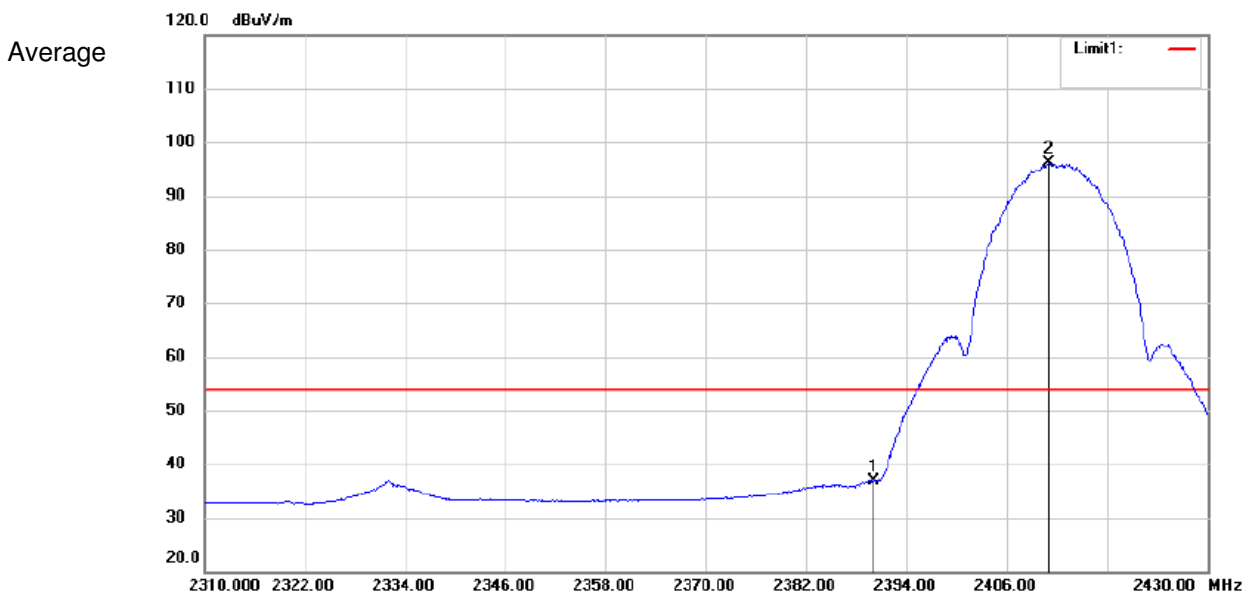
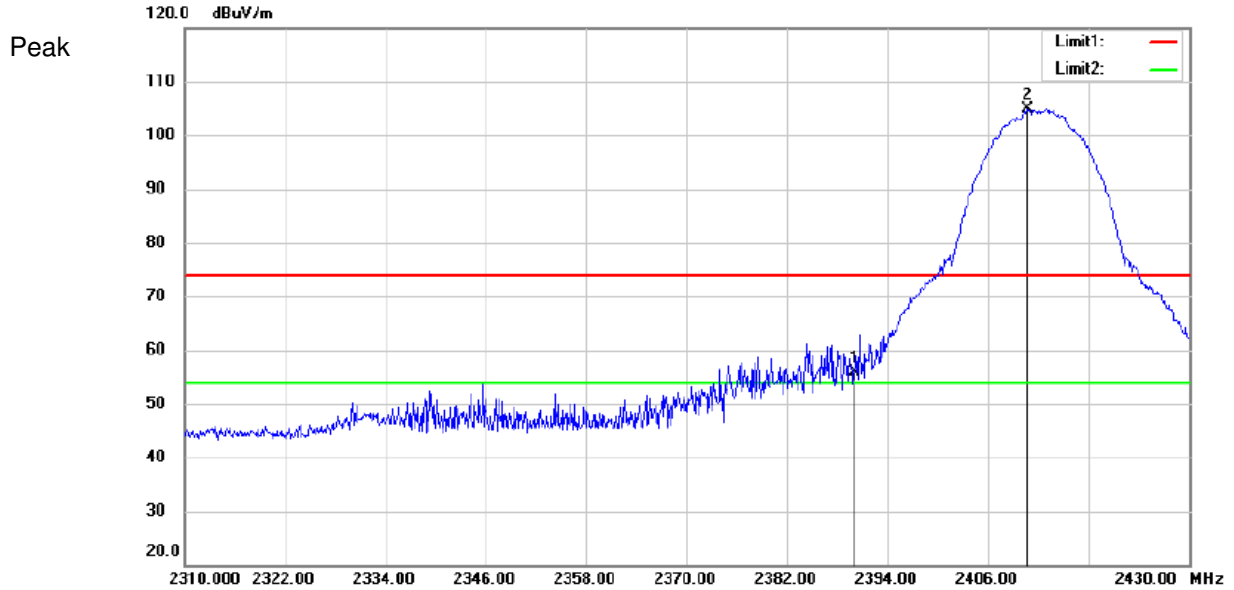

Test Mode: 802.11b

Channel: 2462

MK.	Frequency (MHz)	Reading (dBuV/m)	Corrected factor(dB)	Result (dBuV/m)	Limit (dBuV/m)	Over Limit (dB)	Detector	Polarization
1	2463	101.99	-3.99	98.00	54	44.00	Peak	Horizontal
2	2483.5	47.49	-4.01	43.48	54	-10.52	Peak	Horizontal
3	2500	46.96	-4.03	42.93	54	-11.07	Peak	Horizontal
1	2462.5	106.69	-3.99	102.70	54	48.70	Peak	Vertical
2	2483.5	50.93	-4.01	46.92	54	-7.08	Peak	Vertical
3	2500	48.41	-4.03	44.38	54	-9.62	Peak	Vertical

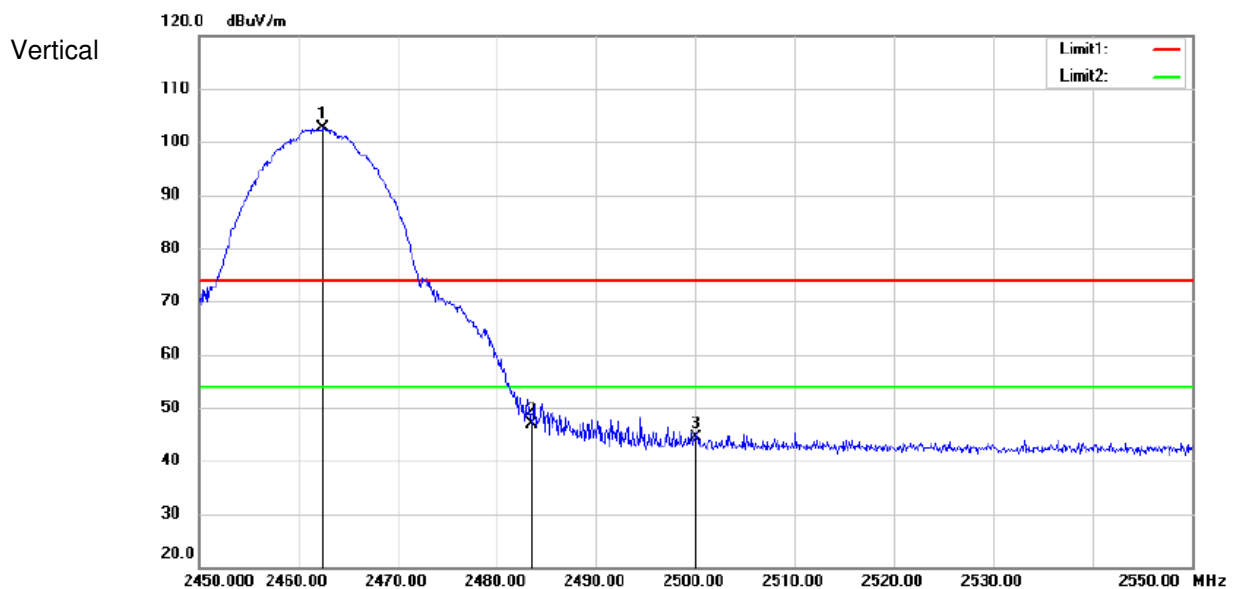
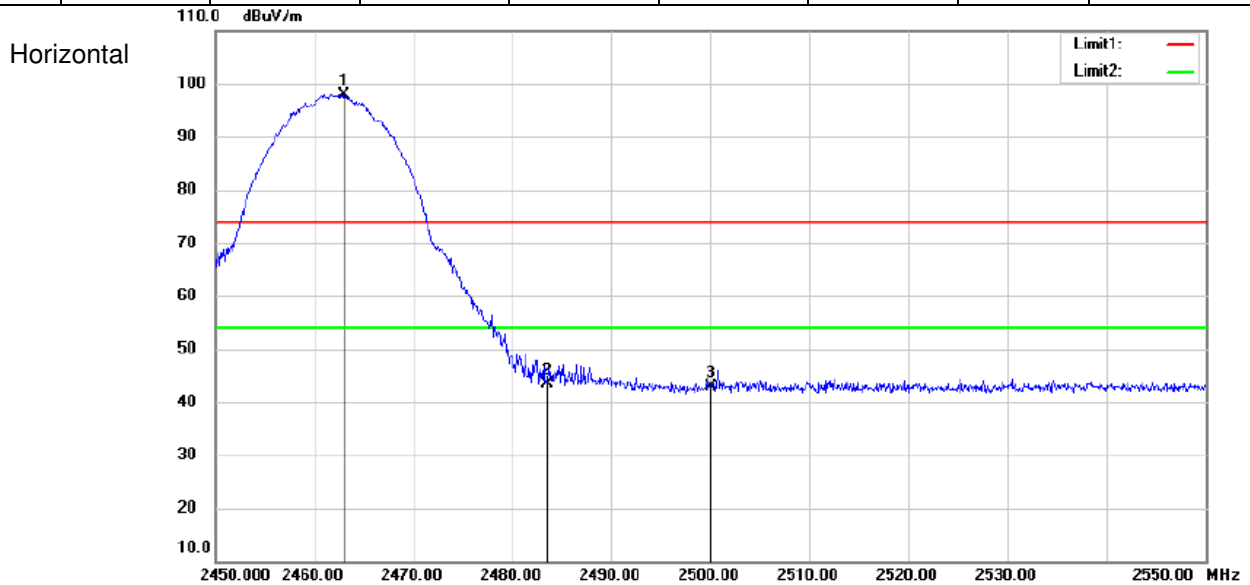

Test Mode: 802.11g

Channel: 2412

MK.	Frequency (MHz)	Reading (dBuV/m)	Corrected factor(dB)	Result (dBuV/m)	Limit (dBuV/m)	Over Limit (dB)	Detector	Polarization
1	2390	62.42	-3.89	58.53	74	-15.47	Peak	Horizontal
2	2406	101.93	-3.92	98.01	74	24.01	Peak	Horizontal
1	2390	38.64	-3.89	34.75	54	-19.25	Average	Horizontal
2	2407.8	88.18	-3.93	84.25	54	30.25	Average	Horizontal

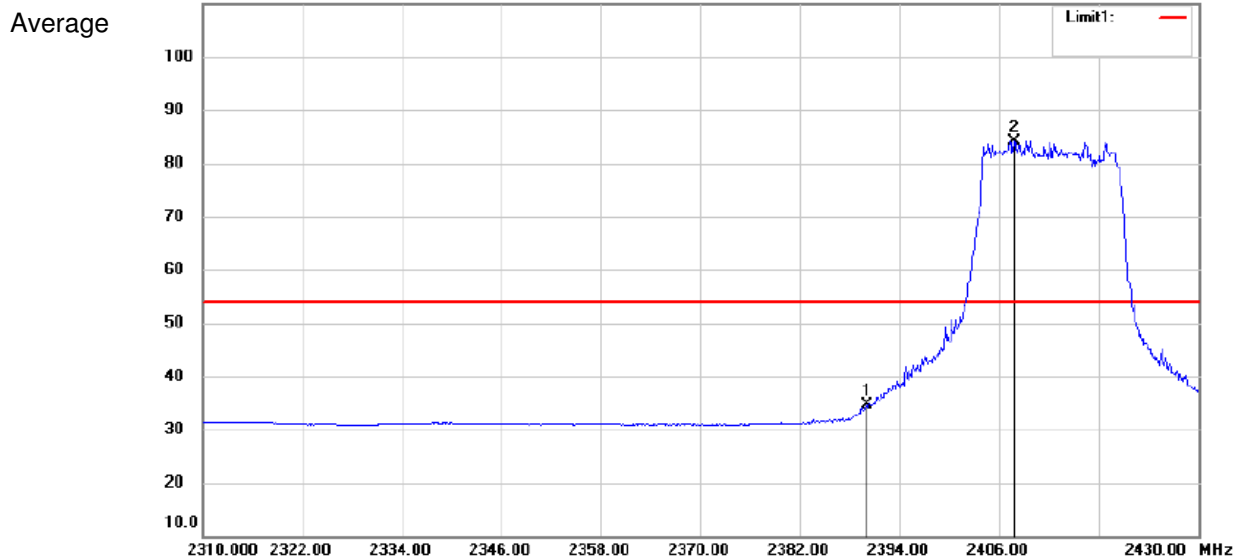
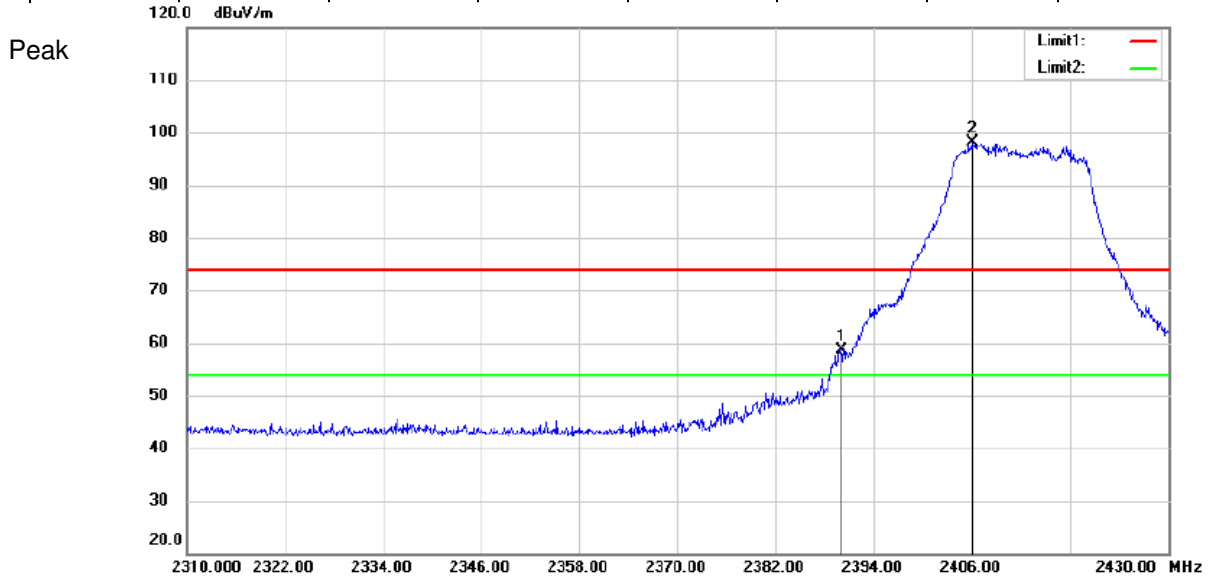



Test Mode: 802.11g

Channel: 2412

MK.	Frequency (MHz)	Reading (dBuV/m)	Corrected factor (dB)	Result (dBuV/m)	Limit (dBuV/m)	Over Limit (dB)	Detector	Polarization
1	2390	71.88	-3.89	67.99	74	-6.01	Peak	Vertical
2	2417.52	105.13	-3.94	101.19	74	27.19	Peak	Vertical
1	2390	46.11	-3.89	42.22	54	-11.78	Average	Vertical
2	2406.72	92.12	-3.93	88.19	54	34.19	Average	Vertical

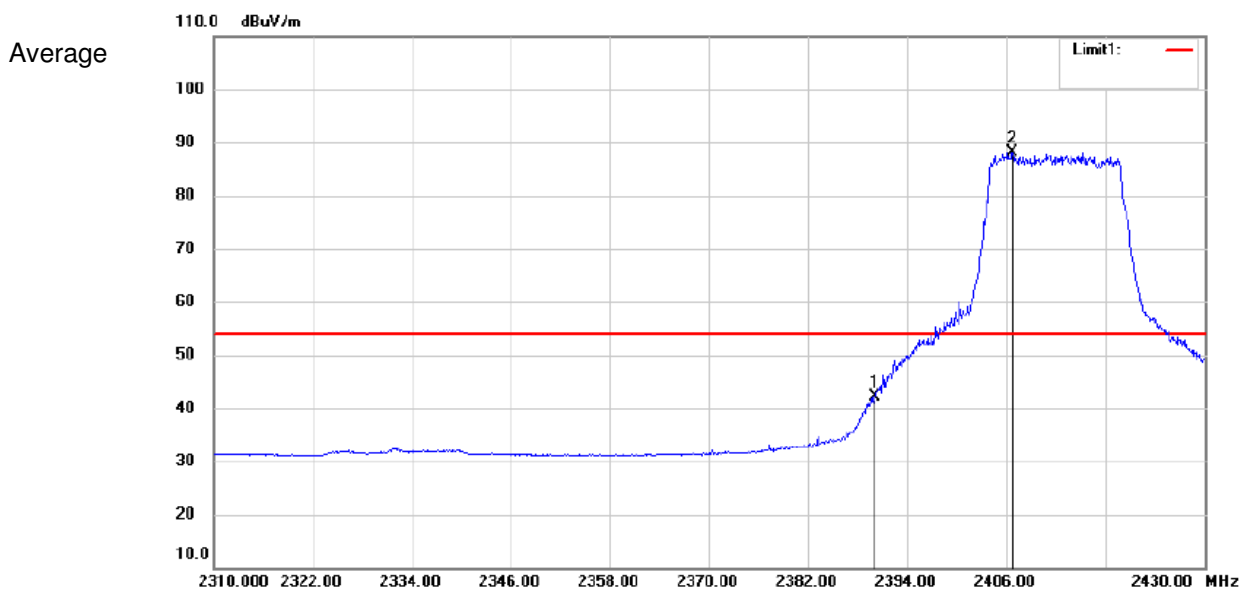
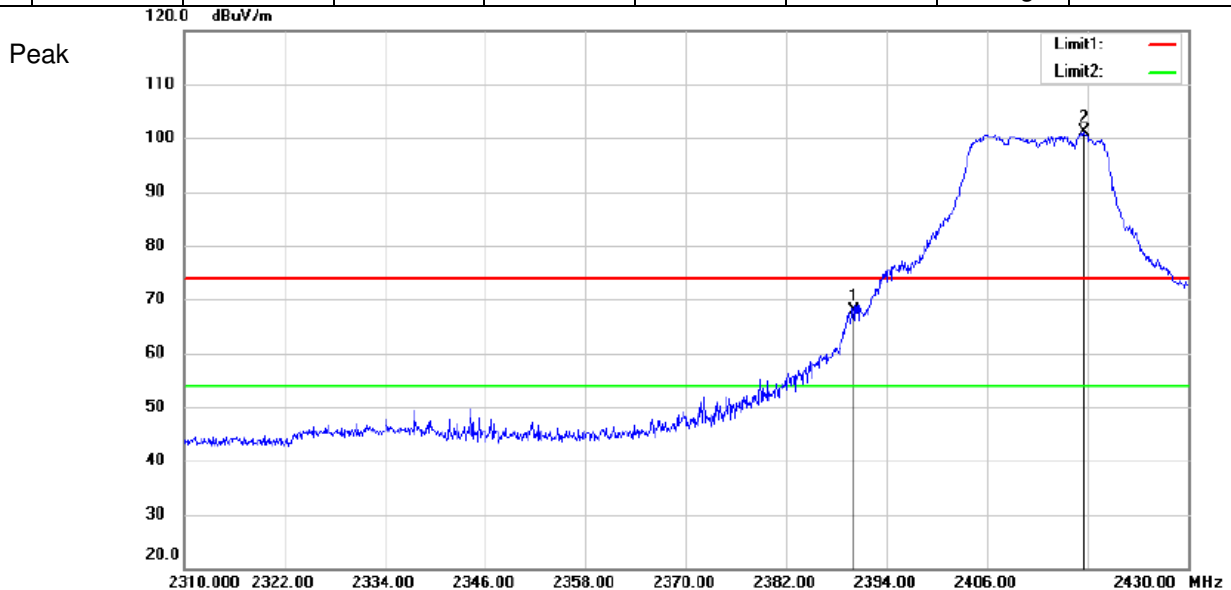

Test Mode: 802.11g

Channel: 2462

MK.	Frequency (MHz)	Reading (dBuV/m)	Corrected factor (dB)	Result (dBuV/m)	Limit (dBuV/m)	Over Limit (dB)	Detector	Polarization
1	2467.5	98.06	-4.00	94.06	54	40.06	Peak	Horizontal
2	2483.5	53.96	-4.01	49.95	54	-4.05	Peak	Horizontal
3	2500	46.69	-4.03	42.66	54	-11.34	Peak	Horizontal

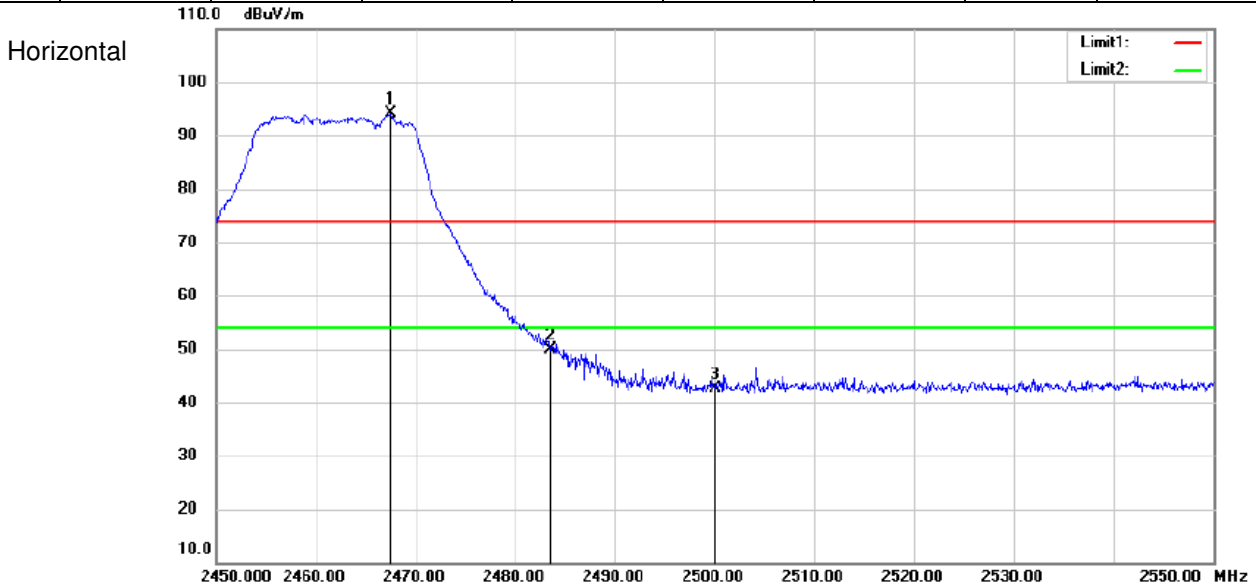

Test Mode: 802.11g

Channel: 2462

MK.	Frequency (MHz)	Reading (dBuV/m)	Corrected factor(dB)	Result (dBuV/m)	Limit (dBuV/m)	Over Limit (dB)	Detector	Polarization
1	2467.3	103.96	-4.00	99.96	74	25.96	Peak	Vertical
2	2483.5	68.04	-4.01	64.03	74	-9.97	Peak	Vertical
3	2500	48.69	-4.03	44.66	74	-29.34	Peak	Vertical
1	2463.4	94.72	-3.98	90.74	54	36.74	Average	Vertical
2	2483.5	42.72	-4.01	38.71	54	-15.29	Average	Vertical
3	2500	34.96	-4.03	30.93	54	-23.07	Average	Vertical

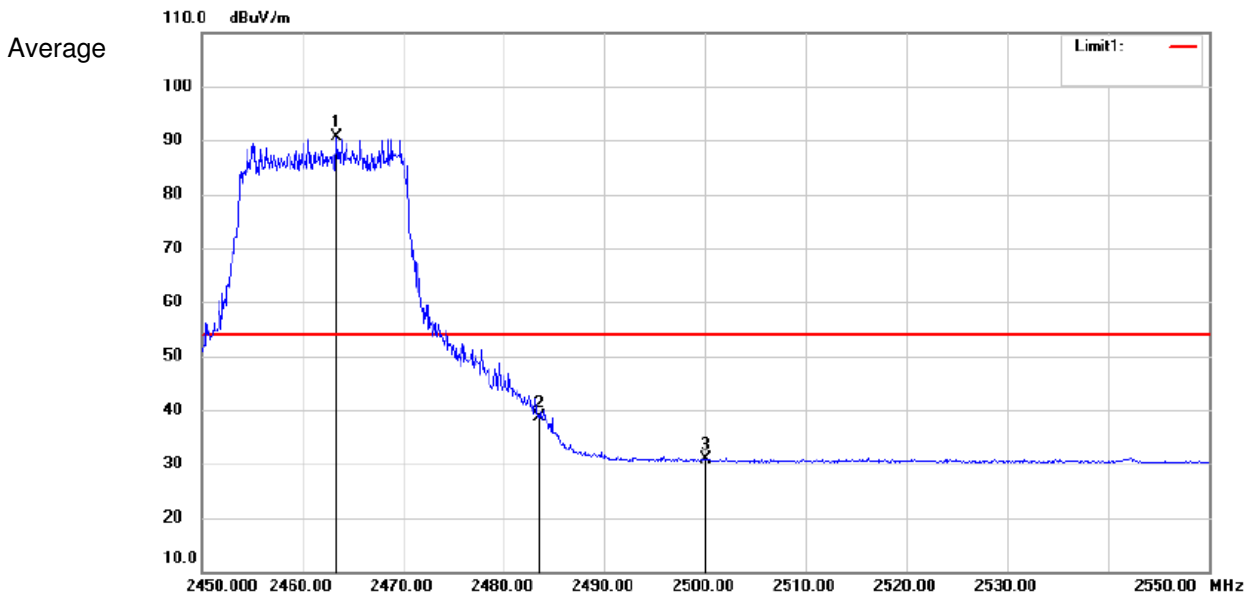
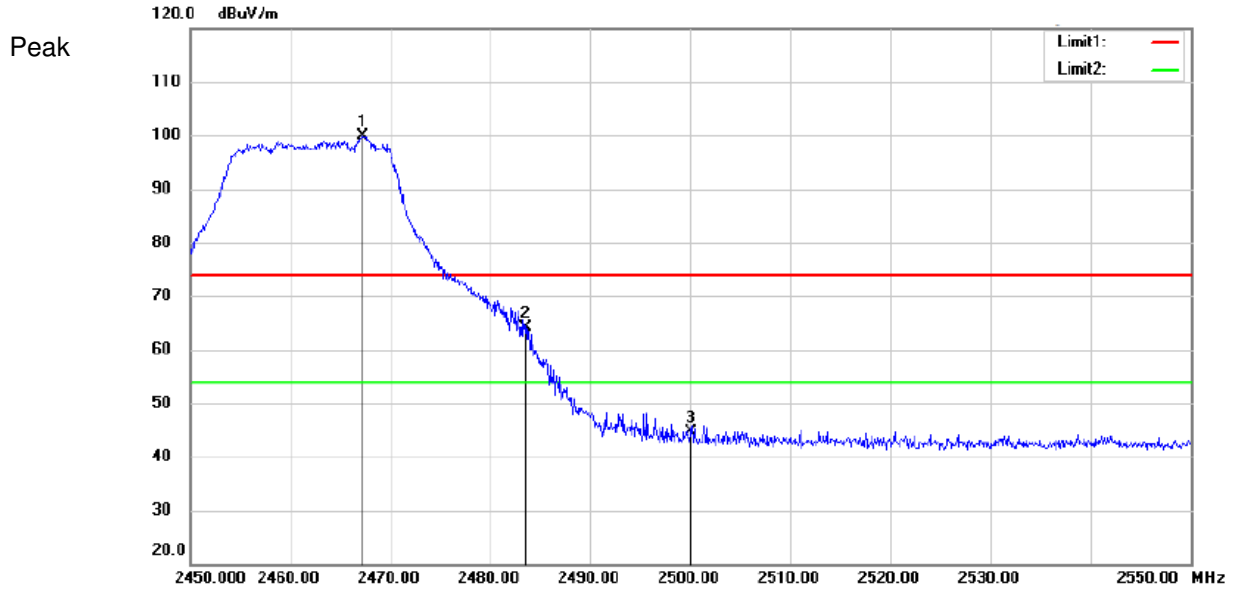



Test Mode: 802.11 n(HT20)

Channel: 2412

MK.	Frequency (MHz)	Reading (dBuV/m)	Corrected factor(dB)	Result (dBuV/m)	Limit (dBuV/m)	Over Limit (dB)	Detector	Polarization
1	2390	62.62	-3.89	58.73	74	-15.27	Peak	Horizontal
2	2405.04	98.20	-3.92	94.28	74	20.28	Peak	Horizontal
1	2390	36.51	-3.89	32.62	54	-21.38	Average	Horizontal
2	2416.8	85.39	-3.94	81.45	54	27.45	Average	Horizontal

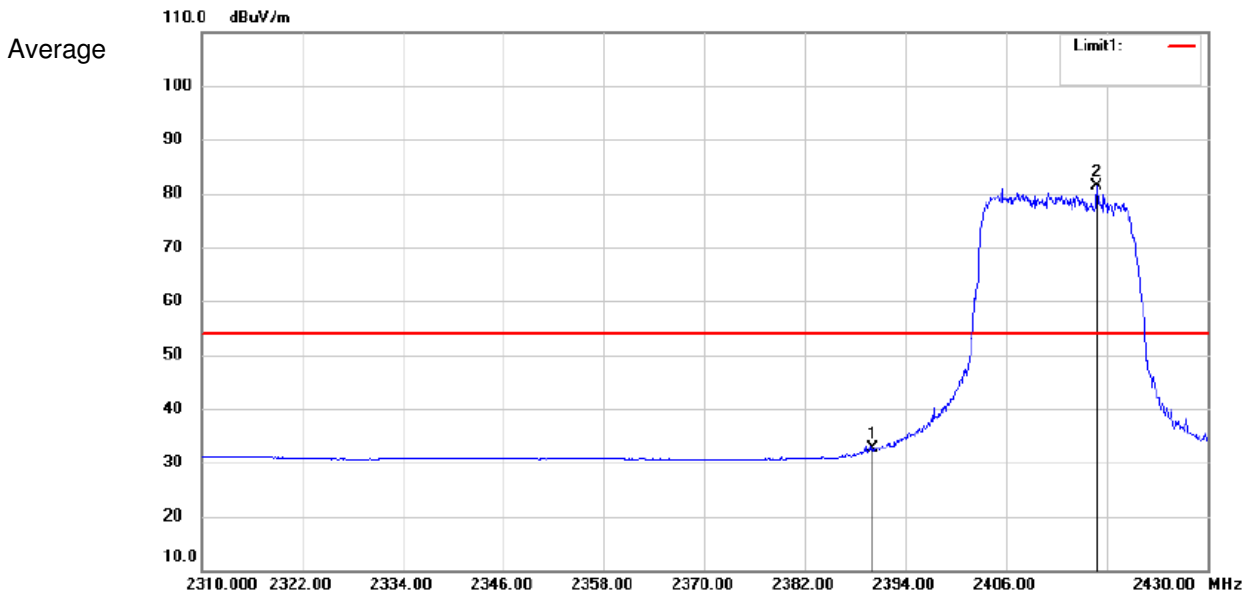
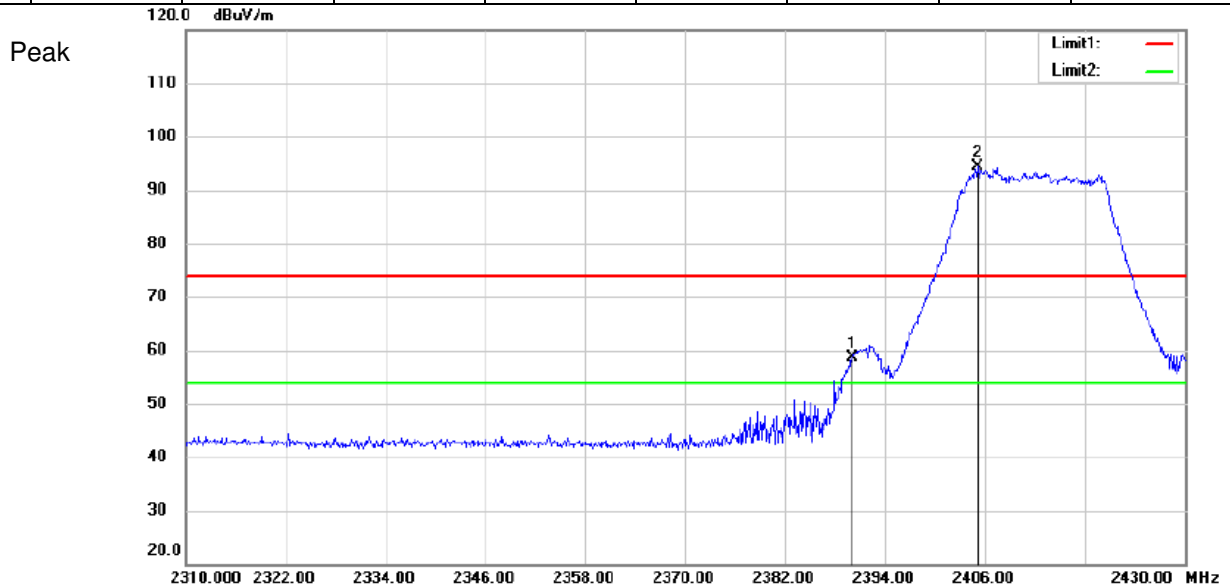



Test Mode: 802.11 n(HT20)

Channel: 2412

MK.	Frequency (MHz)	Reading (dBUV/m)	Corrected factor(dB)	Result (dBUV/m)	Limit (dBUV/m)	Over Limit (dB)	Detector	Polarization
1	2390	72.07	-3.89	68.18	74	-5.82	Peak	Vertical
2	2407.44	102.55	-3.92	98.63	74	24.63	Peak	Vertical
1	2390	41.27	-3.89	37.38	54	-16.62	Average	Vertical
2	2418	91.34	-3.94	87.40	54	33.40	Average	Vertical

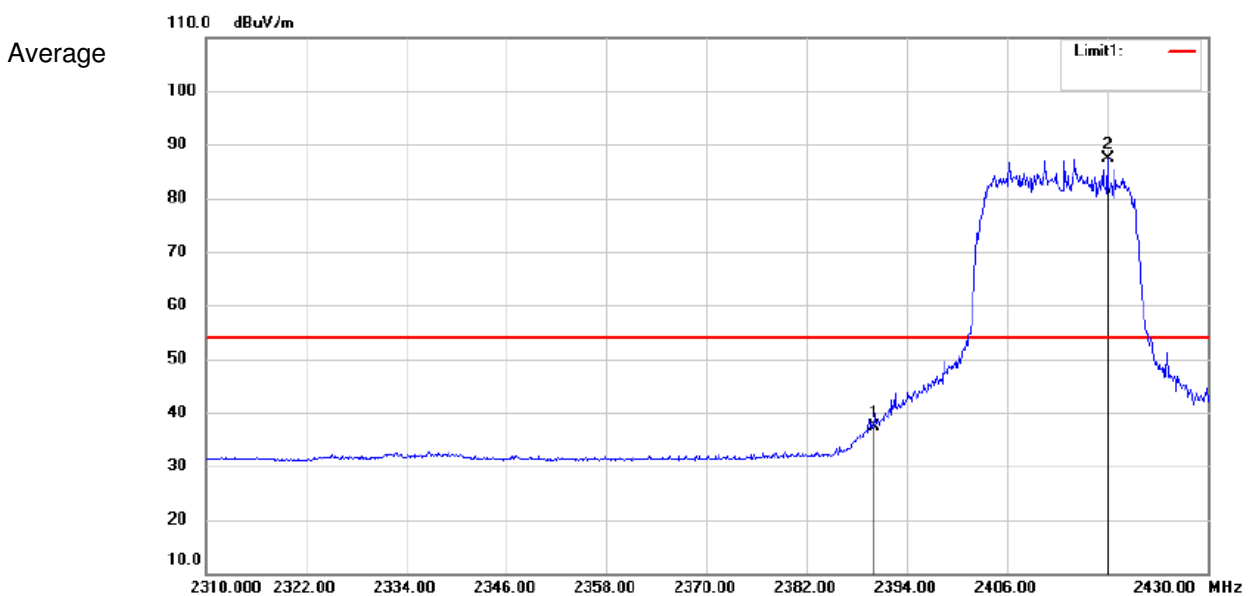
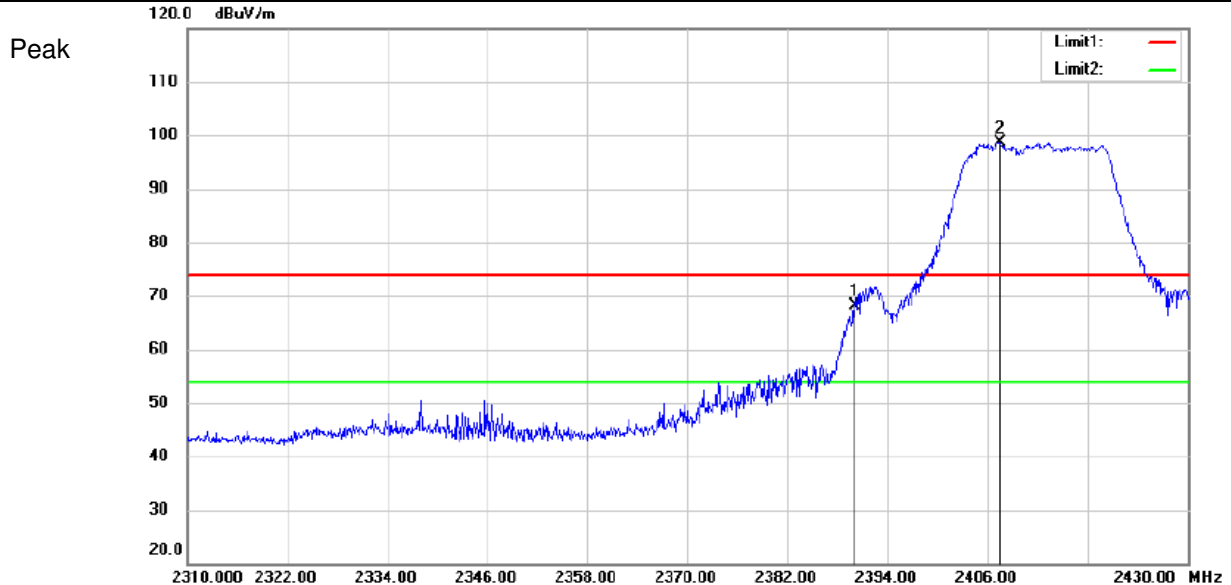



Test Mode: 802.11 n(HT20)

Channel: 2462

MK.	Frequency (MHz)	Reading (dBuV/m)	Corrected factor(dB)	Result (dBuV/m)	Limit (dBuV/m)	Over Limit (dB)	Detector	Polarization
1	2461.9	96.36	-3.99	92.37	74	18.37	Peak	Horizontal
2	2483.5	60.50	-4.01	56.49	74	-17.51	Peak	Horizontal
3	2500	47.28	-4.03	43.25	74	-30.75	Peak	Horizontal
1	2456.1	87.54	-3.98	83.56	54	29.56	Average	Horizontal
2	2483.5	36.11	-4.01	32.10	54	-21.90	Average	Horizontal
3	2500	34.39	-4.03	30.36	54	-23.64	Average	Horizontal

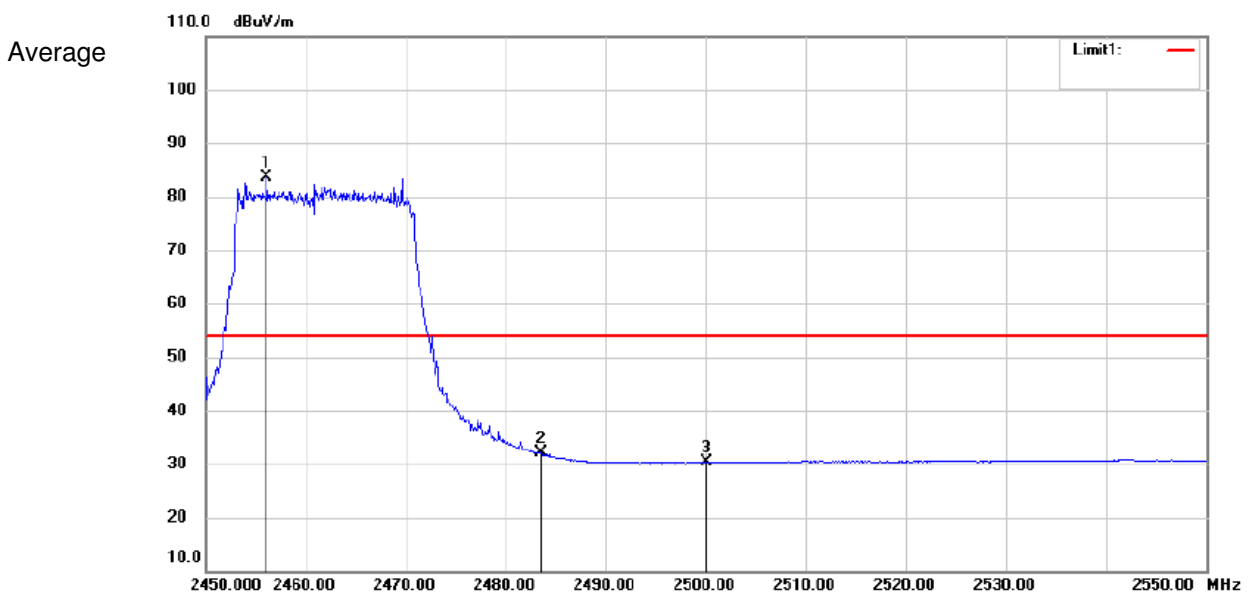
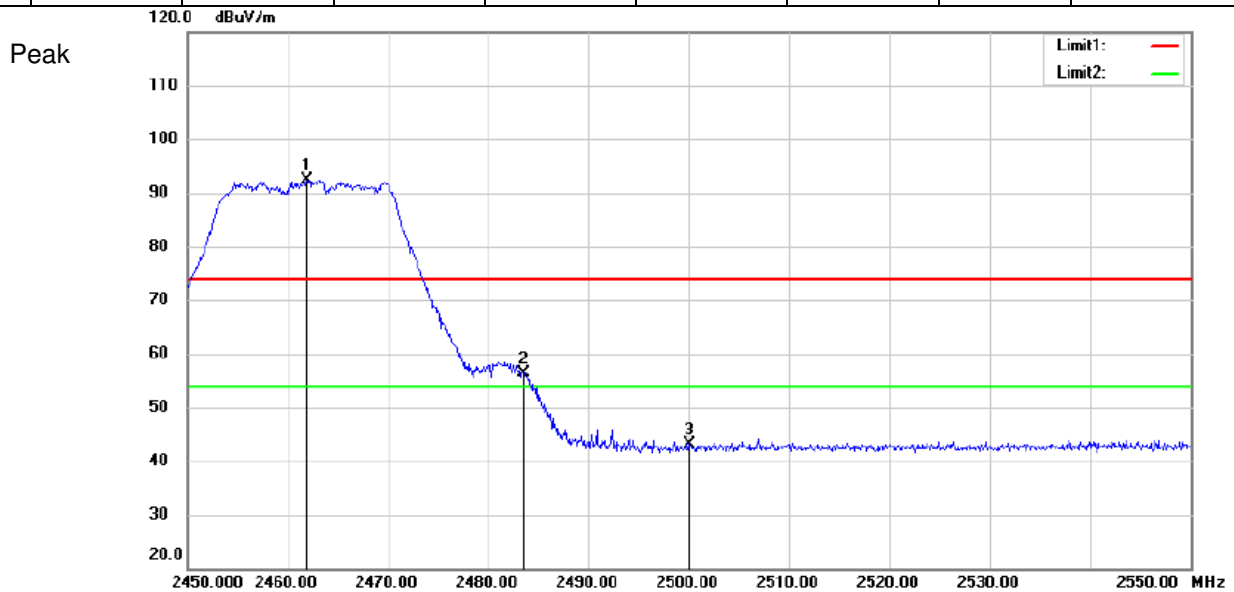

Test Mode: 802.11 n(HT20)

Channel: 2462

MK.	Frequency (MHz)	Reading (dBuV/m)	Corrected factor(dB)	Result (dBuV/m)	Limit (dBuV/m)	Over Limit (dB)	Detector	Polarization
1	2462	102.98	-3.99	98.99	74	24.99	Peak	Vertical
2	2483.5	72.54	-4.01	68.53	74	-5.47	Peak	Vertical
3	2500	48.45	-4.03	44.42	74	-29.58	Peak	Vertical
1	2464.6	94.74	-3.99	90.75	54	36.75	Average	Vertical
2	2483.5	46.46	-4.01	42.45	54	-11.55	Average	Vertical
3	2500	35.55	-4.03	31.52	54	-22.48	Average	Vertical

Peak

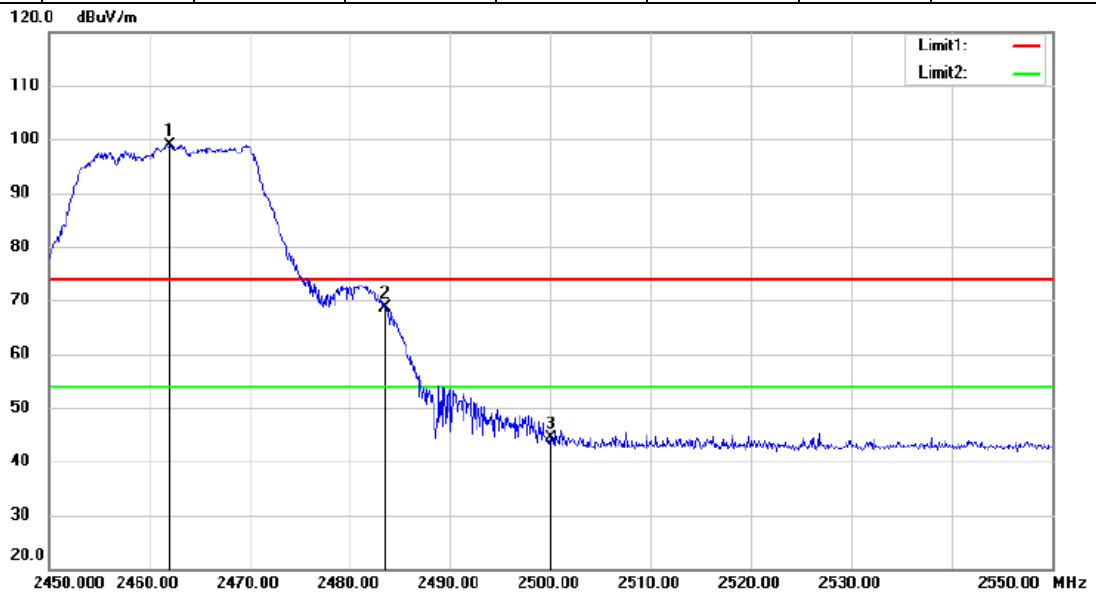

Average

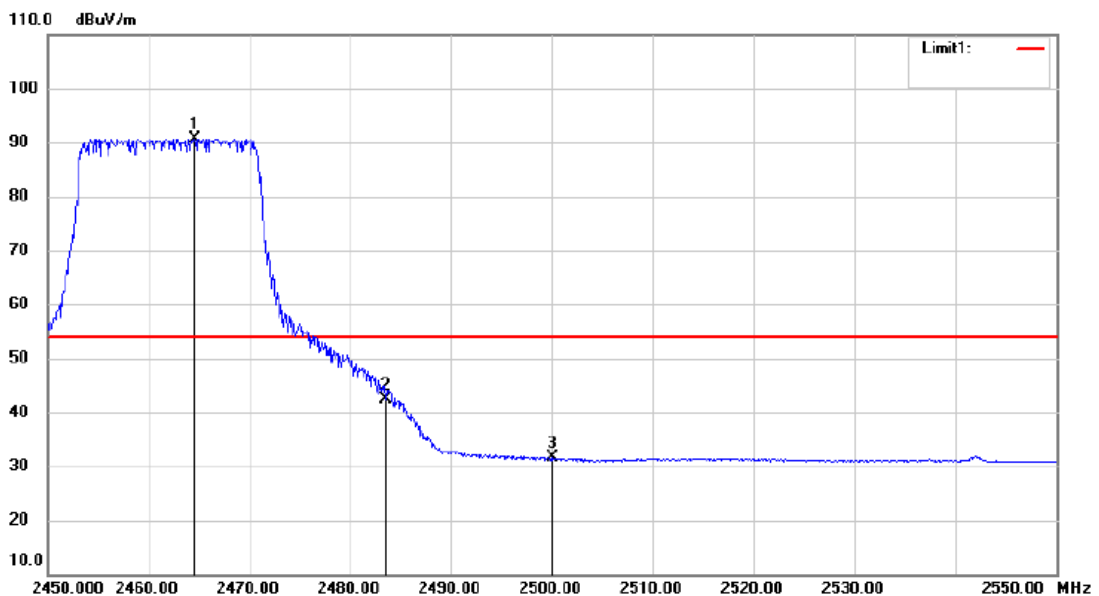

Test Mode: 802.11 n(HT40)

Channel: 2422

MK.	Frequency (MHz)	Reading (dBuV/m)	Corrected factor(dB)	Result (dBuV/m)	Limit (dBuV/m)	Over Limit (dB)	Detector	Polarization
1	2390	51.90	-3.89	48.01	54	-5.99	Peak	Horizontal
2	2413.46	93.22	-3.93	89.29	54	35.29	Peak	Horizontal

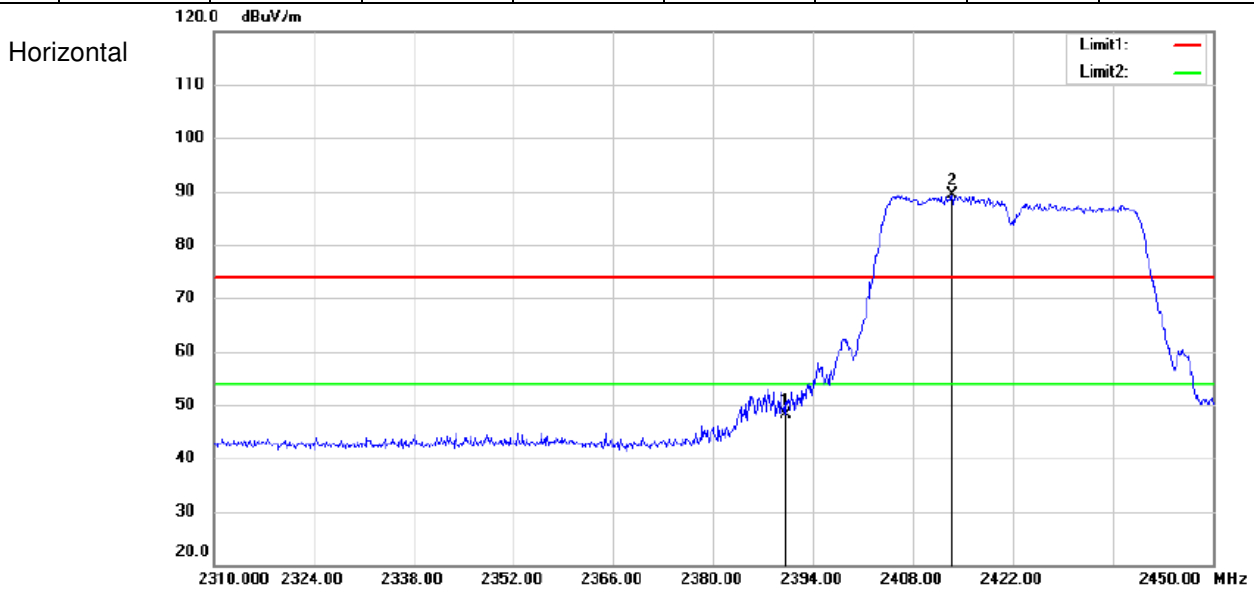



Test Mode: 802.11 n(HT40)

Channel: 2422

MK.	Frequency (MHz)	Reading (dBuV/m)	Corrected factor(dB)	Result (dBuV/m)	Limit (dBuV/m)	Over Limit (dB)	Detector	Polarization
1	2390	66.62	-3.89	62.73	74	-11.27	Peak	Vertical
2	2413.6	99.89	-3.93	95.96	74	21.96	Peak	Vertical
1	2390	48.57	-3.89	44.68	54	-9.32	Average	Vertical
2	2405.9	90.37	-3.93	86.44	54	32.44	Average	Vertical

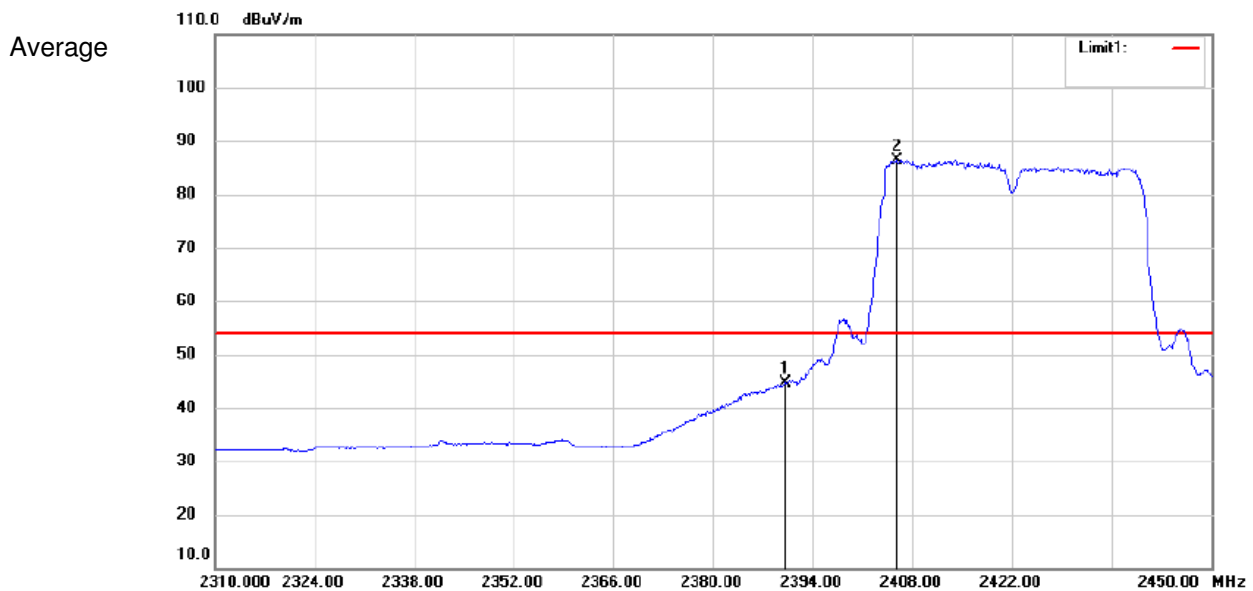
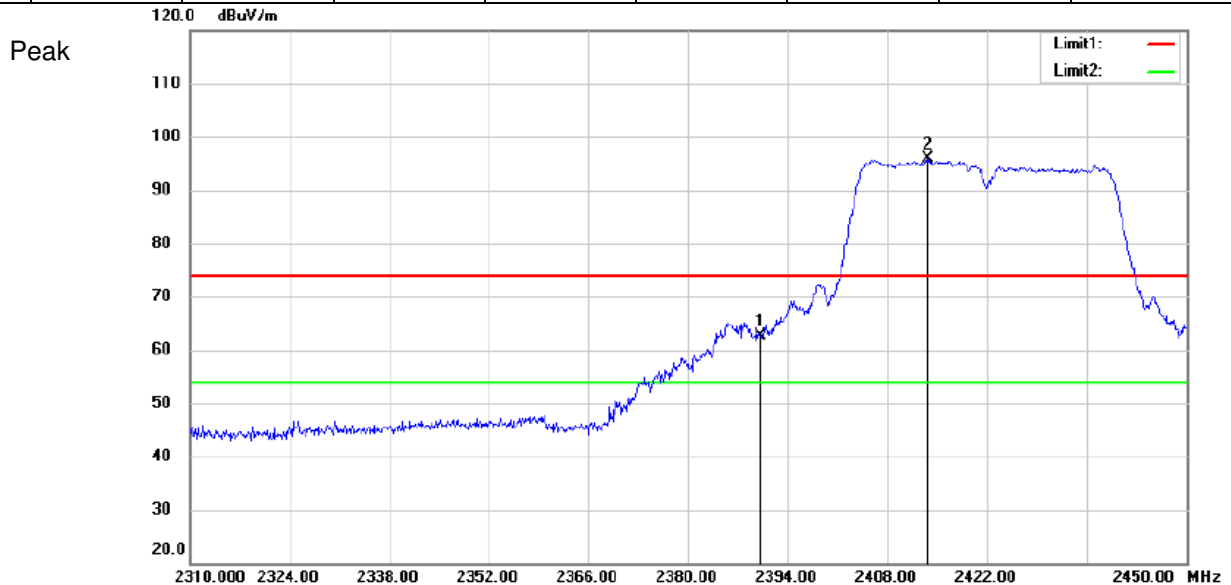



Test Mode: 802.11 n(HT40)

Channel: 2452

MK.	Frequency (MHz)	Reading (dBuV/m)	Corrected factor(dB)	Result (dBuV/m)	Limit (dBuV/m)	Over Limit (dB)	Detector	Polarization
1	2457	91.98	-3.98	88.00	54	34.00	Peak	Horizontal
2	2483.5	50.90	-4.01	46.89	54	-7.11	Peak	Horizontal
3	2500	48.00	-4.03	43.97	54	-10.03	Peak	Horizontal

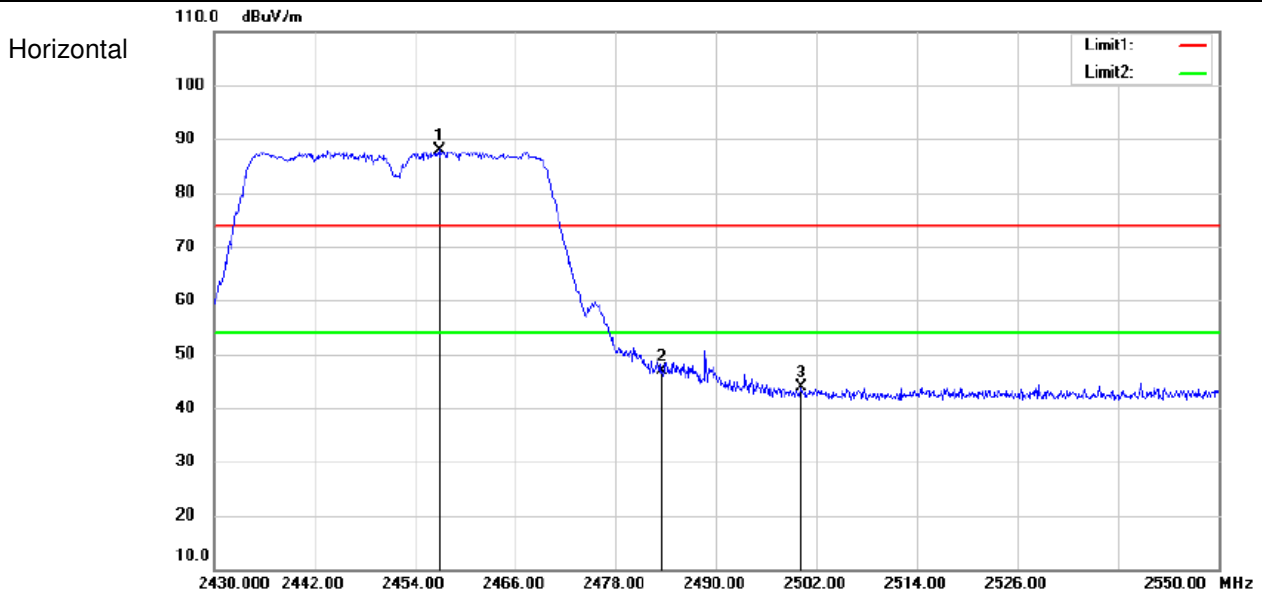

Test Mode: 802.11 n(HT40)

Channel: 2452

MK.	Frequency (MHz)	Reading (dBuV/m)	Corrected factor(dB)	Result (dBuV/m)	Limit (dBuV/m)	Over Limit (dB)	Detector	Polarization
1	2467.2	98.43	-4.00	94.43	74	20.43	Peak	Vertical
2	2483.5	64.33	-4.01	60.32	74	-13.68	Peak	Vertical
3	2500	54.12	-4.03	50.09	74	-23.91	Peak	Vertical
1	2466.72	89.16	-3.99	85.17	54	31.17	Average	Vertical
2	2483.5	47.12	-4.01	43.11	54	-10.89	Average	Vertical
3	2500	37.87	-4.03	33.84	54	-20.16	Average	Vertical

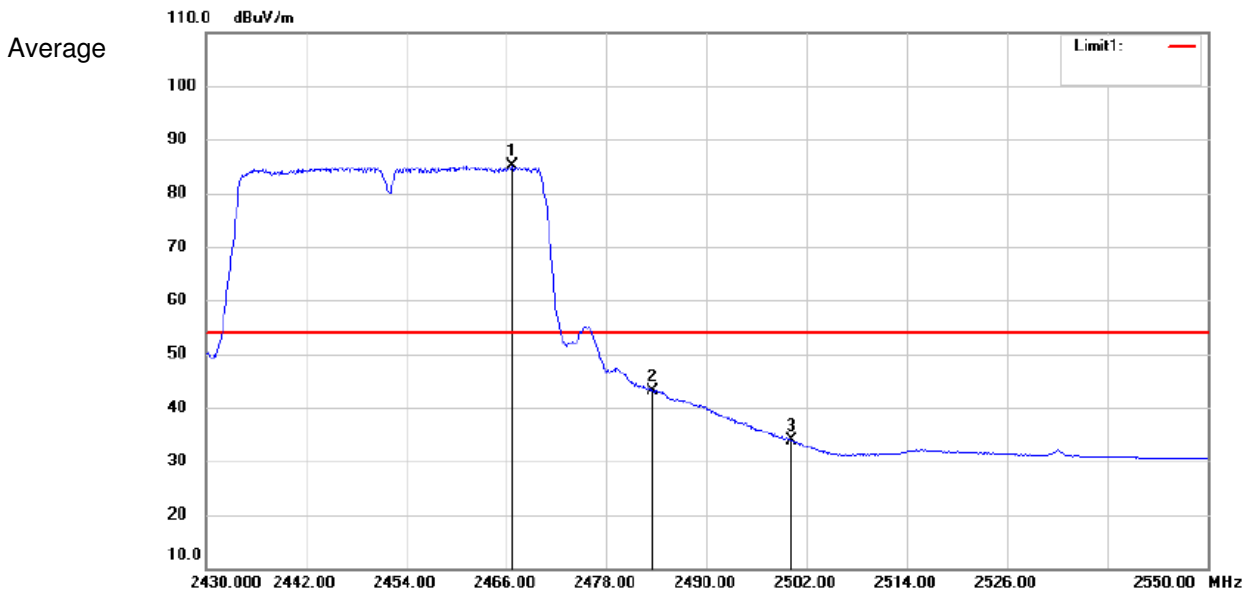
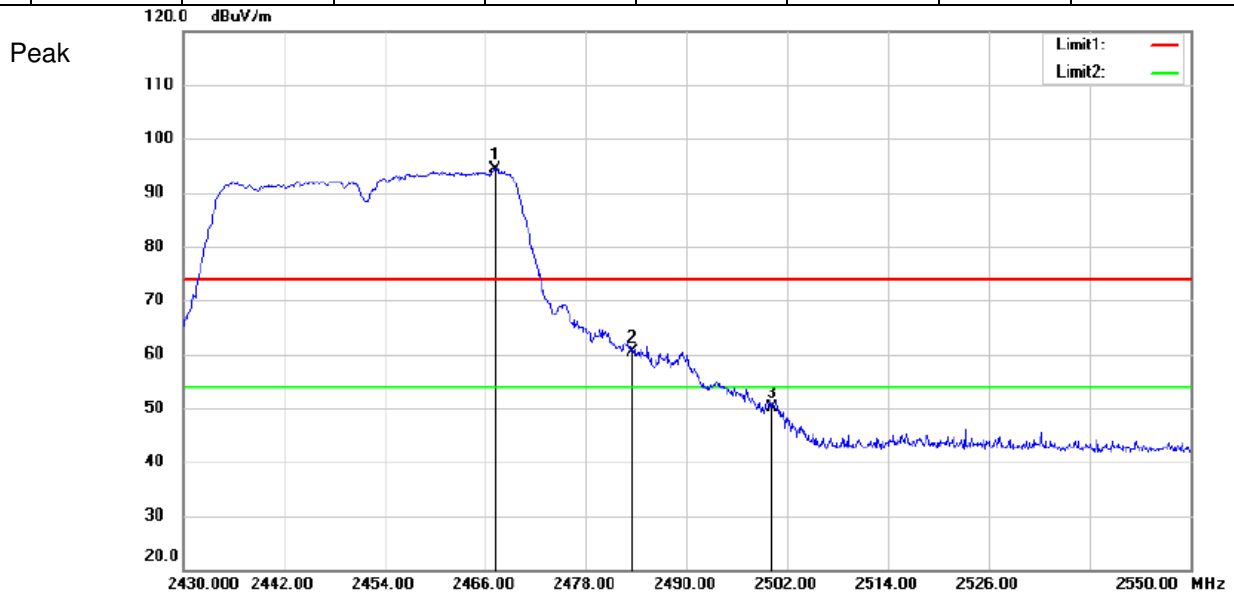



Remark: 1). Test Level = Receiver Reading + Antenna Factor + Cable Loss- Preamplifier Factor
2). If the Peak value below the AV Limit, the AV test doesn't perform for this submission.

All frequencies within the "Restricted bands" have been evaluated to compliance. Except as shown in paragraph of this section, only spurious emissions are permitted in any of the frequency bands listed below:

a. FCC Part 15, Subpart C Section 15.205 Restricted bands of operation.

MHz	MHz	MHz	GHz
0.090 - 0.110	16.42 - 16.423	399.9 - 410	4.5 - 5.15
¹ 0.495 - 0.505	16.69475 - 16.69525	608 - 614	5.35 - 5.46
2.1735 - 2.1905	16.80425 - 16.80475	960 - 1240	7.25 - 7.75
4.125 - 4.128	25.5 - 25.67	1300 - 1427	8.025 - 8.5
4.17725 - 4.17775	37.5 - 38.25	1435 - 1626.5	9.0 - 9.2
4.20725 - 4.20775	73 - 74.6	1645.5 - 1646.5	9.3 - 9.5
6.215 - 6.218	74.8 - 75.2	1660 - 1710	10.5 - 12.7
6.26775 - 6.26825	108 - 121.94	1718.8 - 1722.2	13.25 - 13.4
6.31175 - 6.31225	123 - 138	2200 - 2300	14.47 - 14.5
8.291 - 8.294	149.9 - 150.05	2310 - 2390	15.35 - 16.2
8.362 - 8.366	156.52475 - 156.52525	2483.5 - 2500	17.7 - 21.4
8.37625 - 8.38675	156.7 - 156.9	2655 - 2900	22.01 - 23.12
8.41425 - 8.41475	162.0125 - 167.17	3260 - 3267	23.6 - 24.0
12.29 - 12.293	167.72 - 173.2	3332 - 3339	31.2 - 31.8
12.51975 - 12.52025	240 - 285	3345.8 - 3358	36.43 - 36.5
12.57675 - 12.57725	322 - 335.4	3600 - 4400	
13.36 - 13.41			



b. RSS-Gen section 7.2.2 Restricted bands of operation

MHz	MHz	GHz
0.090-0.110	240-285	9.0-9.2
2.1735-2.1905	322-335.4	9.3-9.5
3.020-3.026	399.9-410	10.6-12.7
4.125-4.128	608-614	13.25-13.4
4.17725-4.17775	960-1427	14.47-14.5
4.20725-4.20775	1435-1626.5	15.35-16.2
5.677-5.683	1645.5-1646.5	17.7-21.4
6.215-6.218	1660-1710	22.01-23.12
6.26775-6.26825	1718.8-1722.2	23.6-24.0
6.31175-6.31225	2200-2300	31.2-31.8
8.291-8.294	2310-2390	36.43-36.5
8.362-8.366	2655-2900	Above 38.6
8.37625-8.38675	3260-3267	
8.41425-8.41475	3332-3339	
12.29-12.293	3345.8-3358	
12.51975-12.52025	3500-4400	
12.57675-12.57725	4500-5150	
13.36-13.41	5350-5460	
16.42-16.423	7250-7750	
16.69475-16.69525	8025-8500	
16.80425-16.80475		
25.5-25.67		
37.5-38.25		
73-74.6		
74.8-75.2		
108-138		
156.52475-156.52525		
156.7-156.9		

7.9 99% Occupied Bandwidth

Test Configuration:

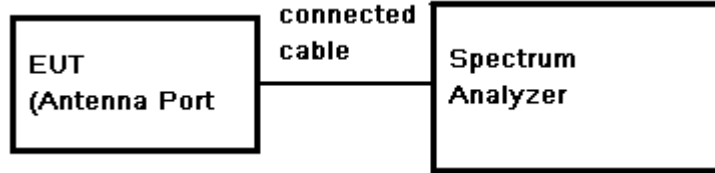

Test Procedure:

1. Remove the antenna from the EUT and then connect a low RF cable from the antenna port to the spectrum;
2. Set the spectrum analyzer: Span = approximately 2 to 3 times the 20dB bandwidth, centred on the hopping channel;
3. Set the spectrum analyzer: RBW \geq 1% of the 20dB bandwidth (set 1MHz). VBW \geq RBW. Sweep = auto; Detector Function = Peak. Trace = Max Hold.
4. Mark the peak frequency and -20dB points.

Test Date:

Test Mode	Channel (MHz)	Bandwidth (MHz)
802.11 b	2412	15.09
	2437	15.09
	2462	15.09
802.11 g	2412	17.40
	2437	17.37
	2462	17.43
802.11 n(HT20)	2412	18.42
	2437	18.45
	2462	18.48
802.11 n(HT40)	2422	37.52
	2437	37.76
	2452	37.68

Test plot as follows:

802.11 b	Channel: 2412
----------	---------------

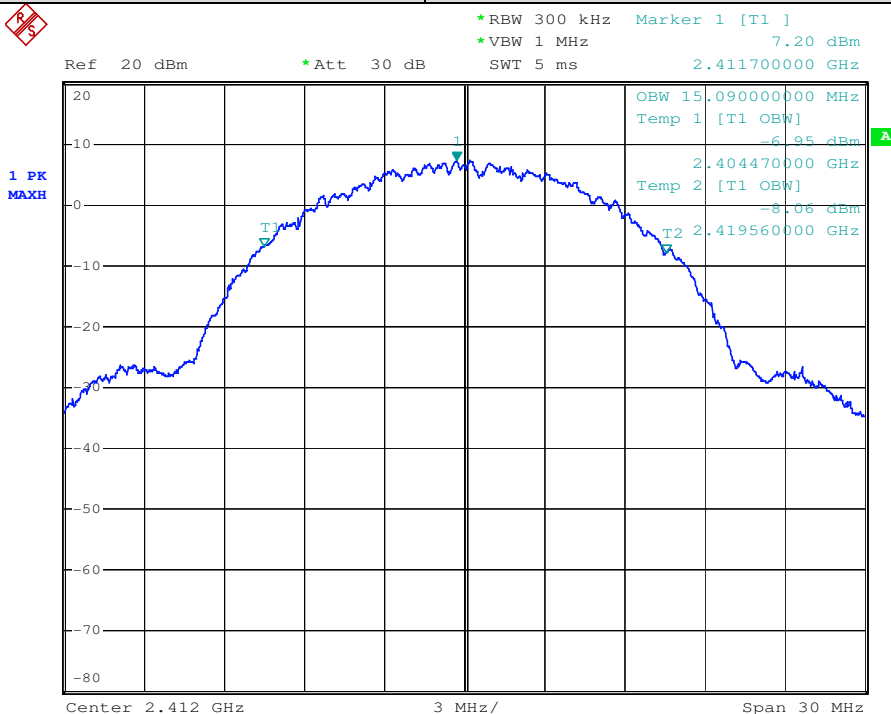

802.11 b	Channel: 2437
----------	---------------

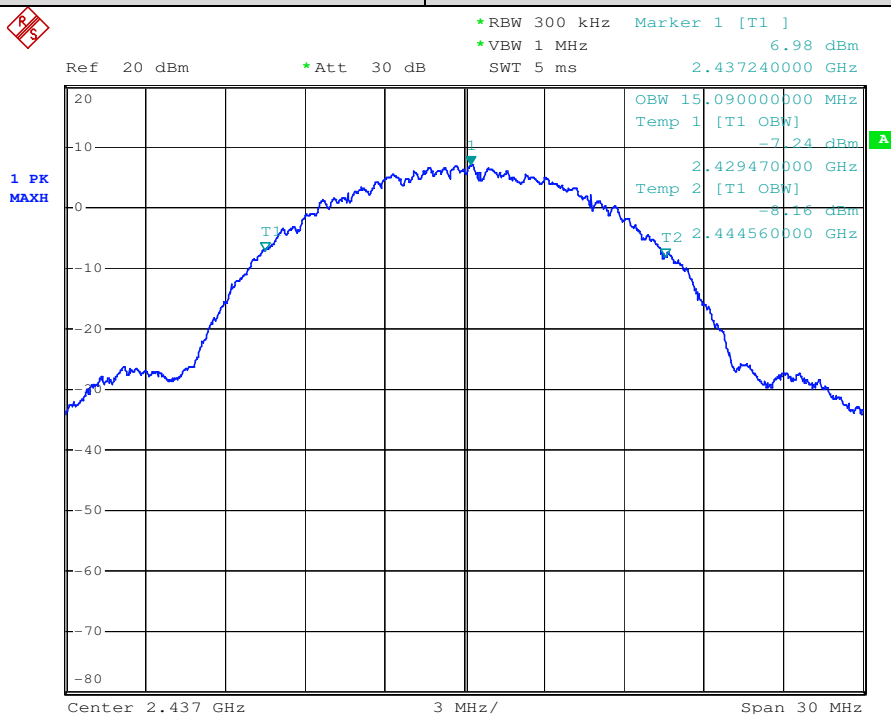

802.11 b Channel: 2462

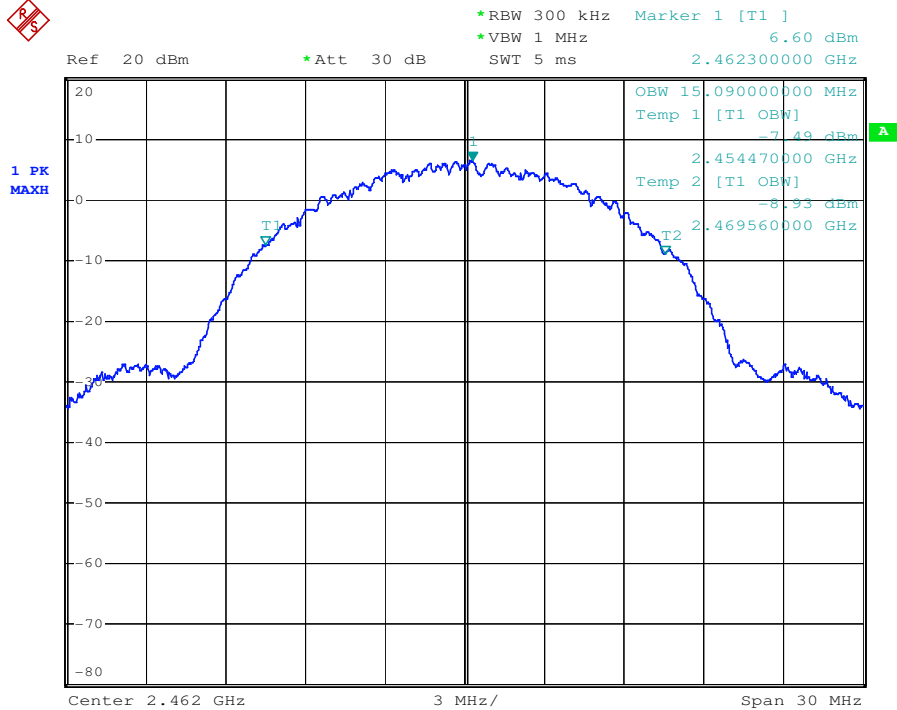

802.11 g Channel: 2412

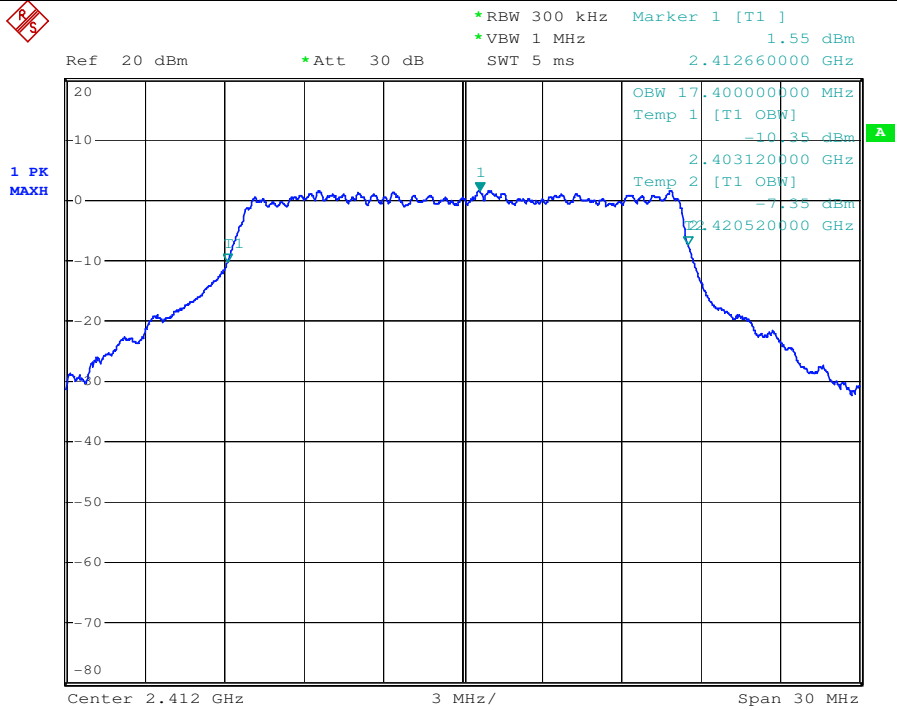

802.11 g Channel: 2437

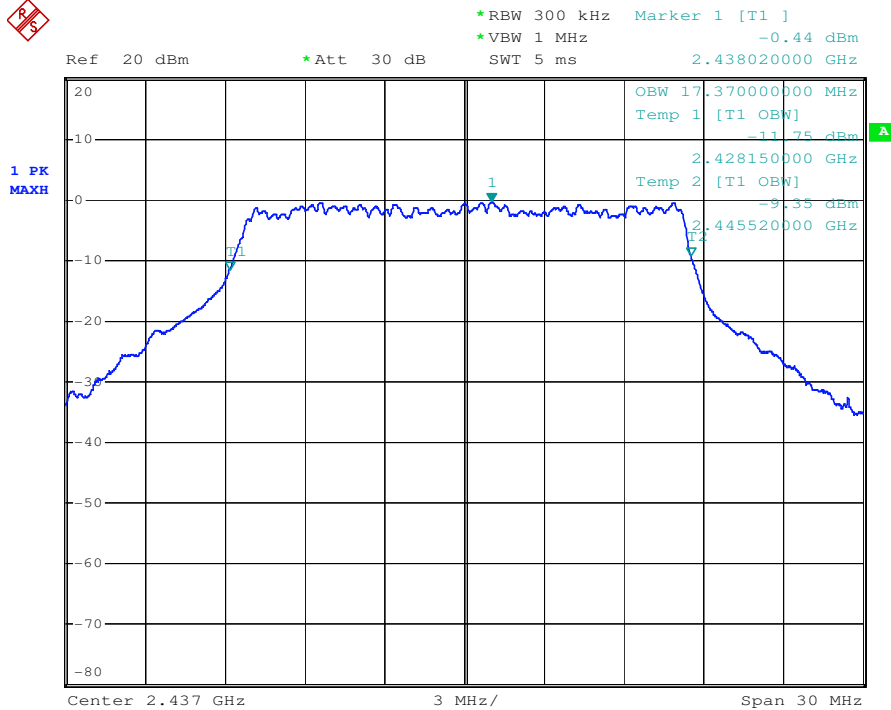

802.11 g Channel: 2462

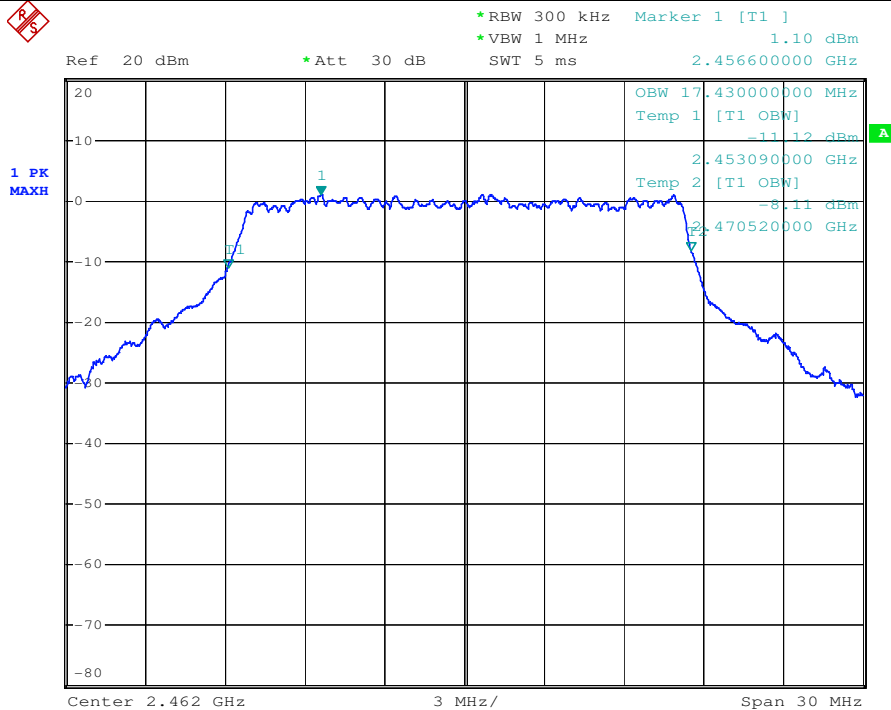

This document is issued by the Company subject to its General Conditions of Service printed overleaf, available on request or accessible at www.sgs.com/terms_and_conditions.htm and, for electronic format documents, subject to Terms and Conditions for Electronic Documents at www.sgs.com/terms_e-document.htm. Attention is drawn to the limitation of liability, indemnification and jurisdiction issues defined therein. Any holder of this document is advised that information contained hereon reflects the Company's findings at the time of its intervention only and within the limits of Client's instructions, if any. The Company's sole responsibility is to its Client and this document does not exonerate parties to a transaction from exercising all their rights and obligations under the transaction documents. This document cannot be reproduced except in full, without prior written approval of the Company. Any unauthorized alteration, forgery or falsification of the content or appearance of this document is unlawful and offenders may be prosecuted to the fullest extent of the law. Unless otherwise stated the results shown in this test report refer only to the sample(s) tested and such sample(s) are retained for 90 days only



802.11 n (HT20) Channel: 2412

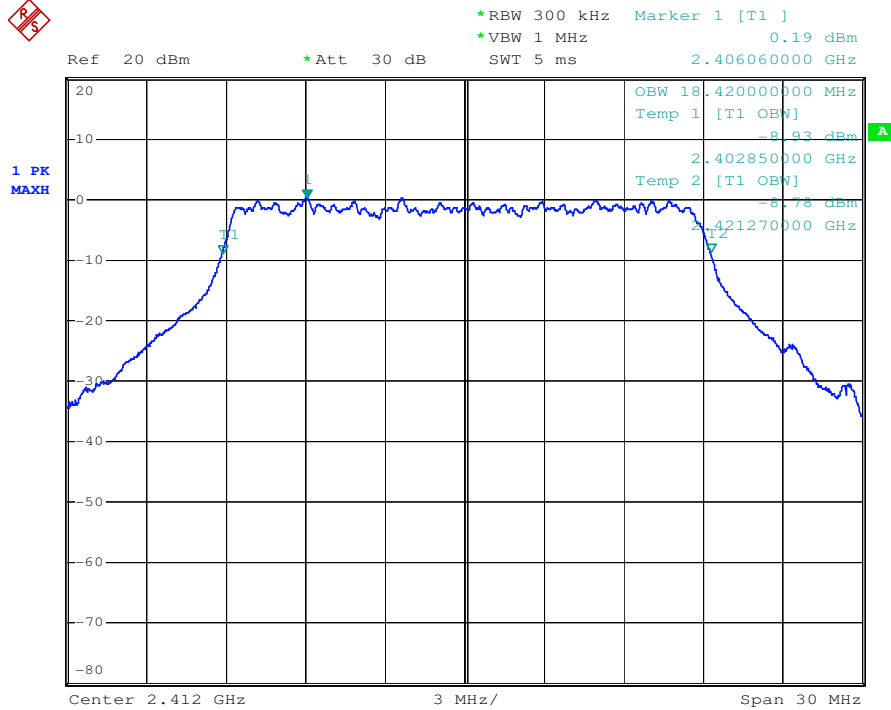

802.11 n (HT20) Channel: 2437

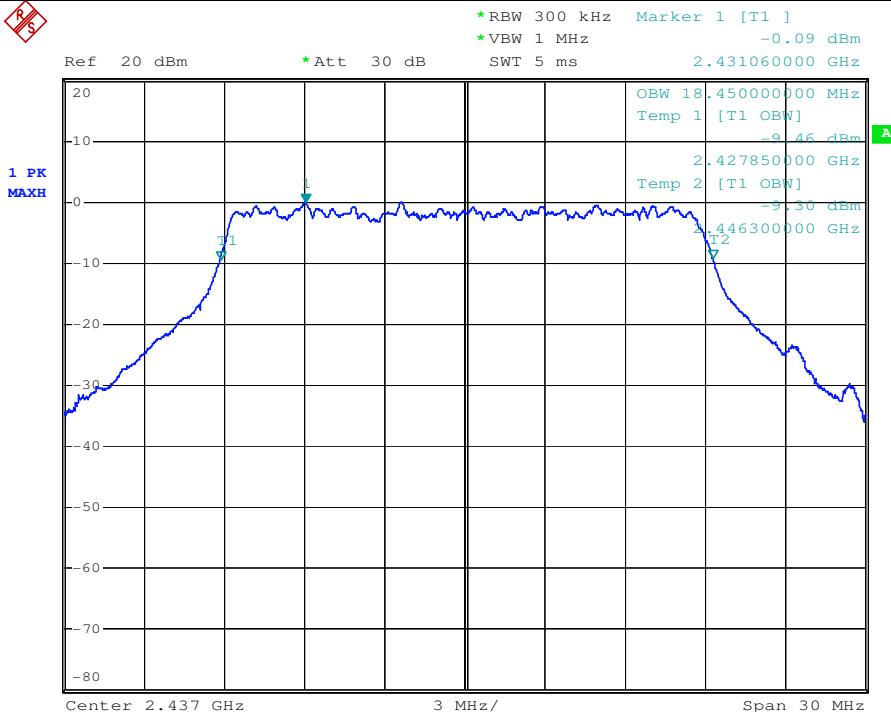



802.11 n (HT20) Channel: 2462

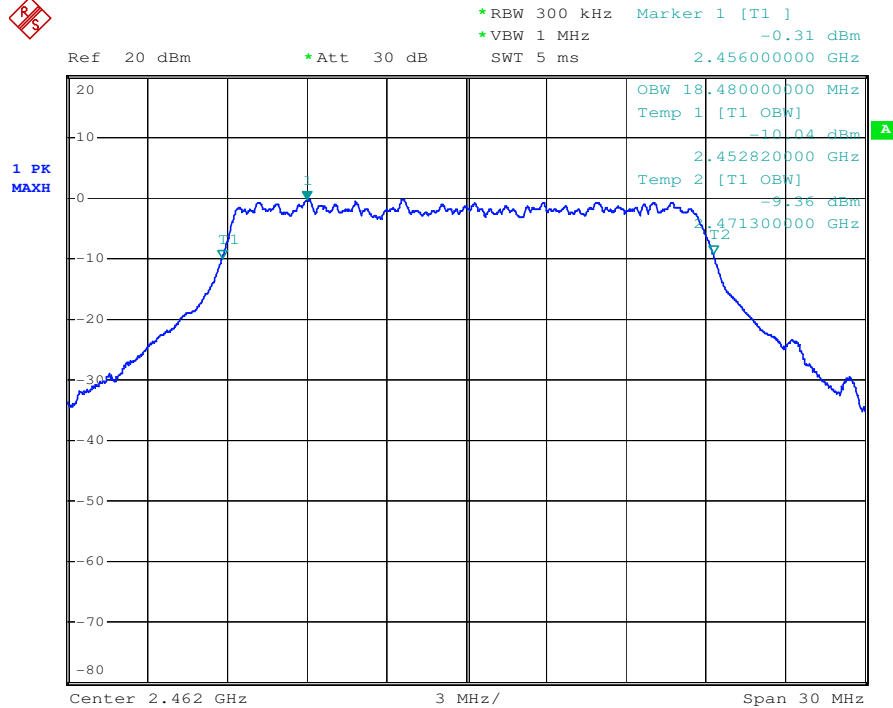

802.11 n (HT40) Channel: 2422

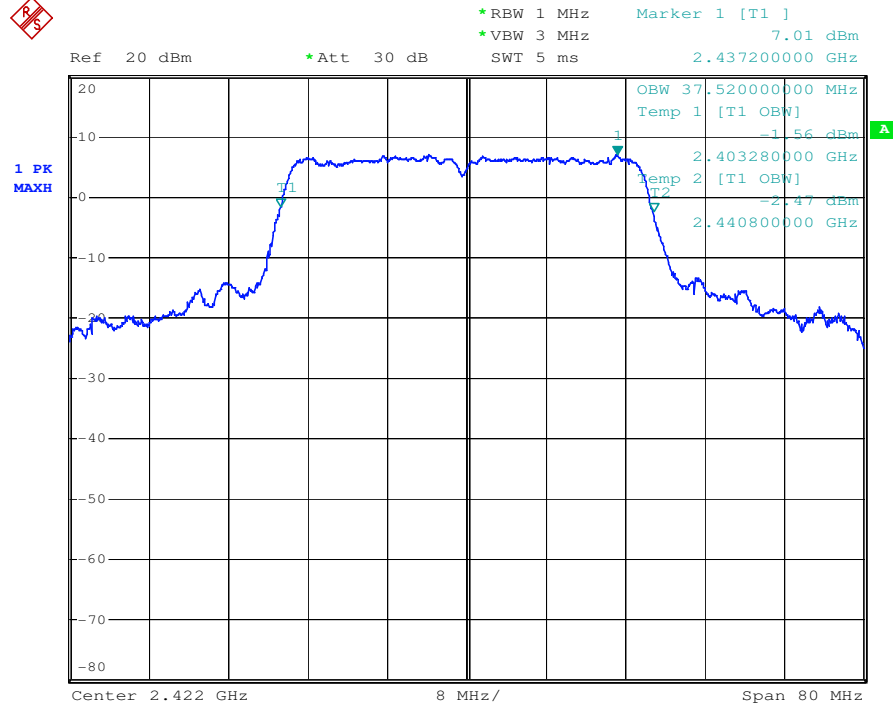



802.11 n (HT40) Channel: 2437

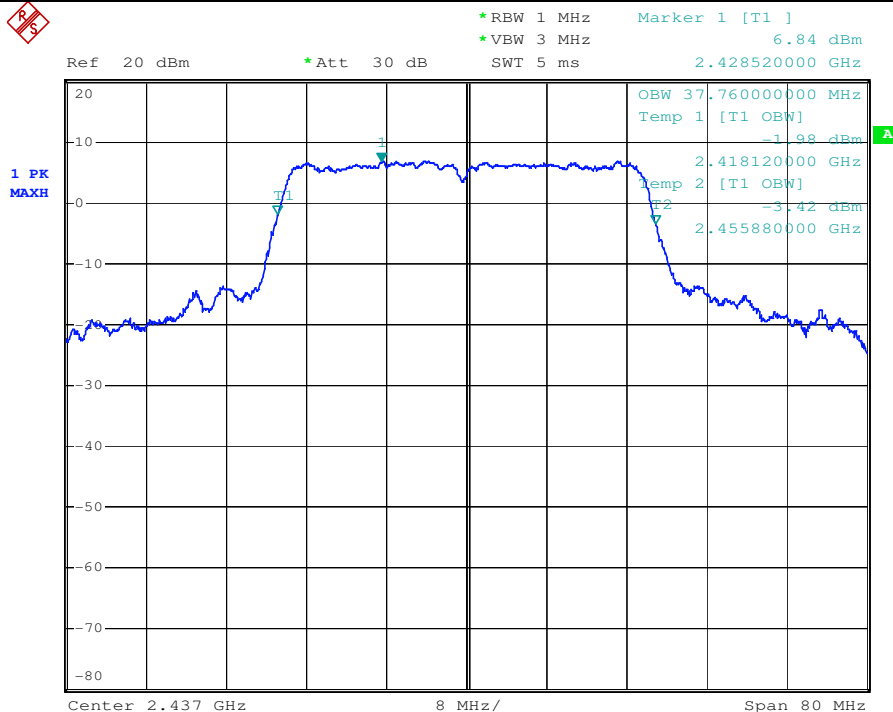

802.11 n (HT40) Channel: 2452

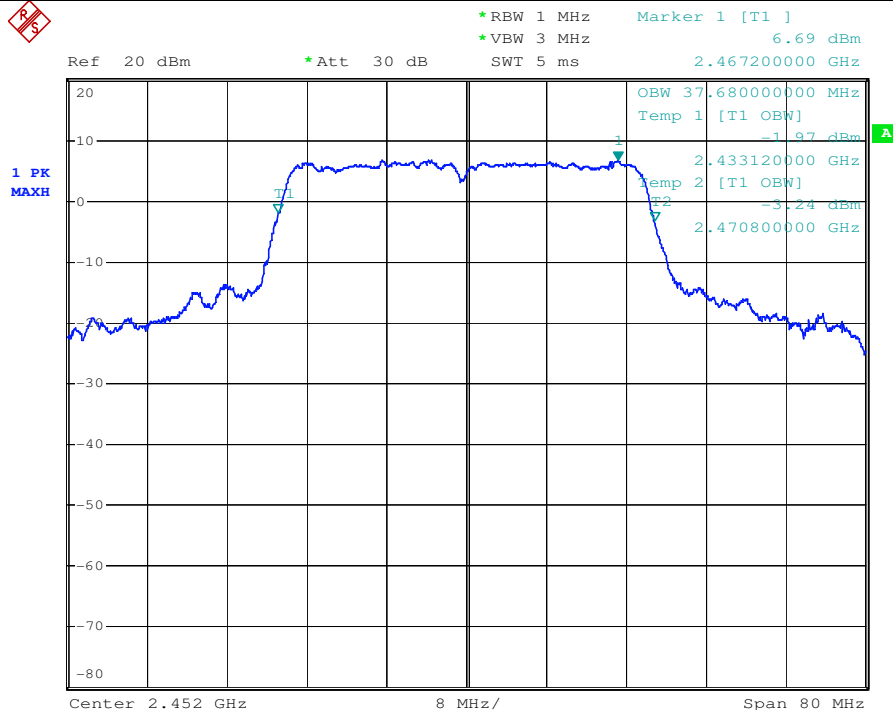



8 Test Setup Photographs

Refer to the < TV-IP322WI_Test Setup photos-FCC>.

9 EUT Constructional Details

Refer to the < TV-IP322WI_External Photos > & < TV-IP322WI_Internal Photos >.

--End of the Report--