



A D T

FCC TEST REPORT

REPORT NO.: RF991117C17B
MODEL NO.: TEW-MFP1
FCC ID: XU8TEWMFP1
RECEIVED: Oct. 01, 2010
TESTED: Oct. 04 ~ Nov. 26, 2010
ISSUED: Feb. 07, 2012

APPLICANT: TRENDnet, Inc.

ADDRESS: 20675 Manhattan Place, Torrance, CA 90501, USA

ISSUED BY: Bureau Veritas Consumer Products Services (H.K.) Ltd., Taoyuan Branch

LAB ADDRESS: No. 47, 14th Ling, Chia Pau Vil., Lin Kou Dist., New Taipei City, Taiwan (R.O.C)

TEST LOCATION: No. 19, Hwa Ya 2nd Rd, Wen Hwa Tsuen, Kwei Shan Hsiang, Taoyuan Hsien 333, Taiwan, R.O.C.

This test report consists of 69 pages in total. It may be duplicated completely for legal use with the approval of the applicant. It should not be reproduced except in full, without the written approval of our laboratory. The client should not use it to claim product, certification, approval or endorsement by TAF or any government agency. The test results in the report only apply to the tested sample.





A D T

TABLE OF CONTENTS

RELEASE CONTROL RECORD	4
1. CERTIFICATION	5
2. SUMMARY OF TEST RESULTS	6
2.1 MEASUREMENT UNCERTAINTY	6
3. GENERAL INFORMATION	7
3.1 GENERAL DESCRIPTION OF EUT	7
3.2 DESCRIPTION OF TEST MODES	8
3.2.1 CONFIGURATION OF SYSTEM UNDER TEST	9
3.2.2 TEST MODE APPLICABILITY AND TESTED CHANNEL DETAIL	10
3.3 GENERAL DESCRIPTION OF APPLIED STANDARDS	12
3.4 DESCRIPTION OF SUPPORT UNITS	12
4. TEST TYPES AND RESULTS	13
4.1 RADIATED EMISSION MEASUREMENT	13
4.1.1 LIMITS OF RADIATED EMISSION MEASUREMENT	13
4.1.2 TEST INSTRUMENTS	14
4.1.3 TEST PROCEDURES	15
4.1.4 DEVIATION FROM TEST STANDARD	15
4.1.5 TEST SETUP	16
4.1.6 EUT OPERATING CONDITIONS	16
4.1.7 TEST RESULTS	17
4.2 CONDUCTED EMISSION MEASUREMENT	30
4.2.1 LIMITS OF CONDUCTED EMISSION MEASUREMENT	30
4.2.2 TEST INSTRUMENTS	30
4.2.3 TEST PROCEDURES	31
4.2.4 DEVIATION FROM TEST STANDARD	31
4.2.5 TEST SETUP	32
4.2.6 EUT OPERATING CONDITIONS	32
4.2.7 TEST RESULTS	33
4.3 6dB BANDWIDTH MEASUREMENT	35
4.3.1 LIMITS OF 6dB BANDWIDTH MEASUREMENT	35
4.3.2 TEST INSTRUMENTS	35
4.3.3 TEST PROCEDURE	35
4.3.4 DEVIATION FROM TEST STANDARD	35
4.3.5 TEST SETUP	36
4.3.6 EUT OPERATING CONDITIONS	36
4.3.7 TEST RESULTS	37
4.4 MAXIMUM OUTPUT POWER	41
4.4.1 LIMITS OF MAXIMUM OUTPUT POWER MEASUREMENT	41
4.4.2 INSTRUMENTS	41
4.4.3 TEST PROCEDURES	41
4.4.4 DEVIATION FROM TEST STANDARD	42
4.4.5 TEST SETUP	42



A D T

4.4.6	EUT OPERATING CONDITIONS	42
4.4.7	TEST RESULTS	43
4.5	POWER SPECTRAL DENSITY MEASUREMENT	44
4.5.1	LIMITS OF POWER SPECTRAL DENSITY MEASUREMENT	44
4.5.2	TEST INSTRUMENTS.....	44
4.5.3	TEST PROCEDURE.....	44
4.5.4	DEVIATION FROM TEST STANDARD.....	45
4.5.5	TEST SETUP.....	45
4.5.6	EUT OPERATING CONDITION.....	45
4.5.7	TEST RESULTS	46
4.6	BAND EDGES MEASUREMENT	50
4.6.1	LIMITS OF BAND EDGES MEASUREMENT	50
4.6.2	TEST INSTRUMENTS.....	50
4.6.3	TEST PROCEDURE.....	50
4.6.4	DEVIATION FROM TEST STANDARD.....	50
4.6.5	EUT OPERATING CONDITION.....	50
4.6.6	TEST RESULTS	51
5.	PHOTOGRAPHS OF THE TEST CONFIGURATION.....	67
6.	INFORMATION ON THE TESTING LABORATORIES	68
7.	APPENDIX A - MODIFICATIONS RECORDERS FOR ENGINEERING CHANGES TO THE EUT BY THE LAB.....	69



A D T

RELEASE CONTROL RECORD

ISSUE NO.	REASON FOR CHANGE	DATE ISSUED
Original release	NA	Feb. 07, 2012



A D T

1. CERTIFICATION

PRODUCT: 1-Port Wireless N Multi-Function USB Print Server

MODEL: TEW-MFP1

BRAND: TRENDnet

APPLICANT: TRENDnet, Inc.

TESTED: Oct. 04 ~ Nov. 26, 2010

TEST SAMPLE: ENGINEERING SAMPLE

STANDARDS: **FCC Part 15, Subpart C (Section 15.247)**

ANSI C63.4-2003

ANSI C63.10-2009

The above equipment (Model: TEW-MFP1) has been tested by **Bureau Veritas Consumer Products Services (H.K.) Ltd., Taoyuan Branch**, and found compliance with the requirement of the above standards. The test record, data evaluation & Equipment Under Test (EUT) configurations represented herein are true and accurate accounts of the measurements of the sample's EMC characteristics under the conditions specified in this report.

PREPARED BY :  , DATE: Feb. 07, 2012
Polly Chien / Specialist

APPROVED BY :  , DATE: Feb. 07, 2012
Gary Chang / Technical Manager



2. SUMMARY OF TEST RESULTS

The EUT has been tested according to the following specifications:

APPLIED STANDARD: FCC PART 15, SUBPART C (SECTION 15.247)			
STANDARD SECTION	TEST TYPE AND LIMIT	RESULT	REMARK
15.207	AC Power Conducted Emission	PASS	Meet the requirement of limit. Minimum passing margin is -21.59dB at 0.150MHz.
15.247(a)(2)	Spectrum Bandwidth of a Direct Sequence Spread Spectrum System Limit: min. 500kHz	PASS	Meet the requirement of limit.
15.247(b)	Maximum Output Power Limit: max. 30dBm	PASS	Meet the requirement of limit.
15.247(d)	Radiated Emissions Limit: Table 15.209	PASS	Meet the requirement of limit. Minimum passing margin is -1.0dB at 2390.00MHz.
15.247(e)	Power Spectral Density Limit: max. 8dBm	PASS	Meet the requirement of limit.
15.247(d)	Band Edge Measurement Limit: 20dB less than the peak value of fundamental frequency	PASS	Meet the requirement of limit.
15.203	Antenna Requirement	PASS	No antenna connector is used.

2.1 MEASUREMENT UNCERTAINTY

Where relevant, the following measurement uncertainty levels have been estimated for tests performed on the EUT as specified in CISPR 16-4-2:

MEASUREMENT	FREQUENCY	UNCERTAINTY
Conducted emissions	150kHz~30MHz	2.44 dB
Radiated emissions	30MHz ~ 200MHz	3.19 dB
	200MHz ~1000MHz	3.21 dB
	1GHz ~ 18GHz	2.26 dB
	18GHz ~ 40GHz	1.94 dB

This uncertainty represents an expanded uncertainty expressed at approximately the 95% confidence level using a coverage factor of $k = 2$.



A D T

3. GENERAL INFORMATION

3.1 GENERAL DESCRIPTION OF EUT

EUT	1-Port Wireless N Multi-Function USB Print Server
MODEL NO.	TEW-MFP1
FCC ID	XU8TEWMFP1
POWER SUPPLY	12Vdc
MODULATION TYPE	CCK, DQPSK, DBPSK for DSSS 64QAM, 16QAM, QPSK, BPSK for OFDM
MODULATION TECHNOLOGY	DSSS, OFDM
TRANSFER RATE	802.11b: 11.0/ 5.5/ 2.0/ 1.0Mbps 802.11g: 54.0/ 48.0/ 36.0/ 24.0/ 18.0/ 12.0/ 9.0/ 6.0Mbps 802.11n: up to 150.0Mbps
OPERATING FREQUENCY	2412 ~ 2462MHz
NUMBER OF CHANNEL	11 for 802.11b, 802.11g, 802.11n (20MHz) 7 for 802.11n (40MHz)
OUTPUT POWER	380.2mW
ANTENNA TYPE	Dipole antenna with 2dBi gain
ANTENNA CONNECTOR	NA
DATA CABLE	NA
I/O PORTS	RJ45, USB
ACCESSORY DEVICES	Adapter

NOTE:

1. This report is issued as a duplicate report to the original report no.: RF991117C17. The differences are changing the product name, model name, brand name, applicant, FCC ID and housing.
2. The test photos in this report would be retaken to meet clients' requests.
3. The EUT provides one completed transmitter and one receiver.

MODULATION MODE	TX FUNCTION
802.11b	1TX
802.11g	1TX
802.11n (20MHz)	1TX
802.11n (40MHz)	1TX

4. The EUT were powered by the following adapter:

BRAND:	DVE
MODEL:	DSA-12G-12 FUS 120120
INPUT:	100-240Vac, 50/60Hz, 0.3A
OUTPUT:	+12Vdc, 1A
POWER LINE:	1.5m non-shielded cable without core



A D T

5. The above EUT information is declared by manufacturer and for more detailed features description, please refer to the manufacturer's specifications or user's manual.

3.2 DESCRIPTION OF TEST MODES

11 channels are provided for 802.11b, 802.11g and 802.11n (20MHz):

CHANNEL	FREQUENCY	CHANNEL	FREQUENCY
1	2412MHz	7	2442MHz
2	2417MHz	8	2447MHz
3	2422MHz	9	2452MHz
4	2427MHz	10	2457MHz
5	2432MHz	11	2462MHz
6	2437MHz		

7 channels are provided for 802.11n (40MHz):

CHANNEL	FREQUENCY	CHANNEL	FREQUENCY
1	2422MHz	5	2442MHz
2	2427MHz	6	2447MHz
3	2432MHz	7	2452MHz
4	2437MHz		

3.2.1 CONFIGURATION OF SYSTEM UNDER TEST

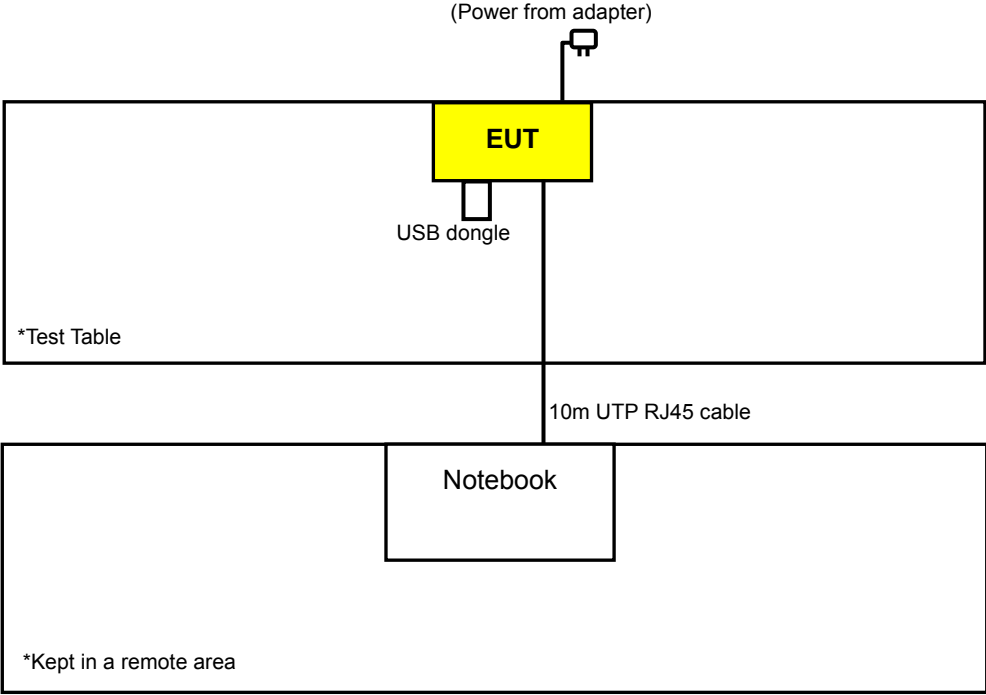

3.2.2 TEST MODE APPLICABILITY AND TESTED CHANNEL DETAIL

EUT CONFIGURE MODE	APPLICABLE TO				DESCRIPTION
	RE \geq 1G	RE<1G	PLC	APCM	
-	√	√	√	√	-

Where **RE \geq 1G**: Radiated Emission above 1GHz **RE<1G**: Radiated Emission below 1GHz
PLC: Power Line Conducted Emission **APCM**: Antenna Port Conducted Measurement

RADIATED EMISSION TEST (ABOVE 1GHz):

- Pre-Scan has been conducted to determine the worst-case mode from all possible combinations between available modulations, data rates and antenna ports (if EUT with antenna diversity architecture).
- Following channel(s) was (were) selected for the final test as listed below.

MODE	AVAILABLE CHANNEL	TESTED CHANNEL	MODULATION TECHNOLOGY	MODULATION TYPE	DATA RATE (Mbps)
802.11b	1 to 11	1, 6, 11	DSSS	DBPSK	1.0
802.11g	1 to 11	1, 6, 11	OFDM	BPSK	6.0
802.11n (20MHz)	1 to 11	1, 6, 11	OFDM	BPSK	6.5
802.11n (40MHz)	1 to 7	1, 4, 7	OFDM	BPSK	13.5

RADIATED EMISSION TEST (BELOW 1GHz):

- Pre-Scan has been conducted to determine the worst-case mode from all possible combinations between available modulations, data rates and antenna ports (if EUT with antenna diversity architecture).
- Following channel(s) was (were) selected for the final test as listed below.

MODE	AVAILABLE CHANNEL	TESTED CHANNEL	MODULATION TECHNOLOGY	MODULATION TYPE	DATA RATE (Mbps)
802.11n (20MHz)	1 to 11	6	OFDM	BPSK	6.5

POWER LINE CONDUCTED EMISSION TEST:

- Pre-Scan has been conducted to determine the worst-case mode from all possible combinations between available modulations, data rates and antenna ports (if EUT with antenna diversity architecture).
- Following channel(s) was (were) selected for the final test as listed below.

MODE	AVAILABLE CHANNEL	TESTED CHANNEL	MODULATION TECHNOLOGY	MODULATION TYPE	DATA RATE (Mbps)
802.11n (20MHz)	1 to 11	6	OFDM	BPSK	6.5



A D T

BANDEDGE MEASUREMENT:

- Pre-Scan has been conducted to determine the worst-case mode from all possible combinations between available modulations, data rates and antenna ports (if EUT with antenna diversity architecture).
- Following channel(s) was (were) selected for the final test as listed below.

MODE	AVAILABLE CHANNEL	TESTED CHANNEL	MODULATION TECHNOLOGY	MODULATION TYPE	DATA RATE (Mbps)
802.11b	1 to 11	1, 11	DSSS	DBPSK	1.0
802.11g	1 to 11	1, 11	OFDM	BPSK	6.0
802.11n (20MHz)	1 to 11	1, 11	OFDM	BPSK	6.5
802.11n (40MHz)	1 to 7	1, 7	OFDM	BPSK	13.5

ANTENNA PORT CONDUCTED MEASUREMENT:

- This item includes all test value of each mode, but only includes spectrum plot of worst value of each mode.
- Pre-Scan has been conducted to determine the worst-case mode from all possible combinations between available modulations, data rates and antenna ports (if EUT with antenna diversity architecture).
- Following channel(s) was (were) selected for the final test as listed below.

MODE	AVAILABLE CHANNEL	TESTED CHANNEL	MODULATION TECHNOLOGY	MODULATION TYPE	DATA RATE (Mbps)
802.11b	1 to 11	1, 6, 11	DSSS	DBPSK	1.0
802.11g	1 to 11	1, 6, 11	OFDM	BPSK	6.0
802.11n (20MHz)	1 to 11	1, 6, 11	OFDM	BPSK	6.5
802.11n (40MHz)	1 to 7	1, 4, 7	OFDM	BPSK	13.5

TEST CONDITION:

APPLICABLE TO	ENVIRONMENTAL CONDITIONS	INPUT POWER	TESTED BY
RE \geq 1G	25deg. C, 65%RH, 1009 hPa	120Vac, 60Hz	Long Chen
RE $<$ 1G	25deg. C, 65%RH, 1009 hPa	120Vac, 60Hz	Long Chen
PLC	25deg. C, 65%RH, 1006 hPa	120Vac, 60Hz	Frank Wang
APCM	25deg. C, 65%RH, 1009 hPa	120Vac, 60Hz	Long Chen



3.3 GENERAL DESCRIPTION OF APPLIED STANDARDS

The EUT is a RF Product. According to the specifications of the manufacturer, it must comply with the requirements of the following standards:

FCC Part 15, Subpart C (15.247)

ANSI C63.4-2003

ANSI C63.10-2009

All test items have been performed and recorded as per the above standards.

NOTE: The EUT is also considered as a kind of computer peripheral, because the connection to computer is necessary for typical use. It has been verified to comply with the requirements of FCC Part 15, Subpart B, Class B (DoC). The test report has been issued separately.

3.4 DESCRIPTION OF SUPPORT UNITS

The EUT has been tested as an independent unit together with other necessary accessories or support units. The following support units or accessories were used to form a representative test configuration during the tests.

NO.	PRODUCT	BRAND	MODEL NO.	SERIAL NO.	FCC ID
1	NOTEBOOK	DELL	PP05L	12130898320	E2K24CLNS
2	USB DONGLE	TDK	TDK-166	NA	NA

NO.	SIGNAL CABLE DESCRIPTION OF THE ABOVE SUPPORT UNITS
1	10m RJ45 UTP cable.
2	NA

NOTE:

- 1. All power cords of the above support units are non shielded (1.8m).
- 2. Item 1 acted as a communication partner to transfer data.



4. TEST TYPES AND RESULTS

4.1 RADIATED EMISSION MEASUREMENT

4.1.1 LIMITS OF RADIATED EMISSION MEASUREMENT

Emissions radiated outside of the specified bands, shall be according to the general radiated limits in 15.209 as following:

FREQUENCIES (MHz)	FIELD STRENGTH (microvolts/meter)	MEASUREMENT DISTANCE (meters)
0.009 ~ 0.490	2400/F(kHz)	300
0.490 ~ 1.705	24000/F(kHz)	30
1.705 ~ 30.0	30	30
30 ~ 88	100	3
88 ~ 216	150	3
216 ~ 960	200	3
Above 960	500	3

NOTE:

1. The lower limit shall apply at the transition frequencies.
2. Emission level (dBuV/m) = 20 log Emission level (uV/m).
3. As shown in 15.35(b), for frequencies above 1000MHz, the field strength limits are based on average detector, however, the peak field strength of any emission shall not exceed the maximum permitted average limits, specified above by more than 20dB under any condition of modulation.



A D T

4.1.2 TEST INSTRUMENTS

DESCRIPTION & MANUFACTURER	MODEL NO.	SERIAL NO.	DATE OF CALIBRATION	DUE DATE OF CALIBRATION
Test Receiver ROHDE & SCHWARZ	ESI7	838496/016	Dec. 29, 2009	Dec. 28, 2010
Spectrum Analyzer ROHDE & SCHWARZ	FSP40	100039	Jan. 11, 2010	Jan. 10, 2011
BILOG Antenna SCHWARZBECK	VULB9168	9168-155	Apr. 28, 2010	Apr. 27, 2011
HORN Antenna SCHWARZBECK	BBHA 9120D	9120D-408	Jan. 05, 2010	Jan. 04, 2011
HORN Antenna SCHWARZBECK	BBHA 9170	BBHA9170242	Dec. 25, 2009	Dec. 24, 2010
Preamplifier Agilent	8449B	3008A01910	Sep. 09, 2010	Sep. 08, 2011
Preamplifier Agilent	8447D	2944A10638	Dec. 21, 2009	Dec. 20, 2010
RF signal cable HUBER+SUHNNER	SUCOFLEX 104	274041/4	Aug. 21, 2010	Aug. 20, 2011
RF signal cable HUBER+SUHNNER	SUCOFLEX 104	283397/4	Aug. 21, 2010	Aug. 20, 2011
Software ADT.	ADT_Radiated_ V7.6.15.9.2	NA	NA	NA
Antenna Tower inn-co GmbH	MA 4000	010303	NA	NA
Antenna Tower Controller inn-co GmbH	CO2000	019303	NA	NA
Turn Table ADT.	TT100.	TT93021704	NA	NA
Turn Table Controller ADT.	SC100.	SC93021704	NA	NA

- NOTE:**
1. The calibration interval of the above test instruments is 12 months and the calibrations are traceable to NML/ROC and NIST/USA.
 2. The test was performed in HwaYa Chamber 4.
 3. The horn antenna and HP preamplifier (model: 8449B) are used only for the measurement of emission frequency above 1GHz if tested.
 4. The FCC Site Registration No. is 988962.
 5. The IC Site Registration No. is IC7450F-4.



4.1.3 TEST PROCEDURES

- a. The EUT was placed on the top of a rotating table 0.8 meters above the ground at a 3 meters semi-anechoic chamber. The table was rotated 360 degrees to determine the position of the highest radiation.
- b. The EUT was set 3 meters away from the interference-receiving antenna, which was mounted on the top of a variable-height antenna tower.
- c. The antenna is a broadband antenna, and its height is varied from one meter to four meters above the ground to determine the maximum value of the field strength. Both horizontal and vertical polarizations of the antenna are set to make the measurement.
- d. For each suspected emission, the EUT was arranged to its worst case and then the antenna was tuned to heights from 1 meter to 4 meters and the rotatable table was turned from 0 degrees to 360 degrees to find the maximum reading.
- e. The test-receiver system was set to Peak Detect Function and Specified Bandwidth with Maximum Hold Mode.
- f. If the emission level of the EUT in peak mode was lower than the limit specified, then testing could be stopped and the peak values of the EUT would be reported. Otherwise the emissions would be re-tested one by one using peak, quasi-peak or average method as specified and then reported in a data sheet.

NOTE:

1. The resolution bandwidth and video bandwidth of test receiver/spectrum analyzer is 120kHz for Quasi-peak detection at frequency below 1GHz.
2. The resolution bandwidth of test receiver/spectrum analyzer is 1MHz and video bandwidth is 3MHz for Peak detection at frequency above 1GHz.
3. The resolution bandwidth of test receiver/spectrum analyzer is 1MHz and the video bandwidth is 10Hz for Average detection (AV) at frequency above 1GHz.
4. All modes of operation were investigated and the worst-case emissions are reported.

4.1.4 DEVIATION FROM TEST STANDARD

No deviation.

4.1.5 TEST SETUP

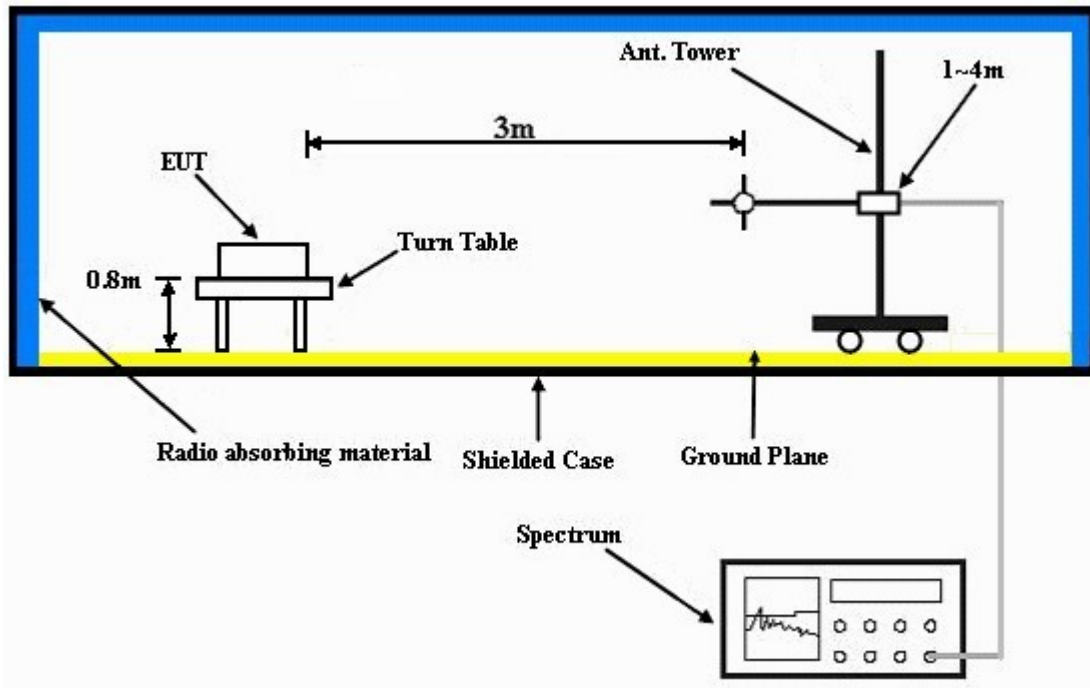

For the actual test configuration, please refer to the attached file (Test Setup Photo).

4.1.6 EUT OPERATING CONDITIONS

- a. Placed the EUT on the testing table.
- b. Prepared notebook system to act as a communication partner and placed them outside of testing area.
- c. The communication partners connected with EUT via a RJ45 cable and run a test program (provided by manufacturer) to enable EUT under transmission condition continuously at specific channel frequency.
- d. The necessary accessories enable the EUT in full functions.



A D T

4.1.7 TEST RESULTS

802.11b

EUT TEST CONDITION		MEASUREMENT DETAIL	
CHANNEL	Channel 1	FREQUENCY RANGE	1 ~ 25GHz
INPUT POWER	120Vac, 60 Hz	DETECTOR FUNCTION	Peak (PK) Average (AV)
ENVIRONMENTAL CONDITIONS	25deg. C, 65%RH	TESTED BY	Long Chen

ANTENNA POLARITY & TEST DISTANCE: HORIZONTAL AT 3 M								
NO.	FREQ. (MHz)	EMISSION LEVEL (dBuV/m)	LIMIT (dBuV/m)	MARGIN (dB)	ANTENNA HEIGHT (m)	TABLE ANGLE (Degree)	RAW VALUE (dBuV)	CORRECTION FACTOR (dB/m)
1	2390.00	62.1 PK	74.0	-11.9	1.38 H	131	28.60	33.50
2	2390.00	47.7 AV	54.0	-6.3	1.38 H	131	14.20	33.50
3	*2412.00	100.4 PK			1.38 H	131	66.80	33.60
4	*2412.00	95.7 AV			1.38 H	131	62.10	33.60
5	4824.00	57.8 PK	74.0	-16.2	1.56 H	85	17.80	40.00
6	4824.00	52.9 AV	54.0	-1.1	1.56 H	85	12.90	40.00
ANTENNA POLARITY & TEST DISTANCE: VERTICAL AT 3 M								
NO.	FREQ. (MHz)	EMISSION LEVEL (dBuV/m)	LIMIT (dBuV/m)	MARGIN (dB)	ANTENNA HEIGHT (m)	TABLE ANGLE (Degree)	RAW VALUE (dBuV)	CORRECTION FACTOR (dB/m)
1	2390.00	64.2 PK	74.0	-9.8	1.18 V	209	30.70	33.50
2	2390.00	51.0 AV	54.0	-3.0	1.18 V	209	17.50	33.50
3	*2412.00	108.6 PK			1.18 V	180	75.00	33.60
4	*2412.00	103.9 AV			1.18 V	180	70.30	33.60
5	4824.00	56.6 PK	74.0	-17.4	1.46 V	147	16.60	40.00
6	4824.00	51.8 AV	54.0	-2.2	1.46 V	147	11.80	40.00

- REMARKS:**
1. Emission level (dBuV/m) = Raw Value (dBuV) + Correction Factor (dB/m).
 2. Correction Factor (dB/m) = Antenna Factor (dB/m) + Cable Factor (dB).
 3. The other emission levels were very low against the limit.
 4. Margin value = Emission level – Limit value.
 5. “ * ”: Fundamental frequency.



A D T

EUT TEST CONDITION		MEASUREMENT DETAIL	
CHANNEL	Channel 6	FREQUENCY RANGE	1 ~ 25GHz
INPUT POWER	120Vac, 60 Hz	DETECTOR FUNCTION	Peak (PK) Average (AV)
ENVIRONMENTAL CONDITIONS	25deg. C, 65%RH	TESTED BY	Long Chen

ANTENNA POLARITY & TEST DISTANCE: HORIZONTAL AT 3 M								
NO.	FREQ. (MHz)	EMISSION LEVEL (dBuV/m)	LIMIT (dBuV/m)	MARGIN (dB)	ANTENNA HEIGHT (m)	TABLE ANGLE (Degree)	RAW VALUE (dBuV)	CORRECTION FACTOR (dB/m)
1	*2437.00	99.7 PK			1.36 H	127	66.00	33.70
2	*2437.00	95.0 AV			1.36 H	127	61.30	33.70
3	4874.00	56.6 PK	74.0	-17.4	1.55 H	79	16.50	40.10
4	4874.00	52.8 AV	54.0	-1.2	1.55 H	79	12.70	40.10
ANTENNA POLARITY & TEST DISTANCE: VERTICAL AT 3 M								
NO.	FREQ. (MHz)	EMISSION LEVEL (dBuV/m)	LIMIT (dBuV/m)	MARGIN (dB)	ANTENNA HEIGHT (m)	TABLE ANGLE (Degree)	RAW VALUE (dBuV)	CORRECTION FACTOR (dB/m)
1	*2437.00	108.0 PK			1.12 V	144	74.30	33.70
2	*2437.00	103.2 AV			1.12 V	144	69.50	33.70
3	4874.00	55.1 PK	74.0	-18.9	1.78 V	150	15.00	40.10
4	4874.00	50.5 AV	54.0	-3.5	1.78 V	150	10.40	40.10

- REMARKS:**
1. Emission level (dBuV/m) = Raw Value (dBuV) + Correction Factor (dB/m).
 2. Correction Factor (dB/m) = Antenna Factor (dB/m) + Cable Factor (dB).
 3. The other emission levels were very low against the limit.
 4. Margin value = Emission level – Limit value.
 5. “ * “: Fundamental frequency.



A D T

EUT TEST CONDITION		MEASUREMENT DETAIL	
CHANNEL	Channel 11	FREQUENCY RANGE	1 ~ 25GHz
INPUT POWER	120Vac, 60 Hz	DETECTOR FUNCTION	Peak (PK) Average (AV)
ENVIRONMENTAL CONDITIONS	25deg. C, 65%RH	TESTED BY	Long Chen

ANTENNA POLARITY & TEST DISTANCE: HORIZONTAL AT 3 M								
NO.	FREQ. (MHz)	EMISSION LEVEL (dBuV/m)	LIMIT (dBuV/m)	MARGIN (dB)	ANTENNA HEIGHT (m)	TABLE ANGLE (Degree)	RAW VALUE (dBuV)	CORRECTION FACTOR (dB/m)
1	*2462.00	100.1 PK			1.31 H	130	66.30	33.80
2	*2462.00	95.4 AV			1.31 H	130	61.60	33.80
3	2483.50	58.4 PK	74.0	-15.6	1.31 H	130	24.60	33.80
4	2483.50	48.1 AV	54.0	-5.9	1.31 H	130	14.30	33.80
5	4924.00	56.3 PK	74.0	-17.7	1.00 H	46	16.10	40.20
6	4924.00	52.2 AV	54.0	-1.8	1.00 H	46	12.00	40.20
ANTENNA POLARITY & TEST DISTANCE: VERTICAL AT 3 M								
NO.	FREQ. (MHz)	EMISSION LEVEL (dBuV/m)	LIMIT (dBuV/m)	MARGIN (dB)	ANTENNA HEIGHT (m)	TABLE ANGLE (Degree)	RAW VALUE (dBuV)	CORRECTION FACTOR (dB/m)
1	*2462.00	108.4 PK			1.68 V	95	74.60	33.80
2	*2462.00	103.7 AV			1.68 V	95	69.90	33.80
3	2483.50	60.1 PK	74.0	-13.9	1.68 V	95	26.30	33.80
4	2483.50	48.2 AV	54.0	-5.8	1.68 V	95	14.40	33.80
5	4924.00	56.2 PK	74.0	-17.8	1.05 V	199	16.00	40.20
6	4924.00	52.0 AV	54.0	-2.0	1.05 V	199	11.80	40.20

- REMARKS:**
1. Emission level (dBuV/m) = Raw Value (dBuV) + Correction Factor (dB/m).
 2. Correction Factor (dB/m) = Antenna Factor (dB/m) + Cable Factor (dB).
 3. The other emission levels were very low against the limit.
 4. Margin value = Emission level – Limit value.
 5. “ * “: Fundamental frequency.



A D T

802.11g

EUT TEST CONDITION		MEASUREMENT DETAIL	
CHANNEL	Channel 1	FREQUENCY RANGE	1 ~ 25GHz
INPUT POWER	120Vac, 60 Hz	DETECTOR FUNCTION	Peak (PK) Average (AV)
ENVIRONMENTAL CONDITIONS	25deg. C, 65%RH	TESTED BY	Long Chen

ANTENNA POLARITY & TEST DISTANCE: HORIZONTAL AT 3 M								
NO.	FREQ. (MHz)	EMISSION LEVEL (dBuV/m)	LIMIT (dBuV/m)	MARGIN (dB)	ANTENNA HEIGHT (m)	TABLE ANGLE (Degree)	RAW VALUE (dBuV)	CORRECTION FACTOR (dB/m)
1	2390.00	67.2 PK	74.0	-6.8	1.32 H	128	33.70	33.50
2	2390.00	51.8 AV	54.0	-2.2	1.32 H	128	18.30	33.50
3	*2412.00	103.1 PK			1.32 H	128	69.50	33.60
4	*2412.00	92.0 AV			1.32 H	128	58.40	33.60
5	4824.00	61.8 PK	74.0	-12.2	1.58 H	89	21.80	40.00
6	4824.00	47.7 AV	54.0	-6.3	1.58 H	89	7.70	40.00

ANTENNA POLARITY & TEST DISTANCE: VERTICAL AT 3 M								
NO.	FREQ. (MHz)	EMISSION LEVEL (dBuV/m)	LIMIT (dBuV/m)	MARGIN (dB)	ANTENNA HEIGHT (m)	TABLE ANGLE (Degree)	RAW VALUE (dBuV)	CORRECTION FACTOR (dB/m)
1	2390.00	68.9 PK	74.0	-5.1	1.18 V	233	35.40	33.50
2	2390.00	52.8 AV	54.0	-1.2	1.18 V	233	19.30	33.50
3	*2412.00	111.3 PK			1.18 V	233	77.70	33.60
4	*2412.00	100.6 AV			1.18 V	233	67.00	33.60
5	4824.00	59.4 PK	74.0	-14.6	1.55 V	328	19.40	40.00
6	4824.00	44.8 AV	54.0	-9.2	1.55 V	328	4.80	40.00

- REMARKS:**
1. Emission level (dBuV/m) = Raw Value (dBuV) + Correction Factor (dB/m).
 2. Correction Factor (dB/m) = Antenna Factor (dB/m) + Cable Factor (dB).
 3. The other emission levels were very low against the limit.
 4. Margin value = Emission level – Limit value.
 5. “ * “: Fundamental frequency.



A D T

EUT TEST CONDITION		MEASUREMENT DETAIL	
CHANNEL	Channel 6	FREQUENCY RANGE	1 ~ 25GHz
INPUT POWER	120Vac, 60 Hz	DETECTOR FUNCTION	Peak (PK) Average (AV)
ENVIRONMENTAL CONDITIONS	25deg. C, 65%RH	TESTED BY	Long Chen

ANTENNA POLARITY & TEST DISTANCE: HORIZONTAL AT 3 M								
NO.	FREQ. (MHz)	EMISSION LEVEL (dBuV/m)	LIMIT (dBuV/m)	MARGIN (dB)	ANTENNA HEIGHT (m)	TABLE ANGLE (Degree)	RAW VALUE (dBuV)	CORRECTION FACTOR (dB/m)
1	2390.00	63.5 PK	74.0	-10.5	1.35 H	101	30.00	33.50
2	2390.00	49.7 AV	54.0	-4.3	1.35 H	101	16.20	33.50
3	*2437.00	106.6 PK			1.35 H	101	72.90	33.70
4	*2437.00	96.0 AV			1.35 H	101	62.30	33.70
5	2483.50	59.1 PK	74.0	-14.9	1.35 H	101	25.30	33.80
6	2483.50	48.4 AV	54.0	-5.6	1.35 H	101	14.60	33.80
7	4874.00	65.9 PK	74.0	-8.1	1.13 H	80	25.80	40.10
8	4874.00	52.1 AV	54.0	-1.9	1.13 H	80	12.00	40.10
ANTENNA POLARITY & TEST DISTANCE: VERTICAL AT 3 M								
NO.	FREQ. (MHz)	EMISSION LEVEL (dBuV/m)	LIMIT (dBuV/m)	MARGIN (dB)	ANTENNA HEIGHT (m)	TABLE ANGLE (Degree)	RAW VALUE (dBuV)	CORRECTION FACTOR (dB/m)
1	2390.00	67.8 PK	74.0	-6.2	1.17 V	196	34.30	33.50
2	2390.00	52.9 AV	54.0	-1.1	1.17 V	196	19.40	33.50
3	*2437.00	114.7 PK			1.13 V	145	81.00	33.70
4	*2437.00	104.1 AV			1.13 V	145	70.40	33.70
5	2483.50	63.8 PK	74.0	-10.2	1.17 V	196	30.00	33.80
6	2483.50	50.6 AV	54.0	-3.4	1.17 V	196	16.80	33.80
7	4874.00	63.8 PK	74.0	-10.2	1.59 V	153	23.70	40.10
8	4874.00	50.1 AV	54.0	-3.9	1.59 V	153	10.00	40.10

- REMARKS:**
1. Emission level (dBuV/m) = Raw Value (dBuV) + Correction Factor (dB/m).
 2. Correction Factor (dB/m) = Antenna Factor (dB/m) + Cable Factor (dB).
 3. The other emission levels were very low against the limit.
 4. Margin value = Emission level – Limit value.
 5. “ * “: Fundamental frequency.



A D T

EUT TEST CONDITION		MEASUREMENT DETAIL	
CHANNEL	Channel 11	FREQUENCY RANGE	1 ~ 25GHz
INPUT POWER	120Vac, 60 Hz	DETECTOR FUNCTION	Peak (PK) Average (AV)
ENVIRONMENTAL CONDITIONS	25deg. C, 65%RH	TESTED BY	Long Chen

ANTENNA POLARITY & TEST DISTANCE: HORIZONTAL AT 3 M								
NO.	FREQ. (MHz)	EMISSION LEVEL (dBuV/m)	LIMIT (dBuV/m)	MARGIN (dB)	ANTENNA HEIGHT (m)	TABLE ANGLE (Degree)	RAW VALUE (dBuV)	CORRECTION FACTOR (dB/m)
1	*2462.00	102.6 PK			1.30 H	130	68.80	33.80
2	*2462.00	91.4 AV			1.30 H	130	57.60	33.80
3	2483.50	66.5 PK	74.0	-7.5	1.30 H	129	32.70	33.80
4	2483.50	51.2 AV	54.0	-2.8	1.30 H	129	17.40	33.80
5	4924.00	62.9 PK	74.0	-11.1	1.53 H	70	22.70	40.20
6	4924.00	49.1 AV	54.0	-4.9	1.53 H	70	8.90	40.20

ANTENNA POLARITY & TEST DISTANCE: VERTICAL AT 3 M								
NO.	FREQ. (MHz)	EMISSION LEVEL (dBuV/m)	LIMIT (dBuV/m)	MARGIN (dB)	ANTENNA HEIGHT (m)	TABLE ANGLE (Degree)	RAW VALUE (dBuV)	CORRECTION FACTOR (dB/m)
1	*2462.00	111.0 PK			1.44 V	199	77.20	33.80
2	*2462.00	100.4 AV			1.44 V	199	66.60	33.80
3	2483.50	68.7 PK	74.0	-5.3	1.44 V	199	34.90	33.80
4	2483.50	52.7 AV	54.0	-1.3	1.44 V	199	18.90	33.80
5	4924.00	61.8 PK	74.0	-12.2	1.18 V	189	21.60	40.20
6	4924.00	47.9 AV	54.0	-6.1	1.18 V	189	7.70	40.20

- REMARKS:**
1. Emission level (dBuV/m) = Raw Value (dBuV) + Correction Factor (dB/m).
 2. Correction Factor (dB/m) = Antenna Factor (dB/m) + Cable Factor (dB).
 3. The other emission levels were very low against the limit.
 4. Margin value = Emission level – Limit value.
 5. “ * “: Fundamental frequency.



A D T

802.11n (20MHz)

EUT TEST CONDITION		MEASUREMENT DETAIL	
CHANNEL	Channel 1	FREQUENCY RANGE	1 ~ 25GHz
INPUT POWER	120Vac, 60 Hz	DETECTOR FUNCTION	Peak (PK) Average (AV)
ENVIRONMENTAL CONDITIONS	25deg. C, 65%RH	TESTED BY	Long Chen

ANTENNA POLARITY & TEST DISTANCE: HORIZONTAL AT 3 M								
NO.	FREQ. (MHz)	EMISSION LEVEL (dBuV/m)	LIMIT (dBuV/m)	MARGIN (dB)	ANTENNA HEIGHT (m)	TABLE ANGLE (Degree)	RAW VALUE (dBuV)	CORRECTION FACTOR (dB/m)
1	2390.00	64.3 PK	74.0	-9.7	1.39 H	146	30.80	33.50
2	2390.00	49.8 AV	54.0	-4.2	1.39 H	146	16.30	33.50
3	*2412.00	102.9 PK			1.39 H	146	69.30	33.60
4	*2412.00	92.5 AV			1.39 H	146	58.90	33.60
5	4824.00	60.6 PK	74.0	-13.4	1.16 H	76	20.60	40.00
6	4824.00	47.0 AV	54.0	-7.0	1.16 H	76	7.00	40.00

ANTENNA POLARITY & TEST DISTANCE: VERTICAL AT 3 M								
NO.	FREQ. (MHz)	EMISSION LEVEL (dBuV/m)	LIMIT (dBuV/m)	MARGIN (dB)	ANTENNA HEIGHT (m)	TABLE ANGLE (Degree)	RAW VALUE (dBuV)	CORRECTION FACTOR (dB/m)
1	2390.00	69.9 PK	74.0	-4.1	1.19 V	180	36.40	33.50
2	2390.00	52.7 AV	54.0	-1.3	1.19 V	180	19.20	33.50
3	*2412.00	111.4 PK			1.19 V	180	77.80	33.60
4	*2412.00	100.9 AV			1.19 V	180	67.30	33.60
5	4824.00	59.5 PK	74.0	-14.5	1.44 V	150	19.50	40.00
6	4824.00	45.4 AV	54.0	-8.6	1.44 V	150	5.40	40.00

- REMARKS:**
1. Emission level (dBuV/m) = Raw Value (dBuV) + Correction Factor (dB/m).
 2. Correction Factor (dB/m) = Antenna Factor (dB/m) + Cable Factor (dB).
 3. The other emission levels were very low against the limit.
 4. Margin value = Emission level – Limit value.
 5. “ * “: Fundamental frequency.



A D T

EUT TEST CONDITION		MEASUREMENT DETAIL	
CHANNEL	Channel 6	FREQUENCY RANGE	1 ~ 25GHz
INPUT POWER	120Vac, 60 Hz	DETECTOR FUNCTION	Peak (PK) Average (AV)
ENVIRONMENTAL CONDITIONS	25deg. C, 65%RH	TESTED BY	Long Chen

ANTENNA POLARITY & TEST DISTANCE: HORIZONTAL AT 3 M								
NO.	FREQ. (MHz)	EMISSION LEVEL (dBuV/m)	LIMIT (dBuV/m)	MARGIN (dB)	ANTENNA HEIGHT (m)	TABLE ANGLE (Degree)	RAW VALUE (dBuV)	CORRECTION FACTOR (dB/m)
1	2390.00	62.9 PK	74.0	-11.1	1.30 H	206	29.40	33.50
2	2390.00	48.8 AV	54.0	-5.2	1.30 H	206	15.30	33.50
3	*2437.00	106.4 PK			2.06 H	100	72.70	33.70
4	*2437.00	95.6 AV			2.06 H	100	61.90	33.70
5	4874.00	66.7 PK	74.0	-7.3	1.55 H	74	26.60	40.10
6	4874.00	52.9 AV	54.0	-1.1	1.55 H	74	12.80	40.10
ANTENNA POLARITY & TEST DISTANCE: VERTICAL AT 3 M								
NO.	FREQ. (MHz)	EMISSION LEVEL (dBuV/m)	LIMIT (dBuV/m)	MARGIN (dB)	ANTENNA HEIGHT (m)	TABLE ANGLE (Degree)	RAW VALUE (dBuV)	CORRECTION FACTOR (dB/m)
1	2390.00	65.2 PK	74.0	-8.8	1.15 V	92	31.70	33.50
2	2390.00	52.8 AV	54.0	-1.2	1.15 V	92	19.30	33.50
3	*2437.00	114.1 PK			1.15 V	200	80.40	33.70
4	*2437.00	103.2 AV			1.15 V	200	69.50	33.70
5	4874.00	64.9 PK	74.0	-9.1	1.06 V	189	24.80	40.10
6	4874.00	51.4 AV	54.0	-2.6	1.06 V	189	11.30	40.10

- REMARKS:**
1. Emission level (dBuV/m) = Raw Value (dBuV) + Correction Factor (dB/m).
 2. Correction Factor (dB/m) = Antenna Factor (dB/m) + Cable Factor (dB).
 3. The other emission levels were very low against the limit.
 4. Margin value = Emission level – Limit value.
 5. “ * ”: Fundamental frequency.



A D T

EUT TEST CONDITION		MEASUREMENT DETAIL	
CHANNEL	Channel 11	FREQUENCY RANGE	1 ~ 25GHz
INPUT POWER	120Vac, 60 Hz	DETECTOR FUNCTION	Peak (PK) Average (AV)
ENVIRONMENTAL CONDITIONS	25deg. C, 65%RH	TESTED BY	Long Chen

ANTENNA POLARITY & TEST DISTANCE: HORIZONTAL AT 3 M								
NO.	FREQ. (MHz)	EMISSION LEVEL (dBuV/m)	LIMIT (dBuV/m)	MARGIN (dB)	ANTENNA HEIGHT (m)	TABLE ANGLE (Degree)	RAW VALUE (dBuV)	CORRECTION FACTOR (dB/m)
1	*2462.00	101.7 PK			1.00 H	131	67.90	33.80
2	*2462.00	91.0 AV			1.00 H	131	57.20	33.80
3	2483.50	67.8 PK	74.0	-6.2	1.49 H	243	34.00	33.80
4	2483.50	49.8 AV	54.0	-4.2	1.49 H	243	16.00	33.80
5	4924.00	58.1 PK	74.0	-15.9	1.70 H	64	17.90	40.20
6	4924.00	43.9 AV	54.0	-10.1	1.70 H	64	3.70	40.20
ANTENNA POLARITY & TEST DISTANCE: VERTICAL AT 3 M								
NO.	FREQ. (MHz)	EMISSION LEVEL (dBuV/m)	LIMIT (dBuV/m)	MARGIN (dB)	ANTENNA HEIGHT (m)	TABLE ANGLE (Degree)	RAW VALUE (dBuV)	CORRECTION FACTOR (dB/m)
1	*2462.00	109.9 PK			1.10 V	102	76.10	33.80
2	*2462.00	99.1 AV			1.10 V	102	65.30	33.80
3	2483.50	70.2 PK	74.0	-3.8	1.62 V	94	36.40	33.80
4	2483.50	52.8 AV	54.0	-1.2	1.62 V	94	19.00	33.80
5	4824.00	56.6 PK	74.0	-17.4	1.00 V	155	16.60	40.00
6	4824.00	41.3 AV	54.0	-12.7	1.00 V	155	1.30	40.00

- REMARKS:**
1. Emission level (dBuV/m) = Raw Value (dBuV) + Correction Factor (dB/m).
 2. Correction Factor (dB/m) = Antenna Factor (dB/m) + Cable Factor (dB).
 3. The other emission levels were very low against the limit.
 4. Margin value = Emission level – Limit value.
 5. “ * “: Fundamental frequency.



A D T

802.11n (40MHz)

EUT TEST CONDITION		MEASUREMENT DETAIL	
CHANNEL	Channel 1	FREQUENCY RANGE	1 ~ 25GHz
INPUT POWER	120Vac, 60 Hz	DETECTOR FUNCTION	Peak (PK) Average (AV)
ENVIRONMENTAL CONDITIONS	25deg. C, 65%RH	TESTED BY	Long Chen

ANTENNA POLARITY & TEST DISTANCE: HORIZONTAL AT 3 M								
NO.	FREQ. (MHz)	EMISSION LEVEL (dBuV/m)	LIMIT (dBuV/m)	MARGIN (dB)	ANTENNA HEIGHT (m)	TABLE ANGLE (Degree)	RAW VALUE (dBuV)	CORRECTION FACTOR (dB/m)
1	2390.00	61.9 PK	74.0	-12.1	1.00 H	162	28.40	33.50
2	2390.00	49.3 AV	54.0	-4.7	1.00 H	162	15.80	33.50
3	*2422.00	95.6 PK			1.27 H	249	62.00	33.60
4	*2422.00	84.5 AV			1.27 H	249	50.90	33.60
5	4844.00	55.7 PK	74.0	-18.3	1.11 H	60	15.70	40.00
6	4844.00	42.9 AV	54.0	-11.1	1.11 H	60	2.90	40.00
ANTENNA POLARITY & TEST DISTANCE: VERTICAL AT 3 M								
NO.	FREQ. (MHz)	EMISSION LEVEL (dBuV/m)	LIMIT (dBuV/m)	MARGIN (dB)	ANTENNA HEIGHT (m)	TABLE ANGLE (Degree)	RAW VALUE (dBuV)	CORRECTION FACTOR (dB/m)
1	2390.00	68.0 PK	74.0	-6.0	1.00 V	202	34.50	33.50
2	2390.00	53.0 AV	54.0	-1.0	1.00 V	202	19.50	33.50
3	*2422.00	103.2 PK			1.14 V	333	69.60	33.60
4	*2422.00	92.6 AV			1.14 V	333	59.00	33.60
5	4844.00	51.0 PK	74.0	-23.0	1.00 V	152	11.00	40.00
6	4844.00	36.7 AV	54.0	-17.3	1.00 V	152	-3.30	40.00

- REMARKS:**
1. Emission level (dBuV/m) = Raw Value (dBuV) + Correction Factor (dB/m).
 2. Correction Factor (dB/m) = Antenna Factor (dB/m) + Cable Factor (dB).
 3. The other emission levels were very low against the limit.
 4. Margin value = Emission level – Limit value.
 5. “ * “: Fundamental frequency.



A D T

EUT TEST CONDITION		MEASUREMENT DETAIL	
CHANNEL	Channel 4	FREQUENCY RANGE	1 ~ 25GHz
INPUT POWER	120Vac, 60 Hz	DETECTOR FUNCTION	Peak (PK) Average (AV)
ENVIRONMENTAL CONDITIONS	25deg. C, 65%RH	TESTED BY	Long Chen

ANTENNA POLARITY & TEST DISTANCE: HORIZONTAL AT 3 M								
NO.	FREQ. (MHz)	EMISSION LEVEL (dBuV/m)	LIMIT (dBuV/m)	MARGIN (dB)	ANTENNA HEIGHT (m)	TABLE ANGLE (Degree)	RAW VALUE (dBuV)	CORRECTION FACTOR (dB/m)
1	2390.00	66.4 PK	74.0	-7.6	1.00 H	249	32.90	33.50
2	2390.00	49.8 AV	54.0	-4.2	1.00 H	249	16.30	33.50
3	*2437.00	98.1 PK			1.36 H	124	64.40	33.70
4	*2437.00	87.5 AV			1.36 H	124	53.80	33.70
5	4874.00	55.3 PK	74.0	-18.7	1.54 H	78	15.20	40.10
6	4874.00	42.9 AV	54.0	-11.1	1.54 H	78	2.80	40.10
ANTENNA POLARITY & TEST DISTANCE: VERTICAL AT 3 M								
NO.	FREQ. (MHz)	EMISSION LEVEL (dBuV/m)	LIMIT (dBuV/m)	MARGIN (dB)	ANTENNA HEIGHT (m)	TABLE ANGLE (Degree)	RAW VALUE (dBuV)	CORRECTION FACTOR (dB/m)
1	2390.00	68.1 PK	74.0	-5.9	1.12 V	99	34.60	33.50
2	2390.00	52.7 AV	54.0	-1.3	1.12 V	99	19.20	33.50
3	*2437.00	105.7 PK			1.17 V	205	72.00	33.70
4	*2437.00	95.2 AV			1.17 V	205	61.50	33.70
5	4874.00	46.4 PK	74.0	-27.6	1.36 V	257	6.30	40.10
6	4874.00	34.6 AV	54.0	-19.4	1.36 V	257	-5.50	40.10

- REMARKS:**
1. Emission level (dBuV/m) = Raw Value (dBuV) + Correction Factor (dB/m).
 2. Correction Factor (dB/m) = Antenna Factor (dB/m) + Cable Factor (dB).
 3. The other emission levels were very low against the limit.
 4. Margin value = Emission level – Limit value.
 5. “ * “: Fundamental frequency.



A D T

EUT TEST CONDITION		MEASUREMENT DETAIL	
CHANNEL	Channel 7	FREQUENCY RANGE	1 ~ 25GHz
INPUT POWER	120Vac, 60 Hz	DETECTOR FUNCTION	Peak (PK) Average (AV)
ENVIRONMENTAL CONDITIONS	25deg. C, 65%RH	TESTED BY	Long Chen

ANTENNA POLARITY & TEST DISTANCE: HORIZONTAL AT 3 M								
NO.	FREQ. (MHz)	EMISSION LEVEL (dBuV/m)	LIMIT (dBuV/m)	MARGIN (dB)	ANTENNA HEIGHT (m)	TABLE ANGLE (Degree)	RAW VALUE (dBuV)	CORRECTION FACTOR (dB/m)
1	*2452.00	95.1 PK			2.07 H	123	61.40	33.70
2	*2452.00	84.0 AV			2.07 H	123	50.30	33.70
3	2483.50	65.4 PK	74.0	-8.6	1.00 H	215	31.60	33.80
4	2483.50	50.7 AV	54.0	-3.3	1.00 H	215	16.90	33.80
5	4904.00	54.3 PK	74.0	-19.7	1.10 H	248	14.10	40.20
6	4904.00	38.4 AV	54.0	-15.6	1.10 H	248	-1.80	40.20

ANTENNA POLARITY & TEST DISTANCE: VERTICAL AT 3 M								
NO.	FREQ. (MHz)	EMISSION LEVEL (dBuV/m)	LIMIT (dBuV/m)	MARGIN (dB)	ANTENNA HEIGHT (m)	TABLE ANGLE (Degree)	RAW VALUE (dBuV)	CORRECTION FACTOR (dB/m)
1	*2452.00	102.3 PK			1.76 V	191	68.60	33.70
2	*2452.00	91.3 AV			1.76 V	191	57.60	33.70
3	2483.50	67.8 PK	74.0	-6.2	1.12 V	338	34.00	33.80
4	2483.50	52.7 AV	54.0	-1.3	1.12 V	338	18.90	33.80
5	4904.00	50.5 PK	74.0	-23.5	1.00 V	219	10.30	40.20
6	4904.00	36.0 AV	54.0	-18.0	1.00 V	219	-4.20	40.20

- REMARKS:**
1. Emission level (dBuV/m) = Raw Value (dBuV) + Correction Factor (dB/m).
 2. Correction Factor (dB/m) = Antenna Factor (dB/m) + Cable Factor (dB).
 3. The other emission levels were very low against the limit.
 4. Margin value = Emission level – Limit value.
 5. “ * “: Fundamental frequency.



A D T

BELOW 1GHz WORST-CASE DATA : 802.11n (20MHz)

EUT TEST CONDITION		MEASUREMENT DETAIL	
CHANNEL	Channel 6	FREQUENCY RANGE	Below 1000MHz
INPUT POWER	120Vac, 60 Hz	DETECTOR FUNCTION	Quasi-Peak
ENVIRONMENTAL CONDITIONS	25deg. C, 65%RH	TESTED BY	Long Chen

ANTENNA POLARITY & TEST DISTANCE: HORIZONTAL AT 3 M								
NO.	FREQ. (MHz)	EMISSION LEVEL (dBuV/m)	LIMIT (dBuV/m)	MARGIN (dB)	ANTENNA HEIGHT (m)	TABLE ANGLE (Degree)	RAW VALUE (dBuV)	CORRECTION FACTOR (dB/m)
1	125.17	32.9 QP	43.5	-10.6	1.50 H	262	20.70	12.20
2	249.60	37.5 QP	46.0	-8.5	1.25 H	109	23.00	14.50
3	319.60	39.2 QP	46.0	-6.8	1.00 H	136	23.70	15.50
4	640.41	36.0 QP	46.0	-10.0	1.25 H	334	11.00	25.00
5	747.34	39.9 QP	46.0	-6.1	1.25 H	118	12.60	27.30
6	881.50	41.4 QP	46.0	-4.6	1.00 H	214	11.40	30.00
ANTENNA POLARITY & TEST DISTANCE: VERTICAL AT 3 M								
NO.	FREQ. (MHz)	EMISSION LEVEL (dBuV/m)	LIMIT (dBuV/m)	MARGIN (dB)	ANTENNA HEIGHT (m)	TABLE ANGLE (Degree)	RAW VALUE (dBuV)	CORRECTION FACTOR (dB/m)
1	41.57	32.1 QP	40.0	-7.9	1.00 V	34	16.90	15.20
2	249.60	31.3 QP	46.0	-14.7	1.00 V	349	16.80	14.50
3	319.60	34.8 QP	46.0	-11.2	1.50 V	283	19.30	15.50
4	533.47	34.6 QP	46.0	-11.4	1.25 V	121	12.20	22.40
5	640.41	34.8 QP	46.0	-11.2	1.25 V	19	9.80	25.00
6	880.22	39.5 QP	46.0	-6.5	2.50 V	19	9.50	30.00

- REMARKS:**
1. Emission level (dBuV/m) = Raw Value (dBuV) + Correction Factor (dB/m).
 2. Correction Factor (dB/m) = Antenna Factor (dB/m) + Cable Factor (dB).
 3. The other emission levels were very low against the limit.
 4. Margin value = Emission level – Limit value.



A D T

4.2 CONDUCTED EMISSION MEASUREMENT

4.2.1 LIMITS OF CONDUCTED EMISSION MEASUREMENT

FREQUENCY OF EMISSION (MHz)	CONDUCTED LIMIT (dB μ V)	
	Quasi-peak	Average
0.15 ~ 0.5	66 to 56	56 to 46
0.5 ~ 5	56	46
5 ~ 30	60	50

- NOTE:** 1. The lower limit shall apply at the transition frequencies.
2. The limit decreases in line with the logarithm of the frequency in the range of 0.15 to 0.50MHz.
3. All emanations from a class A/B digital device or system, including any network of conductors and apparatus connected thereto, shall not exceed the level of field strengths specified above.

4.2.2 TEST INSTRUMENTS

DESCRIPTION & MANUFACTURER	MODEL NO.	SERIAL NO.	DATE OF CALIBRATION	DUE DATE OF CALIBRATION
Test Receiver ROHDE & SCHWARZ	ESCS30	100291	Dec. 16, 2009	Dec. 15, 2010
RF signal cable Woken	5D-FB	Cable-HYC01-01	Dec. 30, 2009	Dec. 29, 2010
LISN ROHDE & SCHWARZ	ESH3-Z5	100312	Jun. 28, 2010	Jun. 27, 2011
V-LISN SCHWARZBECK	NNBL 8226-2	8226-142	Jul. 12, 2010	Jul. 11, 2011
Software ADT	ADT_Cond_ V7.3.7	NA	NA	NA

- NOTE:** 1. The calibration interval of the above test instruments is 12 months and the calibrations are traceable to NML/ROC and NIST/USA.
2. The test was performed in HwaYa Shielded Room 1.
3. The VCCI Site Registration No. is C-2040.



A D T

4.2.3 TEST PROCEDURES

- a. The EUT was placed 0.4 meters from the conducting wall of the shielded room with EUT being connected to the power mains through a line impedance stabilization network (LISN). Other support units were connected to the power mains through another LISN. The two LISNs provide 50 ohm/ 50uH of coupling impedance for the measuring instrument.
- b. Both lines of the power mains connected to the EUT were checked for maximum conducted interference.
- c. The frequency range from 150kHz to 30MHz was searched. Emission levels under (Limit - 20dB) was not recorded.

NOTE: All modes of operation were investigated and the worst-case emissions are reported.

4.2.4 DEVIATION FROM TEST STANDARD

No deviation.

4.2.5 TEST SETUP

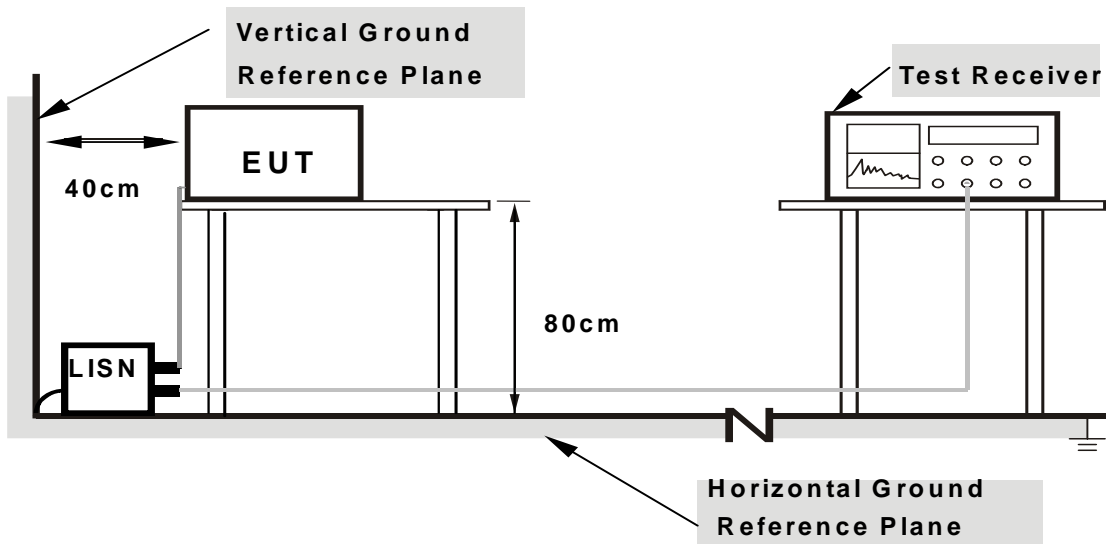

Note: 1. Support units were connected to second LISN.

2. Both of LISNs (AMN) are 80 cm from EUT and at least 80 from other units and other metal planes

For the actual test configuration, please refer to the attached file (Test Setup Photo).

4.2.6 EUT OPERATING CONDITIONS

Same as 4.1.6.

4.2.7 TEST RESULTS

CONDUCTED WORST-CASE DATA : 802.11n (20MHz)

PHASE	Line 1	6dB BANDWIDTH	9kHz
--------------	--------	----------------------	------

No	Freq. [MHz]	Corr. Factor (dB)	Reading Value		Emission Level		Limit		Margin	
			[dB (uV)]		[dB (uV)]		[dB (uV)]		(dB)	
			Q.P.	AV.	Q.P.	AV.	Q.P.	AV.	Q.P.	AV.
1	0.150	0.12	44.29	-	44.41	-	66.00	56.00	-21.59	-
2	0.353	0.13	30.33	-	30.46	-	58.89	48.89	-28.43	-
3	0.931	0.17	19.87	-	20.04	-	56.00	46.00	-35.96	-
4	1.773	0.23	18.90	-	19.13	-	56.00	46.00	-36.87	-
5	4.707	0.38	26.46	-	26.84	-	56.00	46.00	-29.16	-
6	14.211	0.99	22.89	-	23.88	-	60.00	50.00	-36.12	-

- REMARKS:**
1. Q.P. and AV. are abbreviations of quasi-peak and average individually.
 2. "-": The Quasi-peak reading value also meets average limit and measurement with the average detector is unnecessary.
 3. The emission levels of other frequencies were very low against the limit.
 4. Margin value = Emission level - Limit value
 5. Correction factor = Insertion loss + Cable loss
 6. Emission Level = Correction Factor + Reading Value.

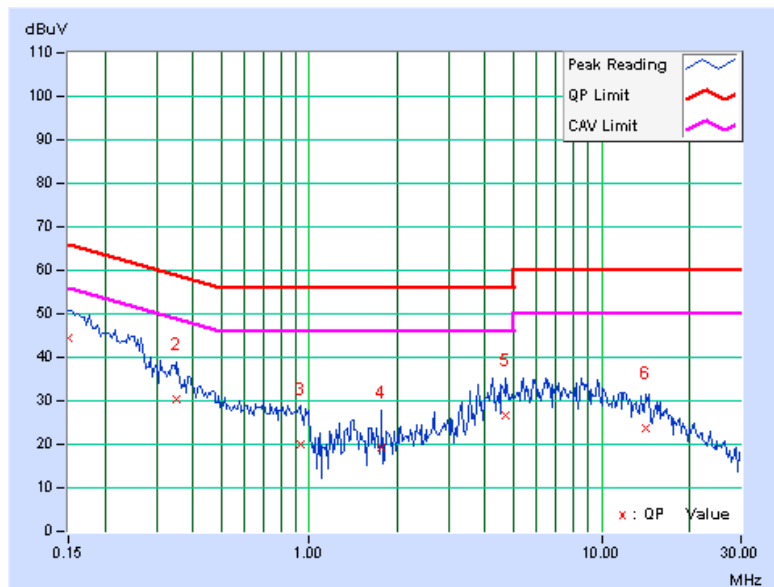

PHASE	Line 2	6dB BANDWIDTH	9kHz
-------	--------	---------------	------

No	Freq. [MHz]	Corr.	Reading Value		Emission Level		Limit		Margin	
		Factor	[dB (uV)]		[dB (uV)]		[dB (uV)]		(dB)	
		(dB)	Q.P.	AV.	Q.P.	AV.	Q.P.	AV.	Q.P.	AV.
1	0.150	0.10	43.67	-	43.77	-	66.00	56.00	-22.23	-
2	0.259	0.11	37.55	-	37.66	-	61.45	51.45	-23.80	-
3	0.982	0.17	21.63	-	21.80	-	56.00	46.00	-34.20	-
4	2.438	0.26	25.69	-	25.95	-	56.00	46.00	-30.05	-
5	5.113	0.36	30.09	-	30.45	-	60.00	50.00	-29.55	-
6	10.539	0.60	26.65	-	27.25	-	60.00	50.00	-32.75	-

- REMARKS:**
1. Q.P. and AV. are abbreviations of quasi-peak and average individually.
 2. "-": The Quasi-peak reading value also meets average limit and measurement with the average detector is unnecessary.
 3. The emission levels of other frequencies were very low against the limit.
 4. Margin value = Emission level - Limit value
 5. Correction factor = Insertion loss + Cable loss
 6. Emission Level = Correction Factor + Reading Value.

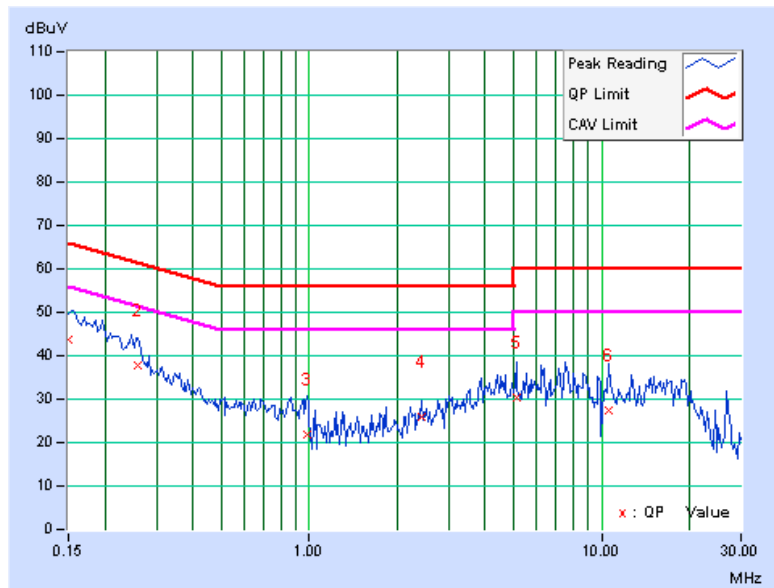



A D T

4.3 6dB BANDWIDTH MEASUREMENT

4.3.1 LIMITS OF 6dB BANDWIDTH MEASUREMENT

The minimum of 6dB Bandwidth Measurement is 0.5 MHz.

4.3.2 TEST INSTRUMENTS

DESCRIPTION & MANUFACTURER	MODEL NO.	SERIAL NO.	DATE OF CALIBRATION	DUE DATE OF CALIBRATION
SPECTRUM ANALYZER R&S	FSP40	100039	Jan. 11, 2010	Jan. 10, 2011

NOTE: The calibration interval of the above test instruments is 12 months and the calibrations are traceable to NML/ROC and NIST/USA.

4.3.3 TEST PROCEDURE

The transmitter output was connected to the spectrum analyzer through an attenuator. The bandwidth of the fundamental frequency was measured by spectrum analyzer with 100kHz RBW and 300kHz VBW. The 6dB bandwidth is defined as the total spectrum the power of which is higher than peak power minus 6dB.

4.3.4 DEVIATION FROM TEST STANDARD

No deviation.

4.3.5 TEST SETUP

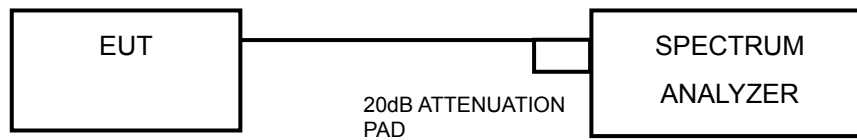

4.3.6 EUT OPERATING CONDITIONS

The software provided by client to enable the EUT under transmission condition continuously at lowest, middle and highest channel frequencies individually.



A D T

4.3.7 TEST RESULTS

802.11b

CHANNEL	CHANNEL FREQUENCY (MHz)	6dB BANDWIDTH (MHz)	MINIMUM LIMIT (MHz)	PASS / FAIL
1	2412	12.10	0.5	PASS
6	2437	11.20	0.5	PASS
11	2462	12.13	0.5	PASS

CH 11

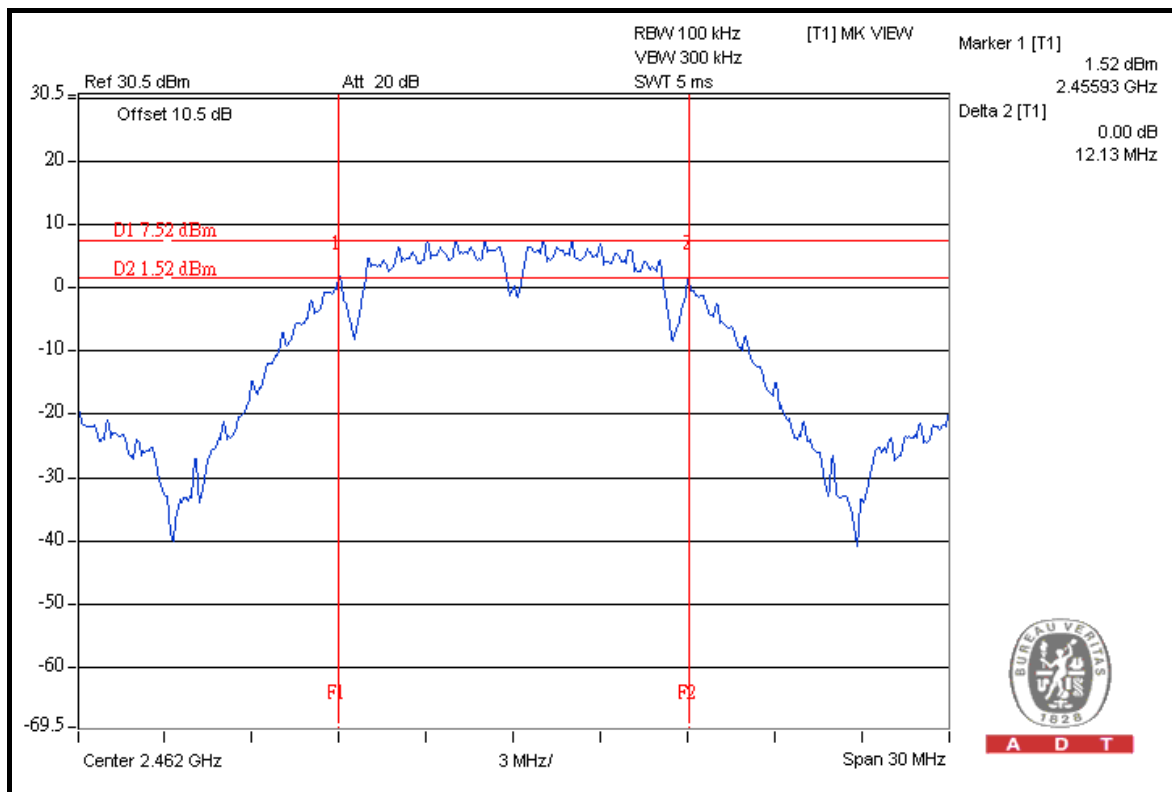



A D T

802.11g

CHANNEL	CHANNEL FREQUENCY (MHz)	6dB BANDWIDTH (MHz)	MINIMUM LIMIT (MHz)	PASS / FAIL
1	2412	16.39	0.5	PASS
6	2437	16.39	0.5	PASS
11	2462	16.42	0.5	PASS

CH 11

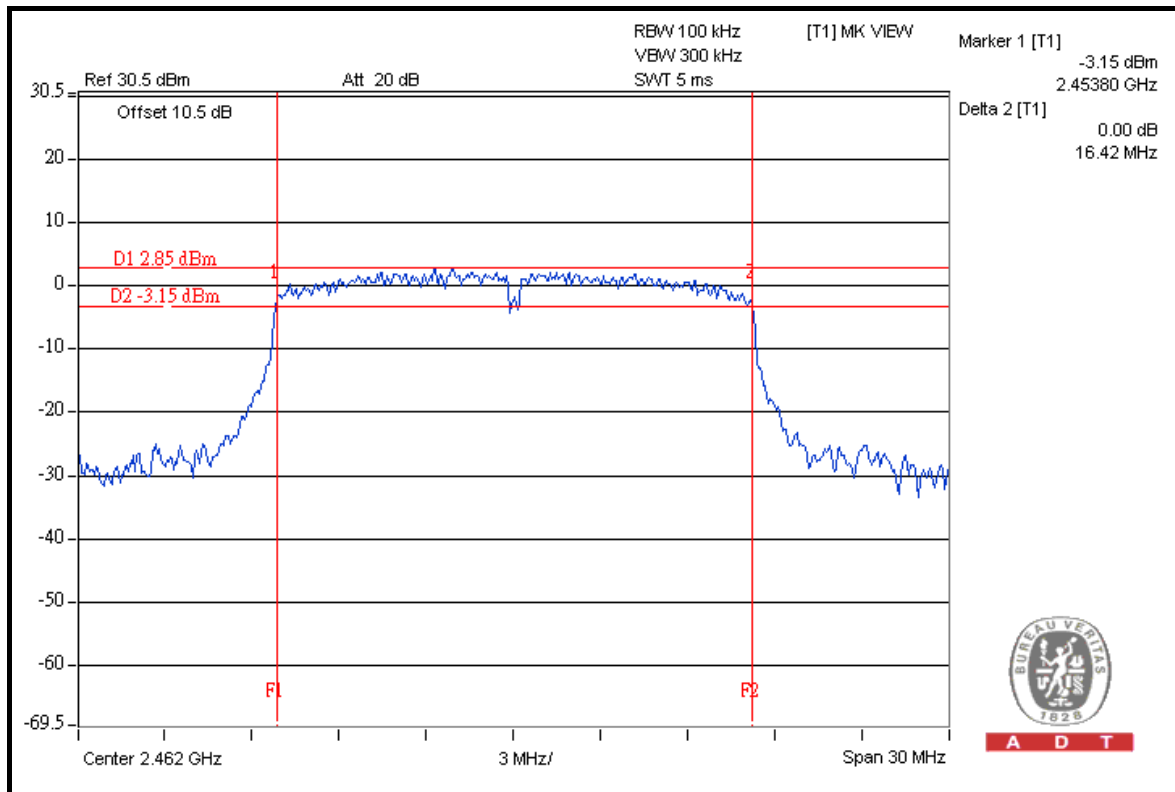



A D T

802.11n (20MHz)

CHANNEL	CHANNEL FREQUENCY (MHz)	6dB BANDWIDTH (MHz)	MINIMUM LIMIT (MHz)	PASS / FAIL
1	2412	16.40	0.5	PASS
6	2437	16.40	0.5	PASS
11	2462	16.41	0.5	PASS

CH 11

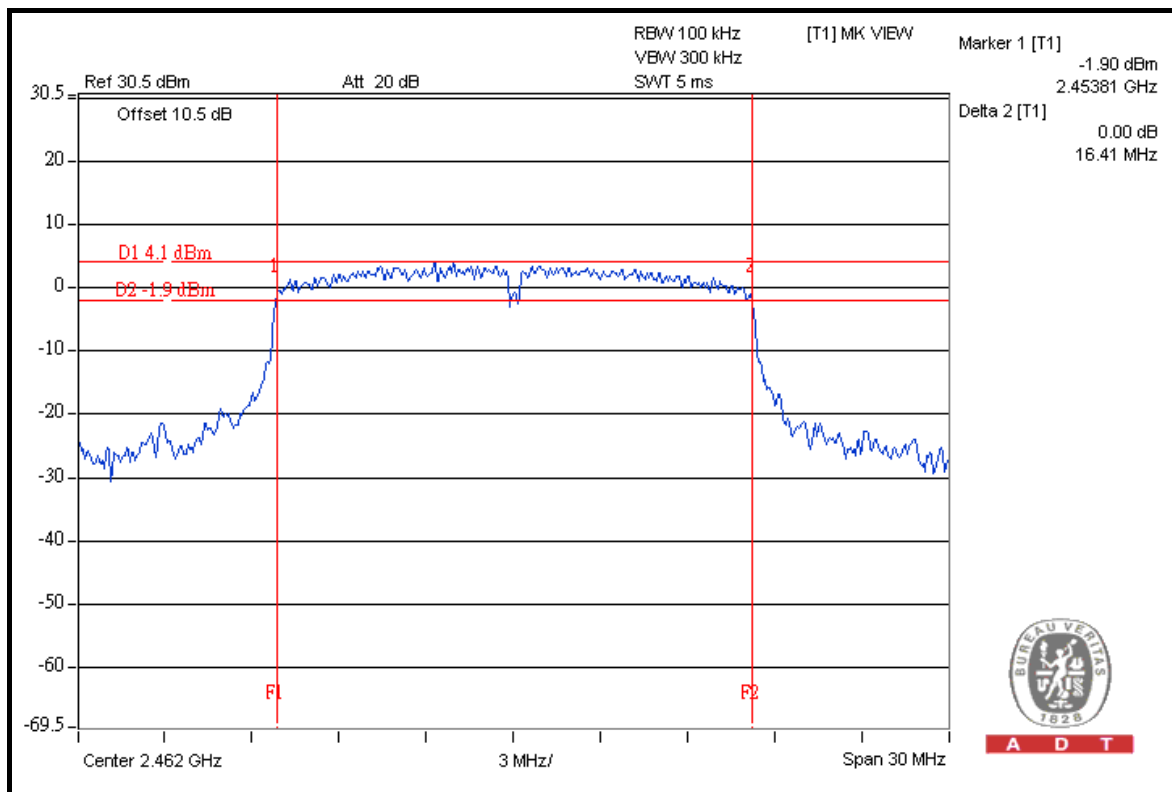



A D T

802.11n (40MHz)

CHANNEL	CHANNEL FREQUENCY (MHz)	6dB BANDWIDTH (MHz)	MINIMUM LIMIT (MHz)	PASS / FAIL
1	2422	36.45	0.5	PASS
4	2437	36.41	0.5	PASS
7	2452	36.42	0.5	PASS

CH 1

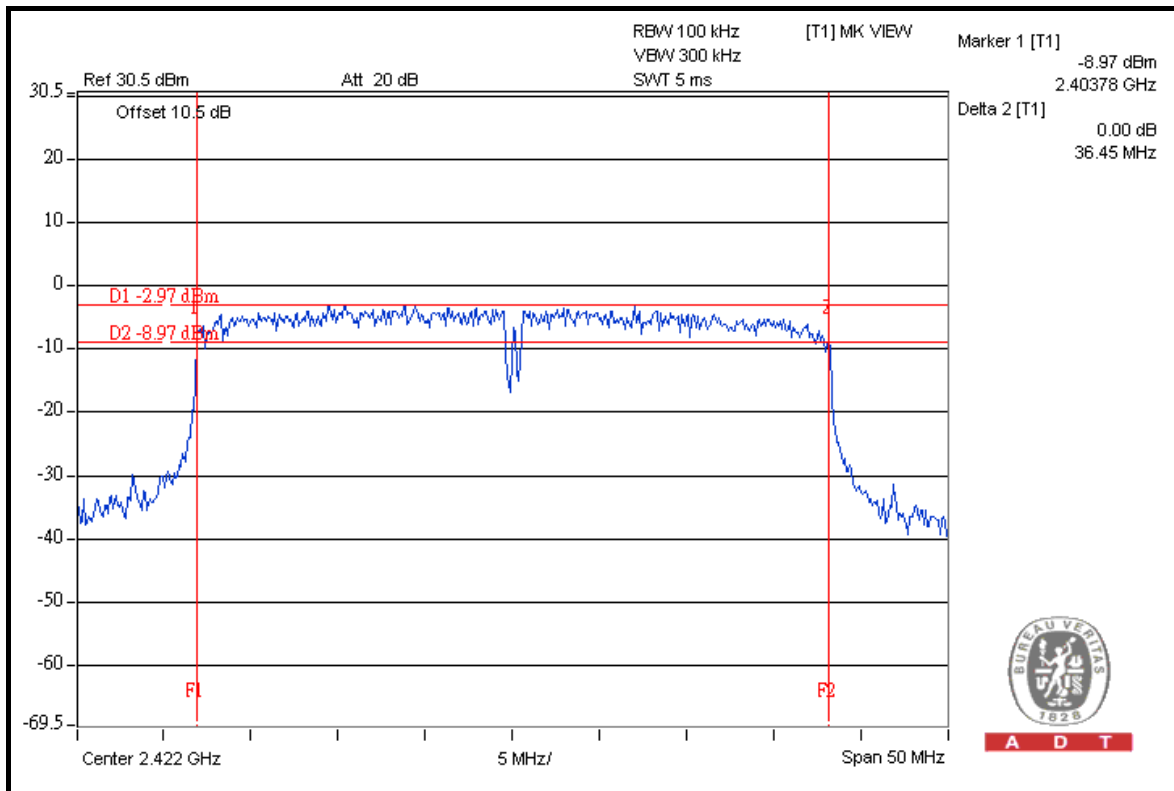

A D T



A D T

4.4 MAXIMUM OUTPUT POWER

4.4.1 LIMITS OF MAXIMUM OUTPUT POWER MEASUREMENT

The Maximum Output Power Measurement is 30dBm.

4.4.2 INSTRUMENTS

DESCRIPTION & MANUFACTURER	MODEL NO.	SERIAL NO.	DATE OF CALIBRATION	DUE DATE OF CALIBRATION
High Speed Peak Power Meter	ML2495A	0842014	Apr. 21, 2010	Apr. 20, 2011
Power Sensor	MA2411B	0738404	Apr. 21, 2010	Apr. 20, 2011

NOTE:

1. The calibration interval of the above test instruments is 12 months and the calibrations are traceable to NML/ROC and NIST/USA.
2. Measurement Bandwidth of ML2495A is 65MHz greater than 6dB bandwidth of emission.

4.4.3 TEST PROCEDURES

A power sensor was used on the output port of the EUT. A power meter was used to read the response of the power sensor. Record the power level.

4.4.4 DEVIATION FROM TEST STANDARD

No deviation.

4.4.5 TEST SETUP

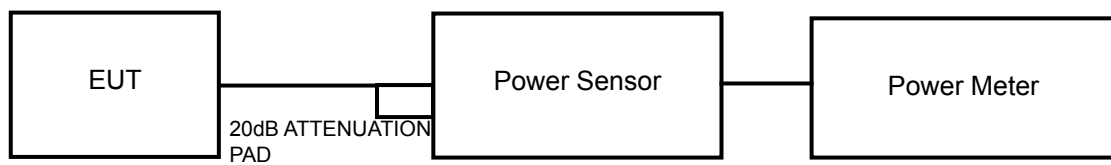

4.4.6 EUT OPERATING CONDITIONS

Same as Item 4.3.6.



4.4.7 TEST RESULTS

802.11b

CHANNEL	CHANNEL FREQUENCY (MHz)	POWER OUTPUT (mW)	POWER OUTPUT (dBm)	POWER LIMIT (dBm)	PASS/FAIL
1	2412	141.3	21.5	30	PASS
6	2437	123.0	20.9	30	PASS
11	2462	123.0	20.9	30	PASS

802.11g

CHANNEL	CHANNEL FREQUENCY (MHz)	POWER OUTPUT (mW)	POWER OUTPUT (dBm)	POWER LIMIT (dBm)	PASS/FAIL
1	2412	302.0	24.8	30	PASS
6	2437	354.8	25.5	30	PASS
11	2462	263.0	24.2	30	PASS

802.11n (20MHz)

CHANNEL	CHANNEL FREQUENCY (MHz)	POWER OUTPUT (mW)	POWER OUTPUT (dBm)	POWER LIMIT (dBm)	PASS/FAIL
1	2412	316.2	25.0	30	PASS
6	2437	380.2	25.8	30	PASS
11	2462	295.1	24.7	30	PASS

802.11n (40MHz)

CHANNEL	CHANNEL FREQUENCY (MHz)	POWER OUTPUT (mW)	POWER OUTPUT (dBm)	POWER LIMIT (dBm)	PASS/FAIL
1	2422	144.5	21.6	30	PASS
4	2437	257.0	24.1	30	PASS
7	2452	120.2	20.8	30	PASS

4.5 POWER SPECTRAL DENSITY MEASUREMENT

4.5.1 LIMITS OF POWER SPECTRAL DENSITY MEASUREMENT

The Maximum of Power Spectral Density Measurement is 8dBm.

4.5.2 TEST INSTRUMENTS

DESCRIPTION & MANUFACTURER	MODEL NO.	SERIAL NO.	DATE OF CALIBRATION	DUE DATE OF CALIBRATION
SPECTRUM ANALYZER R&S	FSP40	100039	Jan. 11, 2010	Jan. 10, 2011

NOTE: The calibration interval of the above test instruments is 12 months and the calibrations are traceable to NML/ROC and NIST/USA.

4.5.3 TEST PROCEDURE

The transmitter output was connected to the spectrum analyzer through an attenuator, the bandwidth of the fundamental frequency was measured with the spectrum analyzer using 3kHz RBW and 30kHz VBW, set sweep time = span/3kHz. The power spectral density was measured and recorded.

The sweep time is allowed to be longer than span/3kHz for a full response of the mixer in the spectrum analyzer.

4.5.4 DEVIATION FROM TEST STANDARD

No deviation.

4.5.5 TEST SETUP

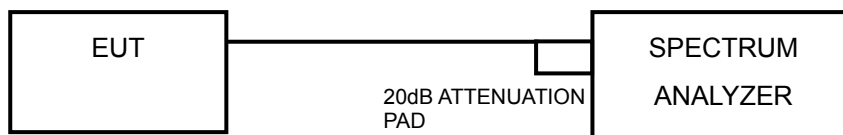

4.5.6 EUT OPERATING CONDITION

Same as Item 4.3.6.



A D T

4.5.7 TEST RESULTS

802.11b

CHANNEL	CHANNEL FREQUENCY (MHz)	RF POWER LEVEL IN 3 kHz BW (dBm)	MAXIMUM LIMIT (dBm)	PASS/FAIL
1	2412	-10.1	8	PASS
6	2437	-10.9	8	PASS
11	2462	-10.7	8	PASS

CH 1

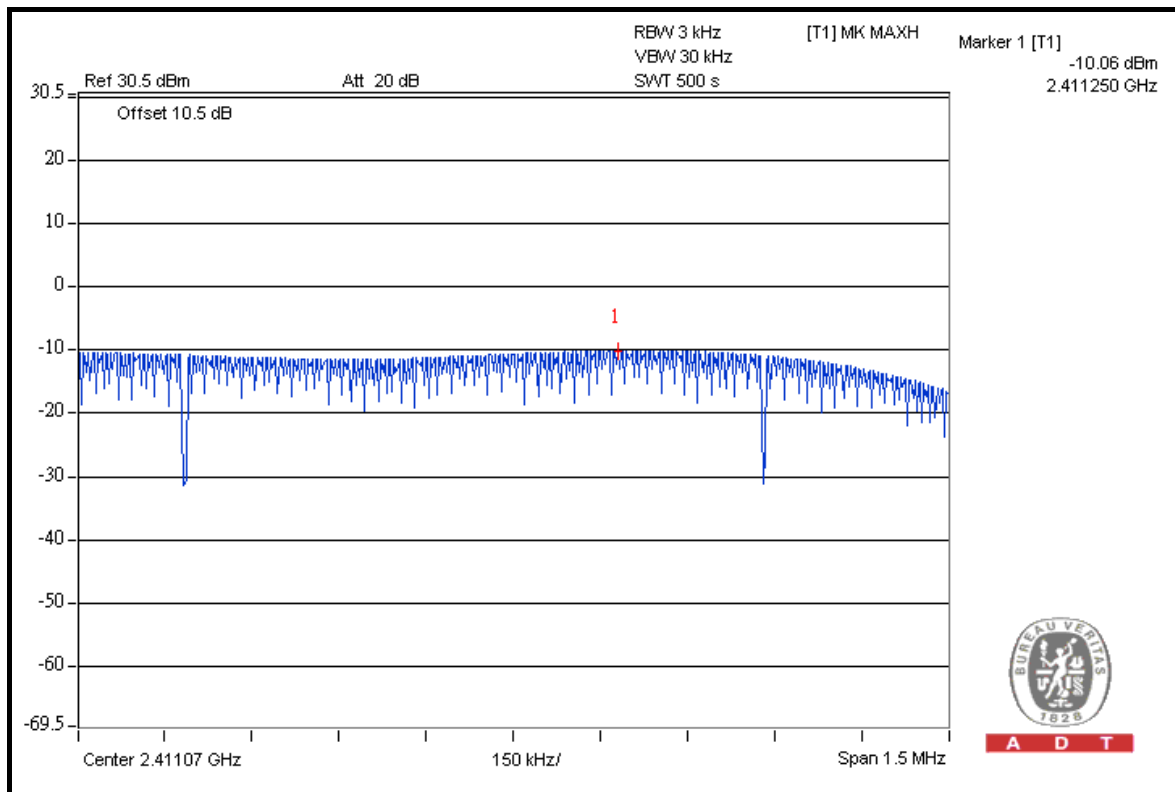



A D T

802.11g

CHANNEL	CHANNEL FREQUENCY (MHz)	RF POWER LEVEL IN 3 kHz BW (dBm)	MAXIMUM LIMIT (dBm)	PASS/FAIL
1	2412	-10.4	8	PASS
6	2437	-9.9	8	PASS
11	2462	-11.2	8	PASS

CH 6

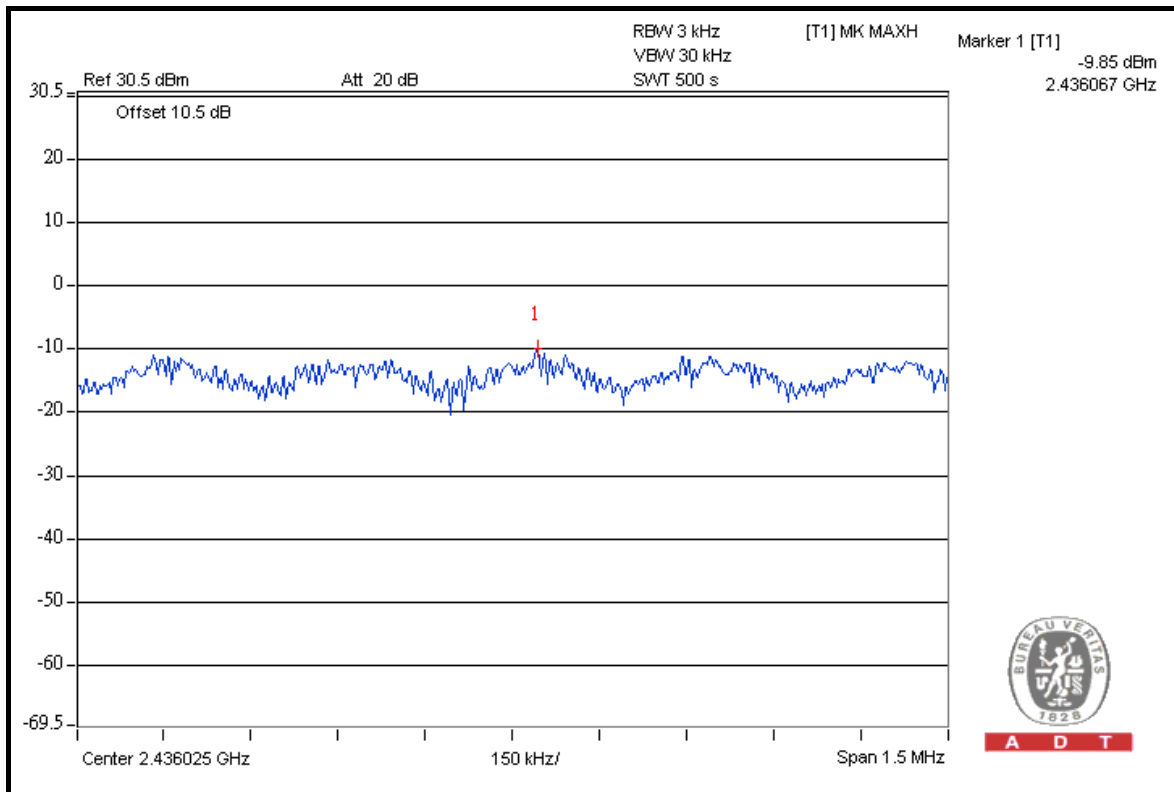



A D T

802.11n (20MHz)

CHANNEL	CHANNEL FREQUENCY (MHz)	RF POWER LEVEL IN 3 kHz BW (dBm)	MAXIMUM LIMIT (dBm)	PASS/FAIL
1	2412	-9.5	8	PASS
6	2437	-8.8	8	PASS
11	2462	-9.9	8	PASS

CH 6

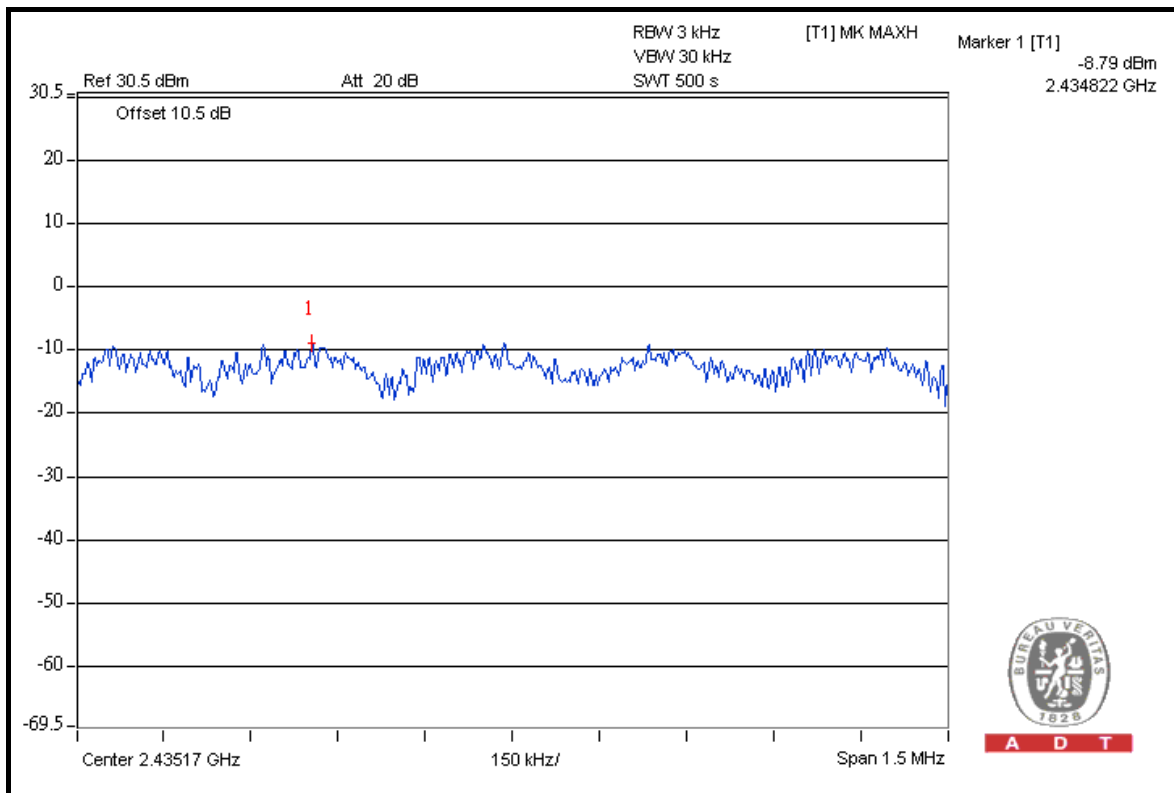



A D T

802.11n (40MHz)

CHANNEL	CHANNEL FREQUENCY (MHz)	RF POWER LEVEL IN 3 kHz BW (dBm)	MAXIMUM LIMIT (dBm)	PASS/FAIL
1	2422	-16.3	8	PASS
4	2437	-13.7	8	PASS
7	2452	-17.0	8	PASS

CH 4

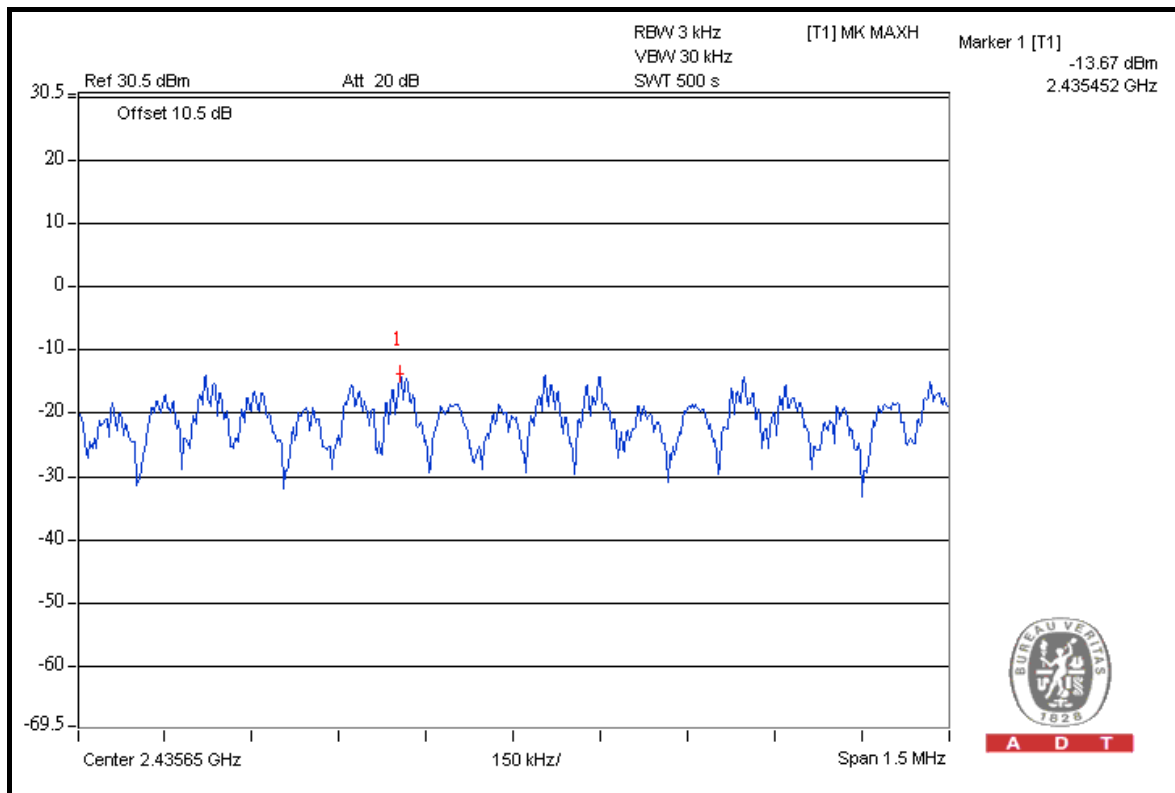



A D T

4.6 BAND EDGES MEASUREMENT

4.6.1 LIMITS OF BAND EDGES MEASUREMENT

Below -20dB of the highest emission level of operating band (in 100kHz Resolution Bandwidth).

4.6.2 TEST INSTRUMENTS

DESCRIPTION & MANUFACTURER	MODEL NO.	SERIAL NO.	DATE OF CALIBRATION	DUE DATE OF CALIBRATION
SPECTRUM ANALYZER R&S	FSP40	100039	Jan. 11, 2010	Jan. 10, 2011

NOTE: The calibration interval of the above test instruments is 12 months and the calibrations are traceable to NML/ROC and NIST/USA.

4.6.3 TEST PROCEDURE

The transmitter output was connected to the spectrum analyzer via a low loss cable. Set both RBW and VBW of spectrum analyzer to 100kHz with suitable frequency span including 300kHz bandwidth from band edge. The band edges was measured and recorded.

The spectrum plots (Peak RBW = 100kHz, VBW = 300kHz; Average RBW = 1MHz, VBW = 10Hz) are attached on the following pages.

4.6.4 DEVIATION FROM TEST STANDARD

No deviation.

4.6.5 EUT OPERATING CONDITION

Same as Item 4.3.6.



A D T

4.6.6 TEST RESULTS

The spectrum plots are attached on the following pages. D1 line indicates the highest level, and D2 line indicates the 20dB offset below D1. It shows compliance with the requirement in part 15.247(d).

802.11b

RESTRICT BAND (2310 ~ 2390 MHz)

FREQUENCY (MHz)	FUNDAMENTAL EMISSION (dBuV/m)	DELTA (dB)	MAXIMUM FIELD STRENGTH IN RESTRICT BAND (dBuV/m)	LIMIT (dBuV/m)
2412.00 (PK)	108.6	45.54	63.06	74.00
2412.00 (AV)	103.9	61.05	42.85	54.00

RESTRICT BAND (2483.5 ~ 2500 MHz)

FREQUENCY (MHz)	FUNDAMENTAL EMISSION (dBuV/m)	DELTA (dB)	MAXIMUM FIELD STRENGTH IN RESTRICT BAND (dBuV/m)	LIMIT (dBuV/m)
2462.00 (PK)	108.4	44.53	63.87	74.00
2462.00 (AV)	103.7	51.52	52.18	54.00

NOTE:

1. Delta = Amplitude between the peak of the fundamental and the peak of the band edge emission. Please check following 3 pages.
2. Maximum field strength in restrict band = Fundamental emission – Delta.



A D T

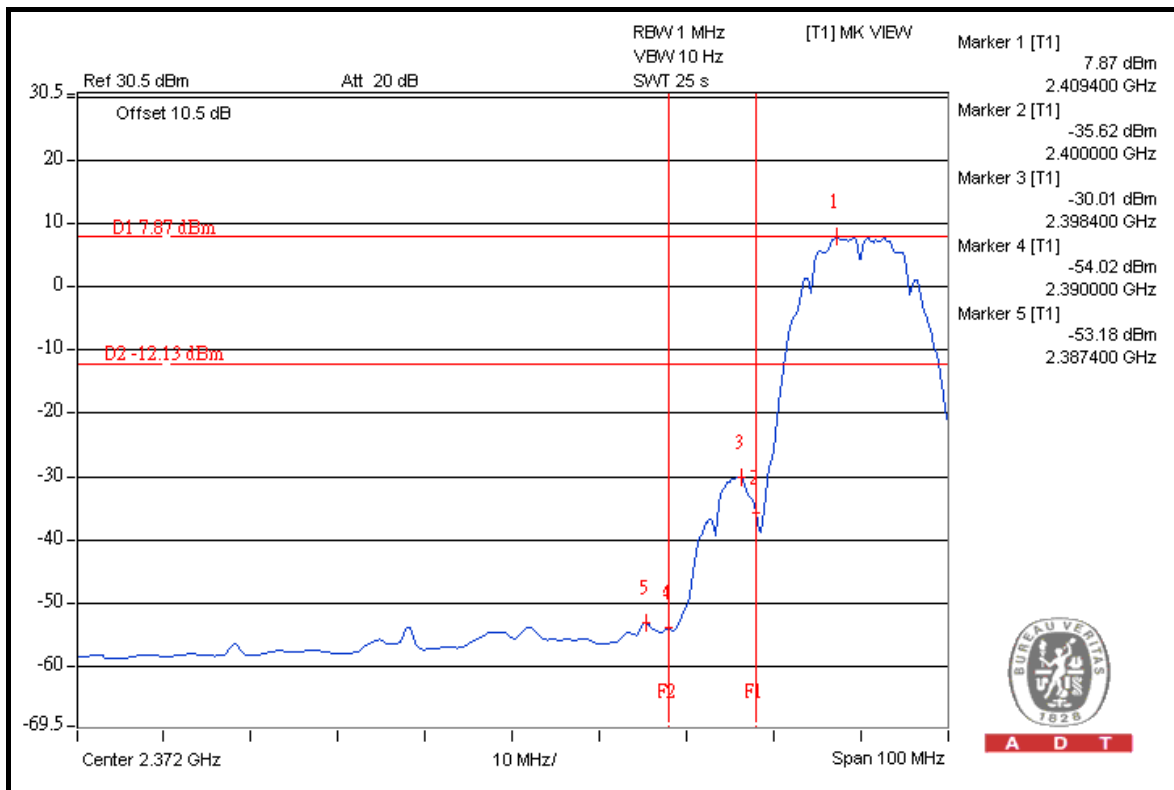
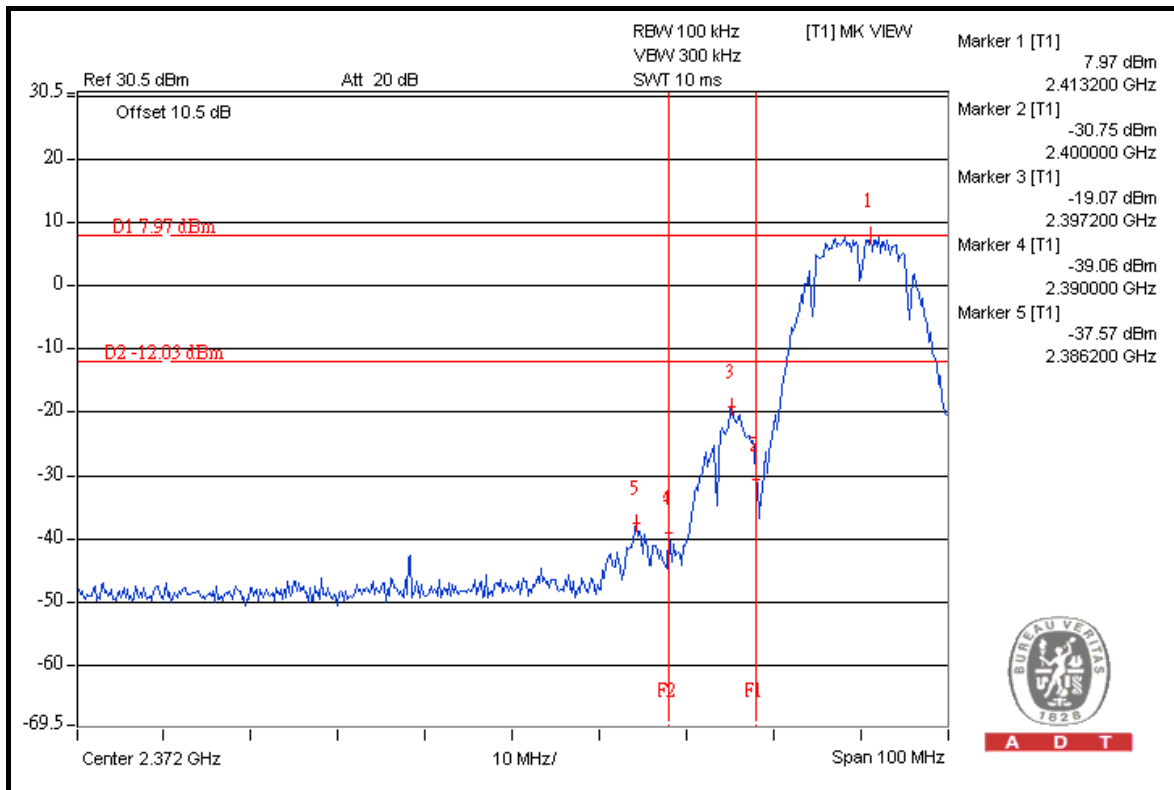



A D T

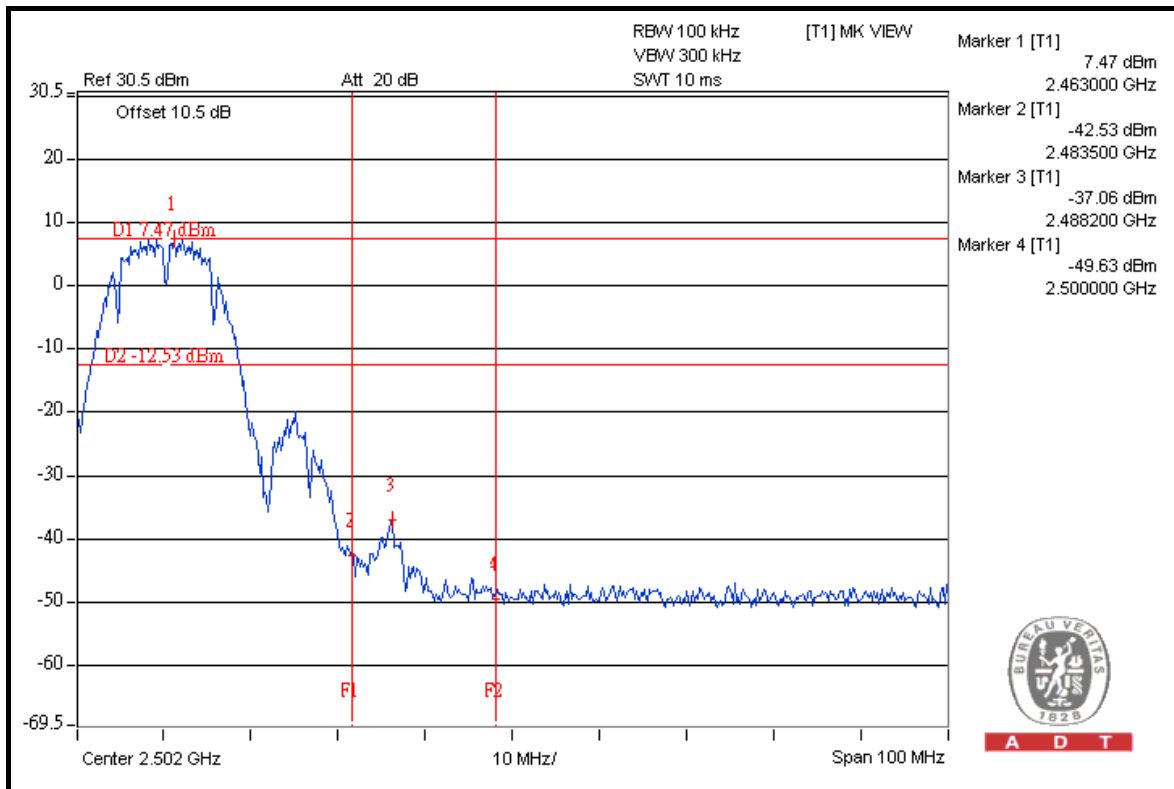
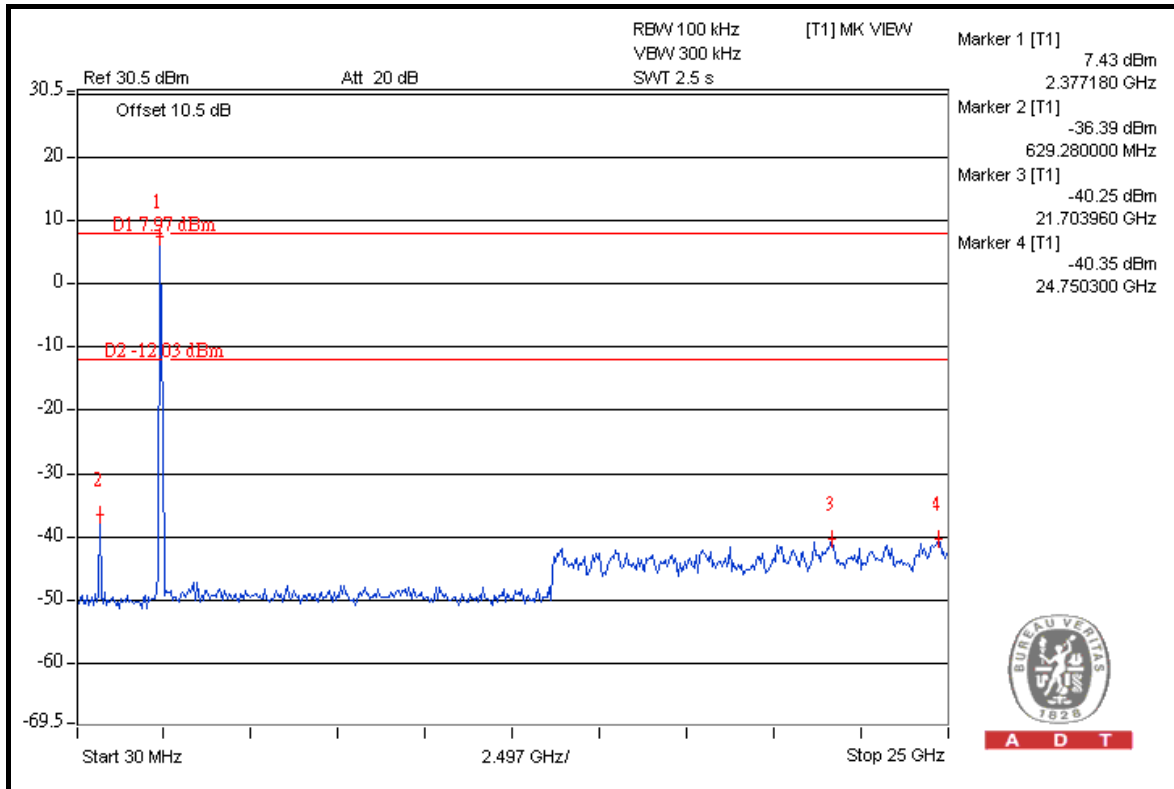



A D T

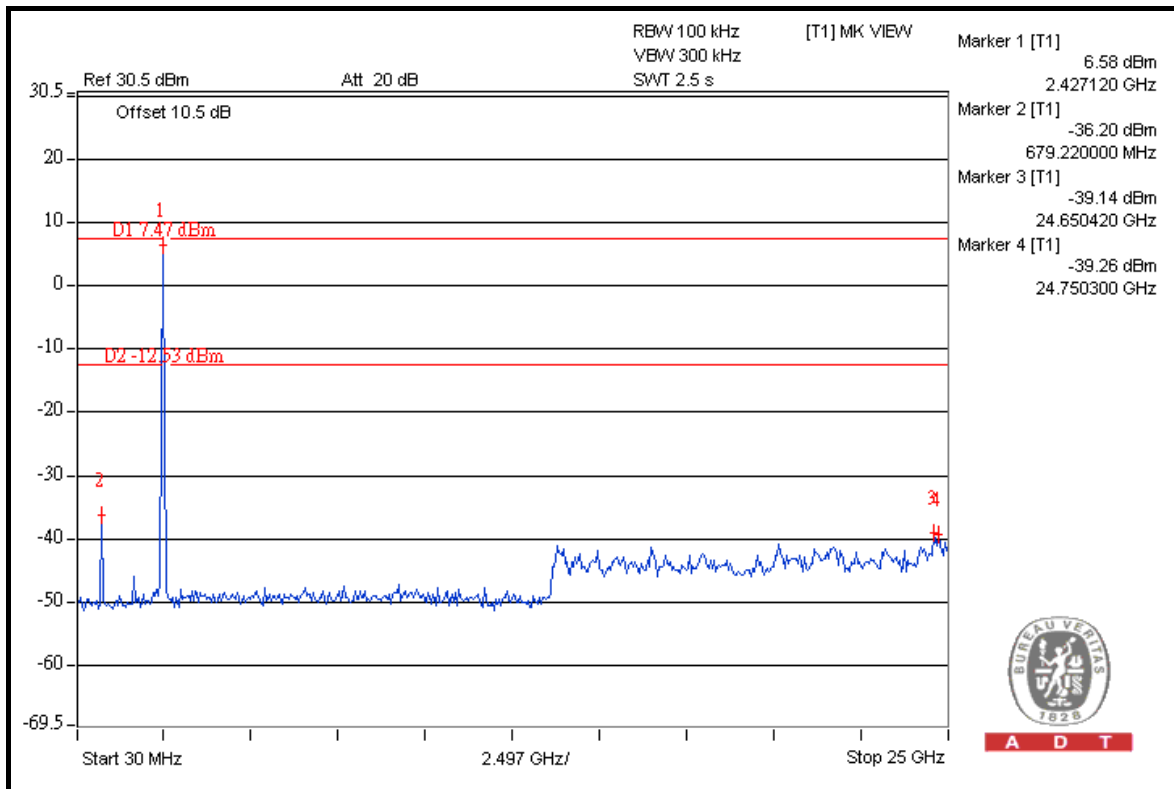
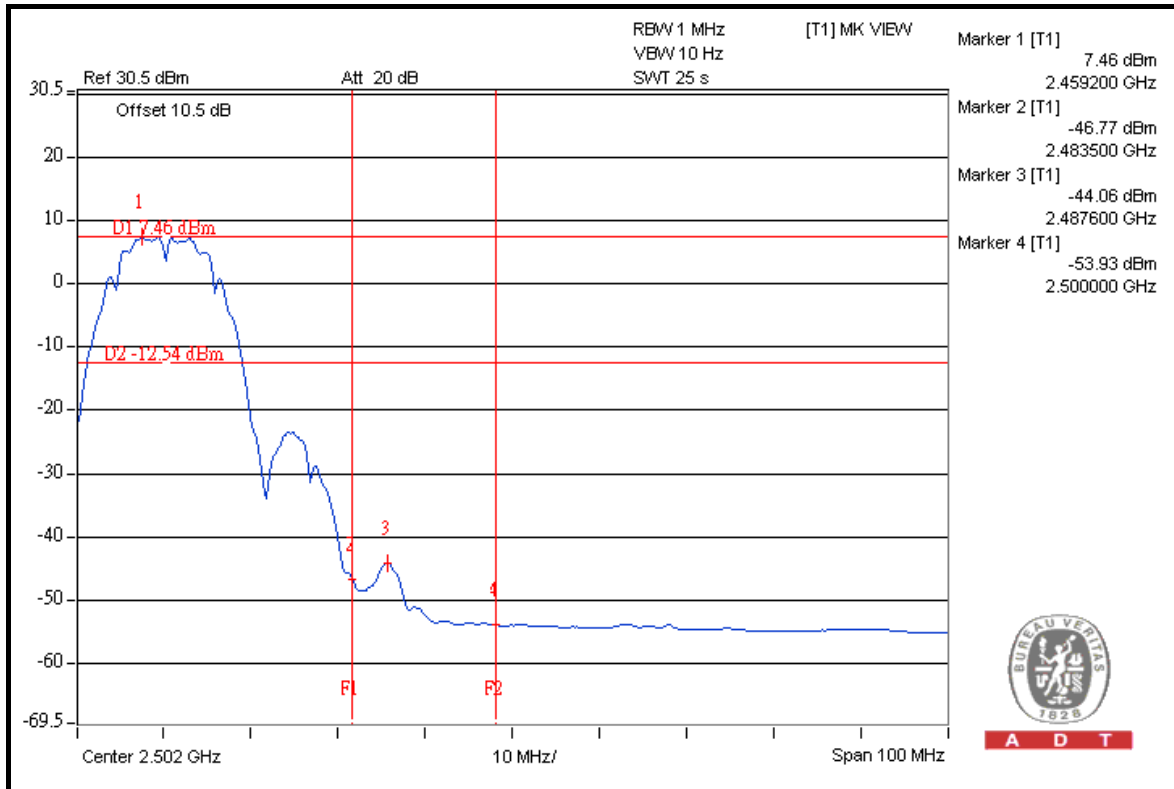



A D T

802.11g

RESTRICT BAND (2310 ~ 2390 MHz)

FREQUENCY (MHz)	FUNDAMENTAL EMISSION (dBuV/m)	DELTA (dB)	MAXIMUM FIELD STRENGTH IN RESTRICT BAND (dBuV/m)	LIMIT (dBuV/m)
2412.00 (PK)	111.3	39.27	72.03	74.00
2412.00 (AV)	100.6	48.06	52.54	54.00

RESTRICT BAND (2483.5 ~ 2500 MHz)

FREQUENCY (MHz)	FUNDAMENTAL EMISSION (dBuV/m)	DELTA (dB)	MAXIMUM FIELD STRENGTH IN RESTRICT BAND (dBuV/m)	LIMIT (dBuV/m)
2462.00 (PK)	111.0	41.87	69.13	74.00
2462.00 (AV)	100.4	48.62	51.78	54.00

NOTE:

1. Delta = Amplitude between the peak of the fundamental and the peak of the band edge emission. Please check following 3 pages.
2. Maximum field strength in restrict band = Fundamental emission – Delta.



A D T

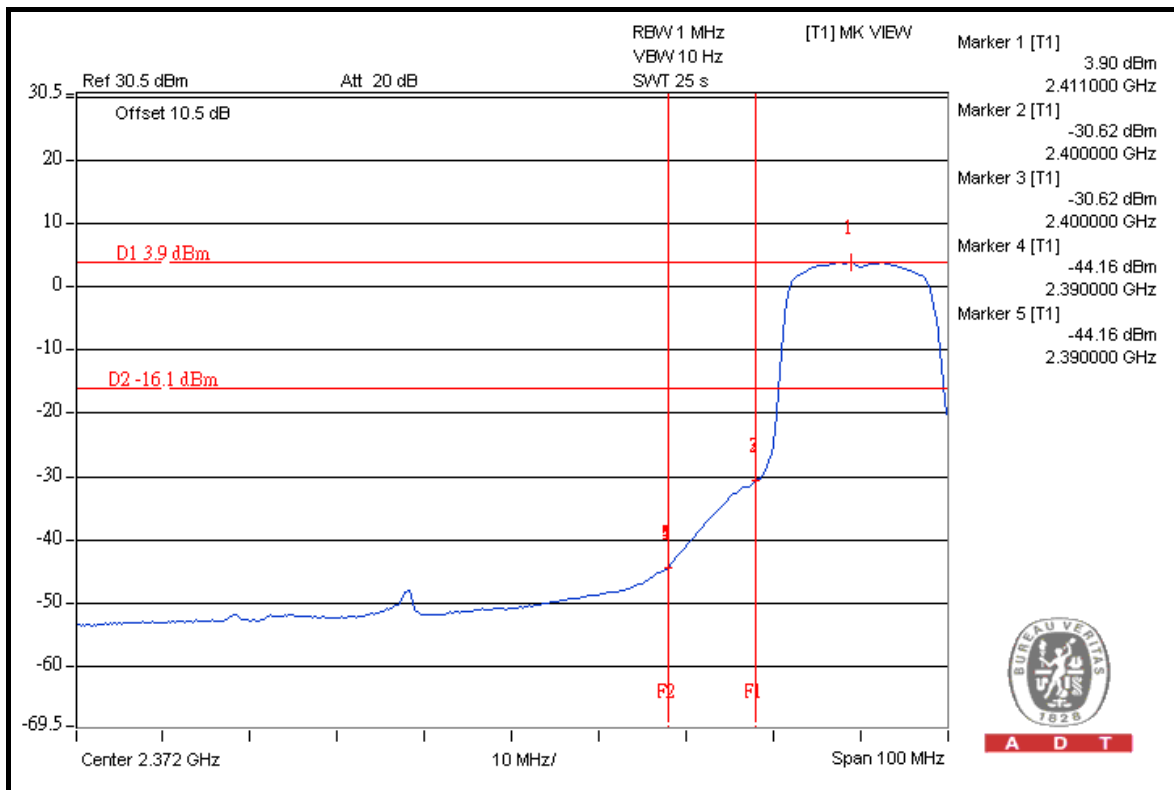
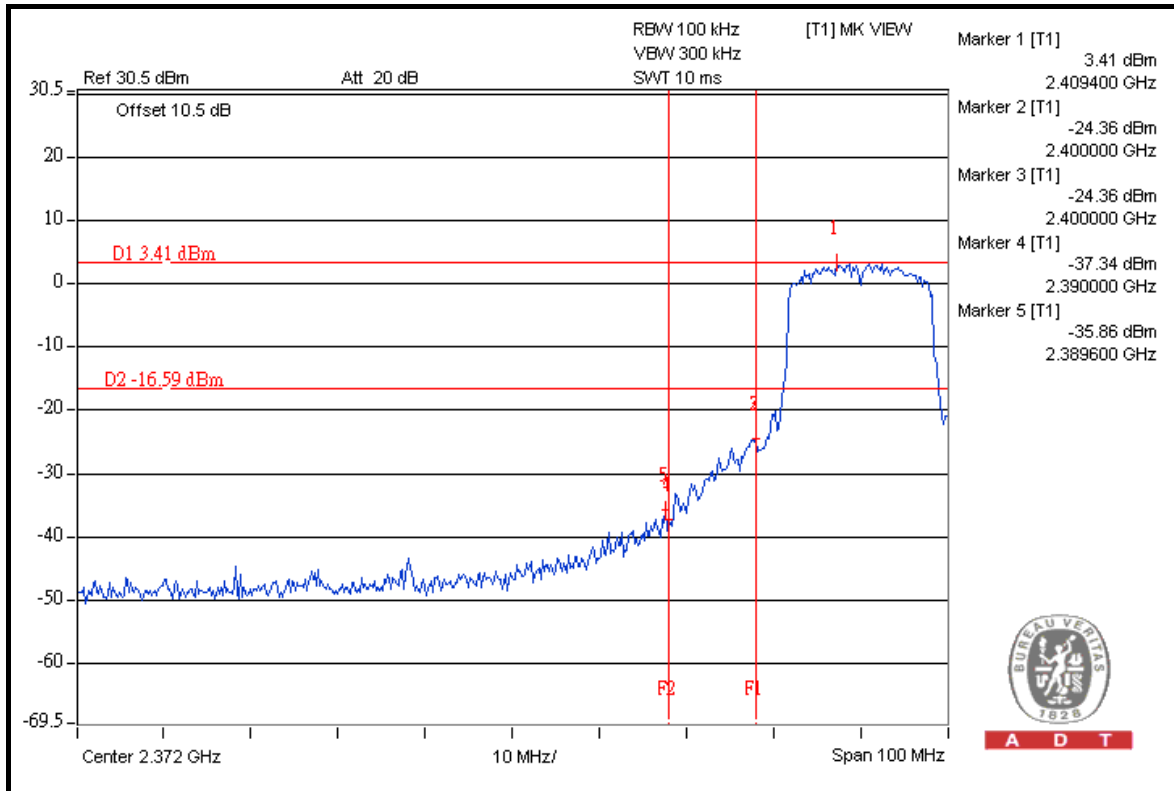



A D T

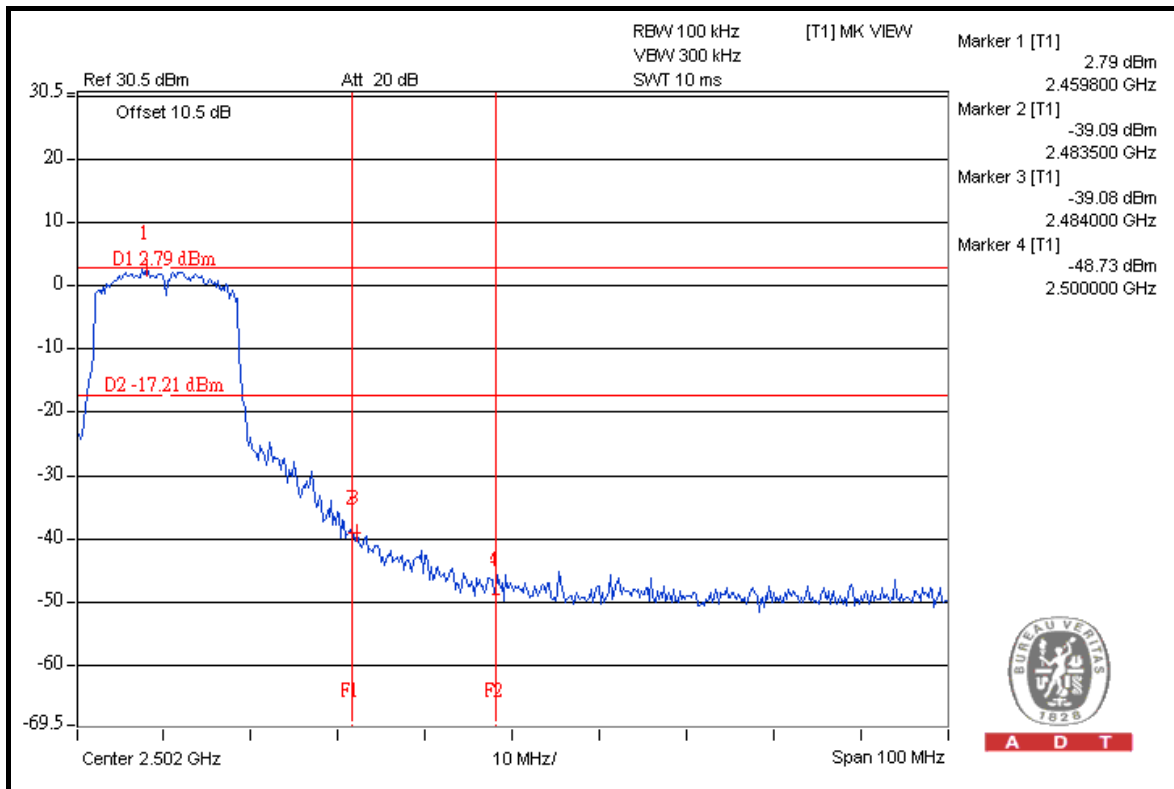
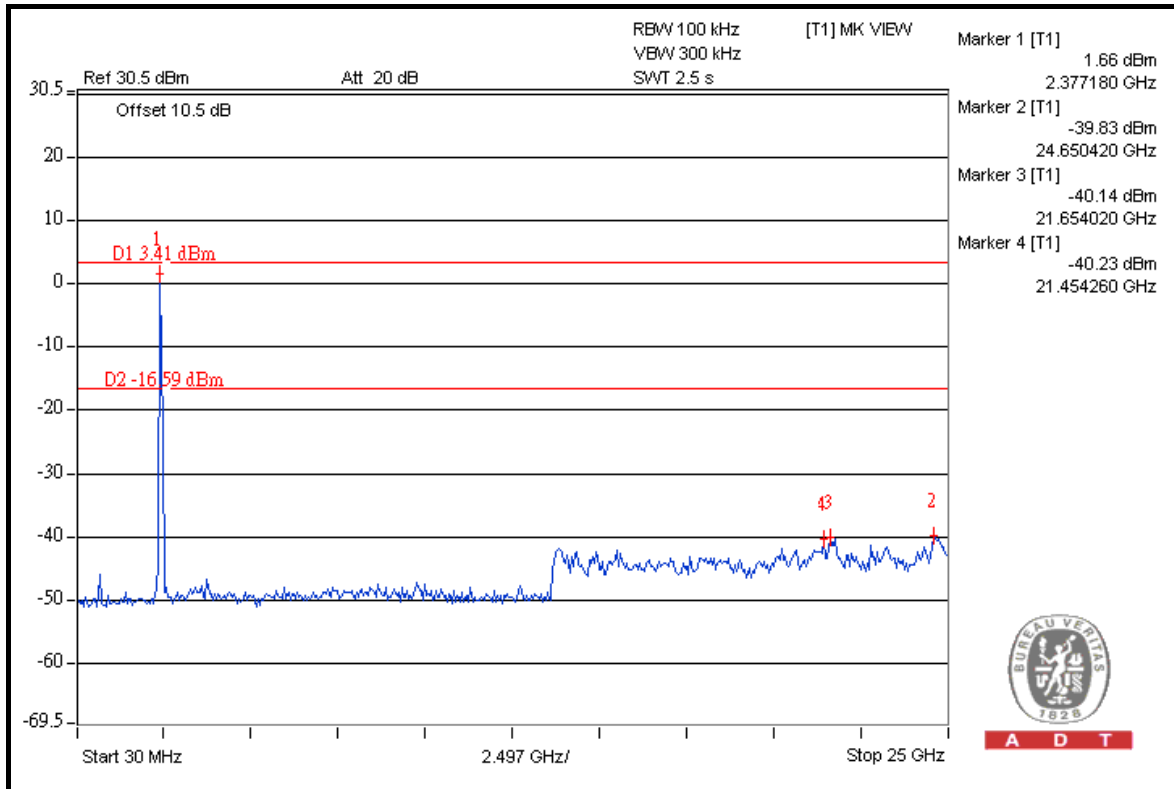



A D T

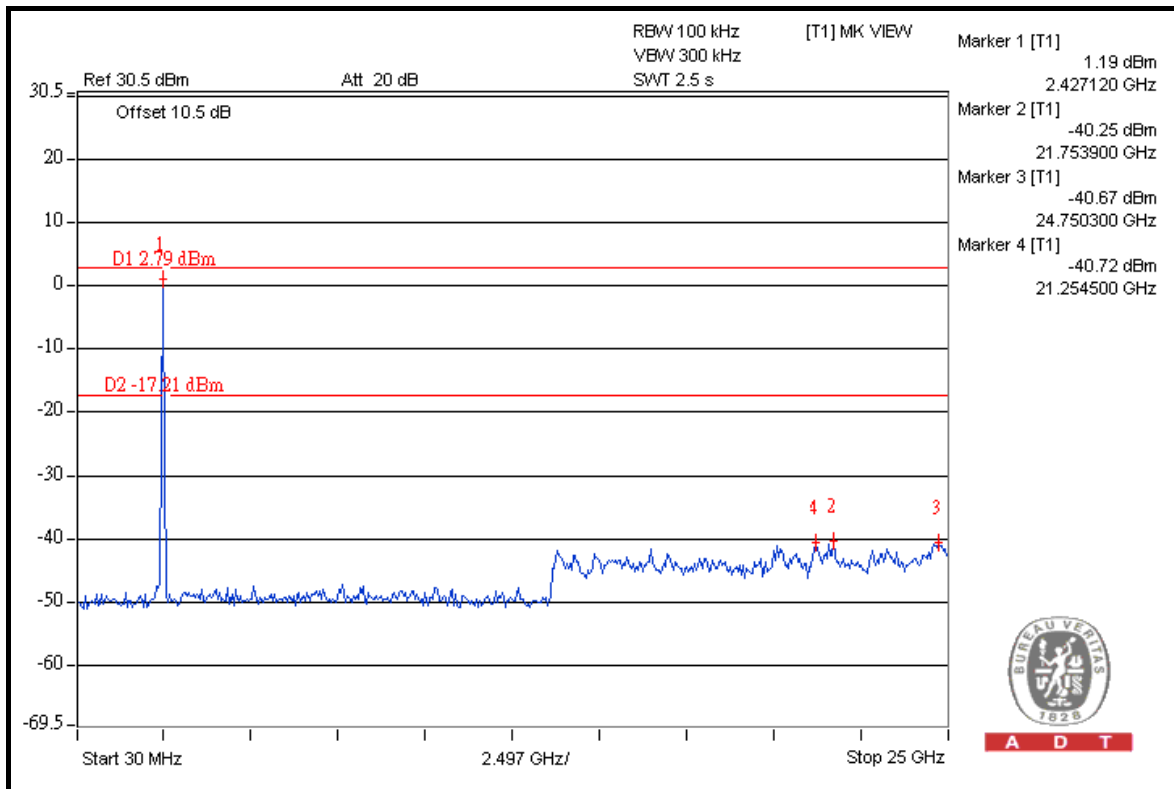
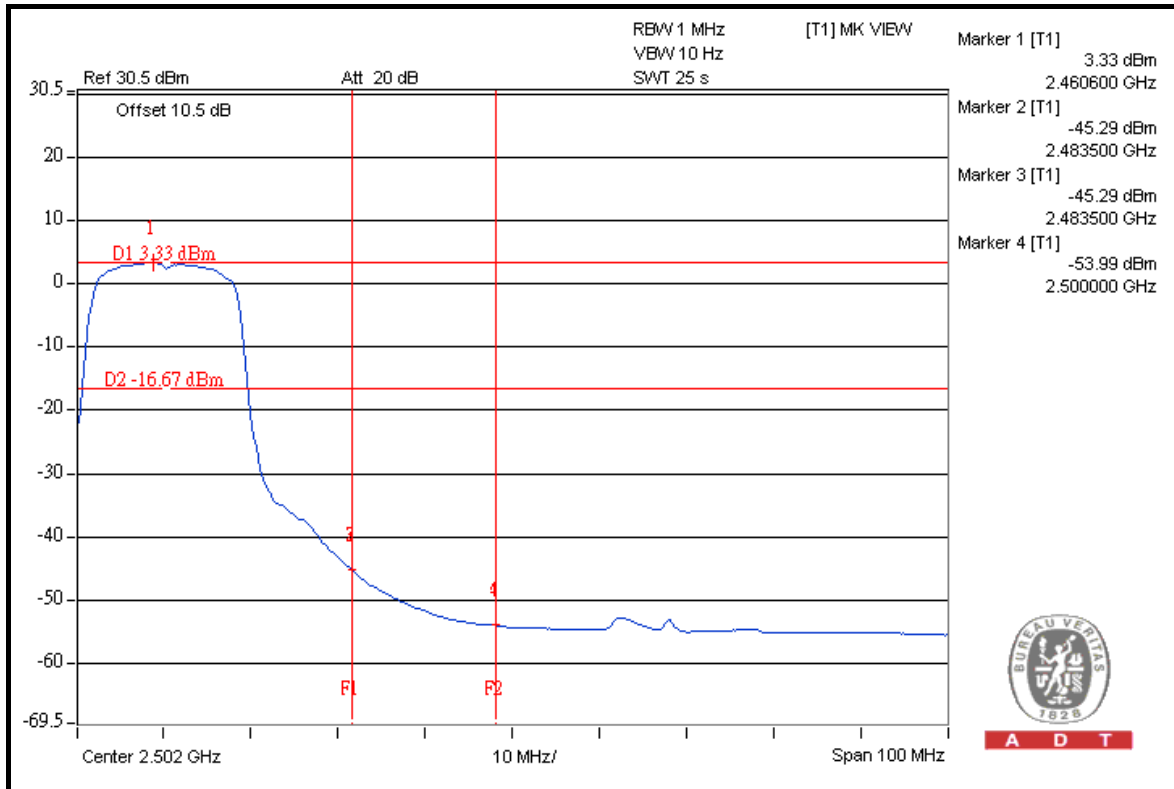



A D T

802.11n (20MHz)

RESTRICT BAND (2310 ~ 2390 MHz)

FREQUENCY (MHz)	FUNDAMENTAL EMISSION (dBuV/m)	DELTA (dB)	MAXIMUM FIELD STRENGTH IN RESTRICT BAND (dBuV/m)	LIMIT (dBuV/m)
2412.00 (PK)	111.4	39.58	71.82	74.00
2412.00 (AV)	100.9	50.44	50.46	54.00

RESTRICT BAND (2483.5 ~ 2500 MHz)

FREQUENCY (MHz)	FUNDAMENTAL EMISSION (dBuV/m)	DELTA (dB)	MAXIMUM FIELD STRENGTH IN RESTRICT BAND (dBuV/m)	LIMIT (dBuV/m)
2462.00 (PK)	109.9	40.50	69.40	74.00
2462.00 (AV)	99.1	46.22	52.88	54.00

NOTE:

1. Delta = Amplitude between the peak of the fundamental and the peak of the band edge emission. Please check following 3 pages.
2. Maximum field strength in restrict band = Fundamental emission – Delta.



A D T

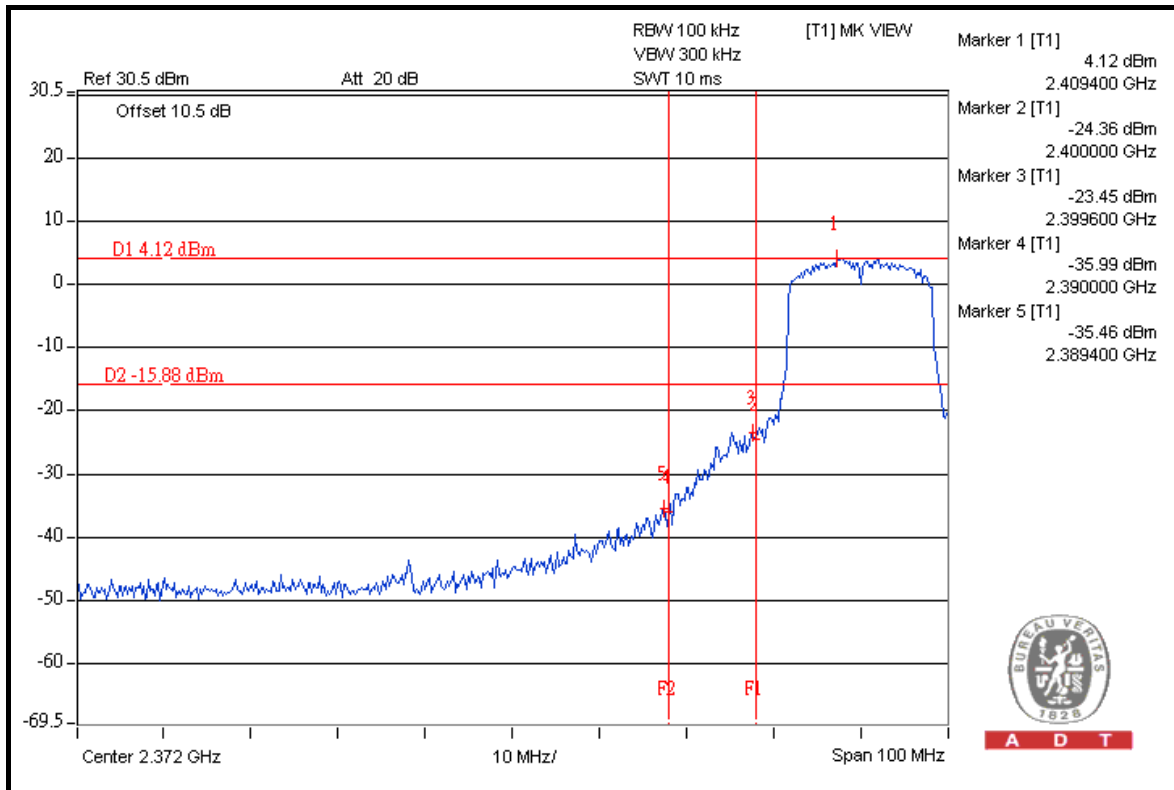

A D T

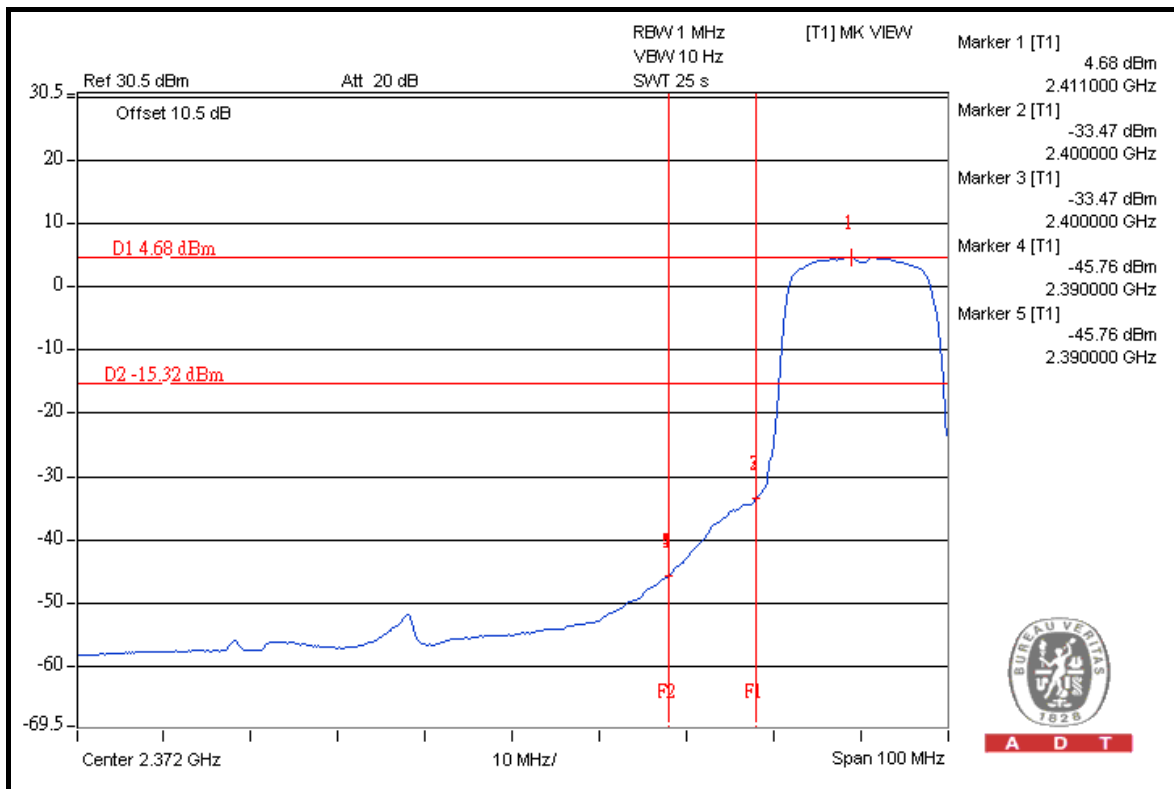

A D T



A D T

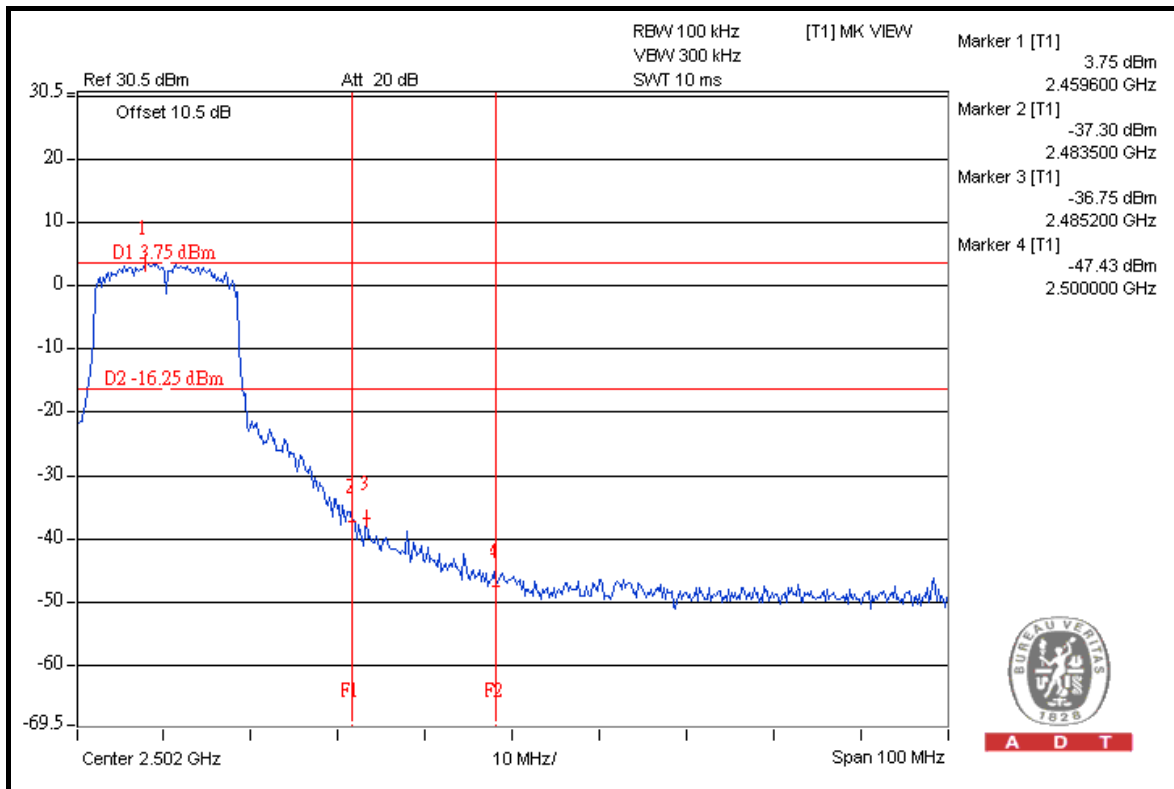
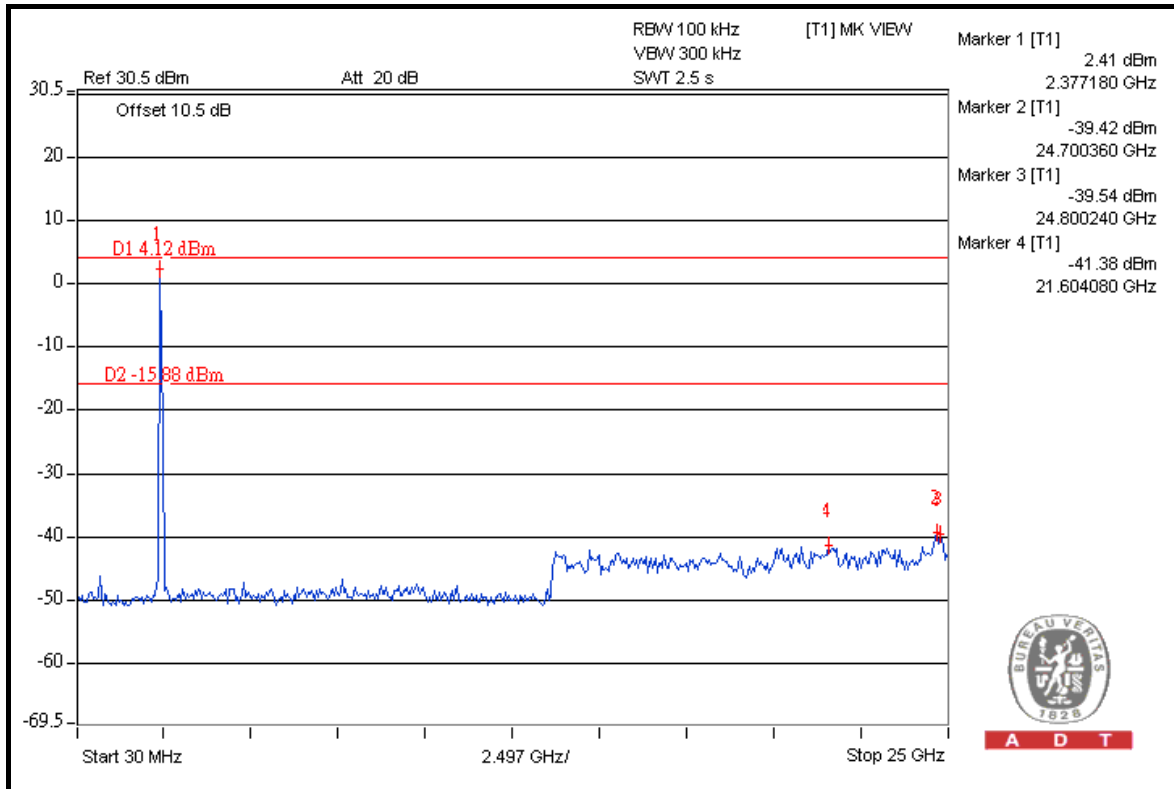



A D T

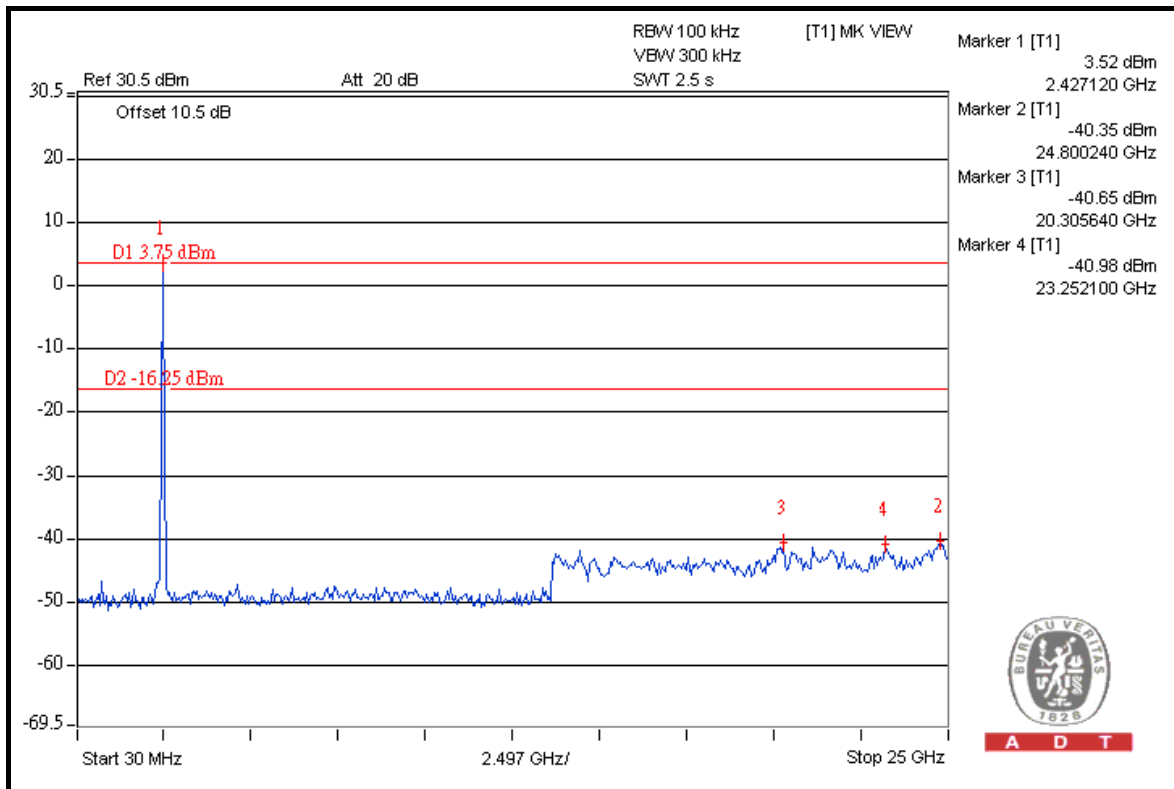
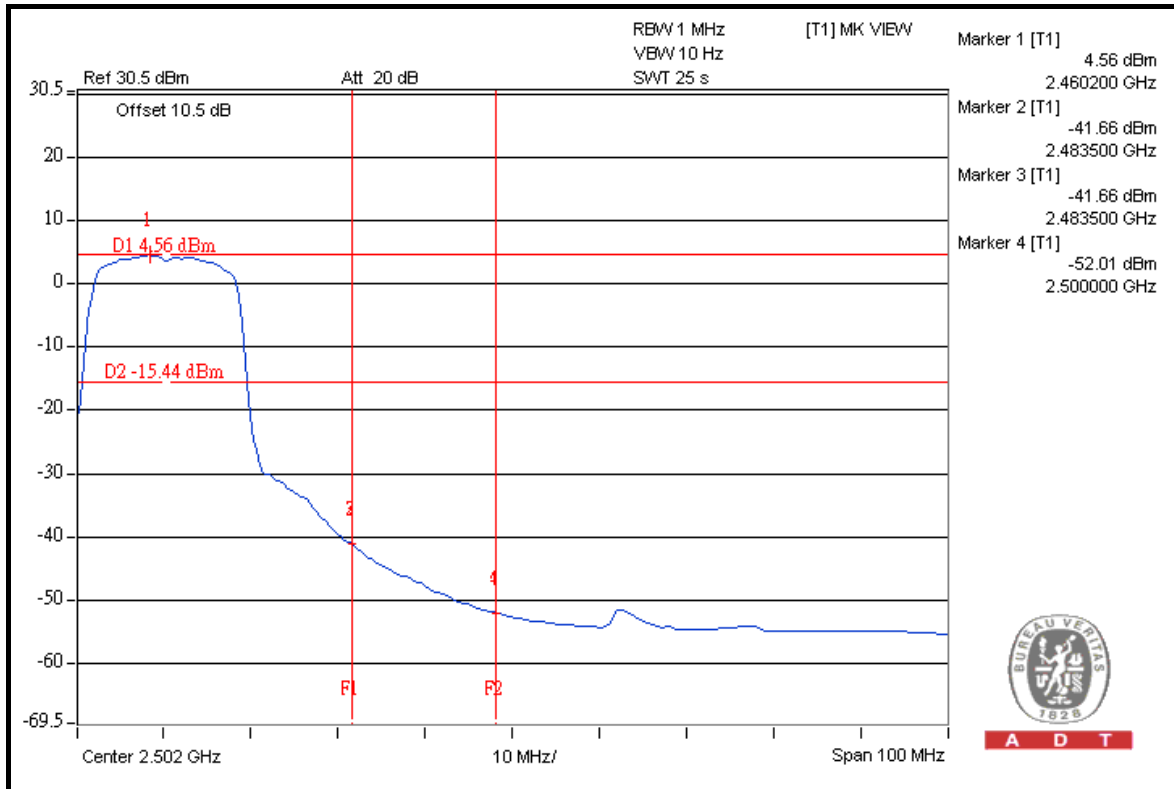



A D T

802.11n (40MHz)

RESTRICT BAND (2310 ~ 2390 MHz)

FREQUENCY (MHz)	FUNDAMENTAL EMISSION (dBuV/m)	DELTA (dB)	MAXIMUM FIELD STRENGTH IN RESTRICT BAND (dBuV/m)	LIMIT (dBuV/m)
2422.00 (PK)	103.2	33.80	69.40	74.00
2422.00 (AV)	92.6	40.20	52.40	54.00

RESTRICT BAND (2483.5 ~ 2500 MHz)

FREQUENCY (MHz)	FUNDAMENTAL EMISSION (dBuV/m)	DELTA (dB)	MAXIMUM FIELD STRENGTH IN RESTRICT BAND (dBuV/m)	LIMIT (dBuV/m)
2452.00 (PK)	102.3	36.67	65.63	74.00
2452.00 (AV)	91.3	39.67	51.63	54.00

NOTE:

1. Delta = Amplitude between the peak of the fundamental and the peak of the band edge emission. Please check following 3 pages.
2. Maximum field strength in restrict band = Fundamental emission – Delta.



A D T

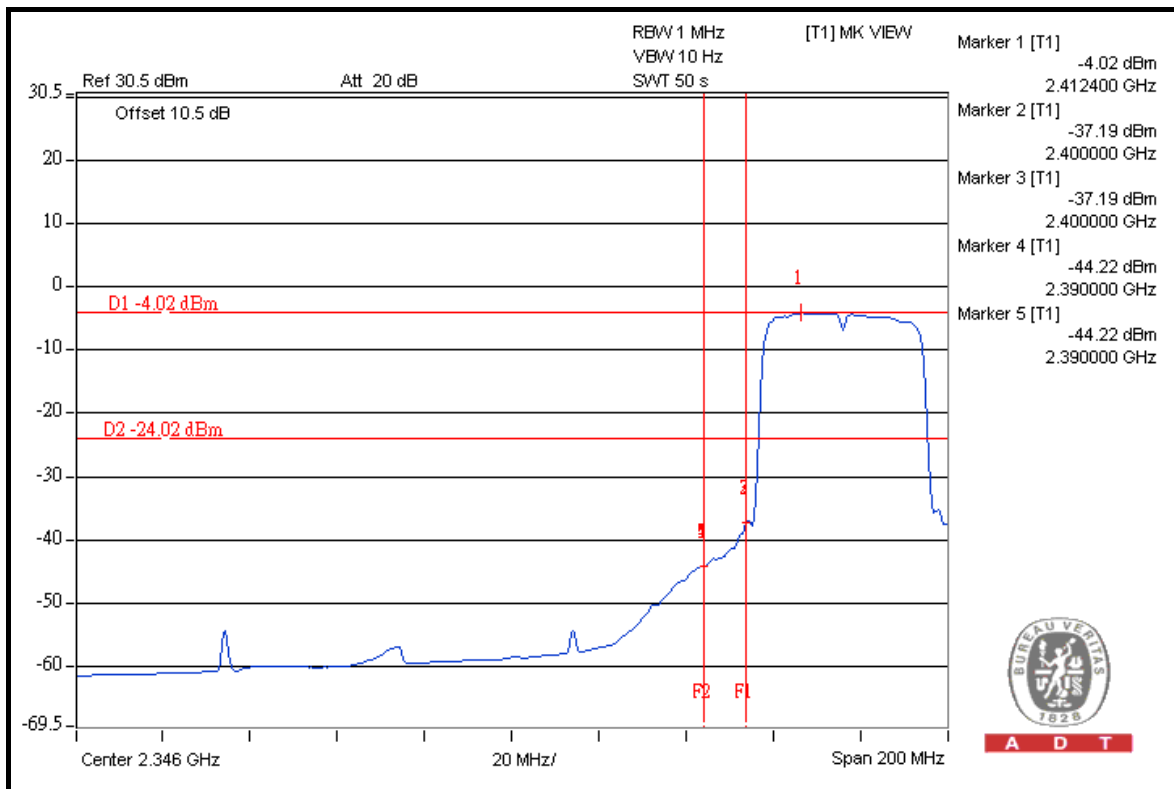
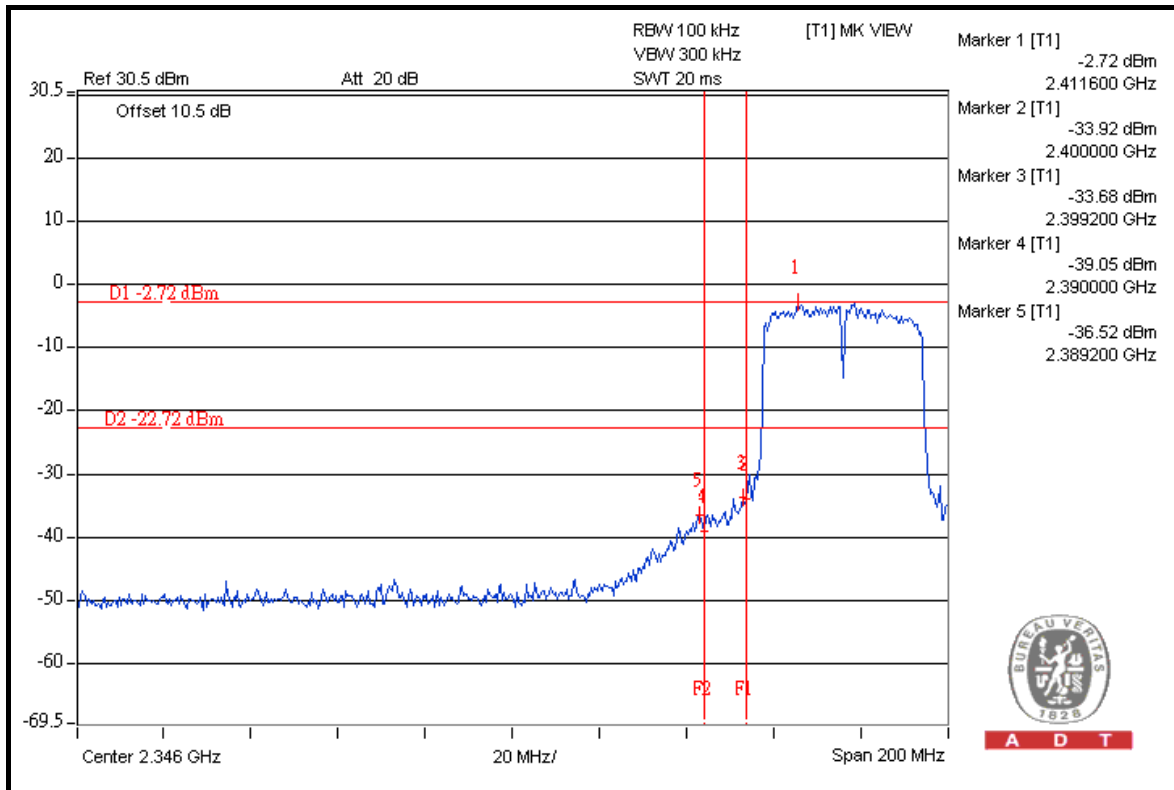



A D T

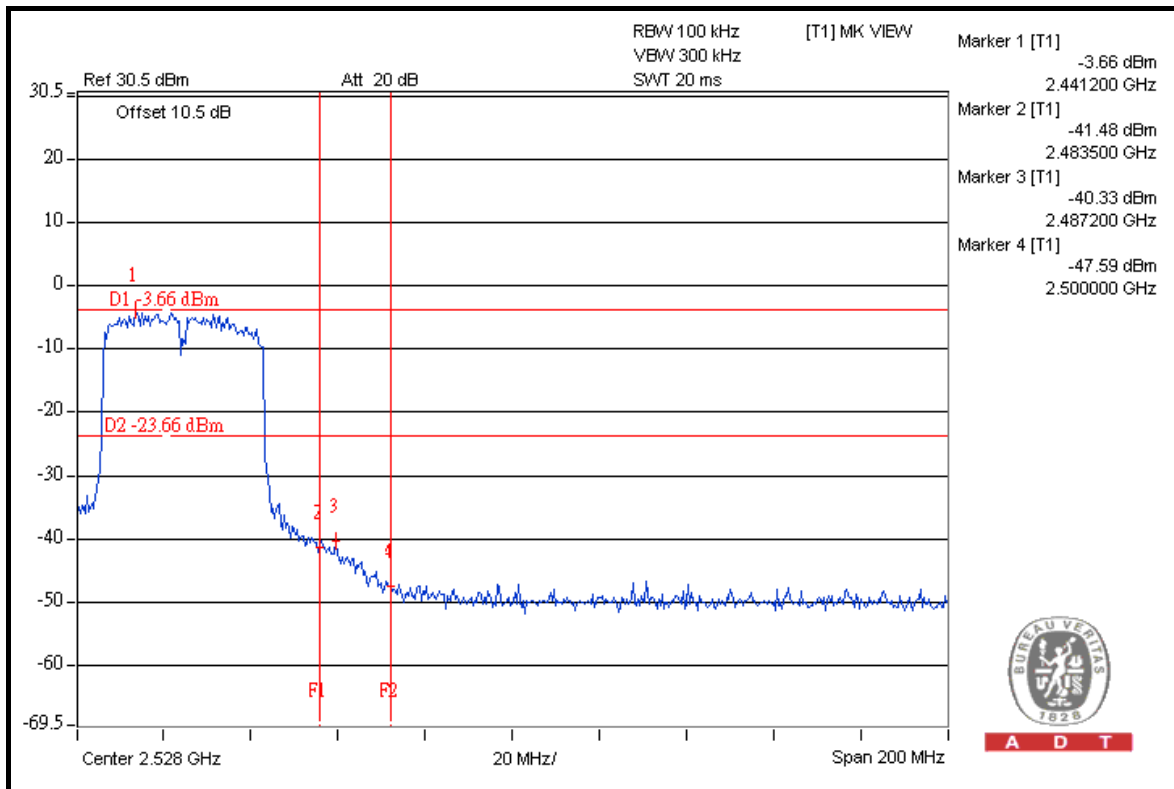
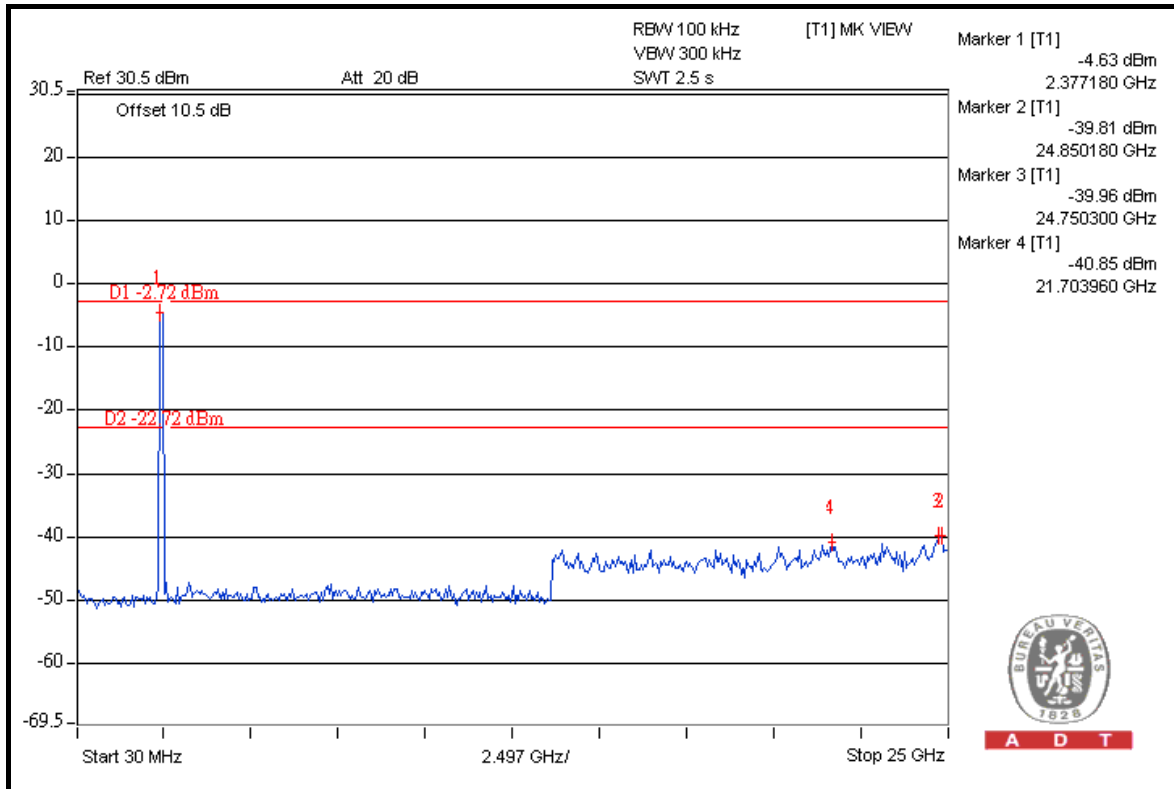



A D T

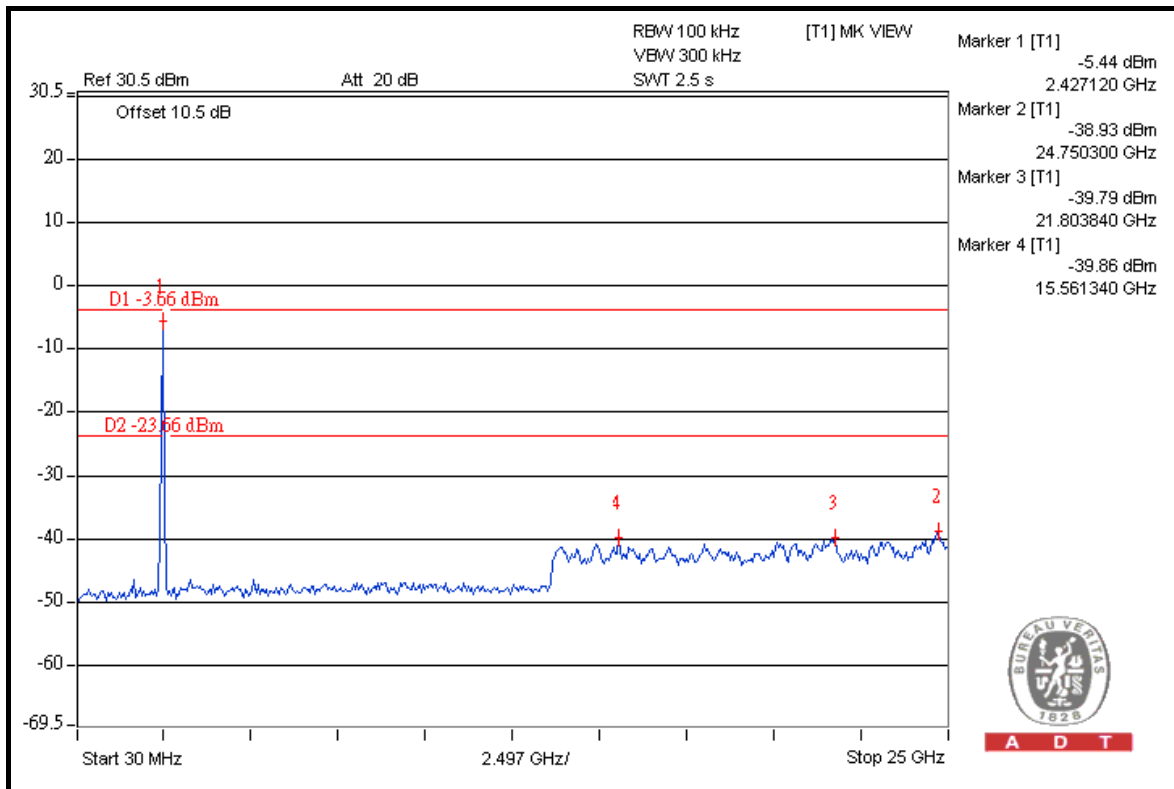
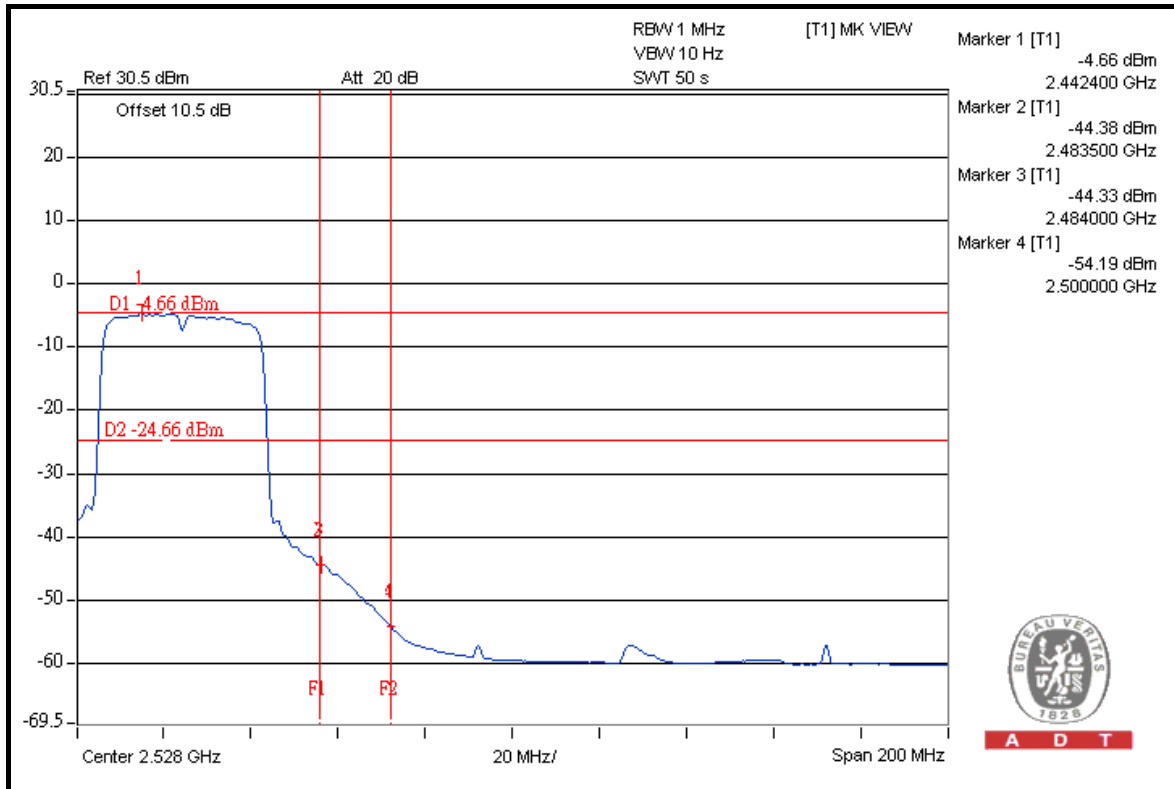



A D T

5. PHOTOGRAPHS OF THE TEST CONFIGURATION

Please refer to the attached file (Test Setup Photo).



A D T

6. INFORMATION ON THE TESTING LABORATORIES

We, Bureau Veritas Consumer Products Services (H.K.) Ltd., Taoyuan Branch, were founded in 1988 to provide our best service in EMC, Radio, Telecom and Safety consultation. Our laboratories are accredited and approved according to ISO/IEC 17025.

Copies of accreditation and authorization certificates of our laboratories obtained from approval agencies can be downloaded from our web site:

www.adt.com.tw/index.5.phtml. If you have any comments, please feel free to contact us at the following:

Linko EMC/RF Lab:

Tel: 886-2-26052180

Fax: 886-2-26051924

Hsin Chu EMC/RF Lab:

Tel: 886-3-5935343

Fax: 886-3-5935342

Hwa Ya EMC/RF/Safety Telecom Lab:

Tel: 886-3-3183232

Fax: 886-3-3185050

Email: service.adt@tw.bureauveritas.com

Web Site: www.adt.com.tw

The address and road map of all our labs can be found in our web site also.



A D T

7. APPENDIX A - MODIFICATIONS RECORDERS FOR ENGINEERING CHANGES TO THE EUT BY THE LAB

No any modifications are made to the EUT by the lab during the test.

---END---