

TRENDnet[®]



Quick Installation Guide
TEW-831DR (V1)

Table of Contents

1 English

1. Before You Start
2. Installation

8 Français

1. Avant de commencer
2. Installation

15 Deutsch

1. Bevor Sie anfangen
2. Installation

22 Español

1. Antes de comenzar
2. Instalación

29 Português

1. Antes de Iniciar
2. Instalação

36 Italiano

1. Prima di cominciare
2. Installazione

43 Русский

1. *Перед началом работы*
2. Установка

1. Before You Start

Package Contents

- TEW-831DR
- Quick Installation Guide
- Network cable (1.5m / 5ft.)
- Power adapter (12V DC, 1A)

Minimum Requirements

- A computer with a wired or wireless network adapter and Web browser
- Broadband internet
- Installed modem

ENGLISH

FRANÇAIS

DEUTSCH

ESPAÑOL

PORTUGUÊS

ITALIANO

РУССКИЙ

Note:

- We have pre-encrypted the TEW-831DR with a unique WiFi Name (SSID) and WiFi Key (WiFi password). You can find these pre-configured settings on the labels on the top and bottom of the router. You will use this information to connect to the router wirelessly. To change the WiFi Key, refer to the user's guide. If the wireless router is reset to factory default, the WiFi Name and the WiFi Key will also reset to factory default.
- To log back into the wireless router's management interface, you will need to know the router's Management Login username and password. You can find the default username and password on the labels on the top and bottom of the router.

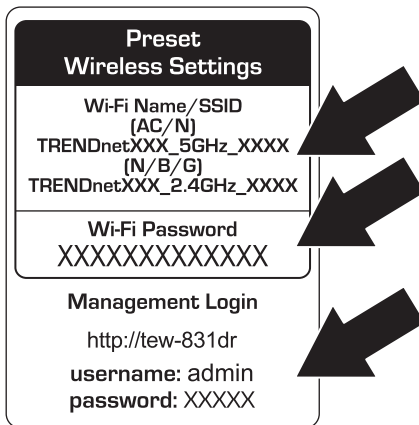

2. Installation

Note: It is recommended that you configure the wireless router from a wired computer.

1. Position the antennas for the best WiFi coverage. It is recommended that you position all of the antennas vertically as shown.



2. Using a computer connected via a wired or wireless network, verify that you have an Internet connection with your existing modem or router.
3. Power off your modem.

Note: If your modem includes a battery backup, remove the battery as well.

4. Unplug the power and disconnect all cables between your modem and existing router.
5. Connect your modem to the TEW-831DR's Internet WAN port, located on the back of the unit, using the included network cable.

ENGLISH

FRANÇAIS

DEUTSCH

ESPAÑOL

PORTUGUÊS

ITALIANO

РУССКИЙ

6. Using another network cable, connect your computer to one of the wireless router's 3 network ports located on the back of the unit, or pre-configured WiFi network (See page 2).

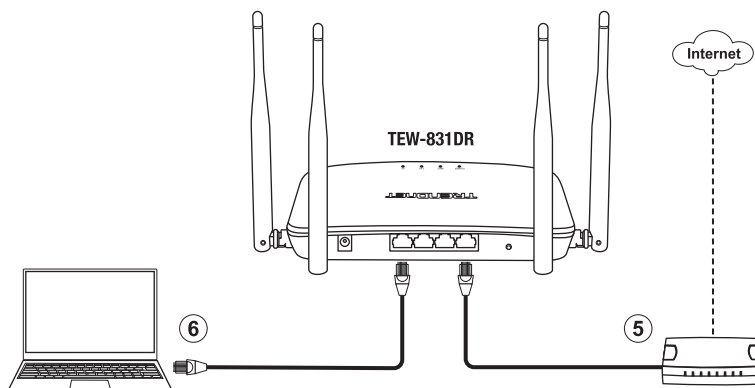

7. Power on your modem. Wait until the LED lights on the modem indicate that it is fully functional (**approximately 2-3 minutes**). For more information on your modem's LED lights, please refer to your modem's user's guide.

8. Connect the power adapter to the back of the router and then to a power outlet.

9. Verify that the blue status LED lights on the front of the router (**Power, 2.4G, 5G**) are on.

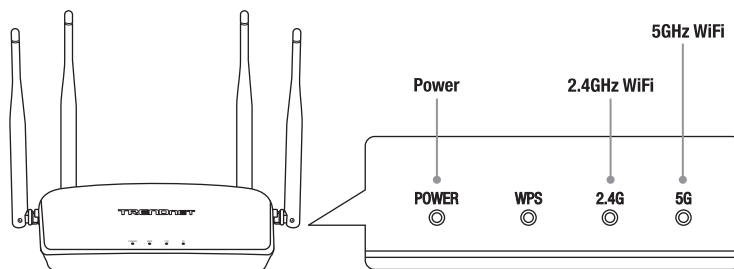

10. Open your web browser from the connected computer; the wizard will automatically appear. Select the desired language and then click **Next**. If the wizard does not appear, type <http://tew-831dr> into the address bar of your web browser, and press **Enter**.

Note: You can also access the device using the default IP address (<http://192.168.10.1>).

11. To begin Setup Wizard click "**Next**".

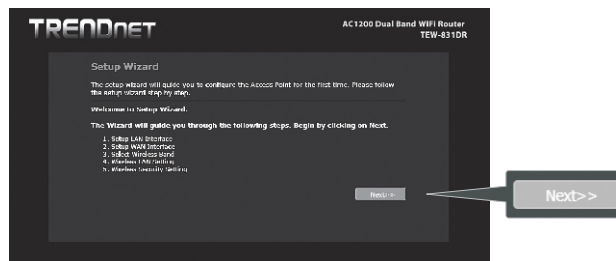

12. Setup your routers IP Address and click "**Next**".

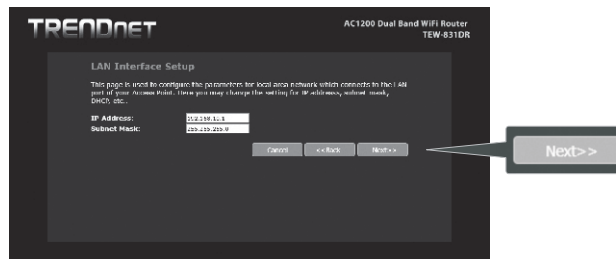

- ENGLISH
- FRANÇAIS
- DEUTSCH
- ESPAÑOL
- PORTUGUÊS
- ITALIANO
- РУССКИЙ

13. Setup your WAN Access Type then click "Next".

Note: You may need to contact your Internet Service Provider for additional information.

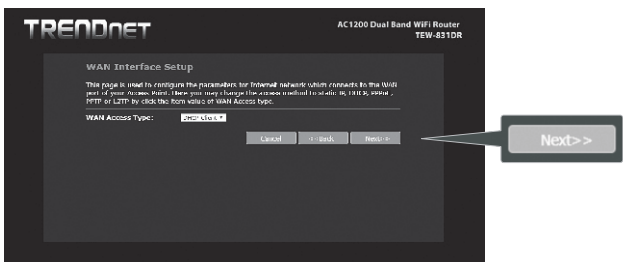

14. Configure your 5GHz wireless settings then click "Next".

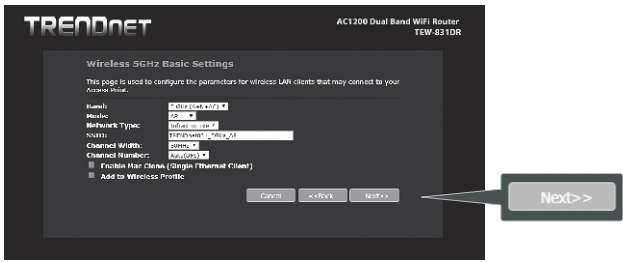

15. Configure your 5GHz wireless key then click "Next".

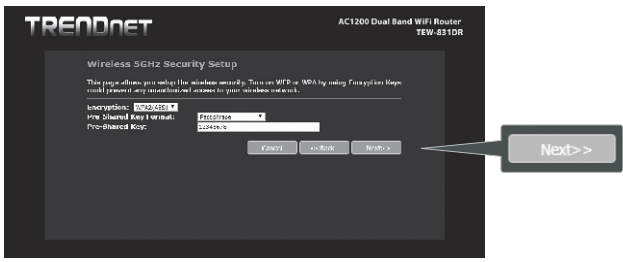

16. Configure your 2.4GHz wireless settings then click “Next”.

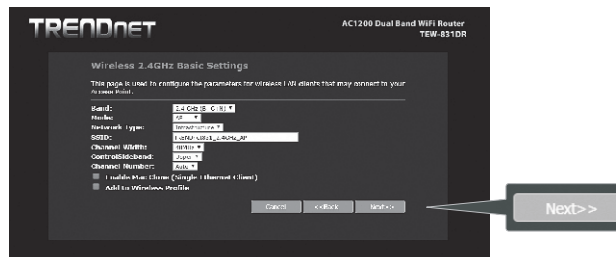

17. Configure your 2.4GHz wireless key. Once All wireless settings are complete. Press the “Finished” button and the router will reboot.



18. Open a web browser and enter a web address (for example www.trendnet.com) to verify that you have Internet connection.

Wireless router installation is now complete.

For detailed information regarding the wireless router's configuration and advanced settings, please refer to the User's Guide on the TRENDnet support page, www.trendnet.com/support.

Toll Free English Technical Support

US/Canada: 855-373-4741

Hours: Monday-Friday

7:00 AM- 6:00 PM, Pacific Standard Time.

After hours: 866-845-3673

- ENGLISH
- FRANÇAIS
- DEUTSCH
- ESPAÑOL
- PORTUGUÊS
- ITALIANO
- РУССКИЙ

ENGLISH

FRANÇAIS

DEUTSCH

ESPAÑOL

PORTUGUÊS

ITALIANO

РУССКИЙ

1. Avant de commencer

Guide d'installation rapide

- TEW-831DR
- Guide d'installation rapide
- Câble réseau (1.5m / 5pieds)
- Adaptateur secteur (12V DC, 1A)

Installation nécessaire

- Un ordinateur avec un adaptateur réseau filaire ou sans fil et un navigateur Internet
- Internet à large bande
- Modem installé

Remarque:

- Nous avons pré-crypté le TEW-831DR avec un nom de WiFi (SSID) et une clé (mot de passe) WiFi exclusifs. Vous trouverez ces paramètres préconfigurés sur les étiquettes se trouvant au sur la partie inférieure et supérieure du routeur. Ces informations seront nécessaires afin de vous connecter en mode WiFi au routeur. Pour modifier la clé WiFi, veuillez consulter le guide de l'utilisateur. Si le routeur WiFi est réinitialisé avec les valeurs d'origine par défaut, le nom du WiFi et la clé WiFi seront également restaurés et retrouveront leurs valeurs d'origine par défaut
- Pour vous identifier à nouveau dans l'interface de gestion du routeur WiFi, vous devrez connaître le nom d'utilisateur et le mot de passe de gestion du routeur. Vous trouverez le nom d'utilisateur et le mot de passe par défaut sur les étiquettes se trouvant au sommet et au bas du routeur.

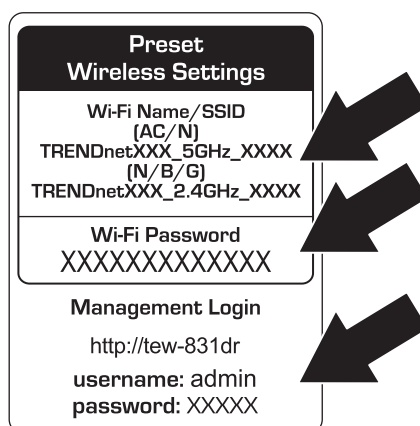

2. Installation

Remarque: Il est recommandé de configurer le routeur sans fil depuis un ordinateur câblé.

1. Fixez les antennes de manière à obtenir la meilleure couverture WiFi. Nous vous recommandons de positionner toutes les antennes verticalement, comme indiqué sur l'illustration.

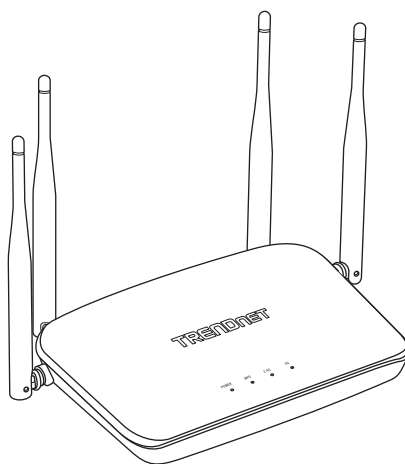

2. À l'aide d'un ordinateur connecté à un réseau filaire ou WiFi, vérifiez que votre modem ou votre routeur existant vous fournit une connexion Internet.

3. Mettez votre modem hors tension.

Remarque: Si votre modem dispose d'une batterie de secours, enlevez également la batterie.

4. Débranchez l'alimentation et déconnectez tous les câbles entre votre modem et votre routeur actuel.
5. Connectez votre modem au port Internet du TEW-831DR se trouvant à l'arrière de l'appareil à l'aide du câble réseau fourni.

6. A l'aide d'un autre câble réseau, connectez votre ordinateur à l'un des 3 ports réseau du routeur WiFi se trouvant à l'arrière e l'appareil, ou réseau WiFi préconfiguré (voir page 9).

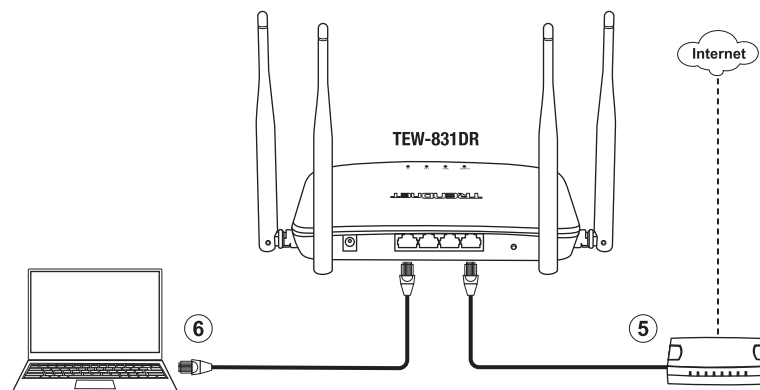

7. Mettez votre modem sous tension. Attendez que les voyants LED du modem indiquent qu'il est complètement fonctionnel (**environ 2 ou 3 minutes**). Pour plus d'informations, quant aux voyants LED de votre modem, veuillez consulter le guide de l'utilisateur de ce dernier.

8. Branchez l'adaptateur secteur à l'arrière du routeur et connectez-le ensuite à une prise de courant.

9. Vérifiez que les LED bleus d'état s'allument sur la face avant du routeur (**Alimentation, 2.4 G, 5 G**) sont allumés.

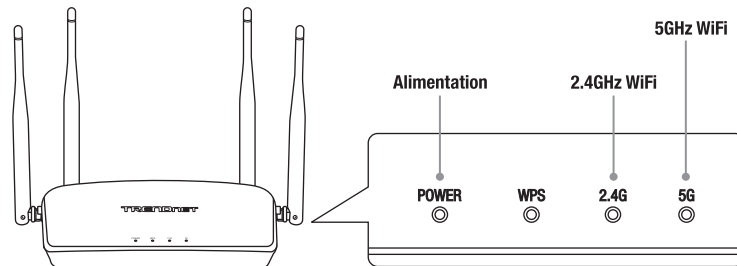

ENGLISH

FRANÇAIS

DEUTSCH

ESPAÑOL

PORTUGUÊS

ITALIANO

РУССКИЙ

10. Ouvrez votre navigateur Internet depuis l'ordinateur connecté, l'assistant apparaîtra automatiquement. Choisissez la langue désirée et cliquez ensuite sur **Next** (Suivant). Si l'assistant n'apparaît pas, tapez <http://tew-831dr> dans la barre d'adresse de votre navigateur et appuyez sur **Enter**.

Remarque: Vous pouvez également accéder au périphérique en utilisant l'adresse IP par défaut <http://192.168.10.1>.

11. Pour lancer l'assistant de configuration, cliquez sur « **Next** » (Suivant).

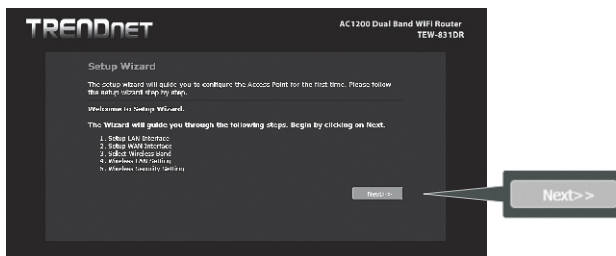

12. Configurez l'adresse IP de votre routeur puis cliquez sur « **Next** » (Suivant).

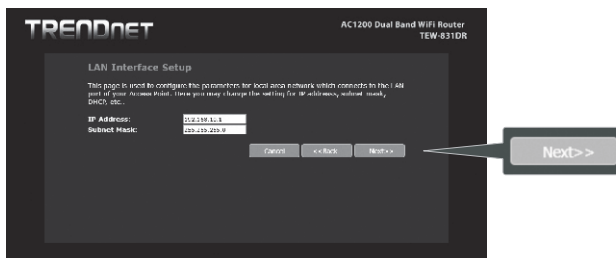

13. Configurez votre type d'accès WAN puis cliquez sur « Next » (Suivant).

Remarque: Vous devrez peut-être communiquer avec votre fournisseur de services Internet pour obtenir de plus amples renseignements.

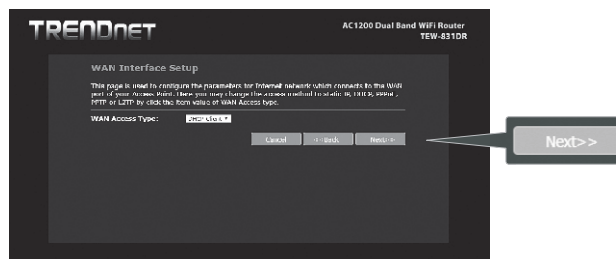

14. Configurez vos paramètres WiFi 5GHz puis cliquez sur « Next » (Suivant).

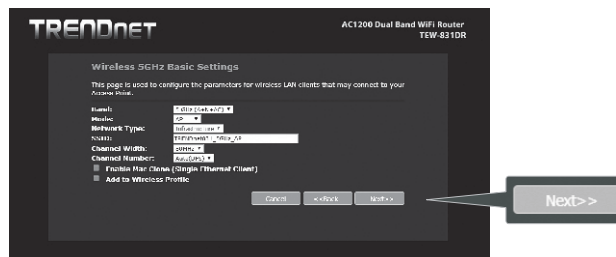

15. Configurez votre clé WiFi 5GHz puis cliquez sur « Next » (Suivant).

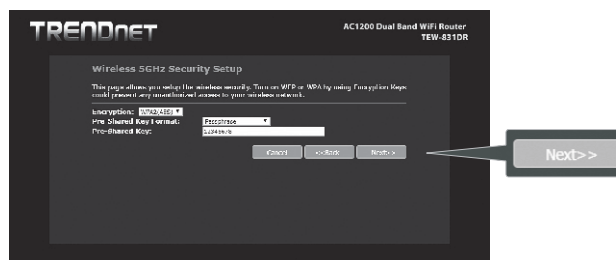

- ENGLISH
- FRANÇAIS
- DEUTSCH
- ESPAÑOL
- PORTUGUÊS
- ITALIANO
- РУССКИЙ

16. Configurez votre clé WiFi 2.4GHz puis cliquez sur « **Next** » (**Suivant**).

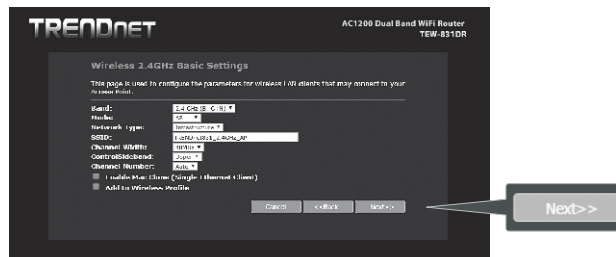

17. Configurez votre clé WiFi 2,4GHz. Lorsque tous les paramétrages WiFi sont effectués, cliquez sur le bouton « **Finished** » (**Terminé**) afin d'appliquer les paramètres et de redémarrer le routeur.

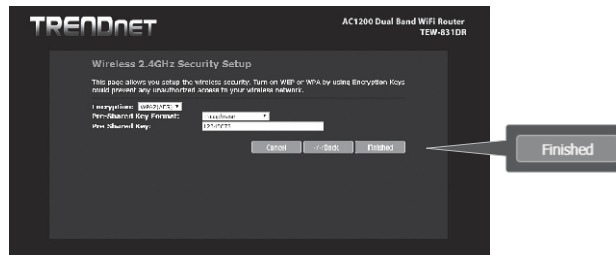

18. Ouvrez un navigateur et saisissez une adresse Internet (par exemple, www.trendnet.com) afin de vérifier que votre connexion Internet est active.

L'installation du routeur WiFi est à présent terminée.

Pour des informations plus détaillées concernant la configuration et les paramètres avancés du routeur WiFi, Veuillez consulter le Guide de l'utilisateur sur la page d'assistance de TRENDnet, www.trendnet.com/support.

1. Bevor Sie Beginnen

Paketinhalte

- TEW-831DR
- Schnellinstallationsanleitung
- Netzkabel (1.5m / 5Fuß)
- Netzadapter (12V DC, 1A)

Installationsanforderungen

- Computer mit kabelgebundenem oder kabellosem Netzwerkadapter und Webbrowser
- Breitband-Internet
- Installiertes Modem

ENGLISH

FRANÇAIS

DEUTSCH

ESPAÑOL



PORTUGUÊS

ITALIANO

РУССКИЙ

Anmerkung:

- Wir haben den TEW-831DR werkseitig mit einem individuellen Wi-Fi-Namen (SSID) und Wi-Fi-Schlüssel (Wi-Fi-Passwort) verschlüsselt. Sie finden diese vorkonfigurierten Einstellungen auf den Aufklebern oben und unten auf dem Router. Mit diesen Informationen stellen Sie die Wireless-Verbindung zum Router her. Informationen zur Änderung des Wi-Fi Schlüssels entnehmen Sie bitte dem Produkthandbuch. Wenn der Wireless-Router zurückgesetzt wird, werden auch der Wi-Fi Name und der Wi-Fi Schlüssel auf den Auslieferungsstand zurückgesetzt.
- Um sich wieder in die Verwaltungsschnittstelle des Wireless-Routers einzuloggen, müssen Sie den Administrator-Benutzernamen und das Passwort des Routers kennen. Sie finden den Standard-Benutzernamen und das Passwort auf den Aufklebern oben und unten auf dem Router.

Preset Wireless Settings	
Wi-Fi Name/SSID (AC/N) TRENDnetXXX_5GHz_XXXX (N/B/G) TRENDnetXXX_2.4GHz_XXXX	
Wi-Fi Password XXXXXXXXXXXXXX	
Management Login http://tew-831dr username: admin password: XXXXXX	

2. Installation

Anmerkung: Wir empfehlen, dass Sie den Wireless-Router über einen kabelgebundenen PC installieren.

1. Befestigen Sie die Antennen für bestmöglichen Wi-Fi-Empfang aus. Wir empfehlen, dass Sie die Antennen vertikal ausrichten wie gezeigt.



2. Prüfen Sie mit einem Computer, der über Kabel oder Wireless mit dem Netzwerk verbunden ist, dass Sie eine Internetverbindung mit Ihrem bestehenden Modem oder Router haben.
3. Fahren Sie Ihr Modem herunter.

Anmerkung: Falls Ihr Modem über eine Notbatterie verfügt, entfernen Sie diese ebenfalls.

4. Trennen Sie das Stromkabel und alle bestehenden Kabel von Ihrem Modem und Ihrem bestehenden Router ab.
5. Schließen Sie Ihr Modem über das unbegriffene Netzwerkkabel an den Internetausgang des TEW-831DR WAN-port auf der Rückseite des Geräts an.

ENGLISH

FRANÇAIS

DEUTSCH

ESPAÑOL

PORTUGUÊS

ITALIANO

РУССКИЙ

6. Verbinden Sie Ihren Computer über ein anderes Netzkabel mit einem der 3 Netzkabelausgänge des Wireless Routers auf der Rückseite des Geräts, vorkonfiguriertes Wi-Fi-Netzwerk (siehe Seite 16).

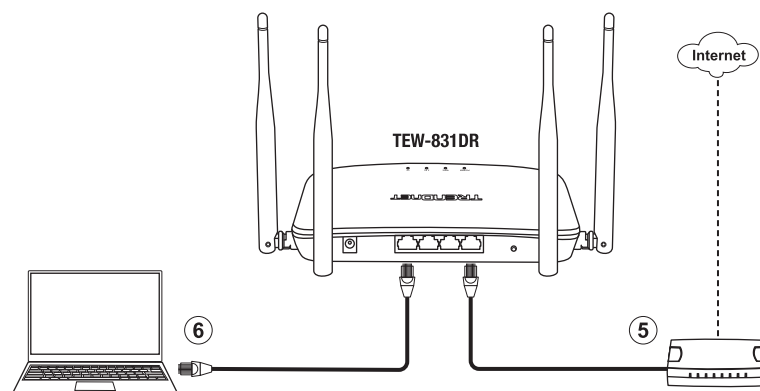

7. Schalten Sie Ihr Modem ein. Warten Sie, bis die LEDs anzeigen, dass das Modem voll funktionsfähig ist (**etwa 2-3 Minuten**). Weitere Informationen zu den LEDs Ihres Modems entnehmen Sie bitte dem Benutzerhandbuch Ihres Modems.
8. Stecken Sie den Netzadapter auf der Rückseite des Routers ein und stecken Sie ihn dann in eine Steckdose.
9. Vergewissern Sie sich, dass die blauen LED-tatusleuchten an der Vorderseite des Routers (**Strom, 2.4G, 5G**) aufleuchten.

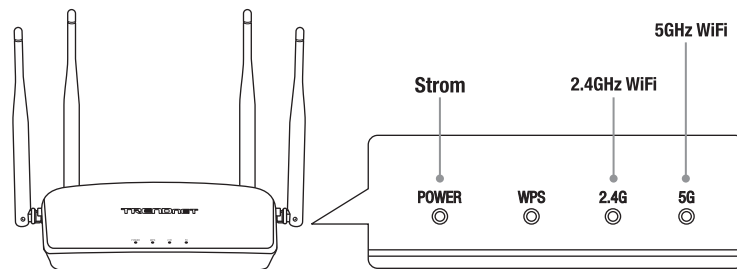

10. Öffnen Sie Ihren Webbrowser von dem verbundenen Computer aus; der Assistent erscheint automatisch. Wählen Sie die gewünschte Sprache aus und klicken Sie auf **"Next" (Weiter)**. Falls der Assistent nicht erscheint, geben Sie bitte <http://192.168.10.1> in die Adressleiste Ihres Webbrowsers ein und drücken Sie auf **Eingabe**.

Anmerkung: Sie können auf das Gerät auch über die folgende Standard-IP-Adresse zugreifen: <http://192.168.10.1>.

11. Um den Setup-Assistenten zu starten, klicken Sie auf **"Next" (Weiter)**.

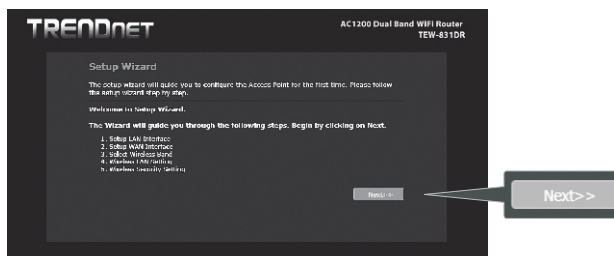

12. Richten Sie die IP-Adresse Ihres Routers ein und klicken Sie dann auf **"Next" (Weiter)**.

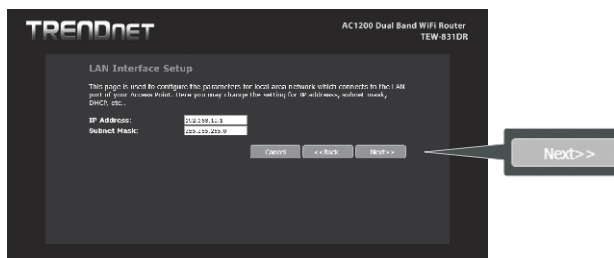

ENGLISH

FRANÇAIS

DEUTSCH

ESPAÑOL

PORTUGUÊS

ITALIANO

РУССКИЙ

13. Richten Sie Ihren WAN-Zugriffstyp ein und klicken Sie dann auf **"Next" (Weiter)**.

Anmerkung: Unter Umständen müssen Sie sich für weitere Informationen an Ihren Internetdienstanbieter wenden.

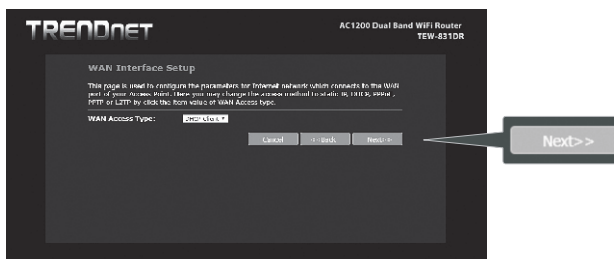

14. Konfigurieren Sie Ihre 5GHz Wireless-Einstellungen und klicken Sie dann auf **"Next" (Weiter)**.

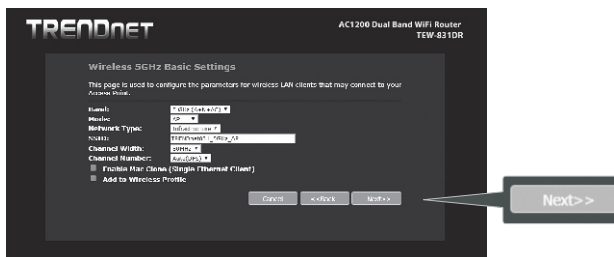

15. Konfigurieren Sie Ihr 5GHz Wireless-Passwort und klicken Sie dann auf **"Next" (Weiter)**.

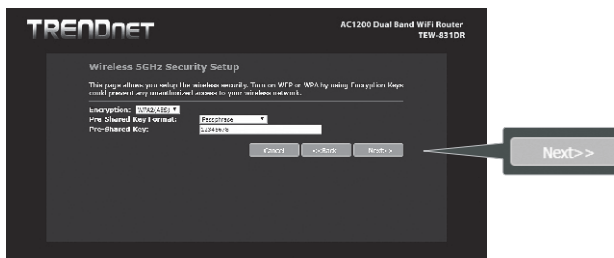

16. Konfigurieren Sie Ihr 2.4GHz Wireless-Passwort und klicken Sie dann auf "Next" (Weiter).

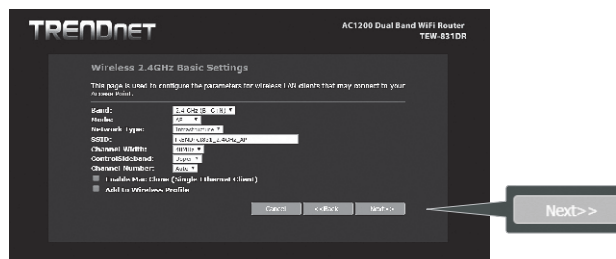

17. Konfigurieren Sie Ihr 2,4 GHz Wireless-Passwort. Sobald alle Wireless-Einstellungen abgeschlossen sind, klicken Sie auf die Schaltfläche "Finished" (Fertig), um die Einstellungen zu übernehmen und den Router neu zu starten.



18. Öffnen Sie einen Webbrowser und geben Sie eine Internetadresse ein (z.B. www.trendnet.com), um Ihre Internetverbindung zu testen.

Die Installation Ihres Wireless-Routers ist damit abgeschlossen.

Weitere Informationen zur Konfiguration des Wireless-Routers und fortgeschrittene, Weitere Informationen finden Sie im Benutzerhandbuch auf der TRENDnet-Support-Seite, www.trendnet.com/support.

ENGLISH

FRANÇAIS

DEUTSCH

ESPAÑOL

PORTUGUÊS

ITALIANO

РУССКИЙ

ENGLISH

1. Antes de comenzar

Contenidos del paquete

- TEW-831DR
- Guía de instalación rápida
- Cable de red (1.5mts / 5pies)
- Adaptador de corriente (12V DC, 1A)

FRANÇAIS

Requisitos de instalación

- Una computadora con adaptador de red por cable o wireless y navegador web
- Internet de banda ancha
- Módem instalado

DEUTSCH

ESPAÑOL

PORTUGUÊS

ITALIANO

РУССКИЙ

Nota:

- Hemos preconfigurado el TEW-831DR con un nombre Wi-Fi (SSID) y una clave WiFi (contraseña Wi-Fi) únicos. Encontrará estas opciones preconfiguradas en las etiquetas de la parte superior e inferior del router. Necesitará esta información para conectarse al router sin cables. Para cambiar la clave WiFi, consulte el manual del usuario. Si se reinicia el router wireless desde cero, la clave WiFi y el nombre WiFi pasarán a ser los que venían de fábrica.
- Para volver a conectarse a la interfaz de administración del router wireless, deberá conocer el nombre de usuario y la contraseña de acceso de administrador al router. Encontrará el nombre de usuario y la contraseña por defecto en las etiquetas de la parte superior e inferior del router.

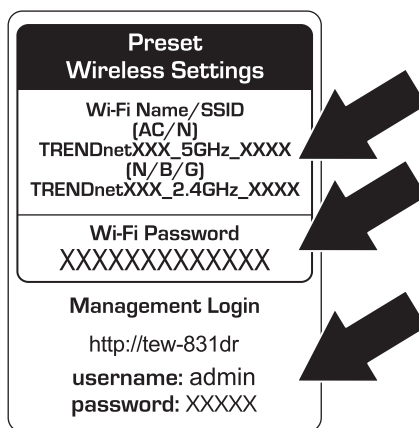

2. Instalación

Nota: Se recomienda configurar el router wireless desde una computadora cableada.

1. Acople las antenas para lograr la mejor cobertura WiFi posible. Se recomienda colocar el resto de las antenas verticalmente, según se muestra.

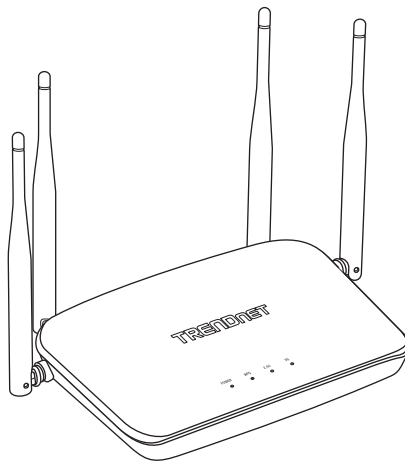

2. Utilizando una computadora conectada mediante una red por cable o wireless, compruebe que tenga conexión a Internet a través de su módem o router existente.

3. Apague el módem.

Nota: Si su módem cuenta con batería de respaldo, retírela también.

4. Desconecte la alimentación y todos los cables entre su módem y su router existente.

5. Conecte el módem al puerto WAN de Internet del TEW-831DR, situado en la parte trasera de la unidad, utilizando el cable de red incluido.

6. Utilizando otro cable de red, conecte su computadora a uno de los 3 puertos de red del router wireless situados en la parte trasera de la unidad, o red WiFi preconfigurada (ver página 23)

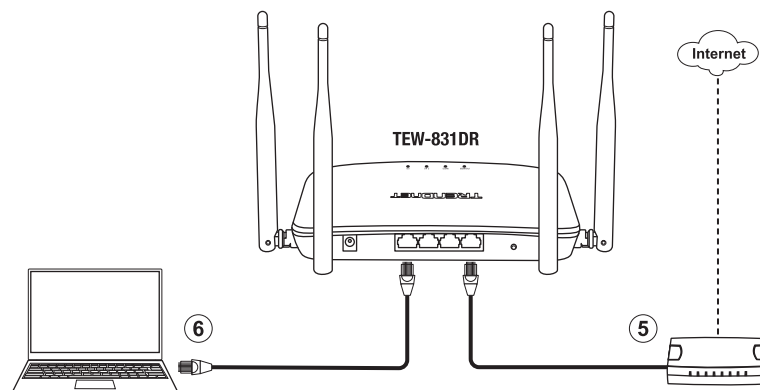

7. Encienda el módem. Espere hasta que los LED del módem indiquen que está completamente disponible (**aproximadamente 2-3 minutos**). Para obtener más detalles sobre los LED del módem, consulte la guía del usuario del módem.
8. Conecte el adaptador de alimentación a la parte trasera del router y después a una toma de corriente.
9. Compruebe que los LED azules de estado de la parte frontal del router (**alimentación, 2.4G, 5G**) estén encendidos.

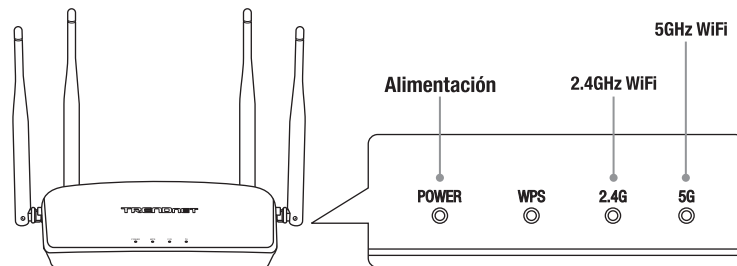

10. Abra su navegador web desde la computadora conectada; el asistente aparecerá automáticamente. Seleccione el idioma deseado y después haga clic en **Next** (Siguiente). Si no aparece el asistente, escriba <http://tew-831dr> en la barra de direcciones de su navegador web y pulse **Intro**.

Nota: También puede acceder al dispositivo utilizando la dirección IP por defecto (<http://192.168.10.1>).

11. Para iniciar el asistente de configuración, haga clic en **"Next" (Siguiente)**.

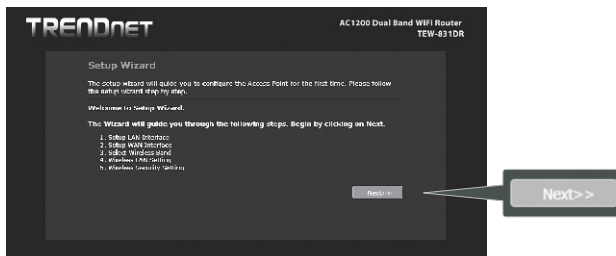

12. Configure la dirección IP de su router y haga clic en **"Next" (Siguiente)**.

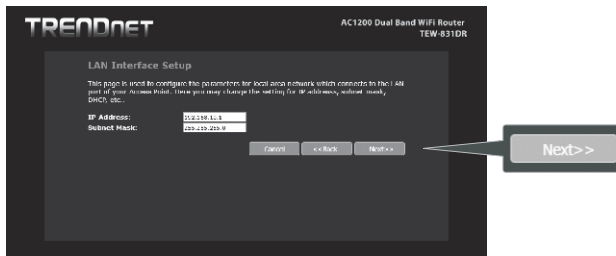

13. Configure su tipo de acceso a la WAN y haga clic en "Next" (Siguiente).

Nota: Es posible que tenga que ponerse en contacto con su proveedor de servicios de Internet para obtener información adicional.

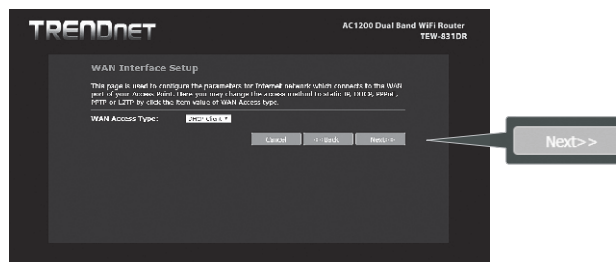

14. Establezca su configuración wireless de 5GHz y haga clic en "Next" (Siguiente).

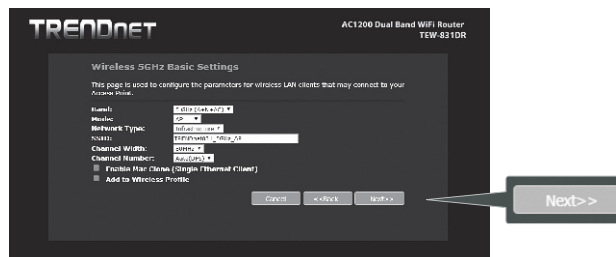

15. Configure su clave wireless de 5GHz y haga clic en "Next" (Siguiente).

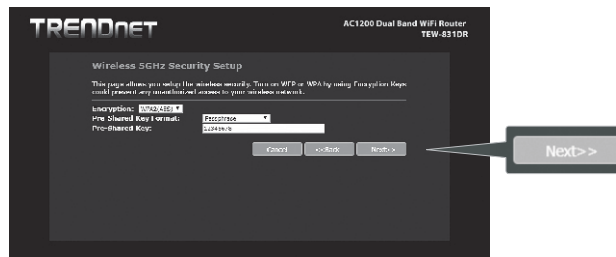

15. Configure su clave wireless de 2.4GHz y haga clic en "Next" (Siguiente).

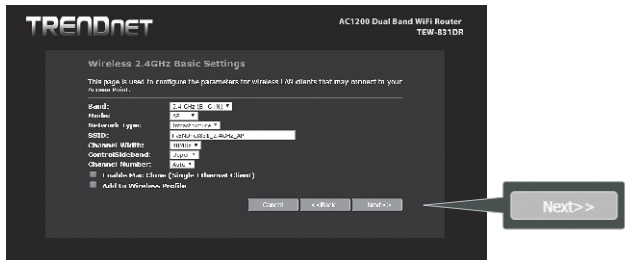

17. Configure su clave wireless de 2.4GHz. Una vez terminada la configuración wireless inicial, pulse el botón "Finish" (Terminado) para aplicar la configuración y reiniciar el router.



18. Abra un navegador web y escriba una dirección web (p. ej. www.trendnet.com) para comprobar que esté conectado a Internet.

La instalación del router wireless ha finalizado.

Si desea información más detallada sobre la configuración del router wireless y sus opciones avanzadas, consulte la Guía del Usuario en la página de soporte de TRENDnet, www.trendnet.com/support.

1. Antes de começar

Conteúdo da embalagem

- TEW-831DR
- Guia de instalação rápida
- Cabo de rede (1,5m / 5pés)
- Adaptador de energia (12V DC, 1A)

Requisitos de instalação

- Um computador com uma placa de rede com fio ou wireless e um navegador de Internet
- Internet de banda larga
- Modem instalado

ENGLISH

FRANÇAIS

DEUTSCH

ESPAÑOL



PORTUGUÊS

ITALIANO

РУССКИЙ

Note:

- Nós pré-criptografamos o TEW-831DR com um Nome de WiFi exclusivo (SSID) e uma chave de WiFi (senha do WiFi). Você pode encontrar essas pré-configurações nas etiquetas na parte superior e na parte inferior do roteador. Você usará essas informações para conectar o roteador sem o uso de fios. Para alterar a chave do WiFi, consulte o guia do usuário. Se o roteador wireless for restabelecido para o padrão de fábrica, o nome e a chave do WiFi também serão restabelecidos para os padrões de fábrica.
- Para entrar novamente na interface de controle do roteador wireless, será necessário saber o nome de usuário e a senha de login de gerenciamento do roteador. Você pode encontrar o nome de usuário e senha padrão nas etiquetas na parte superior e na parte inferior do roteador.

Preset Wireless Settings	
Wi-Fi Name/SSID (AC/N) TRENDnetXXX_5GHz_XXXX (N/B/G) TRENDnetXXX_2.4GHz_XXXX	
Wi-Fi Password XXXXXXXXXXXXXXXX	
Management Login http://tew-831dr username: admin password: XXXXXX	

2. Instalação

Nota: Recomendamos que você configure o roteador wireless através de um computador com fio.

1. Fixe as antenas na a obter a melhor cobertura WiFi. Recomendamos que você posicione todas as antenas verticalmente conforme exibido.



2. Usando um computador conectado através de uma rede com cabo ou wireless, verifique se você tem conexão com a Internet com seu modem ou roteador existente.
 3. Desligue seu modem.
- Nota:** Se o seu modem inclui um bateria reserva, remova-a também.
4. Desconecte a energia e todos os cabos entre seu modem e roteador existente.
 5. Conecte seu modem à porta de WAN do TEW-831DR localizada na traseira da unidade usando o cabo de rede incluído.

ENGLISH

FRANÇAIS

DEUTSCH

ESPAÑOL

PORTUGUÊS

ITALIANO

РУССКИЙ

6. Usando outro cabo de rede, conecte seu computador a uma das 3 portas de rede do roteador wireless, localizadas na traseira da unidade, rede WiFi pré-configurada (consulte a página 30).

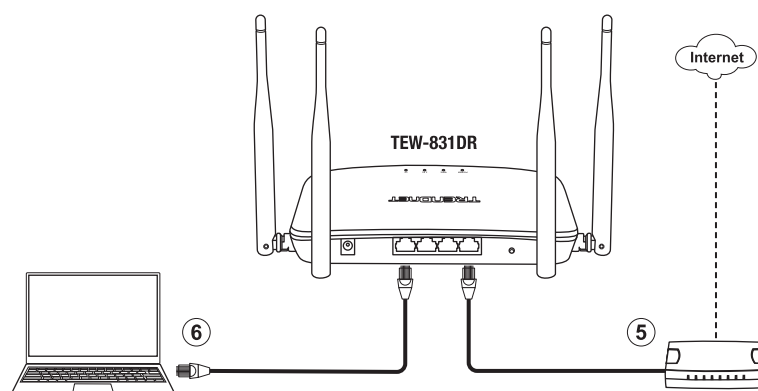

7. Ligue seu modem. Aguarde até que as luzes de LED do modem indiquem que ele está totalmente funcional (**aproximadamente 2 a 3 minutos**). Para obter mais informações sobre as luzes de LED do modem, consulte o guia do usuário do modem.

8. Conecte o adaptador de energia na traseira do roteador e em seguida a uma tomada.

9. Verifique se as luzes de LED de status azuis na frente do roteador (**Energia, 2.4G, 5G**) estão acesas.

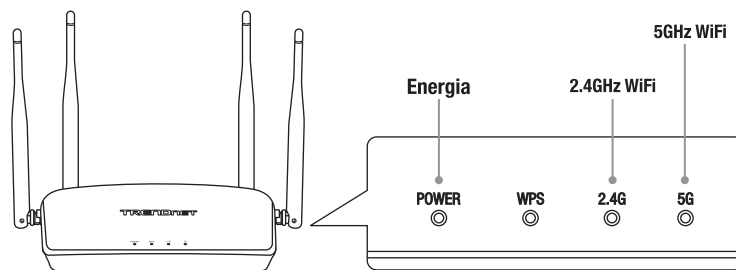

10. Abra o navegador de Internet do computador conectado; o assistente aparecerá automaticamente. Selecione o idioma desejado e depois clique em **Avançar**. Se o assistente não aparecer, digite <http://tew-831dr> na barra de endereço do seu navegador e pressione **Enter**.

Nota: Também é possível acessar o dispositivo usando o endereço IP padrão (<http://192.168.10.1>).

11. Para iniciar o Assistente de instalação, clique em **"Next" (Avançar)**.

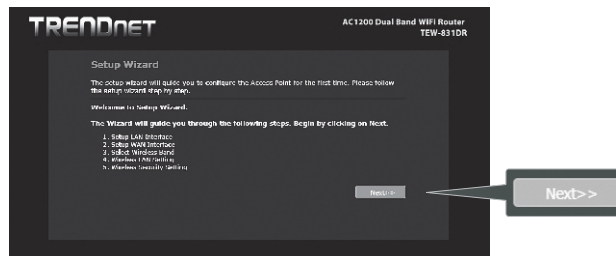

12. Configure o endereço IP do roteador e clique em **"Next" (Avançar)**.

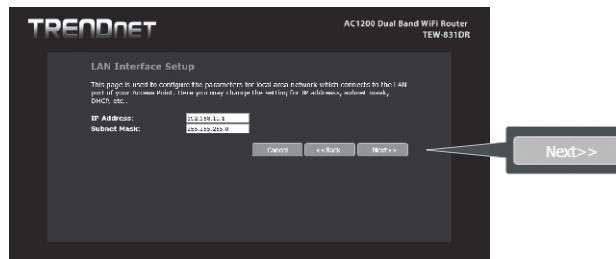

13. Configure o tipo de acesso WAN e clique em "Next" (Avançar).

Nota: Pode ser necessário entrar em contato com seu provedor de serviços de Internet para obter informações adicionais.



14. Configure os parâmetros sem fio 5GHz e clique em "Next" (Avançar).

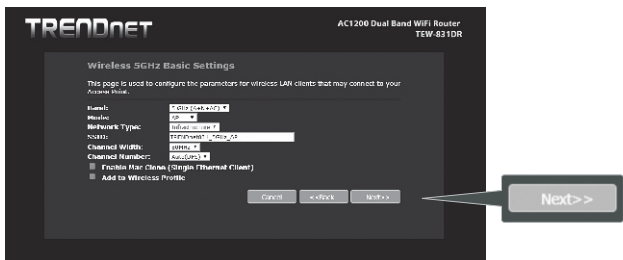

15. Configure a chave sem fio 5GHz e clique em "Next" (Avançar).

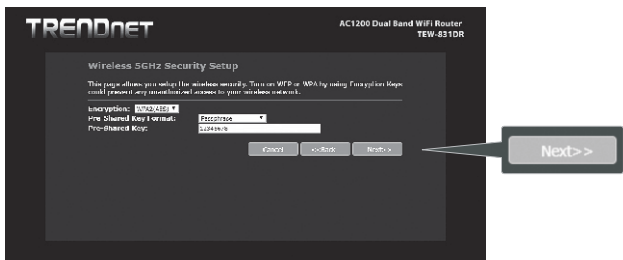

16. Configure a chave sem fio 2.4GHz e clique em "Next" (Avançar).

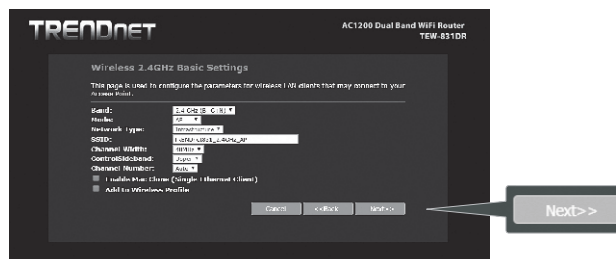

17. Configure a chave sem fio 2,4 GHz. Quando todas as configurações sem fio estiverem concluídas, pressione o botão "Finished" (Concluído) para aplicar as configurações e reiniciar o roteador.



18. Abra um navegador de Internet e insira um endereço da Internet (por exemplo www.trendnet.com) para verificar se você tem uma conexão com a Internet.

A instalação do roteador wireless agora está completa.

Para obter informações detalhadas sobre a configuração do roteador wireless e configurações avançadas, por favor, consulte o Guia do Usuário na página de suporte da TRENDnet, www.trendnet.com/support.

ENGLISH

FRANÇAIS

DEUTSCH

ESPAÑOL

PORTUGUÊS

ITALIANO

РУССКИЙ

ENGLISH

1. Prima di cominciare

Contenuto della Confezione

- TEW-831DR
- Guida di installazione rapida
- Cavo di rete (1.5m / 5ft.)
- Alimentatore (12V DC, 1A)

FRANÇAIS

Requisiti per l'installazione

- Un computer con adattatore di rete su cavo o wireless ed un web browser
- Internet a larga banda
- Modem installato

DEUTSCH

ESPAÑOL

PORTUGUÊS

ITALIANO

РУССКИЙ

2. Installazione

Nota: Si raccomanda di configurare il router wireless da un computer connesso su cavo.

1. Inserite le antenne sul retro e sui fianchi del router e posizionatele per avere la migliore copertura WiFi. Si raccomanda di orientare le antenne verticalmente come mostrato.

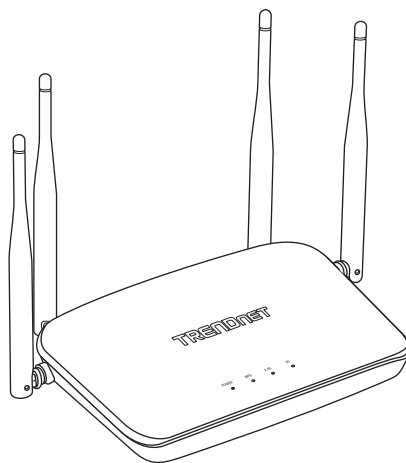

2. Usando un computer connesso in rete via cavo o wireless, verificate di avere una connessione ad Internet tramite il vostro router o modem esistente.

3. Spegnete il modem.

Nota: Se il modem contiene una batteria di emergenza, rimuovete anche la batteria.

4. Scollegate l'alimentazione e tutti i cavi tra il modem ed il router esistente.

5. Collegate il vostro modem alla porta Internet WAN del TEW-831DR, posata sul retro dell'unità, usando il cavo di rete incluso.

Nota:

- Abbiamo pre-crittografato il TEW-831DR con un nome WiFi (SSID) ed una chiave WiFi (WiFi password) univoci. Potete trovare questi parametri preconfigurati sulle etichette poste sul fianco e sul fondo del router. Userete queste informazioni per collegarvi al router via wireless. Per cambiare la chiave WiFi, fate riferimento alla guida utente. Se il router wireless viene resettato, anche il nome WiFi e la chiave WiFi verranno riportati ai valori preconfigurati di fabbrica
- Per entrare di nuovo nella interfaccia di gestione del router wireless, avrete bisogno di conoscere la username e password di accesso del router. Potete trovare username e password di fabbrica sulle etichette poste sopra e sul fondo del router.

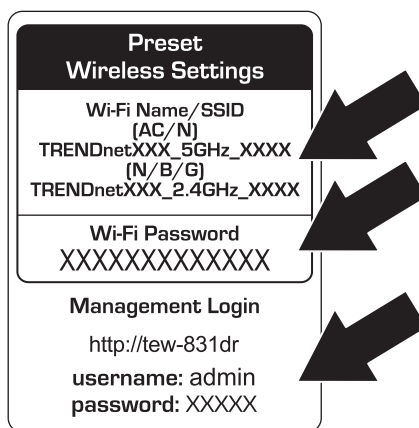

6. Usando un diverso cavo di rete, collegate il vostro computer ad una delle 3 porte di rete del router wireless, poste sul retro dell'unità, rete WiFi preconfigurata (Vedere pagina 37).

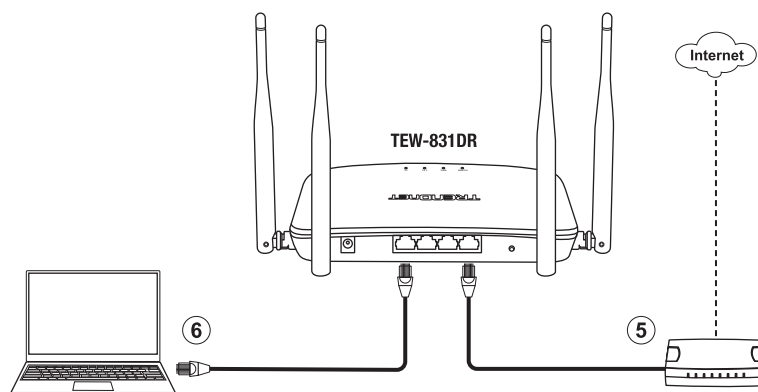

7. Accendete il vostro modem. Attendete finchè le luci LED sul modem indicano che è completamente avviato (**approssimativamente 2-3 minuti**). Per maggiori informazioni sulle luci LED del vostro modem, prego fate riferimento alla relativa guida utente.
8. Collegate l'alimentatore sul retro del router e quindi ad una presa di corrente.
9. Verificate che siano accese le luci LED blu di stato sul frontale del router (**Power, 2,4G, 5G**) e la luce.

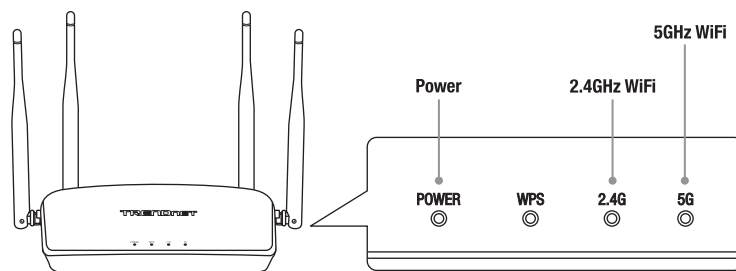

10. Aprire il web browser sul computer collegato; apparirà automaticamente il wizard.
Selezionate la lingua desiderata e quindi cliccate **Next**. Se il wizard non appare, digitate <http://192.168.10.1> nella barra indirizzi del vostro web browser e premete **Invio**.

Nota: Potete accedere al dispositivo anche usando l'indirizzo IP di fabbrica (<http://192.168.10.1>).

11. Per avviare l'installazione guidata fare clic su "**Next**" (**Avanti**).

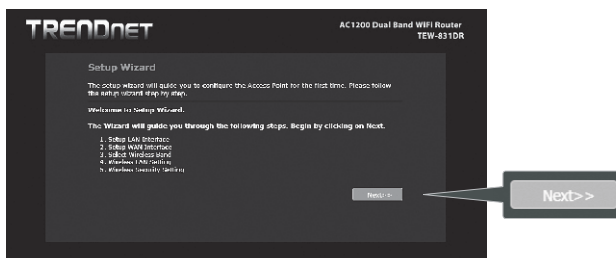

12. Impostare l'indirizzo IP del router, quindi fare clic su "**Next**" (**Avanti**).

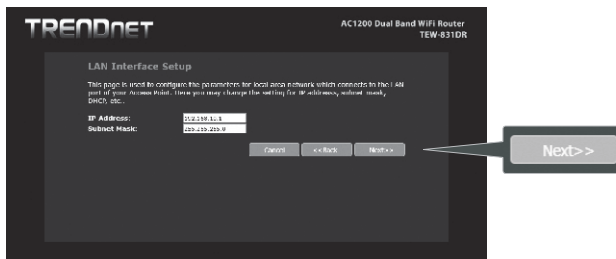

16. Configurare la wireless key a 2.4GHz, quindi fare clic su "Next" (Avanti).

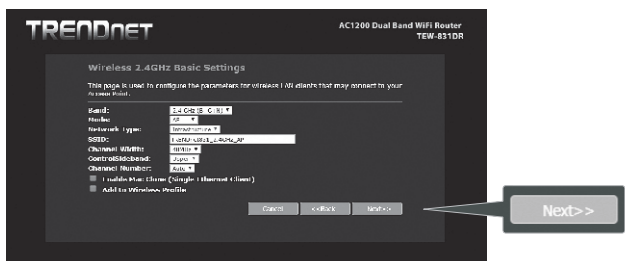

17. Configurare la wireless key a 2,4 GHz. Una volta che tutte le impostazioni wireless sono state completate. Premere il pulsante "Finished" (Fine) per applicare le impostazioni e riavviare il router.

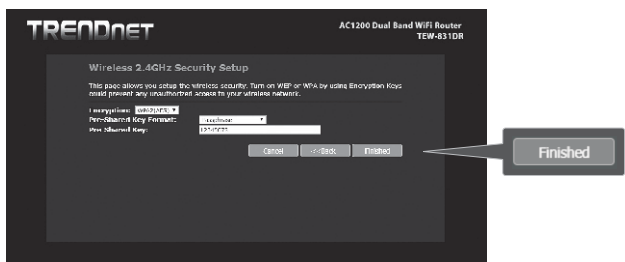

18. Aprire un web browser ed inserire un indirizzo web (per esempio www.trendnet.com) per verificare di avere connessione ad Internet.

L'installazione del router wireless è ora completa.

Per informazioni dettagliate riguardo alla configurazione del router wireless e per i parametri avanzati, Fare riferimento alla Guida Utente nella pagina di assistenza di TRENDnet, www.trendnet.com/support.

1. Перед началом работы

Содержимое упаковки

- TEW-831DR
- Руководство по установке
- Сетевой кабель (1.5м / 5футов)
- Блок питания (12В постоянного тока, 1А)

Минимальные требования

- Компьютер с проводным или беспроводным сетевым адаптером и веб-браузером
- Широкополосный доступ в Интернет
- Установленный модем

ENGLISH

FRANÇAIS

DEUTSCH

ESPAÑOL

PORTUGUÊS

ITALIANO

РУССКИЙ

Примечание:

- Мы предварительно зашифровали TEW-831DR уникальным Именем WiFi (SSID) и Ключом WiFi (паролем WiFi). Эти предварительные настройки указаны на этикетках на верхней и нижней панелях маршрутизатора. Эта информация понадобится вам для беспроводного доступа к маршрутизатору. Для изменения Ключа WiFi обратитесь к руководству пользователя. Если настройки маршрутизатора будут сброшены к заводским, Имя WiFi и Ключ WiFi также будут возвращены к заводским.
- Чтобы заново войти в интерфейс управления беспроводного маршрутизатора, Вам понадобится административный логин и пароль от маршрутизатора. Логин и пароль по умолчанию находятся на нижней стороне корпуса устройства.

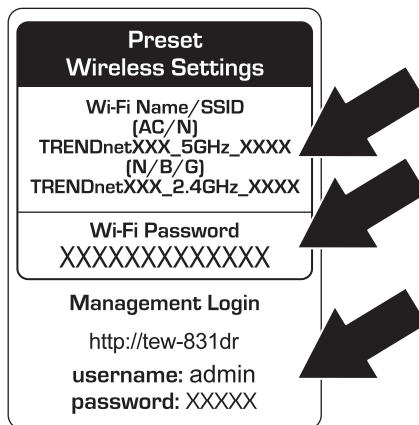

2. Инсталляция

Примечание: Рекомендуется провести конфигурацию беспроводного маршрутизатора с помощью подключенного к нему через кабель компьютера.

1. Рикрепите антенны к задней и боковой панели вашего маршрутизатора и расположите их для лучшего покрытия WiFi. Рекомендуется установить все антенны вертикально, как показано на рисунке.

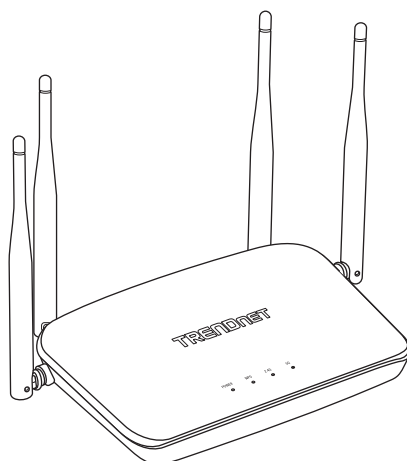

2. С помощью компьютера, подключенного к проводной или беспроводной сети, проверьте наличие подключения к Интернет через ваш модем или маршрутизатор.
3. Выключите модем.

Примечание: Если ваш модем включает в себя резервный аккумулятор, также извлеките его.

4. Выключите питание и отсоедините все кабеля между вашим модемом и маршрутизатором.
5. Подключите модем к интернет-WAN-порту на TEW-831DR, размещенному на задней панели устройства, с помощью идущего в комплекте сетевого кабеля.

ENGLISH

FRANÇAIS

DEUTSCH

ESPAÑOL

PORTUGUÊS

ITALIANO

РУССКИЙ

6. С помощью другого сетевого кабеля подключите компьютер к одному из 3 сетевых портов беспроводного маршрутизатора, расположенных на задней панели устройства, предварительно настроенная сеть WiFi (См. стр. 44)

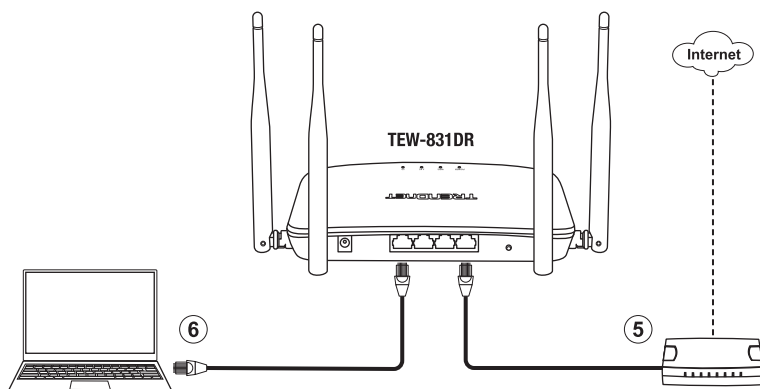

7. Включите модем. Подождите, пока светодиоды на модеме не покажут, что он находится в полностью рабочем состоянии (**приблизительно 2-3 минуты**). Для получения более подробной информации об индикаторах вашего модема обратитесь к руководству пользователя вашего модема.
8. Присоедините блок питания к задней панели маршрутизатора, затем вставьте его в электрическую розетку.
9. Убедитесь, что синие индикаторы состояния на передней панели маршрутизатора (**Питание, 2.4G, 5G**) к которому подключен ваш компьютер светятся.

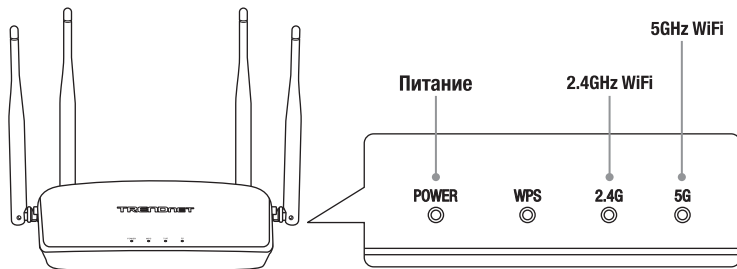

10. Откройте веб-браузер на подключенном компьютере, после чего автоматически появится мастер настройки. Выберите нужный язык и нажмите **Next (Далее)**. Если мастер настройки не появится, напишите в адресной строке вашего браузера `http://tew-831dr` и нажмите **Enter** (Ввод).

Примечание: Вы также можете получить доступ к устройству по стандартному IP-адресу `http://192.168.10.1`).

11. Для запуска мастера установки нажмите **"Next" (Далее)**.

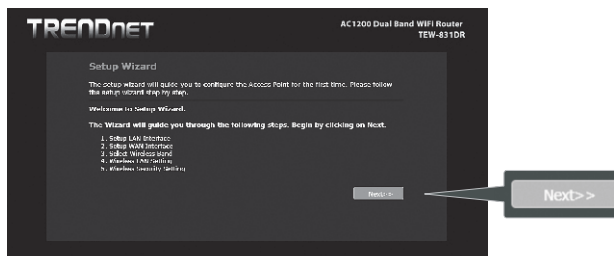

12. Настройте IP-адрес маршрутизатора, а затем нажмите **"Next" (Далее)**.

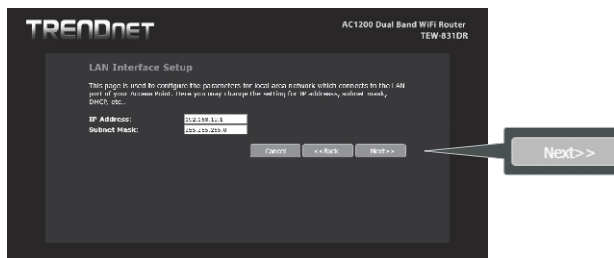

13. Настройте тип доступа WAN, а затем нажмите "Next" (Далее).

Примечание: Возможно что, Вам придется связаться с Вашим Интернет-провайдером для получения дополнительной информации.

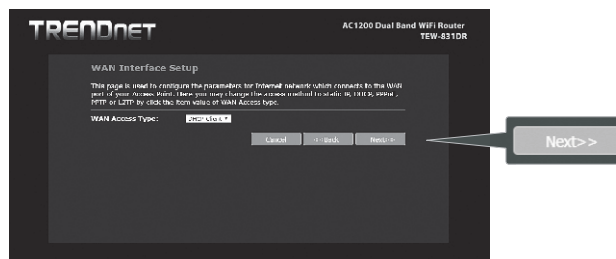

14. Настройте тип доступа WAN, а затем нажмите "Next" (Далее).

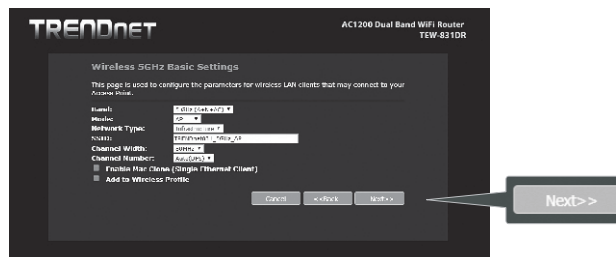

15. Настройте параметры беспроводной сети 5 ГГц, а затем нажмите "Next" (Далее).

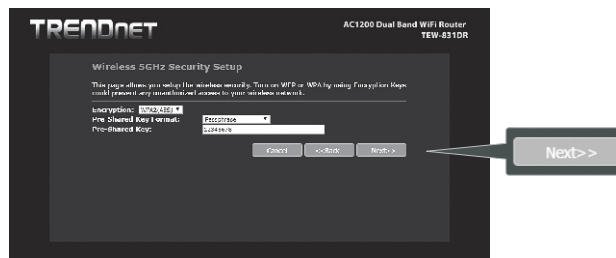

16. Настройте параметры беспроводной сети 2,4 ГГц, а затем нажмите "Next" (Далее).

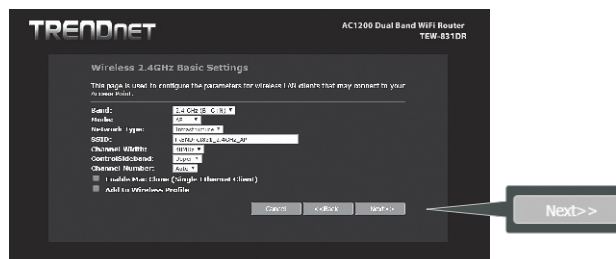

17. Настройте беспроводной ключ 2,4 ГГц. После того, как все настройки беспроводной сети завершены. Нажмите на кнопку «Готово» (Finished), чтобы применить настройки и перезагрузить маршрутизатор.



18. Откройте веб-браузер и введите веб-адрес (например, www.trendnet.com), чтобы проверить наличие интернет-соединения.

Теперь установка беспроводного маршрутизатора завершена.

Дополнительную информацию о конфигурации беспроводного маршрутизатора и расширенных настройках вы можете найти в руководстве пользователя на сайте, www.trendnet.com/support.

Бесплатная линия технической поддержки для США и Канады (по-английски) :
855-373-4741

Расписание работы: Понедельник-Пятница с 7:00 до 18:00 (Тихоокеанский часовой пояс).

Во вне рабочее время : 866-845-3673

ENGLISH

FRANÇAIS

DEUTSCH

ESPAÑOL

PORTUGUÊS

ITALIANO

РУССКИЙ

Declaration of Conformity

TRENDNET®

Manufacturer's Name and Address

TRENDnet, Inc.
20675 Manhattan Place
Torrance, CA 90501 USA

Zwolsestraat 156 2587 WB
The Hague The Netherlands



Product Information

Model Number: TEW-831DR
Product Name: AC1200 Dual Band WiFi Router
Trade Name: TRENDnet

TRENDnet hereby declare that the product is in compliance with the essential requirements and other relevant provisions under our sole responsibility.

Safety EN 62368-1:2014
EMC EN 301 489-1 V2.1.1 (2017-02)
EN 301 489-17 V3.1.1 (2017-02)
EN 55032: 2012+ AC: 2013
EN 55024: 2010

Radio Spectrum & Health

EN 300 328 V2.1.1 (2016-11)
EN 301 893 V2.1.1 (2017-05)
EN 62311: 2008

Energy Efficiency Regulation (EC) No. 1275/2008, No. 801/2013

This product is herewith confirmed to comply with the Directives.

Directives: Low Voltage Directive 2014/35/EU
EMC Directive 2014/30/EU
RE Directive 2014/53/EU
EMF Directive 1999/519/EU 2013/35/EU
Ecodesign Directive 2009/125/EU
RoHS Directive 2011/65/EU
WEEE Directive 2012/19/EU
REACH Regulation (EU) No. 1907/2006

Person responsible for this declaration.

Place of Issue: Torrance, California, USA

Date: November 21, 2019

Name: Sonny Su

Title: Director of Technology

Signature:

A handwritten signature in black ink, appearing to read 'Sonny Su', is written over a horizontal line.



Déclaration de conformité

TRENDNET®

Nom et adresse du fabricant

TRENDnet, Inc.
20675 Manhattan Place
Torrance, CA 90501 USA

Zwolsestraat 156 2587 WB
The Hague The Netherlands



Détails du produit

Modèle: TEW-831DR
Nom du produit: Routeur WiFi dual band AC1200
Nom Commercial: TRENDnet

TRENDnet déclare par la présente que le produit est conforme aux exigences essentielles et aux autres dispositions pertinentes de la Directive en vertu de notre seule responsabilité.

Sécurité EN 62368-1:2014
CEM EN 301 489-1 V2.1.1 (2017-02)
EN 301 489-17 V3.1.1 (2017-02)
EN 55032: 2012+ AC: 2013
EN 55024: 2010

Spectre radio et santé

EN 300 328 V2.1.1 (2016-11)
EN 301 893 V2.1.1 (2017-05)
EN 62311: 2008

Efficacité énergétique Règlement (CE) N° 1275/2008, N° 801/2013

Ce produit est conforme à la directives suivante.

Directives: Directive Basse Tension 2014/35/UE
Directive CEM 2014/30/UE
Directive RE 2014/53/UE
Directive EMF 1999/519/UE 2013/35/UE
Directive Écoconception 2009/125/UE
Directive RoHS 2011/65/UE
Directive WEEE 2012/19/UE
REACH Règlement (UE) N° 1907/2006

Personne responsable de cette déclaration.

Lieu de délivrance: Torrance, California, USA

Date: 21 Novembre, 2019

Nom: Sonny Su

Position: Director of Technology

Signature:



TRENDnet[®]

Certifications

This device complies with Part 15 of the FCC Rules. Operation is subject to the following two conditions:

- (1) This device may not cause harmful interference.
- (2) This device must accept any interference received, including interference that may cause undesired operation.



Waste electrical and electronic products must not be disposed of with household waste. Please recycle where facilities exist. Check with your Local Authority or Retailer for recycling advice.

Applies to PoE Products Only: This product is to be connected only to PoE networks without routing to the outside plant.

Note

The Manufacturer is not responsible for any radio or TV interference caused by unauthorized modifications to this equipment. Such modifications could void the user's authority to operate the equipment.

Advertencia

En todos nuestros equipos se mencionan claramente las características del adaptador de alimentación necesario para su funcionamiento. El uso de un adaptador distinto al mencionado puede producir daños físicos y/o daños al equipo conectado. El adaptador de alimentación debe operar con voltaje y frecuencia de la energía eléctrica domiciliar existente en el país o zona de instalación.

Technical Support

If you have any questions regarding the product installation, please contact our Technical Support. Toll free US/Canada: **1-855-373-4741**
Regional phone numbers available at www.trendnet.com/support

TRENDnet
20675 Manhattan Place
Torrance, CA 90501
USA

Product Warranty Registration

Please take a moment to register your product online. Go to TRENDnet's website at: www.trendnet.com/register

120*150mm 80g 书写纸 单黑 骑马钉