

FCC Radio Test Report

FCC ID: XU8TEW831DR

This report concerns: **Original Grant**

Project No. : 2001C070
Equipment : AC1200 Wireless Dual band Gigabit Router
Brand Name : TRENDnet
Test Model : TEW-831DR
Series Model : N/A
Applicant : TRENDnet,Inc.
Address : 20675 Manhattan Place ,Torrance, CA 90501 USA
Manufacturer : TRENDnet,Inc.
Address : 20675 Manhattan Place ,Torrance, CA 90501 USA
Factory : SHENZHEN GONGJIN ELECTRONICS CO.,LTD
Address : No.2, Danzi North Road,Kengzi Street, Shenzhen, Guangdong, China
Date of Receipt : Jan. 19, 2020
Date of Test : Jan. 19, 2020 ~ Jun. 10, 2020
Issued Date : Jul. 16, 2020
Report Version : R02
Test Sample : Engineering Sample No.: DG2020011969 for conducted, DG202005095 for radiated
Standard(s) : FCC Part15, Subpart E(15.407)
ANSI C63.10-2013
FCC KDB 789033 D02 General UNII Test Procedures New Rules v02r01
FCC KDB 662911 D01 Multiple Transmitter Output v02r01

The above equipment has been tested and found compliance with the requirement of the relative standards by BTL Inc.



Prepared by : Vincent Tan



Approved by : Ethan Ma



Certificate #5123.02

Add: No.3, Jinshagang 1st Road, Shixia, Dalang Town,Dongguan, Guangdong, China.

Tel: +86-769-8318-3000

Web: www.newbtl.com

Declaration

BTL represents to the client that testing is done in accordance with standard procedures as applicable and that test instruments used has been calibrated with standards traceable to international standard(s) and/or national standard(s).

BTL's reports apply only to the specific samples tested under conditions. It is manufacture's responsibility to ensure that additional production units of this model are manufactured with the identical electrical and mechanical components. **BTL** shall have no liability for any declarations, inferences or generalizations drawn by the client or others from **BTL** issued reports.

The report must not be used by the client to claim product certification, approval, or endorsement by NVLAP, NIST, A2LA, or any agency of the U.S. Government.

This report is the confidential property of the client. As a mutual protection to the clients, the public and ourselves, the test report shall not be reproduced, except in full, without our written approval.

BTL's laboratory quality assurance procedures are in compliance with the **ISO/IEC 17025** requirements, and accredited by the conformity assessment authorities listed in this test report.

BTL is not responsible for the sampling stage, so the results only apply to the sample as received.

The information, data and test plan are provided by manufacturer which may affect the validity of results, so it is manufacturer's responsibility to ensure that the apparatus meets the essential requirements of applied standards and in all the possible configurations as representative of its intended use.

Limitation

For the use of the authority's logo is limited unless the Test Standard(s)/Scope(s)/Item(s) mentioned in this test report is (are) included in the conformity assessment authorities acceptance respective.

Please note that the measurement uncertainty is provided for informational purpose only and are not use in determining the Pass/Fail results.

Table of Contents	Page
REPORT ISSUED HISTORY	6
1 . SUMMARY OF TEST RESULTS	7
1.1 TEST FACILITY	8
1.2 MEASUREMENT UNCERTAINTY	8
1.3 TEST ENVIRONMENT CONDITIONS	8
2 . GENERAL INFORMATION	9
2.1 GENERAL DESCRIPTION OF EUT	9
2.2 TEST MODES	12
2.3 PARAMETERS OF TEST SOFTWARE	15
2.4 DUTY CYCLE	17
2.5 BLOCK DIAGRAM SHOWING THE CONFIGURATION OF SYSTEM TESTED	19
2.6 SUPPORT UNITS	19
3 . AC POWER LINE CONDUCTED EMISSIONS TEST	20
3.1 LIMIT	20
3.2 TEST PROCEDURE	20
3.3 DEVIATION FROM TEST STANDARD	20
3.4 TEST SETUP	21
3.5 EUT OPERATION CONDITIONS	21
3.6 TEST RESULTS	21
4 . RADIATED EMISSIONS TEST	22
4.1 LIMIT	22
4.2 TEST PROCEDURE	23
4.3 DEVIATION FROM TEST STANDARD	23
4.4 TEST SETUP	24
4.5 EUT OPERATION CONDITIONS	25
4.6 TEST RESULTS - 9 KHZ to 30 MHZ	25
4.7 TEST RESULTS - 30 MHz TO 1000 MHz	25
4.8 TEST RESULTS - ABOVE 1000 MHz	25
5 . BANDWIDTH TEST	26
5.1 LIMIT	26
5.2 TEST PROCEDURE	26

Table of Contents	Page
5.3 TEST PROCEDURE	26
5.4 TEST SETUP	26
5.5 EUT OPERATION CONDITIONS	26
5.6 TEST RESULTS	26
6 . MAXIMUM OUTPUT POWER TEST	27
6.1 LIMIT	27
6.2 TEST PROCEDURE	27
6.3 DEVIATION FROM STANDARD	27
6.4 TEST SETUP	27
6.5 EUT OPERATION CONDITIONS	27
6.6 TEST RESULTS	27
7 . POWER SPECTRAL DENSITY TEST	28
7.1 LIMIT	28
7.2 TEST PROCEDURE	28
7.3 DEVIATION FROM STANDARD	28
7.4 TEST SETUP	28
7.5 EUT OPERATION CONDITIONS	28
7.6 TEST RESULTS	28
8 . FREQUENCY STABILITY MEASUREMENT	29
8.1 LIMIT	29
8.2 TEST PROCEDURE	29
8.3 DEVIATION FROM STANDARD	29
8.4 TEST SETUP	29
8.5 EUT OPERATION CONDITIONS	29
8.6 TEST RESULTS	29
9 . MEASUREMENT INSTRUMENTS LIST	30
10 . EUT TEST PHOTOS	32
APPENDIX A - AC POWER LINE CONDUCTED EMISSIONS	36
APPENDIX B - RADIATED EMISSION - 9 KHZ TO 30 MHZ	39
APPENDIX C - RADIATED EMISSION - 30 MHZ TO 1 GHZ	44
APPENDIX D - RADIATED EMISSION - ABOVE 1000 MHZ	47

Table of Contents**Page**

APPENDIX E - BANDWIDTH	122
APPENDIX F - MAXIMUM OUTPUT POWER	133
APPENDIX G - POWER SPECTRAL DENSITY	155
APPENDIX H - FREQUENCY STABILITY	163

REPORT ISSUED HISTORY

Report Version	Description	Issued Date
R00	Original Issue.	Jun. 17, 2020
R01	Revised report to address comments.	Jul. 10, 2020
R02	Revised report to address comments.	Jul. 16, 2020

1. SUMMARY OF TEST RESULTS

Test procedures according to the technical standard(s):

FCC Part15, Subpart E(15.407)				
Standard(s) Section	Test Item	Test Result	Judgment	Remark
15.207 15.407(b)	AC Power Line Conducted Emissions	APPENDIX A	PASS	-----
15.407(b) 15.205(a) 15.209(a)	Radiated Emissions	APPENDIX B APPENDIX C APPENDIX D	PASS	-----
15.407(a) 15.407(e)	Spectrum Bandwidth	APPENDIX E	PASS	-----
15.407(a)	Maximum Output Power	APPENDIX F	PASS	-----
15.407(a)	Power Spectral Density	APPENDIX G	PASS	-----
15.407(g)	Frequency Stability	APPENDIX H	PASS	-----
15.203	Antenna Requirements	-----	PASS	NOTE (2)
15.407(c)	Automatically Discontinue Transmission	-----	PASS	NOTE (3)

Note:

- (1) "N/A" denotes test is not applicable in this test report.
- (2) The device what use a permanently attached antenna were considered sufficient to comply with the provisions of 15.203.
- (3) During no any information transmission, the EUT can automatically discontinue transmission and become standby mode for power saving. the EUT can detect the controlling signal of ACK message transmitting from remote device and verify whether it shall resend or discontinue transmission.
- (4) For UNII-1 this device was functioned as a
 Access point device Client device

1.1 TEST FACILITY

The test facilities used to collect the test data in this report is at the location of No.3,Jinshagang 1st Road, Shixia, Dalang Town, Dongguan, Guangdong, China.

BTL's Test Firm Registration Number for FCC: 357015

BTL's Designation Number for FCC: CN1240

1.2 MEASUREMENT UNCERTAINTY

ISO/IEC 17025 requires that an estimate of the measurement uncertainties associated with the emissions test results be included in the report. The measurement uncertainties given below are based on a 95% confidence level (based on a coverage factor (k=2))

The BTL measurement uncertainty as below table:

A. AC power line conducted emissions test:

Test Site	Method	Measurement Frequency Range	U, (dB)
DG-C02	CISPR	150kHz ~ 30MHz	2.60

B. Radiated emissions test:

Test Site	Method	Measurement Frequency Range	Ant. H / V	U, (dB)
DG-CB03	CISPR	9kHz ~ 30MHz	V	3.79
		9kHz ~ 30MHz	H	3.57
		30MHz ~ 200MHz	V	4.88
		30MHz ~ 200MHz	H	4.14
		200MHz ~ 1,000MHz	V	4.62
		200MHz ~ 1,000MHz	H	4.80
		1GHz ~ 6GHz	-	4.58
		6GHz ~ 18GHz	-	5.18
		18GHz ~ 26.5GHz	-	3.62
		26.5GHz ~ 40GHz	-	4.00

C. Other Measurement:

Parameter	Uncertainty
Spectrum Bandwidth	±3.8 %
Maximum Output Power	±0.95 dB
Power Spectral Density	±0.86 dB
Frequency Stability	±0.16 dB
Temperature	±0.08 °C
Time	±0.58 %
Supply voltages	±0.3 %

Note: Unless specifically mentioned, the uncertainty of measurement has not been taken into account to declare the compliance or non-compliance to the specification.

1.3 TEST ENVIRONMENT CONDITIONS

Test Item	Temperature	Humidity	Test Voltage	Tested By
AC Power Line Conducted Emissions	25°C	53%	AC 120V/60Hz	Kwok Guo
Radiated Emissions-9K-30MHz	25°C	60%	AC 120V/60Hz	Kwok Guo
Radiated Emissions-30 MHz to 1GHz	24°C	68%	AC 120V/60Hz	Kwok Guo
Radiated Emissions-Above 1000 MHz	24°C	68%	AC 120V/60Hz	Kwok Guo
Spectrum Bandwidth	24°C	52%	AC 120V/60Hz	Hayden Chen
Maximum Output Power	24°C	52%	AC 120V/60Hz	Laughing Zhang
Power Spectral Density	24°C	52%	AC 120V/60Hz	Hayden Chen
Frequency Stability	Normal & Extreme	52%	Normal & Extreme	Hayden Chen

2. GENERAL INFORMATION

2.1 GENERAL DESCRIPTION OF EUT

Equipment	AC1200 Wireless Dual band Gigabit Router
Brand Name	TRENDnet
Test Model	TEW-831DR
Series Model	N/A
Model Difference(s)	N/A
Power Source	DC Voltage supplied from AC/DC adapter. Model: GQ12-120100-HU
Power Rating	I/P:100-240V~50/60Hz 0.4A MAX O/P:12V  1.0A
Operation Frequency	UNII-1: 5150 MHz~5250 MHz UNII-3: 5725 MHz~5850 MHz
Modulation Type	OFDM
Bit Rate of Transmitter	Up to 866.7 Mbps
Maximum Output Power for UNII-1_Non Beamforming	IEEE 802.11a: 16.96 dBm (0.0497 W) IEEE 802.11n (HT20): 15.30 dBm (0.0339 W) IEEE 802.11n (HT40): 15.02 dBm (0.0318 W) IEEE 802.11ac (VHT20): 13.04 dBm (0.0201 W) IEEE 802.11ac (VHT40): 12.93 dBm (0.0196 W) IEEE 802.11ac (VHT80): 13.04 dBm (0.0201 W)
Maximum Output Power for UNII-3_Non Beamforming	IEEE 802.11a: 16.97 dBm (0.0498 W) IEEE 802.11n (HT20): 15.06 dBm (0.0321 W) IEEE 802.11n (HT40): 14.87 dBm (0.0307 W) IEEE 802.11ac (VHT20): 12.92 dBm (0.0196 W) IEEE 802.11ac (VHT40): 12.82 dBm (0.0191 W) IEEE 802.11ac (VHT80): 12.91 dBm (0.0195 W)
Maximum Output Power for UNII-1_Beamforming	IEEE 802.11n (HT20): 15.24 dBm (0.0334 W) IEEE 802.11n (HT40): 14.90 dBm (0.0309 W) IEEE 802.11ac (VHT20): 12.96 dBm (0.0198 W) IEEE 802.11ac (VHT40): 12.87 dBm (0.0194 W) IEEE 802.11ac (VHT80): 12.93 dBm (0.0196 W)
Maximum Output Power for UNII-3_Beamforming	IEEE 802.11n (HT20): 14.99 dBm (0.0316 W) IEEE 802.11n (HT40): 14.83 dBm (0.0304 W) IEEE 802.11ac (VHT20): 12.82 dBm (0.0191 W) IEEE 802.11ac (VHT40): 12.72 dBm (0.0187 W) IEEE 802.11ac (VHT80): 12.82 dBm (0.0191 W)

Note:



1. For a more detailed features description, please refer to the manufacturer's specifications or the user's manual.

2. Channel List:

IEEE 802.11a IEEE 802.11n (HT20) IEEE 802.11ac (VHT20)		IEEE 802.11n (HT40) IEEE 802.11ac (VHT40)		IEEE 802.11ac (VHT80)	
UNII-1		UNII-1		UNII-1	
Channel	Frequency (MHz)	Channel	Frequency (MHz)	Channel	Frequency (MHz)
36	5180	38	5190	42	5210
40	5200	46	5230		
44	5220				
48	5240				

IEEE 802.11a IEEE 802.11n (HT20) IEEE 802.11ac (VHT20)		IEEE 802.11n (HT40) IEEE 802.11ac (VHT40)		IEEE 802.11ac (VHT80)	
UNII-3		UNII-3		UNII-3	
Channel	Frequency (MHz)	Channel	Frequency (MHz)	Channel	Frequency (MHz)
149	5745	151	5755	155	5775
153	5765	159	5795		
157	5785				
161	5805				
165	5825				

3. Antenna Specification:

Ant.	Brand	Model Name	Antenna Type	Connector	Gain (dBi)
1		N/A	External	N/A	5.15
2		N/A	External	N/A	5.15

Note:

This EUT supports MIMO 2X2, any transmit signals are correlated with each other, so,

(1) For Non Beamforming:

 $\text{Directional gain} = G_{\text{ANT}} + 10\log(N)\text{dBi}$, that is $\text{Directional gain} = 5.15 + 10\log(2)\text{dBi} = 8.16$.

 So, the UNII-1 output power limit is $24 - (8.16 - 6) = 21.84$, the UNII-3 output power limit is

 $30 - (8.16 - 6) = 27.84$. The UNII-1 power spectral density limit is $11 - (8.16 - 6) = 8.84$, the UNII-3 power spectral density limit is $30 - (8.16 - 6) = 27.84$.

(2) For Beamforming:

 $\text{Beamforming Gain} = 3\text{dBi}$, $\text{Directional gain} = 3 + 5.15 = 8.15$

 So, the UNII-1 output power limit is $24 - (8.15 - 6) = 21.85$, the UNII-3 output power limit is

 $30 - (8.15 - 6) = 27.85$.

4. Table for Antenna Configuration:

Non Beamforming:

Operating Mode	TX Mode	1TX	2TX
IEEE 802.11a		V (Ant. 1)	-
IEEE 802.11n (HT20)		-	V (Ant. 1 + Ant. 2)
IEEE 802.11n (HT40)		-	V (Ant. 1 + Ant. 2)
IEEE 802.11ac (VHT20)		-	V (Ant. 1 + Ant. 2)
IEEE 802.11ac (VHT40)		-	V (Ant. 1 + Ant. 2)
IEEE 802.11ac (VHT80)		-	V (Ant. 1 + Ant. 2)

Beamforming:

Operating Mode	TX Mode	2TX
IEEE 802.11n (HT20)		V (Ant. 1 + Ant. 2)
IEEE 802.11n (HT40)		V (Ant. 1 + Ant. 2)
IEEE 802.11ac (VHT20)		V (Ant. 1 + Ant. 2)
IEEE 802.11ac (VHT40)		V (Ant. 1 + Ant. 2)
IEEE 802.11ac (VHT80)		V (Ant. 1 + Ant. 2)

2.2 TEST MODES

The test system was pre-tested based on the consideration of all possible combinations of EUT operation mode.

Pretest Mode	Description
Mode 1	TX A Mode / CH36, CH40, CH48 (UNII-1)
Mode 2	TX N (HT20) Mode / CH36, CH40, CH48 (UNII-1)
Mode 3	TX N (HT40) Mode / CH38, CH46 (UNII-1)
Mode 4	TX AC (VHT20) Mode / CH36, CH40, CH48 (UNII-1)
Mode 5	TX AC (VHT40) Mode / CH38, CH46 (UNII-1)
Mode 6	TX AC (VHT80) Mode / CH42 (UNII-1)
Mode 7	TX A Mode / CH149,CH157,CH165 (UNII-3)
Mode 8	TX N (HT20) Mode / CH149,CH157,CH165 (UNII-3)
Mode 9	TX N (HT40) Mode / CH151,CH159 (UNII-3)
Mode 10	TX AC (VHT20) Mode / CH149,CH157,CH165 (UNII-3)
Mode 11	TX AC (VHT40) Mode / CH151,CH159 (UNII-3)
Mode 12	TX AC (VHT80) Mode / CH155 (UNII-3)
Mode 13	TX A Mode / CH165 (UNII-3)

Following mode(s) was (were) found to be the worst case(s) and selected for the final test.

AC power line conducted emissions test	
Final Test Mode	Description
Mode 13	TX A Mode / CH165 (UNII-3)

Radiated emissions test – Below 1GHz	
Final Test Mode	Description
Mode 13	TX A Mode / CH165 (UNII-3)

Radiated emissions test – Above 1GHz	
Final Test Mode	Description
Mode 1	TX A Mode / CH36, CH40, CH48 (UNII-1)
Mode 2	TX N (HT20) Mode / CH36, CH40, CH48 (UNII-1)
Mode 3	TX N (HT40) Mode / CH38, CH46 (UNII-1)
Mode 6	TX AC (VHT80) Mode / CH42 (UNII-1)
Mode 7	TX A Mode / CH149,CH157,CH165 (UNII-3)
Mode 8	TX N (HT20) Mode / CH149,CH157,CH165 (UNII-3)
Mode 9	TX N (HT40) Mode / CH151,CH159 (UNII-3)
Mode 12	TX AC (VHT80) Mode / CH155 (UNII-3)

Bandwidth & Output Power Test for Non Beamforming	
Final Test Mode	Description
Mode 1	TX A Mode / CH36, CH40, CH48 (UNII-1)
Mode 2	TX N (HT20) Mode / CH36, CH40, CH48 (UNII-1)
Mode 3	TX N (HT40) Mode / CH38, CH46 (UNII-1)
Mode 4	TX AC (VHT20) Mode / CH36, CH40, CH48 (UNII-1)
Mode 5	TX AC (VHT40) Mode / CH38, CH46 (UNII-1)
Mode 6	TX AC (VHT80) Mode / CH42 (UNII-1)
Mode 7	TX A Mode / CH149,CH157,CH165 (UNII-3)
Mode 8	TX N (HT20) Mode / CH149,CH157,CH165 (UNII-3)
Mode 9	TX N (HT40) Mode / CH151,CH159 (UNII-3)
Mode 10	TX AC (VHT20) Mode / CH149,CH157,CH165 (UNII-3)
Mode 11	TX AC (VHT40) Mode / CH151,CH159 (UNII-3)
Mode 12	TX AC (VHT80) Mode / CH155 (UNII-3)

Output Power Test for Beamforming	
Final Test Mode	Description
Mode 2	TX N (HT20) Mode / CH36, CH40, CH48 (UNII-1)
Mode 3	TX N (HT40) Mode / CH38, CH46 (UNII-1)
Mode 4	TX AC (VHT20) Mode / CH36, CH40, CH48 (UNII-1)
Mode 5	TX AC (VHT40) Mode / CH38, CH46 (UNII-1)
Mode 6	TX AC (VHT80) Mode / CH42 (UNII-1)
Mode 8	TX N (HT20) Mode / CH149,CH157,CH165 (UNII-3)
Mode 9	TX N (HT40) Mode / CH151,CH159 (UNII-3)
Mode 10	TX AC (VHT20) Mode / CH149,CH157,CH165 (UNII-3)
Mode 11	TX AC (VHT40) Mode / CH151,CH159 (UNII-3)
Mode 12	TX AC (VHT80) Mode / CH155 (UNII-3)

Other Conducted test for Non Beamforming	
Test Mode	Description
Mode 1	TX A Mode / CH36, CH40, CH48 (UNII-1)
Mode 2	TX N (HT20) Mode / CH36, CH40, CH48 (UNII-1)
Mode 3	TX N (HT40) Mode / CH38, CH46 (UNII-1)
Mode 6	TX AC (VHT80) Mode / CH42 (UNII-1)
Mode 7	TX A Mode / CH149,CH157,CH165 (UNII-3)
Mode 8	TX N (HT20) Mode / CH149,CH157,CH165 (UNII-3)
Mode 9	TX N (HT40) Mode / CH151,CH159 (UNII-3)
Mode 12	TX AC (VHT80) Mode / CH155 (UNII-3)

Note:

- (1) For radiated emission below 1 GHz test, the IEEE 802.11a channel165 is found to be the worst case and recorded.
- (2) For radiated emission above 1 GHz test, 1GHz~26.5GHz and 26.5GHz~40GHz have been pre-tested and in this report only recorded the worst case. The remaining spurious points are all below the limit value of 20dB.
- (3) The measurements for Power were tested, the worst case were IEEE 802.11a mode, IEEE 802.11n (HT20) mode, IEEE 802.11n (HT40) mode and IEEE 802.11ac(VHT80) mode, only worst case were documented for other test items except Bandwidth.
- (4) The measurements for all the test items were tested during Non Beamforming and Beamforming, the worst case was Non Beamforming, only worst case were documented for other test items except Power.
- (5) For AC power line conducted emissions test, Power AC 120V/60Hz and AC 240V/60Hz were evaluated, the worst case is recorded in this test report.
- (6) For radiated emissions, the WLAN 2.4G_TX B Mode 2412MHz + RLAN 5G_TX A Mode 5825MHz was found the worst case of simultaneous transmission and recorded.

2.3 PARAMETERS OF TEST SOFTWARE

Non Beamforming

UNII-1			
Test Software	MP-Tool-v3.5		
Test Frequency (MHz)	5180	5200	5240
IEEE 802.11a	45	45	45
IEEE 802.11n (HT20)	37/37	37/37	37/37
IEEE 802.11ac (VHT20)	32/32	32/32	32/32
Test Frequency (MHz)	5190	5230	
IEEE 802.11n (HT40)	40/40	42/42	
IEEE 802.11ac (VHT40)	38/38	38/38	
Test Frequency (MHz)	5210		
IEEE 802.11ac (VHT80)	39/39		

UNII-3			
Test Software	MP-Tool-v3.5		
Test Frequency (MHz)	5745	5785	5825
IEEE 802.11a	48	49	51
IEEE 802.11n (HT20)	39/38	40/40	42/42
IEEE 802.11ac (VHT20)	34/34	36/36	38/38
Test Frequency (MHz)	5755	5795	
IEEE 802.11n (HT40)	42/42	42/42	
IEEE 802.11ac (VHT40)	38/38	38/38	
Test Frequency (MHz)	5775		
IEEE 802.11ac (VHT80)	39/39		

Beamforming

UNII-1			
Test Software	MP-Tool-v3.5		
Test Frequency (MHz)	5180	5200	5240
IEEE 802.11n (HT20)	37/37	37/37	37/37
IEEE 802.11ac (VHT20)	32/32	32/32	32/32
Test Frequency (MHz)	5190	5230	/
IEEE 802.11n (HT40)	40/40	42/42	/
IEEE 802.11ac (VHT40)	38/38	38/38	/
Test Frequency (MHz)	5210	/	/
IEEE 802.11ac (VHT80)	39/39	/	/

UNII-3			
Test Software	MP-Tool-v3.5		
Test Frequency (MHz)	5745	5785	5825
IEEE 802.11n (HT20)	39/38	40/40	42/42
IEEE 802.11ac (VHT20)	34/34	36/36	38/38
Test Frequency (MHz)	5755	5795	/
IEEE 802.11n (HT40)	42/42	42/42	/
IEEE 802.11ac (VHT40)	38/38	38/38	/
Test Frequency (MHz)	5775	/	/
IEEE 802.11ac (VHT80)	39/39	/	/

2.4 DUTY CYCLE

If duty cycle is $\geq 98\%$, duty factor is not required.

If duty cycle is $< 98\%$, duty factor shall be considered.

The output power = measured power + duty factor.

The power spectral density = measured power spectral density + duty factor.

IEEE 802.11a

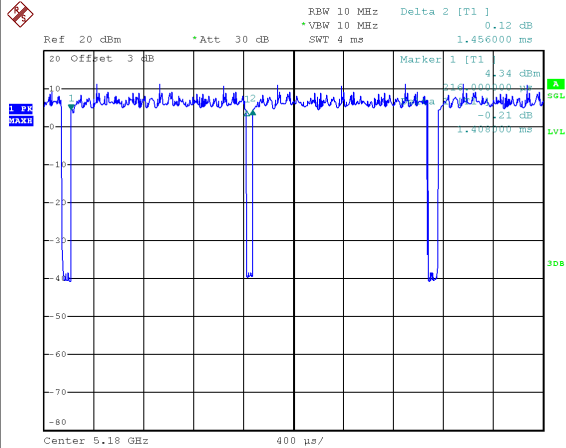

Date: 17.FEB.2020 15:20:52

Duty cycle = $1.408 \text{ ms} / 1.456 \text{ ms} = 96.70\%$
 Duty Factor = $10 \log(1 / \text{Duty cycle}) = 0.15$

IEEE 802.11n (HT20)

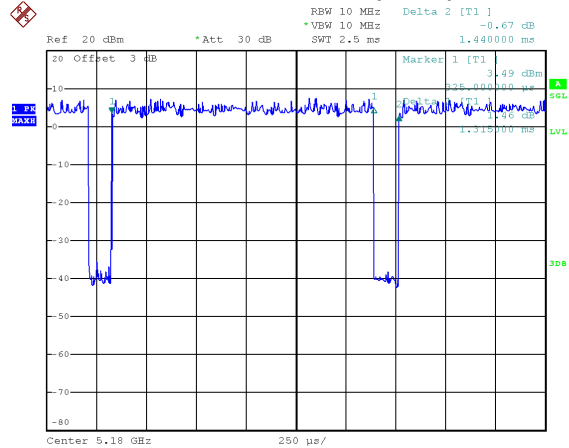

Date: 17.FEB.2020 15:33:16

Duty cycle = $1.315 \text{ ms} / 1.440 \text{ ms} = 91.32\%$
 Duty Factor = $10 \log(1 / \text{Duty cycle}) = 0.39$

IEEE 802.11n (HT40)

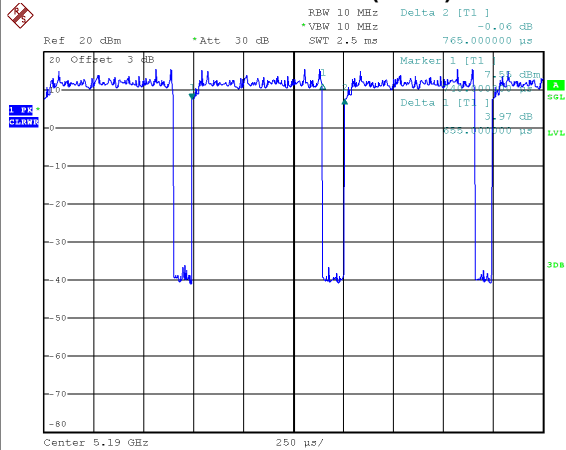

Date: 12.MAR.2020 16:30:33

Duty cycle = $0.655 \text{ ms} / 0.765 \text{ ms} = 85.62\%$
 Duty Factor = $10 \log(1 / \text{Duty cycle}) = 0.67$

IEEE 802.11ac (VHT20)

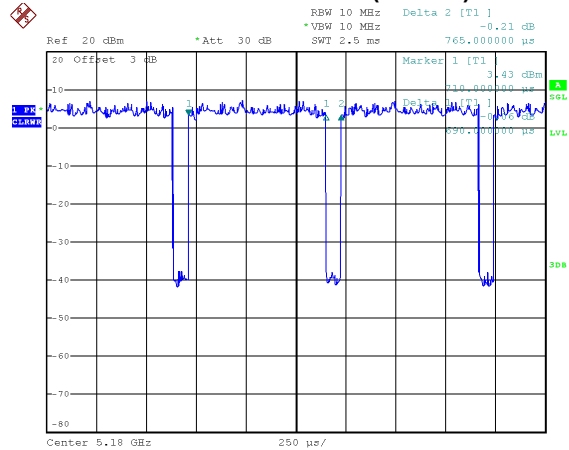

Date: 17.FEB.2020 15:26:48

Duty cycle = $0.690 \text{ ms} / 0.765 \text{ ms} = 90.20\%$
 Duty Factor = $10 \log(1 / \text{Duty cycle}) = 0.45$

IEEE 802.11ac (VHT40)

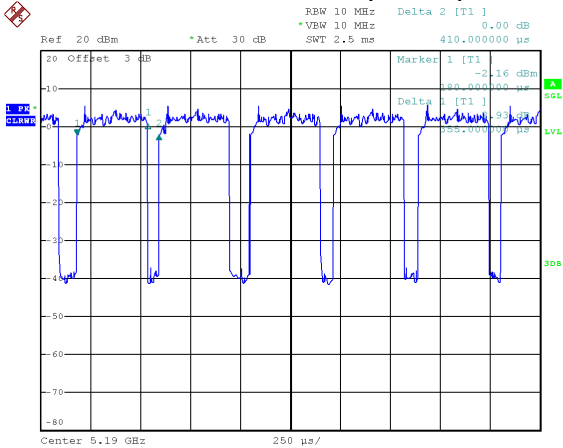

IEEE 802.11ac (VHT80)

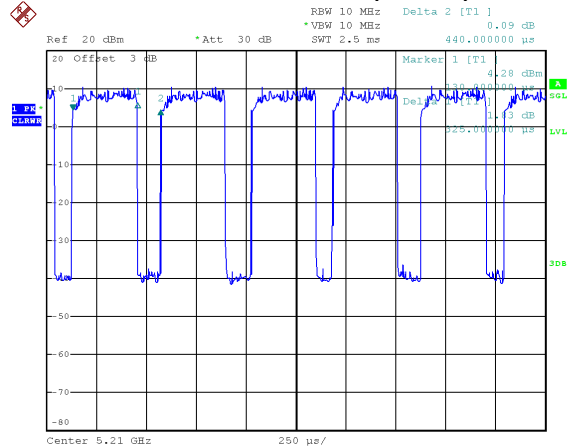

Date: 17.FEB.2020 15:31:29

Date: 12.MAR.2020 16:30:42

Duty cycle = 0.355 ms / 0.410 ms = 86.59%
 Duty Factor = $10 \log(1 / \text{Duty cycle}) = 0.63$

Duty cycle = 0.325 ms / 0.440 ms = 73.86%
 Duty Factor = $10 \log(1 / \text{Duty cycle}) = 1.32$

NOTE:

For IEEE 802.11a, IEEE 802.11n (HT20) and IEEE 802.11ac (VHT20):

For radiated emissions frequency above 1 GHz, the resolution bandwidth of test receiver/spectrum analyzer is 1 MHz and the video bandwidth is 1 kHz (Duty cycle < 98%).

For IEEE 802.11n (HT40) and IEEE 802.11ac (VHT40):

For radiated emissions frequency above 1 GHz, the resolution bandwidth of test receiver/spectrum analyzer is 1 MHz and the video bandwidth is 2 kHz (Duty cycle < 98%).

For IEEE 802.11ac (VHT80):

For radiated emissions frequency above 1 GHz, the resolution bandwidth of test receiver/spectrum analyzer is 1 MHz and the video bandwidth is 3 kHz (Duty cycle < 98%).

2.5 BLOCK DIAGRAM SHOWING THE CONFIGURATION OF SYSTEM TESTED

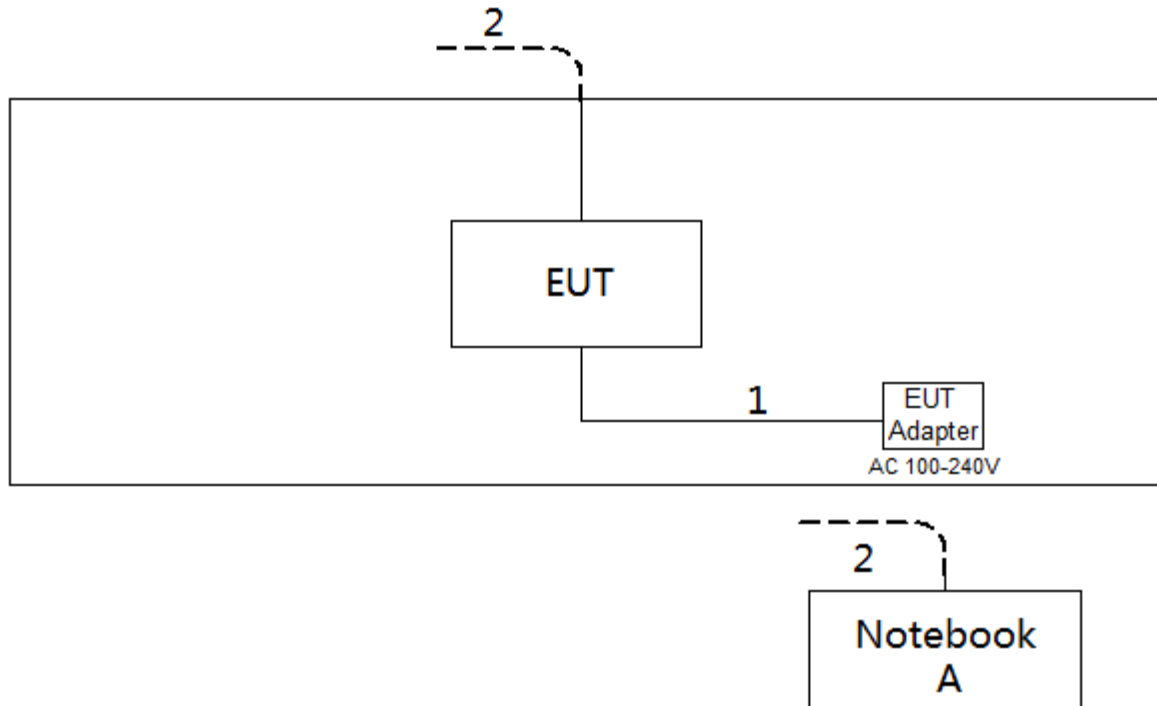

2.6 SUPPORT UNITS

Item	Equipment	Brand	Model No.	Series No.
A	Notebook	Dell	Inspiron 15-7559	N/A

Item	Cable Type	Shielded Type	Ferrite Core	Length
1	DC Cable	NO	NO	1.5m
2	RJ45 Cable	NO	NO	10m

3. AC POWER LINE CONDUCTED EMISSIONS TEST

3.1 LIMIT

Frequency (MHz)	Limit (dB μ V)	
	Quasi-peak	Average
0.15 - 0.5	66 to 56*	56 to 46*
0.5 - 5.0	56	46
5.0 - 30.0	60	50

NOTE:

- (1) The tighter limit applies at the band edges.
- (2) The limit of " * " marked band means the limitation decreases linearly with the logarithm of the frequency in the range.

The following table is the setting of the receiver

Receiver Parameter	Setting
Attenuation	10 dB
Start Frequency	0.15 MHz
Stop Frequency	30 MHz
IF Bandwidth	9 KHz

3.2 TEST PROCEDURE

- a. The EUT was placed 0.8 meters from the horizontal ground plane with EUT being connected to the power mains through a line impedance stabilization network (LISN). All other support equipment powered from additional LISN(s). The LISN provide 50 Ohm/ 50uH of coupling impedance for the measuring instrument.
- b. Interconnecting cables that hang closer than 40 cm to the ground plane shall be folded back and forth in the center forming a bundle 30 to 40 cm long.
- c. I/O cables that are not connected to a peripheral shall be bundled in the center. The end of the cable may be terminated, if required, using the correct terminating impedance. The overall length shall not exceed 1 m.
- d. LISN at least 80 cm from nearest part of EUT chassis.
- e. For the actual test configuration, please refer to the related Item -EUT Test Photos.

3.3 DEVIATION FROM TEST STANDARD

No deviation

3.4 TEST SETUP

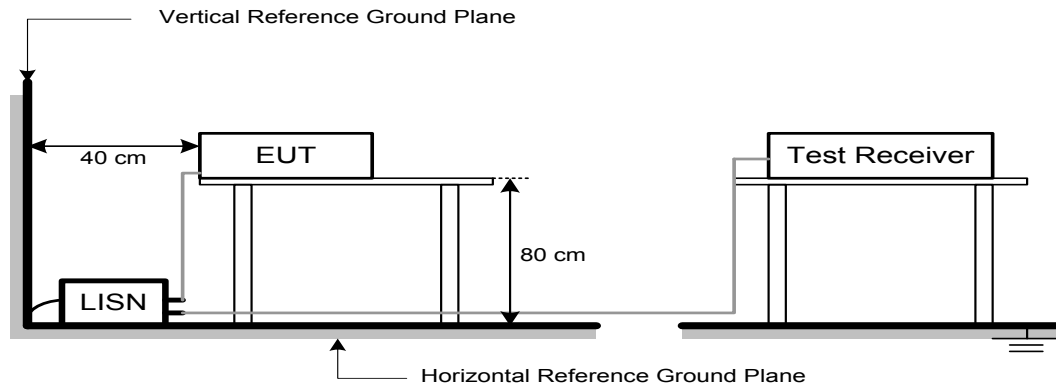

3.5 EUT OPERATION CONDITIONS

The EUT was configured for testing in a typical fashion (as a customer would normally use it). The EUT has been programmed to continuously transmit during test. This operating condition was tested and used to collect the included data.

The EUT was programmed to be in continuously transmitting/TX mode.

3.6 TEST RESULTS

Please refer to the APPENDIX A.

4. RADIATED EMISSIONS TEST

4.1 LIMIT

In case the emission fall within the restricted band specified on 15.205(a), then the 15.209(a) limit in the table below has to be followed.

LIMITS OF RADIATED EMISSIONS MEASUREMENT (9 kHz to 1000 MHz)

Frequency (MHz)	Field Strength (microvolts/meter)	Measurement Distance (meters)
0.009-0.490	2400/F(kHz)	300
0.490-1.705	24000/F(kHz)	30
1.705-30.0	30	30
30-88	100	3
88-216	150	3
216-960	200	3
Above 960	500	3

LIMITS OF UNWANTED EMISSION OUT OF THE RESTRICTED BANDS

Frequency (MHz)	EIRP Limit (dBm/MHz)	Equivalent Field Strength at 3m (dB μ V/m)
5150-5250	-27	68.3
5725-5850	-27 NOTE (2)	68.3
	10 NOTE (2)	105.3
	15.6 NOTE (2)	110.9
	27 NOTE (2)	122.3

NOTE:

(1) The following formula is used to convert the equipment isotropic radiated power (eirp) to field strength:

$$E = \frac{1000000\sqrt{30P}}{3} \mu\text{V/m, where P is the eirp (Watts)}$$

(2) According to 15.407(b)(4)(i), all emissions shall be limited to a level of -27 dBm/MHz at 75 MHz or more above or below the band edge increasing linearly to 10 dBm/MHz at 25 MHz above or below the band edge, and from 25 MHz above or below the band edge increasing linearly to a level of 15.6 dBm/MHz at 5 MHz above or below the band edge, and from 5 MHz above or below the band edge increasing linearly to a level of 27 dBm/MHz at the band edge.

4.2 TEST PROCEDURE

- a. The measuring distance of 3 m shall be used for measurements. The EUT was placed on the top of a rotating table 0.8 meter above the ground at a 3 meter semi-anechoic chamber. The table was rotated 360 degrees to determine the position of the highest radiation.(below 1GHz)
- b. The measuring distance of 3 m shall be used for measurements. The EUT was placed on the top of a rotating table 1.5 meter above the ground at a 3 meter semi-anechoic chamber. The table was rotated 360 degrees to determine the position of the highest radiation.(above 1GHz)
- c. The height of the equipment or of the substitution antenna shall be 0.8m or 1.5m; the height of the test antenna shall vary between 1 m to 4 m. Both horizontal and vertical polarizations of the antenna are set to make the measurement.
- d. For each suspected emission, the EUT was arranged to its worst case and then the antenna was tuned to heights find the maximum reading (used Bore sight function).
- e. The receiver system was set to peak and average detect function and specified bandwidth with maximum hold mode when the test frequency is above 1 GHz.
- f. The initial step in collecting radiated emission data is a receiver peak detector mode pre-scanning the measurement frequency range. Significant peaks are then marked and then Quasi Peak detector mode re-measured.
- g. All readings are Peak unless otherwise stated QP in column of Note. Peak denotes that the Peak reading compliance with the QP Limits and then QP Mode measurement didn't perform. (below 1 GHz)
- h. All readings are Peak Mode value unless otherwise stated AVG in column of Note. If the Peak Mode Measured value compliance with the Peak Limits and lower than AVG Limits, the EUT shall be deemed to meet both Peak & AVG Limits and then only Peak Mode was measured, but AVG Mode didn't perform. (above 1 GHz)
- i. For the actual test configuration, please refer to the related Item –EUT Test Photos.

4.3 DEVIATION FROM TEST STANDARD

No deviation

4.4 TEST SETUP

9 kHz to 30 MHz

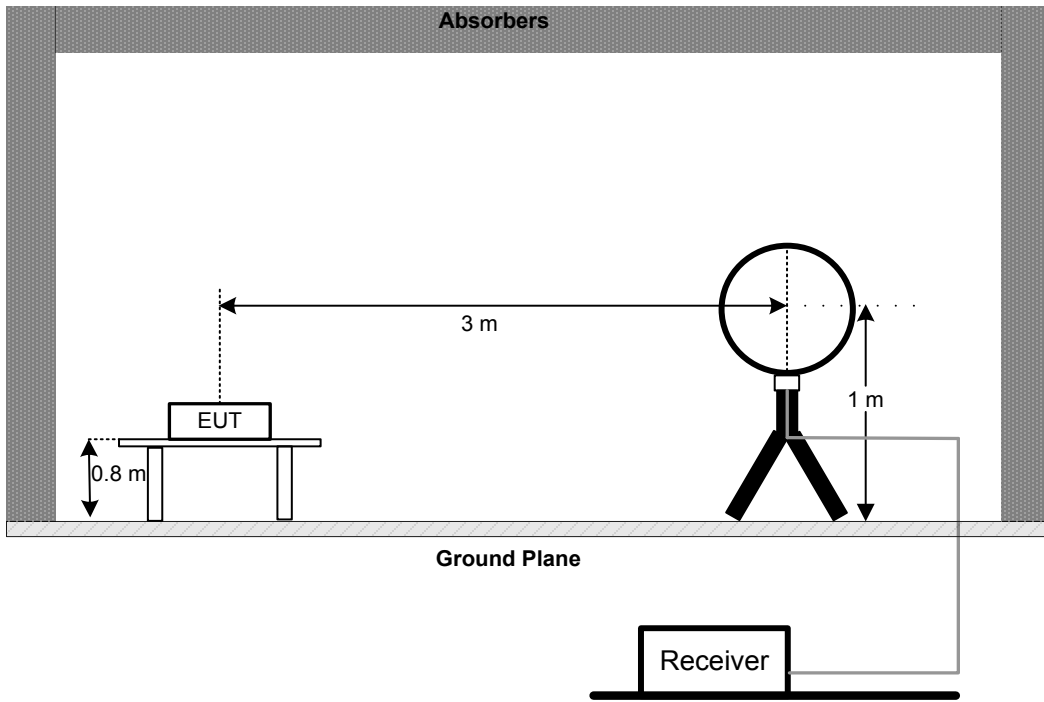

30 MHz to 1 GHz

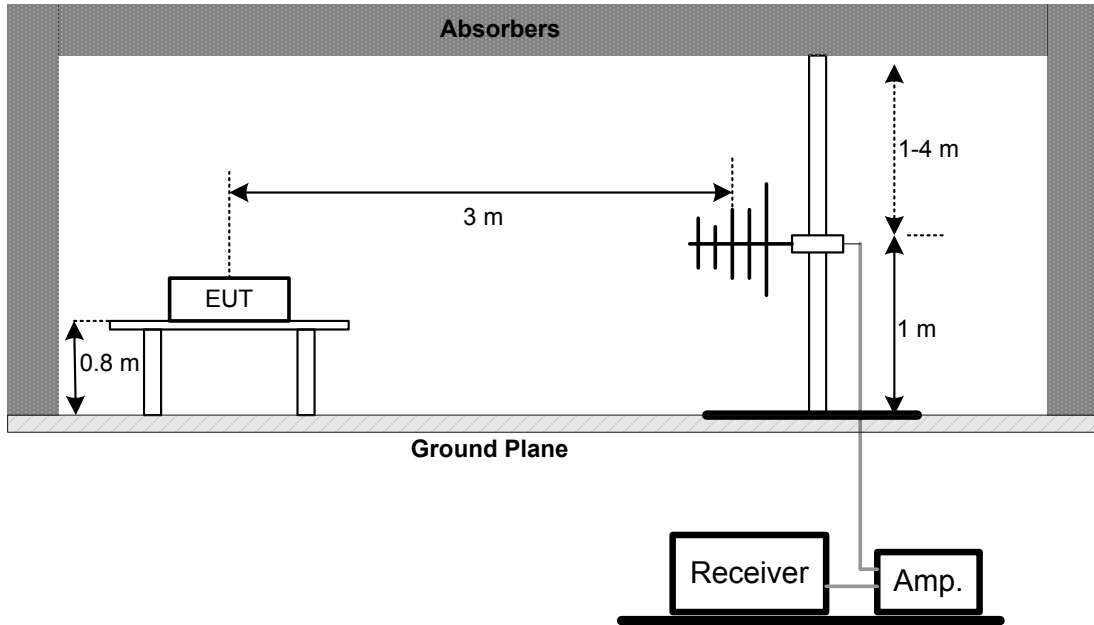

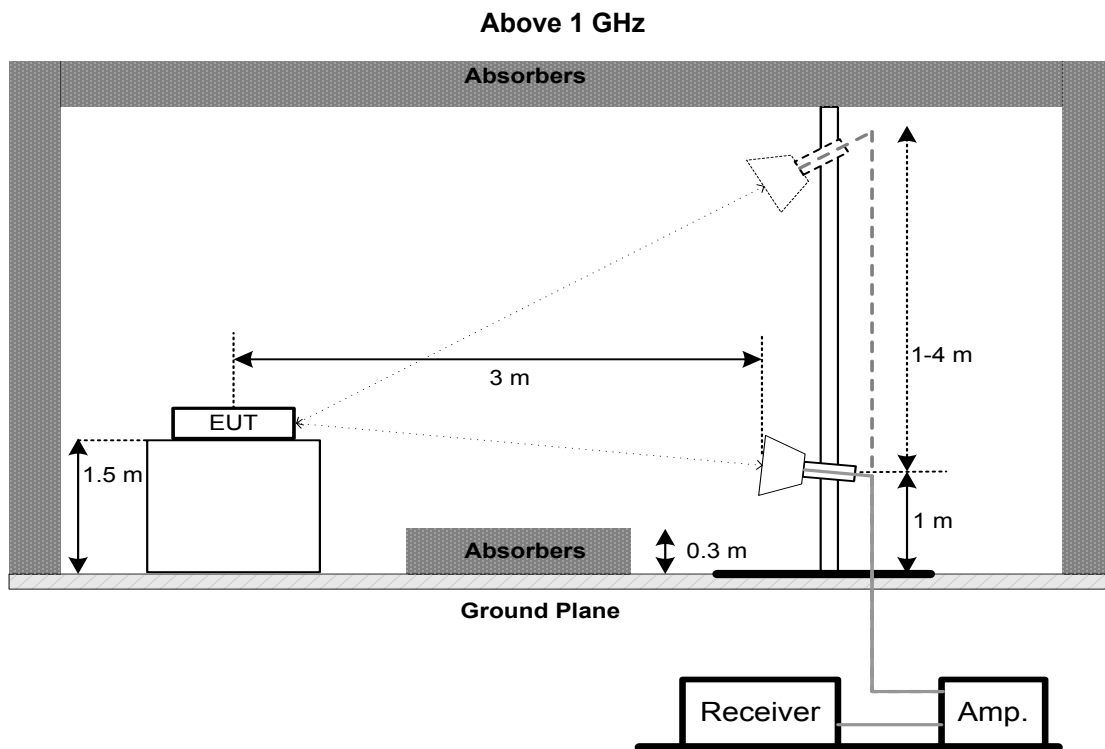

4.5 EUT OPERATION CONDITIONS

The EUT tested system was configured as the statements of 3.5 unless otherwise a special operating condition is specified in the follows during the testing.

4.6 TEST RESULTS - 9 KHZ to 30 MHZ

Please refer to the APPENDIX B

Remark:

- (1) Distance extrapolation factor = $40 \log (\text{specific distance} / \text{test distance})$ (dB).
- (2) Limit line = specific limits (dBuV) + distance extrapolation factor.

4.7 TEST RESULTS - 30 MHz TO 1000 MHz

Please refer to the APPENDIX C.

4.8 TEST RESULTS - ABOVE 1000 MHz

Please refer to the APPENDIX D.

Remark:

- (1) No limit: This is fundamental signal, the judgment is not applicable.
For fundamental signal judgment was referred to Peak output test.

5. BANDWIDTH TEST

5.1 LIMIT

FCC Part15, Subpart E (15.407)			
Section	Test Item	Limit	Frequency Range (MHz)
15.407(a)	26 dB Bandwidth	-	5150-5250
15.407(e)	6 dB Bandwidth	Minimum 500 kHz	5725-5850

5.2 TEST PROCEDURE

- a. The EUT was directly connected to the spectrum analyzer and antenna output port as show in the block diagram below
- b. Spectrum Setting:
For UNII-1:

Spectrum Parameter	Setting
Attenuation	Auto
Span Frequency	> 26 dB Bandwidth
RBW	300 kHz (Bandwidth 20 MHz) 1 MHz (Bandwidth 40 MHz and 80 MHz)
VBW	1 MHz (Bandwidth 20 MHz) 3 MHz (Bandwidth 40 MHz and 80 MHz)
Detector	Peak
Trace	Max Hold
Sweep Time	Auto

For UNII-3:

Spectrum Parameter	Setting
Attenuation	Auto
Span Frequency	6 dB Bandwidth
RBW	100 kHz
VBW	300 kHz
Detector	Peak
Trace	Max Hold
Sweep Time	Auto

- c. Measured the spectrum width with power higher than 26 dB / 6dB below carrier

5.3 TEST PROCEDURE

No deviation.

5.4 TEST SETUP

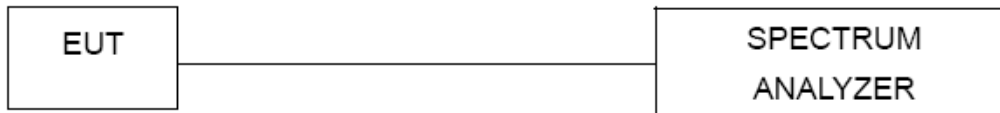

5.5 EUT OPERATION CONDITIONS

The EUT was programmed to be in continuously transmitting mode.

5.6 TEST RESULTS

Please refer to the APPENDIX E.

6. MAXIMUM OUTPUT POWER TEST

6.1 LIMIT

FCC Part15, Subpart E (15.407)			
Section	Test Item	Limit	Frequency Range (MHz)
15.407(a)	Maximum Output Power	AP device: 1 Watt (30 dBm) Client device: 250 mW (24 dBm)	5150-5250
		1 Watt (30dBm)	5725-5850

Note:

- a. For client devices in the 5.15-5.25 GHz band, the maximum conducted output power over the frequency band of operation shall not exceed 250 mW provided the maximum antenna gain does not exceed 6 dBi. In addition, the maximum power spectral density shall not exceed 11 dBm in any 1 megahertz band. If transmitting antennas of directional gain greater than 6 dBi are used, both the maximum conducted output power and the maximum power spectral density shall be reduced by the amount in dB that the directional gain of the antenna exceeds 6 dBi.
- b. For the 5.25-5.35 GHz and 5.47-5.725 GHz bands, the maximum conducted output power over the frequency bands of operation shall not exceed the lesser of 250 mW or 11 dBm + 10log B, where B is the 26dB Bandwidth in megahertz.

6.2 TEST PROCEDURE

- a. The EUT was directly connected to the power meter and antenna output port as show in the block diagram below.
- b. Test test was performed in accordance with method of FCC KDB 789033 D02 General UNII Test Procedures New Rules v02r01.

6.3 DEVIATION FROM STANDARD

No deviation.

6.4 TEST SETUP



6.5 EUT OPERATION CONDITIONS

The EUT was programmed to be in continuously transmitting mode.

6.6 TEST RESULTS

Please refer to the APPENDIX F.

7. POWER SPECTRAL DENSITY TEST

7.1 LIMIT

FCC Part15, Subpart E (15.407)			
Section	Test Item	Limit	Frequency Range (MHz)
15.407(a)	Power Spectral Density	AP device: 17 dBm/MHz Client device: 11 dBm/MHz	5150-5250
		30 dBm/500 kHz	5725-5850

7.2 TEST PROCEDURE

- a. The EUT was directly connected to the spectrum analyzer and antenna output port as show in the block diagram below.
- b. Spectrum Setting

Spectrum Parameter	Setting
Attenuation	Auto
Span Frequency	Encompass the entire emissions bandwidth (EBW) of the signal
RBW	= 1 MHz.
VBW	≥ 3 MHz.
Detector	RMS
Trace average	100 trace
Sweep Time	Auto

Note:

1. For UNII-3, according to KDB publication 789033 D02 General UNII Test Procedures New Rules v02r01, section II.F.5., it is acceptable to set RBW at 1 MHz and VBW at 3 MHz if the spectrum analyzer does not have 500 kHz RBW.
2. The value measured with RBW=1 MHz is to be added with $10\log(500\text{ kHz}/1\text{ MHz})$ which is -3 dB. For example, if the measured value is +10dBm using RBW=1 MHz (that is +10 dBm/MHz), then the converted value will be +7dBm/500kHz.

7.3 DEVIATION FROM STANDARD

No deviation.

7.4 TEST SETUP



7.5 EUT OPERATION CONDITIONS

The EUT was programmed to be in continuously transmitting mode.

7.6 TEST RESULTS

Please refer to the APPENDIX G.

8. FREQUENCY STABILITY MEASUREMENT

8.1 LIMIT

FCC Part15, Subpart E (15.407)			
Section	Test Item	Limit	Frequency Range (MHz)
15.407(g)	Frequency Stability	An emission is maintained within the band of operation under all conditions of normal operation as specified in the users manual.	5150-5250
			5725-5850

8.2 TEST PROCEDURE

- The EUT was directly connected to the spectrum analyzer and antenna output port as show in the block diagram below.
- Spectrum Setting:

Spectrum Parameter	Setting
Attenuation	Auto
Span Frequency	Entire absence of modulation emissions bandwidth
RBW	10 kHz
VBW	10 kHz
Sweep Time	Auto

- The test extreme voltage is to change the primary supply voltage from 85 to 115 percent of the nominal value.
- User manual temperature is $-10^{\circ}\text{C}\sim 70^{\circ}\text{C}$.

8.3 DEVIATION FROM STANDARD

No deviation.

8.4 TEST SETUP

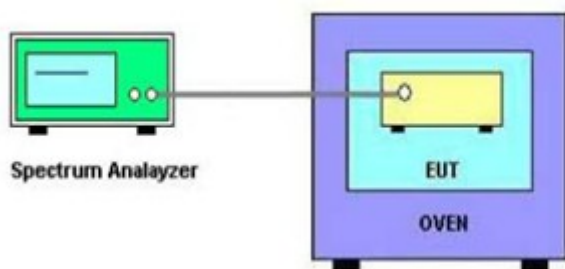

8.5 EUT OPERATION CONDITIONS

The EUT was programmed to be in continuously transmitting mode.

8.6 TEST RESULTS

Please refer to the APPENDIX H.

9. MEASUREMENT INSTRUMENTS LIST

AC Power Line Conducted Emissions					
Item	Kind of Equipment	Manufacturer	Type No.	Serial No.	Calibrated until
1	EMI Test Receiver	R&S	ESCI	100382	Feb. 28, 2021
2	LISN	EMCO	3816/2	52765	Mar. 01, 2021
3	TWO-LINE V-NETWORK	R&S	ENV216	101447	Feb. 28, 2021
4	50Ω Terminator	SHX	TF5-3	15041305	Mar. 01, 2021
5	Measurement Software	Farad	EZ-EMC Ver.NB-03A1-01	N/A	N/A
6	Cable	N/A	RG223	12m	Mar. 10, 2021

Radiated Emissions - 9 kHz to 30 MHz					
Item	Kind of Equipment	Manufacturer	Type No.	Serial No.	Calibrated until
1	Antenna	EM	EM-6876-1	230	Apr. 16, 2021
2	Cable	N/A	RG 213/U	N/A	May 29, 2021
3	EMI Test Receiver	R&S	ESCI	100895	Feb. 28, 2021
4	Measurement Software	Farad	EZ-EMC Ver.NB-03A1-01	N/A	N/A

Radiated Emissions - 30 MHz to 1 GHz					
Item	Kind of Equipment	Manufacturer	Type No.	Serial No.	Calibrated until
1	Antenna	Schwarzbeck	VULB9160	9160-3232	Mar. 09, 2021
2*	Amplifier	HP	8447D	2944A09673	Aug. 11, 2021
3	Receiver	Agilent	N9038A	MY52130039	Aug. 03, 2020
4	Cable	emci	LMR-400(30MHz-1 GHz)(8m+5m)	N/A	May 22, 2021
5	Controller	CT	SC100	N/A	N/A
6	Controller	MF	MF-7802	MF780208416	N/A
7	Measurement Software	Farad	EZ-EMC Ver.NB-03A1-01	N/A	N/A

Radiated Emissions - Above 1 GHz					
Item	Kind of Equipment	Manufacturer	Type No.	Serial No.	Calibrated until
1	Double Ridged Guide Antenna	ETS	3115	75846	Mar. 19, 2021
2	Broad-Band Horn Antenna	Schwarzbeck	BBHA 9170	9170319	Jun. 22, 2021
3	Amplifier	Agilent	8449B	3008A02584	Aug. 03, 2020
4	Microwave Preamplifier With Adaptor	EMC INSTRUMENT	EMC2654045	980039 & HA01	Mar. 07, 2021
5	Receiver	Agilent	N9038A	MY52130039	Aug. 03, 2020
6	Controller	CT	SC100	N/A	N/A
7	Controller	MF	MF-7802	MF780208416	N/A
8	Cable	mitron	RWLP50-4.0A-KJ-S MSM-12M	N/A	Nov. 25, 2020
9	Measurement Software	Farad	EZ-EMC Ver.NB-03A1-01	N/A	N/A

Bandwidth & Output Power & Power Spectral Density					
Item	Kind of Equipment	Manufacturer	Type No.	Serial No.	Calibrated until
1	Spectrum Analyzer	R&S	FSP40	100185	Aug. 03, 2020

Maximum Output Power					
Item	Kind of Equipment	Manufacturer	Type No.	Serial No.	Calibrated until
1	Peak Power Analyzer	Keysight	8990B	MY51000506	Aug. 03, 2020
2	Wideband power sensor	Keysight	N1923A	MY58310004	Aug. 03, 2020

Frequency Stability					
Item	Kind of Equipment	Manufacturer	Type No.	Serial No.	Calibrated until
1	Spectrum Analyzer	R&S	FSP40	100185	Aug. 03, 2020
2	Precision Oven Tester	CEPREI	CEEC-M64T-40	15-008	Feb. 28, 2021

Remark: "N/A" denotes no model name, serial no. or calibration specified.

"**" calibration period of equipment list is three year.

Except * item, all calibration period of equipment list is one year.

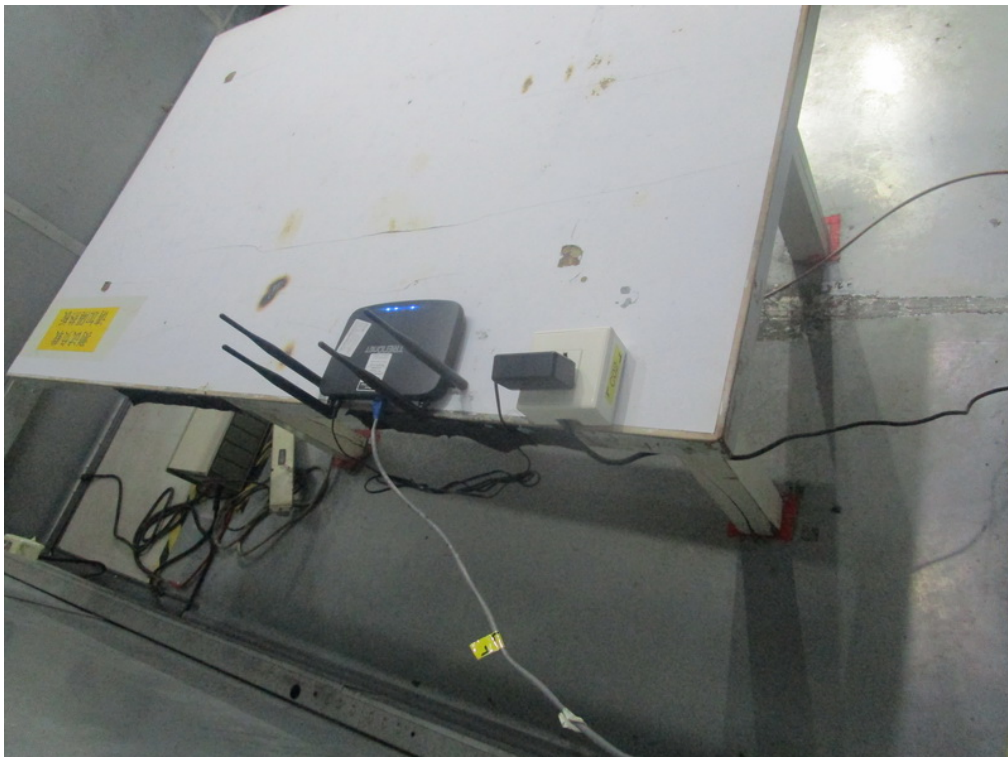
10. EUT TEST PHOTOS**AC Power Line Conducted Emissions Test Photos**

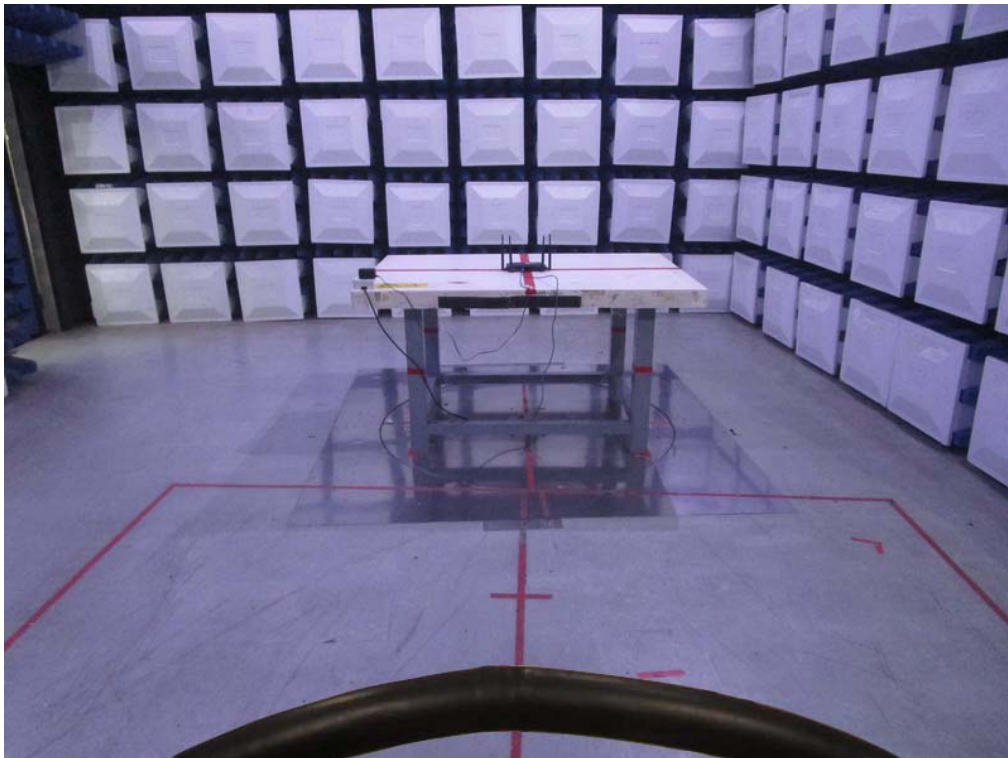
Radiated Emissions Test Photos**9 kHz to 30 MHz**

Radiated Emissions Test Photos

30 MHz to 1 GHz

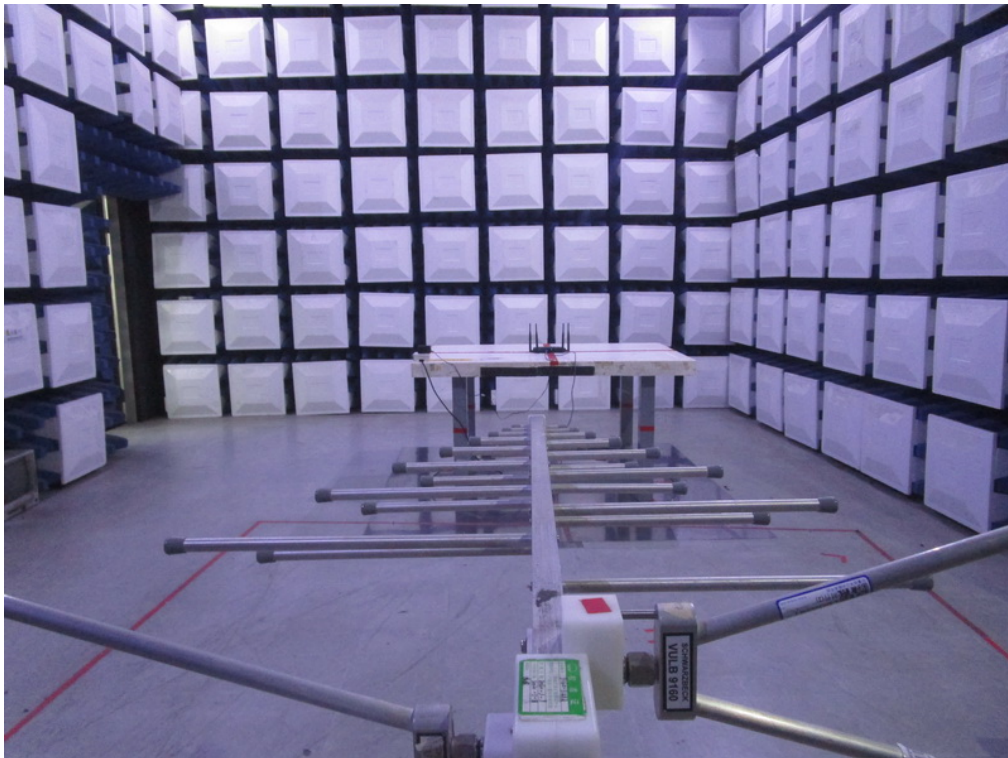
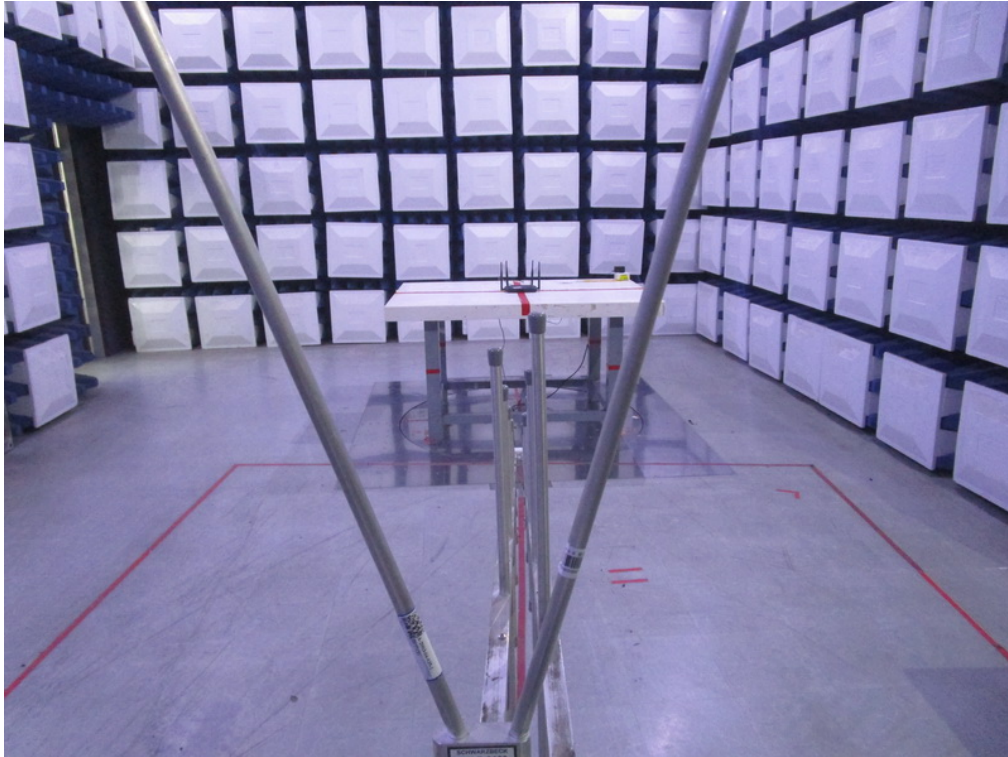

Radiated Emissions Test Photos**Above 1 GHz**

APPENDIX A - AC POWER LINE CONDUCTED EMISSIONS

Test Mode:	TX A Mode Channel 165
Test Voltage:	AC 240V/60Hz

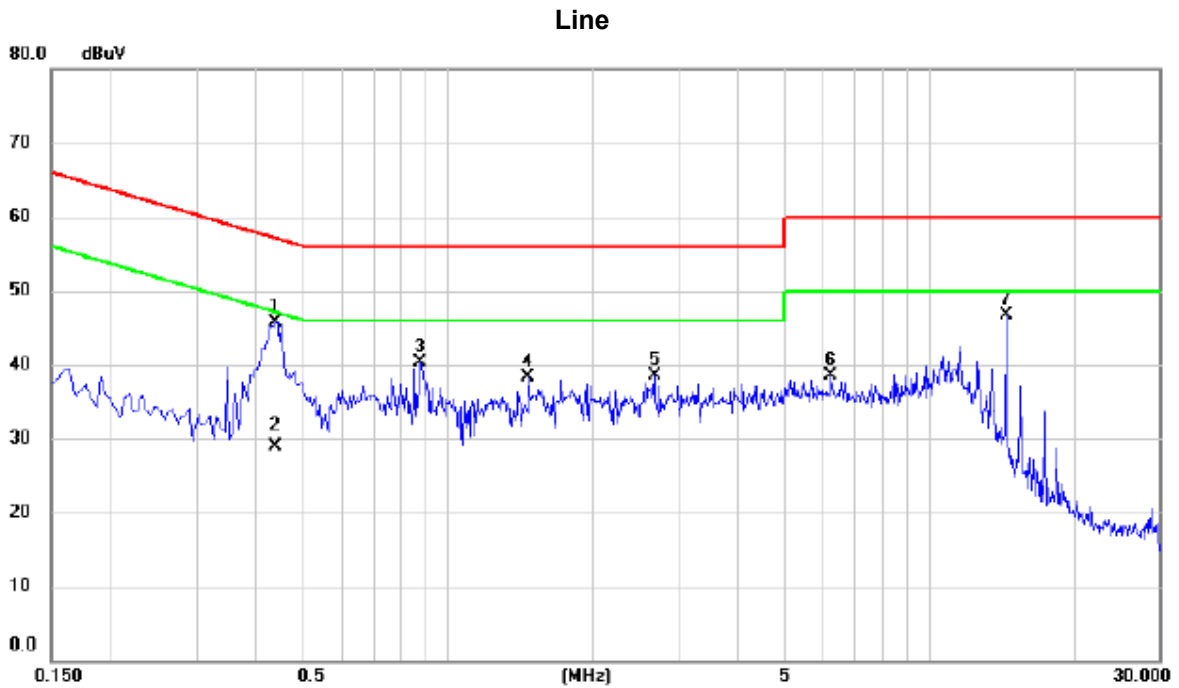

No.	Mk.	Freq. MHz	Reading Level dBuV	Correct Factor dB	Measure- ment dBuV	Limit dBuV	Margin dB	Detector	Comment
1	*	0.4380	35.94	9.82	45.76	57.10	-11.34	peak	
2		0.4380	19.15	9.82	28.97	47.10	-18.13	AVG	
3		0.8745	30.41	9.84	40.25	56.00	-15.75	peak	
4		1.4640	28.42	9.87	38.29	56.00	-17.71	peak	
5		2.6835	28.57	9.91	38.48	56.00	-17.52	peak	
6		6.2295	28.44	10.09	38.53	60.00	-21.47	peak	
7		14.4150	36.34	10.41	46.75	60.00	-13.25	peak	

REMARKS:

- (1) Measurement Value = Reading Level + Correct Factor.
- (2) Margin Level = Measurement Value - Limit Value.
- (3) The test result has included the cable loss.

Test Mode:	TX A Mode Channel 165
Test Voltage:	AC 240V/60Hz

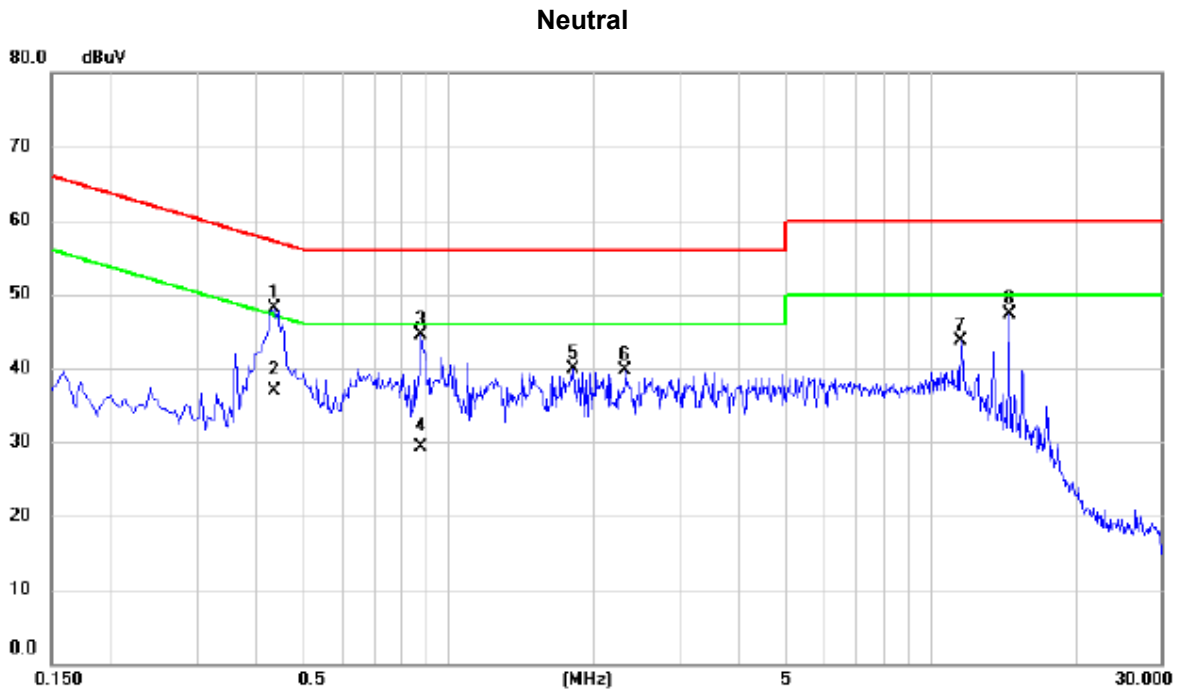

No.	Mk.	Freq. MHz	Reading Level dBuV	Correct Factor dB	Measure- ment dBuV	Limit dBuV	Margin dB	Detector	Comment
1	*	0.4335	38.07	9.96	48.03	57.19	-9.16	peak	
2		0.4335	27.02	9.96	36.98	47.19	-10.21	AVG	
3		0.8745	34.48	10.02	44.50	56.00	-11.50	peak	
4		0.8745	19.33	10.02	29.35	46.00	-16.65	AVG	
5		1.8150	29.77	10.08	39.85	56.00	-16.15	peak	
6		2.3235	29.69	10.10	39.79	56.00	-16.21	peak	
7		11.5485	33.06	10.58	43.64	60.00	-16.36	peak	
8		14.4960	36.60	10.75	47.35	60.00	-12.65	peak	

REMARKS:

- (1) Measurement Value = Reading Level + Correct Factor.
- (2) Margin Level = Measurement Value - Limit Value.
- (3) The test result has included the cable loss.

APPENDIX B - RADIATED EMISSION - 9 KHZ TO 30 MHZ

Test Mode: TX A Mode Channel 165

Ant 0°

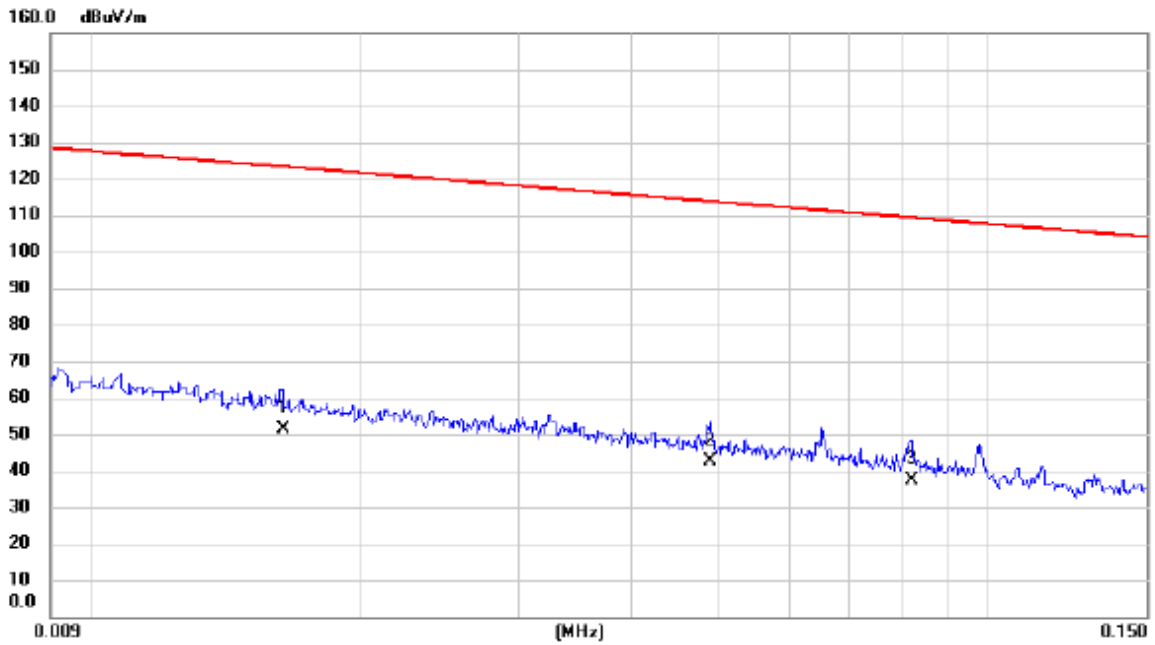

No.	Mk.	Freq. MHz	Reading Level dBuV	Correct Factor dB	Measure- ment dBuV/m	Limit dBuV/m	Margin dB	Detector	Comment
1		0.0164	36.50	14.90	51.40	123.31	-71.91	AVG	
2	*	0.0490	28.80	13.93	42.73	113.80	-71.07	AVG	
3		0.0820	23.90	13.54	37.44	109.33	-71.89	AVG	

REMARKS:

- (1) Measurement Value = Reading Level + Correct Factor.
- (2) Margin Level = Measurement Value - Limit Value.

Test Mode: TX A Mode Channel 165

Ant 0°

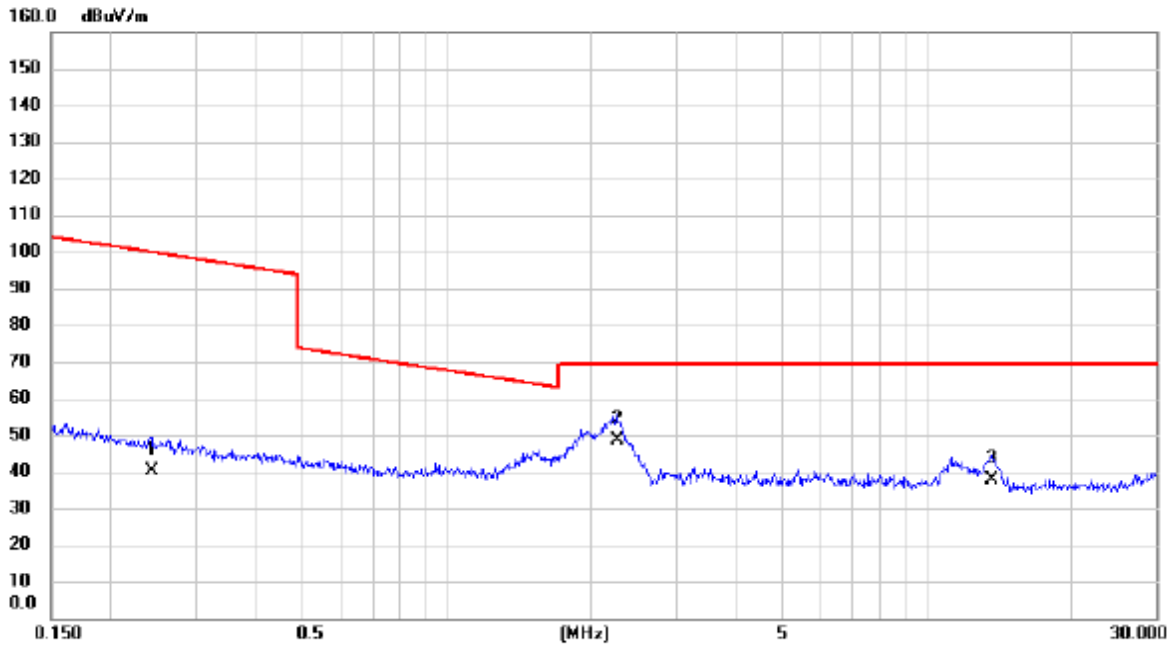

No.	Mk.	Freq. MHz	Reading Level dBuV	Correct Factor dB	Measure- ment dBuV/m	Limit dBuV/m	Margin dB	Detector	Comment
1		0.2430	26.50	13.65	40.15	99.89	-59.74	AVG	
2	*	2.2606	36.90	11.66	48.56	69.54	-20.98	QP	
3		13.6952	26.40	11.59	37.99	69.54	-31.55	QP	

REMARKS:

- (1) Measurement Value = Reading Level + Correct Factor.
- (2) Margin Level = Measurement Value - Limit Value.

Test Mode: TX A Mode Channel 165

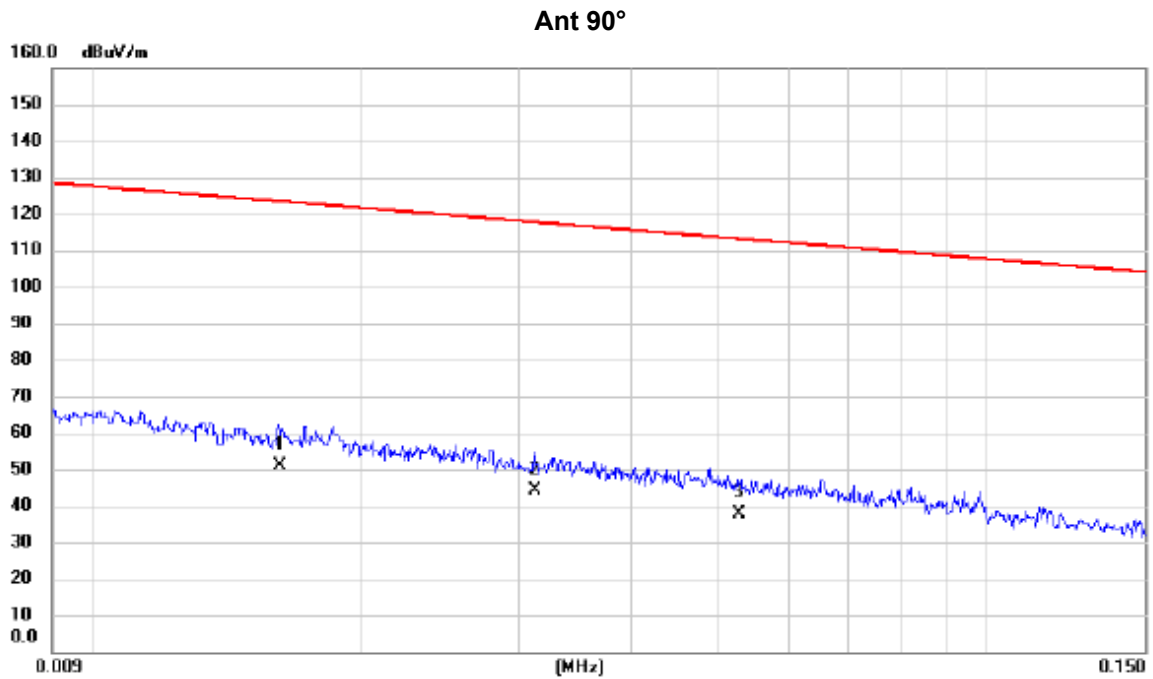

No.	Mk.	Freq.	Reading Level	Correct Factor	Measurement	Limit	Margin	Detector	Comment
		MHz	dBuV	dB	dBuV/m	dBuV/m	dB		
1	*	0.0162	36.20	14.96	51.16	123.41	-72.25	AVG	
2		0.0312	30.50	13.86	44.36	117.72	-73.36	AVG	
3		0.0527	24.10	13.89	37.99	113.17	-75.18	AVG	

REMARKS:

- (1) Measurement Value = Reading Level + Correct Factor.
- (2) Margin Level = Measurement Value - Limit Value.

Test Mode: TX A Mode Channel 165

Ant 90°

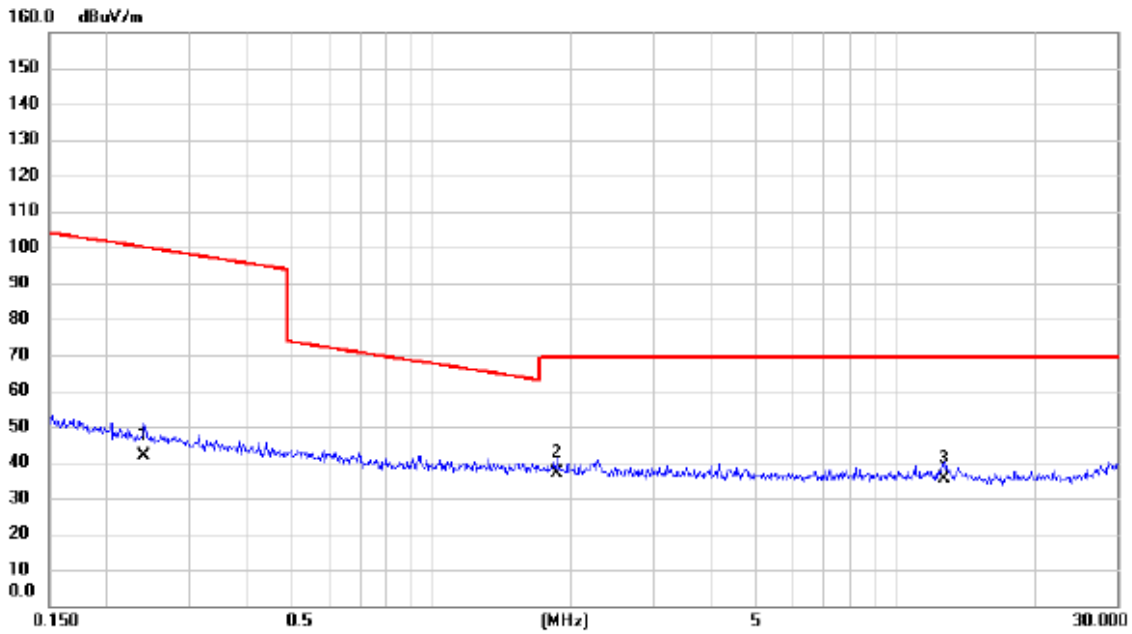

No.	Mk.	Freq. MHz	Reading Level dBuV	Correct Factor dB	Measure- ment dBuV/m	Limit dBuV/m	Margin dB	Detector	Comment
1		0.2404	28.10	13.65	41.75	99.99	-58.24	AVG	
2	*	1.8680	25.30	11.90	37.20	69.54	-32.34	QP	
3		12.7161	23.90	11.60	35.50	69.54	-34.04	QP	

REMARKS:

- (1) Measurement Value = Reading Level + Correct Factor.
- (2) Margin Level = Measurement Value - Limit Value.

APPENDIX C - RADIATED EMISSION - 30 MHZ TO 1 GHZ

Test Mode: TX A Mode Channel 165

Vertical

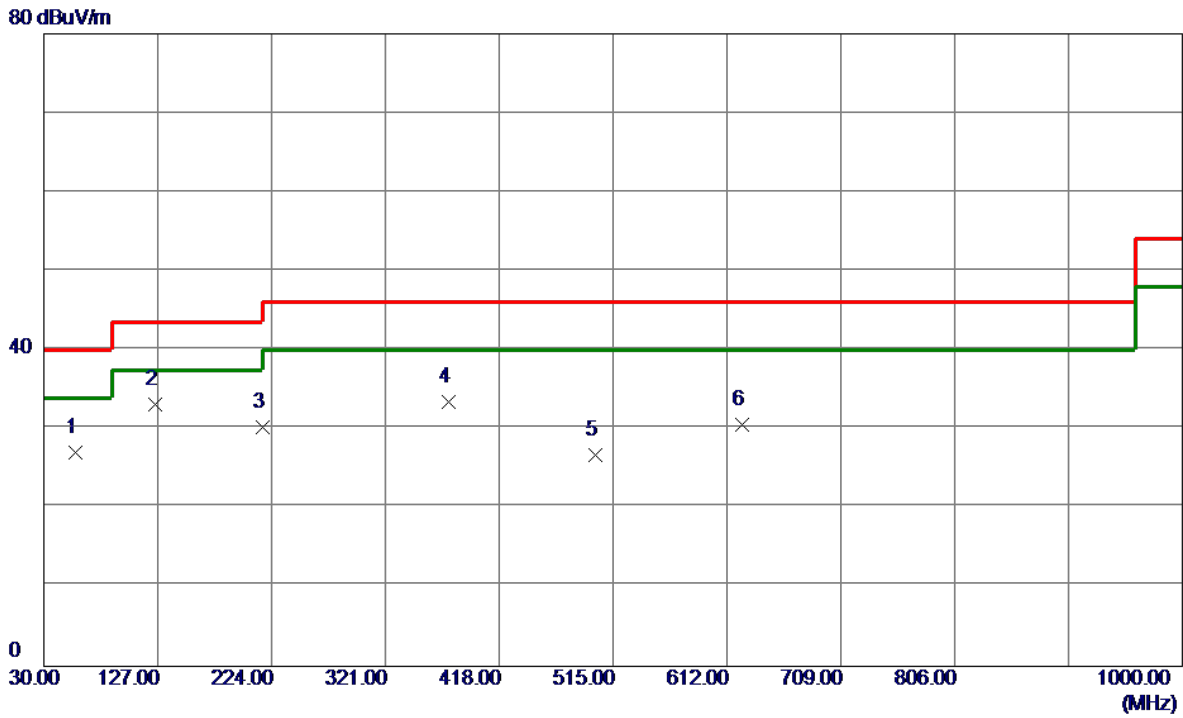

No.	Freq. MHz	Reading Level dBuV/m	Correct Factor dB	Measure ment dBuV/m	Limit dBuV/m	Margin dB	Detector	Comment
1	57.1600	41.78	-14.74	27.04	40.00	-12.96	Peak	
2 *	125.0600	46.82	-13.63	33.19	43.50	-10.31	Peak	
3	216.2400	45.98	-15.79	30.19	46.00	-15.81	Peak	
4	375.3200	44.48	-11.07	33.41	46.00	-12.59	Peak	
5	499.4800	35.58	-8.83	26.75	46.00	-19.25	Peak	
6	624.6100	37.01	-6.47	30.54	46.00	-15.46	Peak	

REMARKS:

- (1) Measurement Value = Reading Level + Correct Factor.
- (2) Margin Level = Measurement Value - Limit Value.

Test Mode: TX A Mode Channel 165

Horizontal

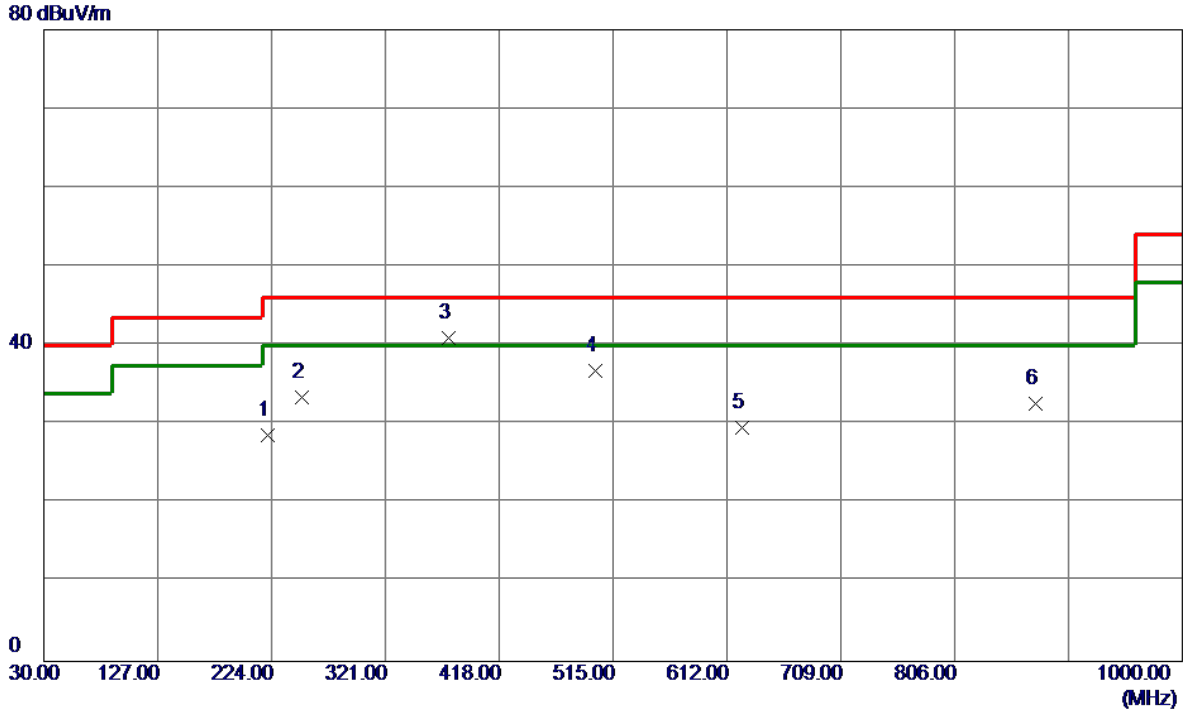

No.	Freq. MHz	Reading Level dBuV/m	Correct Factor dB	Measure ment dBuV/m	Limit dBuV/m	Margin dB	Detector	Comment
1	221.0900	44.10	-15.39	28.71	46.00	-17.29	Peak	
2	250.1900	48.05	-14.55	33.50	46.00	-12.50	Peak	
3 *	375.3200	51.99	-11.07	40.92	46.00	-5.08	Peak	
4	499.4800	45.70	-8.83	36.87	46.00	-9.13	Peak	
5	624.6100	36.01	-6.47	29.54	46.00	-16.46	Peak	
6	874.8700	36.17	-3.58	32.59	46.00	-13.41	Peak	

REMARKS:

- (1) Measurement Value = Reading Level + Correct Factor.
- (2) Margin Level = Measurement Value - Limit Value.

APPENDIX D - RADIATED EMISSION - ABOVE 1000 MHZ

Orthogonal Axis	X
Test Mode	UNII-1_TX A Mode 5180 MHz

Vertical

130 dBuV/m

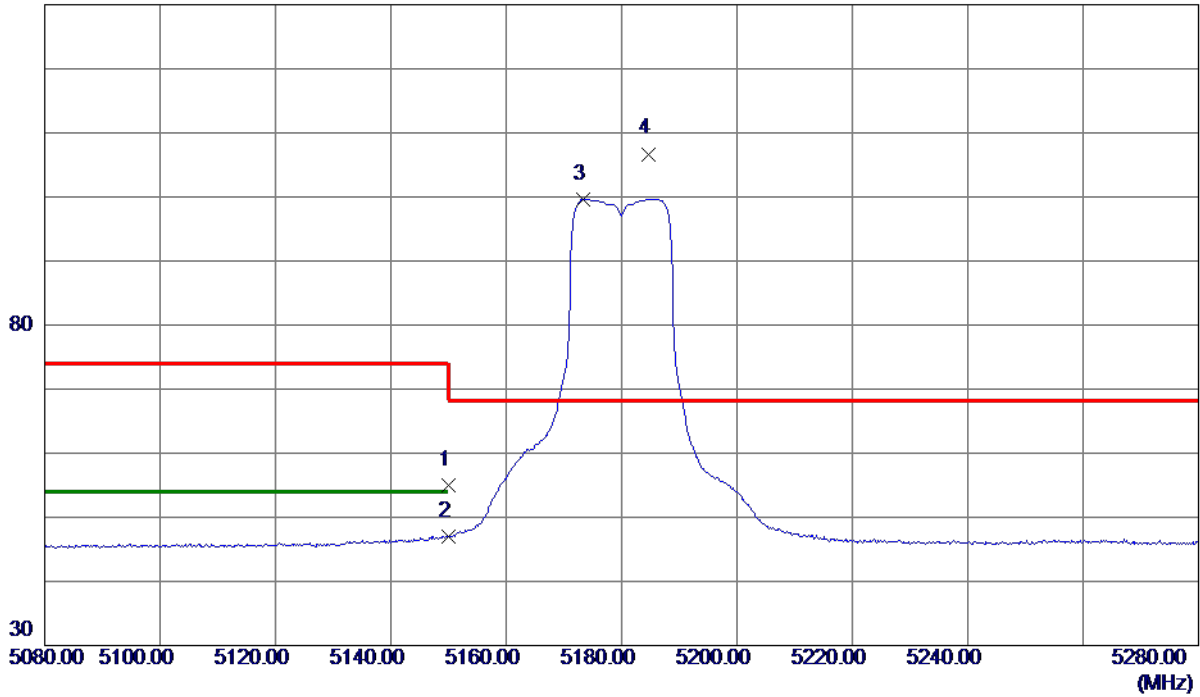

No.	Freq. MHz	Reading Level dBuV/m	Correct Factor dB	Measure ment dBuV/m	Limit dBuV/m	Margin dB	Detector	Comment
1	5150.0000	35.87	19.18	55.05	74.00	-18.95	Peak	
2	5150.0000	27.83	19.18	47.01	54.00	-6.99	AVG	
3	5173.4000	80.40	19.26	99.66	999.00	-899.34	AVG	No Limit
4 *	5184.6000	87.40	19.30	106.70	68.30	38.40	Peak	No Limit

REMARKS:

- (1) Measurement Value = Reading Level + Correct Factor.
- (2) Margin Level = Measurement Value - Limit Value.

Orthogonal Axis	X
Test Mode	UNII-1_TX A Mode 5180 MHz

Vertical

80 dBuV/m

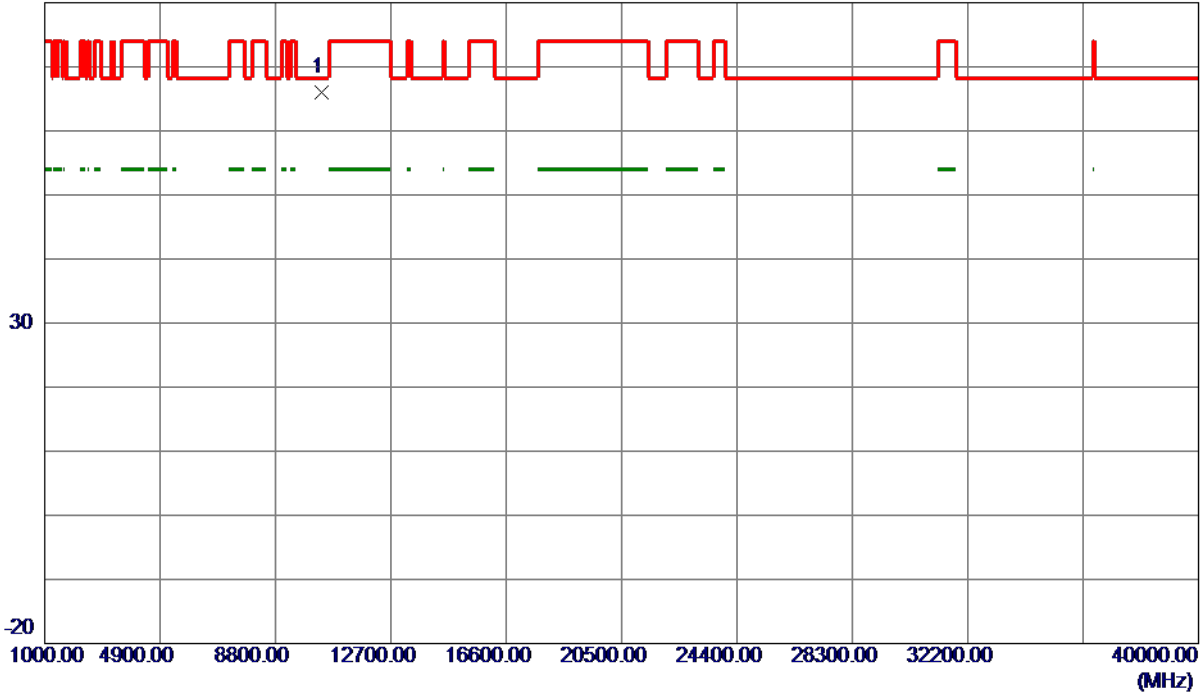

No.	Freq. MHz	Reading Level dBuV/m	Correct Factor dB	Measure ment dBuV/m	Limit dBuV/m	Margin dB	Detector	Comment
1 *	10361.1000	51.15	14.92	66.07	68.30	-2.23	Peak	

REMARKS:

- (1) Measurement Value = Reading Level + Correct Factor.
- (2) Margin Level = Measurement Value - Limit Value.

Orthogonal Axis	X
Test Mode	UNII-1_TX A Mode 5180 MHz

Horizontal

130 dBuV/m

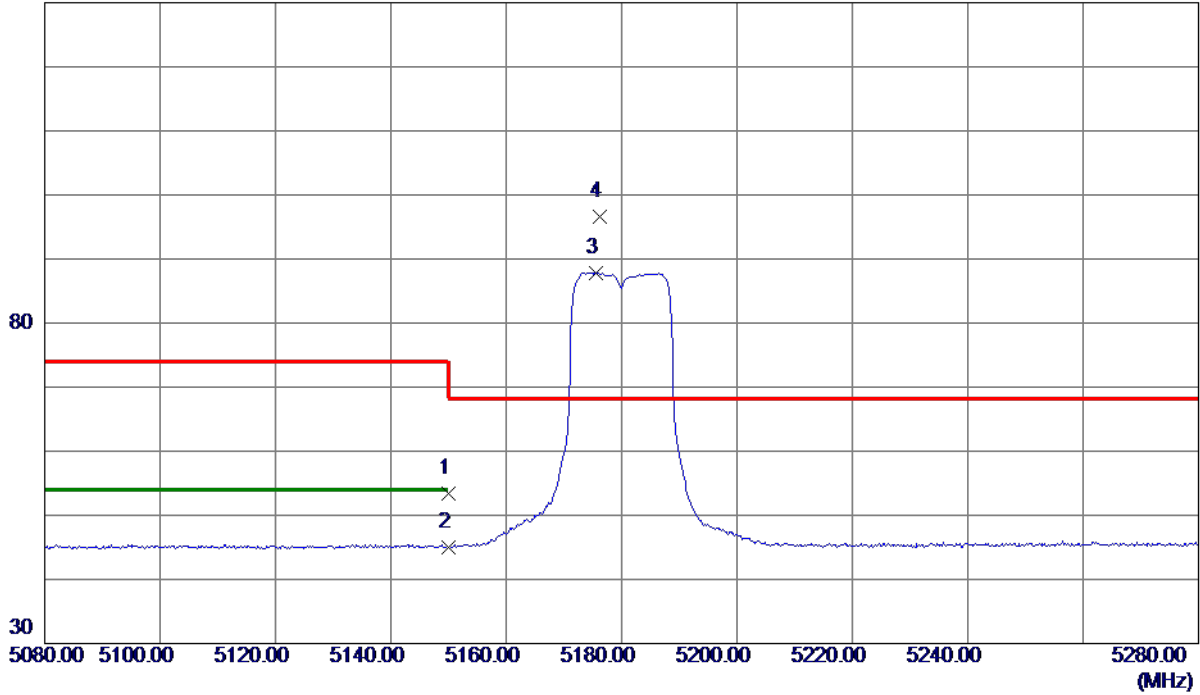

No.	Freq. MHz	Reading Level dBuV/m	Correct Factor dB	Measure ment dBuV/m	Limit dBuV/m	Margin dB	Detector	Comment
1	5150.0000	34.15	19.18	53.33	74.00	-20.67	Peak	
2	5150.0000	25.79	19.18	44.97	54.00	-9.03	AVG	
3	5175.6000	68.61	19.27	87.88	999.00	-911.12	AVG	No Limit
4 *	5176.2000	77.40	19.27	96.67	68.30	28.37	Peak	No Limit

REMARKS:

- (1) Measurement Value = Reading Level + Correct Factor.
- (2) Margin Level = Measurement Value - Limit Value.

Orthogonal Axis	X
Test Mode	UNII-1_TX A Mode 5180 MHz

Horizontal

80 dBuV/m



No.	Freq. MHz	Reading Level dBuV/m	Correct Factor dB	Measure ment dBuV/m	Limit dBuV/m	Margin dB	Detector	Comment
1 *	10359.9330	48.23	14.92	63.15	68.30	-5.15	Peak	

REMARKS:

- (1) Measurement Value = Reading Level + Correct Factor.
- (2) Margin Level = Measurement Value - Limit Value.

Orthogonal Axis	X
Test Mode	UNII-1_TX A Mode 5200 MHz

Vertical

130 dBuV/m

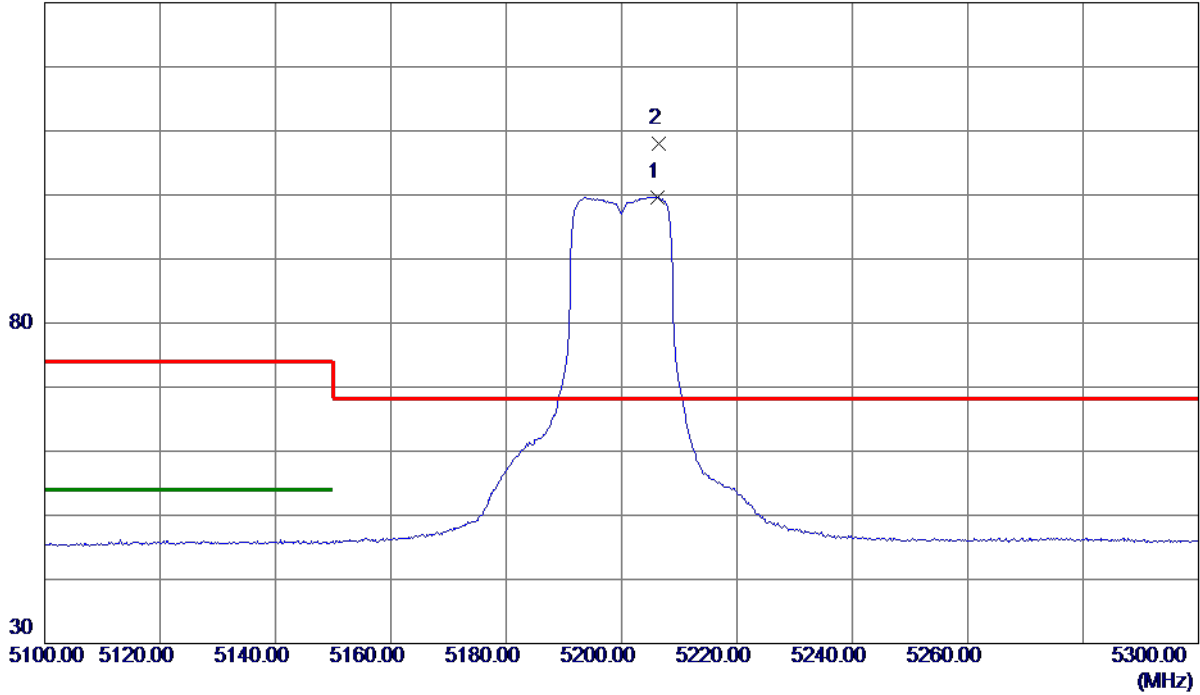

No.	Freq. MHz	Reading Level dBuV/m	Correct Factor dB	Measure ment dBuV/m	Limit dBuV/m	Margin dB	Detector	Comment
1	5206.2000	80.31	19.38	99.69	999.00	-899.31	AVG	No Limit
2 *	5206.4000	88.59	19.38	107.97	68.30	39.67	Peak	No Limit

REMARKS:

- (1) Measurement Value = Reading Level + Correct Factor.
- (2) Margin Level = Measurement Value - Limit Value.

Orthogonal Axis	X
Test Mode	UNII-1_TX A Mode 5200 MHz

Vertical

80 dBuV/m

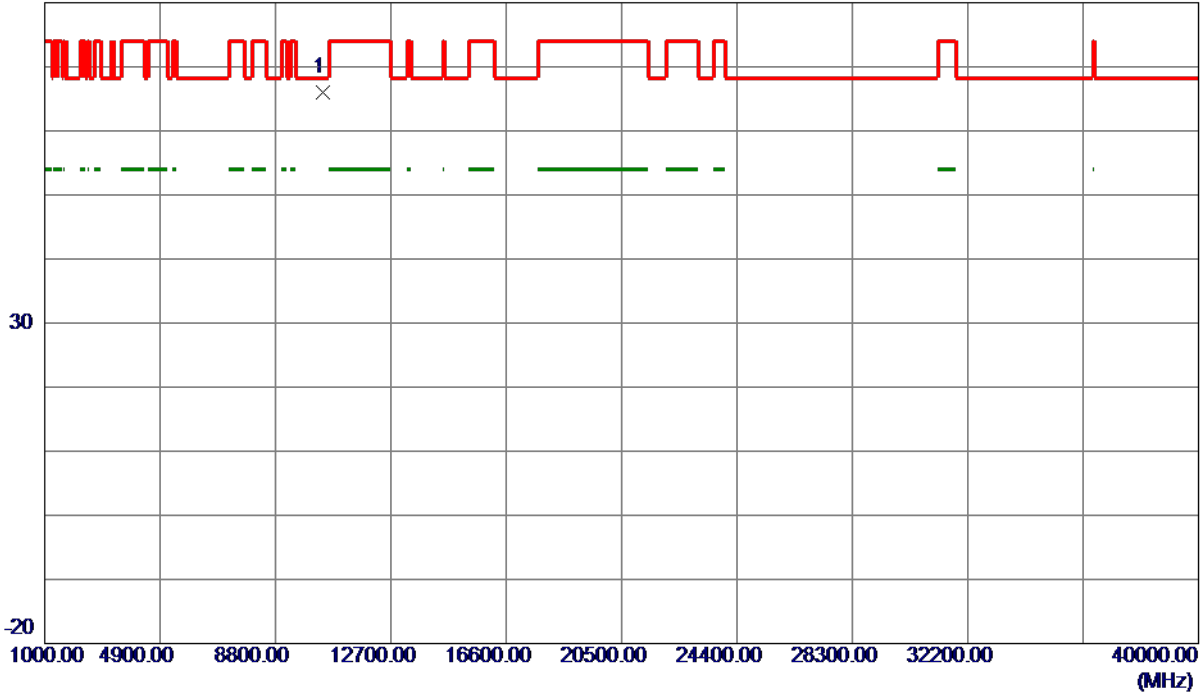

No.	Freq. MHz	Reading Level dBuV/m	Correct Factor dB	Measure ment dBuV/m	Limit dBuV/m	Margin dB	Detector	Comment
1 *	10401.3250	51.04	14.99	66.03	68.30	-2.27	Peak	

REMARKS:

- (1) Measurement Value = Reading Level + Correct Factor.
- (2) Margin Level = Measurement Value - Limit Value.

Orthogonal Axis	X
Test Mode	UNII-1_TX A Mode 5200 MHz

Horizontal

130 dBuV/m

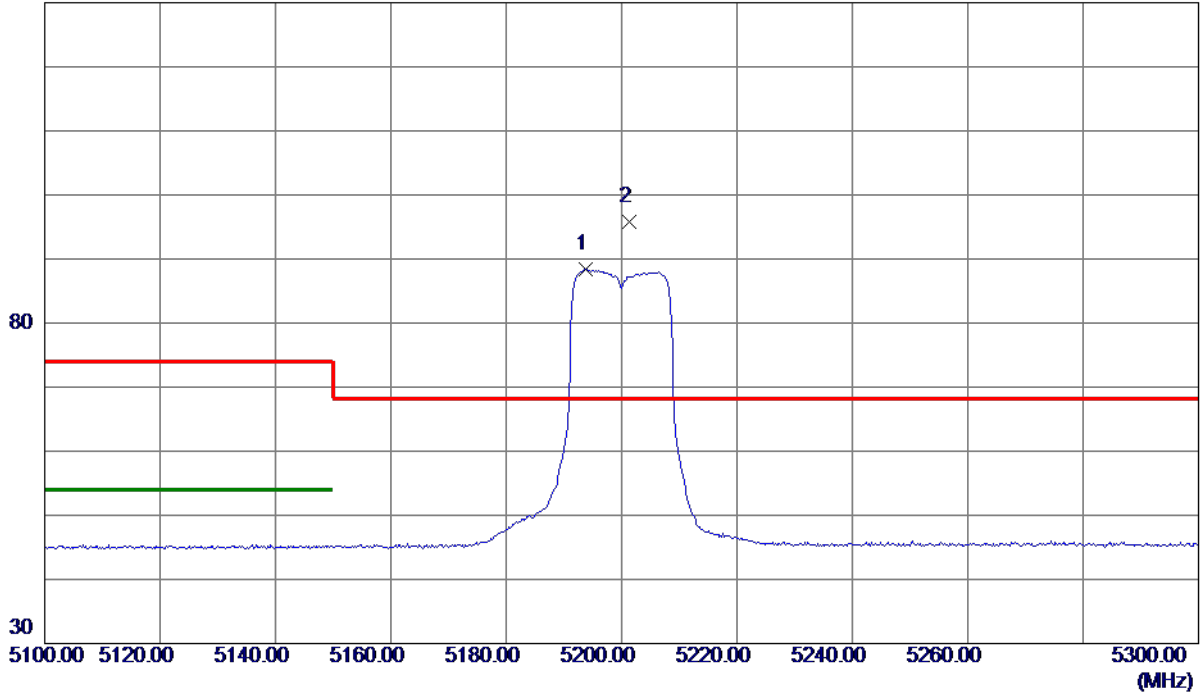

No.	Freq. MHz	Reading Level dBuV/m	Correct Factor dB	Measure ment dBuV/m	Limit dBuV/m	Margin dB	Detector	Comment
1	5193.8000	69.13	19.34	88.47	999.00	-910.53	AVG	No Limit
2 *	5201.4000	76.50	19.37	95.87	68.30	27.57	Peak	No Limit

REMARKS:

- (1) Measurement Value = Reading Level + Correct Factor.
- (2) Margin Level = Measurement Value - Limit Value.

Orthogonal Axis	X
Test Mode	UNII-1_TX A Mode 5200 MHz

Horizontal

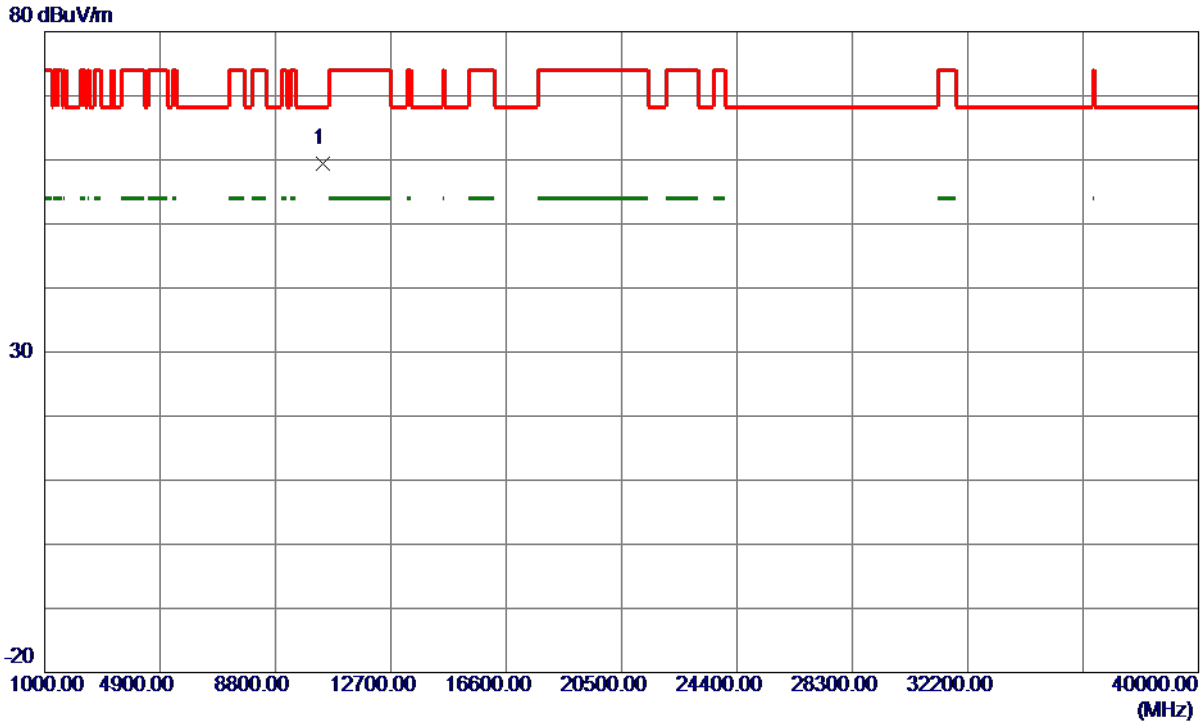

No.	Freq. MHz	Reading Level dBuV/m	Correct Factor dB	Measure ment dBuV/m	Limit dBuV/m	Margin dB	Detector	Comment
1 *	10398.3250	44.43	14.99	59.42	68.30	-8.88	Peak	

REMARKS:

- (1) Measurement Value = Reading Level + Correct Factor.
- (2) Margin Level = Measurement Value - Limit Value.

Orthogonal Axis	X
Test Mode	UNII-1_TX A Mode 5240 MHz

Vertical

130 dBuV/m

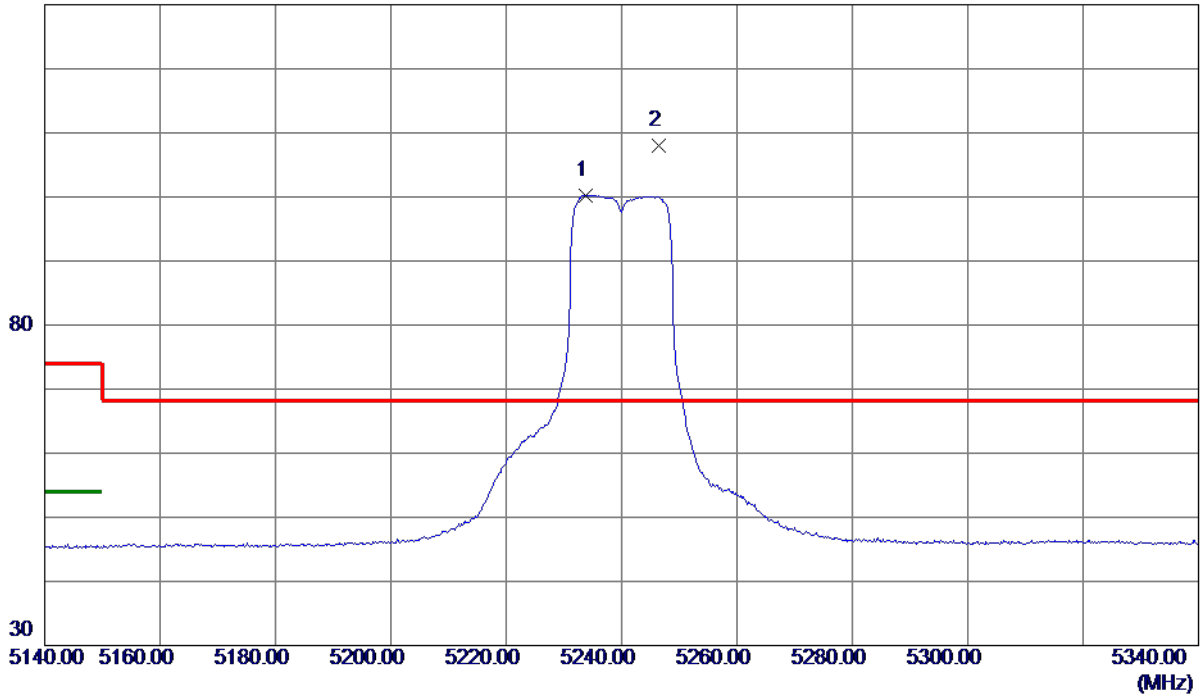

No.	Freq. MHz	Reading Level dBuV/m	Correct Factor dB	Measure ment dBuV/m	Limit dBuV/m	Margin dB	Detector	Comment
1	5233.8000	80.81	19.48	100.29	999.00	-898.71	AVG	No Limit
2 *	5246.4000	88.47	19.53	108.00	68.30	39.70	Peak	No Limit

REMARKS:

- (1) Measurement Value = Reading Level + Correct Factor.
- (2) Margin Level = Measurement Value - Limit Value.

Orthogonal Axis	X
Test Mode	UNII-1_TX A Mode 5240 MHz

Vertical

80 dBuV/m

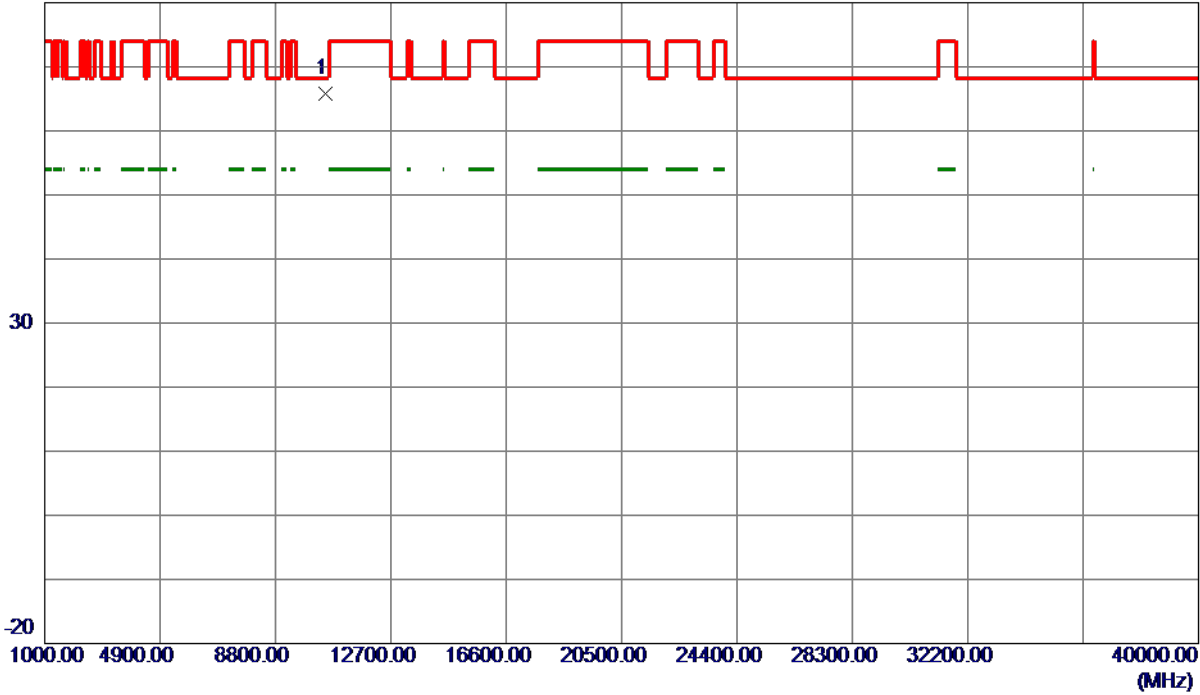

No.	Freq. MHz	Reading Level dBuV/m	Correct Factor dB	Measure ment dBuV/m	Limit dBuV/m	Margin dB	Detector	Comment
1 *	10480.2600	50.72	15.13	65.85	68.30	-2.45	Peak	

REMARKS:

- (1) Measurement Value = Reading Level + Correct Factor.
- (2) Margin Level = Measurement Value - Limit Value.

Orthogonal Axis	X
Test Mode	UNII-1_TX A Mode 5240 MHz

Horizontal

130 dBuV/m

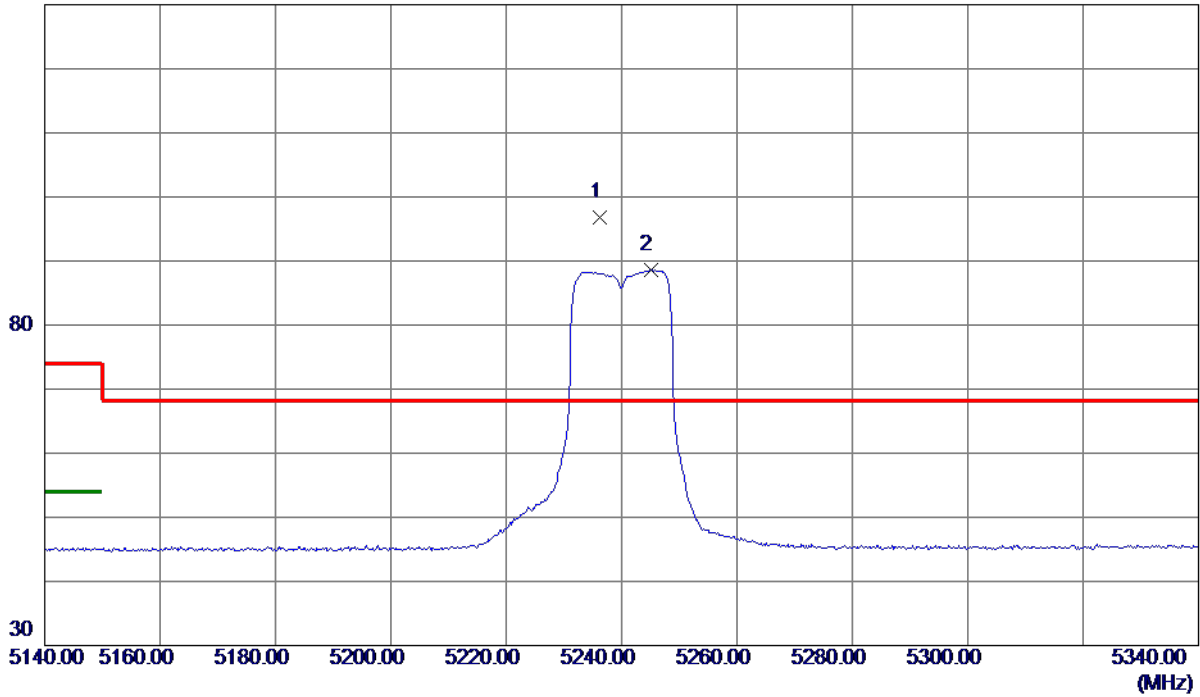

No.	Freq. MHz	Reading Level dBuV/m	Correct Factor dB	Measure ment dBuV/m	Limit dBuV/m	Margin dB	Detector	Comment
1 *	5236.2000	77.30	19.49	96.79	68.30	28.49	Peak	No Limit
2	5245.0000	69.07	19.52	88.59	999.00	-910.41	AVG	No Limit

REMARKS:

- (1) Measurement Value = Reading Level + Correct Factor.
- (2) Margin Level = Measurement Value - Limit Value.

Orthogonal Axis	X
Test Mode	UNII-1_TX A Mode 5240 MHz

Horizontal

80 dBuV/m

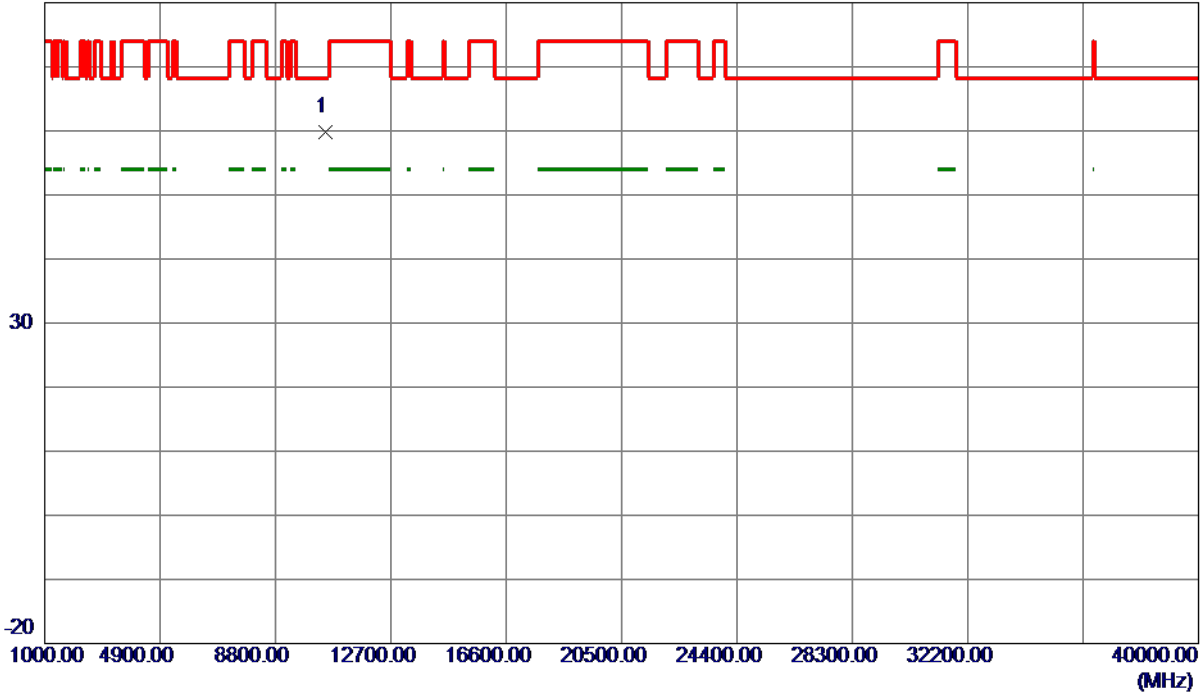

No.	Freq. MHz	Reading Level dBuV/m	Correct Factor dB	Measure ment dBuV/m	Limit dBuV/m	Margin dB	Detector	Comment
1 *	10476.6000	44.69	15.12	59.81	68.30	-8.49	Peak	

REMARKS:

- (1) Measurement Value = Reading Level + Correct Factor.
- (2) Margin Level = Measurement Value - Limit Value.

Orthogonal Axis	X
Test Mode	UNII-1_TX N (HT20) Mode 5180 MHz

Vertical

130 dBuV/m

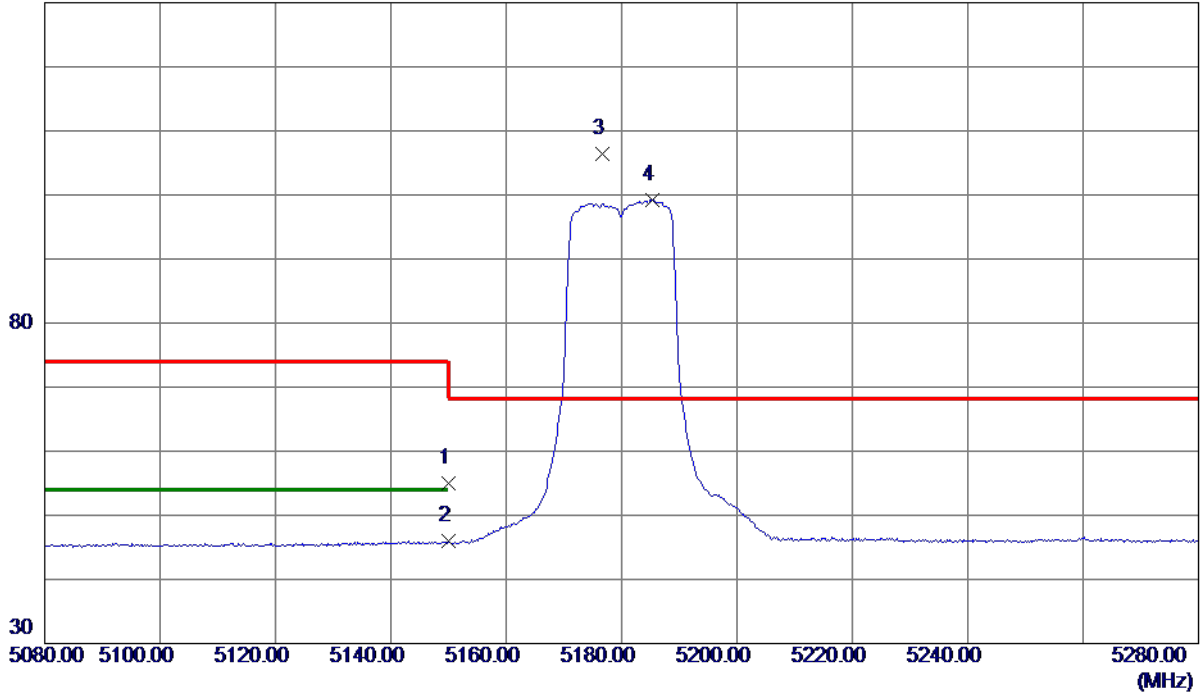

No.	Freq. MHz	Reading Level dBuV/m	Correct Factor dB	Measure ment dBuV/m	Limit dBuV/m	Margin dB	Detector	Comment
1	5150.0000	35.83	19.18	55.01	74.00	-18.99	Peak	
2	5150.0000	26.77	19.18	45.95	54.00	-8.05	AVG	
3 *	5176.6000	87.12	19.27	106.39	68.30	38.09	Peak	No Limit
4	5185.4000	79.97	19.31	99.28	999.00	-899.72	AVG	No Limit

REMARKS:

- (1) Measurement Value = Reading Level + Correct Factor.
- (2) Margin Level = Measurement Value - Limit Value.

Orthogonal Axis	X
Test Mode	UNII-1_TX N (HT20) Mode 5180 MHz

Vertical

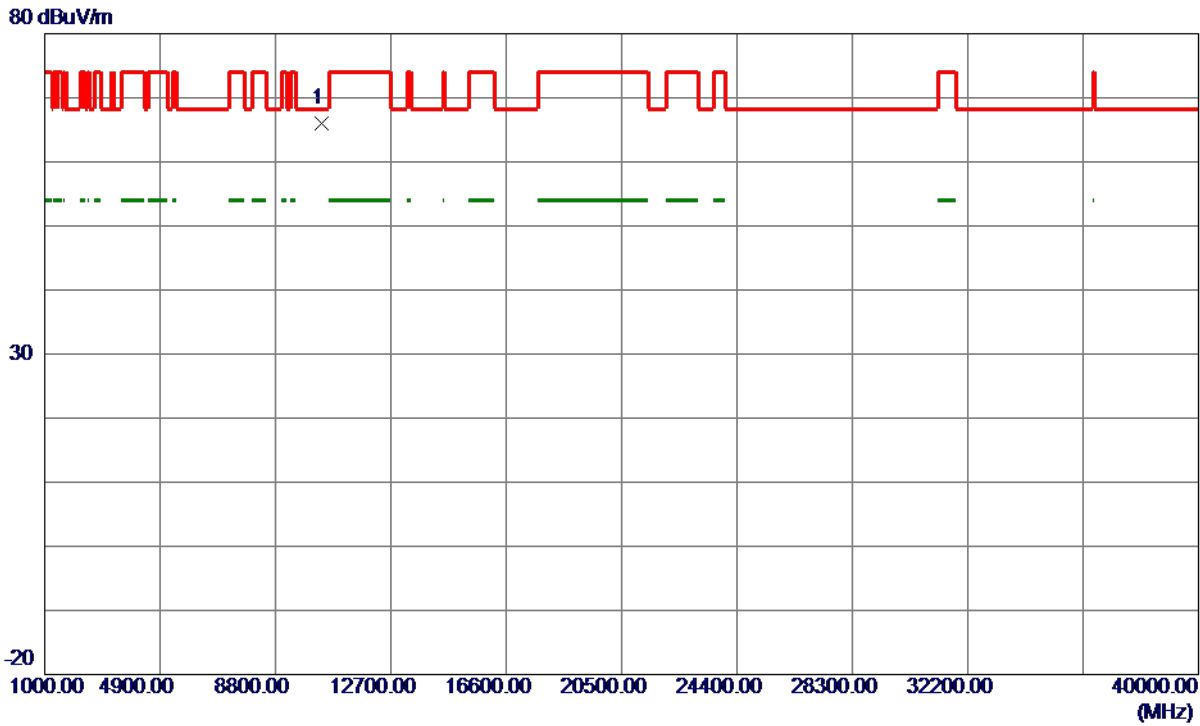

No.	Freq. MHz	Reading Level dBuV/m	Correct Factor dB	Measure ment dBuV/m	Limit dBuV/m	Margin dB	Detector	Comment
1 *	10360.5400	51.12	14.92	66.04	68.30	-2.26	Peak	

REMARKS:

- (1) Measurement Value = Reading Level + Correct Factor.
- (2) Margin Level = Measurement Value - Limit Value.

Orthogonal Axis	X
Test Mode	UNII-1_TX N (HT20) Mode 5180 MHz

Horizontal

130 dBuV/m

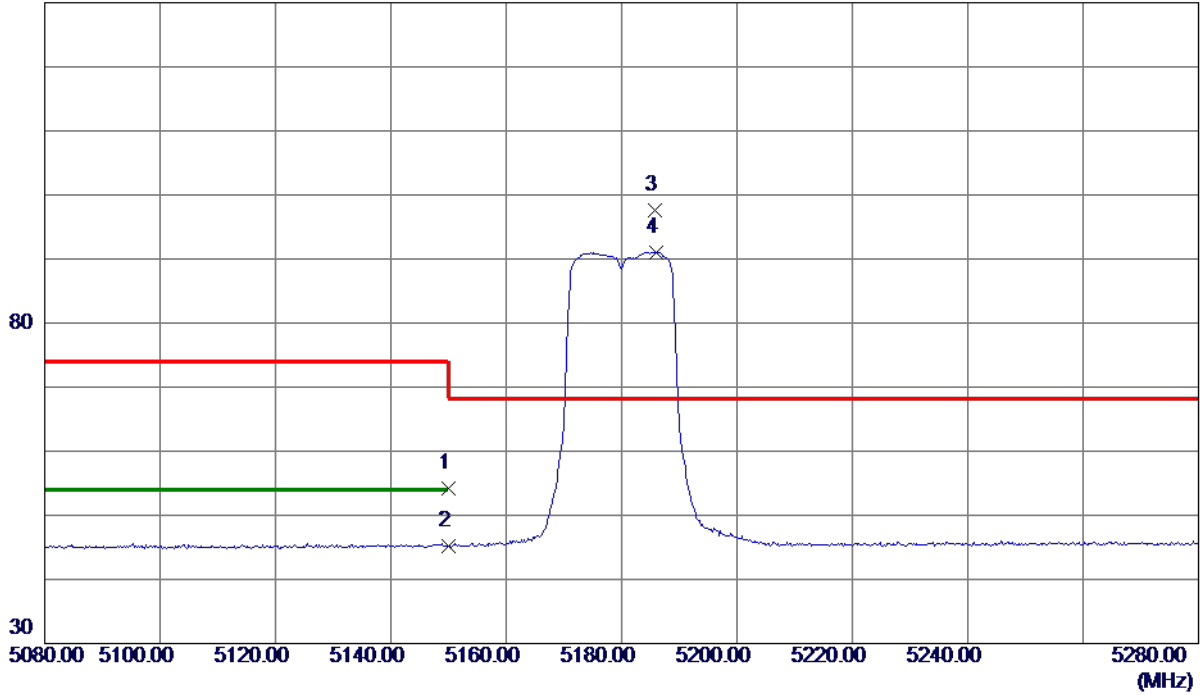

No.	Freq. MHz	Reading Level dBuV/m	Correct Factor dB	Measure ment dBuV/m	Limit dBuV/m	Margin dB	Detector	Comment
1	5150.0000	34.94	19.18	54.12	74.00	-19.88	Peak	
2	5150.0000	26.05	19.18	45.23	54.00	-8.77	AVG	
3 *	5185.8000	78.25	19.31	97.56	68.30	29.26	Peak	No Limit
4	5186.0000	71.76	19.31	91.07	999.00	-907.93	AVG	No Limit

REMARKS:

- (1) Measurement Value = Reading Level + Correct Factor.
- (2) Margin Level = Measurement Value - Limit Value.

Orthogonal Axis	X
Test Mode	UNII-1_TX N (HT20) Mode 5180 MHz

Horizontal

80 dBuV/m

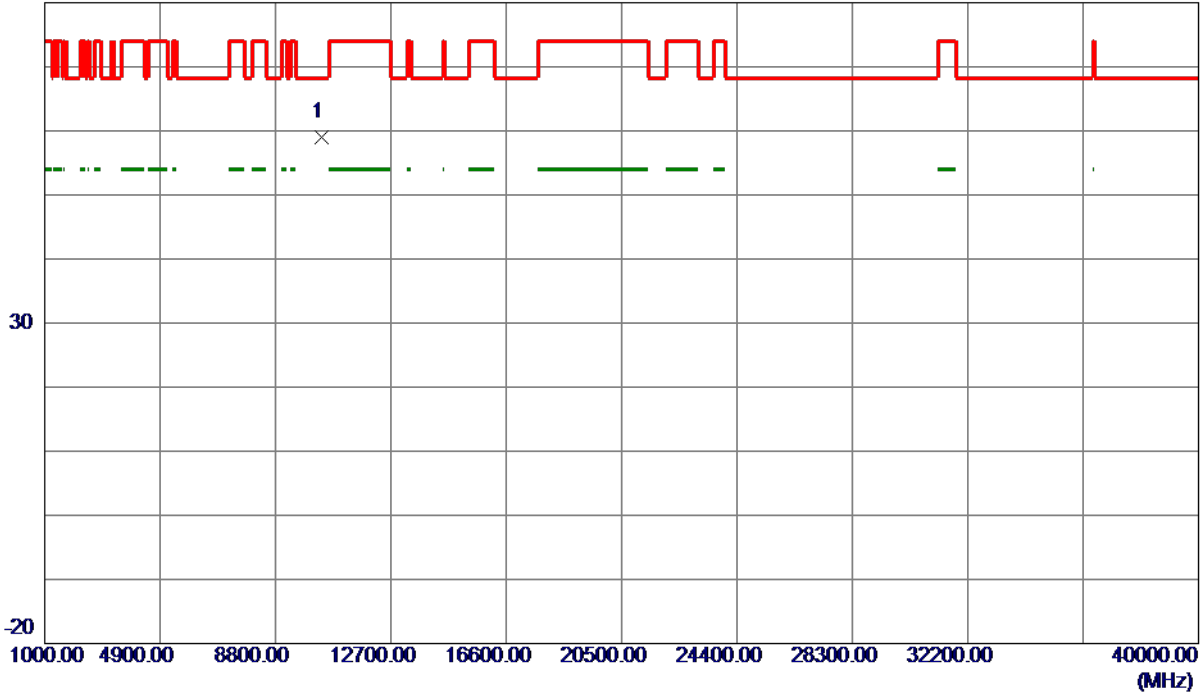

No.	Freq. MHz	Reading Level dBuV/m	Correct Factor dB	Measure ment dBuV/m	Limit dBuV/m	Margin dB	Detector	Comment
1 *	10360.7250	44.16	14.92	59.08	68.30	-9.22	Peak	

REMARKS:

- (1) Measurement Value = Reading Level + Correct Factor.
- (2) Margin Level = Measurement Value - Limit Value.

Orthogonal Axis	X
Test Mode	UNII-1_TX N (HT20) Mode 5200 MHz

Vertical

130 dBuV/m

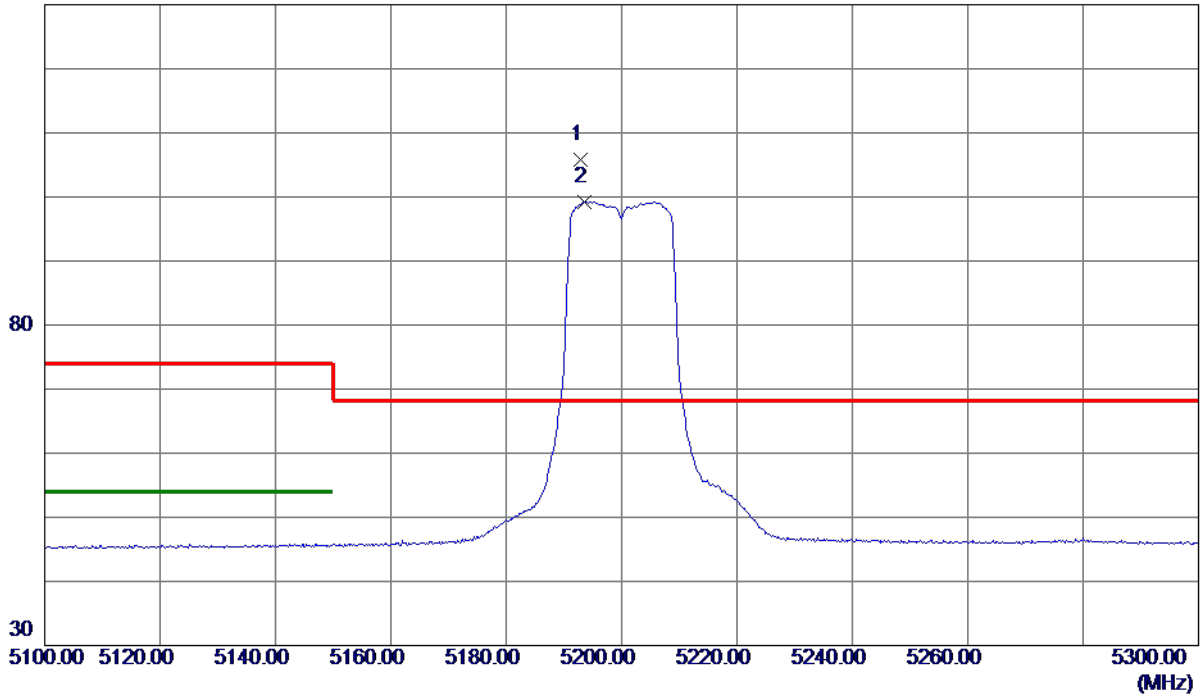

No.	Freq. MHz	Reading Level dBuV/m	Correct Factor dB	Measure ment dBuV/m	Limit dBuV/m	Margin dB	Detector	Comment
1 *	5192.8000	86.55	19.33	105.88	68.30	37.58	Peak	No Limit
2	5193.6000	79.89	19.34	99.23	999.00	-899.77	AVG	No Limit

REMARKS:

- (1) Measurement Value = Reading Level + Correct Factor.
- (2) Margin Level = Measurement Value - Limit Value.

Orthogonal Axis	X
Test Mode	UNII-1_TX N (HT20) Mode 5200 MHz

Vertical

80 dBuV/m

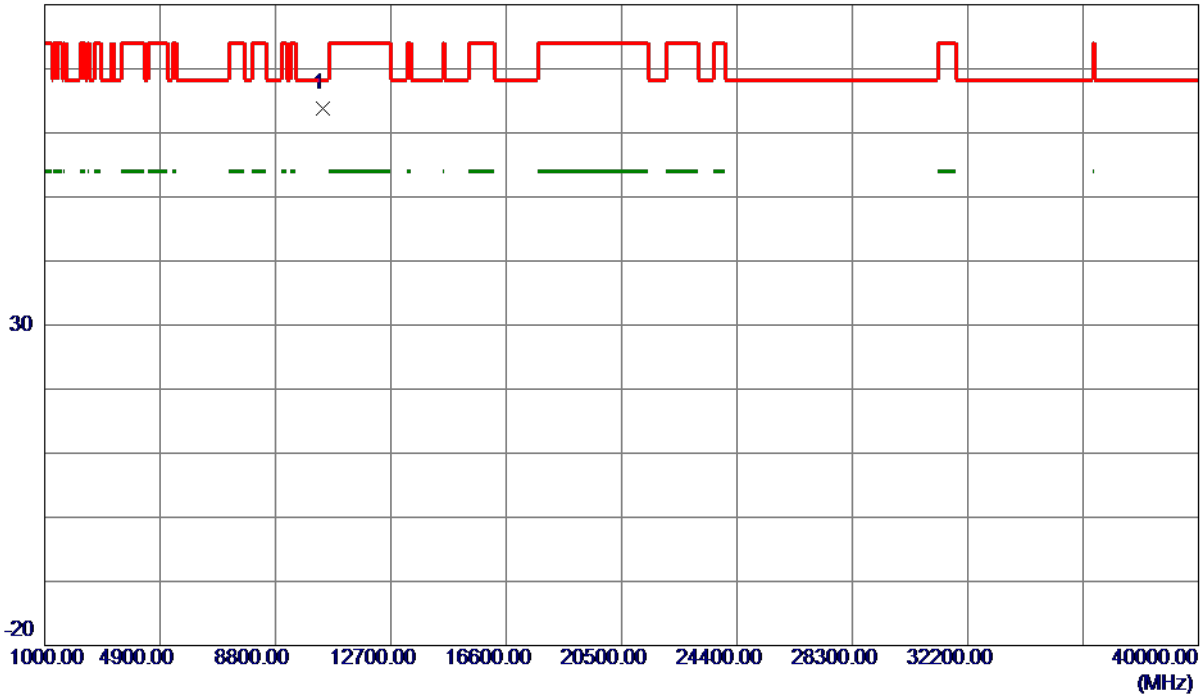

No.	Freq. MHz	Reading Level dBuV/m	Correct Factor dB	Measure ment dBuV/m	Limit dBuV/m	Margin dB	Detector	Comment
1 *	10401.3300	48.90	14.99	63.89	68.30	-4.41	Peak	

REMARKS:

- (1) Measurement Value = Reading Level + Correct Factor.
- (2) Margin Level = Measurement Value - Limit Value.

Orthogonal Axis	X
Test Mode	UNII-1_TX N (HT20) Mode 5200 MHz

Horizontal

130 dBuV/m

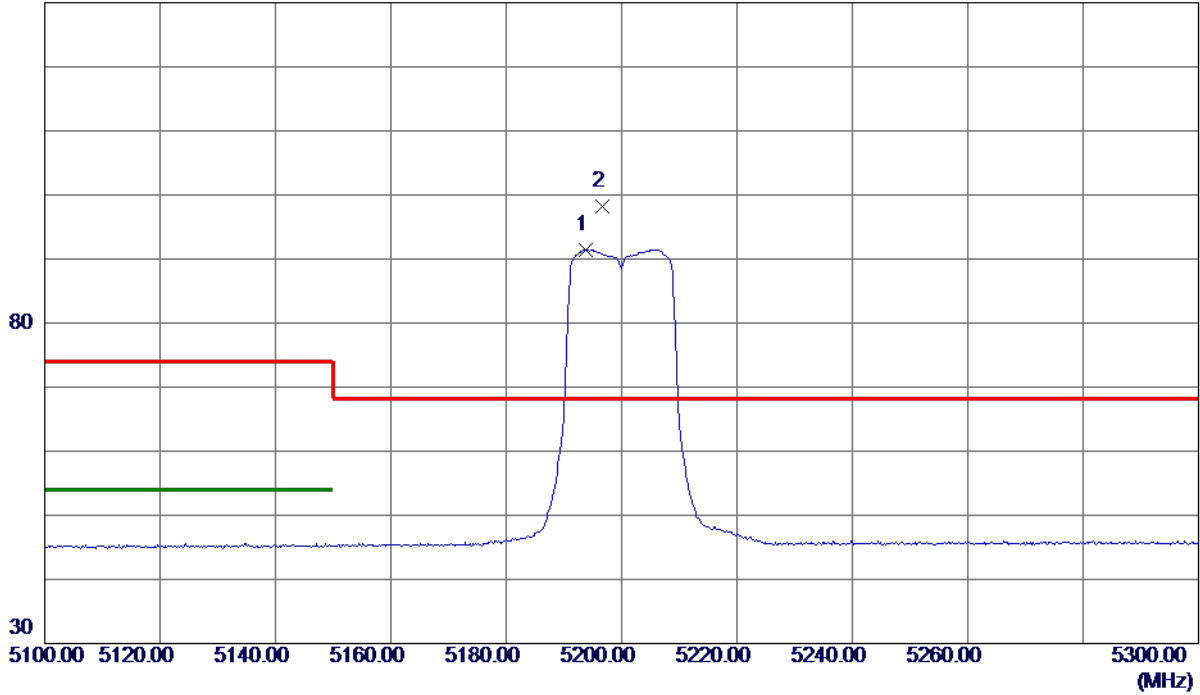

No.	Freq. MHz	Reading Level dBuV/m	Correct Factor dB	Measure ment dBuV/m	Limit dBuV/m	Margin dB	Detector	Comment
1	5193.8000	72.15	19.34	91.49	999.00	-907.51	AVG	No Limit
2 *	5196.6000	78.85	19.35	98.20	68.30	29.90	Peak	No Limit

REMARKS:

- (1) Measurement Value = Reading Level + Correct Factor.
- (2) Margin Level = Measurement Value - Limit Value.

Orthogonal Axis	X
Test Mode	UNII-1_TX N (HT20) Mode 5200 MHz

Horizontal

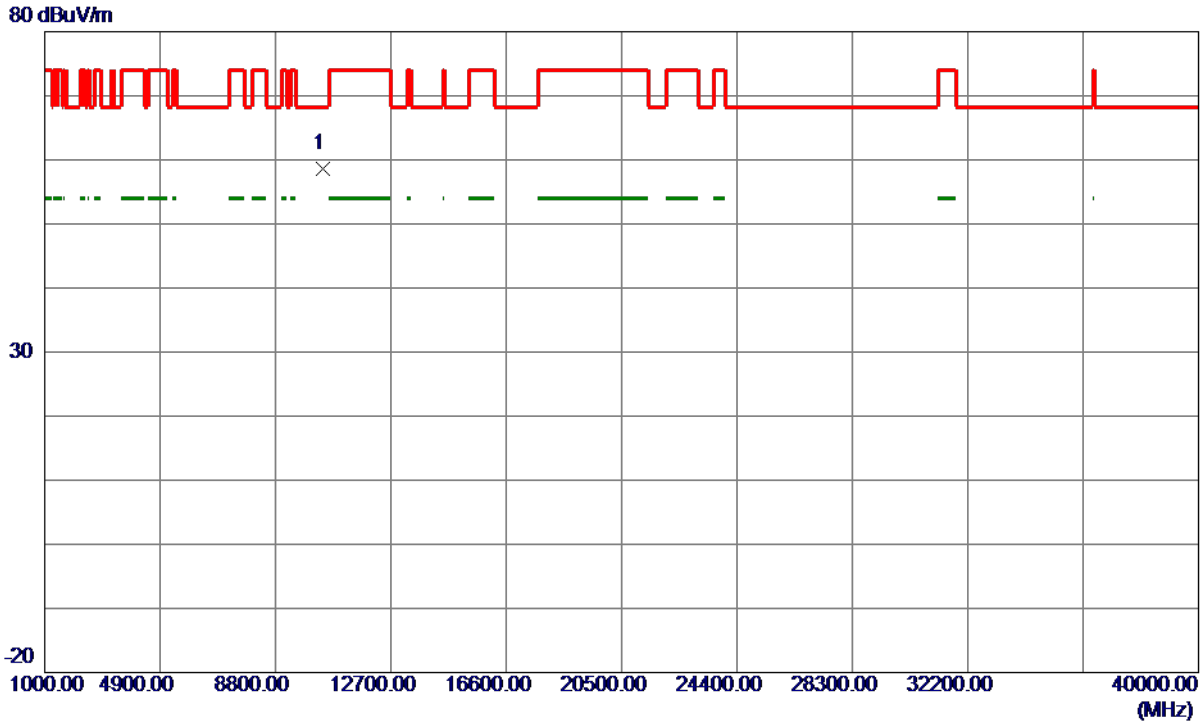

No.	Freq. MHz	Reading Level dBuV/m	Correct Factor dB	Measure ment dBuV/m	Limit dBuV/m	Margin dB	Detector	Comment
1 *	10394.7500	43.60	14.98	58.58	68.30	-9.72	Peak	

REMARKS:

- (1) Measurement Value = Reading Level + Correct Factor.
- (2) Margin Level = Measurement Value - Limit Value.

Orthogonal Axis	X
Test Mode	UNII-1_TX N (HT20) Mode 5240 MHz

Vertical

130 dBuV/m

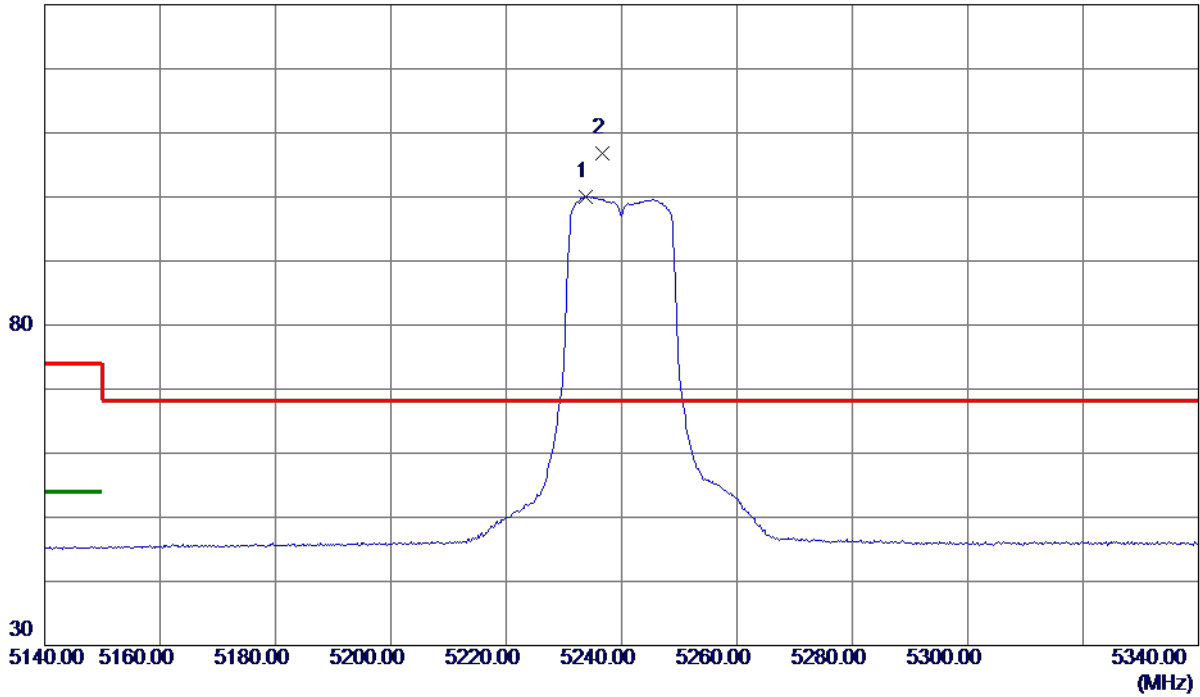

No.	Freq. MHz	Reading Level dBuV/m	Correct Factor dB	Measure ment dBuV/m	Limit dBuV/m	Margin dB	Detector	Comment
1	5233.8000	80.50	19.48	99.98	999.00	-899.02	AVG	No Limit
2 *	5236.6000	87.37	19.49	106.86	68.30	38.56	Peak	No Limit

REMARKS:

- (1) Measurement Value = Reading Level + Correct Factor.
- (2) Margin Level = Measurement Value - Limit Value.

Orthogonal Axis	X
Test Mode	UNII-1_TX N (HT20) Mode 5240 MHz

Vertical

80 dBuV/m

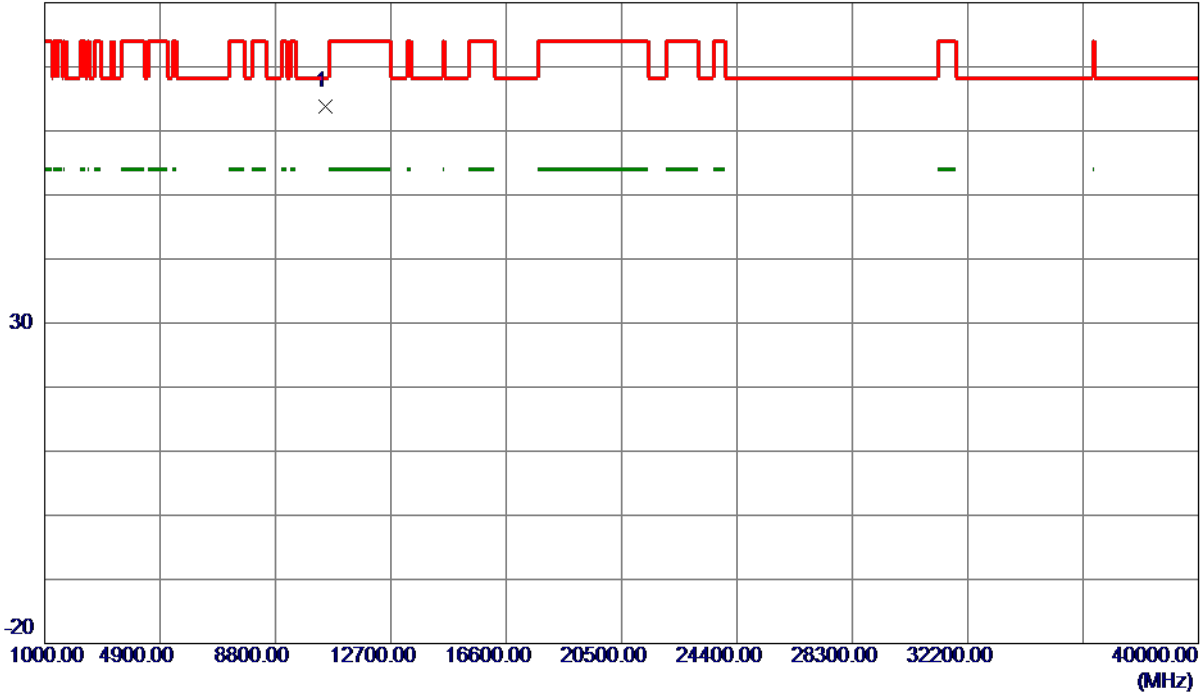

No.	Freq. MHz	Reading Level dBuV/m	Correct Factor dB	Measure ment dBuV/m	Limit dBuV/m	Margin dB	Detector	Comment
1 *	10480.0700	48.74	15.13	63.87	68.30	-4.43	Peak	

REMARKS:

- (1) Measurement Value = Reading Level + Correct Factor.
- (2) Margin Level = Measurement Value - Limit Value.

Orthogonal Axis	X
Test Mode	UNII-1_TX N (HT20) Mode 5240 MHz

Horizontal

130 dBuV/m

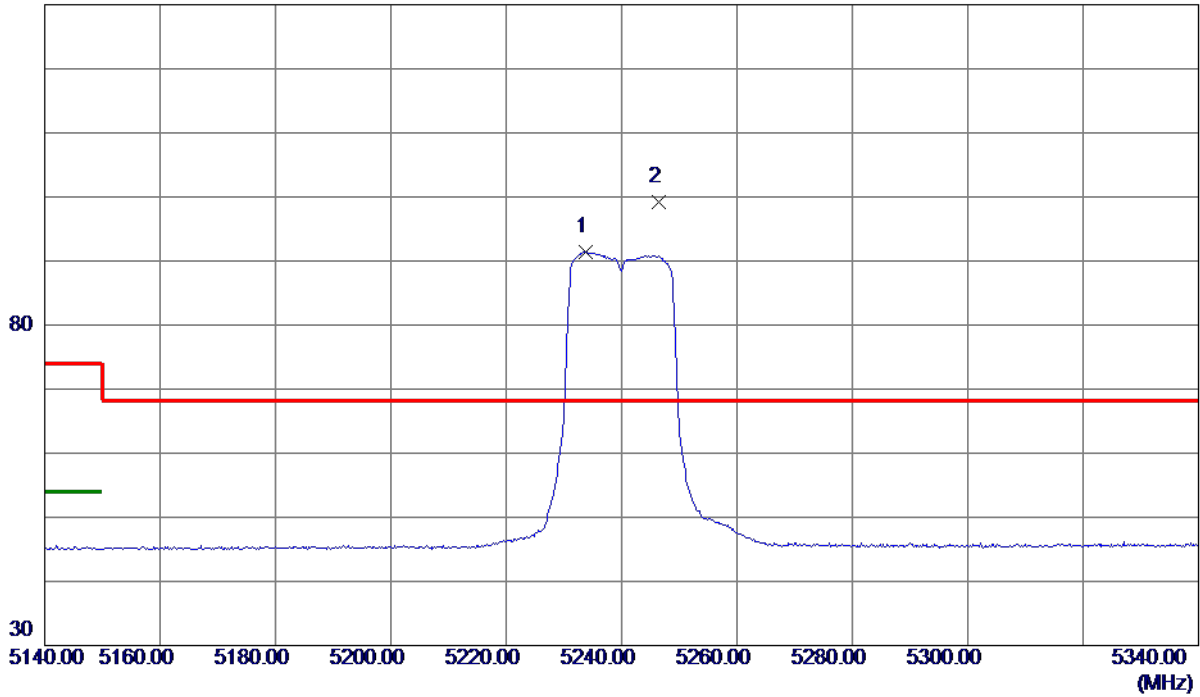

No.	Freq. MHz	Reading Level dBuV/m	Correct Factor dB	Measure ment dBuV/m	Limit dBuV/m	Margin dB	Detector	Comment
1	5233.8000	71.90	19.48	91.38	999.00	-907.62	AVG	No Limit
2 *	5246.4000	79.65	19.53	99.18	68.30	30.88	Peak	No Limit

REMARKS:

- (1) Measurement Value = Reading Level + Correct Factor.
- (2) Margin Level = Measurement Value - Limit Value.

Orthogonal Axis	X
Test Mode	UNII-1_TX N (HT20) Mode 5240 MHz

Horizontal

80 dBuV/m

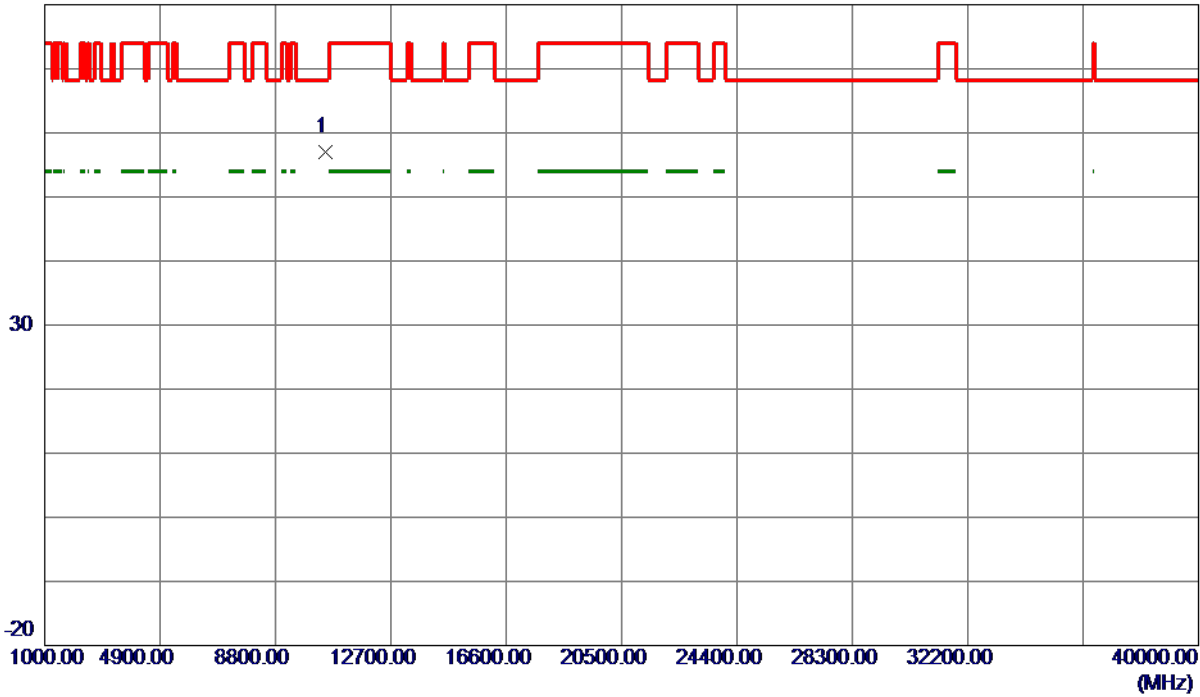

No.	Freq. MHz	Reading Level dBuV/m	Correct Factor dB	Measure ment dBuV/m	Limit dBuV/m	Margin dB	Detector	Comment
1 *	10478.5500	41.80	15.12	56.92	68.30	-11.38	Peak	

REMARKS:

- (1) Measurement Value = Reading Level + Correct Factor.
- (2) Margin Level = Measurement Value - Limit Value.

Orthogonal Axis	X
Test Mode	UNII-1_TX N (HT40) Mode 5190 MHz

Vertical

130 dBuV/m

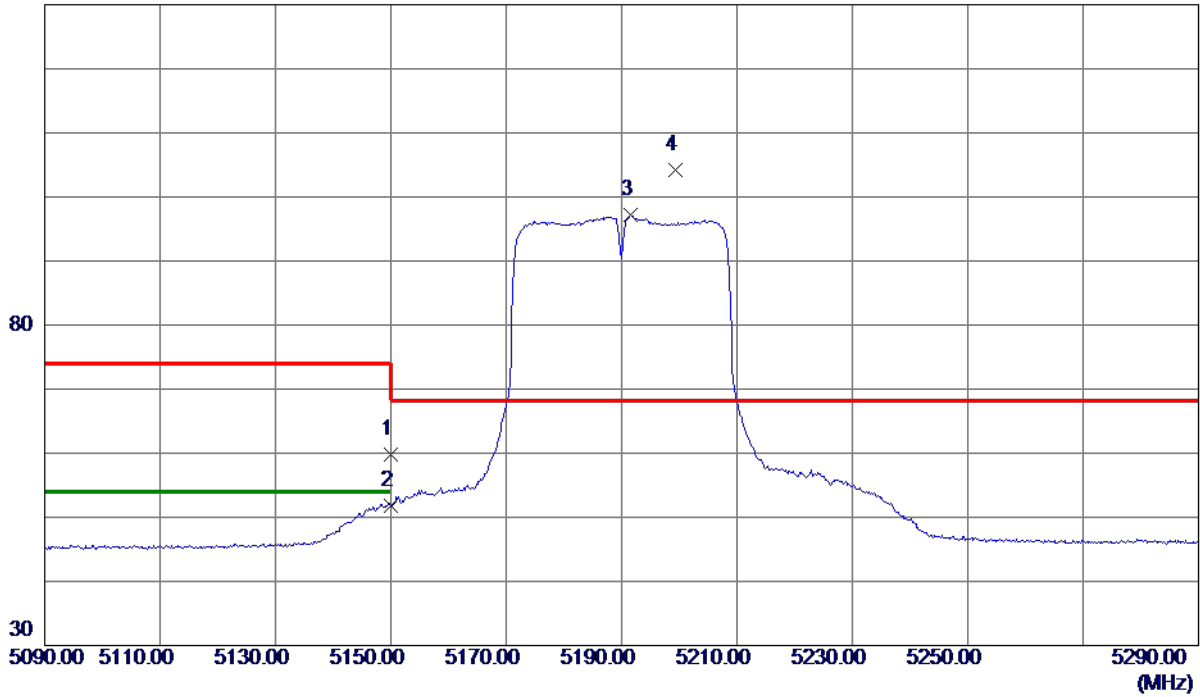

No.	Freq. MHz	Reading Level dBuV/m	Correct Factor dB	Measure ment dBuV/m	Limit dBuV/m	Margin dB	Detector	Comment
1	5150.0000	40.55	19.18	59.73	74.00	-14.27	Peak	
2	5150.0000	32.70	19.18	51.88	54.00	-2.12	AVG	
3	5191.6000	77.85	19.33	97.18	999.00	-901.82	AVG	No Limit
4 *	5199.4000	84.91	19.36	104.27	68.30	35.97	Peak	No Limit

REMARKS:

- (1) Measurement Value = Reading Level + Correct Factor.
- (2) Margin Level = Measurement Value - Limit Value.

Orthogonal Axis	X
Test Mode	UNII-1_TX N (HT40) Mode 5190 MHz

Vertical

80 dBuV/m

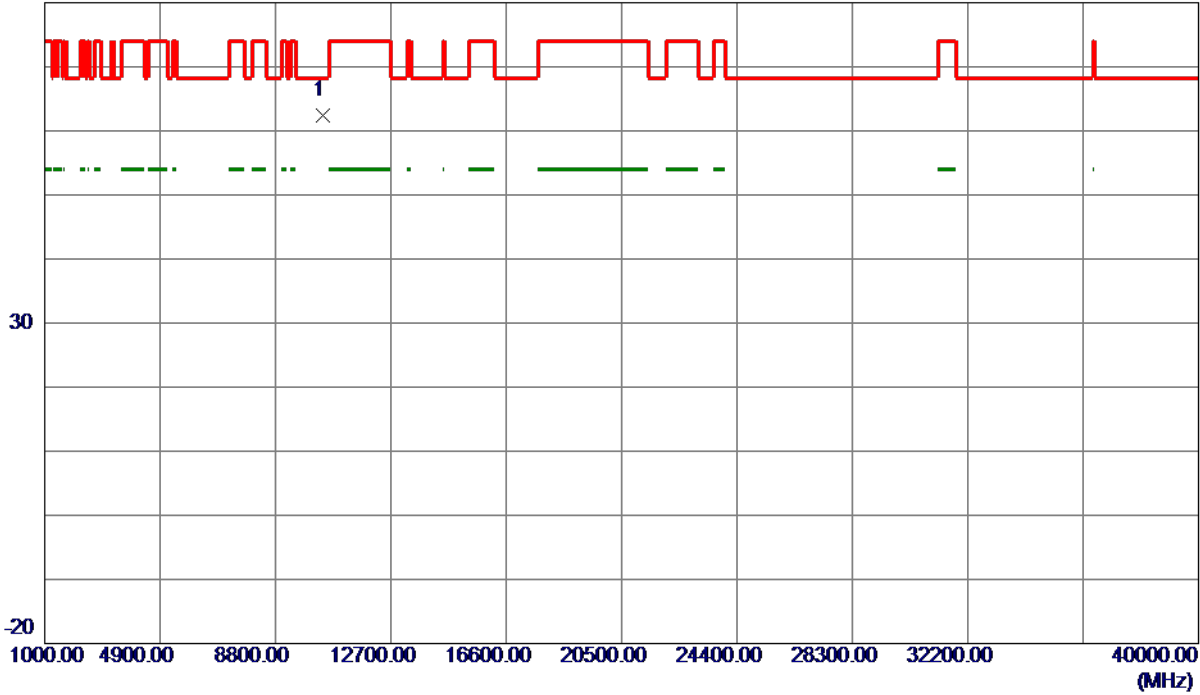

No.	Freq. MHz	Reading Level dBuV/m	Correct Factor dB	Measure ment dBuV/m	Limit dBuV/m	Margin dB	Detector	Comment
1 *	10384.2200	47.42	14.96	62.38	68.30	-5.92	Peak	

REMARKS:

- (1) Measurement Value = Reading Level + Correct Factor.
- (2) Margin Level = Measurement Value - Limit Value.

Orthogonal Axis	X
Test Mode	UNII-1_TX N (HT40) Mode 5190 MHz

Horizontal

130 dBuV/m

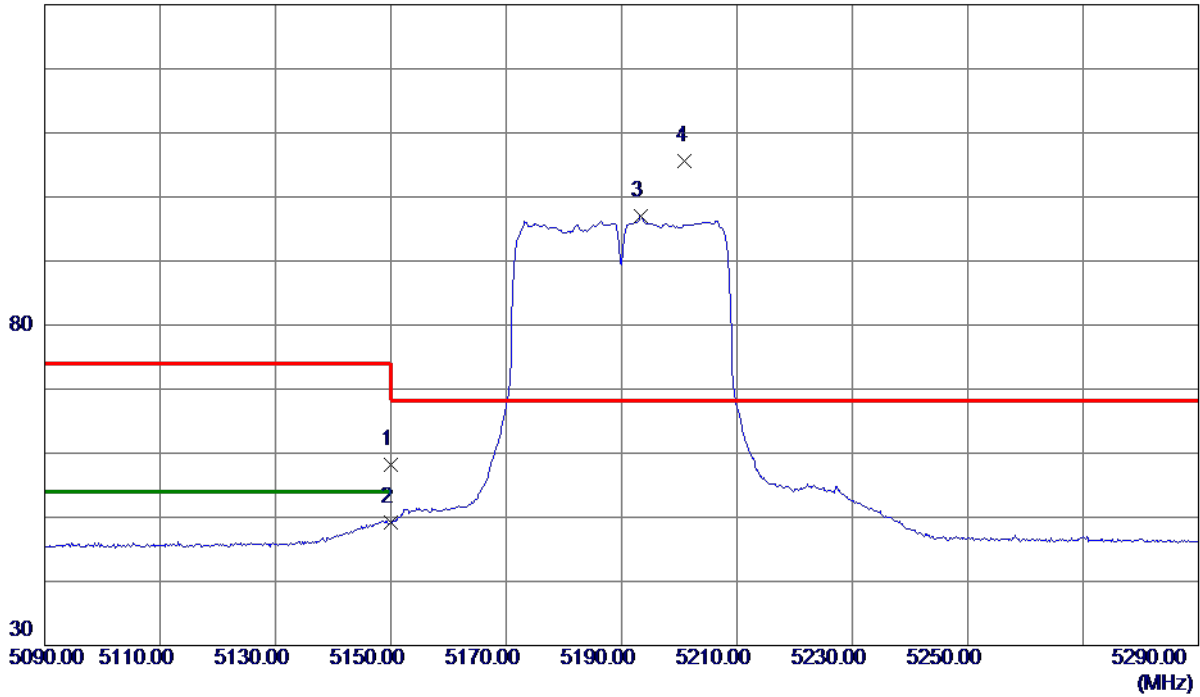

No.	Freq. MHz	Reading Level dBuV/m	Correct Factor dB	Measure ment dBuV/m	Limit dBuV/m	Margin dB	Detector	Comment
1	5150.0000	39.03	19.18	58.21	74.00	-15.79	Peak	
2	5150.0000	30.00	19.18	49.18	54.00	-4.82	AVG	
3	5193.4000	77.74	19.34	97.08	999.00	-901.92	AVG	No Limit
4 *	5201.0000	86.22	19.36	105.58	68.30	37.28	Peak	No Limit

REMARKS:

- (1) Measurement Value = Reading Level + Correct Factor.
- (2) Margin Level = Measurement Value - Limit Value.

Orthogonal Axis	X
Test Mode	UNII-1_TX N (HT40) Mode 5190 MHz

Horizontal

80 dBuV/m

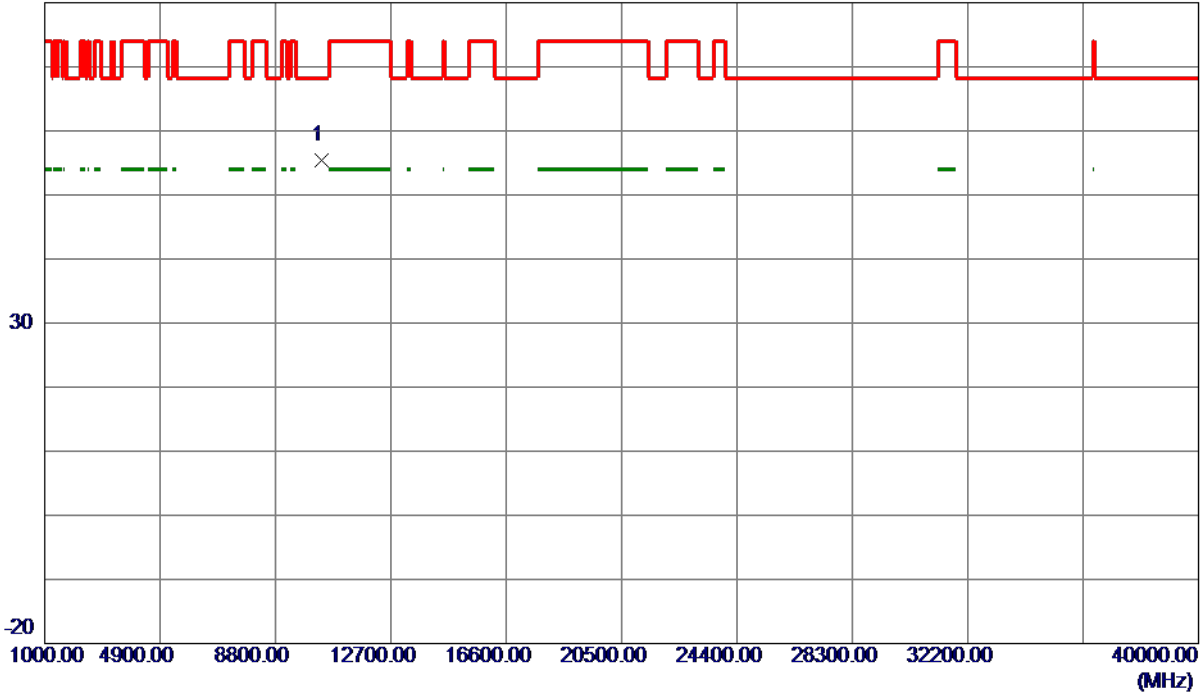

No.	Freq. MHz	Reading Level dBuV/m	Correct Factor dB	Measure ment dBuV/m	Limit dBuV/m	Margin dB	Detector	Comment
1 *	10377.0500	40.49	14.95	55.44	68.30	-12.86	Peak	

REMARKS:

- (1) Measurement Value = Reading Level + Correct Factor.
- (2) Margin Level = Measurement Value - Limit Value.

Orthogonal Axis	X
Test Mode	UNII-1_TX N (HT40) Mode 5230 MHz

Vertical

130 dBuV/m

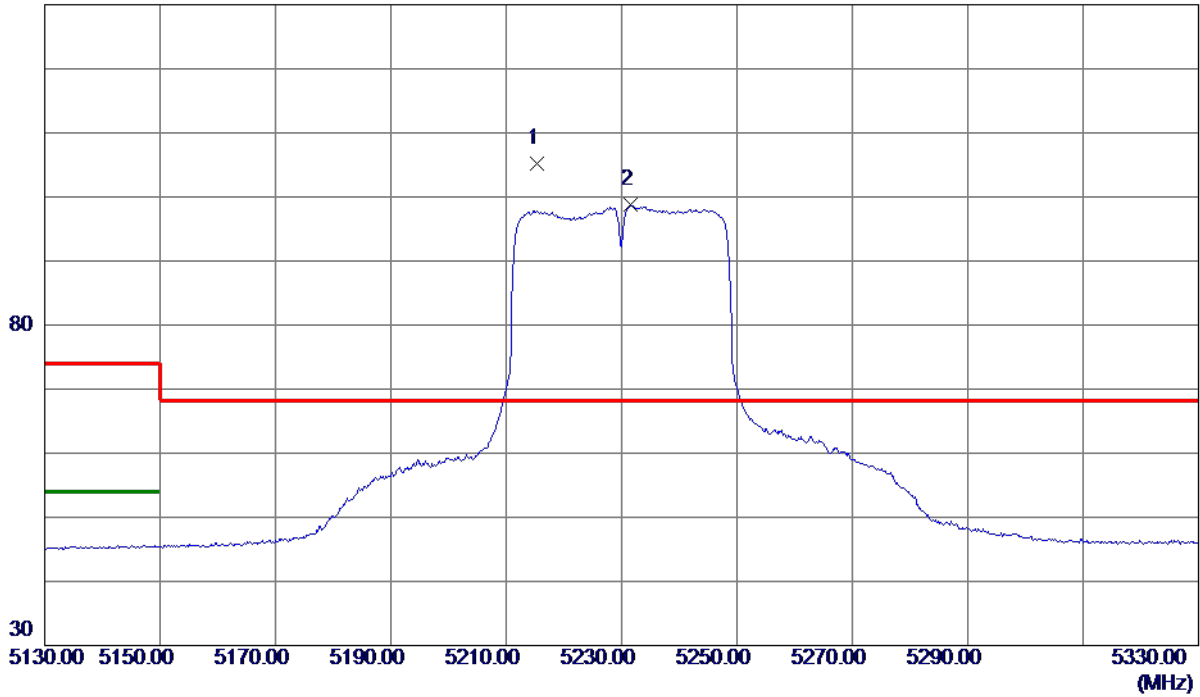

No.	Freq. MHz	Reading Level dBuV/m	Correct Factor dB	Measure ment dBuV/m	Limit dBuV/m	Margin dB	Detector	Comment
1 *	5215.4000	85.70	19.42	105.12	68.30	36.82	Peak	No Limit
2	5231.6000	79.25	19.48	98.73	999.00	-900.27	AVG	No Limit

REMARKS:

- (1) Measurement Value = Reading Level + Correct Factor.
- (2) Margin Level = Measurement Value - Limit Value.

Orthogonal Axis	X
Test Mode	UNII-1_TX N (HT40) Mode 5230 MHz

Vertical

80 dBuV/m

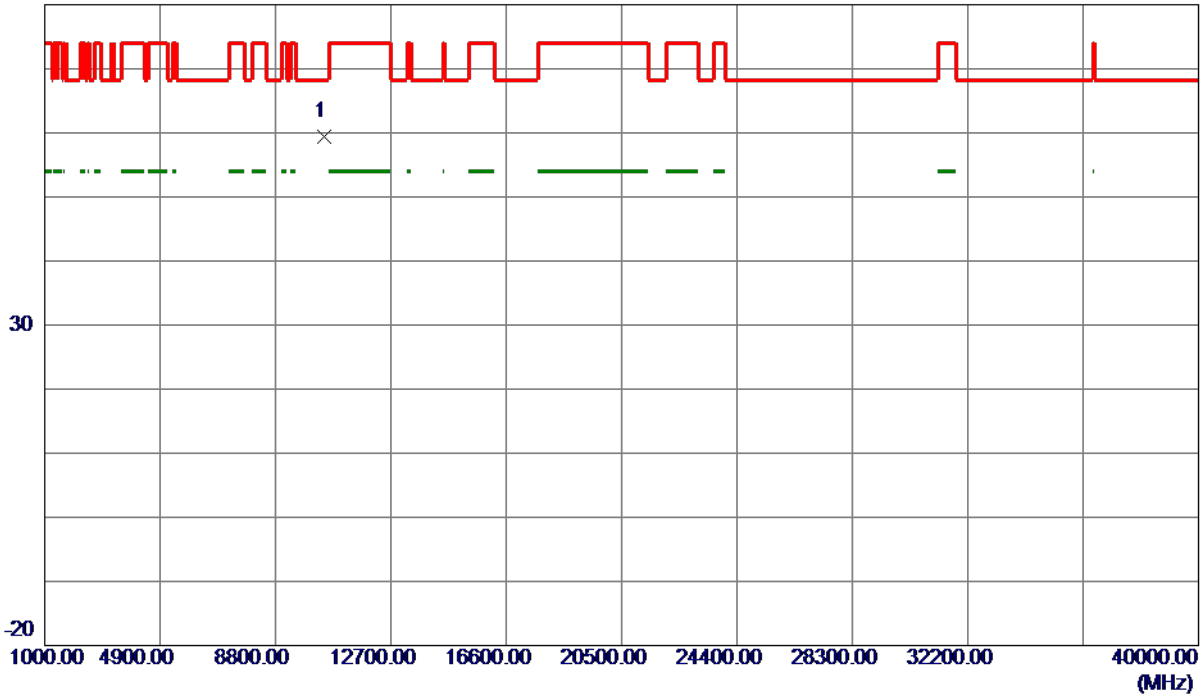

No.	Freq. MHz	Reading Level dBuV/m	Correct Factor dB	Measure ment dBuV/m	Limit dBuV/m	Margin dB	Detector	Comment
1 *	10464.1000	44.30	15.10	59.40	68.30	-8.90	Peak	

REMARKS:

- (1) Measurement Value = Reading Level + Correct Factor.
- (2) Margin Level = Measurement Value - Limit Value.

Orthogonal Axis	X
Test Mode	UNII-1_TX N (HT40) Mode 5230 MHz

Horizontal

130 dBuV/m

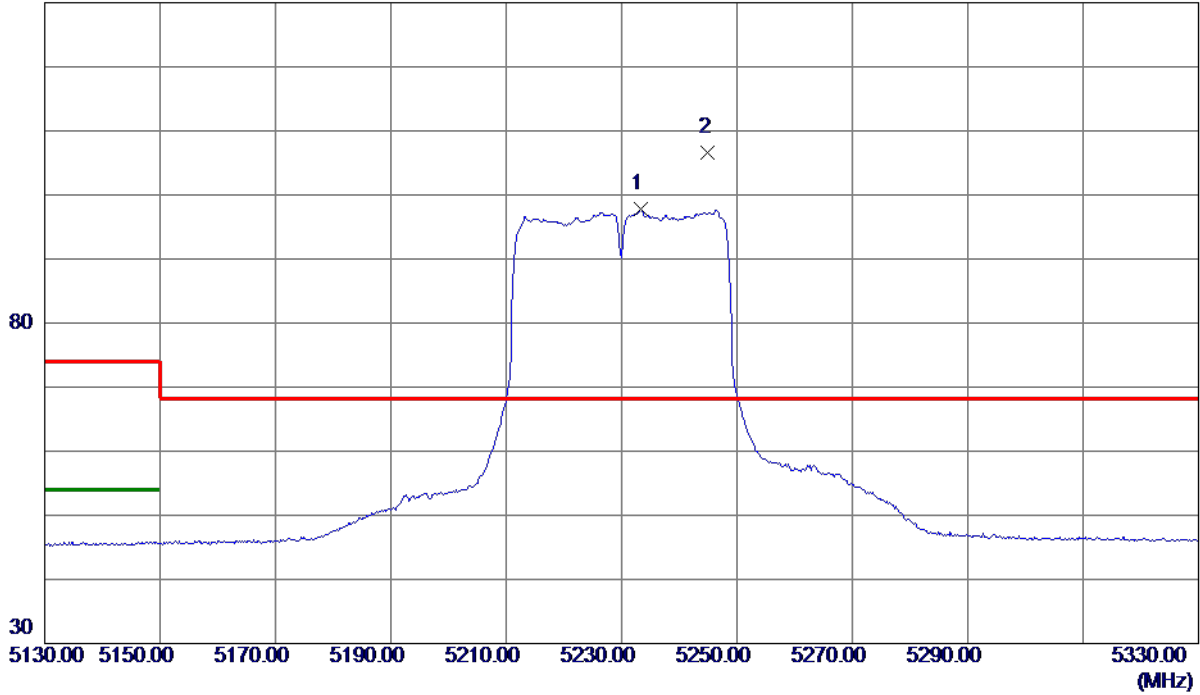

No.	Freq. MHz	Reading Level dBuV/m	Correct Factor dB	Measure ment dBuV/m	Limit dBuV/m	Margin dB	Detector	Comment
1	5233.4000	78.35	19.48	97.83	999.00	-901.17	AVG	No Limit
2 *	5245.0000	87.01	19.52	106.53	68.30	38.23	Peak	No Limit

REMARKS:

- (1) Measurement Value = Reading Level + Correct Factor.
- (2) Margin Level = Measurement Value - Limit Value.

Orthogonal Axis	X
Test Mode	UNII-1_TX N (HT40) Mode 5230 MHz

Horizontal

80 dBuV/m

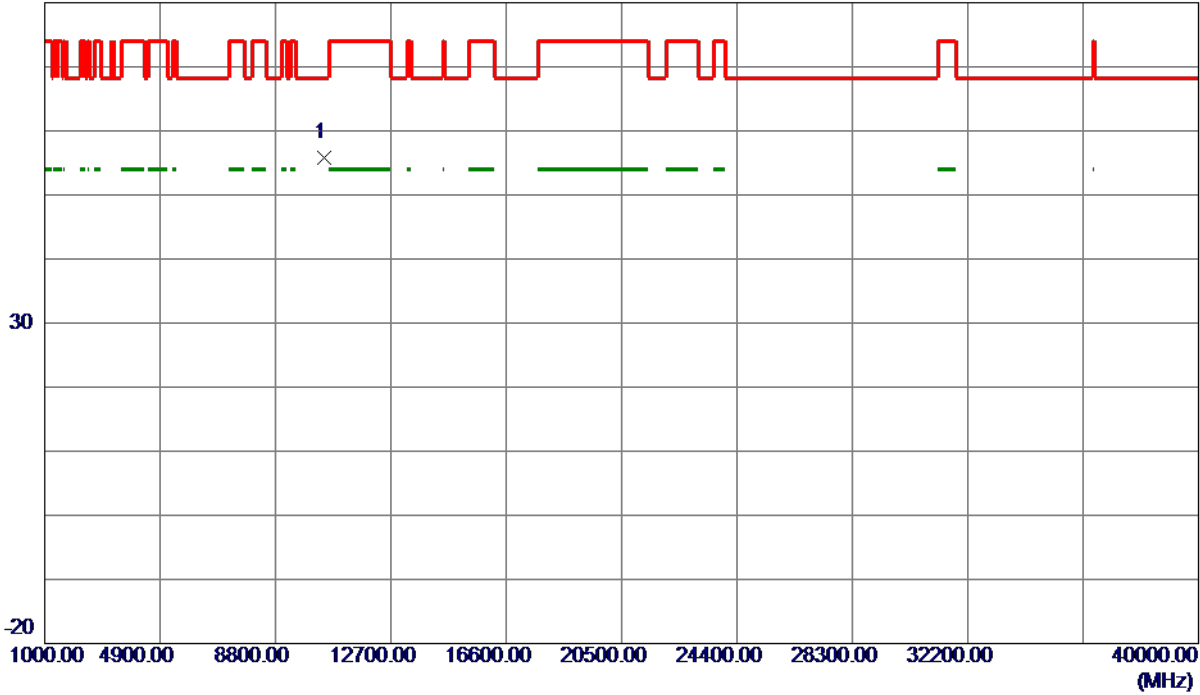

No.	Freq. MHz	Reading Level dBuV/m	Correct Factor dB	Measure ment dBuV/m	Limit dBuV/m	Margin dB	Detector	Comment
1 *	10456.5000	40.77	15.09	55.86	68.30	-12.44	Peak	

REMARKS:

- (1) Measurement Value = Reading Level + Correct Factor.
- (2) Margin Level = Measurement Value - Limit Value.

Orthogonal Axis	X
Test Mode	UNII-3_TX A Mode 5745 MHz

Vertical

130 dBuV/m

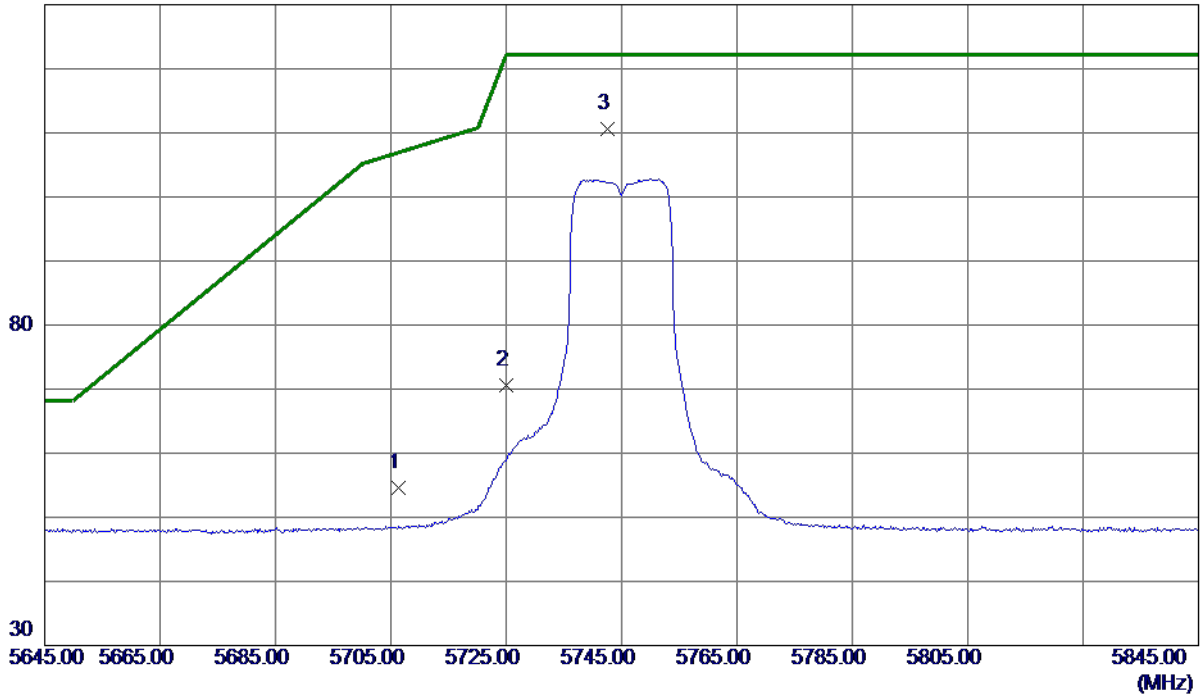

No.	Freq. MHz	Reading Level dBuV/m	Correct Factor dB	Measure ment dBuV/m	Limit dBuV/m	Margin dB	Detector	Comment
1	5706.4000	33.15	21.46	54.61	106.99	-52.38	Peak	
2	5725.0000	49.14	21.55	70.69	122.20	-51.51	Peak	
3 *	5742.6000	89.03	21.64	110.67	122.20	-11.53	Peak	No Limit

REMARKS:

- (1) Measurement Value = Reading Level + Correct Factor.
- (2) Margin Level = Measurement Value - Limit Value.

Orthogonal Axis	X
Test Mode	UNII-3_TX A Mode 5745 MHz

Vertical

80 dBuV/m

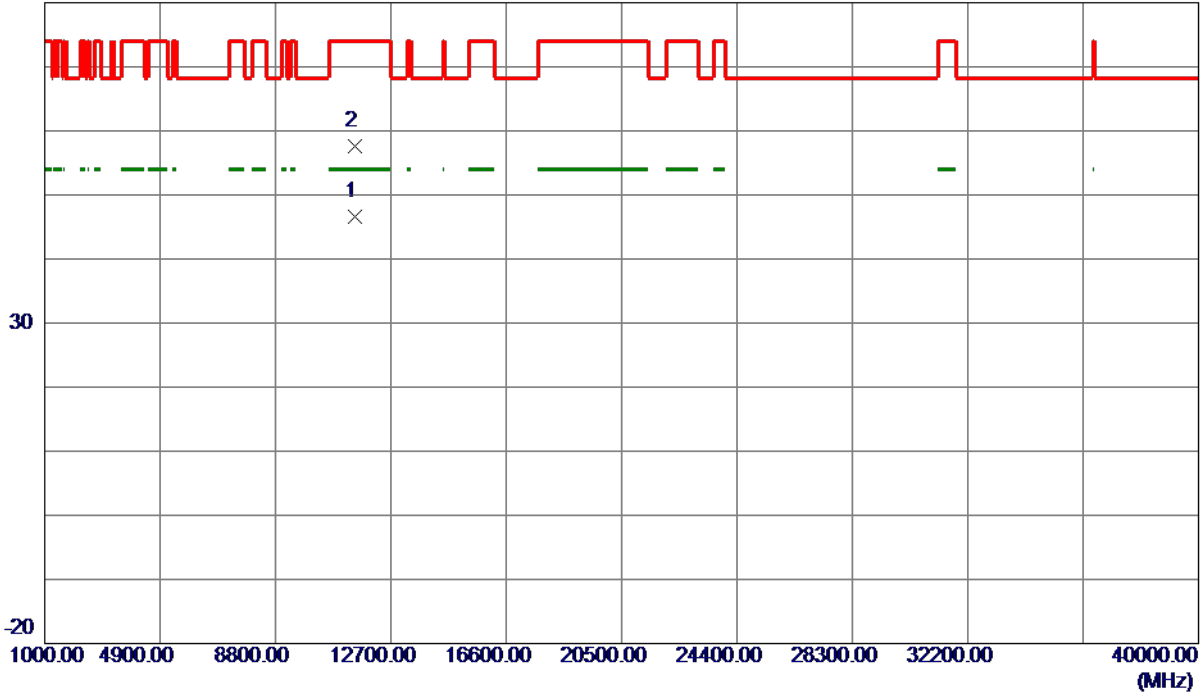

No.	Freq. MHz	Reading Level dBuV/m	Correct Factor dB	Measure ment dBuV/m	Limit dBuV/m	Margin dB	Detector	Comment
1 *	11489.8250	29.67	16.97	46.64	54.00	-7.36	AVG	
2	11490.8750	40.63	16.97	57.60	74.00	-16.40	Peak	

REMARKS:

- (1) Measurement Value = Reading Level + Correct Factor.
- (2) Margin Level = Measurement Value - Limit Value.

Orthogonal Axis	X
Test Mode	UNII-3_TX A Mode 5745 MHz

Horizontal

130 dBuV/m

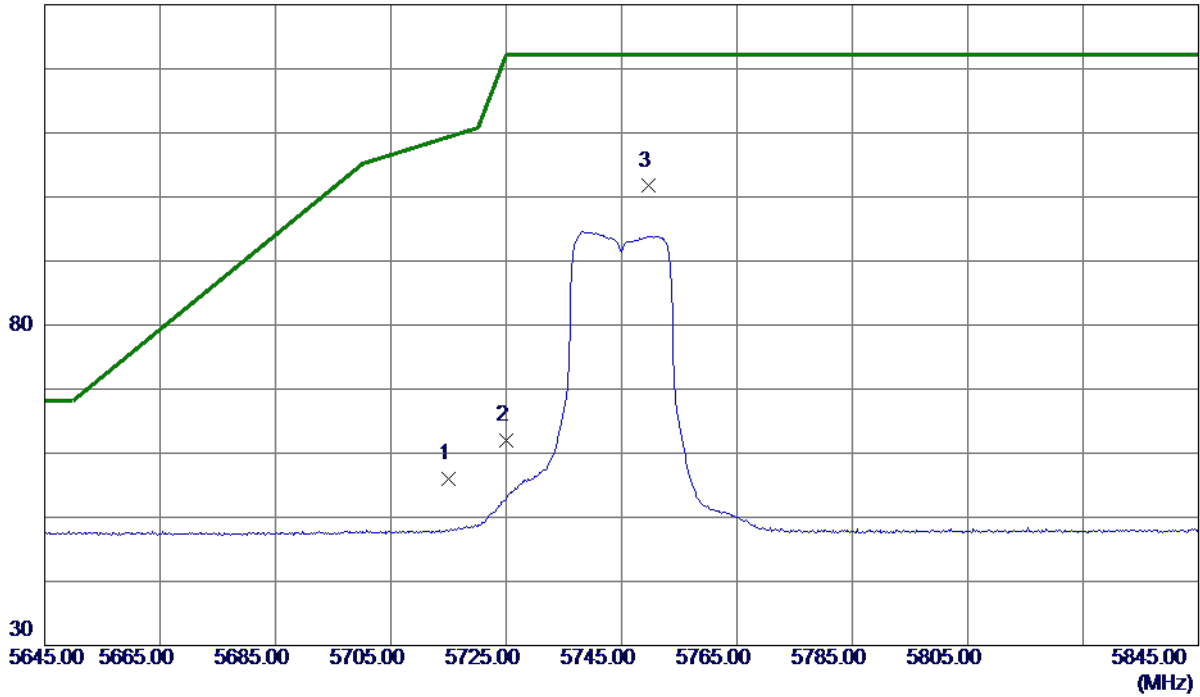

No.	Freq. MHz	Reading Level dBuV/m	Correct Factor dB	Measure ment dBuV/m	Limit dBuV/m	Margin dB	Detector	Comment
1	5715.0000	34.52	21.50	56.02	109.40	-53.38	Peak	
2	5725.0000	40.37	21.55	61.92	122.20	-60.28	Peak	
3 *	5749.6000	80.03	21.67	101.70	122.20	-20.50	Peak	No Limit

REMARKS:

- (1) Measurement Value = Reading Level + Correct Factor.
- (2) Margin Level = Measurement Value - Limit Value.

Orthogonal Axis	X
Test Mode	UNII-3_TX A Mode 5745 MHz

Horizontal

80 dBuV/m

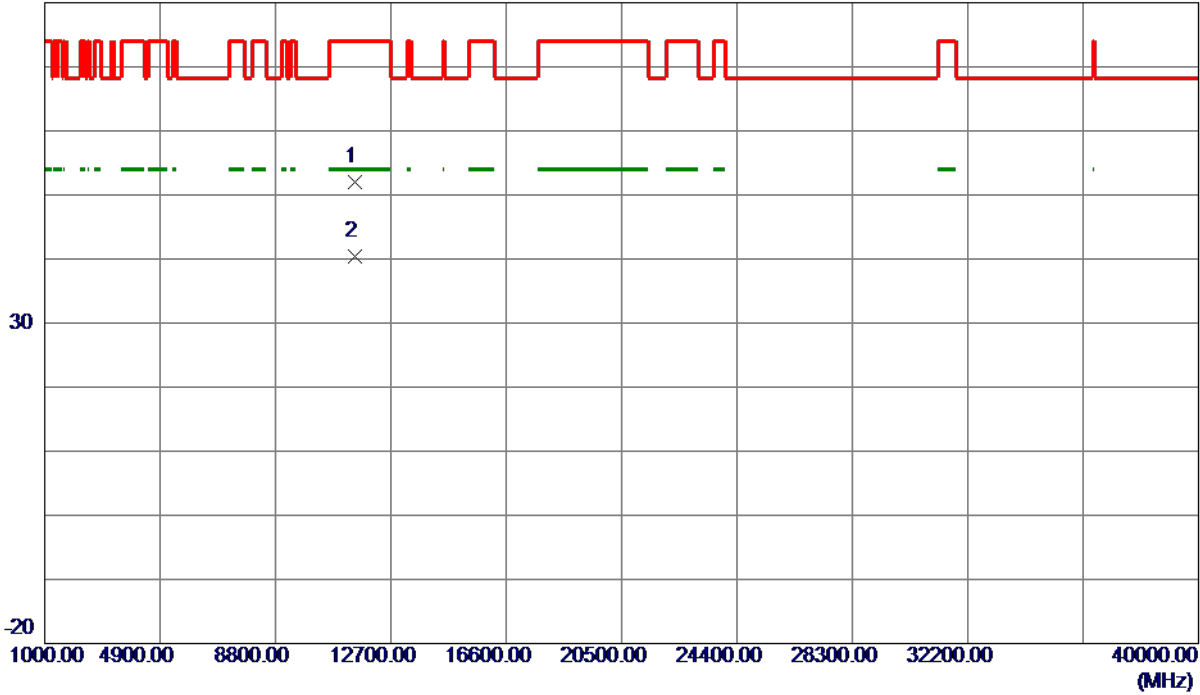

No.	Freq. MHz	Reading Level dBuV/m	Correct Factor dB	Measure ment dBuV/m	Limit dBuV/m	Margin dB	Detector	Comment
1	11489.3000	34.94	16.97	51.91	74.00	-22.09	Peak	
2 *	11489.7000	23.34	16.97	40.31	54.00	-13.69	AVG	

REMARKS:

- (1) Measurement Value = Reading Level + Correct Factor.
- (2) Margin Level = Measurement Value - Limit Value.

Orthogonal Axis	X
Test Mode	UNII-3_TX A Mode 5785 MHz

Vertical

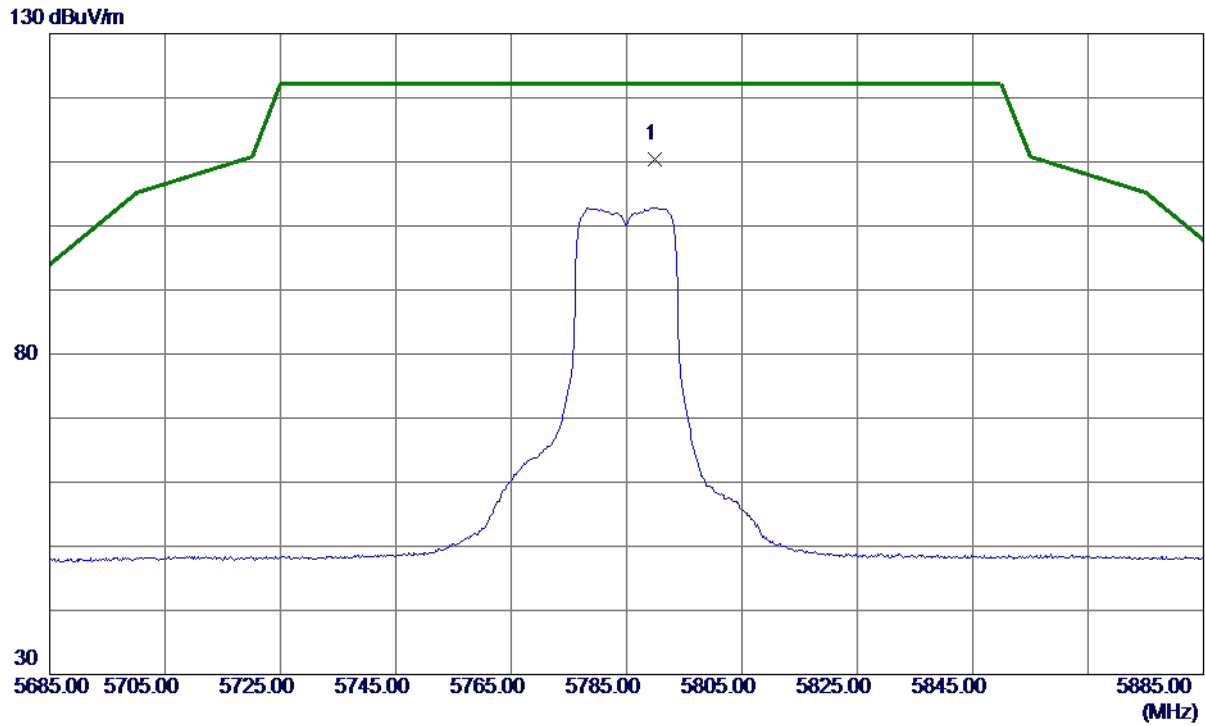

No.	Freq. MHz	Reading Level dBuV/m	Correct Factor dB	Measure ment dBuV/m	Limit dBuV/m	Margin dB	Detector	Comment
1 *	5789.8000	88.53	21.87	110.40	122.20	-11.80	Peak	No Limit

REMARKS:

- (1) Measurement Value = Reading Level + Correct Factor.
- (2) Margin Level = Measurement Value - Limit Value.

Orthogonal Axis	X
Test Mode	UNII-3_TX A Mode 5785 MHz

Vertical

80 dBuV/m

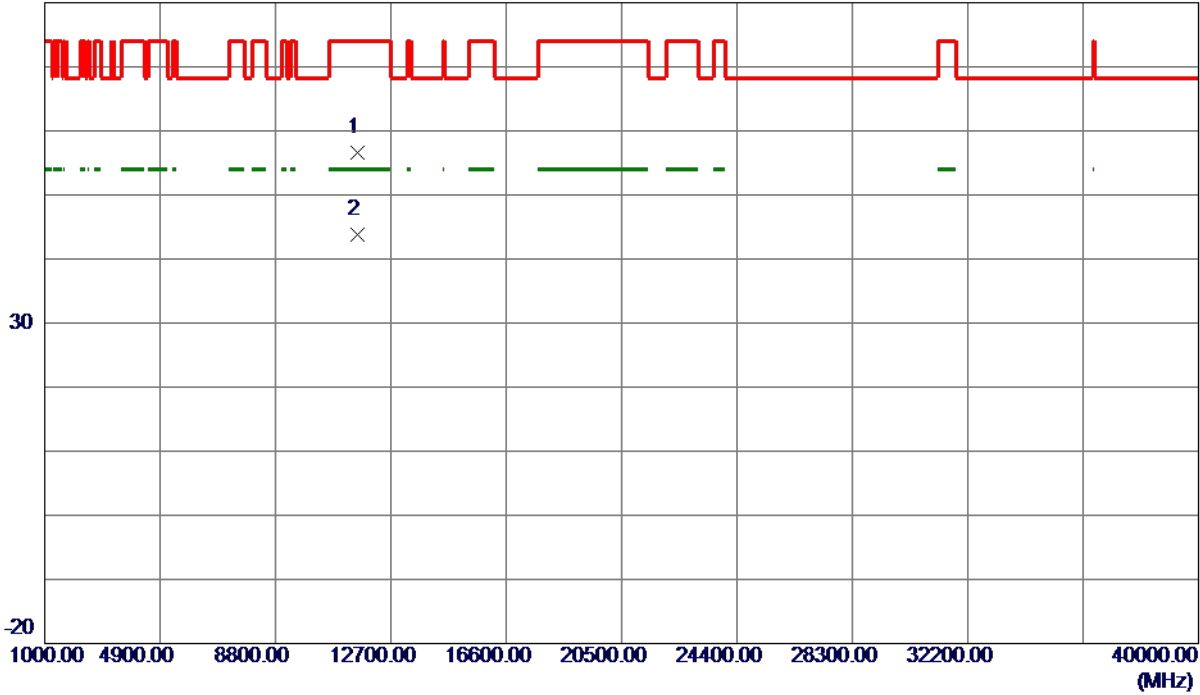

No.	Freq. MHz	Reading Level dBuV/m	Correct Factor dB	Measure ment dBuV/m	Limit dBuV/m	Margin dB	Detector	Comment
1	11569.4500	39.62	16.96	56.58	74.00	-17.42	Peak	
2 *	11569.5500	26.80	16.96	43.76	54.00	-10.24	AVG	

REMARKS:

- (1) Measurement Value = Reading Level + Correct Factor.
- (2) Margin Level = Measurement Value - Limit Value.

Orthogonal Axis	X
Test Mode	UNII-3_TX A Mode 5785 MHz

Horizontal

130 dBuV/m

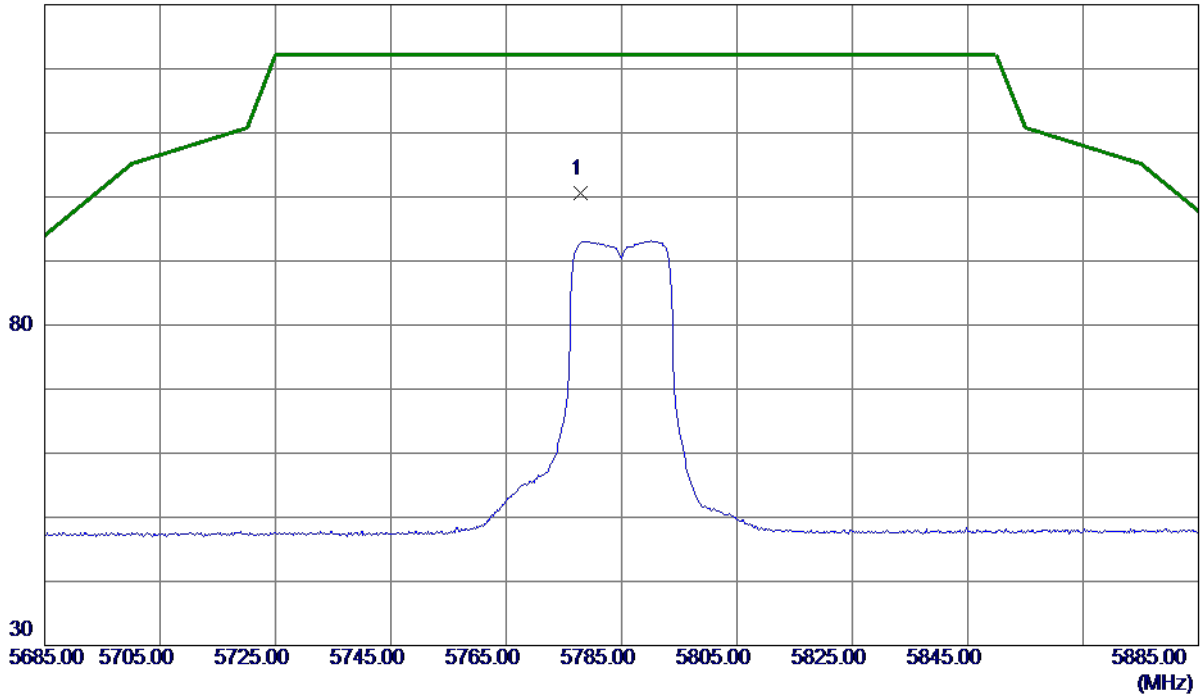

No.	Freq. MHz	Reading Level dBuV/m	Correct Factor dB	Measure ment dBuV/m	Limit dBuV/m	Margin dB	Detector	Comment
1 *	5777.8000	78.69	21.81	100.50	122.20	-21.70	Peak	No Limit

REMARKS:

- (1) Measurement Value = Reading Level + Correct Factor.
- (2) Margin Level = Measurement Value - Limit Value.

Orthogonal Axis	X
Test Mode	UNII-3_TX A Mode 5785 MHz

Horizontal

80 dBuV/m

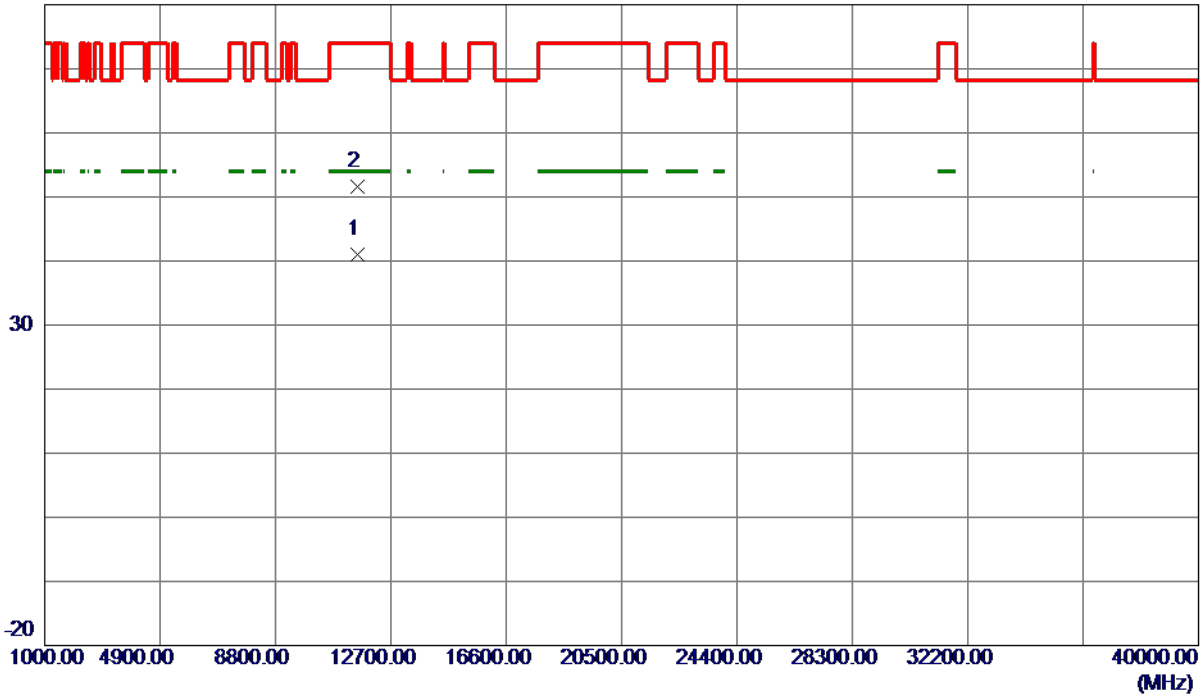

No.	Freq. MHz	Reading Level dBuV/m	Correct Factor dB	Measure ment dBuV/m	Limit dBuV/m	Margin dB	Detector	Comment
1 *	11569.5500	24.00	16.96	40.96	54.00	-13.04	AVG	
2	11572.6250	34.71	16.96	51.67	74.00	-22.33	Peak	

REMARKS:

- (1) Measurement Value = Reading Level + Correct Factor.
- (2) Margin Level = Measurement Value - Limit Value.

Orthogonal Axis	X
Test Mode	UNII-3_TX A Mode 5825 MHz

Vertical

130 dBuV/m

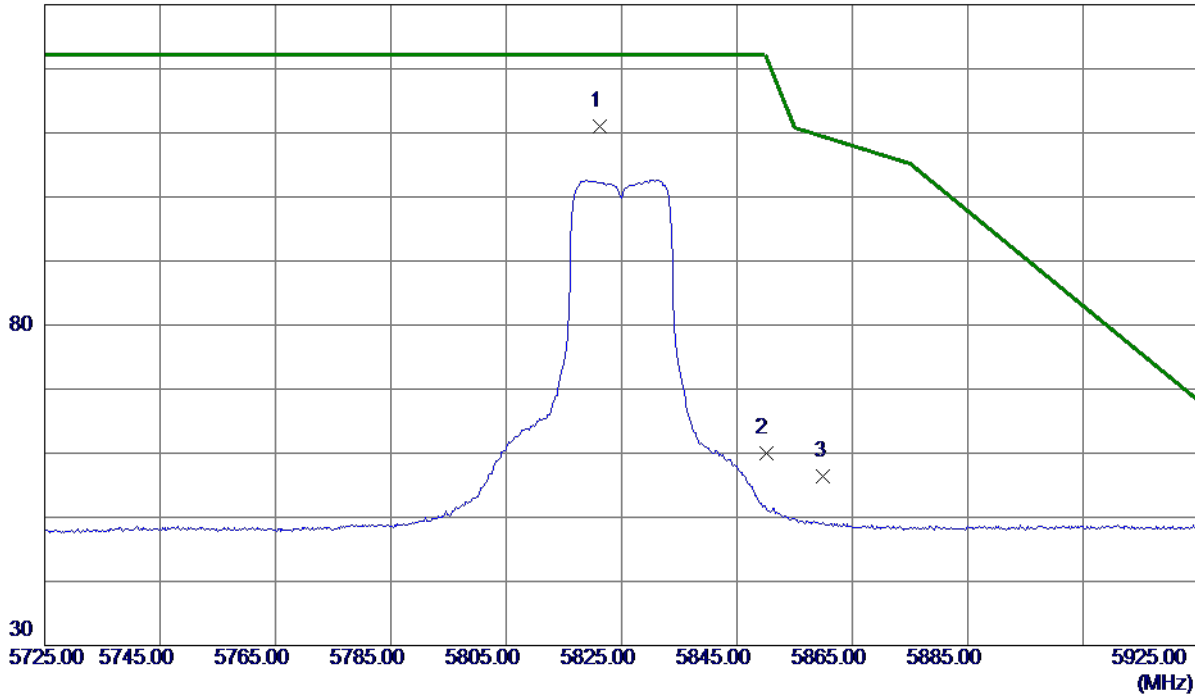

No.	Freq. MHz	Reading Level dBuV/m	Correct Factor dB	Measure ment dBuV/m	Limit dBuV/m	Margin dB	Detector	Comment
1 *	5821.2000	89.05	22.02	111.07	122.20	-11.13	Peak	No Limit
2	5850.0000	37.75	22.16	59.91	122.20	-62.29	Peak	
3	5860.0000	34.16	22.21	56.37	109.40	-53.03	Peak	

REMARKS:

- (1) Measurement Value = Reading Level + Correct Factor.
- (2) Margin Level = Measurement Value - Limit Value.

Orthogonal Axis	X
Test Mode	UNII-3_TX A Mode 5825 MHz

Vertical

80 dBuV/m

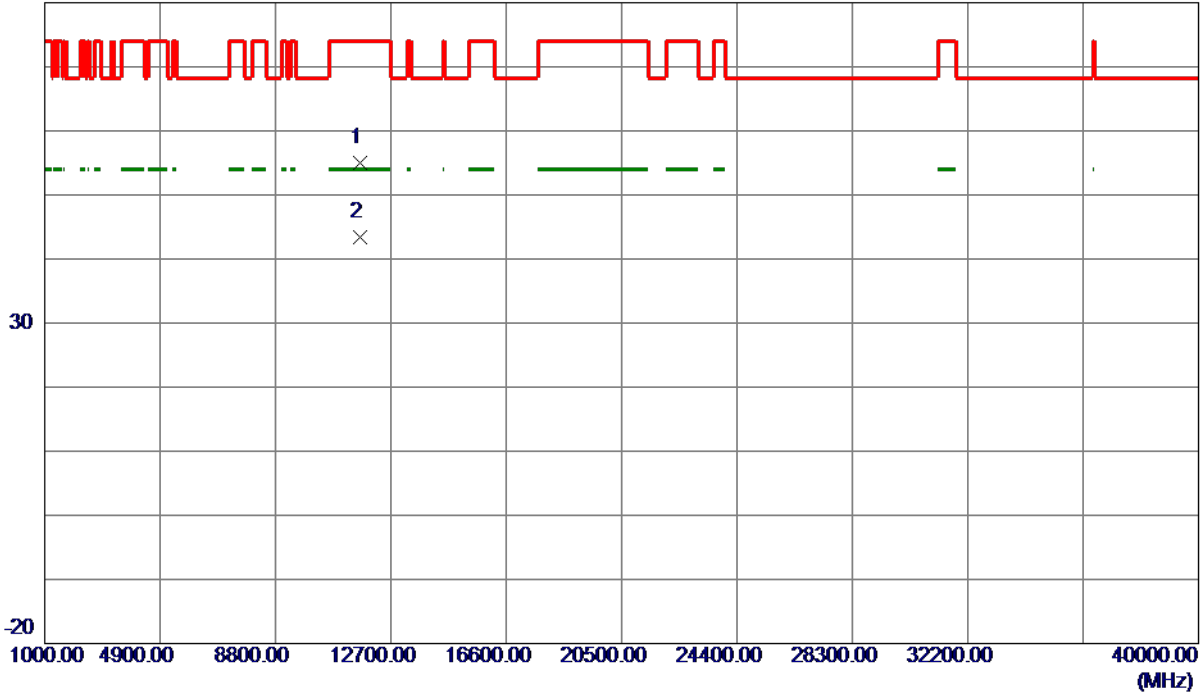

No.	Freq. MHz	Reading Level dBuV/m	Correct Factor dB	Measure ment dBuV/m	Limit dBuV/m	Margin dB	Detector	Comment
1	11649.1750	37.99	16.94	54.93	74.00	-19.07	Peak	
2 *	11649.8500	26.46	16.94	43.40	54.00	-10.60	AVG	

REMARKS:

- (1) Measurement Value = Reading Level + Correct Factor.
- (2) Margin Level = Measurement Value - Limit Value.

Orthogonal Axis	X
Test Mode	UNII-3_TX A Mode 5825 MHz

Horizontal

130 dBuV/m

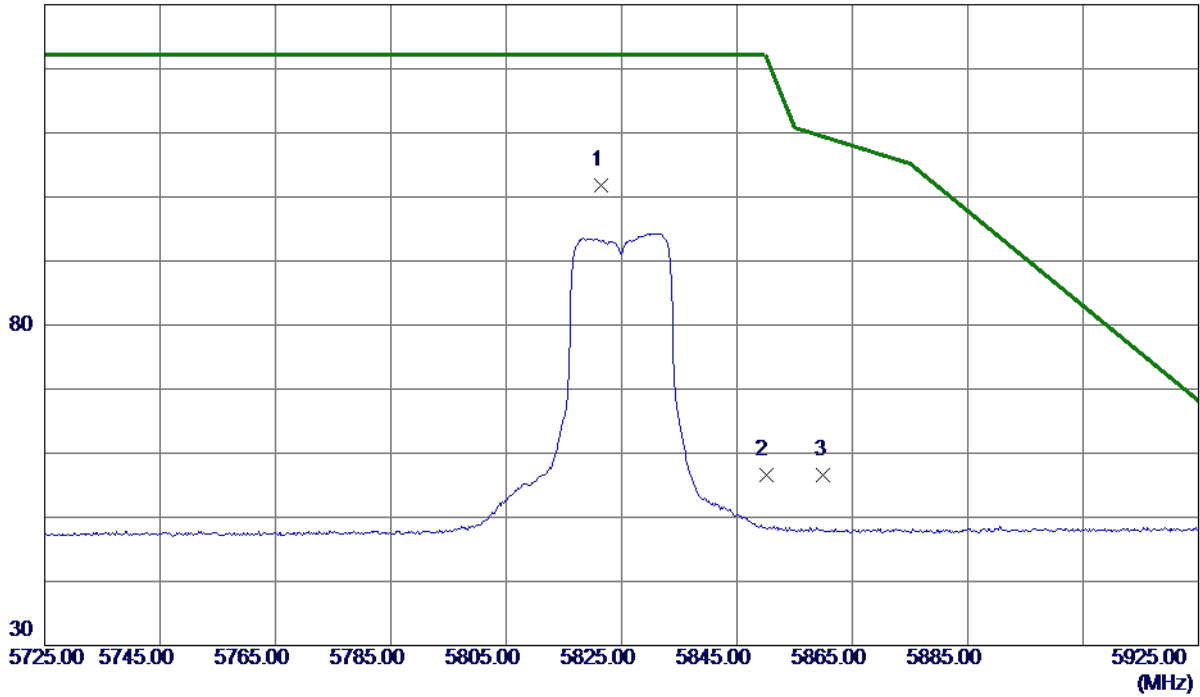

No.	Freq. MHz	Reading Level dBuV/m	Correct Factor dB	Measure ment dBuV/m	Limit dBuV/m	Margin dB	Detector	Comment
1 *	5821.4000	79.82	22.02	101.84	122.20	-20.36	Peak	No Limit
2	5850.0000	34.46	22.16	56.62	122.20	-65.58	Peak	
3	5860.0000	34.37	22.21	56.58	109.40	-52.82	Peak	

REMARKS:

- (1) Measurement Value = Reading Level + Correct Factor.
- (2) Margin Level = Measurement Value - Limit Value.

Orthogonal Axis	X
Test Mode	UNII-3_TX A Mode 5825 MHz

Horizontal

80 dBuV/m

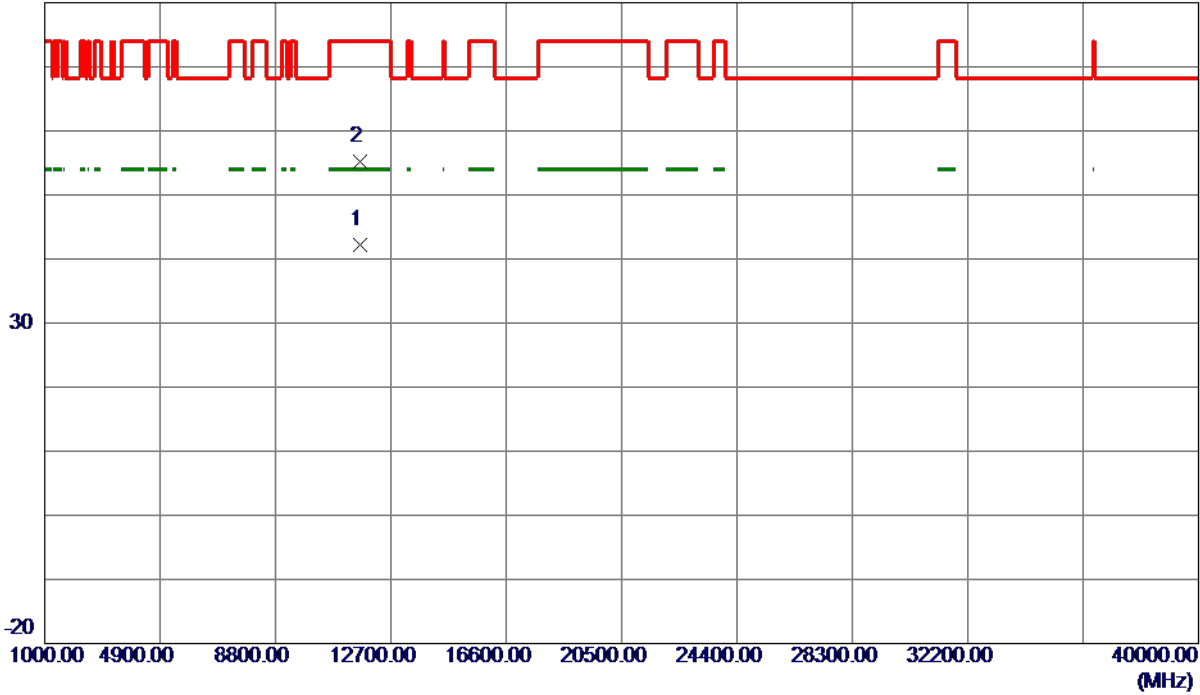

No.	Freq. MHz	Reading Level dBuV/m	Correct Factor dB	Measure ment dBuV/m	Limit dBuV/m	Margin dB	Detector	Comment
1 *	11649.7000	25.34	16.94	42.28	54.00	-11.72	AVG	
2	11650.7750	38.27	16.94	55.21	74.00	-18.79	Peak	

REMARKS:

- (1) Measurement Value = Reading Level + Correct Factor.
- (2) Margin Level = Measurement Value - Limit Value.

Orthogonal Axis	X
Test Mode	UNII-3_TX N (HT20) Mode 5745 MHz

Vertical

130 dBuV/m

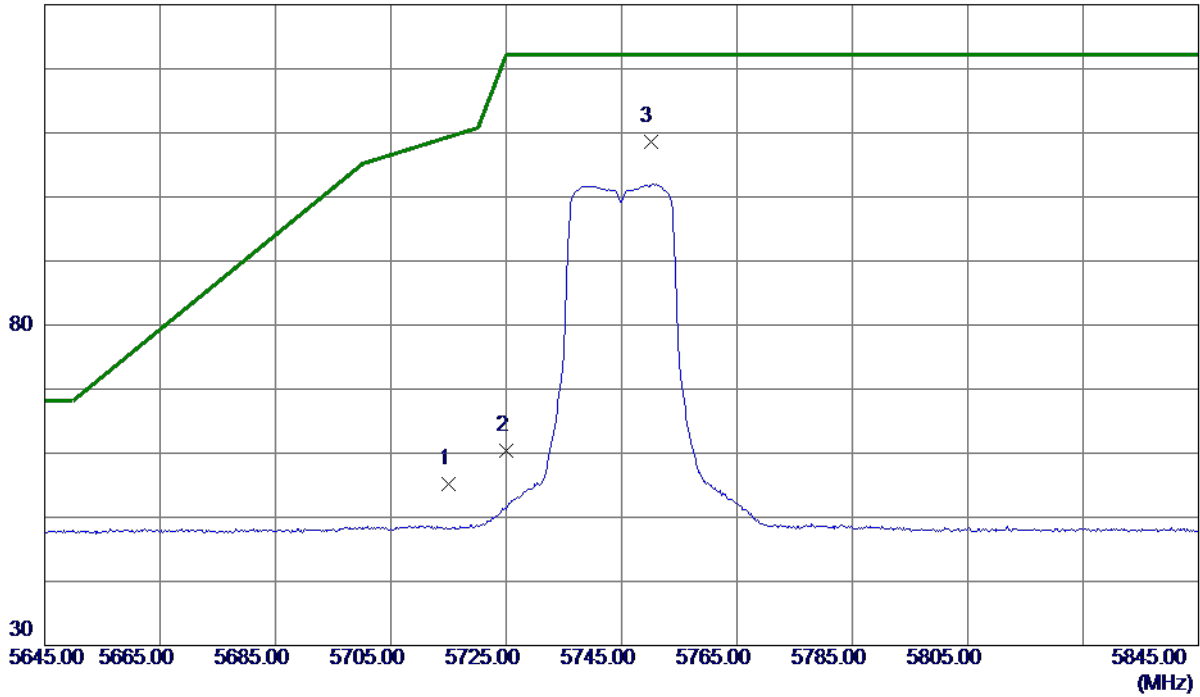

No.	Freq. MHz	Reading Level dBuV/m	Correct Factor dB	Measure ment dBuV/m	Limit dBuV/m	Margin dB	Detector	Comment
1	5715.0000	33.74	21.50	55.24	109.40	-54.16	Peak	
2	5725.0000	38.89	21.55	60.44	122.20	-61.76	Peak	
3 *	5750.0000	86.95	21.67	108.62	122.20	-13.58	Peak	No Limit

REMARKS:

- (1) Measurement Value = Reading Level + Correct Factor.
- (2) Margin Level = Measurement Value - Limit Value.

Orthogonal Axis	X
Test Mode	UNII-3_TX N (HT20) Mode 5745 MHz

Vertical

80 dBuV/m

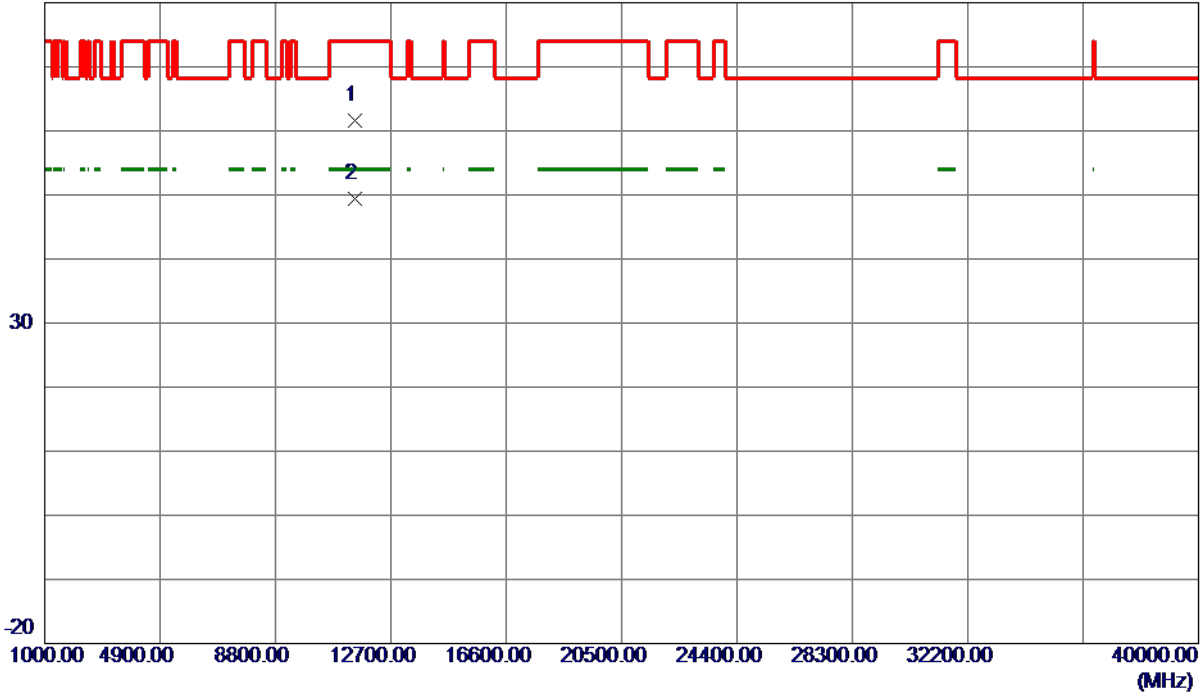

No.	Freq. MHz	Reading Level dBuV/m	Correct Factor dB	Measure ment dBuV/m	Limit dBuV/m	Margin dB	Detector	Comment
1	11483.8750	44.68	16.97	61.65	74.00	-12.35	Peak	
2 *	11490.6000	32.41	16.97	49.38	54.00	-4.62	AVG	

REMARKS:

- (1) Measurement Value = Reading Level + Correct Factor.
- (2) Margin Level = Measurement Value - Limit Value.

Orthogonal Axis	X
Test Mode	UNII-3_TX N (HT20) Mode 5745 MHz

Horizontal

130 dBuV/m

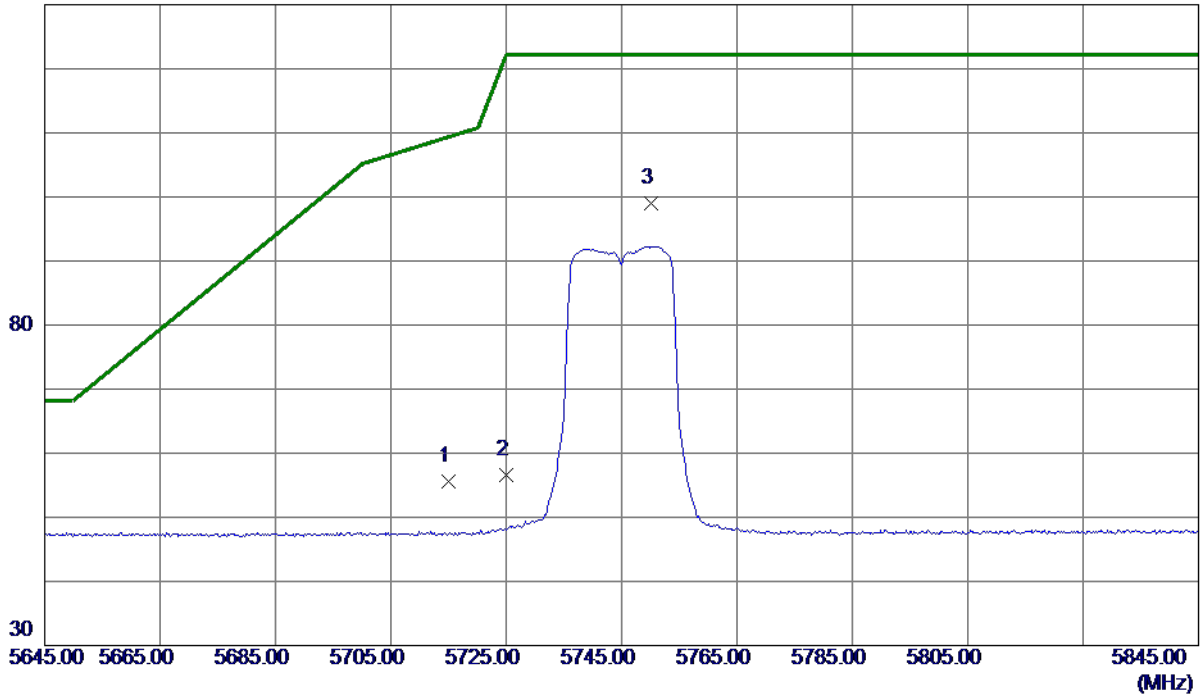

No.	Freq. MHz	Reading Level dBuV/m	Correct Factor dB	Measure ment dBuV/m	Limit dBuV/m	Margin dB	Detector	Comment
1	5715.0000	34.19	21.50	55.69	109.40	-53.71	Peak	
2	5725.0000	35.08	21.55	56.63	122.20	-65.57	Peak	
3 *	5750.2000	77.33	21.67	99.00	122.20	-23.20	Peak	No Limit

REMARKS:

- (1) Measurement Value = Reading Level + Correct Factor.
- (2) Margin Level = Measurement Value - Limit Value.

Orthogonal Axis	X
Test Mode	UNII-3_TX N (HT20) Mode 5745 MHz

Horizontal

80 dBuV/m

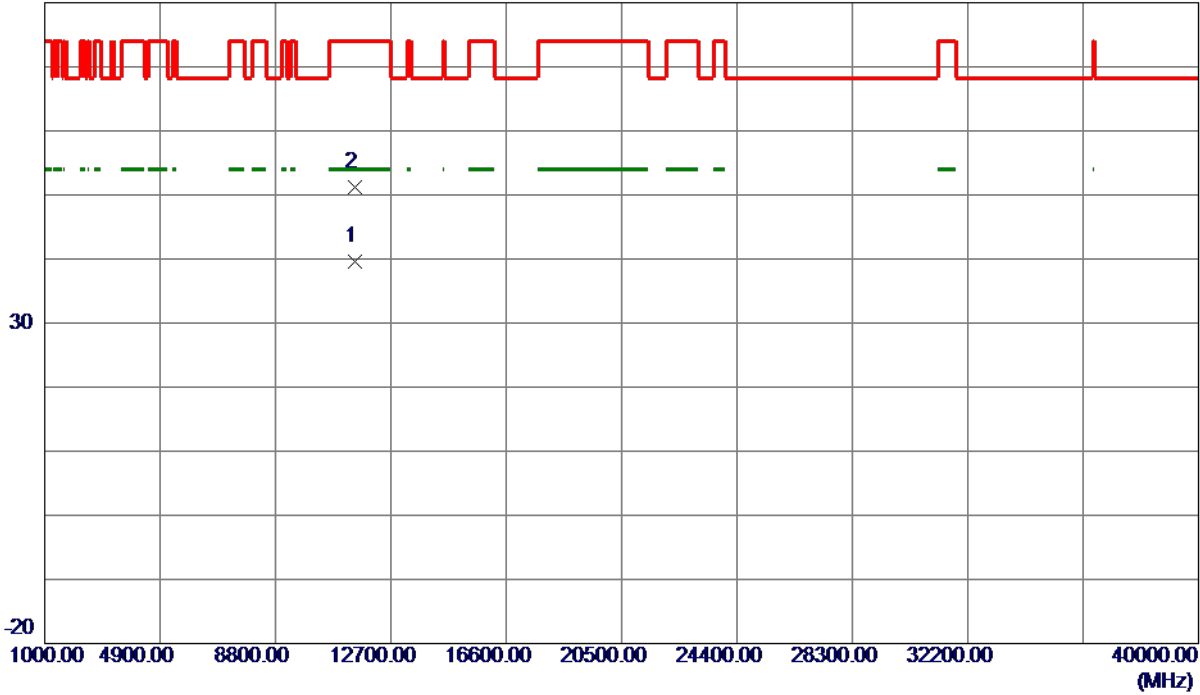

No.	Freq. MHz	Reading Level dBuV/m	Correct Factor dB	Measure ment dBuV/m	Limit dBuV/m	Margin dB	Detector	Comment
1 *	11488.7000	22.68	16.97	39.65	54.00	-14.35	AVG	
2	11489.6000	34.20	16.97	51.17	74.00	-22.83	Peak	

REMARKS:

- (1) Measurement Value = Reading Level + Correct Factor.
- (2) Margin Level = Measurement Value - Limit Value.

Orthogonal Axis	X
Test Mode	UNII-3_TX N (HT20) Mode 5785 MHz

Vertical

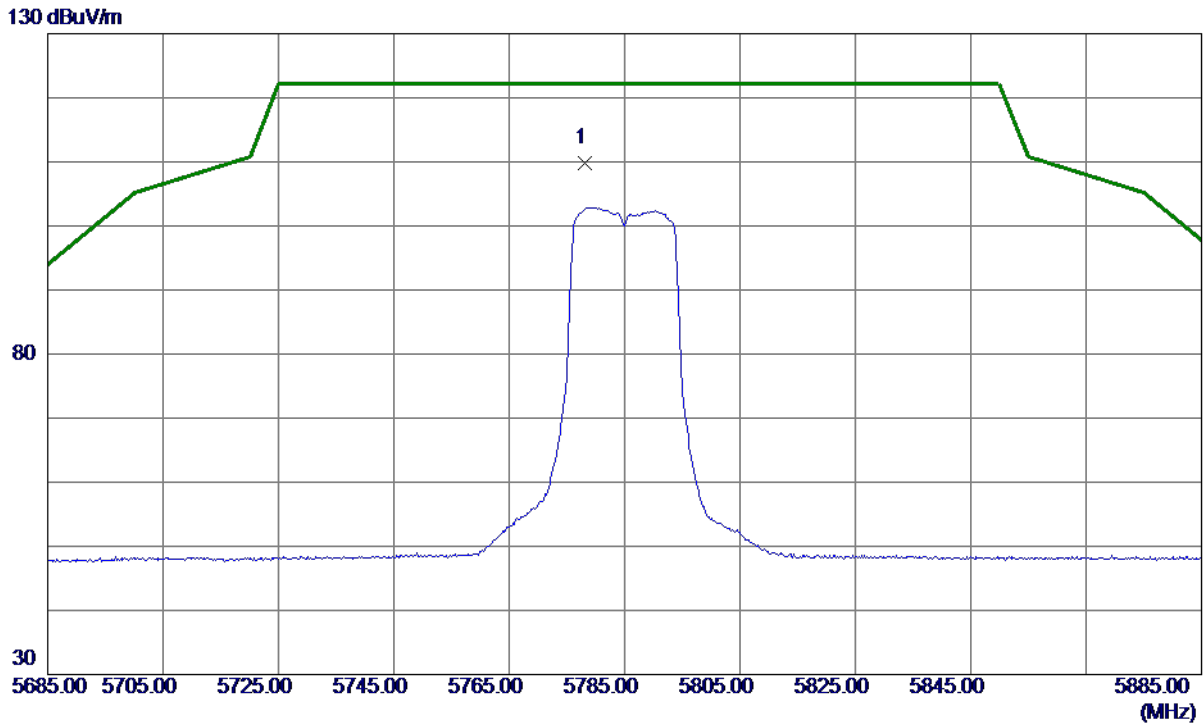

No.	Freq. MHz	Reading Level dBuV/m	Correct Factor dB	Measure ment dBuV/m	Limit dBuV/m	Margin dB	Detector	Comment
1 *	5778.2000	87.97	21.81	109.78	122.20	-12.42	Peak	No Limit

REMARKS:

- (1) Measurement Value = Reading Level + Correct Factor.
- (2) Margin Level = Measurement Value - Limit Value.

Orthogonal Axis	X
Test Mode	UNII-3_TX N (HT20) Mode 5785 MHz

Vertical

80 dBuV/m

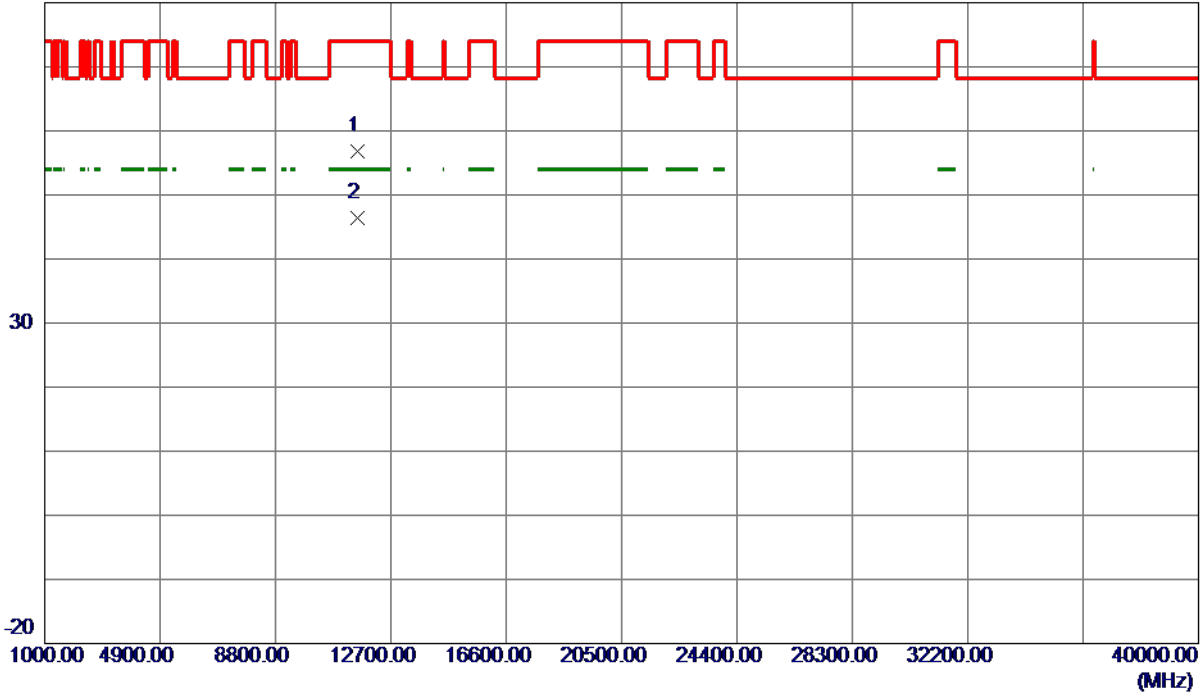

No.	Freq. MHz	Reading Level dBuV/m	Correct Factor dB	Measure ment dBuV/m	Limit dBuV/m	Margin dB	Detector	Comment
1	11570.3500	39.81	16.96	56.77	74.00	-17.23	Peak	
2 *	11570.7500	29.44	16.96	46.40	54.00	-7.60	AVG	

REMARKS:

- (1) Measurement Value = Reading Level + Correct Factor.
- (2) Margin Level = Measurement Value - Limit Value.

Orthogonal Axis	X
Test Mode	UNII-3_TX N (HT20) Mode 5785 MHz

Horizontal

130 dBuV/m

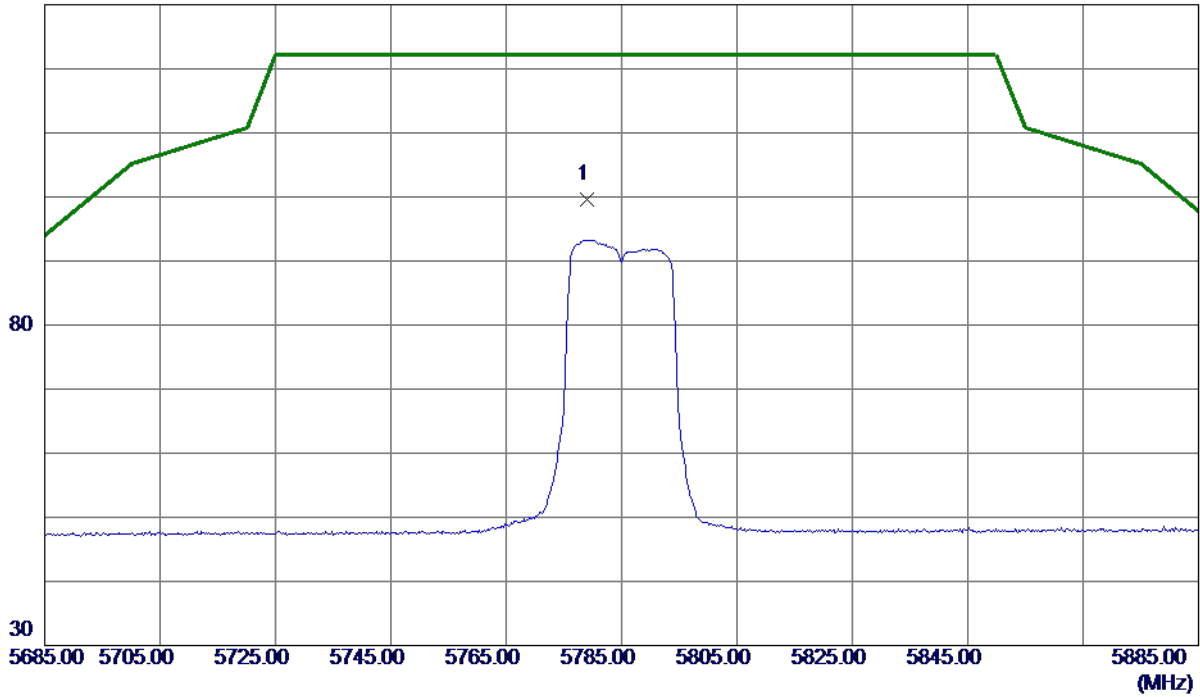

No.	Freq. MHz	Reading Level dBuV/m	Correct Factor dB	Measure ment dBuV/m	Limit dBuV/m	Margin dB	Detector	Comment
1 *	5779.0000	77.78	21.81	99.59	122.20	-22.61	Peak	No Limit

REMARKS:

- (1) Measurement Value = Reading Level + Correct Factor.
- (2) Margin Level = Measurement Value - Limit Value.

Orthogonal Axis	X
Test Mode	UNII-3_TX N (HT20) Mode 5785 MHz

Horizontal

80 dBuV/m

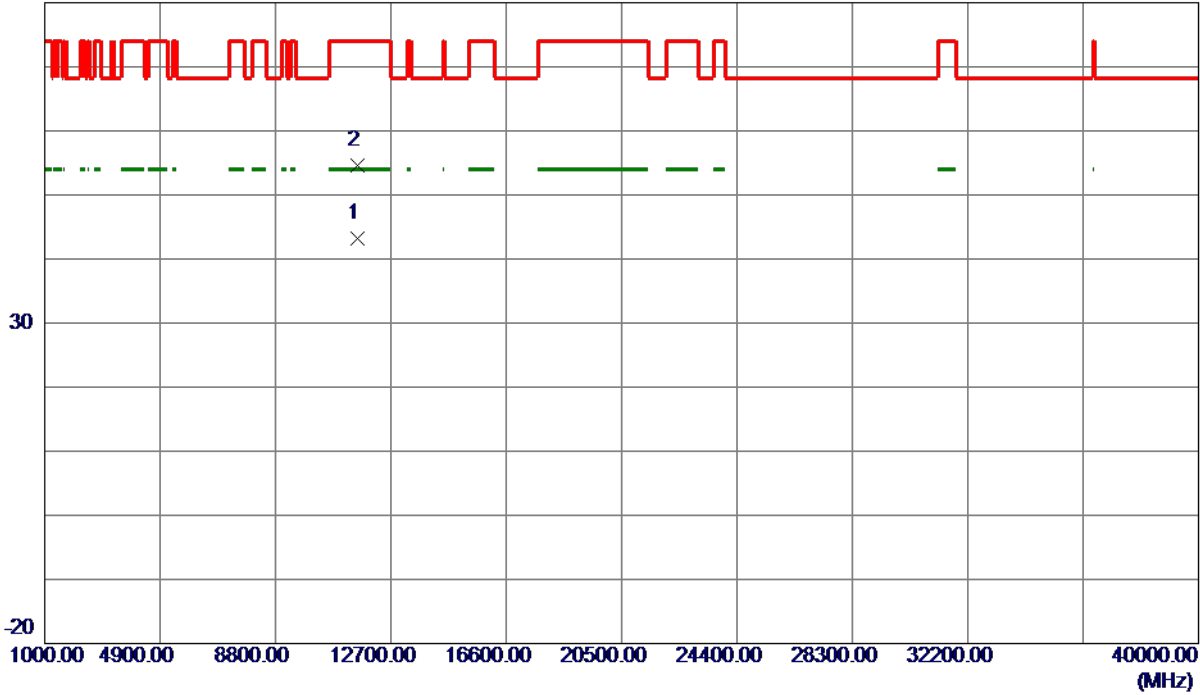

No.	Freq. MHz	Reading Level dBuV/m	Correct Factor dB	Measure ment dBuV/m	Limit dBuV/m	Margin dB	Detector	Comment
1 *	11570.2500	26.17	16.96	43.13	54.00	-10.87	AVG	
2	11573.7500	37.60	16.96	54.56	74.00	-19.44	Peak	

REMARKS:

- (1) Measurement Value = Reading Level + Correct Factor.
- (2) Margin Level = Measurement Value - Limit Value.

Orthogonal Axis	X
Test Mode	UNII-3_TX N (HT20) Mode 5825 MHz

Vertical

130 dBuV/m

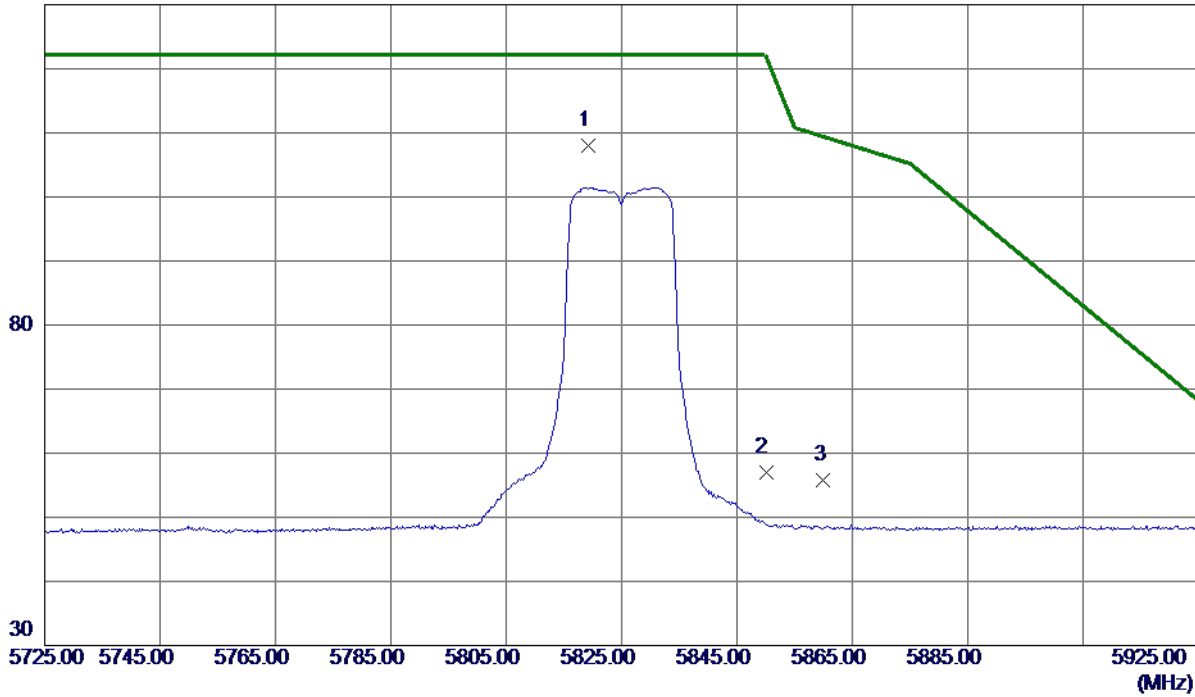

No.	Freq. MHz	Reading Level dBuV/m	Correct Factor dB	Measure ment dBuV/m	Limit dBuV/m	Margin dB	Detector	Comment
1 *	5819.2000	86.05	22.01	108.06	122.20	-14.14	Peak	No Limit
2	5850.0000	34.89	22.16	57.05	122.20	-65.15	Peak	
3	5860.0000	33.63	22.21	55.84	109.40	-53.56	Peak	

REMARKS:

- (1) Measurement Value = Reading Level + Correct Factor.
- (2) Margin Level = Measurement Value - Limit Value.

Orthogonal Axis	X
Test Mode	UNII-3_TX N (HT20) Mode 5825 MHz

Vertical

80 dBuV/m

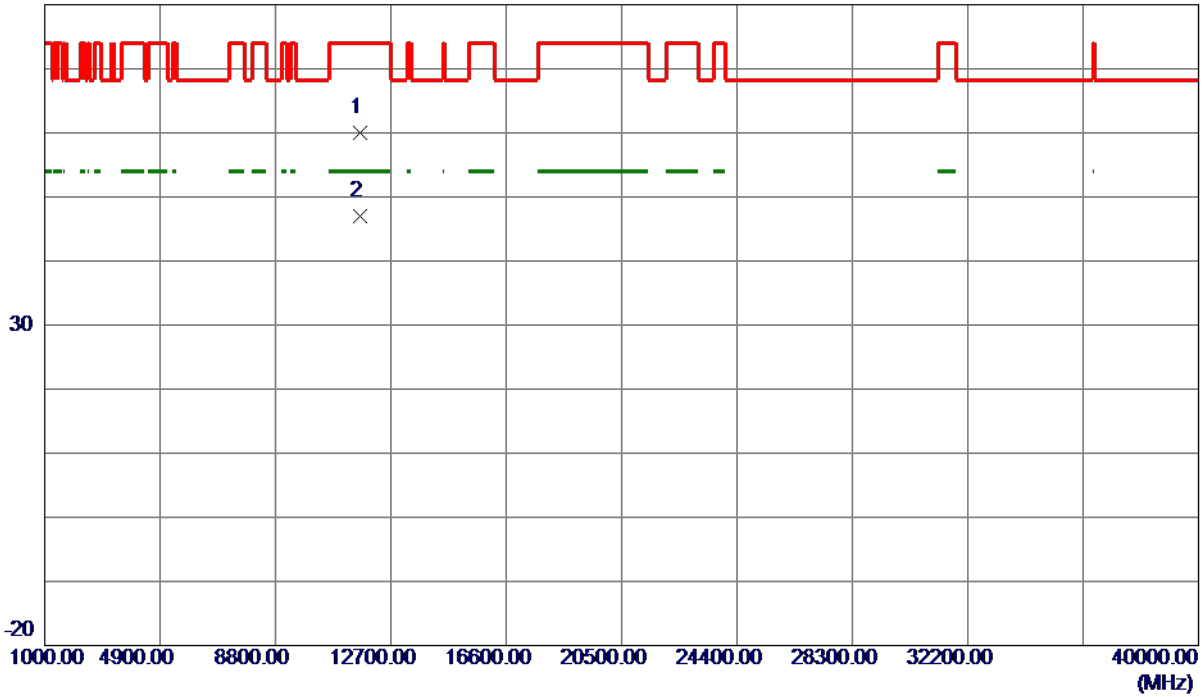

No.	Freq. MHz	Reading Level dBuV/m	Correct Factor dB	Measure ment dBuV/m	Limit dBuV/m	Margin dB	Detector	Comment
1	11644.6000	43.08	16.94	60.02	74.00	-13.98	Peak	
2 *	11650.6750	30.12	16.94	47.06	54.00	-6.94	AVG	

REMARKS:

- (1) Measurement Value = Reading Level + Correct Factor.
- (2) Margin Level = Measurement Value - Limit Value.

Orthogonal Axis	X
Test Mode	UNII-3_TX N (HT20) Mode 5825 MHz

Horizontal

130 dBuV/m

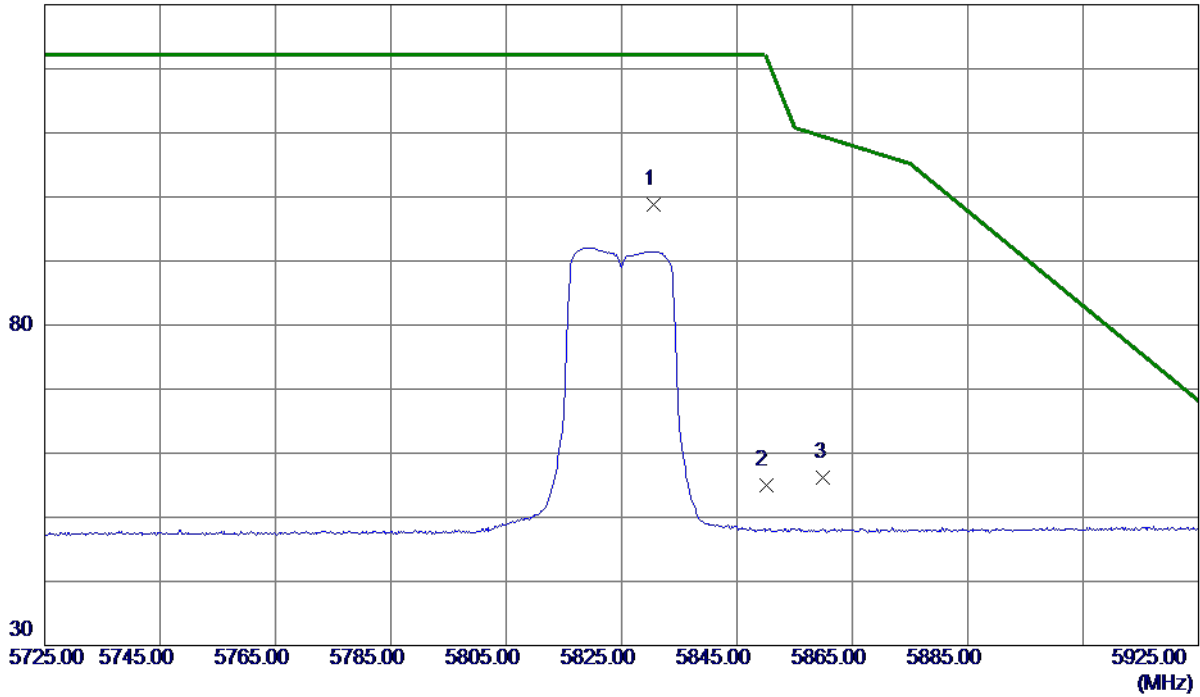

No.	Freq. MHz	Reading Level dBuV/m	Correct Factor dB	Measure ment dBuV/m	Limit dBuV/m	Margin dB	Detector	Comment
1 *	5830.6000	76.69	22.07	98.76	122.20	-23.44	Peak	No Limit
2	5850.0000	32.88	22.16	55.04	122.20	-67.16	Peak	
3	5860.0000	33.91	22.21	56.12	109.40	-53.28	Peak	

REMARKS:

- (1) Measurement Value = Reading Level + Correct Factor.
- (2) Margin Level = Measurement Value - Limit Value.

Orthogonal Axis	X
Test Mode	UNII-3_TX N (HT20) Mode 5825 MHz

Horizontal

80 dBuV/m

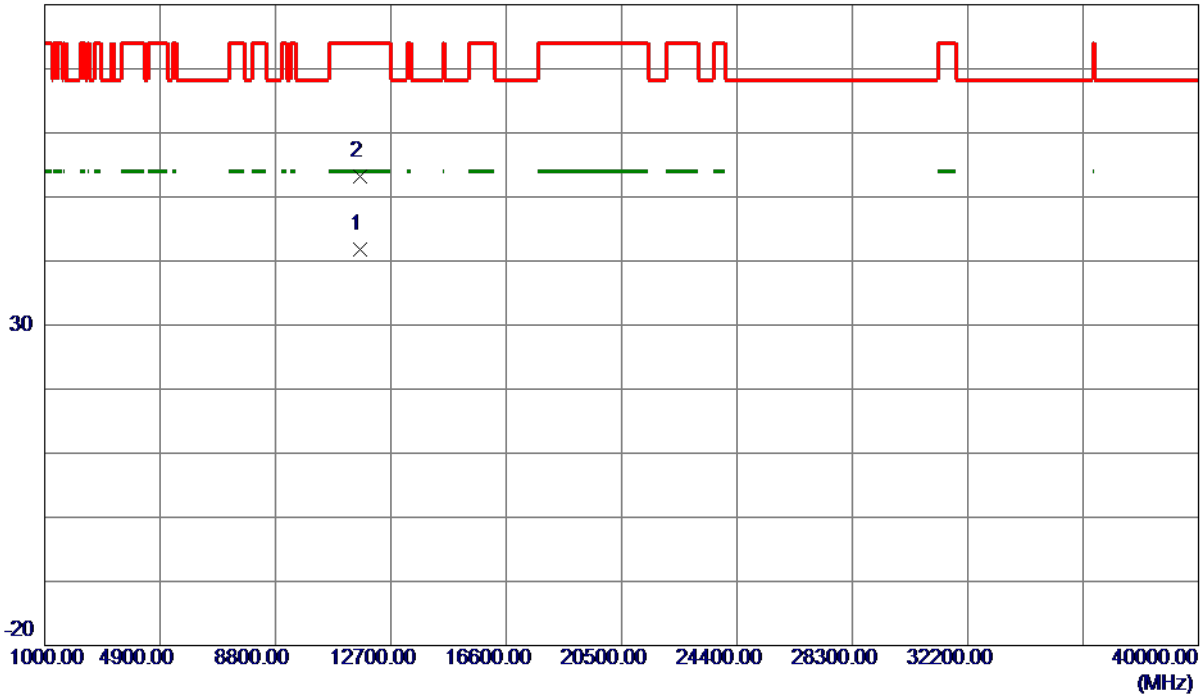

No.	Freq. MHz	Reading Level dBuV/m	Correct Factor dB	Measure ment dBuV/m	Limit dBuV/m	Margin dB	Detector	Comment
1 *	11650.7250	24.88	16.94	41.82	54.00	-12.18	AVG	
2	11653.4750	36.26	16.94	53.20	74.00	-20.80	Peak	

REMARKS:

- (1) Measurement Value = Reading Level + Correct Factor.
- (2) Margin Level = Measurement Value - Limit Value.

Orthogonal Axis	X
Test Mode	UNII-3_TX N (HT40) Mode 5755 MHz

Vertical

130 dBuV/m

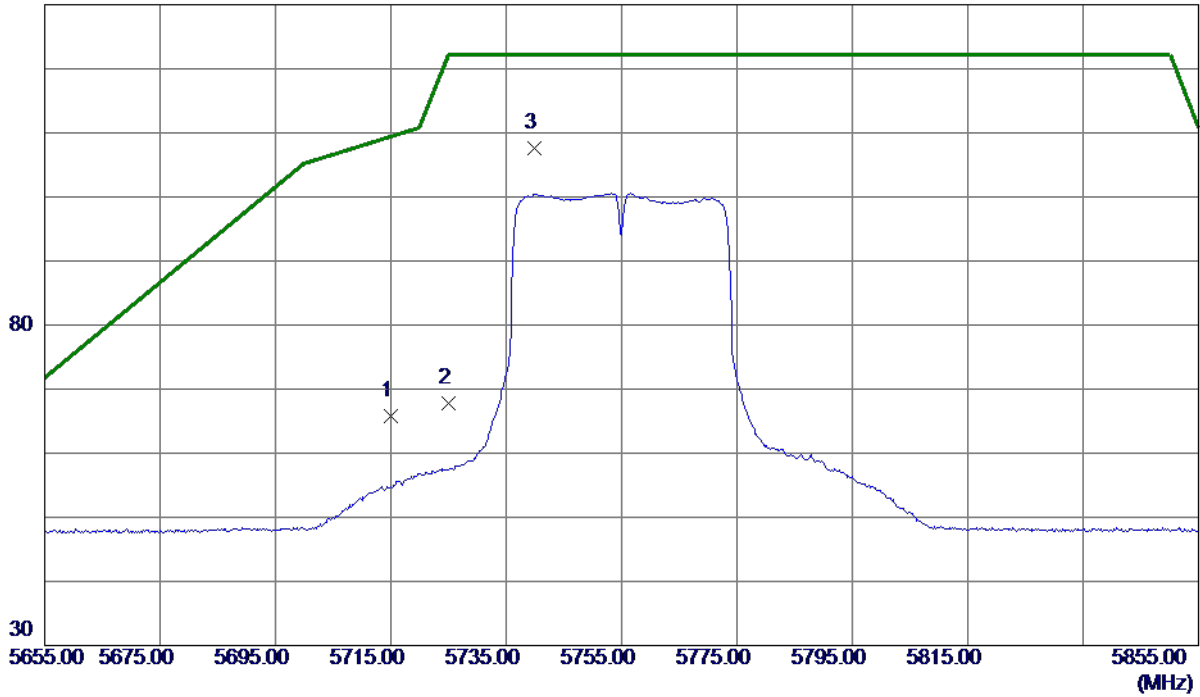

No.	Freq. MHz	Reading Level dBuV/m	Correct Factor dB	Measure ment dBuV/m	Limit dBuV/m	Margin dB	Detector	Comment
1	5715.0000	44.37	21.50	65.87	109.40	-43.53	Peak	
2	5725.0000	46.29	21.55	67.84	122.20	-54.36	Peak	
3 *	5739.8000	86.00	21.62	107.62	122.20	-14.58	Peak	No Limit

REMARKS:

- (1) Measurement Value = Reading Level + Correct Factor.
- (2) Margin Level = Measurement Value - Limit Value.

Orthogonal Axis	X
Test Mode	UNII-3_TX N (HT40) Mode 5755 MHz

Vertical

80 dBuV/m

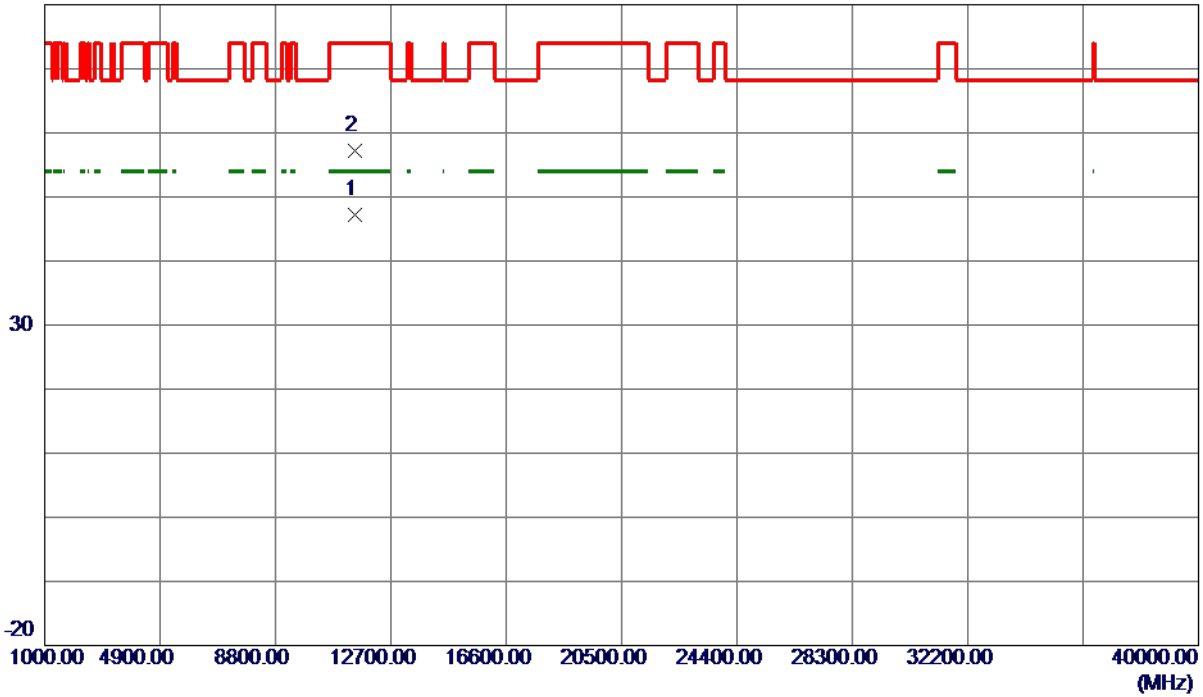

No.	Freq. MHz	Reading Level dBuV/m	Correct Factor dB	Measure ment dBuV/m	Limit dBuV/m	Margin dB	Detector	Comment
1 *	11503.6750	30.20	16.98	47.18	54.00	-6.82	AVG	
2	11506.3500	40.31	16.98	57.29	74.00	-16.71	Peak	

REMARKS:

- (1) Measurement Value = Reading Level + Correct Factor.
- (2) Margin Level = Measurement Value - Limit Value.

Orthogonal Axis	X
Test Mode	UNII-3_TX N (HT40) Mode 5755 MHz

Horizontal

130 dBuV/m

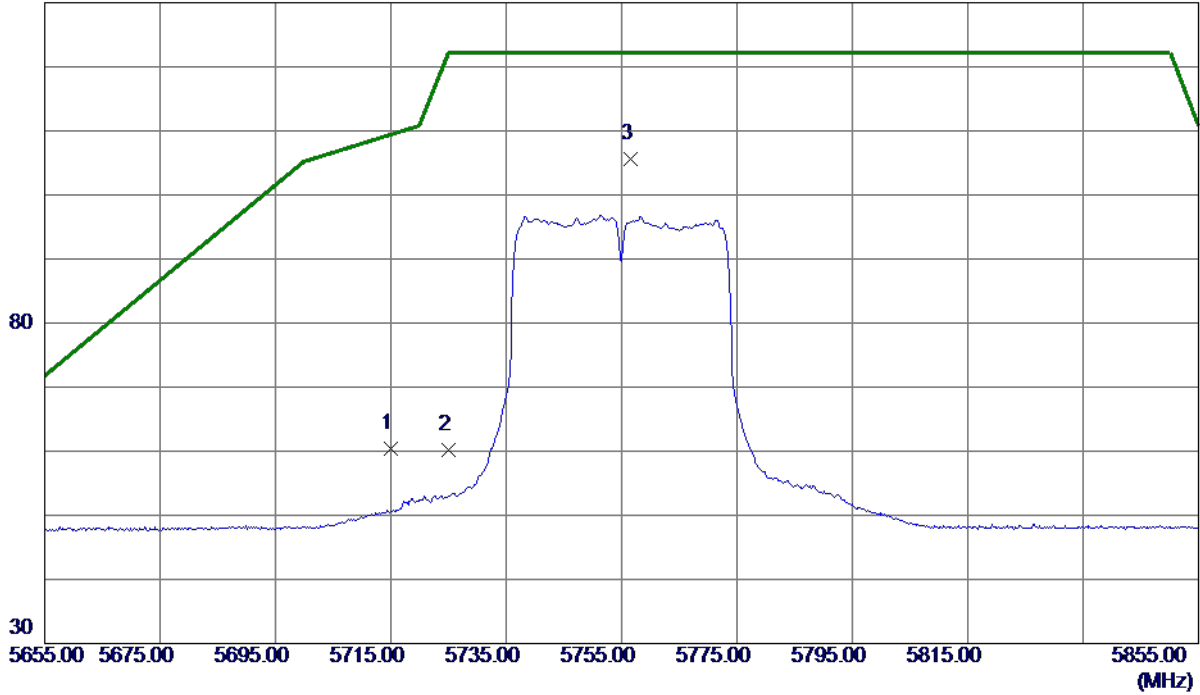

No.	Freq. MHz	Reading Level dBuV/m	Correct Factor dB	Measure ment dBuV/m	Limit dBuV/m	Margin dB	Detector	Comment
1	5715.0000	38.95	21.50	60.45	109.40	-48.95	Peak	
2	5725.0000	38.68	21.55	60.23	122.20	-61.97	Peak	
3 *	5756.6000	83.91	21.70	105.61	122.20	-16.59	Peak	No Limit

REMARKS:

- (1) Measurement Value = Reading Level + Correct Factor.
- (2) Margin Level = Measurement Value - Limit Value.

Orthogonal Axis	X
Test Mode	UNII-3_TX N (HT40) Mode 5755 MHz

Horizontal

80 dBuV/m

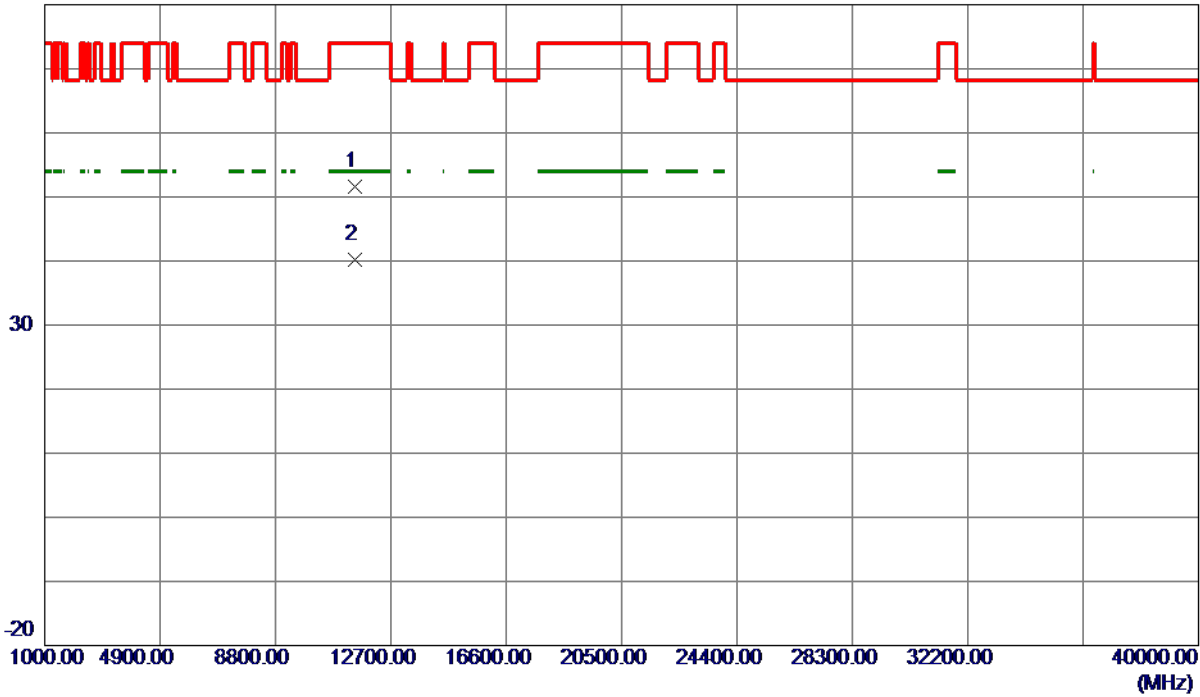

No.	Freq. MHz	Reading Level dBuV/m	Correct Factor dB	Measure ment dBuV/m	Limit dBuV/m	Margin dB	Detector	Comment
1	11503.0500	34.61	16.98	51.59	74.00	-22.41	Peak	
2 *	11506.6500	23.23	16.98	40.21	54.00	-13.79	AVG	

REMARKS:

- (1) Measurement Value = Reading Level + Correct Factor.
- (2) Margin Level = Measurement Value - Limit Value.

Orthogonal Axis	X
Test Mode	UNII-3_TX N (HT40) Mode 5795 MHz

Vertical

130 dBuV/m

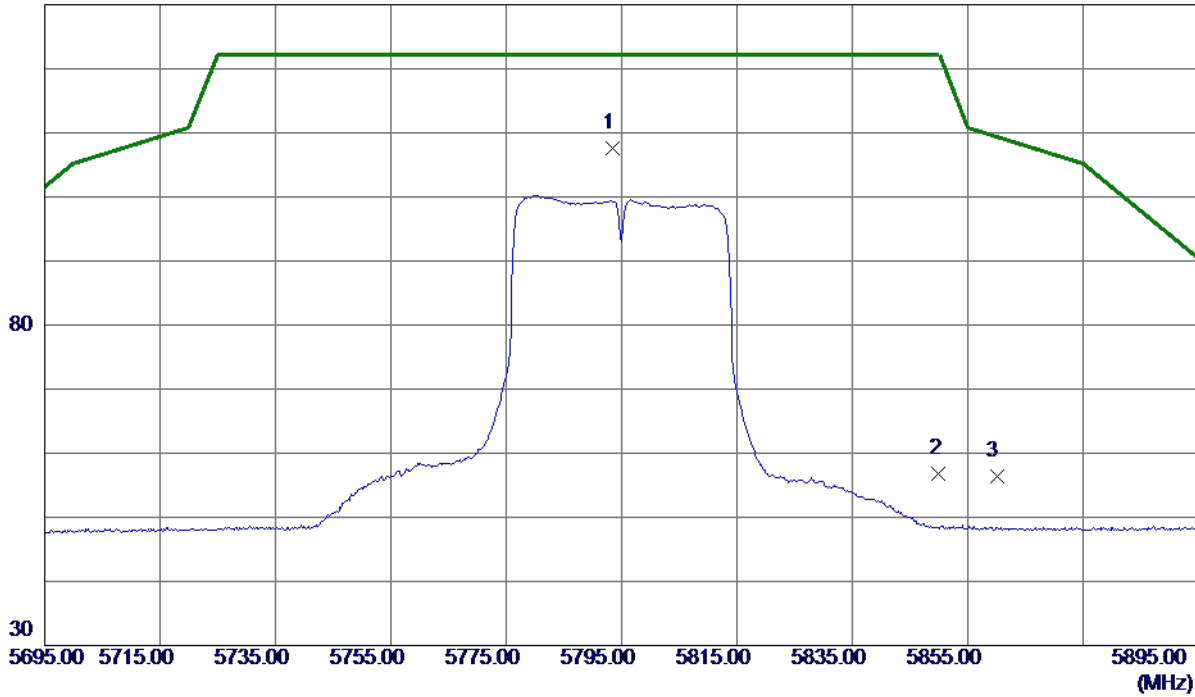

No.	Freq. MHz	Reading Level dBuV/m	Correct Factor dB	Measure ment dBuV/m	Limit dBuV/m	Margin dB	Detector	Comment
1 *	5793.4000	85.70	21.88	107.58	122.20	-14.62	Peak	No Limit
2	5850.0000	34.62	22.16	56.78	122.20	-65.42	Peak	
3	5860.0000	34.18	22.21	56.39	109.40	-53.01	Peak	

REMARKS:

- (1) Measurement Value = Reading Level + Correct Factor.
- (2) Margin Level = Measurement Value - Limit Value.

Orthogonal Axis	X
Test Mode	UNII-3_TX N (HT40) Mode 5795 MHz

Vertical

80 dBuV/m

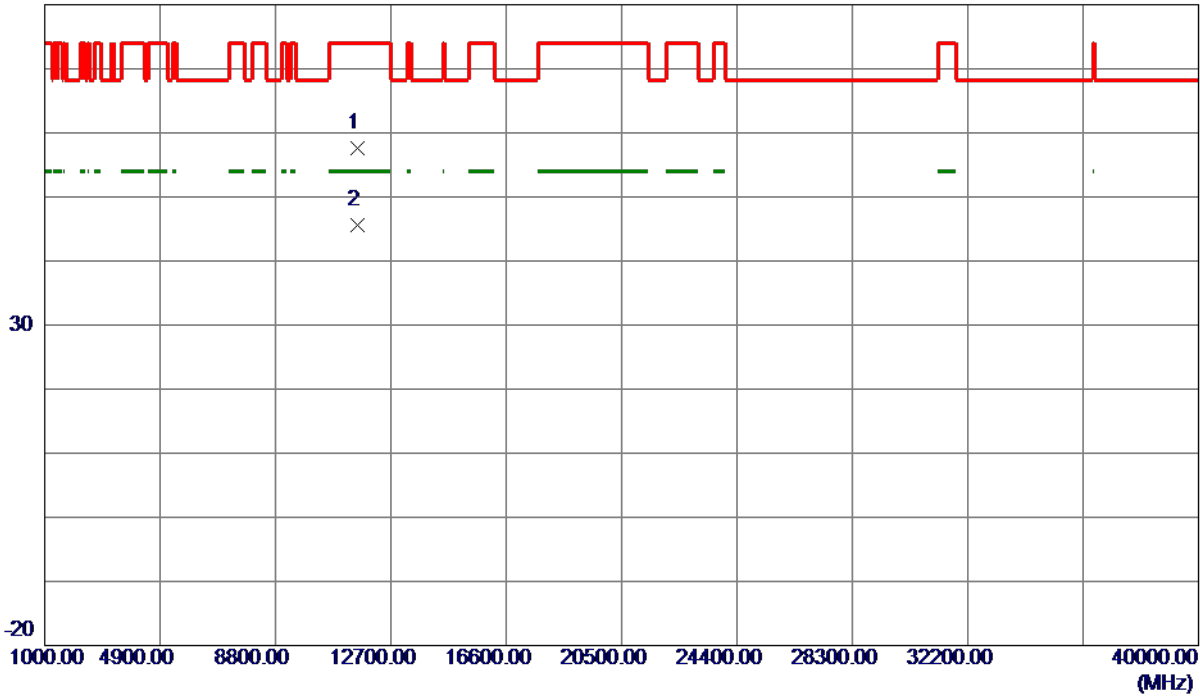

No.	Freq. MHz	Reading Level dBuV/m	Correct Factor dB	Measure ment dBuV/m	Limit dBuV/m	Margin dB	Detector	Comment
1	11585.9500	40.68	16.96	57.64	74.00	-16.36	Peak	
2 *	11586.8750	28.64	16.96	45.60	54.00	-8.40	AVG	

REMARKS:

- (1) Measurement Value = Reading Level + Correct Factor.
- (2) Margin Level = Measurement Value - Limit Value.

Orthogonal Axis	X
Test Mode	UNII-3_TX N (HT40) Mode 5795 MHz

Horizontal

130 dBuV/m

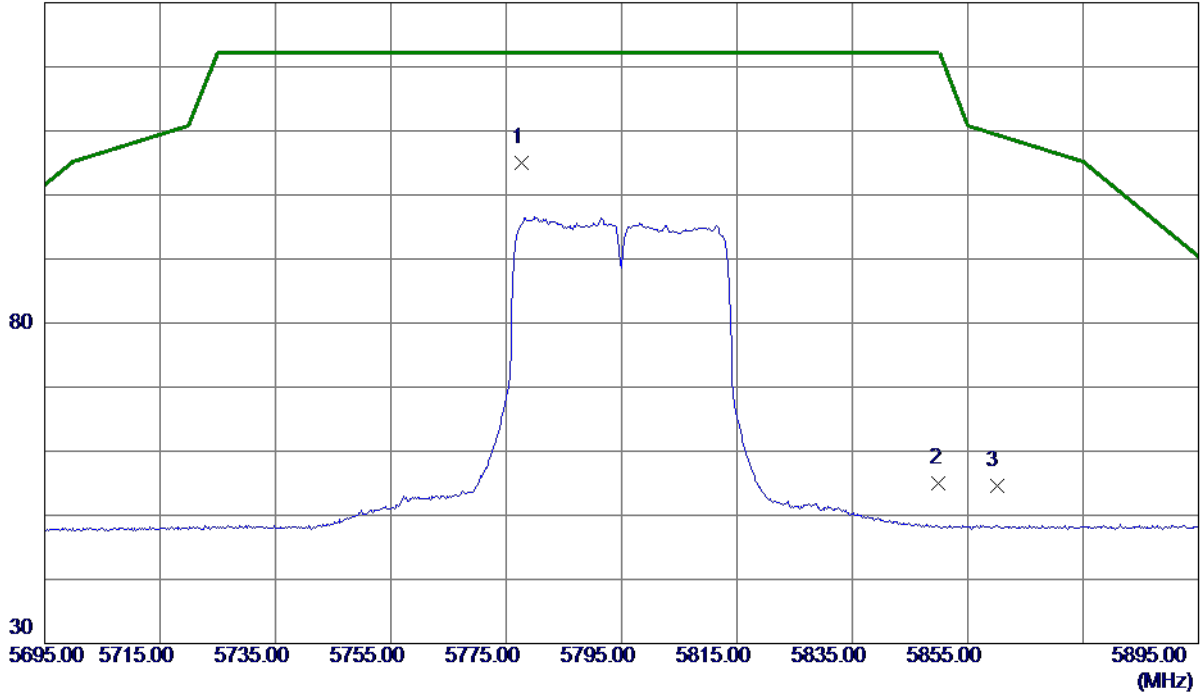

No.	Freq. MHz	Reading Level dBuV/m	Correct Factor dB	Measure ment dBuV/m	Limit dBuV/m	Margin dB	Detector	Comment
1 *	5777.6000	83.24	21.81	105.05	122.20	-17.15	Peak	No Limit
2	5850.0000	32.77	22.16	54.93	122.20	-67.27	Peak	
3	5860.0000	32.34	22.21	54.55	109.40	-54.85	Peak	

REMARKS:

- (1) Measurement Value = Reading Level + Correct Factor.
- (2) Margin Level = Measurement Value - Limit Value.

Orthogonal Axis	X
Test Mode	UNII-3_TX N (HT40) Mode 5795 MHz

Horizontal

80 dBuV/m

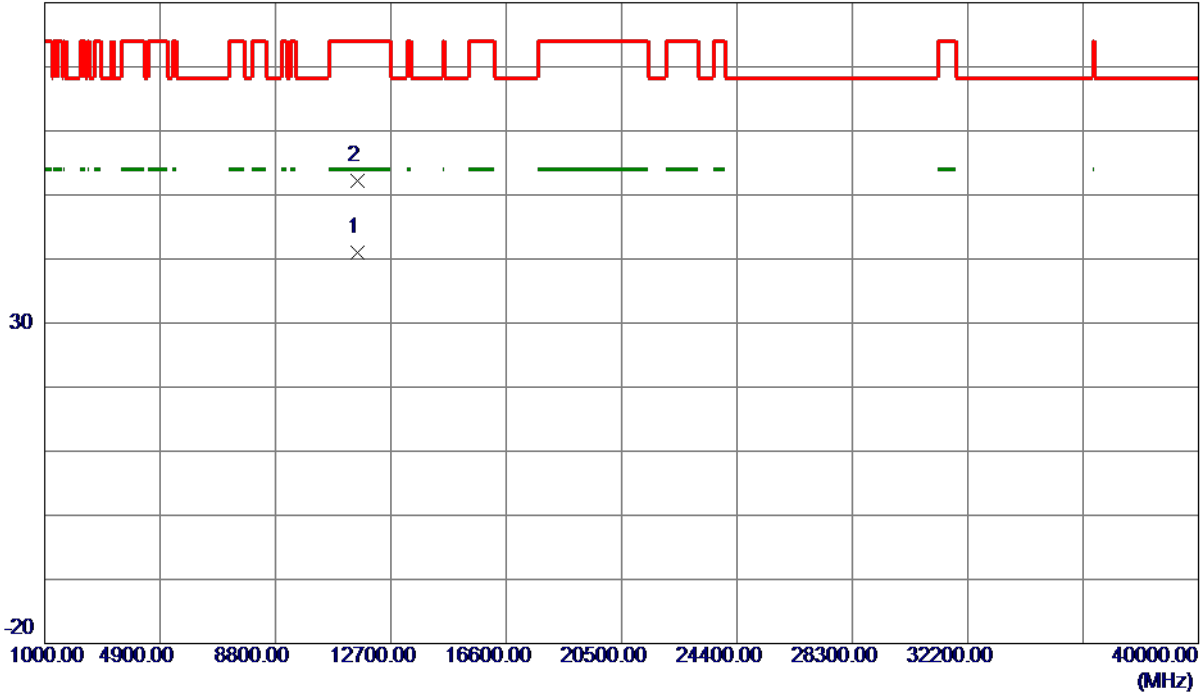

No.	Freq. MHz	Reading Level dBuV/m	Correct Factor dB	Measure ment dBuV/m	Limit dBuV/m	Margin dB	Detector	Comment
1 *	11588.7500	24.02	16.96	40.98	54.00	-13.02	AVG	
2	11589.2250	35.24	16.96	52.20	74.00	-21.80	Peak	

REMARKS:

- (1) Measurement Value = Reading Level + Correct Factor.
- (2) Margin Level = Measurement Value - Limit Value.

Orthogonal Axis	X
Test Mode	UNII-1_TX AC (VHT80) Mode 5210 MHz

Vertical

130 dBuV/m

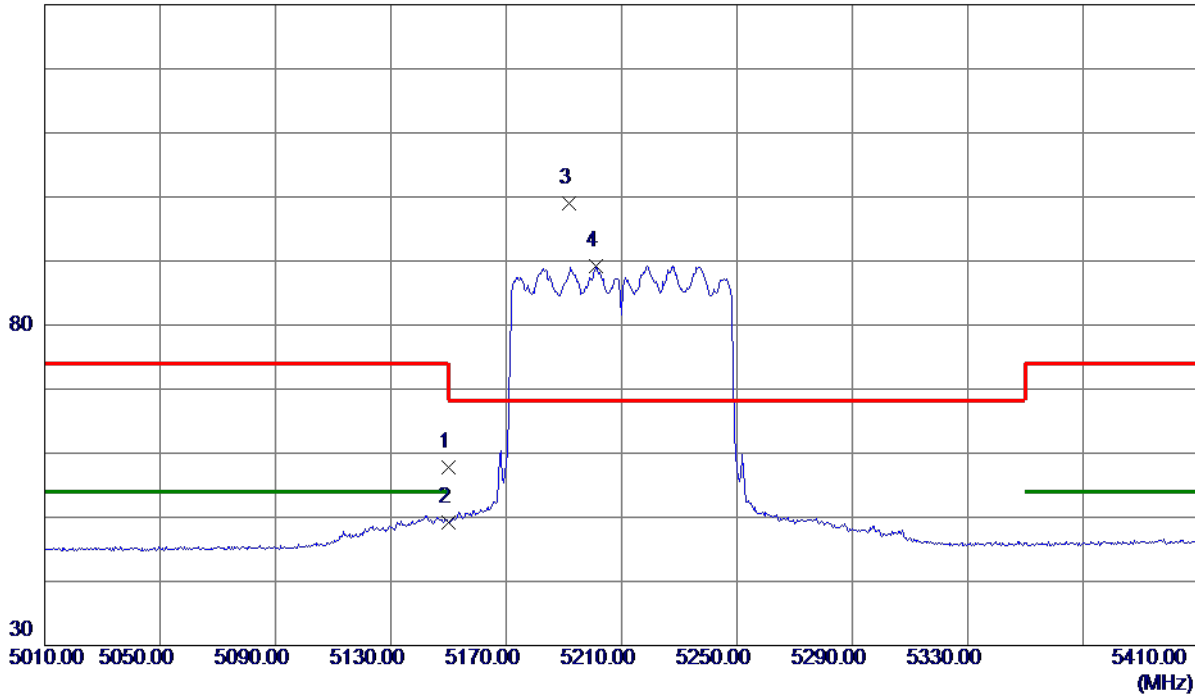

No.	Freq. MHz	Reading Level dBuV/m	Correct Factor dB	Measure ment dBuV/m	Limit dBuV/m	Margin dB	Detector	Comment
1	5150.0000	38.58	19.18	57.76	74.00	-16.24	Peak	
2	5150.0000	30.02	19.18	49.20	54.00	-4.80	AVG	
3 *	5191.6000	79.73	19.33	99.06	68.30	30.76	Peak	No Limit
4	5201.2000	69.82	19.36	89.18	999.00	-909.82	AVG	No Limit

REMARKS:

- (1) Measurement Value = Reading Level + Correct Factor.
- (2) Margin Level = Measurement Value - Limit Value.

Orthogonal Axis	X
Test Mode	UNII-1_TX AC (VHT80) Mode 5210 MHz

Vertical

80 dBuV/m

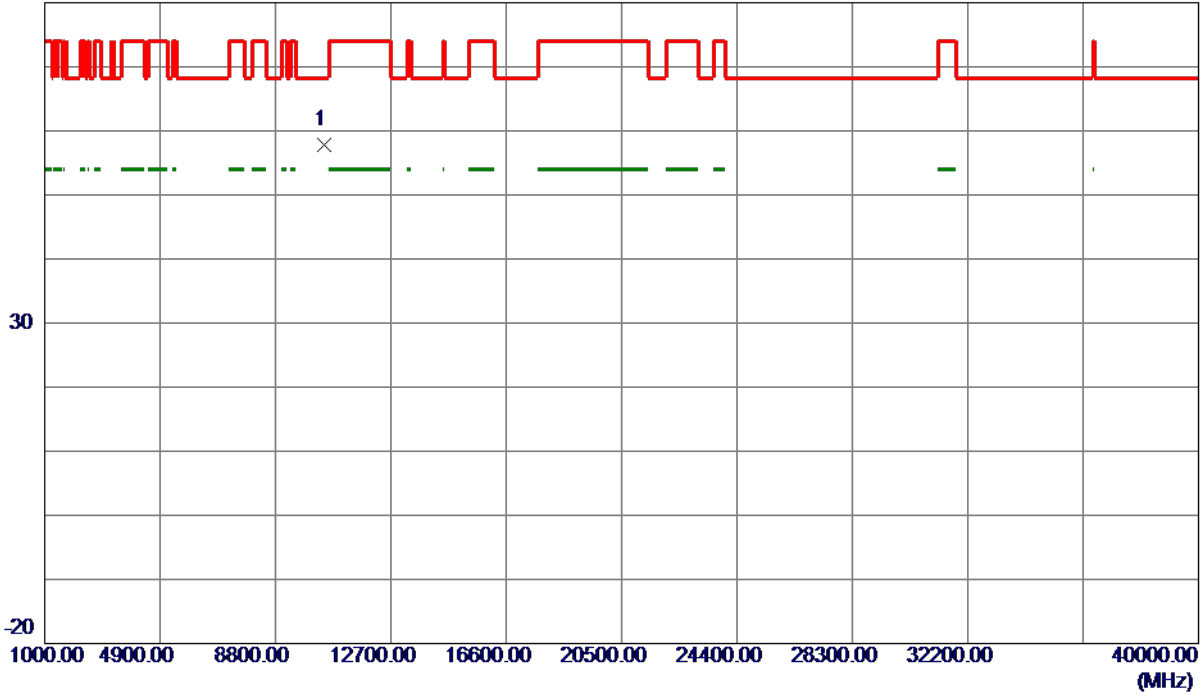

No.	Freq. MHz	Reading Level dBuV/m	Correct Factor dB	Measure ment dBuV/m	Limit dBuV/m	Margin dB	Detector	Comment
1 *	10447.1500	42.70	15.07	57.77	68.30	-10.53	Peak	

REMARKS:

- (1) Measurement Value = Reading Level + Correct Factor.
- (2) Margin Level = Measurement Value - Limit Value.

Orthogonal Axis	X
Test Mode	UNII-1_TX AC (VHT80) Mode 5210 MHz

Horizontal

130 dBuV/m

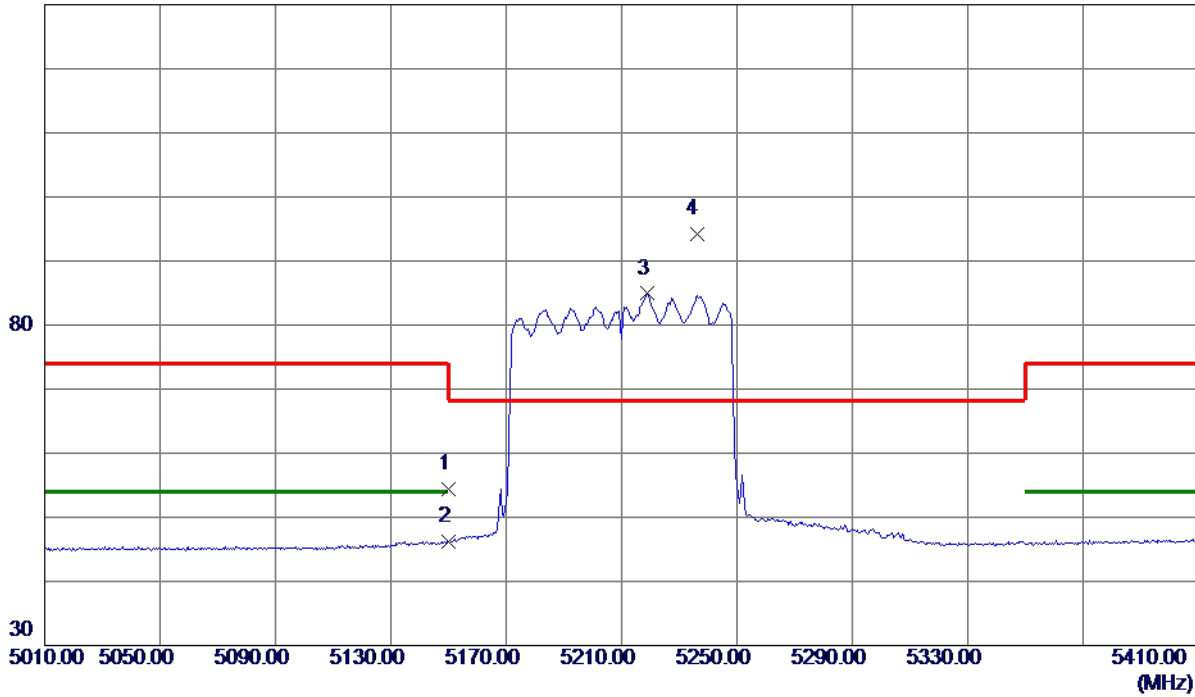

No.	Freq. MHz	Reading Level dBuV/m	Correct Factor dB	Measure ment dBuV/m	Limit dBuV/m	Margin dB	Detector	Comment
1	5150.0000	35.15	19.18	54.33	74.00	-19.67	Peak	
2	5150.0000	26.95	19.18	46.13	54.00	-7.87	AVG	
3	5218.8000	65.47	19.43	84.90	999.00	-914.10	AVG	No Limit
4 *	5236.0000	74.66	19.49	94.15	68.30	25.85	Peak	No Limit

REMARKS:

- (1) Measurement Value = Reading Level + Correct Factor.
- (2) Margin Level = Measurement Value - Limit Value.

Orthogonal Axis	X
Test Mode	UNII-1_TX AC (VHT80) Mode 5210 MHz

Horizontal

80 dBuV/m

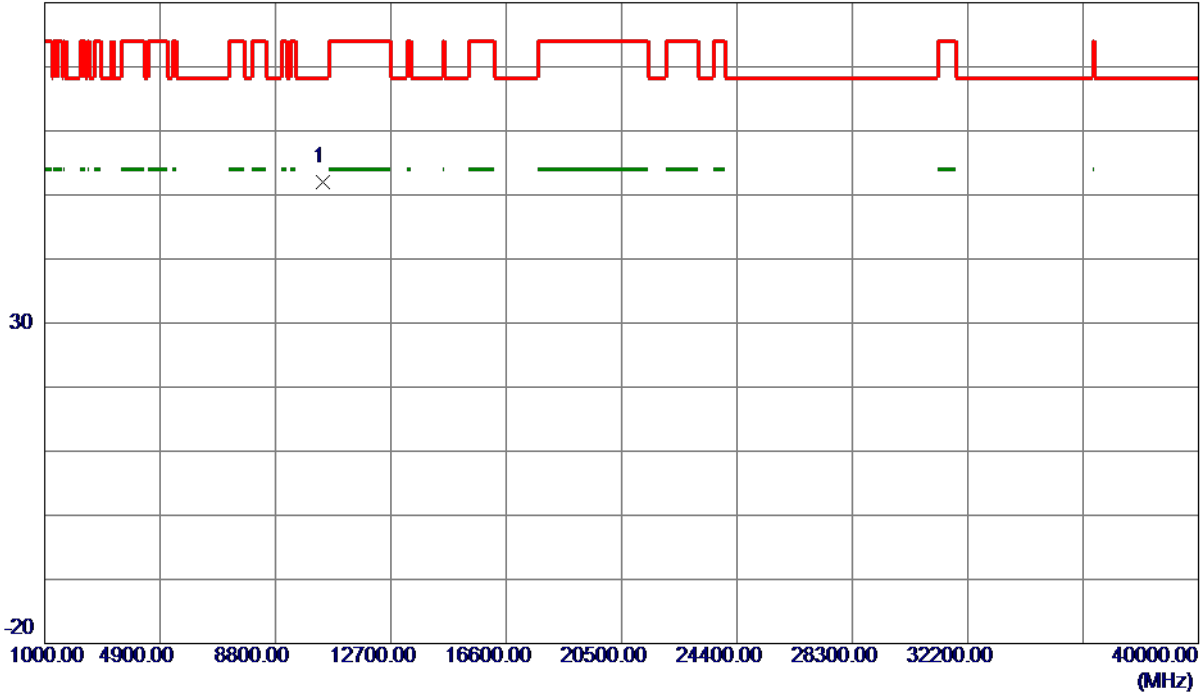

No.	Freq. MHz	Reading Level dBuV/m	Correct Factor dB	Measure ment dBuV/m	Limit dBuV/m	Margin dB	Detector	Comment
1 *	10422.1000	36.90	15.03	51.93	68.30	-16.37	Peak	

REMARKS:

- (1) Measurement Value = Reading Level + Correct Factor.
- (2) Margin Level = Measurement Value - Limit Value.

Orthogonal Axis	X
Test Mode	UNII-3_TX AC (VHT80) Mode 5775 MHz

Vertical

130 dBuV/m

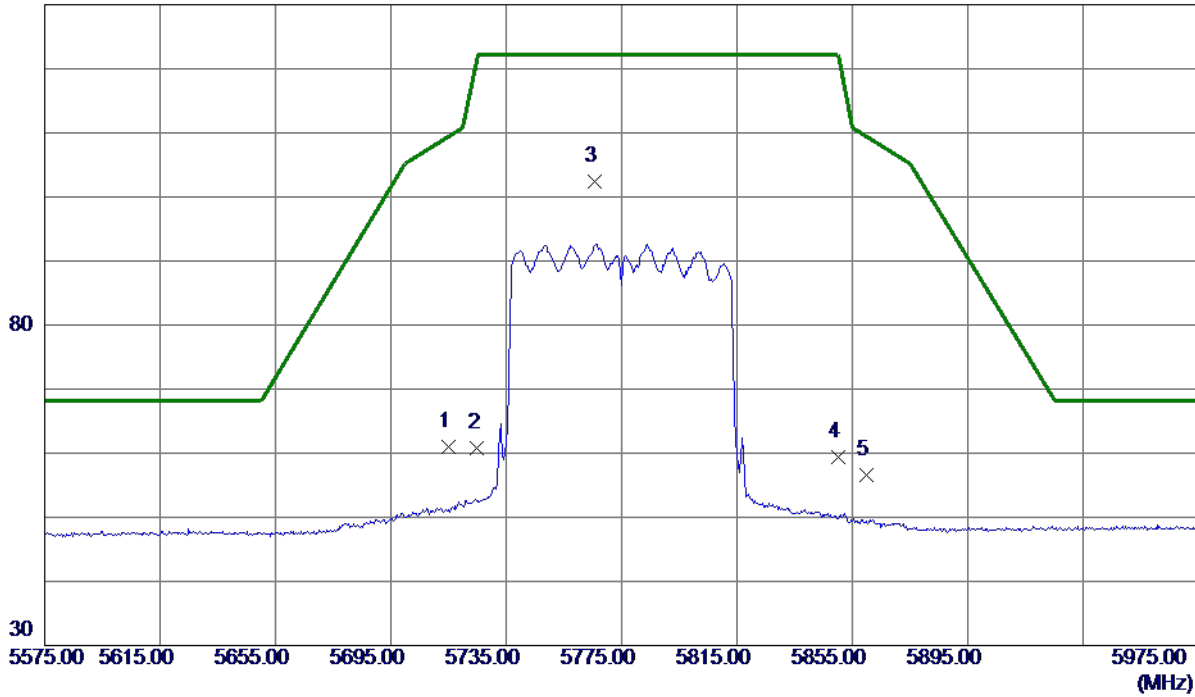

No.	Freq. MHz	Reading Level dBuV/m	Correct Factor dB	Measure ment dBuV/m	Limit dBuV/m	Margin dB	Detector	Comment
1	5715.0000	39.41	21.50	60.91	109.40	-48.49	Peak	
2	5725.0000	39.16	21.55	60.71	122.20	-61.49	Peak	
3 *	5765.8000	80.59	21.75	102.34	122.20	-19.86	Peak	No Limit
4	5850.0000	37.27	22.16	59.43	122.20	-62.77	Peak	
5	5860.0000	34.43	22.21	56.64	109.40	-52.76	Peak	

REMARKS:

- (1) Measurement Value = Reading Level + Correct Factor.
- (2) Margin Level = Measurement Value - Limit Value.

Orthogonal Axis	X
Test Mode	UNII-3_TX AC (VHT80) Mode 5775 MHz

Vertical

80 dBuV/m

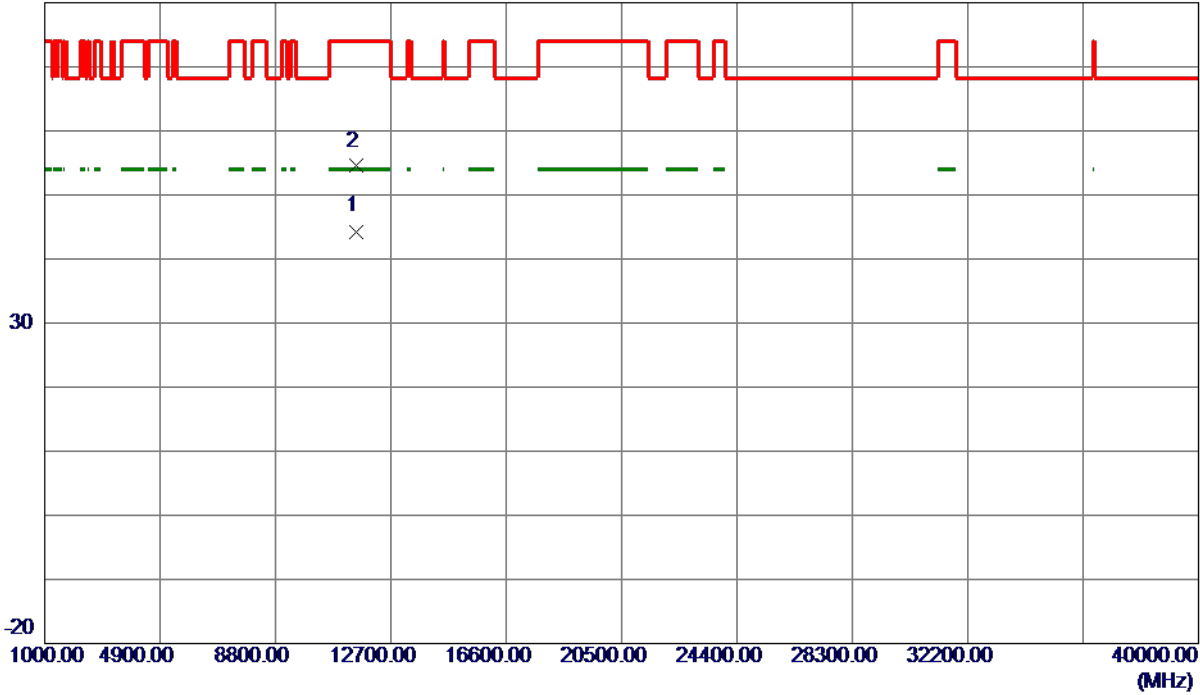

No.	Freq. MHz	Reading Level dBuV/m	Correct Factor dB	Measure ment dBuV/m	Limit dBuV/m	Margin dB	Detector	Comment
1 *	11541.4500	27.33	16.97	44.30	54.00	-9.70	AVG	
2	11549.8250	37.53	16.97	54.50	74.00	-19.50	Peak	

REMARKS:

- (1) Measurement Value = Reading Level + Correct Factor.
- (2) Margin Level = Measurement Value - Limit Value.

Orthogonal Axis	X
Test Mode	UNII-3_TX AC (VHT80) Mode 5775 MHz

Horizontal

130 dBuV/m

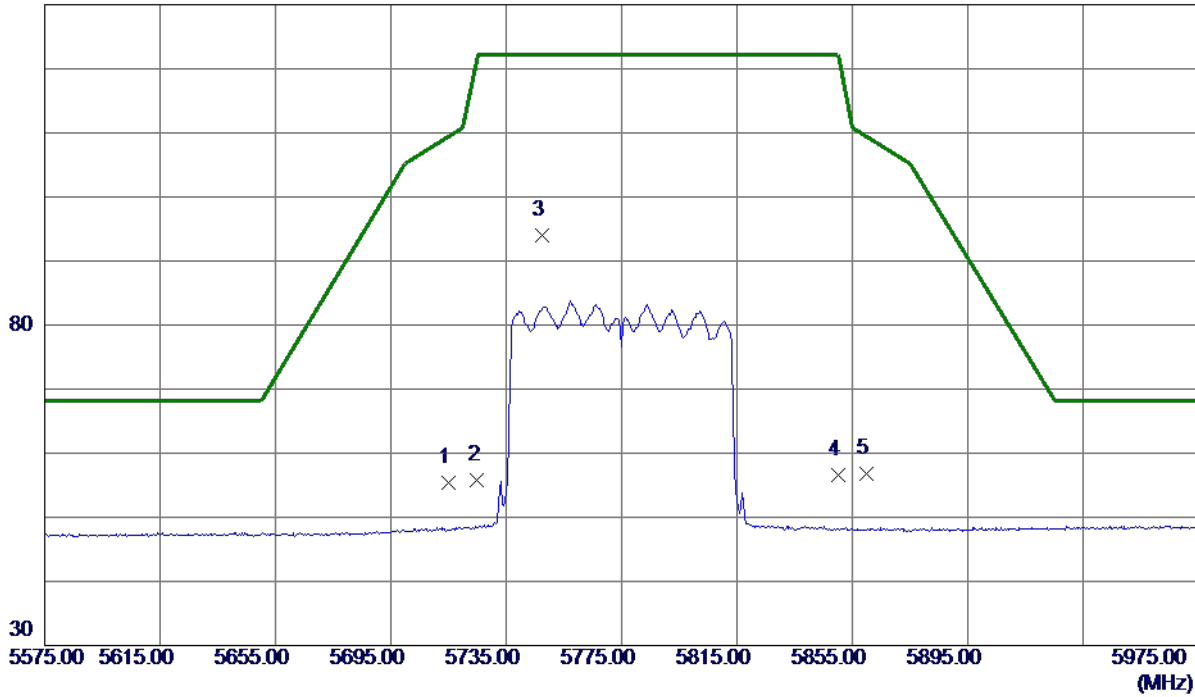

No.	Freq. MHz	Reading Level dBuV/m	Correct Factor dB	Measure ment dBuV/m	Limit dBuV/m	Margin dB	Detector	Comment
1	5715.0000	33.93	21.50	55.43	109.40	-53.97	Peak	
2	5725.0000	34.24	21.55	55.79	122.20	-66.41	Peak	
3 *	5747.4000	72.35	21.66	94.01	122.20	-28.19	Peak	No Limit
4	5850.0000	34.51	22.16	56.67	122.20	-65.53	Peak	
5	5860.0000	34.56	22.21	56.77	109.40	-52.63	Peak	

REMARKS:

- (1) Measurement Value = Reading Level + Correct Factor.
- (2) Margin Level = Measurement Value - Limit Value.

Orthogonal Axis	X
Test Mode	UNII-3_TX AC (VHT80) Mode 5775 MHz

Horizontal

80 dBuV/m

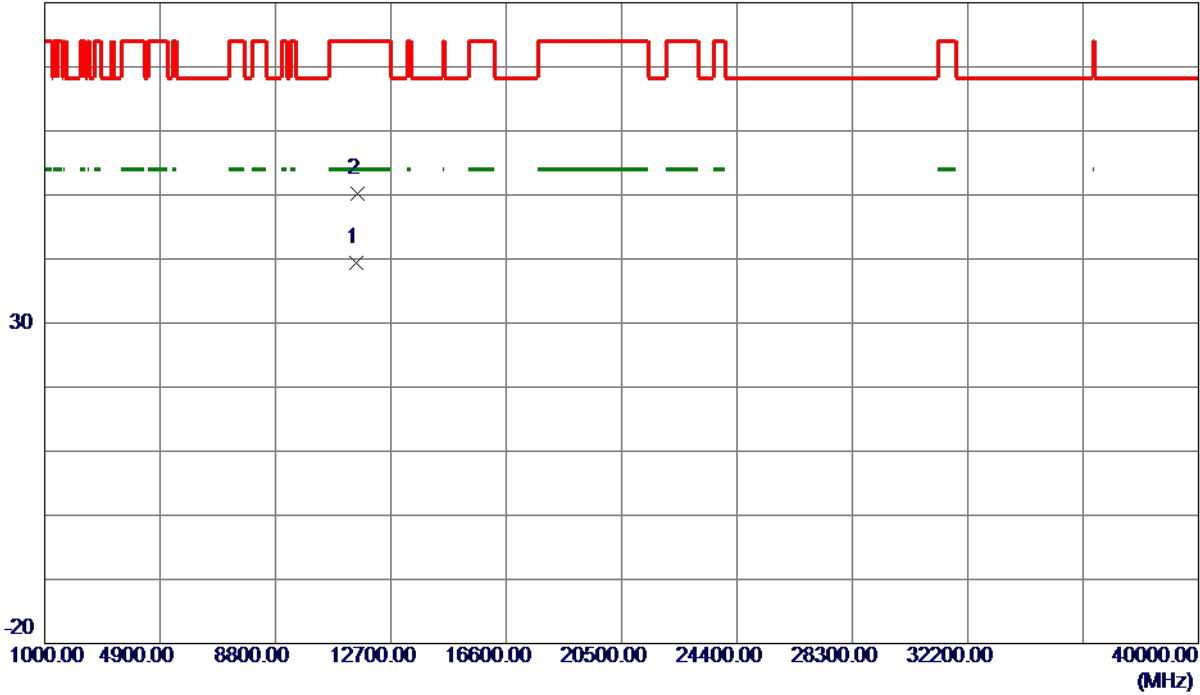

No.	Freq. MHz	Reading Level dBuV/m	Correct Factor dB	Measure ment dBuV/m	Limit dBuV/m	Margin dB	Detector	Comment
1 *	11550.9500	22.35	16.97	39.32	54.00	-14.68	AVG	
2	11555.5750	33.18	16.96	50.14	74.00	-23.86	Peak	

REMARKS:

- (1) Measurement Value = Reading Level + Correct Factor.
- (2) Margin Level = Measurement Value - Limit Value.

The worst case of simultaneous transmission:

Test Mode:	WLAN 2.4G_TX B Mode 2412MHz + RLAN 5G_TX A Mode 5825MHz
------------	---

Vertical

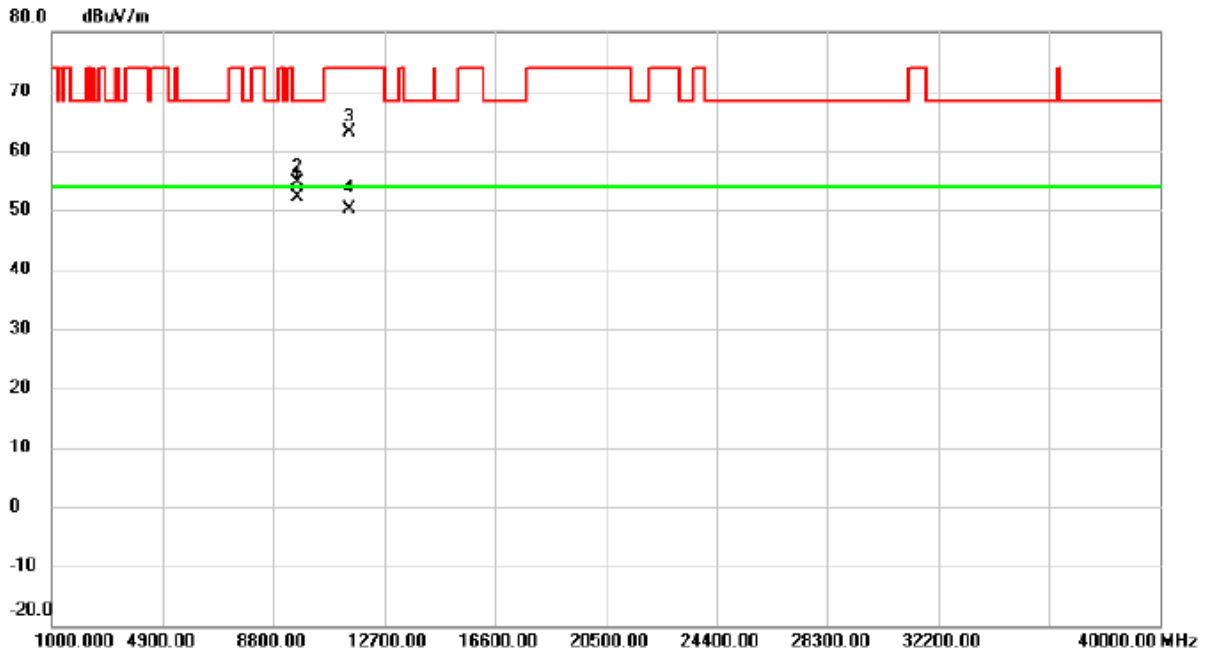

No.	Mk.	Freq. MHz	Reading Level dBuV	Correct Factor dB	Measure- ment dBuV/m	Limit dBuV/m	Margin dB	Detector	Comment
1	*	9648.500	33.38	18.79	52.17	54.00	-1.83	AVG	
2		9648.015	35.80	18.79	54.59	68.30	-13.71	peak	
3		11490.20	43.32	19.70	63.02	74.00	-10.98	peak	
4		11490.50	30.54	19.70	50.24	54.00	-3.76	AVG	

REMARKS:

- (1) Measurement Value = Reading Level + Correct Factor.
- (2) Margin Level = Measurement Value - Limit Value.

Test Mode: WLAN 2.4G_TX B Mode 2412MHz + RLAN 5G_TX A Mode 5825MHz

Horizontal

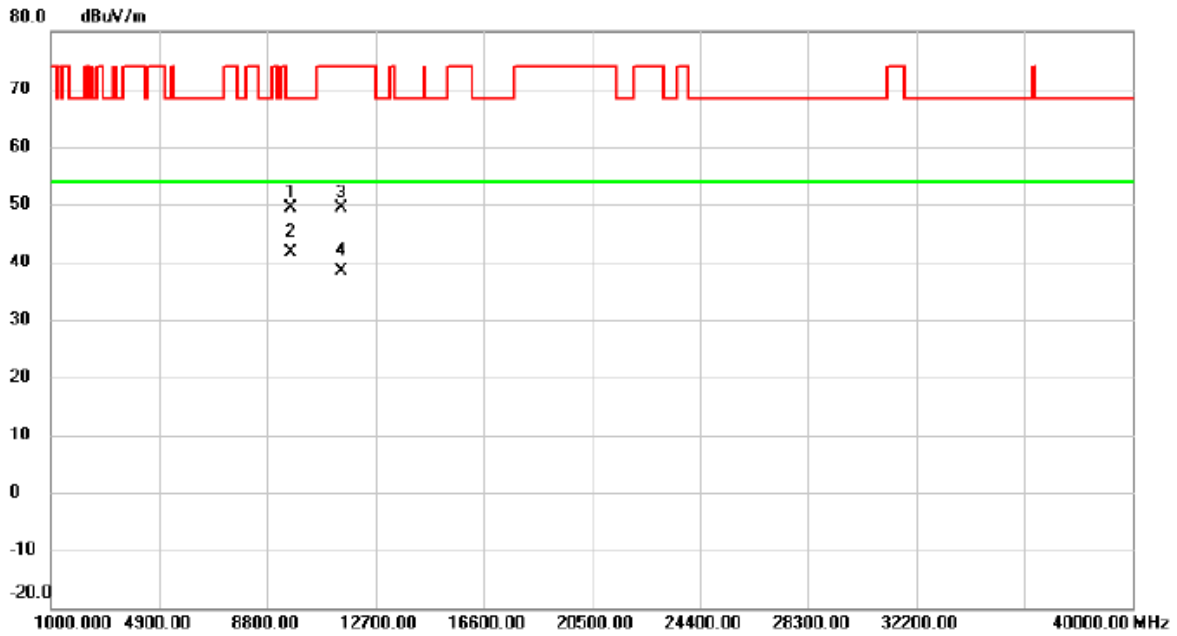

No.	Mk.	Freq. MHz	Reading Level dBuV	Correct Factor dB	Measure- ment dBuV/m	Limit dBuV/m	Margin dB	Detector	Comment
1		9648.650	36.32	13.03	49.35	68.30	-18.95	peak	
2	*	9648.825	28.53	13.03	41.56	54.00	-12.44	AVG	
3		11490.12	32.54	16.95	49.49	74.00	-24.51	peak	
4		11490.36	21.48	16.95	38.43	54.00	-15.57	AVG	

REMARKS:

- (1) Measurement Value = Reading Level + Correct Factor.
- (2) Margin Level = Measurement Value - Limit Value.

APPENDIX E - BANDWIDTH

Test Mode	UNII-1_TX A Mode
-----------	------------------

Channel	Frequency (MHz)	26 dB Bandwidth (MHz)	99 % Emission Bandwidth (MHz)
36	5180	20.79	16.90
40	5200	20.89	16.80
48	5240	21.15	16.80

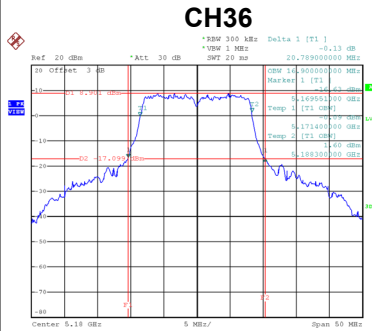

Date: 11.MAR.2020 09:18:44

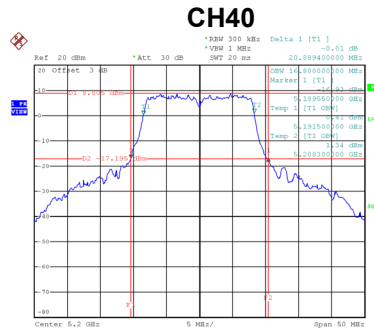

Date: 11.MAR.2020 09:19:38

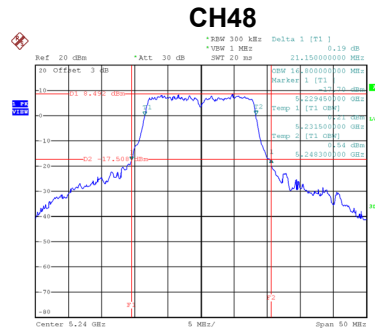

Date: 11.MAR.2020 09:20:26

Test Mode	UNII-1_TX N (HT20) Mode
-----------	-------------------------

Channel	Frequency (MHz)	26 dB Bandwidth (MHz)	99 % Emission Bandwidth (MHz)
36	5180	21.69	17.90
40	5200	21.79	17.90
48	5240	21.70	17.90

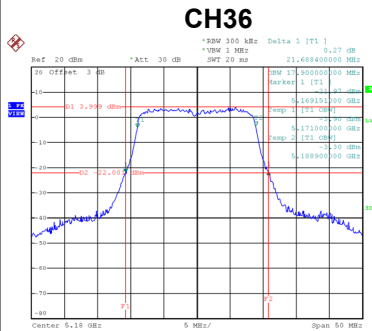

Date: 11.MAR.2020 09:39:46

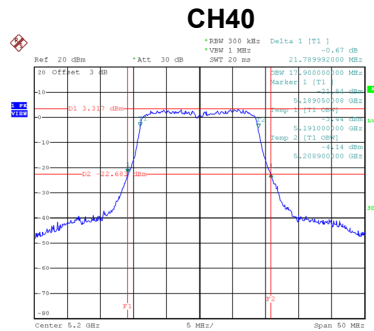

Date: 11.MAR.2020 09:40:36

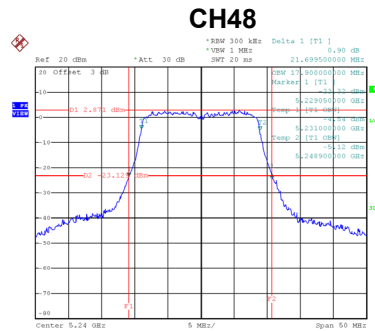

Date: 11.MAR.2020 09:41:17

Test Mode	UNII-1_TX N (HT40) Mode
-----------	-------------------------

Channel	Frequency (MHz)	26 dB Bandwidth (MHz)	99 % Emission Bandwidth (MHz)
38	5190	42.30	36.40
46	5230	42.30	36.40

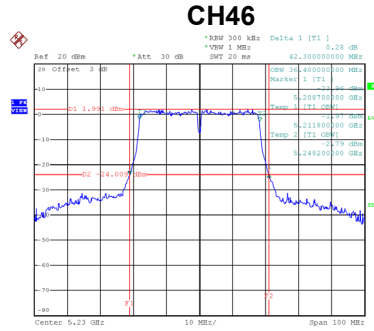
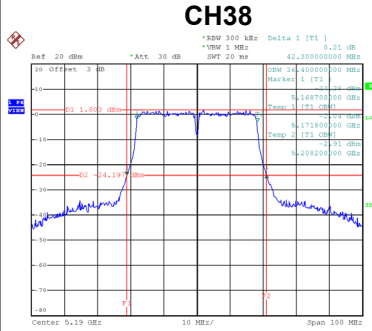

Date: 11.MAR.2020 09:55:52

Date: 11.MAR.2020 10:03:05

Test Mode UNII-3_TX A Mode

Channel	Frequency (MHz)	6 dB Bandwidth (MHz)	99 % Emission Bandwidth (MHz)	6 dB Bandwidth Min. Limit (kHz)	Result
149	5745	16.35	16.80	500	Complies
157	5785	16.35	16.80	500	Complies
165	5825	16.35	16.80	500	Complies

CH149

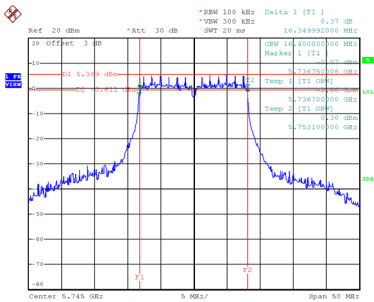

Date: 11.MAR.2020 09:31:37

CH157
6 dB Bandwidth

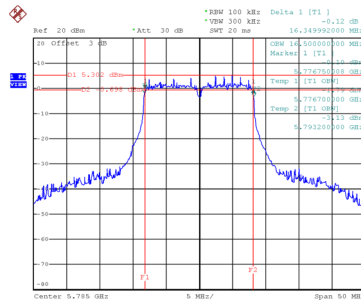

Date: 11.MAR.2020 09:33:28

CH165

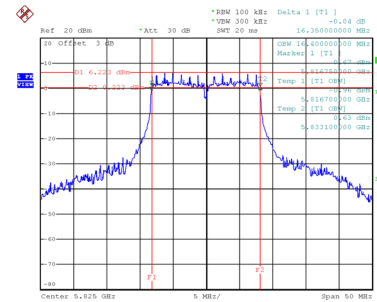

Date: 11.MAR.2020 09:35:13

99 % Emission Bandwidth

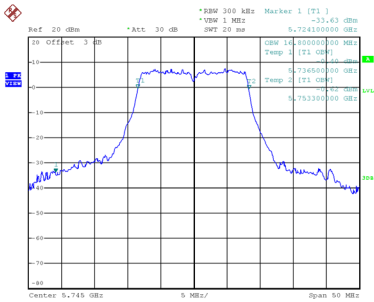

Date: 11.MAR.2020 10:58:02

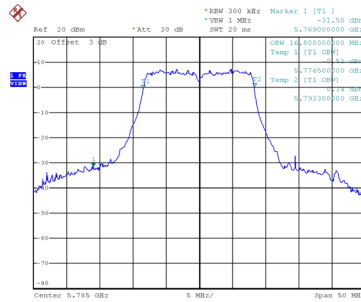

Date: 11.MAR.2020 10:58:14

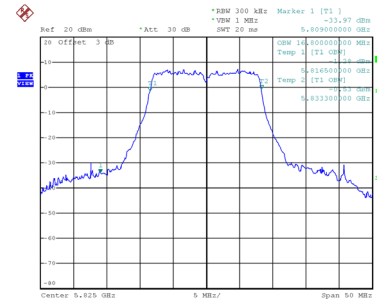

Date: 11.MAR.2020 10:58:24

Test Mode UNII-3_TX N (HT20) Mode

Channel	Frequency (MHz)	6 dB Bandwidth (MHz)	99 % Emission Bandwidth (MHz)	6 dB Bandwidth Min. Limit (kHz)	Result
149	5745	16.99	17.90	500	Complies
157	5785	17.19	17.90	500	Complies
165	5825	16.99	17.90	500	Complies

CH149

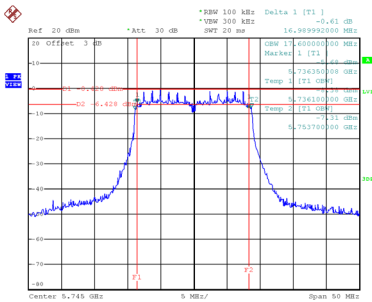

Date: 11.MAR.2020 09:48:54

CH157
6 dB Bandwidth

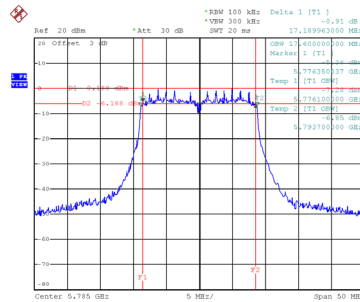

Date: 11.MAR.2020 09:49:54

CH165

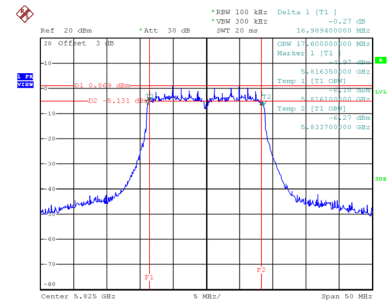

Date: 11.MAR.2020 09:51:52

99 % Emission Bandwidth

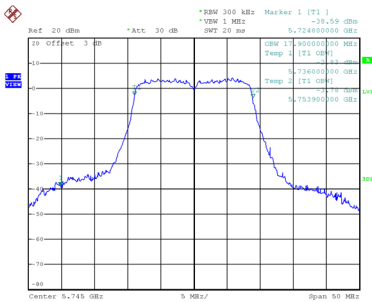

Date: 11.MAR.2020 11:00:28

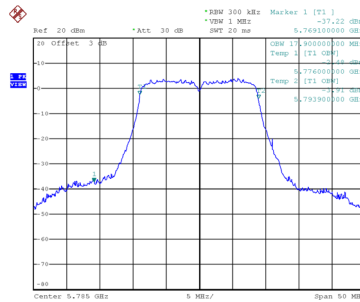

Date: 11.MAR.2020 11:00:42

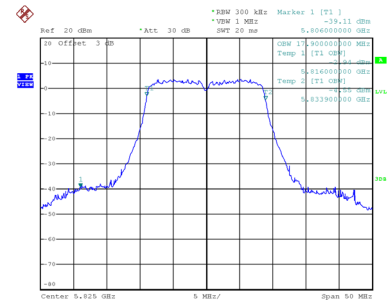

Date: 11.MAR.2020 11:00:57

Test Mode	UNII-3_TX N (HT40) Mode
-----------	-------------------------

Channel	Frequency (MHz)	6 dB Bandwidth (MHz)	99 % Emission Bandwidth (MHz)	6 dB Bandwidth Min. Limit (kHz)	Result
151	5755	36.50	37.20	500	Complies
159	5795	36.50	37.20	500	Complies

CH151

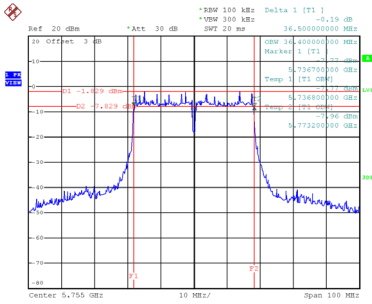

Date: 11.MAR.2020 10:11:22

CH159

6 dB Bandwidth

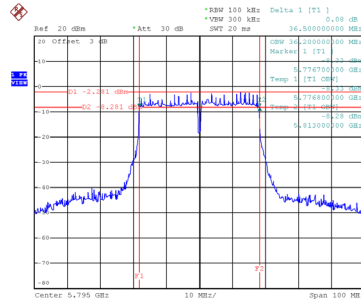

Date: 11.MAR.2020 10:12:40

99 % Emission Bandwidth

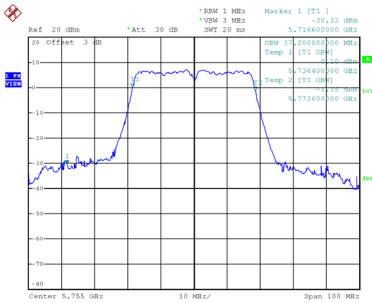

Date: 11.MAR.2020 11:06:43

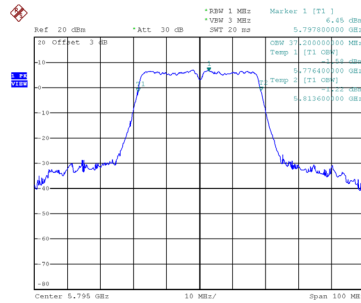

Date: 11.MAR.2020 11:06:56

Test Mode	UNII-1_TX AC (VHT20) Mode
-----------	---------------------------

Channel	Frequency (MHz)	26 dB Bandwidth (MHz)	99 % Emission Bandwidth (MHz)
36	5180	21.79	17.90
40	5200	21.69	17.90
48	5240	21.76	17.90

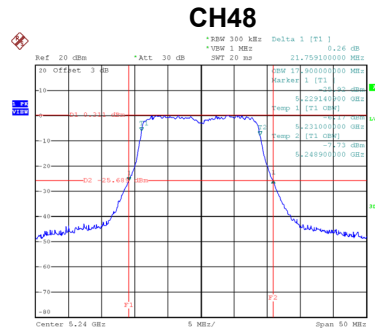
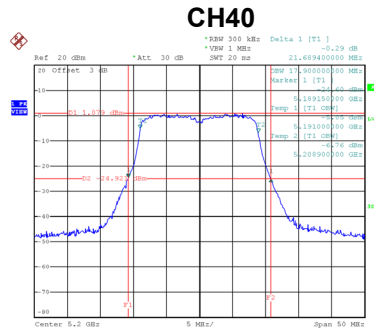
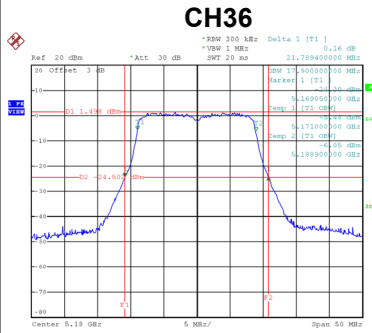

Date: 11.MAR.2020 10:25:15

Date: 11.MAR.2020 10:26:56

Date: 11.MAR.2020 10:28:23

Test Mode	UNII-1_TX AC (VHT40) Mode
-----------	---------------------------

Channel	Frequency (MHz)	26 dB Bandwidth (MHz)	99 % Emission Bandwidth (MHz)
38	5190	42.59	36.40
46	5230	43.10	36.40

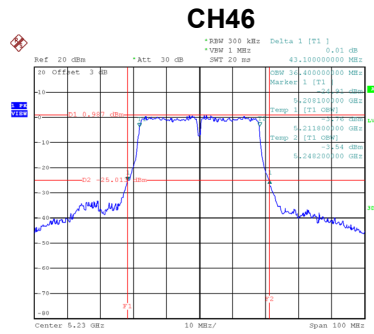
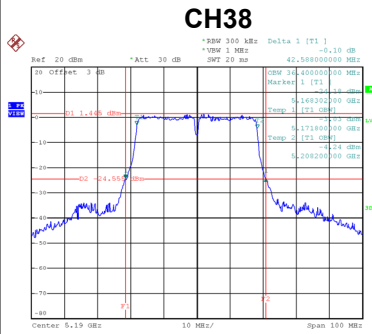

Date: 11.MAR.2020 10:44:45

Date: 11.MAR.2020 10:45:49

Test Mode	UNII-1_TX AC (VHT80)
-----------	----------------------

Channel	Frequency (MHz)	26 dB Bandwidth (MHz)	99 % Emission Bandwidth (MHz)
42	5210	82.40	76.00

CH42

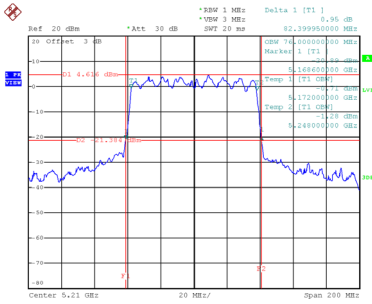

Date: 11.MAR.2020 10:13:49