

FCC Test Report (15.407)

Report No.: RF131223E02C-1

FCC ID: XU8TEW818DRU

Test Model: TEW-818DRU

Received Date: Oct. 28, 2015

Test Date: Nov. 03 to 06, 2015

Issued Date: Dec. 24, 2015

Applicant: TRENDnet, Inc.

Address: 20675 Manhattan Place, Torrance, CA 90501

Issued By: Bureau Veritas Consumer Products Services (H.K.) Ltd., Taoyuan Branch
Hsin Chu Laboratory

Lab Address: E-2, No.1, Li Hsin 1st Road, Hsinchu Science Park, Hsinchu City 300,
Taiwan R.O.C.

Test Location (1): E-2, No.1, Li Hsin 1st Road, Hsinchu Science Park, Hsinchu City 300,
Taiwan R.O.C.

Test Location (2): No. 49, Ln. 206, Wende Rd., Shangshan Tsuen, Chiung Lin Hsiang, Hsin
Chu Hsien 307, Taiwan R.O.C.



This report is for your exclusive use. Any copying or replication of this report to or for any other person or entity, or use of our name or trademark, is permitted only with our prior written permission. This report sets forth our findings solely with respect to the test samples identified herein. The results set forth in this report are not indicative or representative of the quality or characteristics of the lot from which a test sample was taken or any similar or identical product unless specifically and expressly noted. Our report includes all of the tests requested by you and the results thereof based upon the information that you provided to us. You have 60 days from date of issuance of this report to notify us of any material error or omission caused by our negligence, provided, however, that such notice shall be in writing and shall specifically address the issue you wish to raise. A failure to raise such issue within the prescribed time shall constitute your unqualified acceptance of the completeness of this report, the tests conducted and the correctness of the report contents. Unless specific mention, the uncertainty of measurement has been explicitly taken into account to declare the compliance or non-compliance to the specification. The report must not be used by the client to claim product certification, approval, or endorsement by TAF or any government agencies.

Table of Contents

Release Control Record	4
1 Certificate of Conformity	5
2 Summary of Test Results	6
2.1 Measurement Uncertainty	6
2.2 Modification Record	6
3 General Information	7
3.1 General Description of EUT	7
3.2 Description of Test Modes	10
3.2.1 Test Mode Applicability and Tested Channel Detail	11
3.3 Duty Cycle of Test Signal	13
3.4 Description of Support Units	14
3.4.1 Configuration of System under Test	15
3.5 General Description of Applied Standard	16
4 Test Types and Results	17
4.1 Radiated Emission and Bandedge Measurement.....	17
4.1.1 Limits of Radiated Emission and Bandedge Measurement	17
4.1.2 Test Instruments	18
4.1.3 Test Procedure	20
4.1.4 Deviation from Test Standard	20
4.1.5 Test Setup.....	21
4.1.6 EUT Operating Condition	21
4.1.7 Test Results	22
4.2 Conducted Emission Measurement	32
4.2.1 Limits of Conducted Emission Measurement	32
4.2.2 Test Instruments	32
4.2.3 Test Procedure	33
4.2.4 Deviation from Test Standard	33
4.2.5 Test Setup.....	33
4.2.6 EUT Operating Condition	33
4.2.7 Test Results	34
4.3 Transmit Power Measurement	36
4.3.1 Limits of Transmit Power Measurement	36
4.3.2 Test Setup.....	36
4.3.3 Test Instruments	36
4.3.4 Test Procedure	36
4.3.5 Deviation from Test Standard	36
4.3.6 EUT Operating Condition	37
4.3.7 Test Result.....	38
4.4 Peak Power Spectral Density Measurement	39
4.4.1 Limits of Peak Power Spectral Density Measurement	39
4.4.2 Test Setup.....	39
4.4.3 Test Instruments	39
4.4.4 Test Procedure	40
4.4.5 Deviation from Test Standard	40
4.4.6 EUT Operating Condition	40
4.4.7 Test Results	41
4.5 Frequency Stability Measurement	44
4.5.1 Limits of Frequency Stability Measurement	44
4.5.2 Test Setup.....	44
4.5.3 Test Instruments	44
4.5.4 Test Procedure	44
4.5.5 Deviation from Test Standard	44
4.5.6 EUT Operating Condition	44



4.5.7 Test Results	45
4.6 6dB Bandwidth Measurement.....	46
4.6.1 Limits of 6dB Bandwidth Measurement.....	46
4.6.2 Test Setup.....	46
4.6.3 Test Instruments	46
4.6.4 Test Procedure	46
4.6.5 Deviation from Test Standard	46
4.6.6 EUT Operating Condition	46
4.6.7 Test Results	47
5 Pictures of Test Arrangements.....	49
Appendix – Information on the Testing Laboratories	50



A D T

Release Control Record

Issue No.	Description	Date Issued
RF131223E02C-1	Original release.	Dec. 24, 2015



A D T

1 Certificate of Conformity

Product: AC1900 Dual Band Wireless Router

Brand: TRENDnet

Test Model: TEW-818DRU

Sample Status: ENGINEERING SAMPLE

Applicant: TRENDnet, Inc.

Test Date: Nov. 03 to 06, 2015

Standard: 47 CFR FCC Part 15, Subpart E (Section 15.407)
ANSI C63.10: 2013

The above equipment has been tested by **Bureau Veritas Consumer Products Services (H.K.) Ltd., Taoyuan Branch**, and found compliance with the requirement of the above standards. The test record, data evaluation & Equipment Under Test (EUT) configurations represented herein are true and accurate accounts of the measurements of the sample's EMC characteristics under the conditions specified in this report.

Prepared by :  , **Date:** Dec. 24, 2015
Lori Chung / Specialist

Approved by :  , **Date:** Dec. 24, 2015
May Chen / Manager

2 Summary of Test Results

47 CFR FCC Part 15, Subpart E (SECTION 15.407)			
FCC Clause	Test Item	Result	Remarks
15.407(b)(6)	AC Power Conducted Emissions	PASS	Meet the requirement of limit. Minimum passing margin is -2.10dB at 0.30234MHz.
15.407(b)(1/2/3/4/6)	Radiated Emissions & Band Edge Measurement	PASS	Meet the requirement of limit. Minimum passing margin is -0.1dB at 5725.00MHz & 5860.00MHz.
15.407(a)(1/2/3)	Max Average Transmit Power	PASS	Meet the requirement of limit.
15.407(a)(1/2/3)	Peak Power Spectral Density	PASS	Meet the requirement of limit.
15.407(e)	6dB bandwidth	PASS	Meet the requirement of limit. (U-NII-3 Band only)
15.407(g)	Frequency Stability	PASS	Meet the requirement of limit.
15.203	Antenna Requirement	PASS	Antenna connector is i-pex(MHF) not a standard connector.

- NOTE:** 1. The EUT was operating in 2400 ~ 2483.5MHz, 5.15~5.25GHz and 5.725~5.850GHz frequencies band. This report was recorded the RF parameters including 5.15~5.25GHz and 5.725~5.850GHz. For the 2400 ~ 2483.5MHz RF parameters was recorded in another test report.
2. This report is prepared for FCC Class II permissive change. (Upgrade the standard to section 15.407 under new rule and added one new adapter).

2.1 Measurement Uncertainty

Where relevant, the following measurement uncertainty levels have been estimated for tests performed on the EUT as specified in CISPR 16-4-2:

Measurement	Frequency	Expanded Uncertainty (k=2) (±)
Conducted Emissions at mains ports	150kHz ~ 30MHz	2.86 dB
Radiated Emissions up to 1 GHz	30MHz ~1GHz	5.37 dB
Radiated Emissions above 1 GHz	1GHz ~6GHz	3.65 dB
	16GHz ~ 18GHz	3.88 dB
	18GHz ~ 40GHz	4.11 dB

2.2 Modification Record

There were no modifications required for compliance.

3 General Information

3.1 General Description of EUT

Product	AC1900 Dual Band Wireless Router
Brand	TRENDnet
Test Model	TEW-818DRU
Status of EUT	ENGINEERING SAMPLE
Power Supply Rating	DC 12V from power adapter
Modulation Type	CCK, DQPSK, DBPSK for DSSS 64QAM, 16QAM, QPSK, BPSK for OFDM 256QAM for OFDM in 11ac mode and VHT (20/40) mode in 2.4GHz
Modulation Technology	DSSS, OFDM
Transfer Rate	2.4GHz: 802.11b: up to 11Mbps 802.11g: up to 54Mbps 802.11n: up to 600Mbps 5GHz: 802.11a: up to 54Mbps 802.11n: up to 450Mbps 802.11ac: up to 1300Mbps
Operating Frequency	For 5GHz: 5.18 ~ 5.24GHz, 5.745 ~ 5.825GHz For 2.4GHz: 2.412 ~ 2.462GHz
Number of Channel	For 5GHz 9 for 802.11a, 802.11n (HT20), 802.11ac (VHT20) 4 for 802.11n (HT40), 802.11ac (VHT40) 2 for 802.11ac (VHT80) For 2.4GHz 11 for 802.11b, 802.11g, 802.11n (HT20) 7 for 802.11n (HT40)
Output Power	For 5GHz 802.11a: 450.817 mW 802.11ac (VHT20): 350.93mW 802.11ac (VHT40): 345.754mW 802.11ac (VHT80): 115.388mW For 2.4GHz 802.11b: 218.273mW 802.11g: 412.098mW 802.11n (HT20): 705.471mW 802.11n (HT40): 263.260mW
Antenna Type	Refer to Note
Antenna Connector	Refer to Note
Accessory Device	Adapter x1
Data Cable Supplied	Ethernet Cable (unshielded, 1.5m) x1

Note:

1. This report is prepared for FCC Class II permissive change. This report is used in conjunction with report No: RF131223E02-1 and adds the following additional information:

- ◆ Upgraded the standard to section 15.407 under new rule.
- ◆ Added one new adapter as following table:

Original				
No	Brand	Model No.	Plug	Spec.
1	HON-KWANG	HK-AX-120A200-US	US	Input: 100-240V, 800mA, 47~63Hz Output: 12V, 2000mA DC output cable: 1.5m, unshielded
2	HON-KWANG	HK-AX-120A200-EU	EU	Input: 100-240V, 800mA, 47~63Hz Output: 12V, 2000mA DC output cable: 1.5m, unshielded
3	HON-KWANG	HK-AX-120A200-GB	UK	Input: 100-240V, 800mA, 47~63Hz Output: 12V, 2000mA DC output cable: 1.5m, unshielded
4	HON-KWANG	HK-AX-120A200-AU	AU	Input: 100-240V, 800mA, 47~63Hz Output: 12V, 2000mA DC output cable: 1.5m, unshielded
5	KTEC	KSASB0241200200HU	US	Input: 100-240V, 600mA, 47~63Hz Output: 12V, 2000mA DC output cable: 1.5m, unshielded
6	KTEC	KSASB0241200200HE	EU	Input: 100-240V, 600mA, 47~63Hz Output: 12V, 2000mA DC output cable: 1.5m, unshielded
7	KTEC	KSASB0241200200HK	UK	Input: 100-240V, 600mA, 47~63Hz Output: 12V, 2000mA DC output cable: 1.5m, unshielded
8	KTEC	KSASB0241200200HA	AU	Input: 100-240V, 600mA, 47~63Hz Output: 12V, 2000mA DC output cable: 1.5m, unshielded
Newly				
No	Brand	Model No.	Plug	Spec.
9	HON-KWANG	HK-AY-120A200-US	US	Input: 100-240V, 800mA, 47~63Hz Output: 12V, 2000mA DC output cable: 1.5m, unshielded

2. For U-NII-1Band: There is no increase in authorized power level, so RF test data refer to the original test report (Report No.:RF131223E02-1).
3. According to above conditions, all test items of U-NII-3 band need to be performed. And all data was verified to meet the requirements.
4. 2.4GHz and 5GHz technology can transmit at same time.

5. The antennas provided to the EUT, please refer to the following table:

Ant. No.	Transmitter Circuit	Gain (dBi) (Include cable loss)	Antenna Type	Connector Type	Frequency range (GHz to GHz)	Cable Length (mm)
1	Chain (0)	2.5	Dipole	i-pex (MHF)	2.4~2.4835	78
	Chain (2)	4.8			5.15~5.85	
2	Chain (1)	6	Dipole	i-pex (MHF)	2.4~2.4835	90
					5.15~5.85	
3	Chain (2)	5.5	Dipole	i-pex (MHF)	2.4~2.4835	185
	Chain (0)	6			5.15~5.85	

Note:

1. From above antennas, 802.11b mode will fix transmission on Chain (0).
 2. From above antennas, 802.11g mode the worst case was found in Chain (1).
 3. From above antennas, 802.11a mode the worst case was found in Chain (0).
- Therefore only the test data of the mode was recorded in this report.

6. The EUT incorporates a MIMO function.

MODULATION MODE	Tx/Rx FUNCTION
802.11a	1TX (Diversity) / 3RX
802.11b	1TX (Fixed Chain 0) / 3RX
802.11g	1TX (Diversity) / 3RX
802.11n (HT20)	3TX/3RX
802.11n (HT40)	3TX/3RX
802.11ac (VHT20)	3TX/3RX
802.11ac (VHT40)	3TX/3RX
802.11ac (VHT80)	3TX/3RX

Note: 1. The EUT support 2.4GHz band MIMO without beam forming function and 5GHz band MIMO with beam forming function.

2. The modulation and bandwidth are similar for 802.11n mode for 20MHz (40MHz) and 802.11ac mode for 20MHz (40MHz), therefore investigated worst case to representative mode in test report. (Final test mode refer section 3.2.1)

7. When the EUT operating in 802.11n, the software operation, which is defined by manufacturer, MCS (Modulation and Coding Schemes) from 0 to 23.
8. When the EUT operating in 802.11ac and support 256QAM of 802.11n (HT40) for 2.4GHz band, the software operation, which is defined by manufacturer, MCS (Modulation and Coding Schemes) from 0 to 9.
9. The above EUT information is declared by manufacturer and for more detailed features description, please refer to the manufacturer's specifications or user's manual.

3.2 Description of Test Modes

FOR 5180 ~ 5240MHz

4 channels are provided for 802.11a, 802.11n (HT20), 802.11ac (VHT20):

Channel	Frequency	Channel	Frequency
36	5180 MHz	44	5220 MHz
40	5200 MHz	48	5240 MHz

2 channels are provided for 802.11n (HT40), 802.11ac (VHT40):

Channel	Frequency	Channel	Frequency
38	5190 MHz	46	5230 MHz

1 channel is provided for 802.11ac (VHT80):

Channel	Frequency
42	5210MHz

FOR 5745 ~ 5825MHz:

5 channels are provided for 802.11a, 802.11n (HT20), 802.11ac (VHT20):

Channel	Frequency	Channel	Frequency
149	5745MHz	161	5805MHz
153	5765MHz	165	5825MHz
157	5785MHz		

2 channels are provided for 802.11n (HT40), 802.11ac (VHT40):

Channel	Frequency	Channel	Frequency
151	5755MHz	159	5795MHz

1 channel is provided for 802.11ac (VHT80):

Channel	Frequency
155	5775MHz

3.2.1 Test Mode Applicability and Tested Channel Detail

EUT CONFIGURE MODE	APPLICABLE TO				DESCRIPTION
	RE \geq 1G	RE $<$ 1G	PLC	APCM	
-	√	√	√	√	-

Where **RE \geq 1G**: Radiated Emission above 1GHz **RE $<$ 1G**: Radiated Emission below 1GHz
PLC: Power Line Conducted Emission **APCM**: Antenna Port Conducted Measurement

Radiated Emission Test (Above 1GHz):

- Pre-Scan has been conducted to determine the worst-case mode from all possible combinations between available modulations, data rates and antenna ports (if EUT with antenna diversity architecture).
- Following channel(s) was (were) selected for the final test as listed below.

CDD Mode						
MODE	FREQ. BAND (MHz)	AVAILABLE CHANNEL	TESTED CHANNEL	MODULATION TECHNOLOGY	MODULATION TYPE	DATA RATE (Mbps)
802.11a	5745-5825	149 to 165	149, 157, 165	OFDM	BPSK	6
Beamforming Mode						
MODE	FREQ. BAND (MHz)	AVAILABLE CHANNEL	TESTED CHANNEL	MODULATION TECHNOLOGY	MODULATION TYPE	DATA RATE (Mbps)
802.11ac (VHT20)	5745-5825	149 to 165	149, 157, 165	OFDM	BPSK	6.5
802.11ac (VHT40)		151 to 159	151, 159	OFDM	BPSK	13.5
802.11ac (VHT80)		155	155	OFDM	BPSK	29.5

Radiated Emission Test (Below 1GHz):

- Pre-Scan has been conducted to determine the worst-case mode from all possible combinations between available modulations, data rates and antenna ports (if EUT with antenna diversity architecture).
- Following channel(s) was (were) selected for the final test as listed below.

CDD Mode						
EUT CONFIGURE MODE	FREQ. BAND (MHz)	AVAILABLE CHANNEL	TESTED CHANNEL	MODULATION TECHNOLOGY	MODULATION TYPE	DATA RATE (Mbps)
802.11a	5180-5240 5745-5825	36 to 48 149 to 165	157	OFDM	BPSK	6

Power Line Conducted Emission Test:

- Pre-Scan has been conducted to determine the worst-case mode from all possible combinations between available modulations, data rates and antenna ports (if EUT with antenna diversity architecture).
- Following channel(s) was (were) selected for the final test as listed below.

CDD Mode						
EUT CONFIGURE MODE	FREQ. BAND (MHz)	AVAILABLE CHANNEL	TESTED CHANNEL	MODULATION TECHNOLOGY	MODULATION TYPE	DATA RATE (Mbps)
802.11a	5180-5240 5745-5825	36 to 48 149 to 165	157	OFDM	BPSK	6

Antenna Port Conducted Measurement:

- This item includes all test value of each mode, but only includes spectrum plot of worst value of each mode.
- Pre-Scan has been conducted to determine the worst-case mode from all possible combinations between available modulations, data rates and antenna ports (if EUT with antenna diversity architecture).
- Following channel(s) was (were) selected for the final test as listed below.

CDD Mode						
MODE	FREQ. BAND (MHz)	AVAILABLE CHANNEL	TESTED CHANNEL	MODULATION TECHNOLOGY	MODULATION TYPE	DATA RATE (Mbps)
802.11a	5745-5825	149 to 165	149, 157, 165	OFDM	BPSK	6
Beamforming Mode						
MODE	FREQ. BAND (MHz)	AVAILABLE CHANNEL	TESTED CHANNEL	MODULATION TECHNOLOGY	MODULATION TYPE	DATA RATE (Mbps)
802.11ac (VHT20)	5745-5825	149 to 165	149, 157, 165	OFDM	BPSK	6.5
802.11ac (VHT40)		151 to 159	151, 159	OFDM	BPSK	13.5
802.11ac (VHT80)		155	155	OFDM	BPSK	29.5

Test Condition:

APPLICABLE TO	ENVIRONMENTAL CONDITIONS	INPUT POWER	TESTED BY
RE \geq 1G	26deg. C, 70%RH	120Vac, 60Hz	Weiwei Lo
RE $<$ 1G	26deg. C, 70%RH	120Vac, 60Hz	Weiwei Lo
PLC	25deg. C, 56%RH	120Vac, 60Hz	Jason Huang
APCM	25deg. C, 60%RH	120Vac, 60Hz	Nelson Teng

3.3 Duty Cycle of Test Signal

If duty cycle of test signal is $\geq 98\%$, duty factor is not required.
 If duty cycle of test signal is $< 98\%$, duty factor shall be considered.

802.11a: Duty cycle = 2.064 ms/2.083 ms = 0.991

802.11ac (VHT20): Duty cycle = 1.926 ms/1.947 ms = 0.989

802.11ac (VHT40): Duty cycle = 0.954 ms/0.972 ms = 0.981

802.11ac (VHT80): Duty cycle = 0.458 ms/0.48 ms = 0.954, Duty factor = $10 * \log(1/0.954) = 0.20$

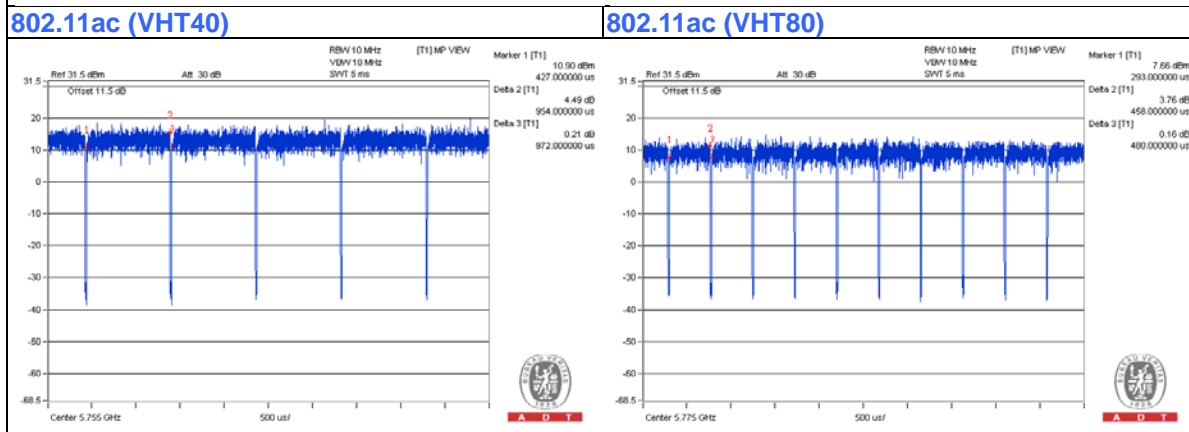
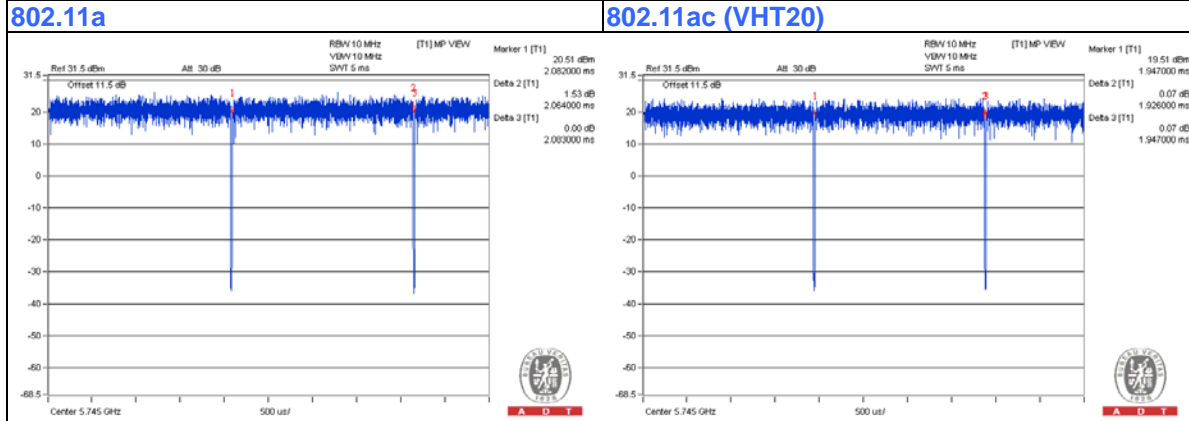

3.4 Description of Support Units

The EUT has been tested as an independent unit together with other necessary accessories or support units. The following support units or accessories were used to form a representative test configuration during the tests.

ID	Product	Brand	Model No.	Serial No.	FCC ID	Remarks
A.	iPod shuffle	Apple	MD778TA/A	CC4JMCMXF4T1	NA	Provided by Lab
B.	USB 3.0 dongle	NA	NA	NA	NA	Provided by Lab
C.	Notebook Computer	DELL	E6420	482T3R1	FCC DoC	Provided by Lab
D.	HUB	ZyXEL	ES-116P	S060H02000215	FCC DoC	Provided by Lab
E.	Notebook Computer	DELL	PP32LA	GSLB32S	FCC DoC	Provided by Lab

Note:

1. All power cords of the above support units are non-shielded (1.8m).
2. Items E~F acted as communication partners to transfer data.

ID	Descriptions	Qty.	Length (m)	Shielding (Yes/No)	Cores (Qty.)	Remarks
1.	DC	1	1.5	No	0	Supplied by Client
2.	RJ45	1	10	No	0	Provided by Lab
3.	RJ45	3	10	No	0	Provided by Lab
4.	RJ45	1	10	No	0	Provided by Lab
5.	USB	1	0.1	Yes	0	Provided by Lab

3.4.1 Configuration of System under Test

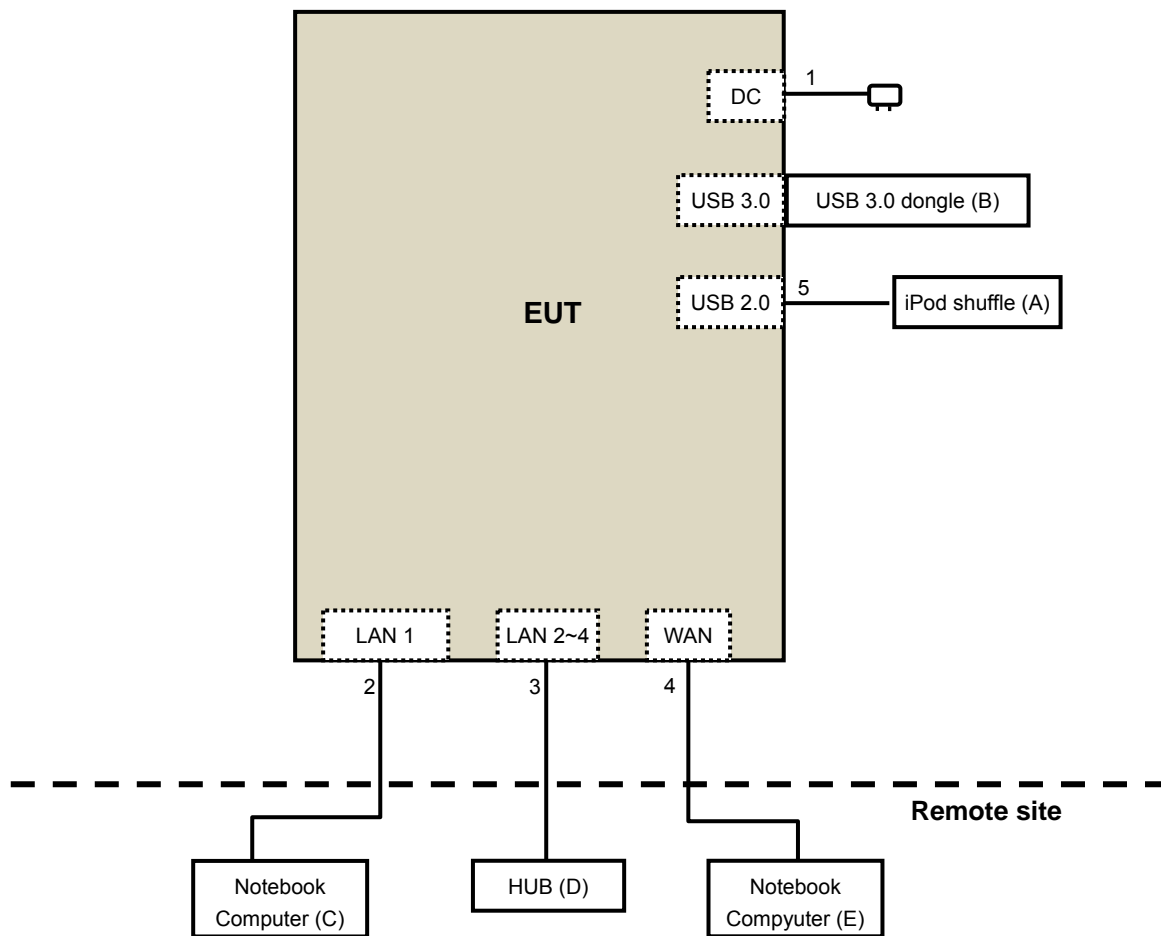

3.5 General Description of Applied Standard

The EUT is a RF Product. According to the specifications of the manufacturer, it must comply with the requirements of the following standards:

FCC Part 15, Subpart E (15.407)
KDB 789033 D02 General UNII Test Procedure New Rules v01
KDB 662911 D01 Multiple Transmitter Output v02r01
ANSI C63.10-2013

All test items have been performed and recorded as per the above standards.

NOTE: The EUT has been verified to comply with the requirements of FCC Part 15, Subpart B, Class B (DoC). The test report has been issued separately.

4 Test Types and Results

4.1 Radiated Emission and Bandedge Measurement

4.1.1 Limits of Radiated Emission and Bandedge Measurement

Radiated emissions which fall in the restricted bands must comply with the radiated emission limits specified as below table.

Frequencies (MHz)	Field Strength (microvolts/meter)	Measurement Distance (meters)
0.009 ~ 0.490	2400/F(kHz)	300
0.490 ~ 1.705	24000/F(kHz)	30
1.705 ~ 30.0	30	30
30 ~ 88	100	3
88 ~ 216	150	3
216 ~ 960	200	3
Above 960	500	3

NOTE:

1. The lower limit shall apply at the transition frequencies.
2. Emission level (dBuV/m) = 20 log Emission level (uV/m).
3. For frequencies above 1000MHz, the field strength limits are based on average detector, however, the peak field strength of any emission shall not exceed the maximum permitted average limits, specified above by more than 20dB under any condition of modulation.

LIMITS OF UNWANTED EMISSION OUT OF THE RESTRICTED BANDS

APPLICABLE TO	LIMIT	
789033 D02 General UNII Test Procedure New Rules v01	FIELD STRENGTH AT 3m	
	PK:74 (dBuV/m)	AV:54 (dBuV/m)
APPLICABLE TO	EIRP LIMIT	EQUIVALENT FIELD STRENGTH AT 3m
15.407(b)(1)	PK:-27 (dBm/MHz)	PK:68.2(dBuV/m)
15.407(b)(2)		
15.407(b)(3)		
15.407(b)(4)	PK:-27 (dBm/MHz) ^{*1} PK:-17 (dBm/MHz) ^{*2}	PK: 68.2(dBuV/m) ^{*1} PK:78.2 (dBuV/m) ^{*2}

NOTE: ^{*1} beyond 10MHz of the band edge ^{*2} within 10 MHz of band edge

The following formula is used to convert the equipment isotropic radiated power (eirp) to field strength:

$$E = \frac{1000000\sqrt{30P}}{3} \mu\text{V/m, where P is the eirp (Watts).$$

4.1.2 Test Instruments

DESCRIPTION & MANUFACTURER	MODEL NO.	SERIAL NO.	CALIBRATED DATE	CALIBRATED UNTIL
Test Receiver Agilent	N9038A	MY51210105	July 24, 2015	July 23, 2016
Pre-Amplifier(*) EMCI	EMC001340	980142	Jan. 13, 2014	Jan. 12, 2016
Loop Antenna(*) Electro-Metrics	EM-6879	264	Dec. 16, 2014	Dec. 15, 2016
RF Cable	NA	LOOPCAB-00 1 LOOPCAB-00 2	Jan. 18, 2015	Jan. 17, 2016
Pre-Amplifier Mini-Circuits	ZFL-1000VH2 B	AMP-ZFL-03	Nov. 12, 2014	Nov. 11, 2015
Trilog Broadband Antenna SCHWARZBECK	VULB 9168	9168-360	Feb. 06, 2015	Feb. 05, 2016
RF Cable	8D-FB	CHGCAB-001 -1 CHGCAB-001 -2	Oct. 03, 2015	Oct. 02, 2016
	RF-141	CHGCAB-004	Oct. 03, 2015	Oct. 02, 2016
Horn_Antenna AISI	AIH.8018	000032009111 0	Feb. 09, 2015	Feb. 08, 2016
Pre-Amplifier Agilent	8449B	3008A02578	June 23, 2015	June 22, 2016
RF Cable	NA	131205 131216 131217 SNMY23684/ 4	Jan. 16, 2015	Jan. 15, 2016
Spectrum Analyzer R&S	FSV40	100964	June 26, 2015	June 25, 2016
Pre-Amplifier SPACEK LABS	SLKKa-48-6	9K16	Dec. 12, 2014	Dec. 11, 2015
Horn_Antenna SCHWARZBECK	BBHA 9170	9170-424	Feb. 05, 2015	Feb. 04, 2016
RF Cable	NA	329751/4 RF104-204	Dec. 11, 2014	Dec. 10, 2015
Software	ADT_Radiated _V8.7.07	NA	NA	NA
Antenna Tower & Turn Table CT	NA	NA	NA	NA
Power Meter Anritsu	ML2495A	1014008	Apr. 28, 2015	Apr. 27, 2016
Power Sensor Anritsu	MA2411B	0917122	Apr. 28, 2015	Apr. 27, 2016
spectrum analyzer R&S	FSP40	100060	May 08, 2015	May 07, 2016
Temperature & Humidity Chamber GIANTFORCE	GTH-150-40-S P-AR	MAA0812-00 8	Jan. 12, 2015	Jan. 11, 2016

**Note:**

1. The calibration interval of the above test instruments is 12 months and the calibrations are traceable to NML/ROC and NIST/USA.
2. *The calibration interval of the above test instruments is 24 months and the calibrations are traceable to NML/ROC and NIST/USA.
3. Loop antenna was used for all emissions below 30 MHz.
4. The test was performed in 966 Chamber No. G.
5. The FCC Site Registration No. is 966073.
- 6 The CANADA Site Registration No. is IC 7450H-2.
7. Tested Date: Nov. 04 to 06, 2015

4.1.3 Test Procedure

- a. The EUT was placed on the top of a rotating table 0.8 meters (for below 1GHz) / 1.5 meters (for above 1GHz) above the ground at 3 meter chamber room for test. The table was rotated 360 degrees to determine the position of the highest radiation.
- b. The EUT was set 3 meters away from the interference-receiving antenna, which was mounted on the top of a variable-height antenna tower.
- c. The height of antenna is varied from one meter to four meters above the ground to determine the maximum value of the field strength. Both horizontal and vertical polarizations of the antenna are set to make the measurement.
- d. For each suspected emission, the EUT was arranged to its worst case and then the antenna was tuned to heights from 1 meter to 4 meters and the rotatable table was turned from 0 degrees to 360 degrees to find the maximum reading.
- e. The test-receiver system was set to quasi-peak detect function and specified bandwidth with maximum hold mode when the test frequency is below 1 GHz.
- f. The test-receiver system was set to peak and average detect function and specified bandwidth with maximum hold mode when the test frequency is above 1 GHz. If the peak reading value also meets average limit, measurement with the average detector is unnecessary.

Note:

1. The resolution bandwidth and video bandwidth of test receiver/spectrum analyzer is 120kHz for Quasi-peak detection (QP) at frequency below 1GHz.
2. The resolution bandwidth of test receiver/spectrum analyzer is 1 MHz and the video bandwidth is 3 MHz for Peak detection (PK) at frequency above 1GHz.
3. The resolution bandwidth of test receiver/spectrum analyzer is 1MHz and the video bandwidth is 3MHz for RMS Average (Duty cycle < 98%) for Average detection (AV) at frequency above 1GHz, then the measurement results was added to a correction factor ($10 \log(1/\text{duty cycle})$).
4. The resolution bandwidth of test receiver/spectrum analyzer is 1MHz and the video bandwidth is 10Hz (Duty cycle $\geq 98\%$) for Average detection (AV) at frequency above 1GHz.
5. All modes of operation were investigated and the worst-case emissions are reported.

4.1.4 Deviation from Test Standard

No deviation.

4.1.5 Test Setup

<Frequency Range below 1GHz>

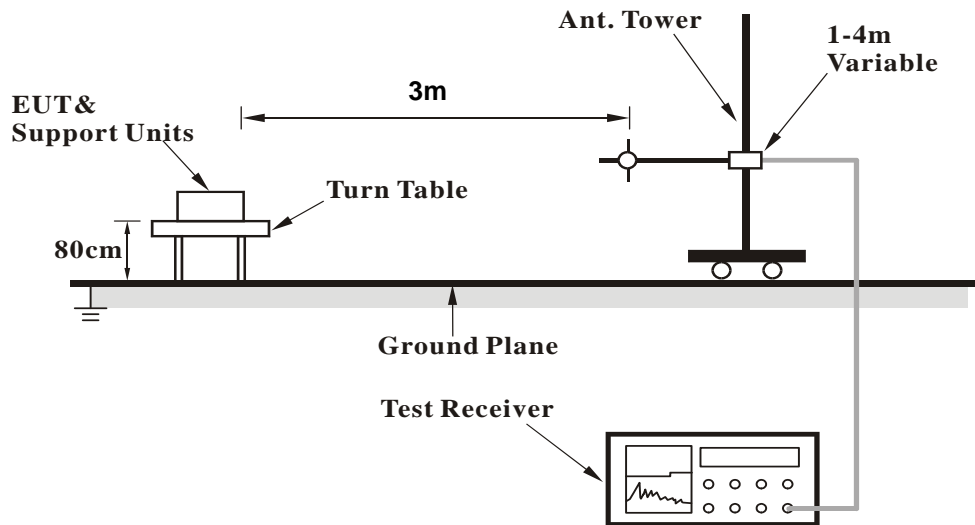

<Frequency Range above 1GHz>

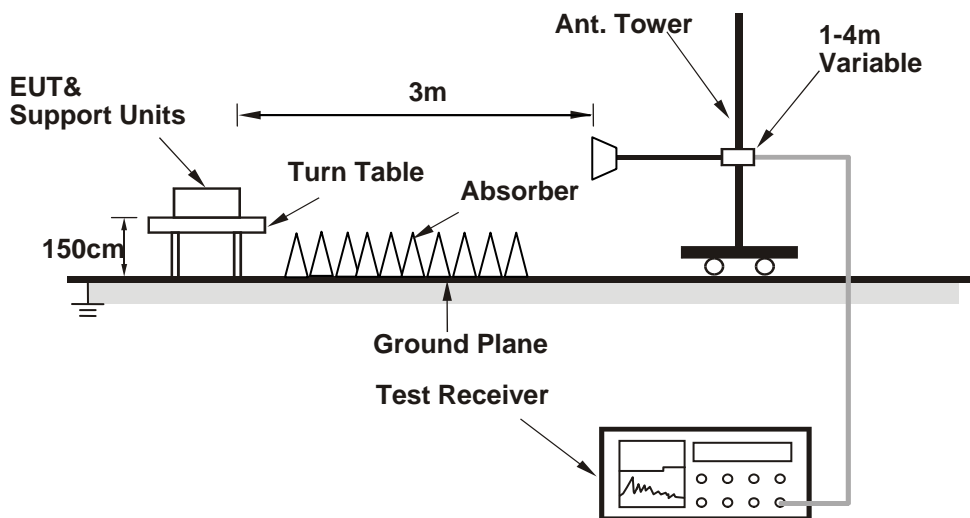

For the actual test configuration, please refer to the attached file (Test Setup Photo).

4.1.6 EUT Operating Condition

1. Place the EUT on testing table.
2. Prepare computer system (support unit C) to act as communication partner.
3. The communication partner runs test program "Mtool_2.0.1.0.exe" to enable EUT under transmission/receiving condition continuously at specific channel frequency.

4.1.7 Test Results

Above 1GHz Data:

802.11a

CHANNEL	TX Channel 149	DETECTOR FUNCTION	Peak (PK)
FREQUENCY RANGE	1GHz ~ 40GHz		Average (AV)

ANTENNA POLARITY & TEST DISTANCE: HORIZONTAL AT 3 M								
NO.	FREQ. (MHz)	EMISSION LEVEL (dBuV/m)	LIMIT (dBuV/m)	MARGIN (dB)	ANTENNA HEIGHT (m)	TABLE ANGLE (Degree)	RAW VALUE (dBuV)	CORRECTION FACTOR (dB/m)
1	#5715.00	59.2 PK	74.0	-14.8	2.30 H	218	47.67	11.53
2	#5715.00	42.1 AV	54.0	-11.9	2.30 H	218	30.57	11.53
3	#5725.00	69.2 PK	78.2	-9.0	2.30 H	218	57.65	11.55
4	*5745.00	104.1 PK			2.30 H	218	92.47	11.63
5	*5745.00	94.2 AV			2.30 H	218	82.57	11.63
6	11490.00	66.0 PK	74.0	-8.0	1.14 H	104	48.70	17.30
7	11490.00	53.0 AV	54.0	-1.0	1.14 H	104	35.70	17.30
8	#17235.00	61.0 PK	74.0	-13.0	1.11 H	100	34.19	26.81
9	#17235.00	49.0 AV	54.0	-5.0	1.11 H	100	22.19	26.81

ANTENNA POLARITY & TEST DISTANCE: VERTICAL AT 3 M								
NO.	FREQ. (MHz)	EMISSION LEVEL (dBuV/m)	LIMIT (dBuV/m)	MARGIN (dB)	ANTENNA HEIGHT (m)	TABLE ANGLE (Degree)	RAW VALUE (dBuV)	CORRECTION FACTOR (dB/m)
1	#5715.00	65.6 PK	74.0	-8.4	1.87 V	159	54.07	11.53
2	#5715.00	47.9 AV	54.0	-6.1	1.87 V	159	36.37	11.53
3	#5725.00	77.5 PK	78.2	-0.7	1.87 V	159	65.95	11.55
4	*5745.00	111.4 PK			1.87 V	159	99.77	11.63
5	*5745.00	101.6 AV			1.87 V	159	89.97	11.63
6	11490.00	56.0 PK	74.0	-18.0	1.27 V	264	38.70	17.30
7	11490.00	44.3 AV	54.0	-9.7	1.27 V	264	27.00	17.30
8	#17235.00	59.9 PK	74.0	-14.1	1.40 V	110	33.09	26.81
9	#17235.00	47.7 AV	54.0	-6.3	1.40 V	110	20.89	26.81

REMARKS:

1. Emission Level(dBuV/m) = Raw Value(dBuV) + Correction Factor(dB/m)
2. Correction Factor(dB/m) = Antenna Factor(dB/m) + Cable Factor(dB) – Pre-Amplifier Factor(dB)
3. The other emission levels were very low against the limit.
4. Margin value = Emission Level – Limit value
5. " * ": Fundamental frequency.
6. " # ": The radiated frequency is out of the restricted band.

CHANNEL	TX Channel 157	DETECTOR FUNCTION	Peak (PK)
FREQUENCY RANGE	1GHz ~ 40GHz		Average (AV)

ANTENNA POLARITY & TEST DISTANCE: HORIZONTAL AT 3 M

NO.	FREQ. (MHz)	EMISSION LEVEL (dBuV/m)	LIMIT (dBuV/m)	MARGIN (dB)	ANTENNA HEIGHT (m)	TABLE ANGLE (Degree)	RAW VALUE (dBuV)	CORRECTION FACTOR (dB/m)
1	#5704.00	58.4 PK	68.2	-9.8	1.12 H	105	46.91	11.49
2	#5725.00	57.3 PK	78.2	-20.9	2.29 H	233	45.75	11.55
3	*5785.00	109.8 PK			2.34 H	225	98.06	11.74
4	*5785.00	99.4 AV			2.34 H	225	87.66	11.74
5	#5850.00	61.5 PK	78.2	-16.7	1.11 H	96	49.75	11.75
6	#5864.00	61.1 PK	68.2	-7.1	2.34 H	211	49.35	11.75
7	11570.00	66.4 PK	74.0	-7.6	1.10 H	102	48.49	17.91
8	11570.00	53.4 AV	54.0	-0.6	1.10 H	102	35.49	17.91
9	#17355.00	63.3 PK	74.0	-10.7	1.10 H	106	36.16	27.14
10	#17355.00	51.6 AV	54.0	-2.4	1.10 H	106	24.46	27.14

ANTENNA POLARITY & TEST DISTANCE: VERTICAL AT 3 M

NO.	FREQ. (MHz)	EMISSION LEVEL (dBuV/m)	LIMIT (dBuV/m)	MARGIN (dB)	ANTENNA HEIGHT (m)	TABLE ANGLE (Degree)	RAW VALUE (dBuV)	CORRECTION FACTOR (dB/m)
1	#5704.00	67.2 PK	68.2	-1.0	1.94 V	161	55.71	11.49
2	#5725.00	65.2 PK	78.2	-13.0	1.94 V	161	53.65	11.55
3	*5785.00	117.2 PK			1.94 V	161	105.46	11.74
4	*5785.00	107.2 AV			1.94 V	161	95.46	11.74
5	#5850.00	67.2 PK	78.2	-11.0	1.94 V	161	55.45	11.75
6	#5864.00	67.3 PK	68.2	-0.9	1.94 V	161	55.55	11.75
7	11570.00	62.2 PK	74.0	-11.8	1.63 V	266	44.29	17.91
8	11570.00	50.0 AV	54.0	-4.0	1.63 V	266	32.09	17.91
9	#17355.00	63.3 PK	74.0	-10.7	1.63 V	270	36.16	27.14
10	#17355.00	51.5 AV	54.0	-2.5	1.63 V	270	24.36	27.14

REMARKS:

- Emission Level(dBuV/m) = Raw Value(dBuV) + Correction Factor(dB/m)
- Correction Factor(dB/m) = Antenna Factor(dB/m) + Cable Factor(dB) – Pre-Amplifier Factor(dB)
- The other emission levels were very low against the limit.
- Margin value = Emission Level – Limit value
- " * ": Fundamental frequency.
- " # ": The radiated frequency is out of the restricted band.

CHANNEL	TX Channel 165	DETECTOR FUNCTION	Peak (PK)
FREQUENCY RANGE	1GHz ~ 40GHz		Average (AV)

ANTENNA POLARITY & TEST DISTANCE: HORIZONTAL AT 3 M

NO.	FREQ. (MHz)	EMISSION LEVEL (dBuV/m)	LIMIT (dBuV/m)	MARGIN (dB)	ANTENNA HEIGHT (m)	TABLE ANGLE (Degree)	RAW VALUE (dBuV)	CORRECTION FACTOR (dB/m)
1	*5825.00	111.8 PK			1.58 H	360	100.02	11.78
2	*5825.00	100.8 AV			1.58 H	360	89.02	11.78
3	#5850.00	69.1 PK	78.2	-9.1	1.58 H	349	57.35	11.75
4	#5904.00	60.8 PK	68.2	-7.4	1.19 H	121	49.05	11.75
5	11650.00	66.5 PK	74.0	-7.5	1.15 H	118	48.34	18.16
6	11650.00	53.2 AV	54.0	-0.8	1.15 H	118	35.04	18.16
7	#17475.00	63.0 PK	74.0	-11.0	1.10 H	113	35.08	27.92
8	#17475.00	51.5 AV	54.0	-2.5	1.10 H	113	23.58	27.92

ANTENNA POLARITY & TEST DISTANCE: VERTICAL AT 3 M

NO.	FREQ. (MHz)	EMISSION LEVEL (dBuV/m)	LIMIT (dBuV/m)	MARGIN (dB)	ANTENNA HEIGHT (m)	TABLE ANGLE (Degree)	RAW VALUE (dBuV)	CORRECTION FACTOR (dB/m)
1	*5825.00	116.6 PK			1.90 V	163	104.82	11.78
2	*5825.00	107.1 AV			1.90 V	163	95.32	11.78
3	#5850.00	77.6 PK	78.2	-0.6	1.90 V	163	65.85	11.75
4	#5904.00	66.1 PK	68.2	-2.1	1.90 V	163	54.35	11.75
5	11650.00	62.5 PK	74.0	-11.5	1.66 V	279	44.34	18.16
6	11650.00	50.0 AV	54.0	-4.0	1.66 V	279	31.84	18.16
7	#17475.00	63.6 PK	74.0	-10.4	1.63 V	254	35.68	27.92
8	#17475.00	51.7 AV	54.0	-2.3	1.63 V	254	23.78	27.92

REMARKS:

1. Emission Level(dBuV/m) = Raw Value(dBuV) + Correction Factor(dB/m)
2. Correction Factor(dB/m) = Antenna Factor(dB/m) + Cable Factor(dB) – Pre-Amplifier Factor(dB)
3. The other emission levels were very low against the limit.
4. Margin value = Emission Level – Limit value
5. " * ": Fundamental frequency.
6. " # ": The radiated frequency is out of the restricted band.

802.11ac (VHT20)

CHANNEL	TX Channel 149	DETECTOR FUNCTION	Peak (PK)
FREQUENCY RANGE	1GHz ~ 40GHz		Average (AV)

ANTENNA POLARITY & TEST DISTANCE: HORIZONTAL AT 3 M

NO.	FREQ. (MHz)	EMISSION LEVEL (dBuV/m)	LIMIT (dBuV/m)	MARGIN (dB)	ANTENNA HEIGHT (m)	TABLE ANGLE (Degree)	RAW VALUE (dBuV)	CORRECTION FACTOR (dB/m)
1	#5715.00	64.1 PK	74.0	-9.9	1.58 H	360	52.57	11.53
2	#5715.00	42.0 AV	54.0	-12.0	1.58 H	360	30.47	11.53
3	#5725.00	75.3 PK	78.2	-2.9	1.58 H	360	63.75	11.55
4	*5745.00	106.5 PK			1.59 H	360	94.87	11.63
5	*5745.00	97.5 AV			1.59 H	360	85.87	11.63
6	11490.00	66.4 PK	74.0	-7.6	1.69 H	302	49.10	17.30
7	11490.00	53.0 AV	54.0	-1.0	1.69 H	302	35.70	17.30
8	#17235.00	59.9 PK	74.0	-14.1	1.03 H	223	33.09	26.81
9	#17235.00	48.2 AV	54.0	-5.8	1.03 H	223	21.39	26.81

ANTENNA POLARITY & TEST DISTANCE: VERTICAL AT 3 M

NO.	FREQ. (MHz)	EMISSION LEVEL (dBuV/m)	LIMIT (dBuV/m)	MARGIN (dB)	ANTENNA HEIGHT (m)	TABLE ANGLE (Degree)	RAW VALUE (dBuV)	CORRECTION FACTOR (dB/m)
1	#5715.00	62.2 PK	74.0	-11.8	1.36 V	176	50.67	11.53
2	#5715.00	48.0 AV	54.0	-6.0	1.36 V	176	36.47	11.53
3	#5725.00	78.1 PK	78.2	-0.1	1.36 V	176	66.55	11.55
4	*5745.00	113.5 PK			1.36 V	176	101.87	11.63
5	*5745.00	104.3 AV			1.36 V	176	92.67	11.63
6	11490.00	55.6 PK	74.0	-18.4	1.19 V	268	38.30	17.30
7	11490.00	43.8 AV	54.0	-10.2	1.19 V	268	26.50	17.30
8	#17235.00	60.4 PK	74.0	-13.6	1.47 V	98	33.59	26.81
9	#17235.00	48.3 AV	54.0	-5.7	1.47 V	98	21.49	26.81

REMARKS:

- Emission Level(dBuV/m) = Raw Value(dBuV) + Correction Factor(dB/m)
- Correction Factor(dB/m) = Antenna Factor(dB/m) + Cable Factor(dB) – Pre-Amplifier Factor(dB)
- The other emission levels were very low against the limit.
- Margin value = Emission Level – Limit value
- " * ": Fundamental frequency.
- " # ": The radiated frequency is out of the restricted band.

CHANNEL	TX Channel 157	DETECTOR FUNCTION	Peak (PK)
FREQUENCY RANGE	1GHz ~ 40GHz		Average (AV)

ANTENNA POLARITY & TEST DISTANCE: HORIZONTAL AT 3 M

NO.	FREQ. (MHz)	EMISSION LEVEL (dBuV/m)	LIMIT (dBuV/m)	MARGIN (dB)	ANTENNA HEIGHT (m)	TABLE ANGLE (Degree)	RAW VALUE (dBuV)	CORRECTION FACTOR (dB/m)
1	*5785.00	106.7 PK			1.65 H	360	94.96	11.74
2	*5785.00	97.8 AV			1.65 H	360	86.06	11.74
3	11570.00	66.2 PK	74.0	-7.8	1.64 H	287	48.29	17.91
4	11570.00	53.8 AV	54.0	-0.2	1.64 H	287	35.89	17.91
5	#17355.00	59.3 PK	74.0	-14.7	1.00 H	215	32.16	27.14
6	#17355.00	47.8 AV	54.0	-6.2	1.00 H	215	20.66	27.14

ANTENNA POLARITY & TEST DISTANCE: VERTICAL AT 3 M

NO.	FREQ. (MHz)	EMISSION LEVEL (dBuV/m)	LIMIT (dBuV/m)	MARGIN (dB)	ANTENNA HEIGHT (m)	TABLE ANGLE (Degree)	RAW VALUE (dBuV)	CORRECTION FACTOR (dB/m)
1	*5785.00	113.7 PK			1.32 V	184	101.96	11.74
2	*5785.00	104.7 AV			1.32 V	184	92.96	11.74
3	11570.00	56.2 PK	74.0	-17.8	1.25 V	270	38.29	17.91
4	11570.00	44.3 AV	54.0	-9.7	1.25 V	270	26.39	17.91
5	#17355.00	60.1 PK	74.0	-13.9	1.45 V	100	32.96	27.14
6	#17355.00	47.9 AV	54.0	-6.1	1.45 V	100	20.76	27.14

REMARKS:

1. Emission Level(dBuV/m) = Raw Value(dBuV) + Correction Factor(dB/m)
2. Correction Factor(dB/m) = Antenna Factor(dB/m) + Cable Factor(dB) – Pre-Amplifier Factor(dB)
3. The other emission levels were very low against the limit.
4. Margin value = Emission Level – Limit value
5. " * ": Fundamental frequency.
6. " # ": The radiated frequency is out of the restricted band.

CHANNEL	TX Channel 165	DETECTOR FUNCTION	Peak (PK)
FREQUENCY RANGE	1GHz ~ 40GHz		Average (AV)

ANTENNA POLARITY & TEST DISTANCE: HORIZONTAL AT 3 M

NO.	FREQ. (MHz)	EMISSION LEVEL (dBuV/m)	LIMIT (dBuV/m)	MARGIN (dB)	ANTENNA HEIGHT (m)	TABLE ANGLE (Degree)	RAW VALUE (dBuV)	CORRECTION FACTOR (dB/m)
1	*5825.00	107.1 PK			1.67 H	360	95.32	11.78
2	*5825.00	98.6 AV			1.67 H	360	86.82	11.78
3	#5850.00	64.0 PK	78.2	-14.2	1.53 H	345	52.25	11.75
4	#5905.00	60.3 PK	68.2	-7.9	1.57 H	360	48.55	11.75
5	11650.00	66.0 PK	74.0	-8.0	1.60 H	292	47.84	18.16
6	11650.00	53.2 AV	54.0	-0.8	1.60 H	292	35.04	18.16
7	#17475.00	59.9 PK	74.0	-14.1	1.00 H	211	31.98	27.92
8	#17475.00	48.1 AV	54.0	-5.9	1.00 H	211	20.18	27.92

ANTENNA POLARITY & TEST DISTANCE: VERTICAL AT 3 M

NO.	FREQ. (MHz)	EMISSION LEVEL (dBuV/m)	LIMIT (dBuV/m)	MARGIN (dB)	ANTENNA HEIGHT (m)	TABLE ANGLE (Degree)	RAW VALUE (dBuV)	CORRECTION FACTOR (dB/m)
1	*5825.00	115.7 PK			1.18 V	169	103.92	11.78
2	*5825.00	107.2 AV			1.18 V	169	95.42	11.78
3	#5850.00	77.9 PK	78.2	-0.3	1.18 V	169	66.15	11.75
4	#5905.00	65.7 PK	68.2	-2.5	1.30 V	194	53.95	11.75
5	11650.00	56.5 PK	74.0	-17.5	1.26 V	285	38.34	18.16
6	11650.00	44.3 AV	54.0	-9.7	1.26 V	285	26.14	18.16
7	#17475.00	59.9 PK	74.0	-14.1	1.42 V	107	31.98	27.92
8	#17475.00	47.9 AV	54.0	-6.1	1.42 V	107	19.98	27.92

REMARKS:

1. Emission Level(dBuV/m) = Raw Value(dBuV) + Correction Factor(dB/m)
2. Correction Factor(dB/m) = Antenna Factor(dB/m) + Cable Factor(dB) – Pre-Amplifier Factor(dB)
3. The other emission levels were very low against the limit.
4. Margin value = Emission Level – Limit value
5. " * ": Fundamental frequency.
6. " # ": The radiated frequency is out of the restricted band.

802.11ac (VHT40)

CHANNEL	TX Channel 151	DETECTOR FUNCTION	Peak (PK)
FREQUENCY RANGE	1GHz ~ 40GHz		Average (AV)

ANTENNA POLARITY & TEST DISTANCE: HORIZONTAL AT 3 M

NO.	FREQ. (MHz)	EMISSION LEVEL (dBuV/m)	LIMIT (dBuV/m)	MARGIN (dB)	ANTENNA HEIGHT (m)	TABLE ANGLE (Degree)	RAW VALUE (dBuV)	CORRECTION FACTOR (dB/m)
1	#5715.00	63.2 PK	74.0	-10.8	1.48 H	350	51.67	11.53
2	#5715.00	48.6 AV	54.0	-5.4	1.48 H	350	37.07	11.53
3	#5725.00	66.2 PK	78.2	-12.0	1.56 H	360	54.65	11.55
4	*5755.00	100.3 PK			1.63 H	360	88.66	11.64
5	*5755.00	90.5 AV			1.63 H	360	78.86	11.64
6	11510.00	56.2 PK	74.0	-17.8	1.22 H	304	38.90	17.30
7	11510.00	43.8 AV	54.0	-10.2	1.22 H	304	26.50	17.30
8	#17265.00	60.4 PK	74.0	-13.6	1.49 H	93	33.69	26.71
9	#17265.00	48.5 AV	54.0	-5.5	1.49 H	93	21.79	26.71

ANTENNA POLARITY & TEST DISTANCE: VERTICAL AT 3 M

NO.	FREQ. (MHz)	EMISSION LEVEL (dBuV/m)	LIMIT (dBuV/m)	MARGIN (dB)	ANTENNA HEIGHT (m)	TABLE ANGLE (Degree)	RAW VALUE (dBuV)	CORRECTION FACTOR (dB/m)
1	#5715.00	69.2 PK	74.0	-4.8	1.40 V	194	57.67	11.53
2	#5715.00	53.6 AV	54.0	-0.4	1.40 V	194	42.07	11.53
3	#5725.00	74.2 PK	78.2	-4.0	1.40 V	194	62.65	11.55
4	*5755.00	109.2 PK			1.39 V	189	97.56	11.64
5	*5755.00	98.6 AV			1.39 V	189	86.96	11.64
6	11510.00	56.1 PK	74.0	-17.9	1.21 V	298	38.80	17.30
7	11510.00	44.0 AV	54.0	-10.0	1.21 V	298	26.70	17.30
8	#17265.00	60.3 PK	74.0	-13.7	1.44 V	119	33.59	26.71
9	#17265.00	48.2 AV	54.0	-5.8	1.44 V	119	21.49	26.71

REMARKS:

- Emission Level(dBuV/m) = Raw Value(dBuV) + Correction Factor(dB/m)
- Correction Factor(dB/m) = Antenna Factor(dB/m) + Cable Factor(dB) – Pre-Amplifier Factor(dB)
- The other emission levels were very low against the limit.
- Margin value = Emission Level – Limit value
- " * ": Fundamental frequency.
- " # ": The radiated frequency is out of the restricted band.

CHANNEL	TX Channel 159	DETECTOR FUNCTION	Peak (PK)
FREQUENCY RANGE	1GHz ~ 40GHz		Average (AV)

ANTENNA POLARITY & TEST DISTANCE: HORIZONTAL AT 3 M

NO.	FREQ. (MHz)	EMISSION LEVEL (dBuV/m)	LIMIT (dBuV/m)	MARGIN (dB)	ANTENNA HEIGHT (m)	TABLE ANGLE (Degree)	RAW VALUE (dBuV)	CORRECTION FACTOR (dB/m)
1	*5795.00	105.3 PK			1.69 H	360	93.52	11.78
2	*5795.00	95.2 AV			1.69 H	360	83.42	11.78
3	#5850.00	66.5 PK	78.2	-11.7	1.51 H	360	54.75	11.75
4	#5860.00	62.7 PK	74.0	-11.3	1.46 H	350	50.95	11.75
5	#5860.00	48.2 AV	54.0	-5.8	1.46 H	350	36.45	11.75
6	11590.00	56.1 PK	74.0	-17.9	1.22 H	318	37.99	18.11
7	11590.00	44.0 AV	54.0	-10.0	1.22 H	318	25.89	18.11
8	#17385.00	60.6 PK	74.0	-13.4	1.53 H	109	33.15	27.45
9	#17385.00	48.5 AV	54.0	-5.5	1.53 H	109	21.05	27.45

ANTENNA POLARITY & TEST DISTANCE: VERTICAL AT 3 M

NO.	FREQ. (MHz)	EMISSION LEVEL (dBuV/m)	LIMIT (dBuV/m)	MARGIN (dB)	ANTENNA HEIGHT (m)	TABLE ANGLE (Degree)	RAW VALUE (dBuV)	CORRECTION FACTOR (dB/m)
1	*5795.00	113.5 PK			1.24 V	182	101.72	11.78
2	*5795.00	103.5 AV			1.24 V	182	91.72	11.78
3	#5850.00	70.3 PK	78.2	-7.9	1.24 V	182	58.55	11.75
4	#5860.00	67.8 PK	74.0	-6.2	1.24 V	182	56.05	11.75
5	#5860.00	53.9 AV	54.0	-0.1	1.24 V	182	42.15	11.75
6	11590.00	56.5 PK	74.0	-17.5	1.27 V	294	38.39	18.11
7	11590.00	44.3 AV	54.0	-9.7	1.27 V	294	26.19	18.11
8	#17385.00	60.5 PK	74.0	-13.5	1.41 V	99	33.05	27.45
9	#17385.00	48.4 AV	54.0	-5.6	1.41 V	99	20.95	27.45

REMARKS:

1. Emission Level(dBuV/m) = Raw Value(dBuV) + Correction Factor(dB/m)
2. Correction Factor(dB/m) = Antenna Factor(dB/m) + Cable Factor(dB) – Pre-Amplifier Factor(dB)
3. The other emission levels were very low against the limit.
4. Margin value = Emission Level – Limit value
5. " * ": Fundamental frequency.
6. " # ": The radiated frequency is out of the restricted band.

802.11ac (VHT80)

CHANNEL	TX Channel 155	DETECTOR FUNCTION	Peak (PK)
FREQUENCY RANGE	1GHz ~ 40GHz		Average (AV)

ANTENNA POLARITY & TEST DISTANCE: HORIZONTAL AT 3 M

NO.	FREQ. (MHz)	EMISSION LEVEL (dBuV/m)	LIMIT (dBuV/m)	MARGIN (dB)	ANTENNA HEIGHT (m)	TABLE ANGLE (Degree)	RAW VALUE (dBuV)	CORRECTION FACTOR (dB/m)
1	#5715.00	63.3 PK	74.0	-10.7	1.45 H	360	51.77	11.53
2	#5715.00	48.8 AV	54.0	-5.2	1.45 H	360	37.27	11.53
3	#5725.00	66.3 PK	78.2	-11.9	1.59 H	360	54.75	11.55
4	*5775.00	100.3 PK			1.67 H	360	88.58	11.72
5	*5775.00	90.8 AV			1.67 H	360	79.08	11.72
6	#5850.00	60.3 PK	78.2	-17.9	1.47 H	360	48.55	11.75
7	#5860.00	57.3 PK	74.0	-16.7	1.51 H	342	45.55	11.75
8	#5860.00	41.2 AV	54.0	-12.8	1.51 H	342	29.45	11.75
9	11550.00	55.8 PK	74.0	-18.2	1.25 H	334	38.09	17.71
10	11550.00	43.6 AV	54.0	-10.4	1.25 H	334	25.89	17.71
11	#17325.00	60.8 PK	74.0	-13.2	1.56 H	121	33.95	26.85
12	#17325.00	48.7 AV	54.0	-5.3	1.56 H	121	21.85	26.85

ANTENNA POLARITY & TEST DISTANCE: VERTICAL AT 3 M

NO.	FREQ. (MHz)	EMISSION LEVEL (dBuV/m)	LIMIT (dBuV/m)	MARGIN (dB)	ANTENNA HEIGHT (m)	TABLE ANGLE (Degree)	RAW VALUE (dBuV)	CORRECTION FACTOR (dB/m)
1	#5715.00	71.6 PK	74.0	-2.4	1.05 V	183	60.07	11.53
2	#5715.00	53.8 AV	54.0	-0.2	1.05 V	183	42.27	11.53
3	#5725.00	72.5 PK	78.2	-5.7	1.05 V	183	60.95	11.55
4	*5775.00	105.5 PK			1.05 V	183	93.78	11.72
5	*5775.00	94.4 AV			1.05 V	183	82.68	11.72
6	#5850.00	64.3 PK	78.2	-13.9	1.05 V	183	52.55	11.75
7	#5860.00	61.4 PK	74.0	-12.6	1.05 V	183	49.65	11.75
8	#5860.00	49.2 AV	54.0	-4.8	1.05 V	183	37.45	11.75
9	11550.00	57.2 PK	74.0	-16.8	1.21 V	288	39.49	17.71
10	11550.00	44.8 AV	54.0	-9.2	1.21 V	288	27.09	17.71
11	#17325.00	59.7 PK	74.0	-14.3	1.41 V	97	32.85	26.85
12	#17325.00	47.9 AV	54.0	-6.1	1.41 V	97	21.05	26.85

REMARKS:

1. Emission Level(dBuV/m) = Raw Value(dBuV) + Correction Factor(dB/m)
2. Correction Factor(dB/m) = Antenna Factor(dB/m) + Cable Factor(dB) – Pre-Amplifier Factor(dB)
3. The other emission levels were very low against the limit.
4. Margin value = Emission Level – Limit value
5. " * ": Fundamental frequency.
6. " # ": The radiated frequency is out of the restricted band.

Below 1GHz Data:
802.11a

CHANNEL	TX Channel 157	DETECTOR FUNCTION	Quasi-Peak (QP)
FREQUENCY RANGE	Below 1GHz		

ANTENNA POLARITY & TEST DISTANCE: HORIZONTAL AT 3 M

NO.	FREQ. (MHz)	EMISSION LEVEL (dBuV/m)	LIMIT (dBuV/m)	MARGIN (dB)	ANTENNA HEIGHT (m)	TABLE ANGLE (Degree)	RAW VALUE (dBuV)	CORRECTION FACTOR (dB/m)
1	151.25	35.6 QP	43.5	-7.9	2.00 H	296	43.27	-7.65
2	282.90	37.8 QP	46.0	-8.2	1.00 H	315	44.98	-7.20
3	400.01	32.6 QP	46.0	-13.5	2.00 H	269	36.60	-4.05
4	500.01	31.9 QP	46.0	-14.1	1.50 H	39	33.41	-1.55
5	800.01	38.0 QP	46.0	-8.0	1.00 H	46	33.48	4.51
6	932.00	38.3 QP	46.0	-7.7	1.50 H	132	31.52	6.78

ANTENNA POLARITY & TEST DISTANCE: VERTICAL AT 3 M

NO.	FREQ. (MHz)	EMISSION LEVEL (dBuV/m)	LIMIT (dBuV/m)	MARGIN (dB)	ANTENNA HEIGHT (m)	TABLE ANGLE (Degree)	RAW VALUE (dBuV)	CORRECTION FACTOR (dB/m)
1	114.75	31.1 QP	43.5	-12.4	1.50 V	360	41.29	-10.23
2	153.51	33.0 QP	43.5	-10.5	1.50 V	72	40.58	-7.56
3	283.46	36.5 QP	46.0	-9.5	1.50 V	320	43.72	-7.19
4	400.01	35.1 QP	46.0	-10.9	1.50 V	278	39.14	-4.05
5	500.01	32.9 QP	46.0	-13.1	1.00 V	301	34.48	-1.55
6	800.01	38.0 QP	46.0	-8.0	1.00 V	294	33.50	4.51

REMARKS:

1. Emission Level(dBuV/m) = Raw Value(dBuV) + Correction Factor(dB/m)
2. Correction Factor(dB/m) = Antenna Factor(dB/m) + Cable Factor(dB) – Pre-Amplifier Factor(dB)
3. The other emission levels were very low against the limit.
4. Margin value = Emission Level – Limit value

4.2 Conducted Emission Measurement

4.2.1 Limits of Conducted Emission Measurement

Frequency (MHz)	Conducted Limit (dBuV)	
	Quasi-peak	Average
0.15 - 0.5	66 - 56	56 - 46
0.50 - 5.0	56	46
5.0 - 30.0	60	50

Note: 1. The lower limit shall apply at the transition frequencies.

2. The limit decreases in line with the logarithm of the frequency in the range of 0.15 to 0.50MHz.

4.2.2 Test Instruments

DESCRIPTION & MANUFACTURER	MODEL NO.	SERIAL NO.	CALIBRATED DATE	CALIBRATED UNTIL
Test Receiver R&S	ESCS 30	100375	May 06, 2015	May 05, 2016
Line-Impedance Stabilization Network (for EUT) SCHWARZBECK	NSLK-8127	8127-522	Sep. 01, 2015	Aug. 31, 2016
Line-Impedance Stabilization Network (for Peripheral) R&S	ENV216	100072	June 11, 2015	June 10, 2016
RF Cable	5D-FB	COCCAB-001	Mar. 09, 2015	Mar. 08, 2016
50 ohms Terminator	N/A	EMC-03	Sep. 23, 2015	Sep. 22, 2016
50 ohms Terminator	N/A	EMC-02	Oct. 01, 2015	Sep. 30, 2016
Software BVADT	BVADT_Cond_ V7.3.7.3	NA	NA	NA

Note:

1. The calibration interval of the above test instruments are 12 months and the calibrations are traceable to NML/ROC and NIST/USA.
2. The test was performed in Shielded Room No. C.
3. The VCCI Con C Registration No. is C-3611.
4. Tested Date: Nov. 03, 2015

4.2.3 Test Procedure

- a. The EUT was placed 0.4 meters from the conducting wall of the shielded room with EUT being connected to the power mains through a line impedance stabilization network (LISN). Other support units were connected to the power mains through another LISN. The two LISNs provide 50 ohm/ 50uH of coupling impedance for the measuring instrument.
- b. Both lines of the power mains connected to the EUT were checked for maximum conducted interference.
- c. The frequency range from 150kHz to 30MHz was searched. Emission levels under (Limit - 20dB) was not recorded.

NOTE: All modes of operation were investigated and the worst-case emissions are reported.

4.2.4 Deviation from Test Standard

No deviation.

4.2.5 Test Setup

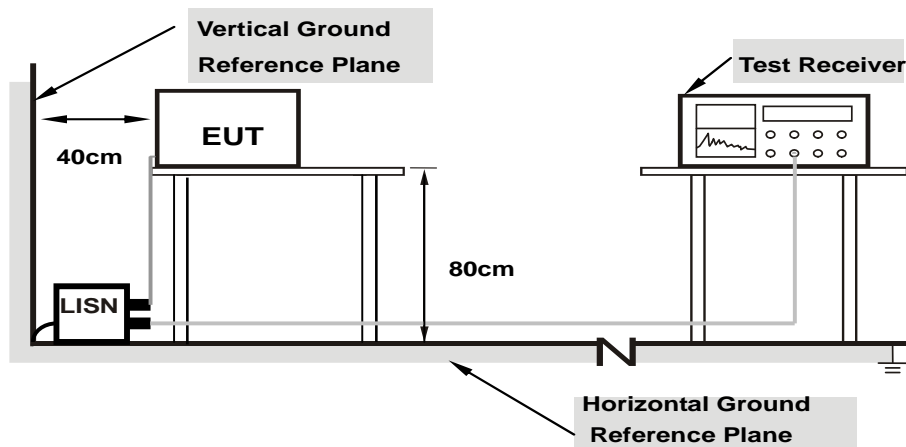

Note: 1.Support units were connected to second LISN.

For the actual test configuration, please refer to the attached file (Test Setup Photo).

4.2.6 EUT Operating Condition

Same as 4.1.6.

4.2.7 Test Results

Phase	Line (L)	Detector Function	Quasi-Peak (QP) / Average (AV)
-------	----------	-------------------	--------------------------------

No	Freq. [MHz]	Corr.	Reading Value		Emission Level		Limit		Margin	
		Factor	[dB (uV)]		[dB (uV)]		[dB (uV)]		(dB)	
	(dB)	Q.P.	AV.	Q.P.	AV.	Q.P.	AV.	Q.P.	AV.	
1	0.16953	10.36	36.51	28.50	46.87	38.86	64.98	54.98	-18.11	-16.12
2	0.20469	10.34	42.45	34.19	52.79	44.53	63.42	53.42	-10.63	-8.89
3	0.23984	10.35	43.38	32.11	53.73	42.46	62.10	52.10	-8.38	-9.65
4	0.28281	10.35	44.21	35.24	54.56	45.59	60.73	50.73	-6.17	-5.14
5	0.41172	10.37	38.42	32.33	48.79	42.70	57.61	47.61	-8.82	-4.91
6	0.48594	10.36	30.64	17.94	41.00	28.30	56.24	46.24	-15.23	-17.93
7	14.08594	11.17	30.91	27.08	42.08	38.25	60.00	50.00	-17.92	-11.75

REMARKS:

1. Q.P. and AV. are abbreviations of quasi-peak and average individually.
2. The emission levels of other frequencies were very low against the limit.
3. Margin value = Emission level - Limit value
4. Correction factor = Insertion loss + Cable loss
5. Emission Level = Correction Factor + Reading Value

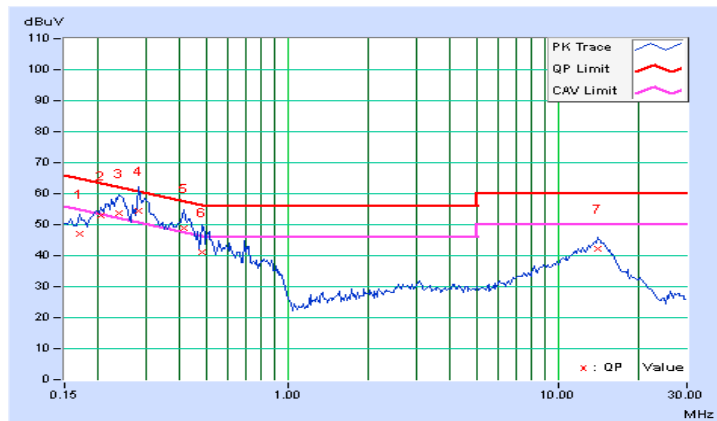

Phase	Neutral (N)	Detector Function	Quasi-Peak (QP) / Average (AV)
-------	-------------	-------------------	--------------------------------

No	Freq. [MHz]	Corr.	Reading Value		Emission Level		Limit		Margin	
		Factor (dB)	[dB (uV)]		[dB (uV)]		[dB (uV)]		(dB)	
			Q.P.	AV.	Q.P.	AV.	Q.P.	AV.	Q.P.	AV.
1	0.19687	10.39	41.38	33.87	51.77	44.26	63.74	53.74	-11.97	-9.48
2	0.21937	10.39	43.52	35.13	53.91	45.52	62.84	52.84	-8.93	-7.32
3	0.23984	10.40	42.67	32.01	53.07	42.41	62.10	52.10	-9.04	-9.70
4	0.26719	10.40	45.61	27.58	56.01	37.98	61.20	51.20	-5.19	-13.22
5	0.30234	10.41	43.89	37.67	54.30	48.08	60.18	50.18	-5.88	-2.10
6	0.40781	10.42	38.40	33.51	48.82	43.93	57.69	47.69	-8.87	-3.76
7	0.49766	10.41	28.92	15.98	39.33	26.39	56.04	46.04	-16.71	-19.65
8	0.66563	10.40	22.21	9.29	32.61	19.69	56.00	46.00	-23.39	-26.31

REMARKS:

1. Q.P. and AV. are abbreviations of quasi-peak and average individually.
2. The emission levels of other frequencies were very low against the limit.
3. Margin value = Emission level - Limit value
4. Correction factor = Insertion loss + Cable loss
5. Emission Level = Correction Factor + Reading Value

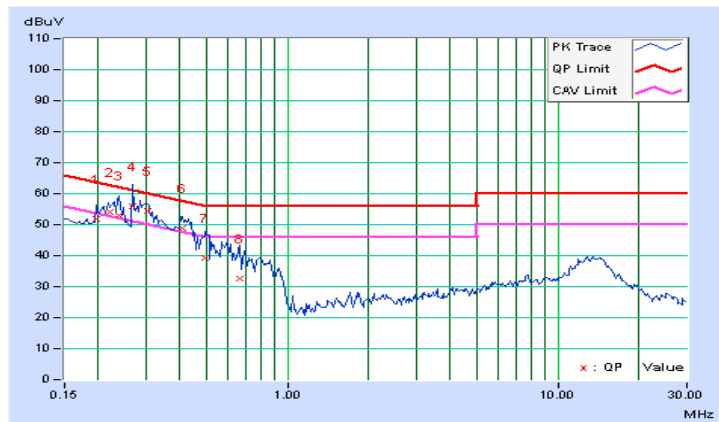

4.3 Transmit Power Measurement

4.3.1 Limits of Transmit Power Measurement

Operation Band	EUT Category		LIMIT
U-NII-1		Outdoor Access Point	1 Watt (30 dBm) (Max. e.i.r.p \leq 125mW(21 dBm) at any elevation angle above 30 degrees as measured from the horizon)
		Fixed point-to-point Access Point	1 Watt (30 dBm)
		Indoor Access Point	1 Watt (30 dBm)
		Mobile and Portable client device	250mW (24 dBm)
U-NII-2A			250mW (24 dBm) or 11 dBm+10 log B*
U-NII-2C			250mW (24 dBm) or 11 dBm+10 log B*
U-NII-3	√		1 Watt (30 dBm)

*B is the 26 dB emission bandwidth in megahertz

Per KDB 662911 Method of conducted output power measurement on IEEE 802.11 devices,

Array Gain = 0 dB (i.e., no array gain) for $N_{ANT} \leq 4$;

Array Gain = 0 dB (i.e., no array gain) for channel widths ≥ 40 MHz for any N_{ANT} ;

Array Gain = $5 \log(N_{ANT}/N_{SS})$ dB or 3 dB, whichever is less for 20-MHz channel widths with $N_{ANT} \geq 5$.

For power measurements on all other devices: Array Gain = $10 \log(N_{ANT}/N_{SS})$ dB.

4.3.2 Test Setup

FOR POWER OUTPUT MEASUREMENT

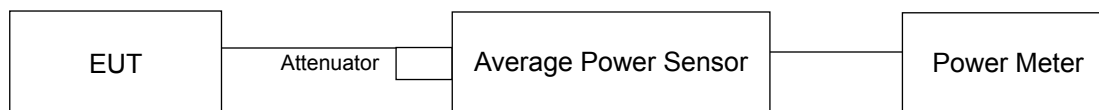

4.3.3 Test Instruments

Refer to section 4.1.2 to get information of above instrument.

4.3.4 Test Procedure

FOR AVERAGE POWER MEASUREMENT

Method PM is used to perform output power measurement, trigger and gating function of wide band power meter is enabled to measure max output power of TX on burst. Duty factor is not added to measured value.

4.3.5 Deviation from Test Standard

No deviation.

4.3.6 EUT Operating Condition

The software provided by client to enable the EUT under transmission condition continuously at lowest, middle and highest channel frequencies individually.

4.3.7 Test Result

POWER OUTPUT

CDD Mode

802.11a

Chan.	Chan. Freq. (MHz)	Average Power (mW)	Average Power (dBm)	Limit (dBm)	Pass / Fail
149	5745	107.647	20.32	30	Pass
157	5785	450.817	26.54	30	Pass
165	5825	269.153	24.30	30	Pass

Beamforming Mode

802.11ac (VHT20)

Chan.	Chan. Freq. (MHz)	Average Power (dBm)			Total Power (mW)	Total Power (dBm)	Limit (dBm)	Pass / Fail
		Chain 0	Chain 1	Chain 2				
149	5745	19.07	19.02	18.26	227.511	23.57	25.61	Pass
157	5785	19.10	19.21	18.66	238.102	23.77	25.61	Pass
165	5825	20.89	20.72	20.42	350.93	25.45	25.61	Pass

NOTE: 1. Directional gain = $10 \log[(10^{G1/20} + 10^{G2/20} + 10^{G3/20})^2 / 3]$ = 10.39dBi > 6dBi , so the power limit shall be reduced to $30-(10.39-6) = 25.61$ dBm.

802.11ac (VHT40)

Chan.	Chan. Freq. (MHz)	Average Power (dBm)			Total Power (mW)	Total Power (dBm)	Limit (dBm)	Pass / Fail
		Chain 0	Chain 1	Chain 2				
151	5755	16.21	16.52	16.03	126.745	21.03	25.61	Pass
159	5795	20.63	20.89	20.31	345.754	25.39	25.61	Pass

NOTE: 1. Directional gain = $10 \log[(10^{G1/20} + 10^{G2/20} + 10^{G3/20})^2 / 3]$ = 10.39dBi > 6dBi , so the power limit shall be reduced to $30-(10.39-6) = 25.61$ dBm.

802.11ac (VHT80)

Chan.	Chan. Freq. (MHz)	Average Power (dBm)			Total Power (mW)	Total Power (dBm)	Limit (dBm)	Pass / Fail
		Chain 0	Chain 1	Chain 2				
155	5775	15.57	16.32	15.62	115.388	20.62	25.61	Pass

NOTE: 1. Directional gain = $10 \log[(10^{G1/20} + 10^{G2/20} + 10^{G3/20})^2 / 3]$ = 10.39dBi > 6dBi , so the power limit shall be reduced to $30-(10.39-6) = 25.61$ dBm.

4.4 Peak Power Spectral Density Measurement

4.4.1 Limits of Peak Power Spectral Density Measurement

Operation Band	EUT Category		LIMIT
U-NII-1		Outdoor Access Point	17dBm/ MHz
		Fixed point-to-point Access Point	
		Indoor Access Point	
		Mobile and Portable client device	11dBm/ MHz
U-NII-2A			11dBm/ MHz
U-NII-2C			11dBm/ MHz
U-NII-3	√		30dBm/ 500kHz

4.4.2 Test Setup

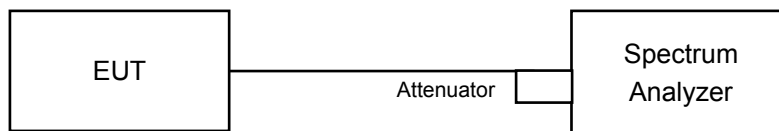

4.4.3 Test Instruments

Refer to section 4.1.2 to get information of above instrument.

4.4.4 Test Procedure

For 802.11a, 802.11ac (VHT20) & 802.11ac (VHT40):

For U-NII-3:

1. Set span to encompass the entire emission bandwidth (EBW) of the signal.
2. Set RBW = 300 kHz, Set VBW \geq 1 MHz, Detector = RMS
3. Use the peak marker function to determine the maximum power level in any 300 kHz band segment within the fundamental EBW.
4. Scale the observed power level to an equivalent value in 500 kHz by adjusting (reducing) the measured power by a bandwidth correction factor (BWCF) where $BWCF = 10\log(500 \text{ kHz}/300\text{kHz})$
5. Sweep time = auto, trigger set to "free run".
6. Trace average at least 100 traces in power averaging mode.
7. Record the max value

For 802.11ac (VHT80):

For U-NII-3:

1. Set span to encompass the entire emission bandwidth (EBW) of the signal.
2. Set RBW = 300 kHz, Set VBW \geq 1 MHz, Detector = RMS
3. Use the peak marker function to determine the maximum power level in any 300 kHz band segment within the fundamental EBW.
4. Scale the observed power level to an equivalent value in 500 kHz by adjusting (reducing) the measured power by a bandwidth correction factor (BWCF) where $BWCF = 10\log(500 \text{ kHz}/300\text{kHz})$
5. Sweep time = auto, trigger set to "free run".
6. Trace average at least 100 traces in power averaging mode.
7. Record the max value and add $10 \log (1/\text{duty cycle})$

4.4.5 Deviation from Test Standard

No deviation.

4.4.6 EUT Operating Condition

Same as Item 4.3.6.

4.4.7 Test Results

CDD Mode**802.11a**

Chan.	Chan. Freq. (MHz)	PSD (dBm/300kHz)	PSD (dBm/500kHz)	Limit (dBm/500kHz)	Pass /Fail
149	5745	-1.32	0.90	30	Pass
157	5785	4.83	7.05	30	Pass
165	5825	3.40	5.62	30	Pass

Beamforming Mode

802.11ac (VHT20)

TX chain	Channel	Freq. (MHz)	PSD (dBm/300kHz)	PSD (dBm/500kHz)	10 log (N=3) dB	Total PSD (dBm/500kHz)	Limit (dBm/500kHz)	Pass /Fail
0	149	5745	-2.65	-0.43	4.77	4.34	25.61	Pass
	157	5785	-2.73	-0.51	4.77	4.26	25.61	Pass
	165	5825	-0.04	2.18	4.77	6.95	25.61	Pass
1	149	5745	-2.84	-0.62	4.77	4.15	25.61	Pass
	157	5785	-2.78	-0.56	4.77	4.21	25.61	Pass
	165	5825	-0.58	1.64	4.77	6.41	25.61	Pass
2	149	5745	-3.37	-1.15	4.77	3.62	25.61	Pass
	157	5785	-3.12	-0.90	4.77	3.87	25.61	Pass
	165	5825	-0.72	1.50	4.77	6.27	25.61	Pass

NOTE: 1. Directional gain = $10 \log[(10^{G1/20} + 10^{G2/20} + 10^{G3/20})^2 / 3]$ = 10.39dBi > 6dBi , so the power density limit shall be reduced to $30-(10.39-6) = 25.61$ dBm.

802.11ac (VHT40)

TX chain	Channel	Freq. (MHz)	PSD (dBm/300kHz)	PSD (dBm/500kHz)	10 log (N=3) dB	Total PSD (dBm/500kHz)	Limit (dBm/500kHz)	Pass /Fail
0	151	5755	-8.42	-6.20	4.77	-1.43	25.61	Pass
	159	5795	-3.83	-1.61	4.77	3.16	25.61	Pass
1	151	5755	-8.71	-6.49	4.77	-1.72	25.61	Pass
	159	5795	-4.39	-2.17	4.77	2.60	25.61	Pass
2	151	5755	-8.78	-6.56	4.77	-1.79	25.61	Pass
	159	5795	-4.63	-2.41	4.77	2.36	25.61	Pass

NOTE: 1. Directional gain = $10 \log[(10^{G1/20} + 10^{G2/20} + 10^{G3/20})^2 / 3]$ = 10.39dBi > 6dBi , so the power density limit shall be reduced to $30-(10.39-6) = 25.61$ dBm.

802.11ac (VHT80)

TX chain	Chan.	Chan. Freq. (MHz)	PSD W/O Duty Factor		10 log (N=3) dB	Duty Factor (dB)	Total PSD With Duty Factor (dBm/500kHz)	Limit (dBm/500kHz)	Pass /Fail
			(dBm/300kHz)	(dBm/500kHz)					
0	155	5775	-12.33	-10.11	4.77	0.20	-5.14	25.61	Pass
1	155	5775	-11.89	-9.67	4.77	0.20	-4.70	25.61	Pass
2	155	5775	-12.42	-10.20	4.77	0.20	-5.23	25.61	Pass

NOTE: 1. Directional gain = $10 \log[(10^{G1/20} + 10^{G2/20} + 10^{G3/20})^2 / 3]$ = 10.39dBi > 6dBi , so the power density limit shall be reduced to $30-(10.39-6) = 25.61$ dBm.

2. Refer to section 3.3 for duty cycle spectrum plot.

Spectrum Plot of Worst Value

802.11a – CH 157

802.11ac (VHT20) – Chain 0: CH 165

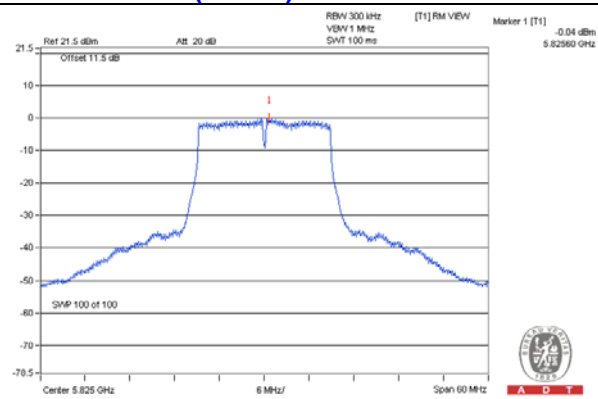
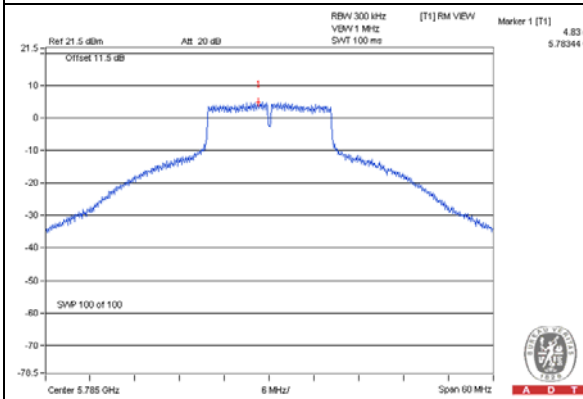

802.11ac (VHT40) – Chain 0: CH 159

802.11ac (VHT80) – Chain 1: CH 155

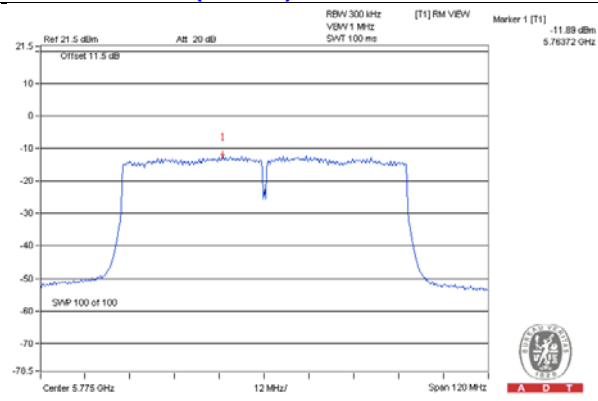
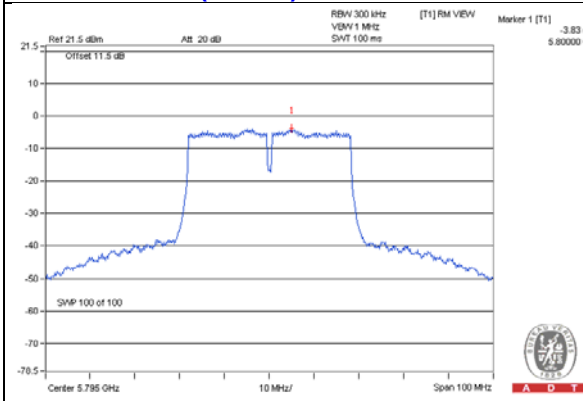

4.5 Frequency Stability Measurement

4.5.1 Limits of Frequency Stability Measurement

The frequency of the carrier signal shall be maintained within band of operation

4.5.2 Test Setup

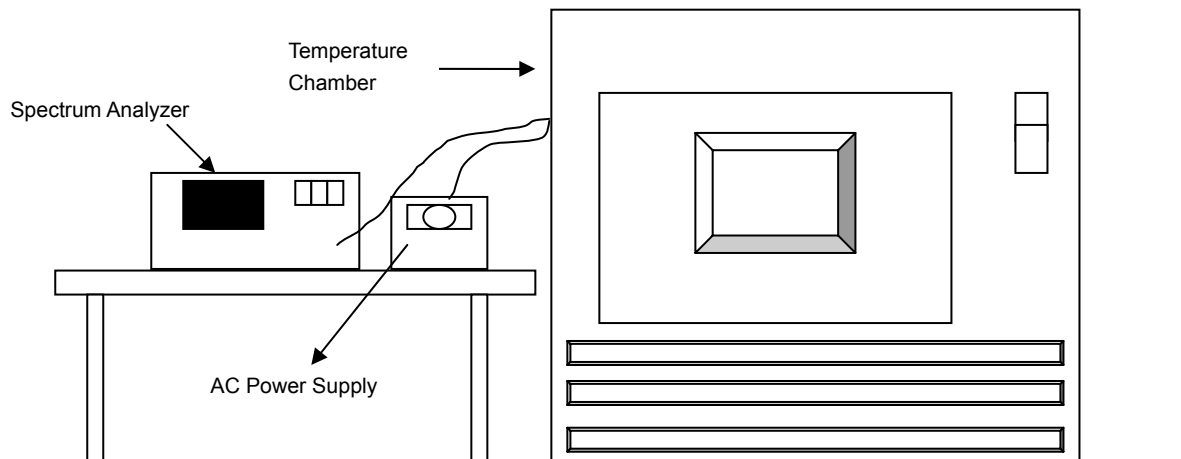

4.5.3 Test Instruments

Refer to section 4.1.2 to get information of above instrument.

4.5.4 Test Procedure

- The EUT was placed inside the environmental test chamber and powered by nominal AC voltage.
- Turn the EUT on and couple its output to a spectrum analyzer.
- Turn the EUT off and set the chamber to the highest temperature specified.
- Allow sufficient time (approximately 30 min) for the temperature of the chamber to stabilize, turn the EUT on and measure the operating frequency after 2, 5, and 10 minutes.
- Repeat step 2 and 3 with the temperature chamber set to the lowest temperature.
- The test chamber was allowed to stabilize at +20 degree C for a minimum of 30 minutes. The supply voltage was then adjusted on the EUT from 85% to 115% and the frequency record.

4.5.5 Deviation from Test Standard

No deviation.

4.5.6 EUT Operating Condition

Set the EUT transmit at un-modulation mode to test frequency stability.

4.5.7 Test Results

FREQUENCY STABILITY VERSUS TEMP.									
OPERATING FREQUENCY: 5745MHz									
TEMP. (°C)	POWER SUPPLY (Vac)	0 MINUTE		2 MINUTE		5 MINUTE		10 MINUTE	
		Measured Frequency (MHz)	Frequency Drift (%)	Measured Frequency (MHz)	Frequency Drift (%)	Measured Frequency (MHz)	Frequency Drift (%)	Measured Frequency (MHz)	Frequency Drift (%)
50	120	5745.0093	0.00016	5745.0108	0.00019	5745.0055	0.00010	5745.0051	0.00009
40	120	5745.0089	0.00015	5745.012	0.00021	5745.0102	0.00018	5745.0104	0.00018
30	120	5744.9969	-0.00005	5745.0013	0.00002	5745.0013	0.00002	5744.9976	-0.00004
20	120	5744.9971	-0.00005	5744.9983	-0.00003	5744.9975	-0.00004	5745.0004	0.00001
10	120	5745.0193	0.00034	5745.016	0.00028	5745.0165	0.00029	5745.0179	0.00031
0	120	5744.9958	-0.00007	5744.9958	-0.00007	5744.9997	-0.00001	5744.9987	-0.00002
-10	120	5745.0108	0.00019	5745.0138	0.00024	5745.0147	0.00026	5745.0126	0.00022
-20	120	5745.0069	0.00012	5745.0068	0.00012	5745.0078	0.00014	5745.0054	0.00009
-30	120	5745.0256	0.00045	5745.0242	0.00042	5745.0246	0.00043	5745.0267	0.00046

FREQUENCY STABILITY VERSUS VOLTAGE									
OPERATING FREQUENCY: 5745MHz									
TEMP. (°C)	POWER SUPPLY (Vac)	0 MINUTE		2 MINUTE		5 MINUTE		10 MINUTE	
		Measured Frequency (MHz)	Frequency Drift (%)	Measured Frequency (MHz)	Frequency Drift (%)	Measured Frequency (MHz)	Frequency Drift (%)	Measured Frequency (MHz)	Frequency Drift (%)
20	138	5744.9977	-0.00004	5744.9993	-0.00001	5744.9968	-0.00006	5745.0006	0.00001
	120	5744.9971	-0.00005	5744.9983	-0.00003	5744.9975	-0.00004	5745.0004	0.00001
	102	5744.9961	-0.00007	5744.9992	-0.00001	5744.9984	-0.00003	5745.0008	0.00001

4.6 6dB Bandwidth Measurement

4.6.1 Limits of 6dB Bandwidth Measurement

The minimum of 6dB Bandwidth Measurement is 0.5MHz.

4.6.2 Test Setup

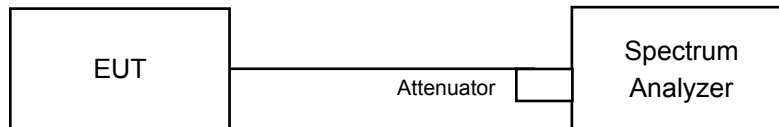

4.6.3 Test Instruments

Refer to section 4.1.2 to get information of above instrument.

4.6.4 Test Procedure

MEASUREMENT PROCEDURE REF

- Set resolution bandwidth (RBW) = 100kHz
- Set the video bandwidth (VBW) $\geq 3 \times$ RBW, Detector = Peak.
- Trace mode = max hold.
- Sweep = auto couple.
- Measure the maximum width of the emission that is constrained by the frequencies associated with the two amplitude points (upper and lower) that are attenuated by 6 dB relative to the maximum level measured in the fundamental emission

4.6.5 Deviation from Test Standard

No deviation.

4.6.6 EUT Operating Condition

The software provided by client to enable the EUT under transmission condition continuously at lowest, middle and highest channel frequencies individually.

4.6.7 Test Results

802.11a

Channel	Frequency (MHz)	6dB Bandwidth (MHz)	Minimum Limit (MHz)	Pass / Fail
149	5745	16.43	0.5	Pass
157	5785	16.43	0.5	Pass
165	5825	16.39	0.5	Pass

802.11ac (VHT20)

Channel	Frequency (MHz)	6dB Bandwidth (MHz)			Minimum Limit (MHz)	Pass / Fail
		Chain 0	Chain 1	Chain 2		
149	5745	17.65	17.69	17.68	0.5	Pass
157	5785	17.66	17.69	17.70	0.5	Pass
165	5825	17.62	17.68	17.67	0.5	Pass

802.11ac (VHT40)

Channel	Frequency (MHz)	6dB Bandwidth (MHz)			Minimum Limit (MHz)	Pass / Fail
		Chain 0	Chain 1	Chain 2		
151	5755	36.43	36.48	36.45	0.5	Pass
159	5795	36.43	36.47	36.44	0.5	Pass

802.11ac (VHT80)

Channel	Frequency (MHz)	6dB Bandwidth (MHz)			Minimum Limit (MHz)	Pass / Fail
		Chain 0	Chain 1	Chain 2		
155	5775	75.70	76.40	76.01	0.5	Pass

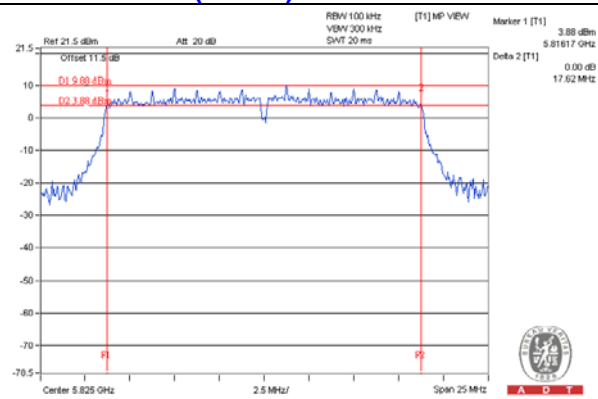
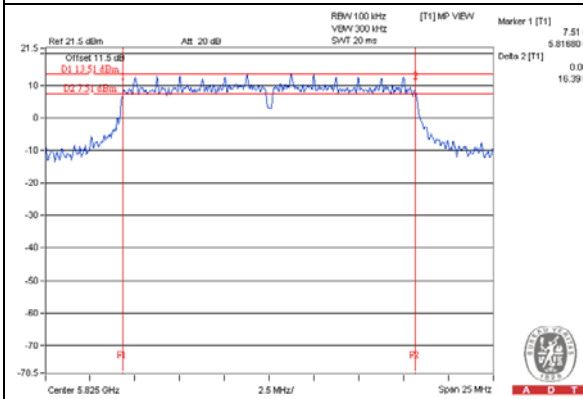
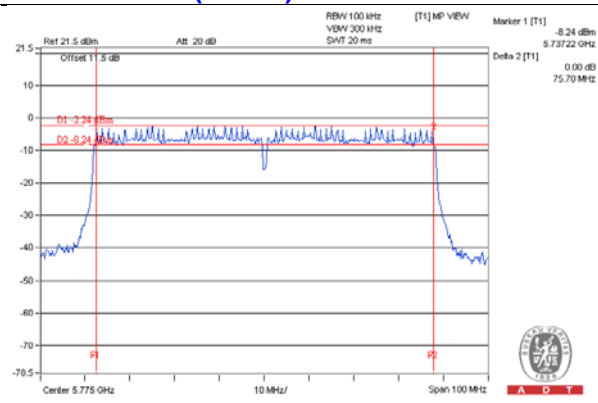
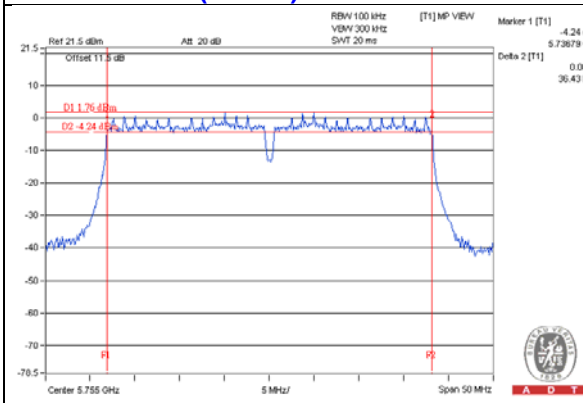
Spectrum Plot of Worst Value
802.11a – CH 165
802.11ac (VHT20) – Chain 0: CH 165

802.11ac (VHT40) – Chain 0: CH 151
802.11ac (VHT80) – Chain 0: CH 155



5 Pictures of Test Arrangements

Please refer to the attached file (Test Setup Photo).



Appendix – Information on the Testing Laboratories

We, Bureau Veritas Consumer Products Services (H.K.) Ltd., Taoyuan Branch, were founded in 1988 to provide our best service in EMC, Radio, Telecom and Safety consultation. Our laboratories are accredited and approved according to ISO/IEC 17025.

If you have any comments, please feel free to contact us at the following:

Linko EMC/RF Lab

Tel: 886-2-26052180

Fax: 886-2-26051924

Hsin Chu EMC/RF/Telecom Lab

Tel: 886-3-6668565

Fax: 886-3-6668323

Hwa Ya EMC/RF/Safety Lab

Tel: 886-3-3183232

Fax: 886-3-3270892

Email: service.adt@tw.bureauveritas.com

Web Site: www.bureauveritas-adt.com

The address and road map of all our labs can be found in our web site also.

--- END ---