



FCC TEST REPORT (15.407)

REPORT NO.: RF131223E02-1

MODEL NO.: TEW-818DRU

FCC ID: XU8TEW818DRU

RECEIVED: Dec. 23, 2013

TESTED: Dec. 25, 2013 to Jan. 07, 2014

ISSUED: Jan. 14, 2014

APPLICANT: TRENDnet, Inc.

ADDRESS: 20675 Manhattan Place, Torrance, CA
90501

ISSUED BY: Bureau Veritas Consumer Products Services
(H.K.) Ltd., Taoyuan Branch Hsin Chu Laboratory

LAB ADDRESS : No. 81-1, Lu Liao Keng, 9th Ling, Wu Lung Tsuen,
Chiung Lin Hsiang, Hsin Chu Hsien 307, Taiwan,
R.O.C.

TEST LOCATION (1): No. 81-1, Lu Liao Keng, 9th Ling, Wu Lung Tsuen,
Chiung Lin Hsiang, Hsin Chu Hsien 307, Taiwan,
R.O.C.

TEST LOCATION (2): No. 49, Ln. 206, Wende Rd., Shangshan Tsuen,
Chiung Lin Hsiang, Hsin Chu Hsien 307, Taiwan,
R.O.C.

This report should not be used by the client to claim product certification, approval, or endorsement by TAF or any government agencies.



This report is for your exclusive use. Any copying or replication of this report to or for any other person or entity, or use of our name or trademark, is permitted only with our prior written permission. This report sets forth our findings solely with respect to the test samples identified herein. The results set forth in this report are not indicative or representative of the quality or characteristics of the lot from which a test sample was taken or any similar or identical product unless specifically and expressly noted. Our report includes all of the tests requested by you and the results thereof based upon the information that you provided to us. You have 60 days from date of issuance of this report to notify us of any material error or omission caused by our negligence, provided, however, that such notice shall be in writing and shall specifically address the issue you wish to raise. A failure to raise such issue within the prescribed time shall constitute your unqualified acceptance of the completeness of this report, the tests conducted and the correctness of the report contents. Unless specific mention, the uncertainty of measurement has been explicitly taken into account to declare the compliance or non-compliance to the specification



Table of Contents

RELEASE CONTROL RECORD	4
1. CERTIFICATION	5
2. SUMMARY OF TEST RESULTS	6
2.1 MEASUREMENT UNCERTAINTY	7
3. GENERAL INFORMATION	8
3.1 GENERAL DESCRIPTION OF EUT	8
3.2 DESCRIPTION OF TEST MODES	11
3.2.1 TEST MODE APPLICABILITY AND TESTED CHANNEL DETAIL	12
3.3 GENERAL DESCRIPTION OF APPLIED STANDARDS	14
3.4 DUTY CYCLE OF TEST SIGNAL	15
3.5 DESCRIPTION OF SUPPORT UNITS.....	19
3.6 CONFIGURATION OF SYSTEM UNDER TEST.....	20
4. TEST TYPES AND RESULTS	22
4.1 CONDUCTED EMISSION MEASUREMENT	22
4.1.1 LIMITS OF CONDUCTED EMISSION MEASUREMENT	22
4.1.2 TEST INSTRUMENTS.....	22
4.1.3 TEST PROCEDURES	23
4.1.4 DEVIATION FROM TEST STANDARD	23
4.1.5 TEST SETUP	23
4.1.6 EUT OPERATING CONDITIONS	24
4.1.7 TEST RESULTS (MODE 1)	25
4.1.8 TEST RESULTS (MODE 2)	27
4.2 RADIATED EMISSION AND BANDEDGE MEASUREMENT	29
4.2.1 LIMITS OF RADIATED EMISSION AND BANDEDGE MEASUREMENT.....	29
4.2.2 LIMITS OF UNWANTED EMISSION OUT OF THE RESTRICTED BANDS.....	29
4.2.3 TEST INSTRUMENTS.....	30
4.2.4 TEST PROCEDURES	31
4.2.5 DEVIATION FROM TEST STANDARD	31
4.2.6 TEST SETUP	32
4.2.7 EUT OPERATING CONDITION.....	32
4.2.8 TEST RESULTS	33
4.3 TRANSMIT POWER MEASUREMENT	43
4.3.1 LIMITS OF TRANSMIT POWER MEASUREMENT	43
4.3.2 TEST INSTRUMENTS.....	43
4.3.3 TEST PROCEDURE.....	44
4.3.4 DEVIATION FROM TEST STANDARD	44
4.3.5 TEST SETUP	45
4.3.6 EUT OPERATING CONDITIONS	45
4.3.7 TEST RESULTS	46



A D T

4.4	PEAK POWER SPECTRAL DENSITY MEASUREMENT	50
4.4.1	LIMITS OF PEAK POWER SPECTRAL DENSITY MEASUREMENT	50
4.4.2	TEST INSTRUMENTS.....	50
4.4.3	TEST PROCEDURES	50
4.4.4	DEVIATION FROM TEST STANDARD	50
4.4.5	TEST SETUP	50
4.4.6	EUT OPERATING CONDITIONS	51
4.4.7	TEST RESULTS	52
4.5	PEAK POWER EXCURSION MEASUREMENT	55
4.5.1	LIMITS OF PEAK POWER EXCURSION MEASUREMENT	55
4.5.2	TEST INSTRUMENTS.....	55
4.5.3	TEST PROCEDURE.....	55
4.5.4	DEVIATION FROM TEST STANDARD	55
4.5.5	TEST SETUP	55
4.5.6	EUT OPERATING CONDITIONS	55
4.5.7	TEST RESULTS	56
4.6	FREQUENCY STABILITY.....	58
4.6.1	LIMITS OF FREQUENCY STABILITY MEASUREMENT	58
4.6.2	TEST INSTRUMENTS.....	58
4.6.3	TEST PROCEDURE.....	58
4.6.4	DEVIATION FROM TEST STANDARD	59
4.6.5	TEST SETUP	59
4.6.6	EUT OPERATING CONDITION.....	59
4.6.7	TEST RESULTS	60
5.	PHOTOGRAPHS OF THE TEST CONFIGURATION.....	61
6.	INFORMATION ON THE TESTING LABORATORIES	62
7.	APPENDIX A - MODIFICATIONS RECORDERS FOR ENGINEERING CHANGES TO THE EUT BY THE LAB.....	63



A D T

RELEASE CONTROL RECORD

ISSUE NO.	REASON FOR CHANGE	DATE ISSUED
RF131223E02-1	Original release	Jan. 14, 2014



1. CERTIFICATION

PRODUCT: AC1900 Dual Band Wireless Router
BRAND NAME: TRENDnet
MODEL NO.: TEW-818DRU
TEST SAMPLE: ENGINEERING SAMPLE
APPLICANT: TRENDnet, Inc.
TESTED: Dec. 25, 2013 to Jan. 07, 2014
STANDARDS: FCC Part 15, Subpart E (Section 15.407)
ANSI C63.10-2009

The above equipment (Model: TEW-818DRU) has been tested by **Bureau Veritas Consumer Products Services (H.K.) Ltd., Taoyuan Branch**, and found compliance with the requirement of the above standards. The test record, data evaluation & Equipment Under Test (EUT) configurations represented herein are true and accurate accounts of the measurements of the sample's EMC characteristics under the conditions specified in this report.

PREPARED BY : Phoenix Huang , **DATE:** Jan. 14, 2014
(Phoenix Huang, Specialist)

APPROVED BY : May Chen , **DATE:** Jan. 14, 2014
(May Chen, Manager)



A D T

2. SUMMARY OF TEST RESULTS

The EUT has been tested according to the following specifications:

For 5GHz, 5150~5250MHz Band

APPLIED STANDARD: FCC PART 15, SUBPART E (SECTION 15.407)			
STANDARD SECTION	TEST TYPE	RESULT	REMARK
15.407(b)(6)	AC Power Conducted Emission	PASS	Meet the requirement of limit. Minimum passing margin is -6.56dB at 0.50547MHz
15.407(b/1/2/3) (b)(6)	Spurious Emissions	PASS	Meet the requirement of limit. Minimum passing margin is -0.3dB at 5400.00MHz
15.407(a/1/2)	Transmit Power	PASS	Meet the requirement of limit.
15.407(a)(6)	Peak Power Excursion	PASS	Meet the requirement of limit.
15.407(a/1/2)	Peak Power Spectral Density	PASS	Meet the requirement of limit.
15.407(g)	Frequency Stability	PASS	Meet the requirement of limit.
15.203	Antenna Requirement	PASS	Antenna connector is i-pex (MHF) not a standard connector.

NOTE: 1. For WLAN: The EUT was operating in 2.400 ~ 2.4835GHz, 5.15~5.25GHz and 5.725~5.850GHz frequencies band. This report was recorded the RF parameters including 5.15~5.25GHz. For the 2.400 ~ 2.4835GHz and 5.725~5.850GHz RF parameters was recorded in another test report.



A D T

2.1 MEASUREMENT UNCERTAINTY

Where relevant, the following measurement uncertainty levels have been estimated for tests performed on the EUT as specified in CISPR 16-4-2:

This uncertainty represents an expanded uncertainty expressed at approximately the 95% confidence level using a coverage factor of $k=2$.

Measurement	Value
Conducted emissions	2.98 dB
Radiated emissions (30MHz-1GHz)	5.37 dB
Radiated emissions (1GHz -6GHz)	3.65 dB
Radiated emissions (6GHz -18GHz)	3.88 dB
Radiated emissions (18GHz -40GHz)	4.11 dB



A D T

3. GENERAL INFORMATION

3.1 GENERAL DESCRIPTION OF EUT

PRODUCT	AC1900 Dual Band Wireless Router
MODEL NO.	TEW-818DRU
POWER SUPPLY	DC 12V from power adapter
MODULATION TYPE	CCK, DQPSK, DBPSK for DSSS 64QAM, 16QAM, QPSK, BPSK for OFDM 256QAM for OFDM in 11ac mode and 11n (HT40) mode of 2.4GHz Band.
MODULATION TECHNOLOGY	DSSS,OFDM
TRANSFER RATE	2.4GHz: 802.11b: up to 11Mbps 802.11g: up to 54Mbps 802.11n: up to 600Mbps 5GHz: 802.11a: up to 54Mbps 802.11n: up to 450Mbps 802.11ac: up to 1300Mbps
OPERATING FREQUENCY	For 15.407 5GHz: 5.18 ~ 5.24GHz For 15.247 2.4GHz: 2.412 ~ 2.462GHz 5GHz: 5.745 ~ 5.825GHz
NUMBER OF CHANNEL	For 15.407 4 for 802.11a, 802.11n (HT20), 802.11ac (VHT20) 2 for 802.11n (HT40), 802.11ac (VHT40) 1 for 802.11ac (VHT80) For 15.247 (2.4GHz) 11 for 802.11b, 802.11g, 802.11n (HT20) 7 for 802.11n (HT40) For 15.247 (5GHz) 5 for 802.11a, 802.11n (HT20), 802.11ac (VHT20) 2 for 802.11n (HT40), 802.11ac (VHT40) 1 for 802.11ac (VHT80)

MAXIMUM OUTPUT POWER	For 15.407 802.11a: 46.132mW 802.11ac (VHT20): 18.067mW 802.11ac (VHT40): 17.615mW 802.11ac (VHT80): 17.630mW For 15.247(2.4GHz) 802.11b: 218.273mW 802.11g: 412.098mW 802.11n (HT20): 705.471mW 802.11n (HT40): 263.260mW For 15.247(5GHz) 802.11a: 503.501mW 802.11ac (VHT20): 357.489mW 802.11ac (VHT40): 359.219mW 802.11ac (VHT80): 350.574mW
ANTENNA TYPE	Please see NOTE
DATA CABLE	Ethernet Cable (unshielded, 1.5m) x1
I/O PORTS	Refer to user's manual
ASSOCIATED DEVICES	Adapter x1

NOTE:

- 2.4GHz and 5GHz technology can transmit at same time.
- The EUT must be supplied with a power adapter and following two different models could be chosen as following table:

No	Brand	Model No.	Plug	Spec.
1	HON-KWANG	HK-AX-120A200-US	US	Input: 100-240V, 800mA, 47~63Hz Output: 12V, 2000mA DC output cable: 1.5m, unshielded
2	KTEC	KSASB0241200200HU	US	Input: 100-240V, 600mA, 47~63Hz Output: 12V, 2000mA DC output cable: 1.5m, unshielded
Note:	For radiated emissions test, the EUT was pre-tested with above adapters 1 & 2, the worst case was found in adapter 1. Therefore only the test data of the adapter was recorded in this report.			

3. The antennas provided to the EUT, please refer to the following table:

Ant. No.	Transmitter Circuit	Gain (dBi) (Include cable loss)	Antenna Type	Connector Type	Frequency range (GHz to GHz)	Cable Length (mm)
1	Chain (0)	2.5	Dipole	i-pex (MHF)	2.4~2.4835	78
	Chain (2)	4.8			5.15~5.85	
2	Chain (1)	6	Dipole	i-pex (MHF)	2.4~2.4835	90
					5.15~5.85	
3	Chain (2)	5.5	Dipole	i-pex (MHF)	2.4~2.4835	185
	Chain (0)	6			5.15~5.85	

Note: 1. From above antennas, 802.11b mode will fix transmission on Chain (0).
 2. From above antennas, 802.11g mode the worst case was found in Chain (1).
 3. From above antennas, 802.11a mode the worst case was found in Chain (0).
 Therefore only the test data of the mode was recorded in this report.

4. The EUT incorporates a MIMO function.

MODULATION MODE	Tx/Rx FUNCTION
802.11a	1TX (Diversity) / 3RX
802.11b	1TX (Fixed Chain 0) / 3RX
802.11g	1TX (Diversity) / 3RX
802.11n (HT20)	3TX/3RX
802.11n (HT40)	3TX/3RX
802.11ac (VHT20)	3TX/3RX
802.11ac (VHT40)	3TX/3RX
802.11ac (VHT80)	3TX/3RX

Note: 1. The EUT support 2.4GHz band MIMO without beam forming function and 5GHz band MIMO with beam forming function.

2. The modulation and bandwidth are similar for 802.11n mode for 20MHz (40MHz) and 802.11ac mode for 20MHz (40MHz), therefore investigated worst case to representative mode in test report. (Final test mode refer section 3.2.1)

- When the EUT operating in 802.11n, the software operation, which is defined by manufacturer, MCS (Modulation and Coding Schemes) from 0 to 23.
- When the EUT operating in 802.11ac and support 256QAM of 802.11n (HT40) for 2.4GHz band, the software operation, which is defined by manufacturer, MCS (Modulation and Coding Schemes) from 0 to 9.
- The above EUT information was declared by the manufacturer and for more detailed features description, please refer to the manufacturer's specifications or User's Manual.



A D T

3.2 DESCRIPTION OF TEST MODES

Operated in 5150 ~ 5350MHz band:

4 channels are provided for 802.11a, 802.11n (HT20), 802.11ac (VHT20):

CHANNEL	FREQUENCY	CHANNEL	FREQUENCY
36	5180 MHz	44	5220 MHz
40	5200 MHz	48	5240 MHz

2 channels are provided for 802.11n (HT40), 802.11ac (VHT40):

CHANNEL	FREQUENCY
38	5190 MHz
46	5230 MHz

1 channel is provided for 802.11ac (VHT80):

CHANNEL	FREQUENCY
42	5210 MHz

3.2.1 TEST MODE APPLICABILITY AND TESTED CHANNEL DETAIL

EUT CONFIGURE MODE	APPLICABLE TO				DESCRIPTION
	PLC	RE < 1G	RE [≥] 1G	APCM	
1	√	√	√	√	Adapter 1
2	√	-	-	-	Adapter 2

Where **PLC**: Power Line Conducted Emission **RE < 1G**: Radiated Emission below 1GHz
RE [≥] 1G: Radiated Emission above 1GHz **APCM**: Antenna Port Conducted Measurement

POWER LINE CONDUCTED EMISSION TEST:

- Pre-Scan has been conducted to determine the worst-case mode from all possible combinations between available modulations, data rates and antenna ports (if EUT with antenna diversity architecture).
- Following channel(s) was (were) selected for the final test as listed below.

MODE	AVAILABLE CHANNEL	TESTED CHANNEL	MODULATION TECHNOLOGY	MODULATION TYPE	DATA RATE (MBPS)
802.11ac (VHT20)	36 to 48	48	OFDM	BPSK	6.5

RADIATED EMISSION TEST (BELOW 1 GHz):

- Pre-Scan has been conducted to determine the worst-case mode from all possible combinations between available modulations, data rates and antenna ports (if EUT with antenna diversity architecture).
- Following channel(s) was (were) selected for the final test as listed below.

MODE	AVAILABLE CHANNEL	TESTED CHANNEL	MODULATION TECHNOLOGY	MODULATION TYPE	DATA RATE (MBPS)
802.11ac (VHT20)	36 to 48	48	OFDM	BPSK	6.5

RADIATED EMISSION TEST (ABOVE 1 GHz):

- Pre-Scan has been conducted to determine the worst-case mode from all possible combinations between available modulations, data rates and antenna ports (if EUT with antenna diversity architecture).
- Following channel(s) was (were) selected for the final test as listed below.

MODE	AVAILABLE CHANNEL	TESTED CHANNEL	MODULATION TECHNOLOGY	MODULATION TYPE	DATA RATE (Mbps)
802.11a	36 to 48	36, 40, 48	OFDM	BPSK	6
802.11ac (VHT20)	36 to 48	36, 40, 48	OFDM	BPSK	6.5
802.11ac (VHT40)	38 to 46	38, 46	OFDM	BPSK	13.5
802.11ac (VHT80)	42	42	OFDM	BPSK	29.3



A D T

ANTENNA PORT CONDUCTED MEASUREMENT:

- Pre-Scan has been conducted to determine the worst-case mode from all possible combinations between available modulations, data rates and antenna ports (if EUT with antenna diversity architecture).
- Following channel(s) was (were) selected for the final test as listed below.

MODE	AVAILABLE CHANNEL	TESTED CHANNEL	MODULATION TECHNOLOGY	MODULATION TYPE	DATA RATE (Mbps)
802.11a	36 to 48	36, 40, 48	OFDM	BPSK	6
802.11ac (VHT20)	36 to 48	36, 40, 48	OFDM	BPSK	6.5
802.11ac (VHT40)	38 to 46	38, 46	OFDM	BPSK	13.5
802.11ac (VHT80)	42	42	OFDM	BPSK	29.3

TEST CONDITION:

APPLICABLE TO	ENVIRONMENTAL CONDITIONS	INPUT POWER	TESTED BY
PLC	21deg. C, 68%RH	120Vac, 60Hz	Jyunchun Lin
RE<1G	20deg. C, 73%RH	120Vac, 60Hz	Jason Huang
RE ³ 1G	22deg. C, 61%RH	120Vac, 60Hz	Chilin Lee
APCM	25deg. C, 60%RH	120Vac, 60Hz	Robert Cheng

3.3 GENERAL DESCRIPTION OF APPLIED STANDARDS

The EUT is a RF product. According to the specifications of the manufacturer, it must comply with the requirements of the following standards:

FCC Part 15, Subpart E (15.407)

789033 D01 General UNII Test Procedures v01 r03

662911 D01 Multiple Transmitter Output v01 r02

ANSI C63.10-2009

All test items have been performed and recorded as per the above standards.

Note: The EUT has been verified to comply with the requirements of FCC Part 15, Subpart B, Class B (DoC). The test report has been issued separately.

3.4 DUTY CYCLE OF TEST SIGNAL

If duty cycle of test signal is $\geq 98\%$, duty factor is not required.

If duty cycle of test signal is $< 98\%$, duty factor shall be considered.

802.11a

BPSK: Duty cycle = $2.061 \text{ ms} / 2.084 \text{ ms} = 0.989$

QPSK: Duty cycle = $1.042 \text{ ms} / 1.063 \text{ ms} = 0.98$

16QAM: Duty cycle = $0.531 \text{ ms} / 0.549 \text{ ms} = 0.967$, Duty factor = $10 * \log(1/0.967) = 0.14$

64QAM: Duty cycle = $0.276 \text{ ms} / 0.294 \text{ ms} = 0.939$, Duty factor = $10 * \log(1/0.939) = 0.27$

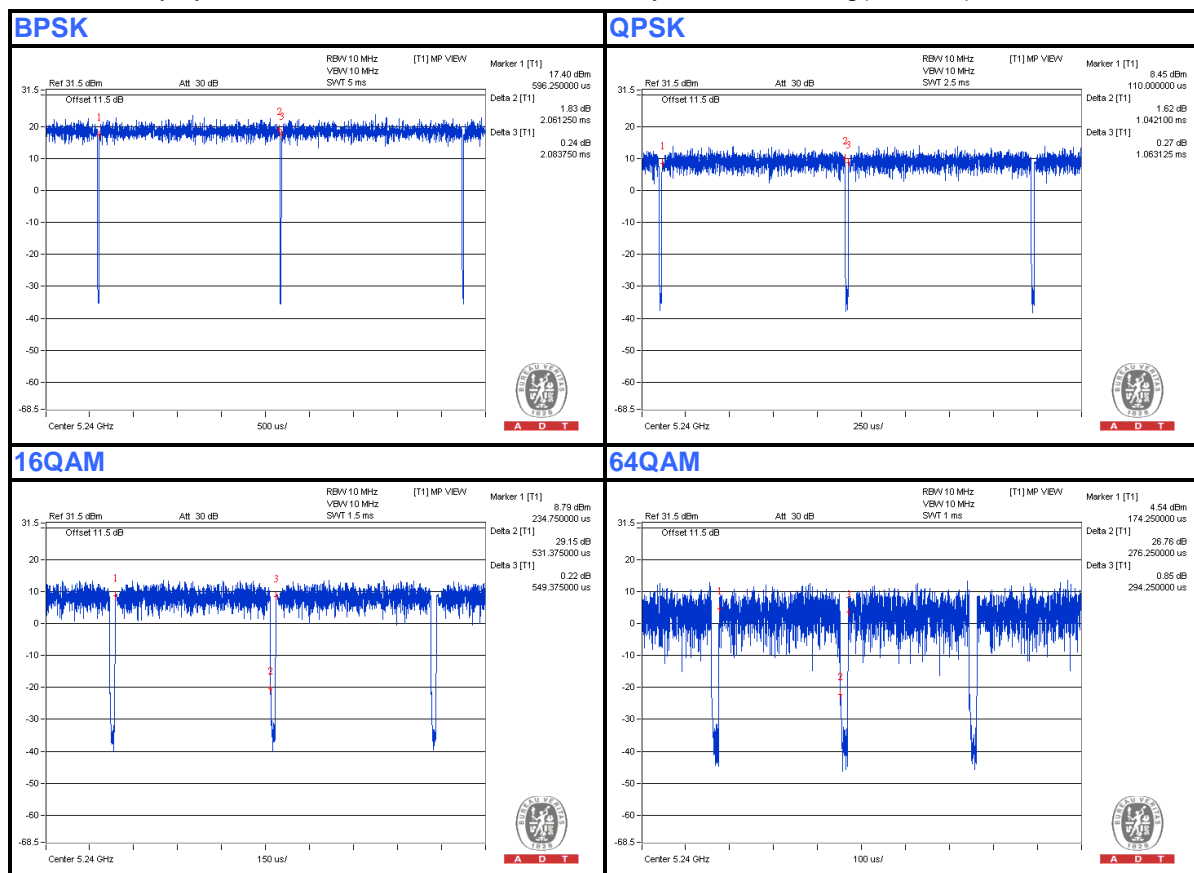



A D T

802.11ac (VHT20)

BPSK: Duty cycle = 1.922 ms/1.942 ms = 0.99

QPSK: Duty cycle = 0.985 ms/1.003 ms = 0.982

16QAM: Duty cycle = 0.511 ms/0.53 ms = 0.964, Duty factor = $10 * \log(1/0.964) = 0.16$

64QAM: Duty cycle = 0.277 ms/0.294 ms = 0.942, Duty factor = $10 * \log(1/0.942) = 0.26$

256QAM: Duty cycle = 0.2 ms/0.22 ms = 0.917, Duty factor = $10 * \log(1/0.917) = 0.37$

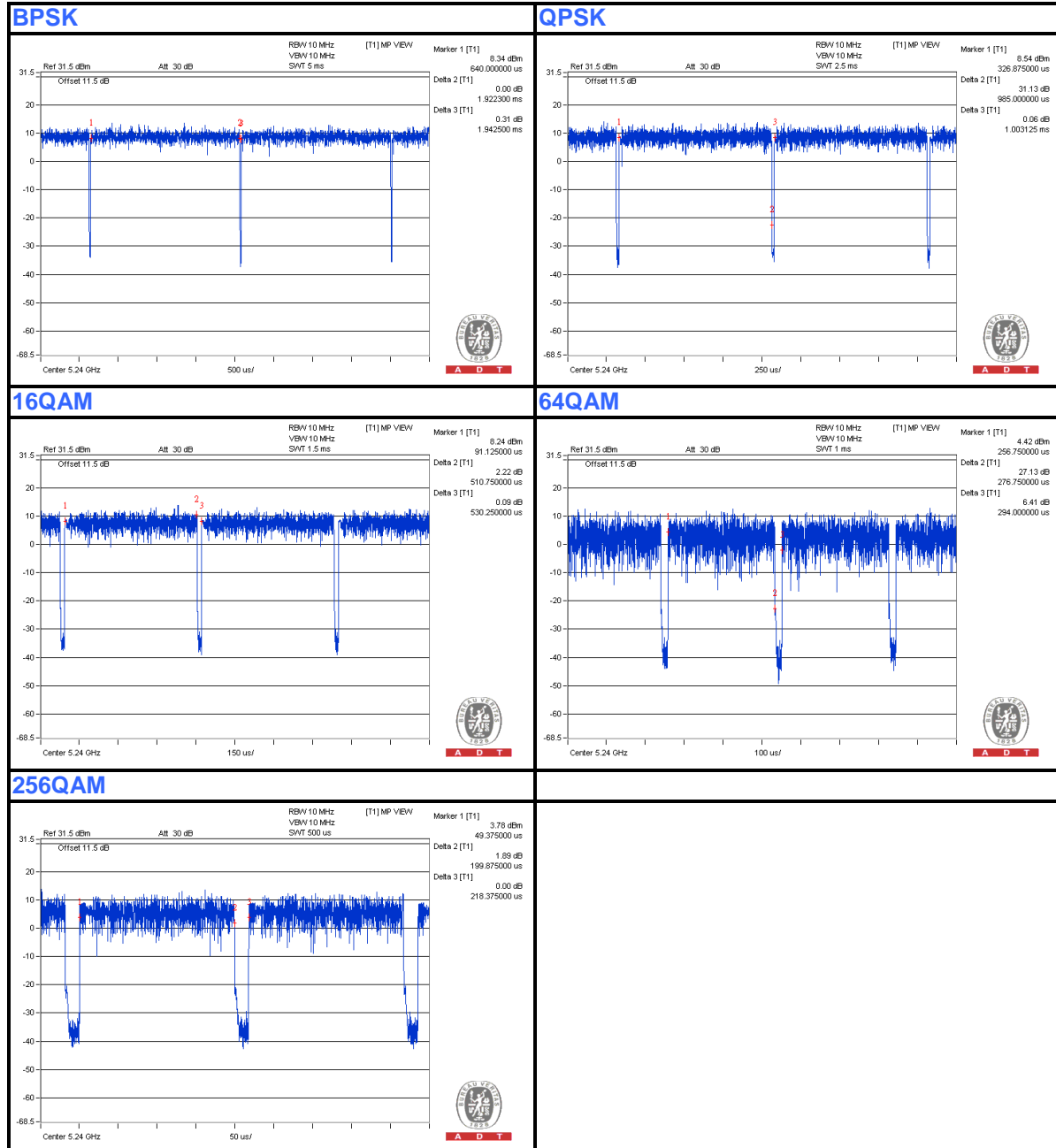



A D T

802.11ac (VHT40)

BPSK: Duty cycle = 0.95 ms/0.969 ms = 0.98

QPSK: Duty cycle = 0.496 ms/0.514 ms = 0.965, Duty factor = $10 * \log(1/0.965) = 0.15$

16QAM: Duty cycle = 0.27 ms/0.288 ms = 0.938, Duty factor = $10 * \log(1/0.938) = 0.28$

64QAM: Duty cycle = 0.156 ms/0.174 ms = 0.897, Duty factor = $10 * \log(1/0.897) = 0.47$

256QAM: Duty cycle = 0.116 ms/0.13 ms = 0.866, Duty factor = $10 * \log(1/0.866) = 0.63$

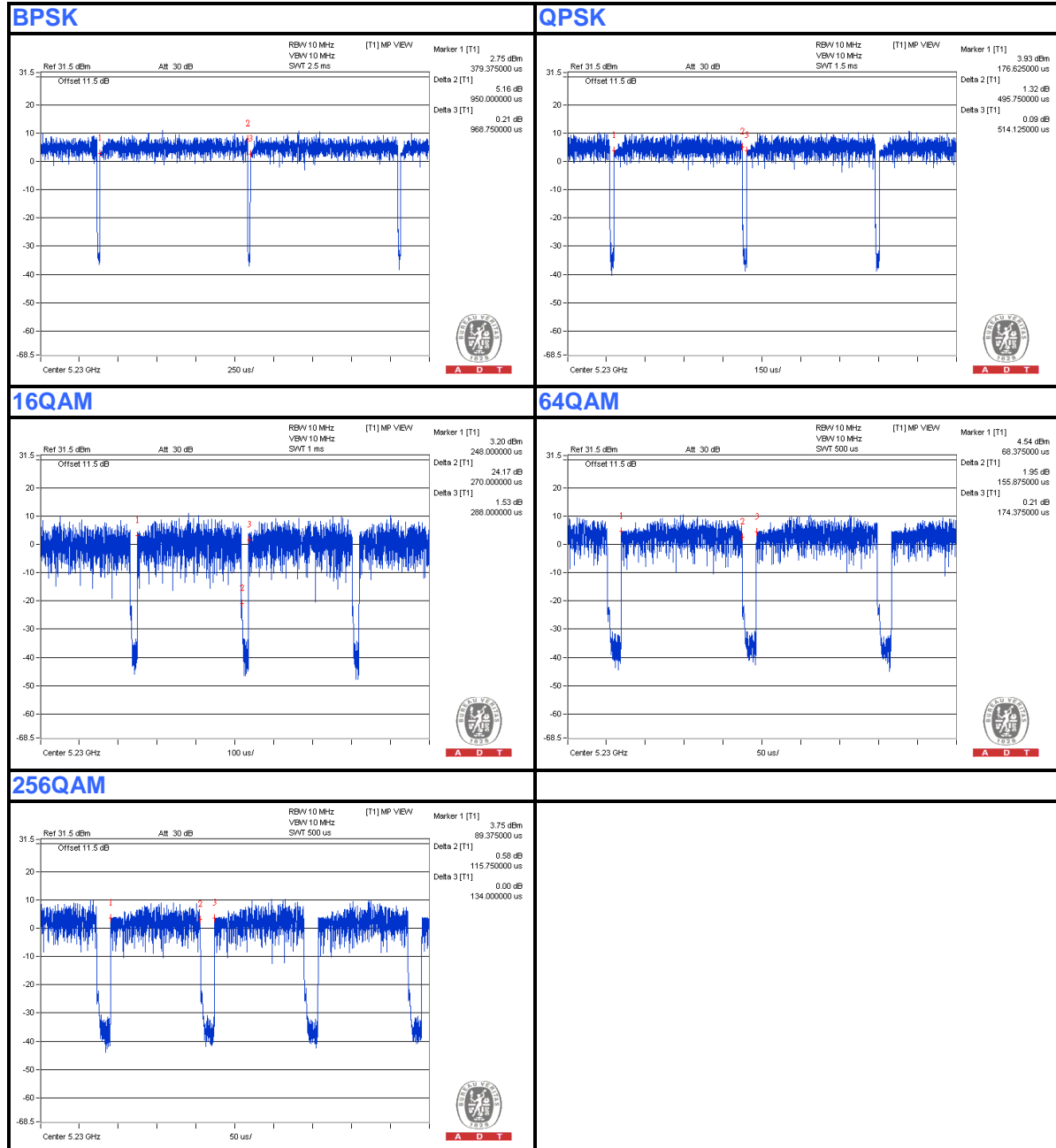



A D T

802.11ac (VHT80)

BPSK: Duty cycle = 0.461 ms/0.478 ms = 0.964, Duty factor = $10 \cdot \log(1/0.964) = 0.16$

QPSK: Duty cycle = 0.252 ms/0.27 ms = 0.933, Duty factor = $10 \cdot \log(1/0.933) = 0.3$

16QAM: Duty cycle = 0.147 ms/0.166 ms = 0.886, Duty factor = $10 \cdot \log(1/0.886) = 0.53$

64QAM: Duty cycle = 0.096 ms/0.114 ms = 0.842, Duty factor = $10 \cdot \log(1/0.842) = 0.75$

256QAM: Duty cycle = 0.076 ms/0.09 ms = 0.809, Duty factor = $10 \cdot \log(1/0.809) = 0.92$

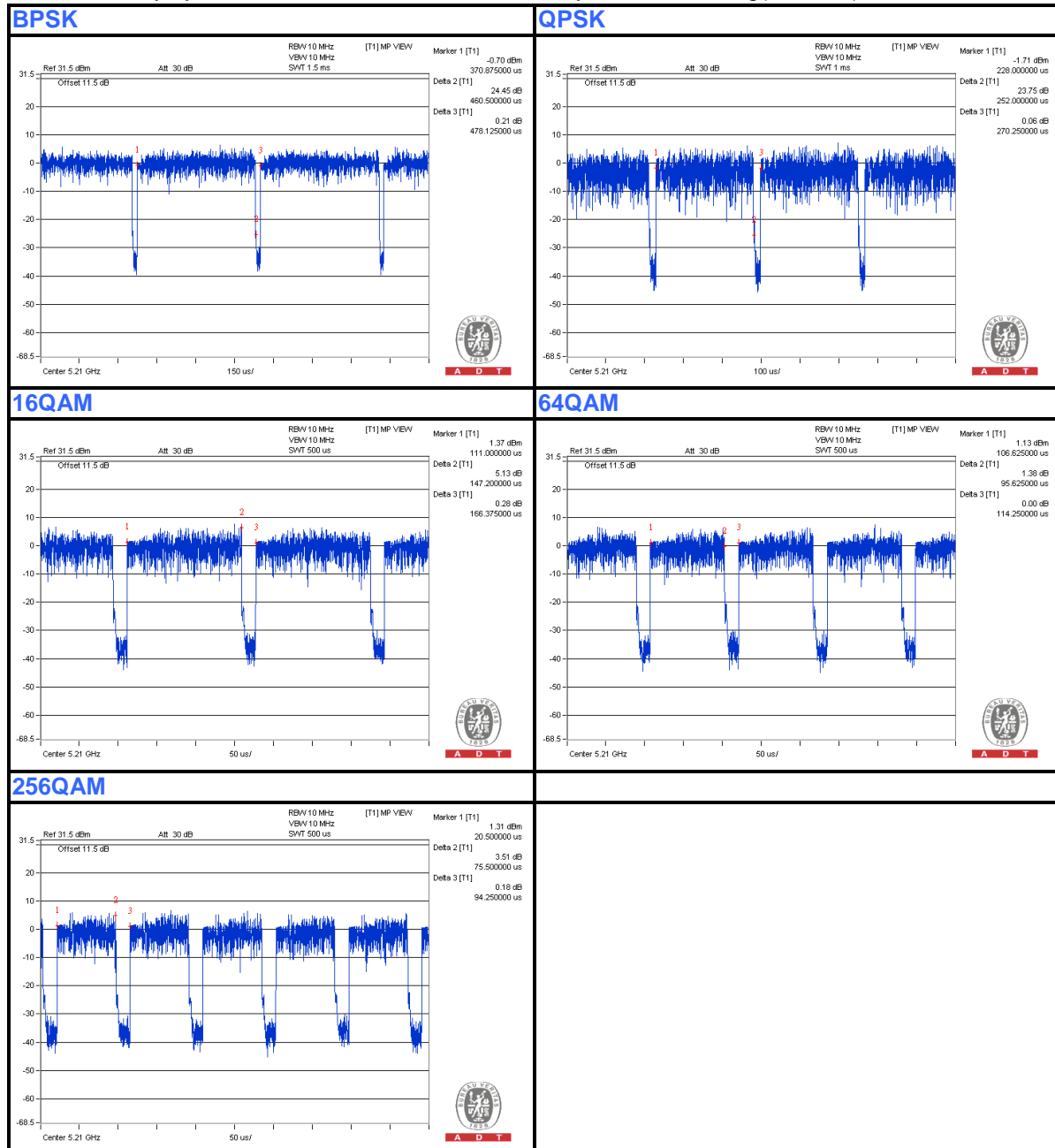



A D T

3.5 DESCRIPTION OF SUPPORT UNITS

The EUT has been tested as an independent unit together with other necessary accessories or support units. The following support units or accessories were used to form a representative test configuration during the tests.

NO.	PRODUCT	BRAND	MODEL NO.	SERIAL NO.	FCC ID
1	NOTEBOOK COMPUTER	DELL	PP32LA	FSLB32S	FCC DoC
2	NOTEBOOK COMPUTER	DELL	PP32LA	GSLB32S	FCC DoC
3	CO-ROUTER	ZyXEL	IES-1000	S4Z3112558	NA
4	HUB	ZyXEL	ES-116P	S060H0200021 5	FCC DoC
5	iPod shuffle	Apple	MC749TA/A	CC4DMFJUDFD M	NA
6	External Hard Drive	WD	WDBACW0010H BK-SESN	WCAZAL62578 7	FCC DoC
7	USB 3.0 Flash disk	ADATA	C103	NA	NA

NO.	SIGNAL CABLE DESCRIPTION OF THE ABOVE SUPPORT UNITS
1	UTP Cable, 10m
2	UTP Cable, 10m
3	RJ-11 Cable, 10m
4	UTP Cable, 10m
5	USB Cable, 0.1m
6	USB Cable, 0.5m
7	NA

NOTE: All power cords of the above support units are non shielded (1.8m).

3.6 CONFIGURATION OF SYSTEM UNDER TEST

For Conducted Emission Test:

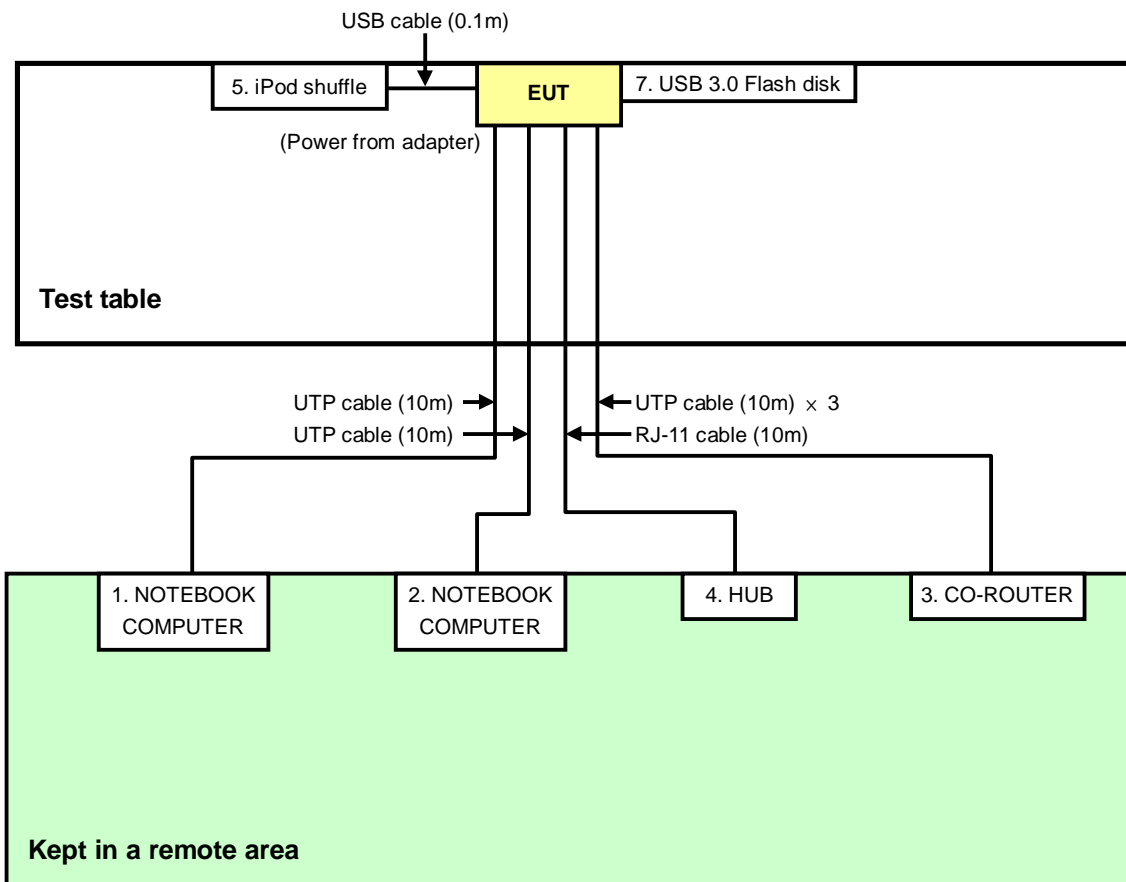

For Radiated Emission Test:

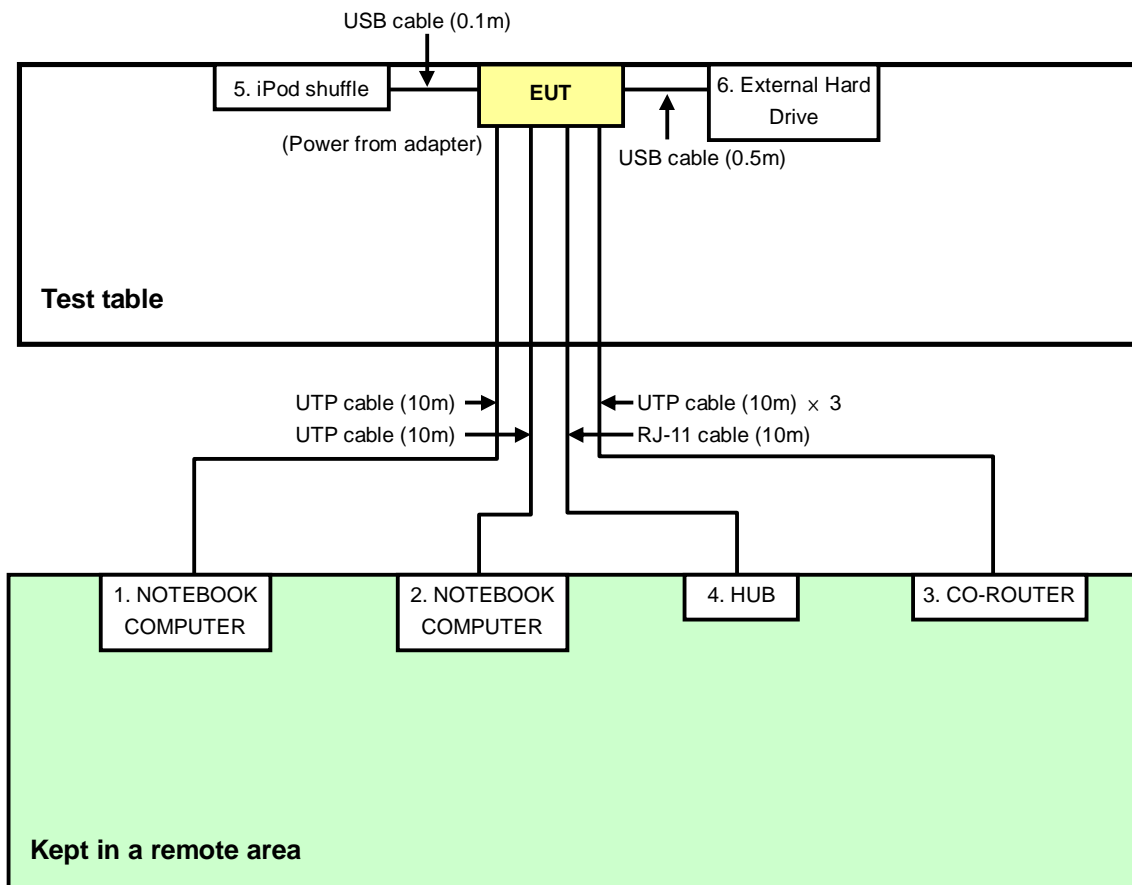

4. TEST TYPES AND RESULTS

4.1 CONDUCTED EMISSION MEASUREMENT

4.1.1 LIMITS OF CONDUCTED EMISSION MEASUREMENT

FREQUENCY OF EMISSION (MHz)	CONDUCTED LIMIT (dB μ V)	
	Quasi-peak	Average
0.15-0.5	66 to 56	56 to 46
0.5-5	56	46
5-30	60	50

- NOTE:**
1. The lower limit shall apply at the transition frequencies.
 2. The limit decreases in line with the logarithm of the frequency in the range of 0.15 to 0.50 MHz.

4.1.2 TEST INSTRUMENTS

DESCRIPTION & MANUFACTURER	MODEL NO.	SERIAL NO.	CALIBRATED DATE	CALIBRATED UNTIL
Test Receiver ROHDE & SCHWARZ	ESCS 30	100287	Feb. 28, 2013	Feb. 27, 2014
Line-Impedance Stabilization Network (for EUT) ROHDE & SCHWARZ	NSLK-8127	5127-523	Oct. 02, 2013	Oct. 01, 2014
Line-Impedance Stabilization Network (for Peripheral) ROHDE & SCHWARZ	ENV216	100071	Nov. 13, 2013	Nov. 12, 2014
RF Cable (JYEBAO)	5DFB	COACAB-001	May 27, 2013	May 26, 2014
50 ohms Terminator	50	3	Oct. 17, 2013	Oct. 16, 2014
50 ohms Terminator	N/A	EMC-04	Oct. 17, 2013	Oct. 16, 2014
Software ADT	BV ADT_Cond_V7.3.7 .3	NA	NA	NA

Note:

1. The calibration interval of the above test instruments is 12 months and the calibrations are traceable to NML/ROC and NIST/USA.
2. The test was performed in Shielded Room No. A.
3. The VCCI Con A Registration No. is C-817.
4. Tested Date: Dec. 25, 2013

4.1.3 TEST PROCEDURES

- a. The EUT was placed 0.4 meters from the conducting wall of the shielded room with EUT being connected to the power mains through a line impedance stabilization network (LISN). Other support units were connected to the power mains through another LISN.
- b. The two LISNs provide 50 ohm/ 50uH of coupling impedance for the measuring instrument.
- c. Both lines of the power mains connected to the EUT were checked for maximum conducted interference.
- d. The frequency range from 150kHz to 30MHz was searched. Emission level under (Limit – 20dB) was not recorded.

NOTE:

1. The resolution bandwidth of test receiver is 9kHz for Quasi-peak detection (QP) & Average detection (AV).

4.1.4 DEVIATION FROM TEST STANDARD

No deviation

4.1.5 TEST SETUP

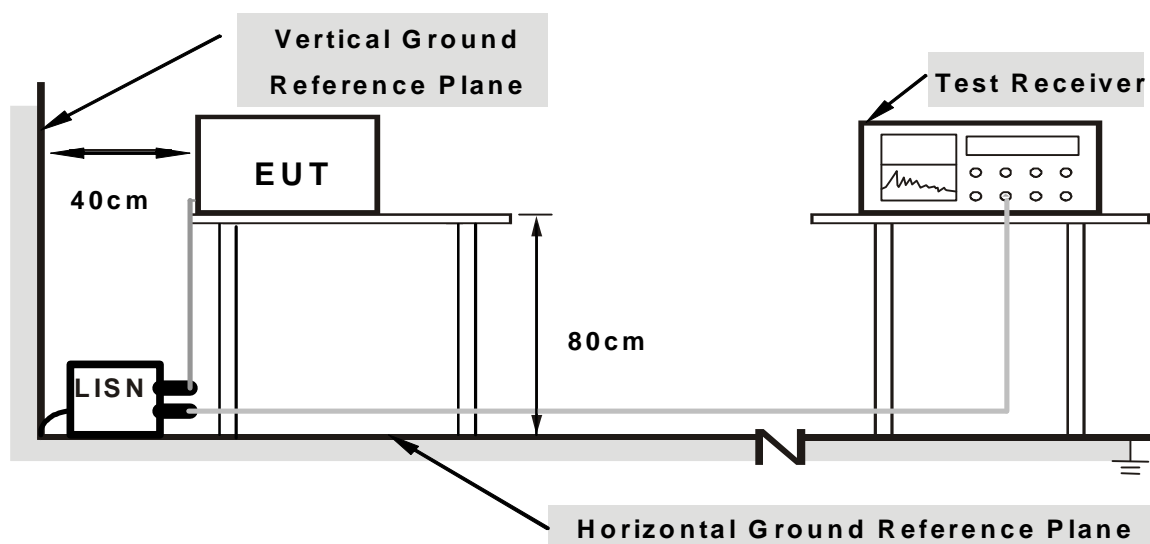

Note: 1.Support units were connected to second LISN.

For the actual test configuration, please refer to the related item – Photographs of the Test Configuration.



A D T

4.1.6 EUT OPERATING CONDITIONS

1. Place the EUT on testing table.
2. Prepare computer system (support unit 1) to act as communication partner.
3. The communication partner runs test program "Mtool_2.0.1.0.exe" to enable EUT under transmission/receiving condition continuously at specific channel frequency.

4.1.7 TEST RESULTS (MODE 1)

PHASE	Line (L)	DETECTOR FUNCTION	Quasi-Peak (QP) / Average (AV)
--------------	----------	--------------------------	--------------------------------

No	Freq.	Corr.	Reading Value		Emission Level		Limit		Margin	
	[MHz]	Factor	[dB (uV)]		[dB (uV)]		[dB (uV)]		(dB)	
		(dB)	Q.P.	AV.	Q.P.	AV.	Q.P.	AV.	Q.P.	AV.
1	0.16562	0.07	52.69	43.97	52.76	44.04	65.18	55.18	-12.41	-11.13
2	0.20078	0.08	47.16	38.11	47.24	38.19	63.58	53.58	-16.34	-15.39
3	0.24766	0.09	43.16	33.59	43.25	33.68	61.84	51.84	-18.58	-18.15
4	0.29063	0.11	41.76	32.82	41.87	32.93	60.51	50.51	-18.64	-17.58
5	0.46641	0.14	42.25	33.29	42.39	33.43	56.58	46.58	-14.18	-13.14
6	0.68516	0.16	37.69	30.82	37.85	30.98	56.00	46.00	-18.15	-15.02

REMARKS:

1. Q.P. and AV. are abbreviations of quasi-peak and average individually.
2. The emission levels of other frequencies were very low against the limit.
3. Margin value = Emission Level – Limit value
4. Correction Factor = Insertion loss + Cable loss
5. Emission Level = Correction Factor + Reading Value

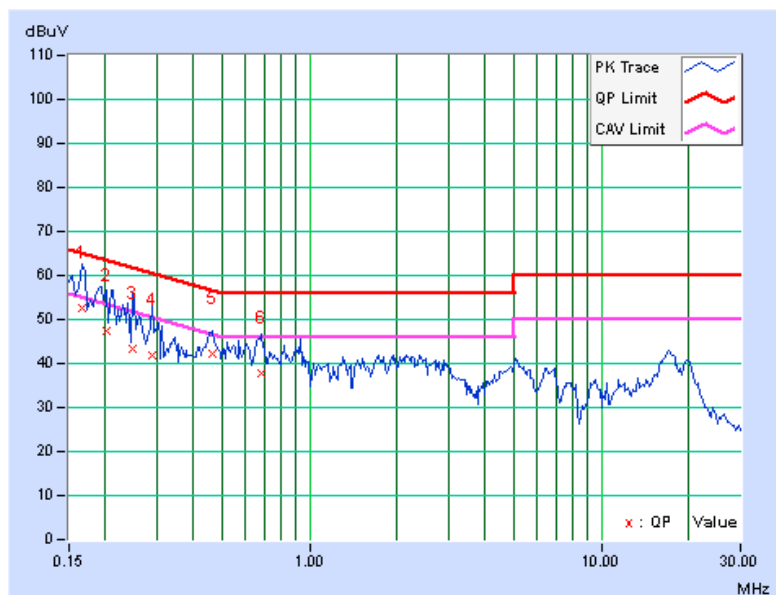



A D T

PHASE	Neutral (N)	DETECTOR FUNCTION	Quasi-Peak (QP) / Average (AV)
--------------	-------------	--------------------------	--------------------------------

No	Freq. [MHz]	Corr. Factor (dB)	Reading Value [dB (uV)]		Emission Level [dB (uV)]		Limit [dB (uV)]		Margin (dB)	
			Q.P.	AV.	Q.P.	AV.	Q.P.	AV.	Q.P.	AV.
1	0.15391	0.07	53.19	40.07	53.26	40.14	65.79	55.79	-12.53	-15.65
2	0.18906	0.07	50.02	34.34	50.09	34.41	64.08	54.08	-13.99	-19.67
3	0.22812	0.08	46.69	37.43	46.77	37.51	62.52	52.52	-15.75	-15.01
4	0.28672	0.10	44.32	37.79	44.42	37.89	60.62	50.62	-16.20	-12.73
5	0.50547	0.15	46.97	39.29	47.12	39.44	56.00	46.00	-8.88	-6.56
6	0.77109	0.16	43.20	36.70	43.36	36.86	56.00	46.00	-12.64	-9.14

REMARKS:

1. Q.P. and AV. are abbreviations of quasi-peak and average individually.
2. The emission levels of other frequencies were very low against the limit.
3. Margin value = Emission Level – Limit value
4. Correction Factor = Insertion loss + Cable loss
5. Emission Level = Correction Factor + Reading Value

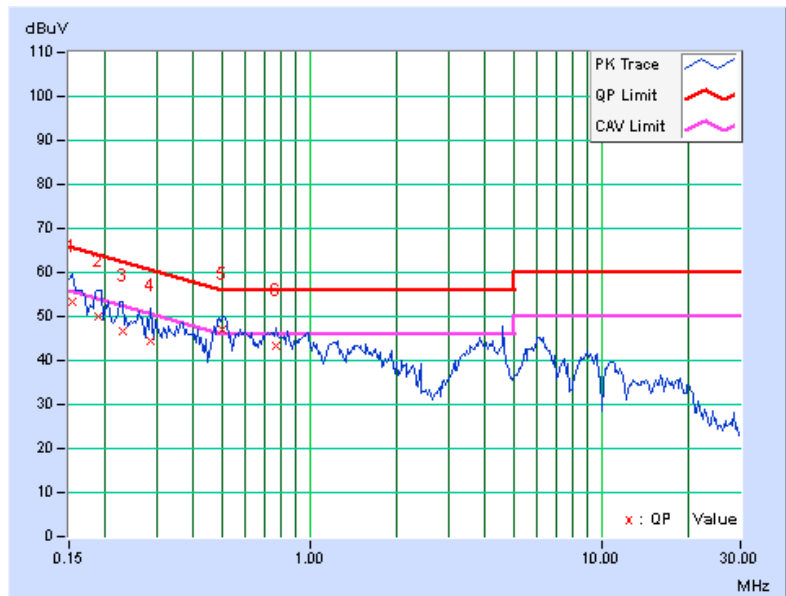

4.1.8 TEST RESULTS (MODE 2)

PHASE	Line (L)	DETECTOR FUNCTION	Quasi-Peak (QP) / Average (AV)
--------------	----------	--------------------------	--------------------------------

No	Freq.	Corr.	Reading Value		Emission Level		Limit		Margin	
	[MHz]	Factor	[dB (uV)]	[dB (uV)]	[dB (uV)]	[dB (uV)]	[dB (uV)]	[dB (uV)]	[dB (uV)]	[dB (uV)]
		(dB)	Q.P.	AV.	Q.P.	AV.	Q.P.	AV.	Q.P.	AV.
1	0.16066	0.07	57.64	47.18	57.71	47.25	65.43	55.43	-7.72	-8.18
2	0.18906	0.08	53.69	38.56	53.77	38.64	64.08	54.08	-10.31	-15.44
3	0.23203	0.09	47.99	33.59	48.08	33.68	62.38	52.38	-14.30	-18.70
4	0.26719	0.10	44.91	31.03	45.01	31.13	61.20	51.20	-16.19	-20.07
5	0.33750	0.12	41.64	25.16	41.76	25.28	59.26	49.26	-17.50	-23.98
6	0.44297	0.14	39.89	26.86	40.03	27.00	57.01	47.01	-16.97	-20.00

REMARKS:

1. Q.P. and AV. are abbreviations of quasi-peak and average individually.
2. The emission levels of other frequencies were very low against the limit.
3. Margin value = Emission Level – Limit value
4. Correction Factor = Insertion loss + Cable loss
5. Emission Level = Correction Factor + Reading Value

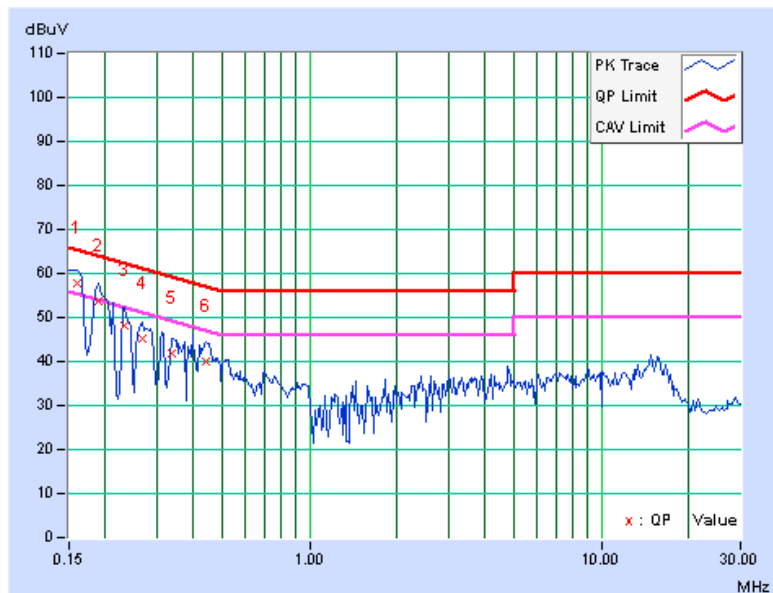

PHASE	Neutral (N)	DETECTOR FUNCTION	Quasi-Peak (QP) / Average (AV)
--------------	-------------	--------------------------	--------------------------------

No	Freq. [MHz]	Corr. Factor (dB)	Reading Value [dB (uV)]		Emission Level [dB (uV)]		Limit [dB (uV)]		Margin (dB)	
			Q.P.	AV.	Q.P.	AV.	Q.P.	AV.	Q.P.	AV.
1	0.15781	0.07	58.38	47.20	58.45	47.27	65.58	55.58	-7.13	-8.31
2	0.19297	0.07	53.25	39.34	53.32	39.41	63.91	53.91	-10.59	-14.50
3	0.22016	0.08	46.65	26.66	46.73	26.74	62.81	52.81	-16.09	-26.08
4	0.26719	0.09	46.88	29.93	46.97	30.02	61.20	51.20	-14.23	-21.18
5	0.30625	0.11	43.50	32.86	43.61	32.97	60.07	50.07	-16.46	-17.10
6	0.38047	0.13	42.67	28.15	42.80	28.28	58.27	48.27	-15.47	-19.99

REMARKS:

1. Q.P. and AV. are abbreviations of quasi-peak and average individually.
2. The emission levels of other frequencies were very low against the limit.
3. Margin value = Emission Level – Limit value
4. Correction Factor = Insertion loss + Cable loss
5. Emission Level = Correction Factor + Reading Value

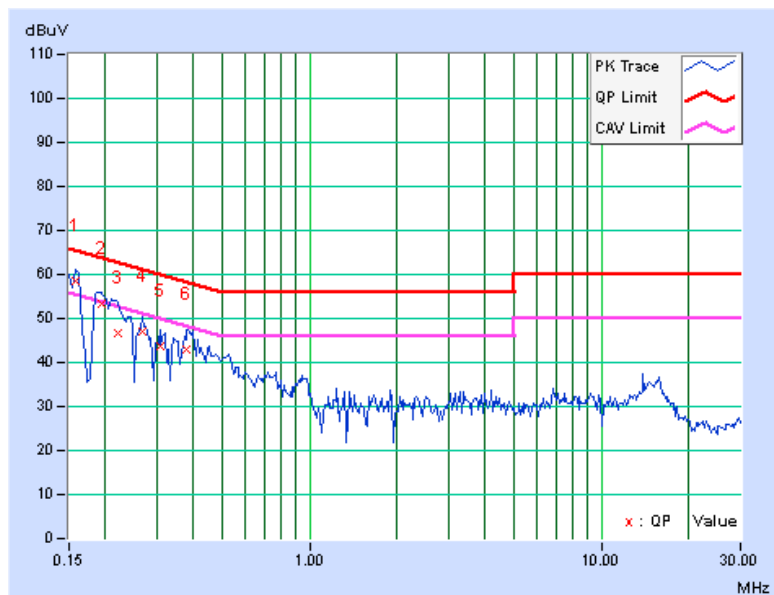



A D T

4.2 RADIATED EMISSION AND BANDEGE MEASUREMENT

4.2.1 LIMITS OF RADIATED EMISSION AND BANDEGE MEASUREMENT

Radiated emissions which fall in the restricted bands must comply with the radiated emission limits specified as below table:

Frequencies (MHz)	Field strength (microvolts/meter)	Measurement distance (meters)
0.009-0.490	2400/F(kHz)	300
0.490-1.705	24000/F(kHz)	30
1.705-30.0	30	30
30-88	100	3
88-216	150	3
216-960	200	3
Above 960	500	3

NOTE:

1. The lower limit shall apply at the transition frequencies.
2. Emission level (dBuV/m) = 20 log Emission level (uV/m).
3. For frequencies above 1000MHz, the field strength limits are based on average detector, however, the peak field strength of any emission shall not exceed the maximum permitted average limits, specified above by more than 20dB under any condition of modulation.

4.2.2 LIMITS OF UNWANTED EMISSION OUT OF THE RESTRICTED BANDS

APPLICABLE TO	LIMIT	
		FIELD STRENGTH AT 3m (dBμV/m)
	PK	AV
	74	54
√	EIRP LIMIT (dBm)	EQUIVALENT FIELD STRENGTH AT 3m (dBμV/m)
	PK	PK
	-27	68.3

NOTE:

1. The following formula is used to convert the equipment isotropic radiated power (eirp) to field strength:

$$E = \frac{1000000\sqrt{30P}}{3} \mu\text{V/m, where P is the eirp (Watts).}$$



A D T

4.2.3 TEST INSTRUMENTS

DESCRIPTION & MANUFACTURER	MODEL NO.	SERIAL NO.	CALIBRATED DATE	CALIBRATED UNTIL
MXE EMI Receiver Agilent	N9038A	MY51210105	Jan. 29,2013	Jan. 28,2014
Pre-Amplifier Mini-Circuits	ZFL-1000VH2 B	AMP-ZFL-03	Nov. 13, 2013	Nov. 12, 2014
Trilog Broadband Antenna SCHWARZBECK	VULB 9168	9168-360	Mar. 19, 2013	Mar. 18, 2014
RF Cable	NA	CHGCAB_001	Oct. 05, 2013	Oct. 04, 2014
Spectrum Analyzer R&S	FSV40	100964	July 15, 2013	July 14, 2014
Horn_Antenna AISL	AIH.8018	0000320091110	Nov. 18, 2013	Nov. 17, 2014
Pre-Amplifier Agilent	8449B	3008A02578	June 25, 2013	June 24, 2014
RF Cable	NA	RF104-201 RF104-203 RF104-204	Dec. 12, 2013	Dec. 11, 2014
Spectrum Analyzer Agilent	E4446A	MY48250253	Aug. 28, 2013	Aug. 27, 2014
Pre-Amplifier SPACEK LABS	SLKKa-48-6	9K16	Nov. 13, 2013	Nov. 12, 2014
Horn_Antenna SCHWARZBECK	BBHA 9170	9170-424	Oct. 08, 2013	Oct. 07, 2014
Software	ADT_Radiated _V8.7.07	NA	NA	NA
Antenna Tower & Turn Table CT	NA	NA	NA	NA

Note:

1. The calibration interval of the above test instruments is 12 months and the calibrations are traceable to NML/ROC and NIST/USA.
2. The horn antenna, preamplifier (model: 8449B) are used only for the measurement of emission frequency above 1GHz if tested.
3. The test was performed in 966 Chamber No. G.
4. The FCC Site Registration No. is 966073.
5. The VCCI Site Registration No. is G-137.
6. The CANADA Site Registration No. is IC 7450H-2.
7. Tested Date: Dec. 25, 2013 to Jan. 07, 2014

4.2.4 TEST PROCEDURES

- a. The EUT was placed on the top of a rotating table 0.8 meters above the ground at 3 meter chamber room for test. The table was rotated 360 degrees to determine the position of the highest radiation.
- b. The EUT was set 3 meters away from the interference-receiving antenna, which was mounted on the top of a variable-height antenna tower.
- c. The height of antenna is varied from one meter to four meters above the ground to determine the maximum value of the field strength. Both horizontal and vertical polarizations of the antenna are set to make the measurement.
- d. For each suspected emission, the EUT was arranged to its worst case and then the antenna was tuned to heights from 1 meter to 4 meters and the rotatable table was turned from 0 degrees to 360 degrees to find the maximum reading.
- e. The test-receiver system was set to quasi-peak detect function and specified bandwidth with maximum hold mode when the test frequency is below 1 GHz.
- f. The test-receiver system was set to peak and average detect function and specified bandwidth with maximum hold mode when the test frequency is above 1 GHz. If the peak reading value also meets average limit, measurement with the average detector is unnecessary.

Note:

1. The resolution bandwidth and video bandwidth of test receiver/spectrum analyzer is 120kHz for Quasi-peak detection (QP) at frequency below 1GHz.
2. The resolution bandwidth of test receiver/spectrum analyzer is 1 MHz and the video bandwidth is 3 MHz for Peak detection (PK) at frequency above 1GHz.
3. The resolution bandwidth of test receiver/spectrum analyzer is 1MHz and the video bandwidth is 3MHz for RMS Average (Duty cycle < 98%) for Average detection (AV) at frequency above 1GHz, then the measurement results was added to a correction factor ($10 \log(1/\text{duty cycle})$).
4. The resolution bandwidth of test receiver/spectrum analyzer is 1MHz and the video bandwidth is 10Hz (Duty cycle $\geq 98\%$) for Average detection (AV) at frequency above 1GHz.
5. All modes of operation were investigated and the worst-case emissions are reported.

4.2.5 DEVIATION FROM TEST STANDARD

No deviation

4.2.6 TEST SETUP

<Frequency Range below 1GHz>

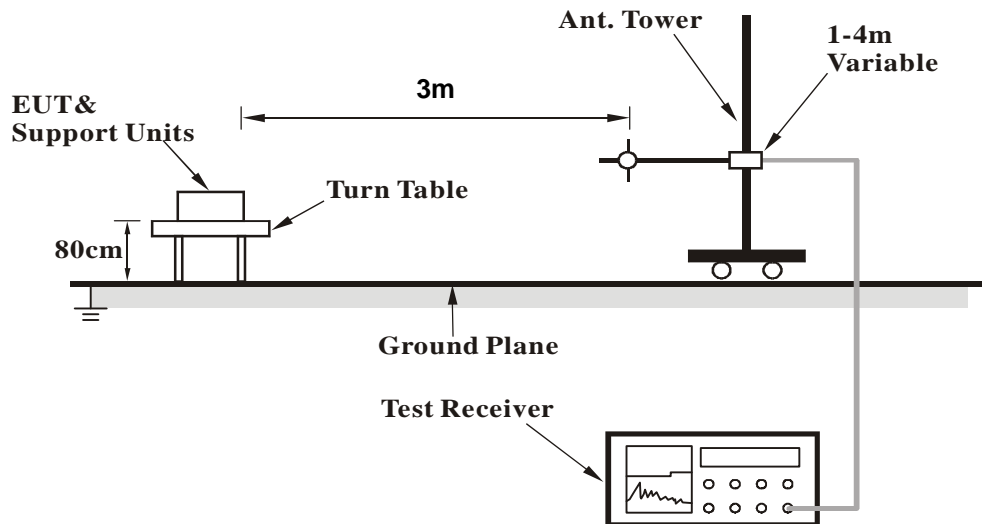

<Frequency Range above 1GHz>

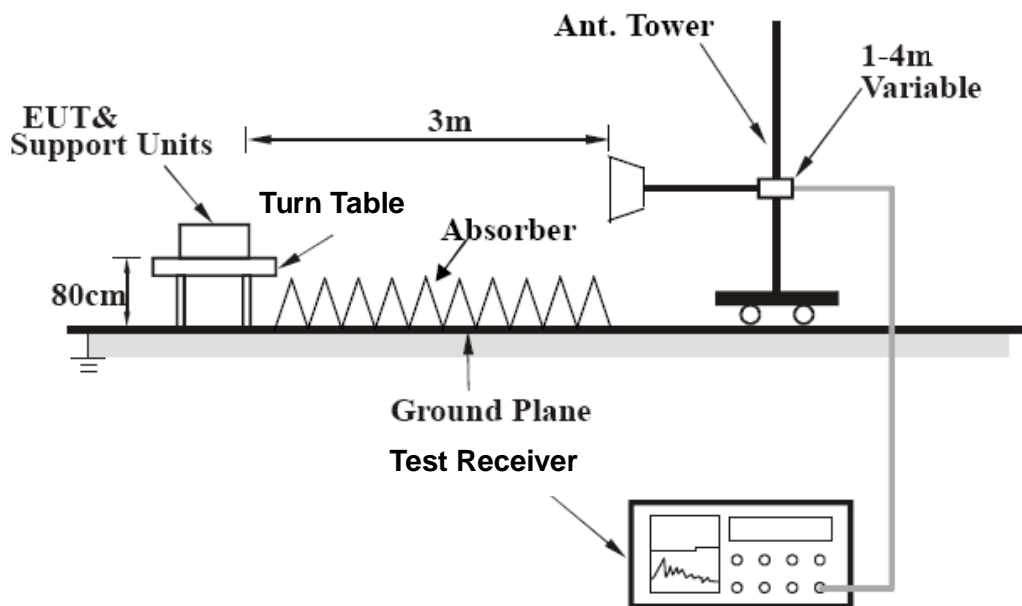

For the actual test configuration, please refer to the related item – Photographs of the Test Configuration.

4.2.7 EUT OPERATING CONDITION

Same as 4.1.6



A D T

4.2.8 TEST RESULTS

BELOW 1GHz WORST-CASE DATA

802.11ac (VHT20)

CHANNEL	TX Channel 48	DETECTOR FUNCTION	Quasi-Peak (QP)
FREQUENCY RANGE	Below 1GHz		

ANTENNA POLARITY & TEST DISTANCE: HORIZONTAL AT 3 M

NO.	FREQ. (MHz)	EMISSION LEVEL (dBuV/m)	LIMIT (dBuV/m)	MARGIN (dB)	ANTENNA HEIGHT (m)	TABLE ANGLE (Degree)	RAW VALUE (dBuV)	CORRECTION FACTOR (dB/m)
1	108.38	34.7 QP	43.5	-8.8	1.50 H	143	51.08	-16.40
2	125.10	33.3 QP	43.5	-10.2	2.00 H	33	48.10	-14.81
3	162.06	32.5 QP	43.5	-11.0	1.50 H	333	45.68	-13.15
4	270.43	32.1 QP	46.0	-13.9	1.50 H	17	45.63	-13.53
5	287.50	34.3 QP	46.0	-11.8	1.50 H	314	47.11	-12.86
6	320.96	32.0 QP	46.0	-14.0	1.00 H	35	43.74	-11.72

ANTENNA POLARITY & TEST DISTANCE: VERTICAL AT 3 M

NO.	FREQ. (MHz)	EMISSION LEVEL (dBuV/m)	LIMIT (dBuV/m)	MARGIN (dB)	ANTENNA HEIGHT (m)	TABLE ANGLE (Degree)	RAW VALUE (dBuV)	CORRECTION FACTOR (dB/m)
1	109.26	38.6 QP	43.5	-4.9	1.50 V	217	54.79	-16.16
2	130.20	35.5 QP	43.5	-8.0	1.00 V	234	50.21	-14.73
3	162.50	30.8 QP	43.5	-12.7	1.50 V	282	44.05	-13.25
4	270.30	32.4 QP	46.0	-13.6	1.00 V	200	45.93	-13.54
5	305.29	29.6 QP	46.0	-16.4	1.50 V	137	41.99	-12.38
6	400.00	31.3 QP	46.0	-14.7	1.50 V	351	41.21	-9.91

REMARKS:

1. Emission Level(dBuV/m) = Raw Value(dBuV) + Correction Factor(dB/m)
2. Correction Factor(dB/m) = Antenna Factor(dB/m) + Cable Factor(dB) – Pre-Amplifier Factor(dB)
3. The other emission levels were very low against the limit.
4. Margin value = Emission Level – Limit value



A D T

ABOVE 1GHz DATA

802.11a

CHANNEL	TX Channel 36	DETECTOR FUNCTION	Peak (PK)
FREQUENCY RANGE	1GHz ~ 40GHz		Average (AV)

ANTENNA POLARITY & TEST DISTANCE: HORIZONTAL AT 3 M

NO.	FREQ. (MHz)	EMISSION LEVEL (dBuV/m)	LIMIT (dBuV/m)	MARGIN (dB)	ANTENNA HEIGHT (m)	TABLE ANGLE (Degree)	RAW VALUE (dBuV)	CORRECTION FACTOR (dB/m)
1	5100.00	55.0 PK	74.0	-19.0	1.58 H	146	47.20	7.80
2	5100.00	44.9 AV	54.0	-9.1	1.58 H	146	37.10	7.80
3	5150.00	56.6 PK	74.0	-17.4	1.58 H	146	48.70	7.90
4	5150.00	44.6 AV	54.0	-9.4	1.58 H	146	36.70	7.90
5	*5180.00	106.7 PK			1.58 H	146	98.80	7.90
6	*5180.00	96.4 AV			1.58 H	146	88.50	7.90
7	#5612.00	57.8 PK	68.3	-10.5	1.58 H	146	48.60	9.20
8	#10000.00	59.2 PK	68.3	-9.1	1.12 H	149	45.20	14.00
9	#10360.00	54.7 PK	68.3	-13.6	1.00 H	99	40.30	14.40
10	15540.00	62.5 PK	74.0	-11.5	1.00 H	38	42.30	20.20
11	15540.00	47.3 AV	54.0	-6.7	1.00 H	38	27.10	20.20

ANTENNA POLARITY & TEST DISTANCE: VERTICAL AT 3 M

NO.	FREQ. (MHz)	EMISSION LEVEL (dBuV/m)	LIMIT (dBuV/m)	MARGIN (dB)	ANTENNA HEIGHT (m)	TABLE ANGLE (Degree)	RAW VALUE (dBuV)	CORRECTION FACTOR (dB/m)
1	5100.00	63.9 PK	74.0	-10.1	1.00 V	258	56.10	7.80
2	5100.00	53.0 AV	54.0	-1.0	1.00 V	258	45.20	7.80
3	5150.00	68.4 PK	74.0	-5.6	1.00 V	258	60.50	7.90
4	5150.00	53.5 AV	54.0	-0.5	1.00 V	258	45.60	7.90
5	*5180.00	116.1 PK			1.00 V	258	108.20	7.90
6	*5180.00	106.3 AV			1.00 V	258	98.40	7.90
7	#5612.00	58.6 PK	68.3	-9.7	1.00 V	258	49.40	9.20
8	#10000.00	59.4 PK	68.3	-8.9	1.06 V	88	45.40	14.00
9	#10360.00	54.5 PK	68.3	-13.8	1.07 V	87	40.10	14.40
10	15540.00	58.9 PK	74.0	-15.1	1.00 V	22	38.70	20.20
11	15540.00	46.2 AV	54.0	-7.8	1.00 V	22	26.00	20.20

REMARKS:

1. Emission Level(dBuV/m) = Raw Value(dBuV) + Correction Factor(dB/m)
2. Correction Factor(dB/m) = Antenna Factor(dB/m) + Cable Factor(dB) – Pre-Amplifier Factor(dB)
3. The other emission levels were very low against the limit.
4. Margin value = Emission Level – Limit value
5. " * ": Fundamental frequency.
6. " # ": The radiated frequency is out of the restricted band.



A D T

CHANNEL	TX Channel 40	DETECTOR FUNCTION	Peak (PK)
FREQUENCY RANGE	1GHz ~ 40GHz		Average (AV)

ANTENNA POLARITY & TEST DISTANCE: HORIZONTAL AT 3 M

NO.	FREQ. (MHz)	EMISSION LEVEL (dBuV/m)	LIMIT (dBuV/m)	MARGIN (dB)	ANTENNA HEIGHT (m)	TABLE ANGLE (Degree)	RAW VALUE (dBuV)	CORRECTION FACTOR (dB/m)
1	5121.00	57.5 PK	74.0	-16.5	1.52 H	157	49.60	7.90
2	5121.00	46.0 AV	54.0	-8.0	1.52 H	157	38.10	7.90
3	*5200.00	106.9 PK			1.61 H	150	99.00	7.90
4	*5200.00	94.6 AV			1.61 H	150	86.70	7.90
5	5361.00	57.2 PK	74.0	-16.8	1.52 H	157	48.60	8.60
6	5361.00	44.1 AV	54.0	-9.9	1.52 H	157	35.50	8.60
7	5418.00	56.1 PK	74.0	-17.9	1.52 H	157	47.40	8.70
8	5418.00	43.6 AV	54.0	-10.4	1.52 H	157	34.90	8.70
9	#10400.00	54.6 PK	68.3	-13.7	1.00 H	101	39.90	14.70
10	15600.00	58.5 PK	74.0	-15.5	1.00 H	36	38.40	20.10
11	15600.00	46.6 AV	54.0	-7.4	1.00 H	36	26.50	20.10

ANTENNA POLARITY & TEST DISTANCE: VERTICAL AT 3 M

NO.	FREQ. (MHz)	EMISSION LEVEL (dBuV/m)	LIMIT (dBuV/m)	MARGIN (dB)	ANTENNA HEIGHT (m)	TABLE ANGLE (Degree)	RAW VALUE (dBuV)	CORRECTION FACTOR (dB/m)
1	5121.00	64.6 PK	74.0	-9.4	1.24 V	245	56.70	7.90
2	5121.00	53.4 AV	54.0	-0.6	1.24 V	245	45.50	7.90
3	*5200.00	114.2 PK			1.20 V	242	106.30	7.90
4	*5200.00	104.6 AV			1.20 V	242	96.70	7.90
5	5361.00	62.7 PK	74.0	-11.3	1.18 V	265	54.10	8.60
6	5361.00	52.9 AV	54.0	-1.1	1.18 V	265	44.30	8.60
7	5418.00	60.0 PK	74.0	-14.0	1.18 V	265	51.30	8.70
8	5418.00	48.8 AV	54.0	-5.2	1.18 V	265	40.10	8.70
9	#10400.00	60.2 PK	68.3	-8.1	1.00 V	0	45.50	14.70
10	15600.00	59.3 PK	74.0	-14.7	1.02 V	29	39.20	20.10
11	15600.00	46.6 AV	54.0	-7.4	1.02 V	29	26.50	20.10

REMARKS:

1. Emission Level(dBuV/m) = Raw Value(dBuV) + Correction Factor(dB/m)
2. Correction Factor(dB/m) = Antenna Factor(dB/m) + Cable Factor(dB) – Pre-Amplifier Factor(dB)
3. The other emission levels were very low against the limit.
4. Margin value = Emission Level – Limit value
5. " * ": Fundamental frequency.
6. " # ": The radiated frequency is out of the restricted band.



A D T

CHANNEL	TX Channel 48	DETECTOR FUNCTION	Peak (PK)
FREQUENCY RANGE	1GHz ~ 40GHz		Average (AV)

ANTENNA POLARITY & TEST DISTANCE: HORIZONTAL AT 3 M

NO.	FREQ. (MHz)	EMISSION LEVEL (dBuV/m)	LIMIT (dBuV/m)	MARGIN (dB)	ANTENNA HEIGHT (m)	TABLE ANGLE (Degree)	RAW VALUE (dBuV)	CORRECTION FACTOR (dB/m)
1	*5240.00	105.8 PK			1.00 H	224	97.70	8.10
2	*5240.00	95.0 AV			1.00 H	224	86.90	8.10
3	5350.00	56.7 PK	74.0	-17.3	1.00 H	224	48.30	8.40
4	5350.00	44.1 AV	54.0	-9.9	1.00 H	224	35.70	8.40
5	#10480.00	55.4 PK	68.3	-12.9	1.00 H	98	40.80	14.60
6	15720.00	63.4 PK	74.0	-10.6	1.00 H	37	43.40	20.00
7	15720.00	47.8 AV	54.0	-6.2	1.00 H	37	27.80	20.00

ANTENNA POLARITY & TEST DISTANCE: VERTICAL AT 3 M

NO.	FREQ. (MHz)	EMISSION LEVEL (dBuV/m)	LIMIT (dBuV/m)	MARGIN (dB)	ANTENNA HEIGHT (m)	TABLE ANGLE (Degree)	RAW VALUE (dBuV)	CORRECTION FACTOR (dB/m)
1	*5240.00	116.5 PK			1.11 V	264	108.40	8.10
2	*5240.00	107.2 AV			1.11 V	264	99.10	8.10
3	5350.00	64.0 PK	74.0	-10.0	1.18 V	265	55.60	8.40
4	5350.00	53.6 AV	54.0	-0.4	1.18 V	265	45.20	8.40
5	#10480.00	60.8 PK	68.3	-7.5	1.00 V	0	46.20	14.60
6	15720.00	59.4 PK	74.0	-14.6	1.06 V	44	39.40	20.00
7	15720.00	46.9 AV	54.0	-7.1	1.06 V	44	26.90	20.00

REMARKS:

1. Emission Level(dBuV/m) = Raw Value(dBuV) + Correction Factor(dB/m)
2. Correction Factor(dB/m) = Antenna Factor(dB/m) + Cable Factor(dB) – Pre-Amplifier Factor(dB)
3. The other emission levels were very low against the limit.
4. Margin value = Emission Level – Limit value
5. " * ": Fundamental frequency.
6. " # ": The radiated frequency is out of the restricted band.

802.11ac (VHT20)

CHANNEL	TX Channel 36	DETECTOR FUNCTION	Peak (PK)
FREQUENCY RANGE	1GHz ~ 40GHz		Average (AV)

ANTENNA POLARITY & TEST DISTANCE: HORIZONTAL AT 3 M

NO.	FREQ. (MHz)	EMISSION LEVEL (dBuV/m)	LIMIT (dBuV/m)	MARGIN (dB)	ANTENNA HEIGHT (m)	TABLE ANGLE (Degree)	RAW VALUE (dBuV)	CORRECTION FACTOR (dB/m)
1	5100.00	58.9 PK	74.0	-15.1	1.00 H	314	51.10	7.80
2	5100.00	47.5 AV	54.0	-6.5	1.00 H	314	39.70	7.80
3	5150.00	56.5 PK	74.0	-17.5	1.00 H	15	48.60	7.90
4	5150.00	45.5 AV	54.0	-8.5	1.00 H	15	37.60	7.90
5	*5180.00	111.2 PK			1.00 H	15	103.30	7.90
6	*5180.00	100.2 AV			1.00 H	15	92.30	7.90
7	#5614.00	59.2 PK	68.3	-9.1	1.00 H	333	49.90	9.30
8	#10360.00	58.6 PK	68.3	-9.7	1.00 H	141	44.20	14.40
9	15540.00	59.5 PK	74.0	-14.5	1.00 H	31	39.30	20.20
10	15540.00	46.3 AV	54.0	-7.7	1.00 H	31	26.10	20.20

ANTENNA POLARITY & TEST DISTANCE: VERTICAL AT 3 M

NO.	FREQ. (MHz)	EMISSION LEVEL (dBuV/m)	LIMIT (dBuV/m)	MARGIN (dB)	ANTENNA HEIGHT (m)	TABLE ANGLE (Degree)	RAW VALUE (dBuV)	CORRECTION FACTOR (dB/m)
1	5100.00	63.6 PK	74.0	-10.4	1.15 V	265	55.80	7.80
2	5100.00	53.6 AV	54.0	-0.4	1.15 V	265	45.80	7.80
3	5150.00	62.7 PK	74.0	-11.3	1.25 V	243	54.80	7.90
4	5150.00	48.0 AV	54.0	-6.0	1.25 V	243	40.10	7.90
5	*5180.00	117.3 PK			1.25 V	264	109.40	7.90
6	*5180.00	108.5 AV			1.25 V	264	100.60	7.90
7	#5614.00	61.3 PK	68.3	-7.0	1.24 V	263	52.00	9.30
8	#10360.00	54.9 PK	68.3	-13.4	1.32 V	86	40.50	14.40
9	15540.00	58.2 PK	74.0	-15.8	1.00 V	124	38.00	20.20
10	15540.00	46.1 AV	54.0	-7.9	1.00 V	124	25.90	20.20

REMARKS:

- Emission Level(dBuV/m) = Raw Value(dBuV) + Correction Factor(dB/m)
- Correction Factor(dB/m) = Antenna Factor(dB/m) + Cable Factor(dB) – Pre-Amplifier Factor(dB)
- The other emission levels were very low against the limit.
- Margin value = Emission Level – Limit value
- " * ": Fundamental frequency.
- " # ": The radiated frequency is out of the restricted band.



A D T

CHANNEL	TX Channel 40	DETECTOR FUNCTION	Peak (PK)
FREQUENCY RANGE	1GHz ~ 40GHz		Average (AV)

ANTENNA POLARITY & TEST DISTANCE: HORIZONTAL AT 3 M

NO.	FREQ. (MHz)	EMISSION LEVEL (dBuV/m)	LIMIT (dBuV/m)	MARGIN (dB)	ANTENNA HEIGHT (m)	TABLE ANGLE (Degree)	RAW VALUE (dBuV)	CORRECTION FACTOR (dB/m)
1	5123.00	61.2 PK	74.0	-12.8	1.00 H	313	53.30	7.90
2	5123.00	50.2 AV	54.0	-3.8	1.00 H	313	42.30	7.90
3	*5200.00	110.8 PK			1.00 H	313	102.90	7.90
4	*5200.00	100.2 AV			1.00 H	313	92.30	7.90
5	#5633.00	60.1 PK	68.3	-8.2	1.00 H	334	50.80	9.30
6	#10400.00	58.9 PK	68.3	-9.4	1.00 H	132	44.20	14.70
7	15600.00	59.7 PK	74.0	-14.3	1.00 H	33	39.60	20.10
8	15600.00	46.2 AV	54.0	-7.8	1.00 H	33	26.10	20.10

ANTENNA POLARITY & TEST DISTANCE: VERTICAL AT 3 M

NO.	FREQ. (MHz)	EMISSION LEVEL (dBuV/m)	LIMIT (dBuV/m)	MARGIN (dB)	ANTENNA HEIGHT (m)	TABLE ANGLE (Degree)	RAW VALUE (dBuV)	CORRECTION FACTOR (dB/m)
1	5123.00	63.5 PK	74.0	-10.5	1.05 V	209	55.60	7.90
2	5123.00	53.5 AV	54.0	-0.5	1.05 V	209	45.60	7.90
3	*5200.00	114.2 PK			1.00 V	259	106.30	7.90
4	*5200.00	104.1 AV			1.00 V	259	96.20	7.90
5	#5633.00	60.6 PK	68.3	-7.7	1.04 V	176	51.30	9.30
6	#10400.00	54.8 PK	68.3	-13.5	1.35 V	76	40.10	14.70
7	15600.00	57.8 PK	74.0	-16.2	1.01 V	139	37.70	20.10
8	15600.00	45.8 AV	54.0	-8.2	1.01 V	139	25.70	20.10

REMARKS:

1. Emission Level(dBuV/m) = Raw Value(dBuV) + Correction Factor(dB/m)
2. Correction Factor(dB/m) = Antenna Factor(dB/m) + Cable Factor(dB) – Pre-Amplifier Factor(dB)
3. The other emission levels were very low against the limit.
4. Margin value = Emission Level – Limit value
5. " * ": Fundamental frequency.
6. " # ": The radiated frequency is out of the restricted band.



A D T

CHANNEL	TX Channel 48	DETECTOR FUNCTION	Peak (PK)
FREQUENCY RANGE	1GHz ~ 40GHz		Average (AV)

ANTENNA POLARITY & TEST DISTANCE: HORIZONTAL AT 3 M

NO.	FREQ. (MHz)	EMISSION LEVEL (dBuV/m)	LIMIT (dBuV/m)	MARGIN (dB)	ANTENNA HEIGHT (m)	TABLE ANGLE (Degree)	RAW VALUE (dBuV)	CORRECTION FACTOR (dB/m)
1	*5240.00	111.8 PK			1.01 H	340	103.70	8.10
2	*5240.00	101.2 AV			1.01 H	340	93.10	8.10
3	5400.00	61.0 PK	74.0	-13.0	1.00 H	333	52.30	8.70
4	5400.00	48.9 AV	54.0	-5.1	1.00 H	333	40.20	8.70
5	#10480.00	58.9 PK	68.3	-9.4	1.00 H	136	44.30	14.60
6	15720.00	60.2 PK	74.0	-13.8	1.00 H	25	40.20	20.00
7	15720.00	46.4 AV	54.0	-7.6	1.00 H	25	26.40	20.00

ANTENNA POLARITY & TEST DISTANCE: VERTICAL AT 3 M

NO.	FREQ. (MHz)	EMISSION LEVEL (dBuV/m)	LIMIT (dBuV/m)	MARGIN (dB)	ANTENNA HEIGHT (m)	TABLE ANGLE (Degree)	RAW VALUE (dBuV)	CORRECTION FACTOR (dB/m)
1	*5240.00	118.1 PK			1.02 V	202	110.00	8.10
2	*5240.00	108.1 AV			1.02 V	202	100.00	8.10
3	5400.00	63.9 PK	74.0	-10.1	1.12 V	197	55.20	8.70
4	5400.00	53.7 AV	54.0	-0.3	1.12 V	197	45.00	8.70
5	#10480.00	54.7 PK	68.3	-13.6	1.35 V	89	40.10	14.60
6	15720.00	58.3 PK	74.0	-15.7	1.02 V	131	38.30	20.00
7	15720.00	46.0 AV	54.0	-8.0	1.02 V	131	26.00	20.00

REMARKS:

1. Emission Level(dBuV/m) = Raw Value(dBuV) + Correction Factor(dB/m)
2. Correction Factor(dB/m) = Antenna Factor(dB/m) + Cable Factor(dB) – Pre-Amplifier Factor(dB)
3. The other emission levels were very low against the limit.
4. Margin value = Emission Level – Limit value
5. " * ": Fundamental frequency.
6. " # ": The radiated frequency is out of the restricted band.



A D T

802.11ac (VHT40)

CHANNEL	TX Channel 38	DETECTOR FUNCTION	Peak (PK)
FREQUENCY RANGE	1GHz ~ 40GHz		Average (AV)

ANTENNA POLARITY & TEST DISTANCE: HORIZONTAL AT 3 M

NO.	FREQ. (MHz)	EMISSION LEVEL (dBuV/m)	LIMIT (dBuV/m)	MARGIN (dB)	ANTENNA HEIGHT (m)	TABLE ANGLE (Degree)	RAW VALUE (dBuV)	CORRECTION FACTOR (dB/m)
1	5150.00	64.7 PK	74.0	-9.3	1.25 H	135	56.80	7.90
2	5150.00	51.9 AV	54.0	-2.1	1.25 H	135	44.00	7.90
3	*5190.00	107.7 PK			1.25 H	135	99.70	8.00
4	*5190.00	97.1 AV			1.25 H	135	89.10	8.00
5	#5622.00	62.5 PK	68.3	-5.8	1.20 H	346	53.20	9.30
6	#6920.00	61.8 PK	68.3	-6.5	1.30 H	2	47.50	14.30
7	#10380.00	59.8 PK	68.3	-8.5	1.00 H	360	45.20	14.60
8	15570.00	59.2 PK	74.0	-14.8	1.00 H	19	39.10	20.10
9	15570.00	45.8 AV	54.0	-8.2	1.00 H	19	25.70	20.10

ANTENNA POLARITY & TEST DISTANCE: VERTICAL AT 3 M

NO.	FREQ. (MHz)	EMISSION LEVEL (dBuV/m)	LIMIT (dBuV/m)	MARGIN (dB)	ANTENNA HEIGHT (m)	TABLE ANGLE (Degree)	RAW VALUE (dBuV)	CORRECTION FACTOR (dB/m)
1	5150.00	68.9 PK	74.0	-5.1	1.00 V	208	61.00	7.90
2	5150.00	53.6 AV	54.0	-0.4	1.00 V	208	45.70	7.90
3	*5190.00	111.4 PK			1.00 V	208	103.40	8.00
4	*5190.00	101.7 AV			1.00 V	208	93.70	8.00
5	#5622.00	61.7 PK	68.3	-6.6	1.32 V	227	52.40	9.30
6	#6920.00	62.4 PK	68.3	-5.9	1.00 V	141	48.10	14.30
7	#10380.00	59.7 PK	68.3	-8.6	1.00 V	349	45.10	14.60
8	15570.00	57.6 PK	74.0	-16.4	1.06 V	125	37.50	20.10
9	15570.00	45.8 AV	54.0	-8.2	1.06 V	125	25.70	20.10

REMARKS:

1. Emission Level(dBuV/m) = Raw Value(dBuV) + Correction Factor(dB/m)
2. Correction Factor(dB/m) = Antenna Factor(dB/m) + Cable Factor(dB) – Pre-Amplifier Factor(dB)
3. The other emission levels were very low against the limit.
4. Margin value = Emission Level – Limit value
5. " * ": Fundamental frequency.
6. " # ": The radiated frequency is out of the restricted band.



A D T

CHANNEL	TX Channel 46	DETECTOR FUNCTION	Peak (PK)
FREQUENCY RANGE	1GHz ~ 40GHz		Average (AV)

ANTENNA POLARITY & TEST DISTANCE: HORIZONTAL AT 3 M

NO.	FREQ. (MHz)	EMISSION LEVEL (dBuV/m)	LIMIT (dBuV/m)	MARGIN (dB)	ANTENNA HEIGHT (m)	TABLE ANGLE (Degree)	RAW VALUE (dBuV)	CORRECTION FACTOR (dB/m)
1	5142.00	61.7 PK	74.0	-12.3	1.27 H	0	53.90	7.80
2	5142.00	49.7 AV	54.0	-4.3	1.27 H	0	41.90	7.80
3	*5230.00	107.7 PK			1.30 H	138	99.60	8.10
4	*5230.00	97.2 AV			1.30 H	138	89.10	8.10
5	5395.00	64.8 PK	74.0	-9.2	1.25 H	136	56.20	8.60
6	5395.00	51.9 AV	54.0	-2.1	1.25 H	136	43.30	8.60
7	#5665.80	63.0 PK	68.3	-5.3	1.16 H	351	53.60	9.40
8	#10460.00	59.7 PK	68.3	-8.6	1.00 H	360	45.00	14.70
9	15690.00	58.8 PK	74.0	-15.2	1.00 H	28	38.80	20.00
10	15690.00	45.4 AV	54.0	-8.6	1.00 H	28	25.40	20.00

ANTENNA POLARITY & TEST DISTANCE: VERTICAL AT 3 M

NO.	FREQ. (MHz)	EMISSION LEVEL (dBuV/m)	LIMIT (dBuV/m)	MARGIN (dB)	ANTENNA HEIGHT (m)	TABLE ANGLE (Degree)	RAW VALUE (dBuV)	CORRECTION FACTOR (dB/m)
1	5142.00	64.1 PK	74.0	-9.9	1.00 V	213	56.30	7.80
2	5142.00	53.6 AV	54.0	-0.4	1.00 V	213	45.80	7.80
3	*5230.00	115.2 PK			1.00 V	208	107.10	8.10
4	*5230.00	105.3 AV			1.00 V	208	97.20	8.10
5	5395.00	61.7 PK	74.0	-12.3	1.12 V	243	53.10	8.60
6	5395.00	52.4 AV	54.0	-1.6	1.12 V	243	43.80	8.60
7	#5665.80	61.3 PK	68.3	-7.0	1.32 V	227	51.90	9.40
8	#10460.00	60.4 PK	68.3	-7.9	1.04 V	360	45.70	14.70
9	15690.00	58.4 PK	74.0	-15.6	1.05 V	127	38.40	20.00
10	15690.00	46.3 AV	54.0	-7.7	1.05 V	127	26.30	20.00

REMARKS:

1. Emission Level(dBuV/m) = Raw Value(dBuV) + Correction Factor(dB/m)
2. Correction Factor(dB/m) = Antenna Factor(dB/m) + Cable Factor(dB) – Pre-Amplifier Factor(dB)
3. The other emission levels were very low against the limit.
4. Margin value = Emission Level – Limit value
5. " * ": Fundamental frequency.
6. " # ": The radiated frequency is out of the restricted band.



802.11ac (VHT80)

CHANNEL	TX Channel 42	DETECTOR FUNCTION	Peak (PK)
FREQUENCY RANGE	1GHz ~ 40GHz		Average (AV)

ANTENNA POLARITY & TEST DISTANCE: HORIZONTAL AT 3 M

NO.	FREQ. (MHz)	EMISSION LEVEL (dBuV/m)	LIMIT (dBuV/m)	MARGIN (dB)	ANTENNA HEIGHT (m)	TABLE ANGLE (Degree)	RAW VALUE (dBuV)	CORRECTION FACTOR (dB/m)
1	5150.00	68.5 PK	74.0	-5.5	1.24 H	136	60.60	7.90
2	5150.00	50.3 AV	54.0	-3.7	1.24 H	136	42.40	7.90
3	*5210.00	107.6 PK			1.30 H	153	99.60	8.00
4	*5210.00	97.2 AV			1.30 H	153	89.20	8.00
5	5350.00	56.9 PK	74.0	-17.1	1.00 H	0	48.50	8.40
6	5350.00	43.9 AV	54.0	-10.1	1.00 H	0	35.50	8.40
7	#5789.00	59.2 PK	68.3	-9.1	1.01 H	175	49.60	9.60
8	#10420.00	60.2 PK	68.3	-8.1	1.00 H	360	45.50	14.70
9	15630.00	58.5 PK	74.0	-15.5	1.00 H	19	38.40	20.10
10	15630.00	45.2 AV	54.0	-8.8	1.00 H	19	25.10	20.10

ANTENNA POLARITY & TEST DISTANCE: VERTICAL AT 3 M

NO.	FREQ. (MHz)	EMISSION LEVEL (dBuV/m)	LIMIT (dBuV/m)	MARGIN (dB)	ANTENNA HEIGHT (m)	TABLE ANGLE (Degree)	RAW VALUE (dBuV)	CORRECTION FACTOR (dB/m)
1	5150.00	66.4 PK	74.0	-7.6	1.00 V	199	58.50	7.90
2	5150.00	53.5 AV	54.0	-0.5	1.00 V	199	45.60	7.90
3	*5210.00	106.2 PK			1.00 V	199	98.20	8.00
4	*5210.00	96.4 AV			1.00 V	199	88.40	8.00
5	5350.00	56.3 PK	74.0	-17.7	1.00 V	199	47.90	8.40
6	5350.00	44.8 AV	54.0	-9.2	1.00 V	199	36.40	8.40
7	#5789.00	61.2 PK	68.3	-7.1	1.52 V	229	51.60	9.60
8	#10420.00	60.4 PK	68.3	-7.9	1.02 V	360	45.70	14.70
9	15630.00	58.1 PK	74.0	-15.9	1.04 V	139	38.00	20.10
10	15630.00	45.8 AV	54.0	-8.2	1.04 V	139	25.70	20.10

REMARKS:

1. Emission Level(dBuV/m) = Raw Value(dBuV) + Correction Factor(dB/m)
2. Correction Factor(dB/m) = Antenna Factor(dB/m) + Cable Factor(dB) – Pre-Amplifier Factor(dB)
3. The other emission levels were very low against the limit.
4. Margin value = Emission Level – Limit value
5. " * ": Fundamental frequency.
6. " # ": The radiated frequency is out of the restricted band.



A D T

4.3 TRANSMIT POWER MEASUREMENT

4.3.1 LIMITS OF TRANSMIT POWER MEASUREMENT

FREQUENCY BAND	LIMIT
5.150 ~ 5.250GHz	The lesser of 50mW (17dBm) or 4dBm + 10logB
5.250 ~ 5.350GHz	The lesser of 250mW (24dBm) or 11dBm + 10logB
5.470 ~ 5.725GHz	The lesser of 250mW (24dBm) or 11dBm + 10logB

NOTE: Where B is the 26dB emission bandwidth in MHz.

Per KDB 662911 D01 Multiple Transmitter Output v01r02 Method of conducted output power measurement on IEEE 802.11 devices,

Array Gain = 0 dB (i.e., no array gain) for NANT ≤ 4;

Array Gain = 0 dB (i.e., no array gain) for channel widths ≥ 40 MHz for any NANT;

Array Gain = 5 log(NANT/NSS) dB or 3 dB, whichever is less for 20-MHz channel widths with NANT ≥ 5.

For power measurements on all other devices: Array Gain = 10 log(NANT/NSS) dB.

4.3.2 TEST INSTRUMENTS

FOR POWER OUTPUT MEASUREMENT

DESCRIPTION & MANUFACTURER	MODEL NO.	SERIAL NO.	CALIBRATED DATE	CALIBRATED UNTIL
Power meter Anritsu	ML2495A	0824006	May 20, 2013	May 19, 2014
Power sensor Anritsu	MA2411B	0738172	May 20, 2013	May 19, 2014

Note:

1. The calibration interval of the above test instruments is 12 months and the calibrations are traceable to NML/ROC and NIST/USA.
2. Tested date : Jan. 02, 2014

FOR 26dB OCCUPIED BANDWIDTH

DESCRIPTION & MANUFACTURER	MODEL NO.	SERIAL NO.	CALIBRATED DATE	CALIBRATED UNTIL
Spectrum Analyzer R&S	FSP 40	100036	Jan. 21, 2013	Jan. 20, 2014

Note:

1. The calibration interval of the above test instruments is 12 months and the calibrations are traceable to NML/ROC and NIST/USA.
2. Tested date : Jan. 02, 2014

4.3.3 TEST PROCEDURE

FOR POWER OUTPUT MEASUREMENT

Method PM is used to perform output power measurement, trigger and gating function of wide band power meter is enabled to measure max output power of TX on burst. Duty factor is not added to measured value.

FOR 26dB OCCUPIED BANDWIDTH

1. Set RBW = approximately 1% of the emission bandwidth.
2. Set the VBW > RBW.
3. Detector = Peak.
4. Trace mode = max hold.
5. Measure the maximum width of the emission that is 26 dB down from the peak of the emission. Compare this with the RBW setting of the analyzer. Readjust RBW and repeat measurement as needed until the RBW/EBW ratio is approximately 1%.

4.3.4 DEVIATION FROM TEST STANDARD

No deviation

4.3.5 TEST SETUP

FOR POWER OUTPUT MEASUREMENT

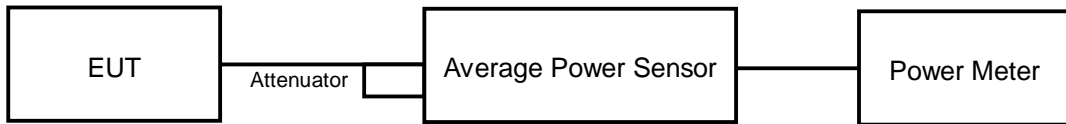

FOR 26dB OCCUPIED BANDWIDTH

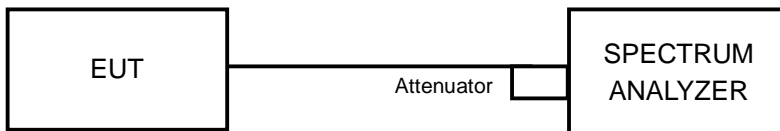

4.3.6 EUT OPERATING CONDITIONS

The software provided by client to enable the EUT under transmission condition continuously at specific channel frequencies individually.



A D T

4.3.7 TEST RESULTS

802.11a

POWER OUTPUT:

CHANNEL	CHANNEL FREQUENCY (MHz)	AVERAGE POWER (mW)	AVERAGE POWER (dBm)	POWER LIMIT (dBm)	PASS/FAIL
36	5180	45.499	16.58	17	PASS
40	5200	46.132	16.64	17	PASS
48	5240	46.026	16.63	17	PASS

26dB OCCUPIED BANDWIDTH:

CHANNEL	CHANNEL FREQUENCY (MHz)	26dBc BANDWIDTH (MHz)
36	5180	20.50
40	5200	20.56
48	5240	20.49

Note: For FCC output power limitation is determined based on 26dBc bandwidth.

Power Limit = $4\text{dBm} + 10\log B$ < UNII Band 1 >			
Channel Number	Freq.(MHz)	Min. B(MHz)	Determined Conducted Limit (dBm)
36	5180	20.50	17.11 > 17
40	5200	20.56	17.13 > 17
48	5240	20.49	17.11 > 17



A D T

802.11ac (VHT20)

POWER OUTPUT:

CHANNEL	FREQUENCY (MHz)	AVERAGE POWER (dBm)			TOTAL POWER (mW)	TOTAL POWER (dBm)	POWER LIMIT (dBm)	PASS / FAIL
		CHAIN 0	CHAIN 1	CHAIN 2				
36	5180	7.14	8.01	7.98	17.781	12.50	12.61	PASS
40	5200	7.11	8.03	8.01	17.817	12.51	12.61	PASS
48	5240	7.39	8.24	7.72	18.067	12.57	12.61	PASS

NOTE: 1. Directional gain = $10 \log[(10^{G1/20} + 10^{G2/20} + 10^{G3/20})^2 / 3]$ = 10.39dBi > 6dBi , so the power limit shall be reduced to $17-(10.39-6) = 12.61\text{dBm}$.

26dB OCCUPIED BANDWIDTH:

CHANNEL	CHANNEL FREQUENCY (MHz)	26dBc BANDWIDTH (MHz)		
		CHAIN 0	CHAIN 1	CHAIN 2
36	5180	20.77	20.62	20.76
40	5200	20.82	20.53	20.49
48	5240	20.84	20.58	20.46

Note: For FCC output power limitation is determined based on 26dBc bandwidth.

Power Limit = 4dBm + 10logB < UNII Band 1 >			
Channel Number	Freq.(MHz)	Min. B(MHz)	Determined Conducted Limit (dBm)
36	5180	20.62	17.14 > 17
40	5200	20.49	17.11 > 17
48	5240	20.46	17.1 > 17



A D T

802.11ac (VHT40)

POWER OUTPUT:

CHANNEL	FREQUENCY (MHz)	AVERAGE POWER (dBm)			TOTAL POWER (mW)	TOTAL POWER (dBm)	POWER LIMIT (dBm)	PASS / FAIL
		CHAIN 0	CHAIN 1	CHAIN 2				
38	5190	7.11	7.98	7.92	17.615	12.46	12.61	PASS
46	5230	7.08	7.92	7.89	17.451	12.42	12.61	PASS

NOTE: 1. Directional gain = $10 \log[(10^{G1/20} + 10^{G2/20} + 10^{G3/20})^2 / 3] = 10.39\text{dBi} > 6\text{dBi}$, so the power limit shall be reduced to $17-(10.39-6) = 12.61\text{dBm}$.

26dB OCCUPIED BANDWIDTH:

CHANNEL	CHANNEL FREQUENCY (MHz)	26dBc BANDWIDTH (MHz)		
		CHAIN 0	CHAIN 1	CHAIN 2
38	5190	41.43	41.10	41.11
46	5230	41.74	41.07	40.81

Note: For FCC output power limitation is determined based on 26dBc bandwidth.

Power Limit = 4dBm + 10logB < UNII Band 1 >			
Channel Number	Freq.(MHz)	Min. B(MHz)	Determined Conducted Limit (dBm)
38	5190	41.10	20.13 > 17
46	5230	40.81	20.1 > 17



A D T

802.11ac (VHT80)

POWER OUTPUT:

CHANNEL	FREQUENCY (MHz)	AVERAGE POWER (dBm)			TOTAL POWER (mW)	TOTAL POWER (dBm)	POWER LIMIT (dBm)	PASS / FAIL
		CHAIN 0	CHAIN 1	CHAIN 2				
42	5210	7.11	7.93	7.98	17.630	12.46	12.61	PASS

NOTE: 1. Directional gain = $10 \log[(10^{G1/20} + 10^{G2/20} + 10^{G3/20})^2 / 3] = 10.39\text{dBi} > 6\text{dBi}$, so the power limit shall be reduced to $17 - (10.39 - 6) = 12.61\text{dBm}$.

26dB OCCUPIED BANDWIDTH:

CHANNEL	CHANNEL FREQUENCY (MHz)	26dBc BANDWIDTH (MHz)		
		CHAIN 0	CHAIN 1	CHAIN 2
42	5210	83.19	82.06	82.26

Note: For FCC output power limitation is determined based on 26dBc bandwidth.

Power Limit = $4\text{dBm} + 10\log B$ < UNII Band 1 >			
Channel Number	Freq.(MHz)	Min. B(MHz)	Determined Conducted Limit (dBm)
42	5210	82.06	23.14 > 17

4.4 PEAK POWER SPECTRAL DENSITY MEASUREMENT

4.4.1 LIMITS OF PEAK POWER SPECTRAL DENSITY MEASUREMENT

FREQUENCY BAND	LIMIT
5.15 ~ 5.25GHz	4dBm
5.25 ~ 5.35GHz	11dBm
5.47 – 5.725GHz	11dBm
5.725 ~ 5.825GHz	17dBm

4.4.2 TEST INSTRUMENTS

DESCRIPTION & MANUFACTURER	MODEL NO.	SERIAL NO.	CALIBRATED DATE	CALIBRATED UNTIL
Spectrum Analyzer R&S	FSP40	100036	Jan. 21, 2013	Jan. 20, 2014

Note:

1. The calibration interval of the above test instruments is 12 months and the calibrations are traceable to NML/ROC and NIST/USA.
2. Tested date : Jan. 02, 2014

4.4.3 TEST PROCEDURES

1. Set span to encompass the entire emission bandwidth (EBW) of the signal.
2. Set RBW = 1 MHz, Set VBW ≥ 3 MHz, Detector = RMS
3. Sweep time = auto, trigger set to “free run”.
4. Trace average at least 100 traces in power averaging mode.
5. Record the max value and for duty cycle of test signal is < 98% add 10 log (1/duty cycle)

4.4.4 DEVIATION FROM TEST STANDARD

No deviation

4.4.5 TEST SETUP

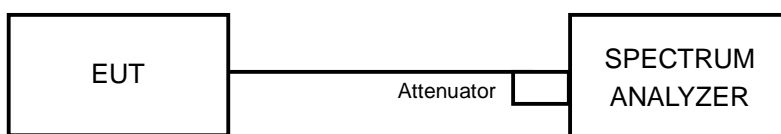



A D T

4.4.6 EUT OPERATING CONDITIONS

Same as 4.3.6



4.4.7 TEST RESULTS

802.11a

CHANNEL	FREQUENCY (MHz)	PSD (dBm)	MAXIMUM LIMIT (dBm)	PASS/FAIL
36	5180	2.80	4	PASS
40	5200	3.07	4	PASS
48	5240	3.50	4	PASS

802.11ac (VHT20)

CHANNEL	CHANNEL FREQUENCY (MHz)	PSD (dBm)			TOTAL POWER DENSITY (dBm)	MAX. LIMIT (dBm)	PASS/FAIL
		CHAIN 0	CHAIN 1	CHAIN 2			
36	5180	-6.75	-5.88	-5.58	-1.27	-0.39	PASS
40	5200	-6.54	-5.56	-5.51	-1.07	-0.39	PASS
48	5240	-6.38	-5.81	-5.71	-1.19	-0.39	PASS

- NOTE:**
- Method a) of power density measurement of KDB 662911 is using for calculating total power density. Total power density is summing entire spectra across corresponding frequency bins on the various outputs by computer.
 - Directional gain = $10 \log[(10^{G1/20} + 10^{G2/20} + 10^{G3/20})^2 / 3] = 10.39\text{dBi} > 6\text{dBi}$, so the power density limit shall be reduced to $4-(10.39-6) = -0.39\text{dBm}$.

802.11ac (VHT40)

CHANNEL	CHANNEL FREQUENCY (MHz)	PSD (dBm)			TOTAL POWER DENSITY (dBm)	MAX. LIMIT (dBm)	PASS/FAIL
		CHAIN 0	CHAIN 1	CHAIN 2			
38	5190	-9.26	-8.40	-8.08	-3.78	-0.39	PASS
46	5230	-9.12	-8.29	-8.17	-3.73	-0.39	PASS

- NOTE:**
- Method a) of power density measurement of KDB 662911 is using for calculating total power density. Total power density is summing entire spectra across corresponding frequency bins on the various outputs by computer.
 - Directional gain = $10 \log[(10^{G1/20} + 10^{G2/20} + 10^{G3/20})^2 / 3] = 10.39\text{dBi} > 6\text{dBi}$, so the power density limit shall be reduced to $4-(10.39-6) = -0.39\text{dBm}$.



A D T

802.11ac (VHT80)

CHANNEL	CHANNEL FREQUENCY (MHz)	PSD W/O DUTY FACTOR (dBm)			DUTY FACTOR (dB)	TOTAL PSD WITH DUTY FACTOR (dBm)	MAX. LIMIT (dBm)	PASS/FAIL
		CHAIN 0	CHAIN 1	CHAIN 2				
42	5210	-12.88	-11.71	-11.57	0.16	-7.08	-0.39	PASS

- NOTE:** 1. Method a) of power density measurement of KDB 662911 is using for calculating total power density. Total power density is summing entire spectra across corresponding frequency bins on the various outputs by computer.
2. Directional gain = $10 \log[(10^{G1/20} + 10^{G2/20} + 10^{G3/20})^2 / 3] = 10.39\text{dBi} > 6\text{dBi}$, so the power density limit shall be reduced to $4-(10.39-6) = -0.39\text{dBm}$.
3. Refer to section 3.4 for duty cycle spectrum plot.



A D T

SPECTRUM PLOT OF WORST VALUE

802.11a / CH48

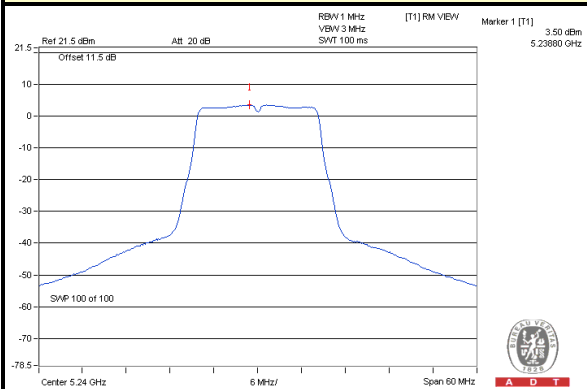

802.11ac (VHT20)_Chain 2 / CH40

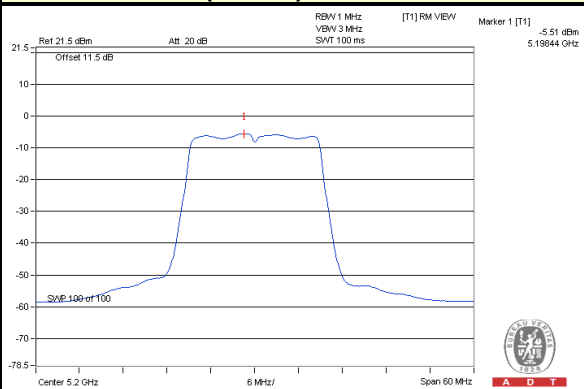

802.11ac (VHT40)_Chain 2 / CH38

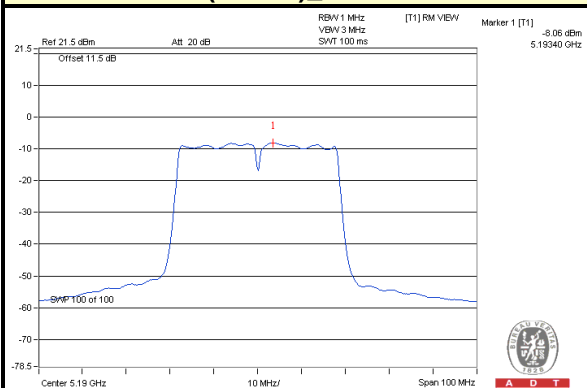

802.11ac (VHT80)_Chain 2 / CH42

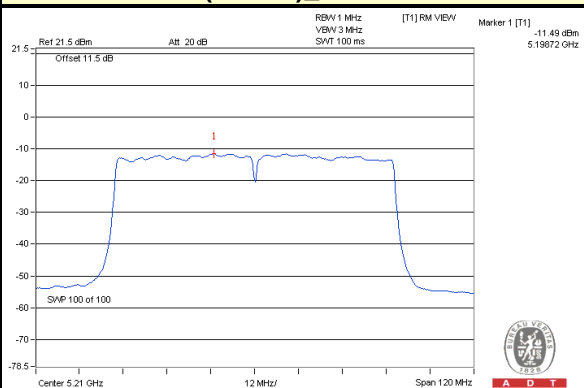

4.5 PEAK POWER EXCURSION MEASUREMENT

4.5.1 LIMITS OF PEAK POWER EXCURSION MEASUREMENT

Shall not exceed 13 dB

4.5.2 TEST INSTRUMENTS

DESCRIPTION & MANUFACTURER	MODEL NO.	SERIAL NO.	CALIBRATED DATE	CALIBRATED UNTIL
Spectrum Analyzer R&S	FSP 40	100036	Jan. 21, 2013	Jan. 20, 2014

Note:

1. The calibration interval of the above test instruments is 12 months and the calibrations are traceable to NML/ROC and NIST/USA.
2. Tested date : Jan. 02, 2014

4.5.3 TEST PROCEDURE

1. Set RBW = 1 MHz, VBW \geq 3 MHz, Detector = peak.
2. Trace mode = max-hold. Allow the sweeps to continue until the trace stabilizes.
3. Use the peak search function to find the peak of the spectrum.
4. Measure the PPSD.
5. Compute the ratio of the maximum of the peak-max-hold spectrum to the PPSD.

4.5.4 DEVIATION FROM TEST STANDARD

No deviation

4.5.5 TEST SETUP

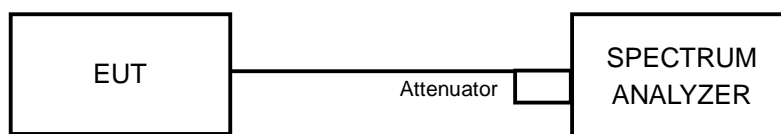

4.5.6 EUT OPERATING CONDITIONS

The software provided by client to enable the EUT under transmission condition continuously at specific channel frequencies individually.



A D T

4.5.7 TEST RESULTS

MODULATION MODE	MODULATION TYPE	CHANNEL FREQUENCY (MHz)	PEAK VALUE (dBm)	PPSD (dBm)	PEAK EXCURSION (dB)	LIMIT (dB)	PASS/ FAIL
802.11a	BPSK	5240	11.57	3.5	8.07	13	PASS
	QPSK		3.03	-5.48	8.51	13	PASS
802.11ac (VHT20)	BPSK	5240	2	-6.38	8.38	13	PASS
	QPSK		3.86	-5.69	9.55	13	PASS
802.11ac (VHT40)	BPSK	5230	-0.1	-9.08	8.98	13	PASS

MODULATION MODE	MODULATION TYPE	CHAN. FREQ. (MHz)	PEAK VALUE (dBm)	PPSD WITHOUT DUTY FACTOR (dBm)	PPSD WITH DUTY FACTOR (dBm)	PEAK EXCURSION (dB)	LIMIT (dB)	PASS /FAIL
802.11a	16QAM	5240	3.9	-5.54	-5.4	9.3	13	PASS
	64QAM		3.28	-5.47	-5.2	8.48	13	PASS
802.11ac (VHT20)	16QAM	5240	4.32	-5.79	-5.63	9.95	13	PASS
	64QAM		4.14	-5.74	-5.48	9.62	13	PASS
	256QAM		4.3	-5.79	-5.42	9.72	13	PASS
802.11ac (VHT40)	QPSK	5230	1.69	-8.35	-8.2	9.89	13	PASS
	16QAM		2.14	-8.21	-7.93	10.07	13	PASS
	64QAM		2.15	-8.4	-7.93	10.08	13	PASS
	256QAM		2.07	-8.46	-7.83	9.9	13	PASS
802.11ac (VHT80)	BPSK	5210	-3.39	-12.85	-12.69	9.3	13	PASS
	QPSK		-1.09	-11.42	-11.12	10.03	13	PASS
	16QAM		-1.4	-11.59	-11.06	9.66	13	PASS
	64QAM		-1.61	-11.61	-10.86	9.25	13	PASS
	256QAM		-1.06	-11.73	-10.81	9.75	13	PASS

NOTE: 1. Refer to section 3.4 for duty cycle spectrum plot.



A D T

SPECTRUM PLOT OF WORST VALUE

802.11a / 16QAM

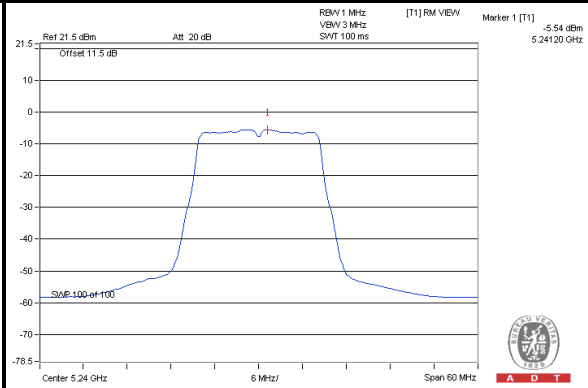
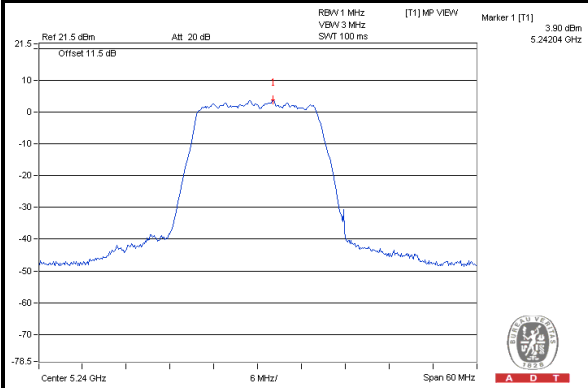

802.11ac (VHT20) / 16QAM

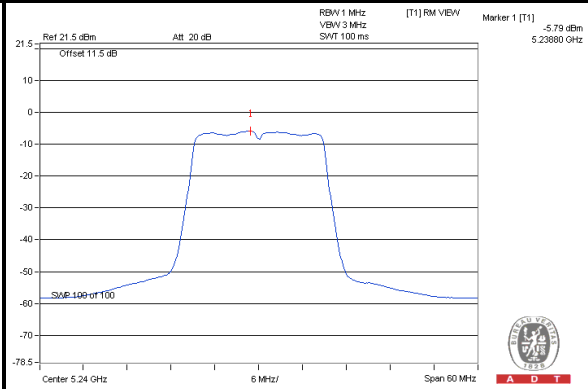
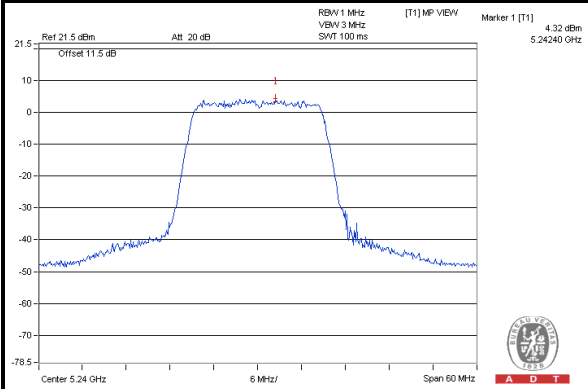

802.11ac (VHT40) / 64QAM

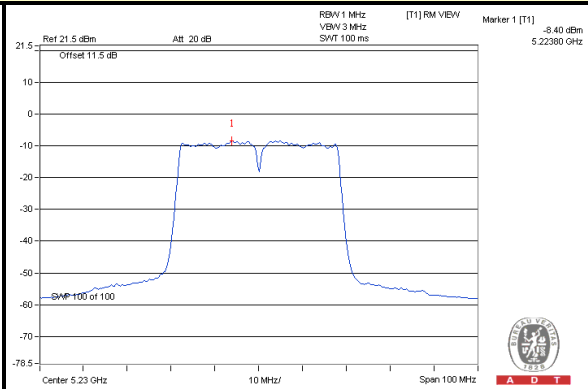
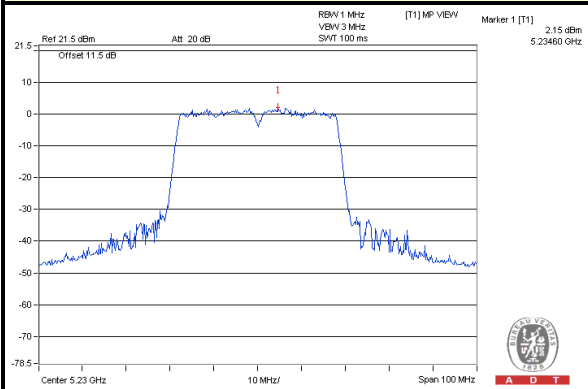

802.11ac (VHT80) / QPSK

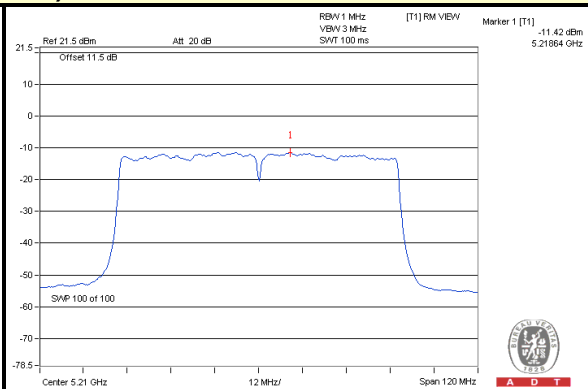
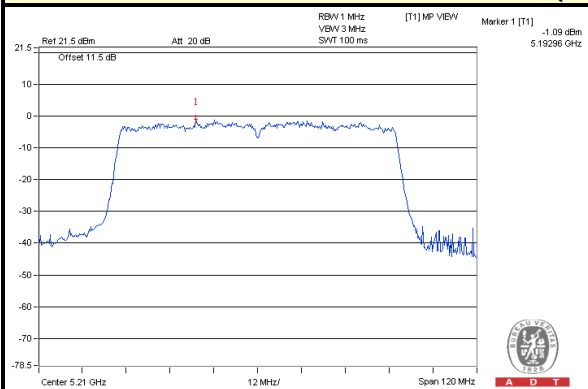



A D T

4.6 FREQUENCY STABILITY

4.6.1 LIMITS OF FREQUENCY STABILITY MEASUREMENT

The frequency of the carrier signal shall be maintained within band of operation

4.6.2 TEST INSTRUMENTS

DESCRIPTION & MANUFACTURER	MODEL NO.	SERIAL NO.	CALIBRATED DATE	CALIBRATED UNTIL
Spectrum Analyzer R&S	FSP 40	100036	Jan. 21, 2013	Jan. 20, 2014
Temperature & Humidity Chamber GIANTFORCE	GTH-150-40 -SP-AR	MAA0812-008	Jan. 17, 2013	Jan. 16, 2014

Note:

1. The calibration interval of the above test instruments is 12 months and the calibrations are traceable to NML/ROC and NIST/USA.
2. Tested date : Jan. 02, 2014

4.6.3 TEST PROCEDURE

1. The EUT was placed inside the environmental test chamber and powered by nominal AC voltage.
2. Turn the EUT on and couple its output to a spectrum analyzer.
3. Turn the EUT off and set the chamber to the highest temperature specified.
4. Allow sufficient time (approximately 30 min) for the temperature of the chamber to stabilize, turn the EUT on and measure the operating frequency after 2, 5, and 10 minutes.
5. Repeat step 2 and 3 with the temperature chamber set to the lowest temperature.
6. The test chamber was allowed to stabilize at +20 degree C for a minimum of 30 minutes. The supply voltage was then adjusted on the EUT from 85% to 115% and the frequency record.

4.6.4 DEVIATION FROM TEST STANDARD

No deviation

4.6.5 TEST SETUP

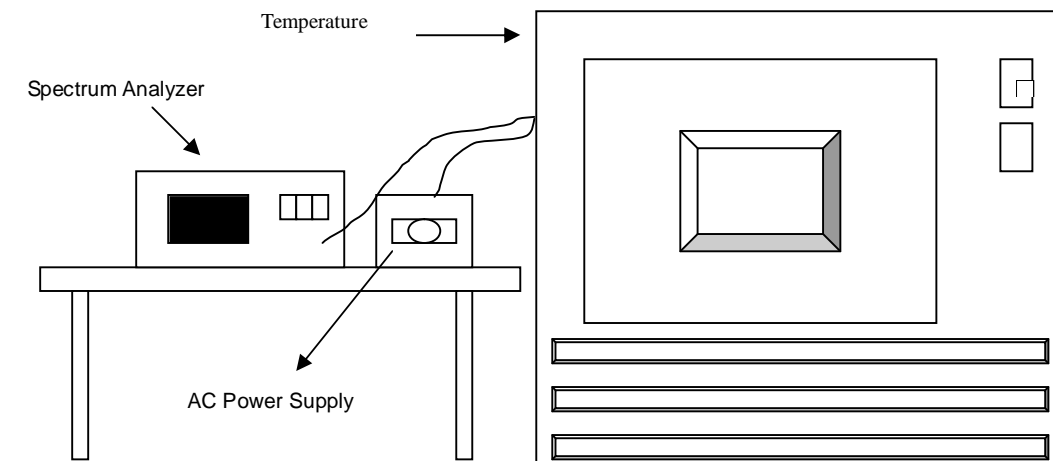

4.6.6 EUT OPERATING CONDITION

Set the EUT transmit at un-modulation mode to test frequency stability.



A D T

4.6.7 TEST RESULTS

FREQUENCY STABILITY VERSUS TEMP.									
OPERATING FREQUENCY: 5240MHz									
TEMP. (°C)	POWER SUPPLY (Vac)	0 MINUTE		2 MINUTE		5 MINUTE		10 MINUTE	
		Measured Frequency	Frequency Drift	Measured Frequency	Frequency Drift	Measured Frequency	Frequency Drift	Measured Frequency	Frequency Drift
		(MHz)	%	(MHz)	%	(MHz)	%	(MHz)	%
50	120	5239.9936	-0.00012	5239.9926	-0.00014	5239.9954	-0.00009	5240.0002	0.00000
40	120	5239.9988	-0.00002	5239.992	-0.00015	5239.9943	-0.00011	5239.9969	-0.00006
30	120	5240.0073	0.00014	5240.0161	0.00031	5240.0111	0.00021	5240.0172	0.00033
20	120	5240.0265	0.00051	5240.0182	0.00035	5240.0194	0.00037	5240.0167	0.00032
10	120	5240.005	0.00010	5240.0056	0.00011	5240.0051	0.00010	5240.0061	0.00012
0	120	5239.99	-0.00019	5239.9832	-0.00032	5239.9851	-0.00028	5239.9841	-0.00030
-10	120	5239.9918	-0.00016	5239.9902	-0.00019	5239.9921	-0.00015	5239.9882	-0.00023
-20	120	5239.9866	-0.00026	5239.987	-0.00025	5239.9817	-0.00035	5239.9877	-0.00023
-30	120	5240.0169	0.00032	5240.015	0.00029	5240.0133	0.00025	5240.0106	0.00020

FREQUENCY STABILITY VERSUS VOLTAGE									
OPERATING FREQUENCY: 5240MHz									
TEMP. (°C)	POWER SUPPLY (Vac)	0 MINUTE		2 MINUTE		5 MINUTE		10 MINUTE	
		Measured Frequency	Frequency Drift	Measured Frequency	Frequency Drift	Measured Frequency	Frequency Drift	Measured Frequency	Frequency Drift
		(MHz)	%	(MHz)	%	(MHz)	%	(MHz)	%
20	138	5240.0275	0.00052	5240.0181	0.00035	5240.0193	0.00037	5240.0158	0.00030
	120	5240.0265	0.00051	5240.0182	0.00035	5240.0194	0.00037	5240.0167	0.00032
	102	5240.0262	0.00050	5240.0174	0.00033	5240.02	0.00038	5240.0175	0.00033



A D T

5. PHOTOGRAPHS OF THE TEST CONFIGURATION

Please refer to the attached file (Test Setup Photo).





6. INFORMATION ON THE TESTING LABORATORIES

We, Bureau Veritas Consumer Products Services (H.K.) Ltd., Taoyuan Branch, were founded in 1988 to provide our best service in EMC, Radio, Telecom and Safety consultation. Our laboratories are accredited and approved according to ISO/IEC 17025.

If you have any comments, please feel free to contact us at the following:

Linko EMC/RF Lab:

Tel: 886-2-26052180

Fax: 886-2-26052943

Hsin Chu EMC/RF Lab:

Tel: 886-3-5935343

Fax: 886-3-5935342

Hwa Ya EMC/RF/Safety/Telecom Lab:

Tel: 886-3-3183232

Fax: 886-3-3270892

Email: service.adt@tw.bureauveritas.com

Web Site: www.bureauveritas-adt.com

The address and road map of all our labs can be found in our web site also.



A D T

7. APPENDIX A - MODIFICATIONS RECORDERS FOR ENGINEERING CHANGES TO THE EUT BY THE LAB

No modifications were made to the EUT by the lab during the test.

--- END ---