



FCC TEST REPORT (15.247)

REPORT NO.: RF131223E02
MODEL NO.: TEW-818DRU
FCC ID: XU8TEW818DRU
RECEIVED: Dec. 23, 2013
TESTED: Dec. 25, 2013 to Jan. 07, 2014
ISSUED: Jan. 14, 2014

APPLICANT: TRENDnet, Inc.

ADDRESS: 20675 Manhattan Place, Torrance, CA
90501

ISSUED BY: Bureau Veritas Consumer Products Services
(H.K.) Ltd., Taoyuan Branch Hsin Chu Laboratory

LAB ADDRESS : No. 81-1, Lu Liao Keng, 9th Ling, Wu Lung Tsuen,
Chiung Lin Hsiang, Hsin Chu Hsien 307, Taiwan,
R.O.C.

TEST LOCATION (1): No. 81-1, Lu Liao Keng, 9th Ling, Wu Lung Tsuen,
Chiung Lin Hsiang, Hsin Chu Hsien 307, Taiwan,
R.O.C.

TEST LOCATION (2): No. 49, Ln. 206, Wende Rd., Shangshan Tsuen,
Chiung Lin Hsiang, Hsin Chu Hsien 307, Taiwan,
R.O.C.

This report should not be used by the client to claim product certification, approval, or endorsement by TAF or any government agencies.



This report is for your exclusive use. Any copying or replication of this report to or for any other person or entity, or use of our name or trademark, is permitted only with our prior written permission. This report sets forth our findings solely with respect to the test samples identified herein. The results set forth in this report are not indicative or representative of the quality or characteristics of the lot from which a test sample was taken or any similar or identical product unless specifically and expressly noted. Our report includes all of the tests requested by you and the results thereof based upon the information that you provided to us. You have 60 days from date of issuance of this report to notify us of any material error or omission caused by our negligence, provided, however, that such notice shall be in writing and shall specifically address the issue you wish to raise. A failure to raise such issue within the prescribed time shall constitute your unqualified acceptance of the completeness of this report, the tests conducted and the correctness of the report contents. Unless specific mention, the uncertainty of measurement has been explicitly taken into account to declare the compliance or non-compliance to the specification



A D T

Table of Contents

RELEASE CONTROL RECORD	5
1. CERTIFICATION	6
2. SUMMARY OF TEST RESULTS	7
2.1 MEASUREMENT UNCERTAINTY	8
3. GENERAL INFORMATION	9
3.1 GENERAL DESCRIPTION OF EUT	9
3.2 DESCRIPTION OF TEST MODES	12
3.2.1 TEST MODE APPLICABILITY AND TESTED CHANNEL DETAIL	13
3.3 GENERAL DESCRIPTION OF APPLIED STANDARDS	16
3.4 DUTY CYCLE OF TEST SIGNAL	17
3.5 DESCRIPTION OF SUPPORT UNITS.....	19
3.6 CONFIGURATION OF SYSTEM UNDER TEST	20
4. TEST TYPES AND RESULTS (FOR 2.4GHz, 2.400 ~ 2.4835GHz BAND)	22
4.1 CONDUCTED EMISSION MEASUREMENT	22
4.1.1 LIMITS OF CONDUCTED EMISSION MEASUREMENT	22
4.1.2 TEST INSTRUMENTS.....	22
4.1.3 TEST PROCEDURES	23
4.1.4 DEVIATION FROM TEST STANDARD	23
4.1.5 TEST SETUP	23
4.1.6 EUT OPERATING CONDITIONS	24
4.1.7 TEST RESULTS (MODE 1)	25
4.1.8 TEST RESULTS (MODE 2)	27
4.2 RADIATED EMISSION AND BANDEDGE MEASUREMENT	29
4.2.1 LIMITS OF RADIATED EMISSION AND BANDEDGE MEASUREMENT	29
4.2.2 TEST INSTRUMENTS.....	30
4.2.3 TEST PROCEDURES	31
4.2.4 DEVIATION FROM TEST STANDARD	31
4.2.5 TEST SETUP	32
4.2.6 EUT OPERATING CONDITIONS	32
4.2.7 TEST RESULTS	33
4.3 6DB BANDWIDTH MEASUREMENT	46
4.3.1 LIMITS OF 6DB BANDWIDTH MEASUREMENT	46
4.3.2 TEST INSTRUMENTS.....	46
4.3.3 TEST PROCEDURE.....	46
4.3.4 DEVIATION FROM TEST STANDARD	46
4.3.5 TEST SETUP	46
4.3.6 EUT OPERATING CONDITIONS	46
4.3.7 TEST RESULTS	47
4.4 CONDUCTED OUTPUT POWER MEASUREMENT	49
4.4.1 LIMITS OF MAXIMUM PEAK OUTPUT POWER MEASUREMENT	49
4.4.2 INSTRUMENTS.....	49
4.4.3 TEST PROCEDURES	49
4.4.4 DEVIATION FROM TEST STANDARD	49
4.4.5 TEST SETUP	50
4.4.6 EUT OPERATING CONDITIONS	50
4.4.7 TEST RESULTS	51
4.5 POWER SPECTRAL DENSITY MEASUREMENT	52
4.5.1 LIMITS OF POWER SPECTRAL DENSITY MEASUREMENT	52
4.5.2 TEST INSTRUMENTS.....	52
4.5.3 TEST PROCEDURE.....	52
4.5.4 DEVIATION FROM TEST STANDARD	52



4.5.5	TEST SETUP	52
4.5.6	EUT OPERATING CONDITION	52
4.5.7	TEST RESULTS	53
4.6	CONDUCTED OUT-BAND EMISSION MEASUREMENT	56
4.6.1	LIMITS OF CONDUCTED OUT-BAND EMISSION MEASUREMENT	56
4.6.2	TEST INSTRUMENTS	56
4.6.3	TEST PROCEDURE	56
4.6.4	DEVIATION FROM TEST STANDARD	57
4.6.5	TEST SETUP	57
4.6.6	EUT OPERATING CONDITION	57
4.6.7	TEST RESULTS	57
5.	TEST TYPES AND RESULTS (FOR 5GHz, 5.725~5.850GHz BAND)	66
5.1	CONDUCTED EMISSION MEASUREMENT	66
5.1.1	LIMITS OF CONDUCTED EMISSION MEASUREMENT	66
5.1.2	TEST INSTRUMENTS	66
5.1.3	TEST PROCEDURES	67
5.1.4	DEVIATION FROM TEST STANDARD	67
5.1.5	TEST SETUP	67
5.1.6	EUT OPERATING CONDITIONS	68
5.1.7	TEST RESULTS (MODE 1)	69
5.1.8	TEST RESULTS (MODE 2)	71
5.2	RADIATED AND BANDEDGE EMISSION MEASUREMENT	73
5.2.1	LIMITS OF RADIATED AND BANDEDGE EMISSION MEASUREMENT	73
5.2.2	TEST INSTRUMENTS	74
5.2.3	TEST PROCEDURES	75
5.2.4	DEVIATION FROM TEST STANDARD	75
5.2.5	TEST SETUP	76
5.2.6	EUT OPERATING CONDITIONS	76
5.2.7	TEST RESULTS	77
5.3	6DB BANDWIDTH MEASUREMENT	87
5.3.1	LIMITS OF 6DB BANDWIDTH MEASUREMENT	87
5.3.2	TEST INSTRUMENTS	87
5.3.3	TEST PROCEDURE	87
5.3.4	DEVIATION FROM TEST STANDARD	87
5.3.5	TEST SETUP	87
5.3.6	EUT OPERATING CONDITIONS	88
5.3.7	TEST RESULTS	89
5.4	CONDUCTED OUTPUT POWER MEASUREMENT	91
5.4.1	LIMITS OF CONDUCTED OUTPUT POWER MEASUREMENT	91
5.4.2	INSTRUMENTS	91
5.4.3	TEST PROCEDURES	91
5.4.4	DEVIATION FROM TEST STANDARD	92
5.4.5	TEST SETUP	93
5.4.6	EUT OPERATING CONDITIONS	93
5.4.7	TEST RESULTS	94
5.5	POWER SPECTRAL DENSITY MEASUREMENT	95
5.5.1	LIMITS OF POWER SPECTRAL DENSITY MEASUREMENT	95
5.5.2	TEST INSTRUMENTS	95
5.5.3	TEST PROCEDURE	95
5.5.4	DEVIATION FROM TEST STANDARD	95
5.5.5	TEST SETUP	95
5.5.6	EUT OPERATING CONDITION	95
5.5.7	TEST RESULTS	96



A D T

5.6	CONDUCTED OUT-BAND EMISSION MEASUREMENT	99
5.6.1	LIMITS OF CONDUCTED OUT-BAND EMISSION MEASUREMENT.....	99
5.6.2	TEST INSTRUMENTS.....	99
5.6.3	TEST PROCEDURE.....	99
5.6.4	DEVIATION FROM TEST STANDARD	100
5.6.5	TEST SETUP	100
5.6.6	EUT OPERATING CONDITION.....	100
5.6.7	TEST RESULTS	100
6.	PHOTOGRAPHS OF THE TEST CONFIGURATION.....	111
7.	INFORMATION ON THE TESTING LABORATORIES	112
8.	APPENDIX A - MODIFICATIONS RECORDERS FOR ENGINEERING CHANGES TO THE EUT BY THE LAB.....	113



A D T

RELEASE CONTROL RECORD

ISSUE NO.	REASON FOR CHANGE	DATE ISSUED
RF131223E02	Original release	Jan. 14, 2014



1. CERTIFICATION

PRODUCT: AC1900 Dual Band Wireless Router
BRAND NAME: TRENDnet
MODEL NO.: TEW-818DRU
TEST SAMPLE: ENGINEERING SAMPLE
APPLICANT: TRENDnet, Inc.
TESTED: Dec. 25, 2013 to Jan. 07, 2014
STANDARDS: FCC Part 15, Subpart C (Section 15.247)
ANSI C63.10-2009

The above equipment (Model: TEW-818DRU) has been tested by **Bureau Veritas Consumer Products Services (H.K.) Ltd., Taoyuan Branch**, and found compliance with the requirement of the above standards. The test record, data evaluation & Equipment Under Test (EUT) configurations represented herein are true and accurate accounts of the measurements of the sample's EMC characteristics under the conditions specified in this report.

PREPARED BY : Phoenix Huang , **DATE:** Jan. 14, 2014
(Phoenix Huang, Specialist)

APPROVED BY : May Chen , **DATE:** Jan. 14, 2014
(May Chen, Manager)



A D T

2. SUMMARY OF TEST RESULTS

The EUT has been tested according to the following specifications:

For 2.4GHz, 2400~2483.5MHz Band

APPLIED STANDARD: FCC PART 15, SUBPART C (SECTION 15.247)			
STANDARD SECTION	TEST TYPE	RESULT	REMARK
15.207	AC Power Conducted Emission	PASS	Meet the requirement of limit. Minimum passing margin is - 5.15dB at 0.16172MHz
15.247(d) 15.209	Radiated Emissions	PASS	Meet the requirement of limit. Minimum passing margin is -0.4dB at 2483.50MHz
15.247(d)	Band Edge Measurement	PASS	Meet the requirement of limit.
15.247(a)(2)	6dB bandwidth	PASS	Meet the requirement of limit.
15.247(b)	Conducted Output power	PASS	Meet the requirement of limit.
15.247(e)	Power Spectral Density	PASS	Meet the requirement of limit.
15.203	Antenna Requirement	PASS	Antenna connector is i-pex (MHF) not a standard connector.

For 5GHz, 5725~5850MHz Band

APPLIED STANDARD: FCC PART 15, SUBPART C (SECTION 15.247)			
STANDARD SECTION	TEST TYPE	RESULT	REMARK
15.207	AC Power Conducted Emission	PASS	Meet the requirement of limit. Minimum passing margin is -6.29dB at 0.15781MHz
15.247(d) 15.209	Radiated Emissions	PASS	Meet the requirement of limit. Minimum passing margin is -0.2dB at 5133.00MHz.
15.247(d)	Band Edge Measurement	PASS	Meet the requirement of limit.
15.247(a)(2)	6dB bandwidth	PASS	Meet the requirement of limit.
15.247(b)	Conducted Output power	PASS	Meet the requirement of limit.
15.247(e)	Power Spectral Density	PASS	Meet the requirement of limit.
15.203	Antenna Requirement	PASS	Antenna connector is i-pex (MHF) not a standard connector.

NOTE:

The EUT was operating in 2.400 ~ 2.4835GHz, 5.15~5.25GHz and 5.725~5.850GHz frequencies band. This report was recorded the RF parameters including 2.400 ~ 2.4835GHz and 5.725~5.850GHz. For the 5.15~5.25GHz RF parameters was recorded in another test report.



A D T

2.1 MEASUREMENT UNCERTAINTY

Where relevant, the following measurement uncertainty levels have been estimated for tests performed on the EUT as specified in CISPR 16-4-2:

This uncertainty represents an expanded uncertainty expressed at approximately the 95% confidence level using a coverage factor of $k=2$.

Measurement	Value
Conducted emissions	2.98 dB
Radiated emissions (30MHz-1GHz)	5.37 dB
Radiated emissions (1GHz -6GHz)	3.65 dB
Radiated emissions (6GHz -18GHz)	3.88 dB
Radiated emissions (18GHz -40GHz)	4.11 dB



A D T

3. GENERAL INFORMATION

3.1 GENERAL DESCRIPTION OF EUT

PRODUCT	AC1900 Dual Band Wireless Router
MODEL NO.	TEW-818DRU
POWER SUPPLY	DC 12V from power adapter
MODULATION TYPE	CCK, DQPSK, DBPSK for DSSS 64QAM, 16QAM, QPSK, BPSK for OFDM 256QAM for OFDM in 11ac mode and 11n (HT40) mode of 2.4GHz Band.
MODULATION TECHNOLOGY	DSSS,OFDM
TRANSFER RATE	2.4GHz: 802.11b: up to 11Mbps 802.11g: up to 54Mbps 802.11n: up to 600Mbps 5GHz: 802.11a: up to 54Mbps 802.11n: up to 450Mbps 802.11ac: up to 1300Mbps
OPERATING FREQUENCY	For 15.407 5GHz: 5.18 ~ 5.24GHz For 15.247 2.4GHz: 2.412 ~ 2.462GHz 5GHz: 5.745 ~ 5.825GHz
NUMBER OF CHANNEL	For 15.407 4 for 802.11a, 802.11n (HT20), 802.11ac (VHT20) 2 for 802.11n (HT40), 802.11ac (VHT40) 1 for 802.11ac (VHT80) For 15.247 (2.4GHz) 11 for 802.11b, 802.11g, 802.11n (HT20) 7 for 802.11n (HT40) For 15.247 (5GHz) 5 for 802.11a, 802.11n (HT20), 802.11ac (VHT20) 2 for 802.11n (HT40), 802.11ac (VHT40) 1 for 802.11ac (VHT80)

MAXIMUM OUTPUT POWER	For 15.407 802.11a: 46.132mW 802.11ac (VHT20): 18.067mW 802.11ac (VHT40): 17.615mW 802.11ac (VHT80): 17.630mW For 15.247(2.4GHz) 802.11b: 218.273mW 802.11g: 412.098mW 802.11n (HT20): 705.471mW 802.11n (HT40): 263.260mW For 15.247(5GHz) 802.11a: 503.501mW 802.11ac (VHT20): 357.489mW 802.11ac (VHT40): 359.219mW 802.11ac (VHT80): 350.574mW
ANTENNA TYPE	Please see NOTE
DATA CABLE	Ethernet Cable (unshielded, 1.5m) x1
I/O PORTS	Refer to user's manual
ASSOCIATED DEVICES	Adapter x1

NOTE:

- 2.4GHz and 5GHz technology can transmit at same time.
- The EUT must be supplied with a power adapter and following two different models could be chosen as following table:

No	Brand	Model No.	Plug	Spec.
1	HON-KWANG	HK-AX-120A200-US	US	Input: 100-240V, 800mA, 47~63Hz Output: 12V, 2000mA DC output cable: 1.5m, unshielded
2	KTEC	KSASB0241200200HU	US	Input: 100-240V, 600mA, 47~63Hz Output: 12V, 2000mA DC output cable: 1.5m, unshielded
Note:	For radiated emissions test, the EUT was pre-tested with above adapters 1 & 2, the worst case was found in adapter 1. Therefore only the test data of the adapter was recorded in this report.			

3. The antennas provided to the EUT, please refer to the following table:

Ant. No.	Transmitter Circuit	Gain (dBi) (Include cable loss)	Antenna Type	Connector Type	Frequency range (GHz to GHz)	Cable Length (mm)
1	Chain (0)	2.5	Dipole	i-pex (MHF)	2.4~2.4835	78
	Chain (2)	4.8			5.15~5.85	
2	Chain (1)	6	Dipole	i-pex (MHF)	2.4~2.4835	90
					5.15~5.85	
3	Chain (2)	5.5	Dipole	i-pex (MHF)	2.4~2.4835	185
	Chain (0)	6			5.15~5.85	

Note: 1. From above antennas, 802.11b mode will fix transmission on Chain (0).
 2. From above antennas, 802.11g mode the worst case was found in Chain (1).
 3. From above antennas, 802.11a mode the worst case was found in Chain (0).
 Therefore only the test data of the mode was recorded in this report.

4. The EUT incorporates a MIMO function.

MODULATION MODE	Tx/Rx FUNCTION
802.11a	1TX (Diversity) / 3RX
802.11b	1TX (Fixed Chain 0) / 3RX
802.11g	1TX (Diversity) / 3RX
802.11n (HT20)	3TX/3RX
802.11n (HT40)	3TX/3RX
802.11ac (VHT20)	3TX/3RX
802.11ac (VHT40)	3TX/3RX
802.11ac (VHT80)	3TX/3RX

Note: 1. The EUT support 2.4GHz band MIMO without beam forming function and 5GHz band MIMO with beam forming function.

2. The modulation and bandwidth are similar for 802.11n mode for 20MHz (40MHz) and 802.11ac mode for 20MHz (40MHz), therefore investigated worst case to representative mode in test report. (Final test mode refer section 3.2.1)

5. When the EUT operating in 802.11n, the software operation, which is defined by manufacturer, MCS (Modulation and Coding Schemes) from 0 to 23.
6. When the EUT operating in 802.11ac and support 256QAM of 802.11n (HT40) for 2.4GHz band, the software operation, which is defined by manufacturer, MCS (Modulation and Coding Schemes) from 0 to 9.
7. The above EUT information was declared by the manufacturer and for more detailed features description, please refer to the manufacturer's specifications or User's Manual.

3.2 DESCRIPTION OF TEST MODES

Operated in 2400 ~ 2483.5MHz band:

11 channels are provided for 802.11b, 802.11g, 802.11n (HT20):

CHANNEL	FREQUENCY	CHANNEL	FREQUENCY
1	2412MHz	7	2442MHz
2	2417MHz	8	2447MHz
3	2422MHz	9	2452MHz
4	2427MHz	10	2457MHz
5	2432MHz	11	2462MHz
6	2437MHz		

7 channels are provided for 802.11n (HT40):

CHANNEL	FREQUENCY	CHANNEL	FREQUENCY
3	2422MHz	7	2442MHz
4	2427MHz	8	2447MHz
5	2432MHz	9	2452MHz
6	2437MHz		

Operated in 5725 ~ 5850MHz band:

5 channels are provided for 802.11a, 802.11n (HT20), 802.11ac (VHT20):

CHANNEL	FREQUENCY	CHANNEL	FREQUENCY
149	5745 MHz	161	5805 MHz
153	5765 MHz	165	5825 MHz
157	5785 MHz		

2 channels are provided for 802.11n (HT40), 802.11ac (VHT40):

CHANNEL	FREQUENCY
151	5755 MHz
159	5795 MHz

1 channel is provided for 802.11ac (VHT80):

CHANNEL	FREQUENCY
155	5775 MHz

3.2.1 TEST MODE APPLICABILITY AND TESTED CHANNEL DETAIL

EUT CONFIGURE MODE	APPLICABLE TO					DESCRIPTION
	PLC	RE < 1G	RE ≥ 1G	APCM	OB	
1	√	√	√	√	√	Adapter 1
2	√	-	-	-	-	Adapter 2

Where **PLC**: Power Line Conducted Emission **RE < 1G**: Radiated Emission below 1GHz
RE ≥ 1G: Radiated Emission above 1GHz **APCM**: Antenna Port Conducted Measurement
OB: Conducted Out-Band Emission Measurement

POWER LINE CONDUCTED EMISSION TEST:

- Pre-Scan has been conducted to determine the worst-case mode from all possible combinations between available modulations, data rates and antenna ports (if EUT with antenna diversity architecture).
- Following channel(s) was (were) selected for the final test as listed below.

MODE	AVAILABLE CHANNEL	TESTED CHANNEL	MODULATION TECHNOLOGY	MODULATION TYPE	DATA RATE (Mbps)
For 2.4 GHz 802.11n (HT20)	1 to 11	6	OFDM	BPSK	6.5
For 5 GHz 802.11ac (VHT40)	151 to 159	159	OFDM	BPSK	13.5

RADIATED EMISSION TEST (BELOW 1 GHz):

- Pre-Scan has been conducted to determine the worst-case mode from all possible combinations between available modulations, data rates and antenna ports (if EUT with antenna diversity architecture).
- Following channel(s) was (were) selected for the final test as listed below.

MODE	AVAILABLE CHANNEL	TESTED CHANNEL	MODULATION TECHNOLOGY	MODULATION TYPE	DATA RATE (Mbps)
For 2.4 GHz 802.11n (HT20)	1 to 11	6	OFDM	BPSK	6.5
For 5 GHz 802.11ac (VHT40)	151 to 159	159	OFDM	BPSK	13.5



A D T

RADIATED EMISSION TEST (ABOVE 1 GHz):

- Pre-Scan has been conducted to determine the worst-case mode from all possible combinations between available modulations, data rates and antenna ports (if EUT with antenna diversity architecture).
- Following channel(s) was (were) selected for the final test as listed below.

MODE	AVAILABLE CHANNEL	TESTED CHANNEL	MODULATION TECHNOLOGY	MODULATION TYPE	DATA RATE (Mbps)
802.11b	1 to 11	1, 6, 11	DSSS	DBPSK	1
802.11g	1 to 11	1, 6, 11	OFDM	BPSK	6
For 2.4 GHz 802.11n (HT20)	1 to 11	1, 6, 11	OFDM	BPSK	6.5
For 2.4 GHz 802.11n (HT40)	3 to 9	3, 6, 9	OFDM	BPSK	13.5
802.11a	149 to 165	149, 157, 165	OFDM	BPSK	6
For 5 GHz 802.11ac (VHT20)	149 to 165	149, 157, 165	OFDM	BPSK	6.5
For 5 GHz 802.11ac (VHT40)	151 to 159	151, 159	OFDM	BPSK	13.5
For 5 GHz 802.11ac (VHT80)	155	155	OFDM	BPSK	29.3

ANTENNA PORT CONDUCTED MEASUREMENT:

- Pre-Scan has been conducted to determine the worst-case mode from all possible combinations between available modulations, data rates and antenna ports (if EUT with antenna diversity architecture).
- Following channel(s) was (were) selected for the final test as listed below.

MODE	AVAILABLE CHANNEL	TESTED CHANNEL	MODULATION TECHNOLOGY	MODULATION TYPE	DATA RATE (Mbps)
802.11b	1 to 11	1, 6, 11	DSSS	DBPSK	1
802.11g	1 to 11	1, 6, 11	OFDM	BPSK	6
For 2.4 GHz 802.11n (HT20)	1 to 11	1, 6, 11	OFDM	BPSK	6.5
For 2.4 GHz 802.11n (HT40)	3 to 9	3, 6, 9	OFDM	BPSK	13.5
802.11a	149 to 165	149, 157, 165	OFDM	BPSK	6
For 5 GHz 802.11ac (VHT20)	149 to 165	149, 157, 165	OFDM	BPSK	6.5
For 5 GHz 802.11ac (VHT40)	151 to 159	151, 159	OFDM	BPSK	13.5
For 5 GHz 802.11ac (VHT80)	155	155	OFDM	BPSK	29.3



A D T

CONDUCTED OUT-BAND EMISSION MEASUREMENT:

- Pre-Scan has been conducted to determine the worst-case mode from all possible combinations between available modulations, data rates and antenna ports (if EUT with antenna diversity architecture).
- Following channel(s) was (were) selected for the final test as listed below.

MODE	AVAILABLE CHANNEL	TESTED CHANNEL	MODULATION TECHNOLOGY	MODULATION TYPE	DATA RATE (Mbps)
802.11b	1 to 11	1, 6, 11	DSSS	DBPSK	1
802.11g	1 to 11	1, 6, 11	OFDM	BPSK	6
For 2.4 GHz 802.11n (HT20)	1 to 11	1, 6, 11	OFDM	BPSK	6.5
For 2.4 GHz 802.11n (HT40)	3 to 9	3, 6, 9	OFDM	BPSK	13.5
802.11a	149 to 165	149, 157, 165	OFDM	BPSK	6
For 5 GHz 802.11ac (VHT20)	149 to 165	149, 157, 165	OFDM	BPSK	6.5
For 5 GHz 802.11ac (VHT40)	151 to 159	151, 159	OFDM	BPSK	13.5
For 5 GHz 802.11ac (VHT80)	155	155	OFDM	BPSK	29.3

TEST CONDITION:

APPLICABLE TO	ENVIRONMENTAL CONDITIONS	INPUT POWER	TESTED BY
PLC	21deg. C, 68%RH	120Vac, 60Hz	Jyunchun Lin
RE<1G	20deg. C, 73%RH	120Vac, 60Hz	Jason Huang
RE ³ 1G	26deg. C, 72%RH	120Vac, 60Hz	Chilin Lee
	22deg. C, 61%RH	120Vac, 60Hz	Chilin Lee
APCM	25deg. C, 60%RH	120Vac, 60Hz	Robert Cheng
OB	25deg. C, 60%RH	120Vac, 60Hz	Robert Cheng

3.3 GENERAL DESCRIPTION OF APPLIED STANDARDS

The EUT is a RF product. According to the specifications of the manufacturer, it must comply with the requirements of the following standards:

FCC Part 15, Subpart C. (15.247)

558074 D01 DTS Meas Guidance v03r01

662911 D01 Multiple Transmitter Output v01 r02

ANSI C63.10-2009

All test items have been performed and recorded as per the above standards.

Note: The EUT has been verified to comply with the requirements of FCC Part 15, Subpart B, Class B (DoC). The test report has been issued separately.

3.4 DUTY CYCLE OF TEST SIGNAL

If duty cycle of test signal is $\geq 98\%$, duty factor is not required.

If duty cycle of test signal is $< 98\%$, duty factor shall be considered.

802.11b: Duty cycle = 1.205 ms/1.221 ms = 0.987

802.11g: Duty cycle = 2.054 ms/2.075 ms = 0.99

802.11n (HT20): Duty cycle = 1.914 ms/1.935 ms = 0.989

802.11n (HT40): Duty cycle = 0.941 ms/0.963 ms = 0.977, Duty factor = $10 * \log(1/0.977) = 0.1$

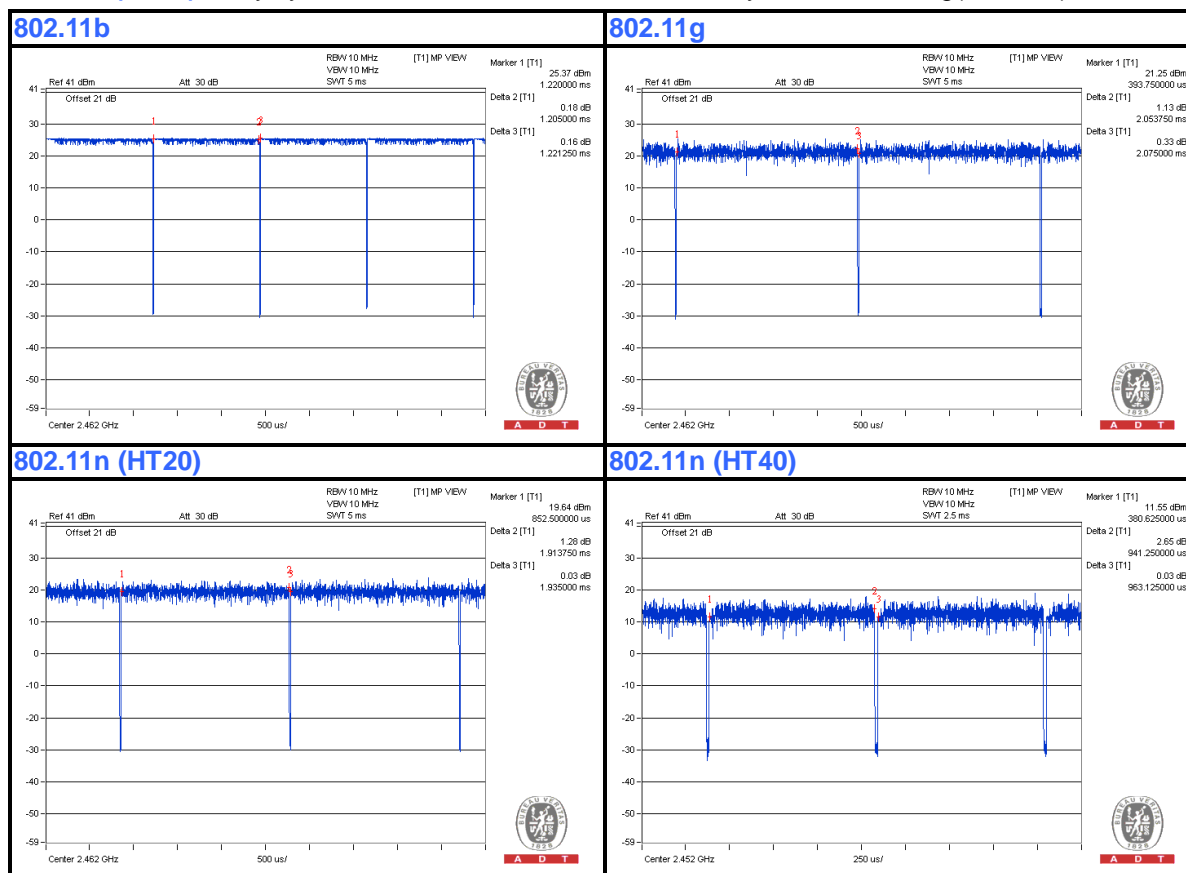



A D T

If duty cycle of test signal is $\geq 98\%$, duty factor is not required.

If duty cycle of test signal is $< 98\%$, duty factor shall be considered.

802.11a: Duty cycle = $2.061 \text{ ms} / 2.089 \text{ ms} = 0.987$

802.11ac (VHT20): Duty cycle = $1.925 \text{ ms} / 1.949 \text{ ms} = 0.988$

802.11ac (VHT40): Duty cycle = $0.952 \text{ ms} / 0.97 \text{ ms} = 0.981$

802.11ac (VHT80): Duty cycle = $0.46 \text{ ms} / 0.477 \text{ ms} = 0.964$, Duty factor = $10 * \log(1/0.964) = 0.16$

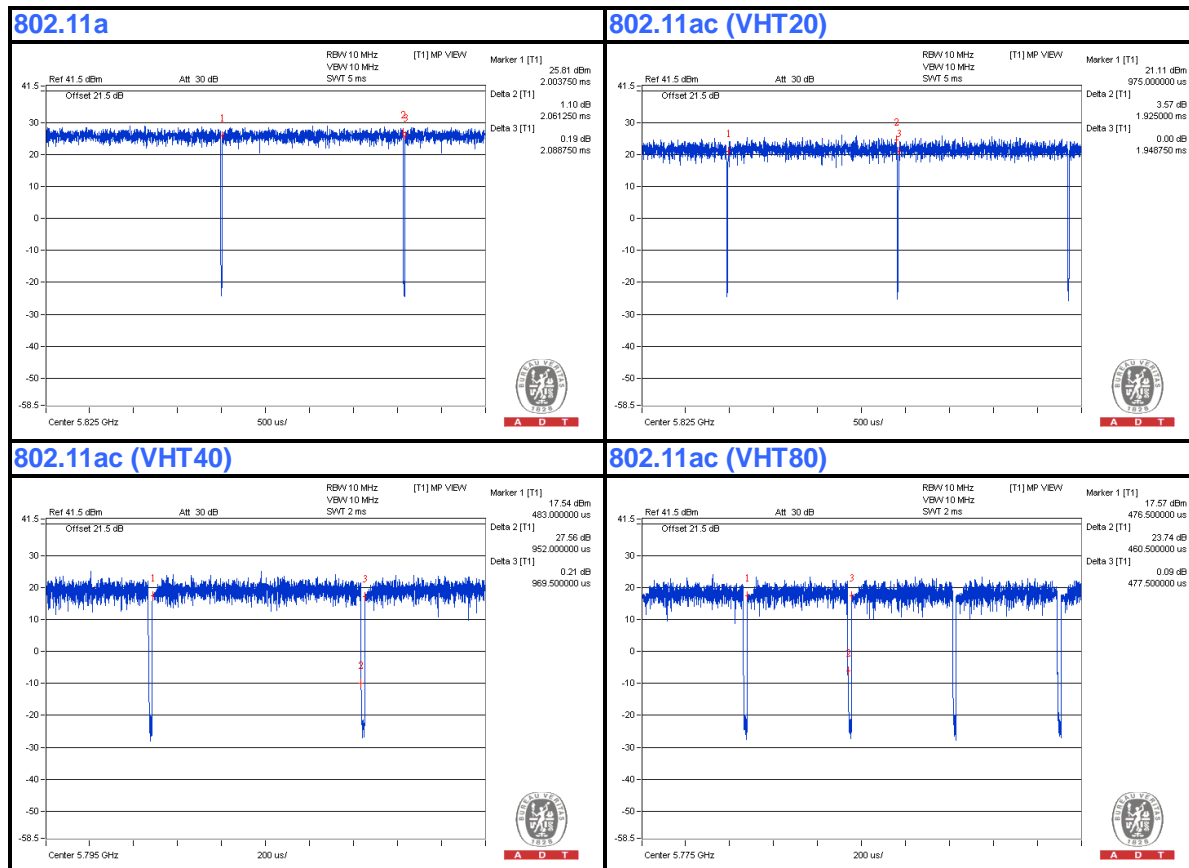



A D T

3.5 DESCRIPTION OF SUPPORT UNITS

The EUT has been tested as an independent unit together with other necessary accessories or support units. The following support units or accessories were used to form a representative test configuration during the tests.

NO.	PRODUCT	BRAND	MODEL NO.	SERIAL NO.	FCC ID
1	NOTEBOOK COMPUTER	DELL	PP32LA	FSLB32S	FCC DoC
2	NOTEBOOK COMPUTER	DELL	PP32LA	GSLB32S	FCC DoC
3	CO-ROUTER	ZyXEL	IES-1000	S4Z3112558	NA
4	HUB	ZyXEL	ES-116P	S060H0200021 5	FCC DoC
5	iPod shuffle	Apple	MC749TA/A	CC4DMFJUDFD M	NA
6	External Hard Drive	WD	WDBACW0010H BK-SESN	WCAZAL62578 7	FCC DoC
7	USB 3.0 Flash disk	ADATA	C103	NA	NA

NO.	SIGNAL CABLE DESCRIPTION OF THE ABOVE SUPPORT UNITS
1	UTP Cable, 10m
2	UTP Cable, 10m
3	RJ-11 Cable, 10m
4	UTP Cable, 10m
5	USB Cable, 0.1m
6	USB Cable, 0.5m
7	NA

NOTE: All power cords of the above support units are non shielded (1.8m).

3.6 CONFIGURATION OF SYSTEM UNDER TEST

For Conducted Emission Test:

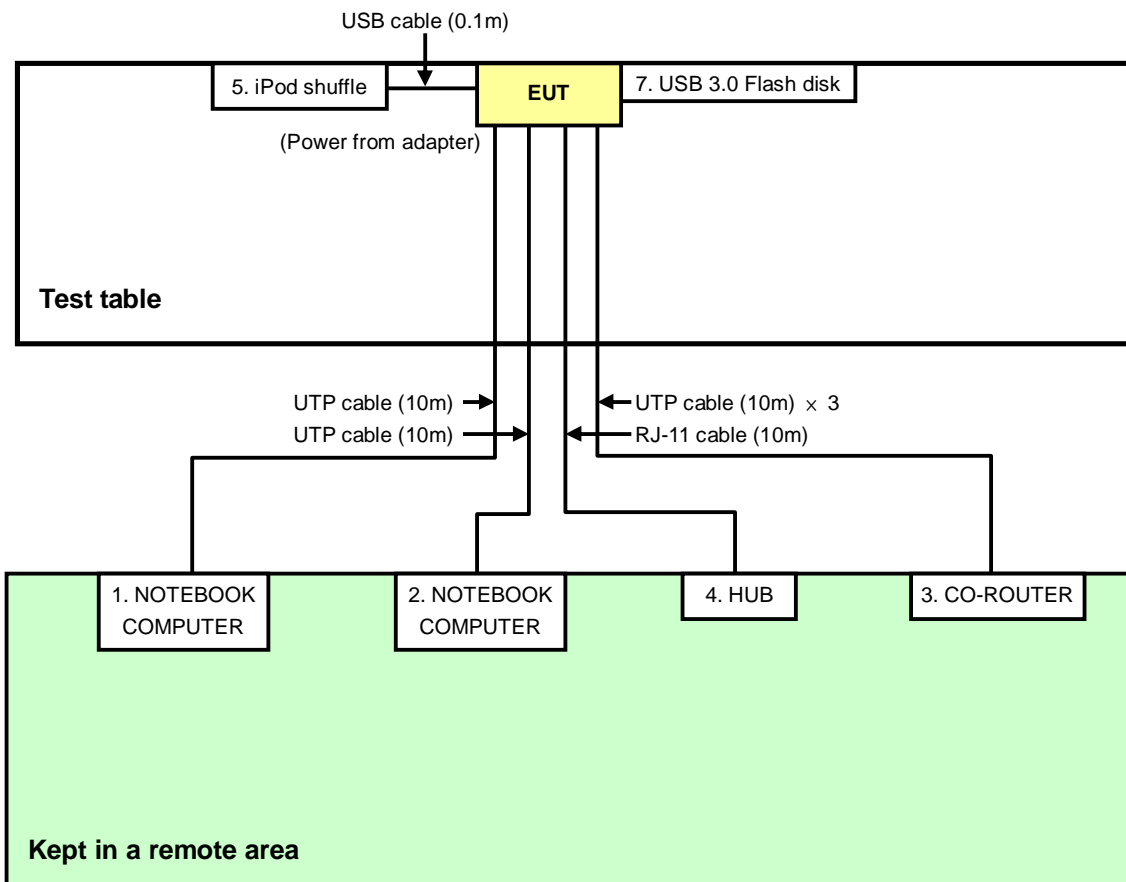

For Radiated Emission Test:

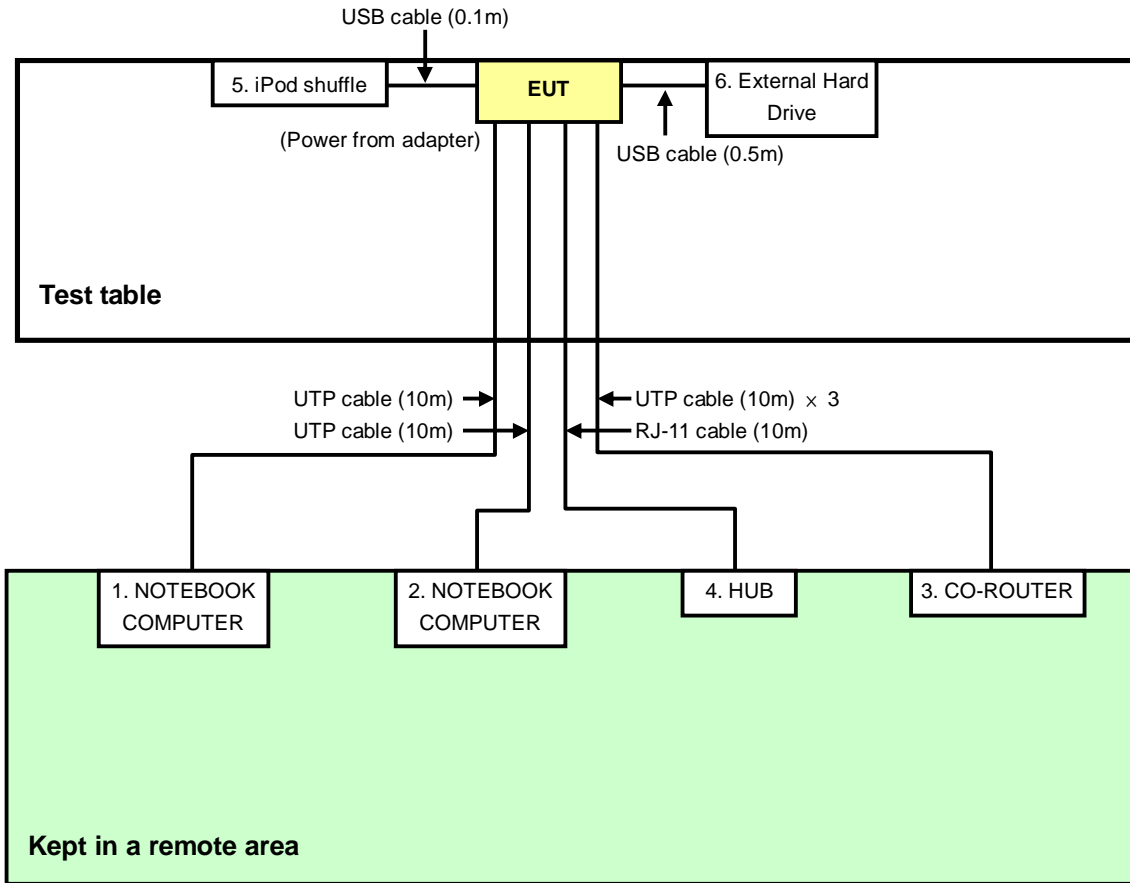



A D T

4. TEST TYPES AND RESULTS (FOR 2.4GHz, 2.400 ~ 2.4835GHz Band)

4.1 CONDUCTED EMISSION MEASUREMENT

4.1.1 LIMITS OF CONDUCTED EMISSION MEASUREMENT

FREQUENCY OF EMISSION (MHz)	CONDUCTED LIMIT (dBµV)	
	Quasi-peak	Average
0.15-0.5	66 to 56	56 to 46
0.5-5	56	46
5-30	60	50

- NOTE:**
1. The lower limit shall apply at the transition frequencies.
 2. The limit decreases in line with the logarithm of the frequency in the range of 0.15 to 0.50 MHz.

4.1.2 TEST INSTRUMENTS

DESCRIPTION & MANUFACTURER	MODEL NO.	SERIAL NO.	CALIBRATED DATE	CALIBRATED UNTIL
Test Receiver ROHDE & SCHWARZ	ESCS 30	100287	Feb. 28, 2013	Feb. 27, 2014
Line-Impedance Stabilization Network (for EUT) ROHDE & SCHWARZ	NSLK-8127	5127-523	Oct. 02, 2013	Oct. 01, 2014
Line-Impedance Stabilization Network (for Peripheral) ROHDE & SCHWARZ	ENV216	100071	Nov. 13, 2013	Nov. 12, 2014
RF Cable (JYEBAO)	5DFB	COACAB-001	May 27, 2013	May 26, 2014
50 ohms Terminator	50	3	Oct. 17, 2013	Oct. 16, 2014
50 ohms Terminator	N/A	EMC-04	Oct. 17, 2013	Oct. 16, 2014
Software ADT	BV ADT_Cond_V7.3.7 .3	NA	NA	NA

Note:

1. The calibration interval of the above test instruments is 12 months and the calibrations are traceable to NML/ROC and NIST/USA.
2. The test was performed in Shielded Room No. A.
3. The VCCI Con A Registration No. is C-817.
4. Tested Date: Dec. 25, 2013

4.1.3 TEST PROCEDURES

- a. The EUT was placed 0.4 meters from the conducting wall of the shielded room with EUT being connected to the power mains through a line impedance stabilization network (LISN). Other support units were connected to the power mains through another LISN.
- b. The two LISNs provide 50 ohm/ 50uH of coupling impedance for the measuring instrument.
- c. Both lines of the power mains connected to the EUT were checked for maximum conducted interference.
- d. The frequency range from 150kHz to 30MHz was searched. Emission levels under (Limit - 20dB) were not recorded.

NOTE:

1. The resolution bandwidth of test receiver is 9kHz for Quasi-peak detection (QP) & Average detection (AV).

4.1.4 DEVIATION FROM TEST STANDARD

No deviation

4.1.5 TEST SETUP

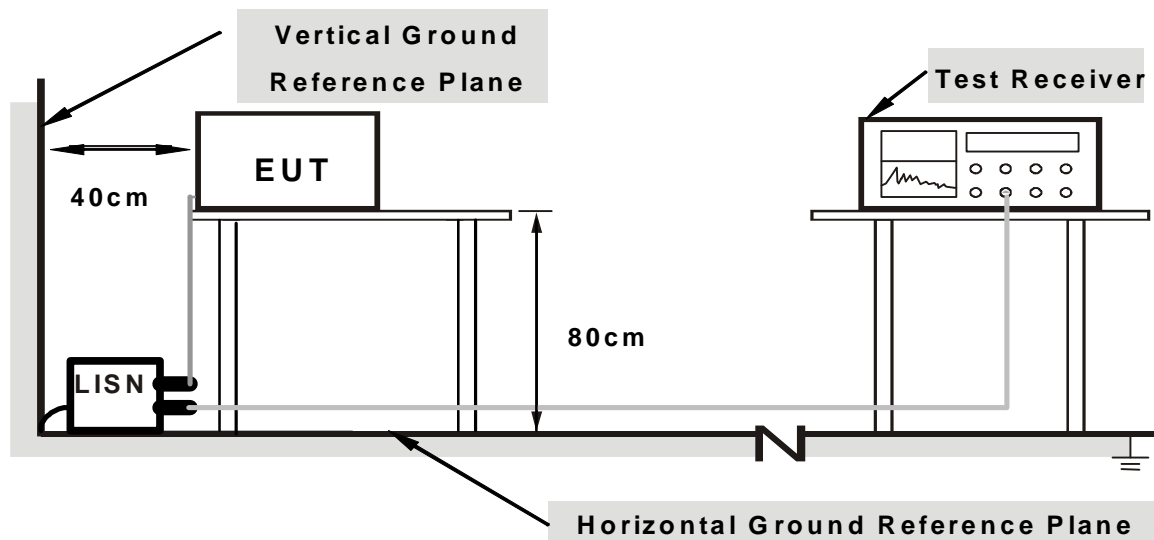

Note: 1.Support units were connected to second LISN.

For the actual test configuration, please refer to the related item – Photographs of the Test Configuration.



A D T

4.1.6 EUT OPERATING CONDITIONS

1. Place the EUT on testing table.
2. Prepare computer system (support unit 1) to act as communication partner.
3. The communication partner runs test program "Mtool_2.0.1.0.exe" to enable EUT under transmission/receiving condition continuously at specific channel frequency.

4.1.7 TEST RESULTS (MODE 1)

PHASE	Line (L)	DETECTOR FUNCTION	Quasi-Peak (QP) / Average (AV)
--------------	----------	--------------------------	--------------------------------

No	Freq.	Corr.	Reading Value		Emission Level		Limit		Margin	
	[MHz]	Factor (dB)	Q.P. [dB (uV)]	AV. [dB (uV)]	Q.P. [dB (uV)]	AV. [dB (uV)]	Q.P. [dB (uV)]	AV. [dB (uV)]	Q.P. (dB)	AV. (dB)
	1	0.16953	0.07	56.56	42.61	56.63	42.68	64.98	54.98	-8.35
2	0.20819	0.08	53.37	38.11	53.45	38.19	63.28	53.28	-9.82	-15.08
3	0.25156	0.10	48.66	34.14	48.76	34.24	61.71	51.71	-12.95	-17.47
4	0.29453	0.11	43.08	31.57	43.19	31.68	60.40	50.40	-17.21	-18.72
5	0.46337	0.14	42.18	34.34	42.32	34.48	56.63	46.63	-14.31	-12.15
6	0.86094	0.17	37.58	29.93	37.75	30.10	56.00	46.00	-18.25	-15.90

REMARKS:

1. Q.P. and AV. are abbreviations of quasi-peak and average individually.
2. The emission levels of other frequencies were very low against the limit.
3. Margin value = Emission Level – Limit value
4. Correction Factor = Insertion loss + Cable loss
5. Emission Level = Correction Factor + Reading Value

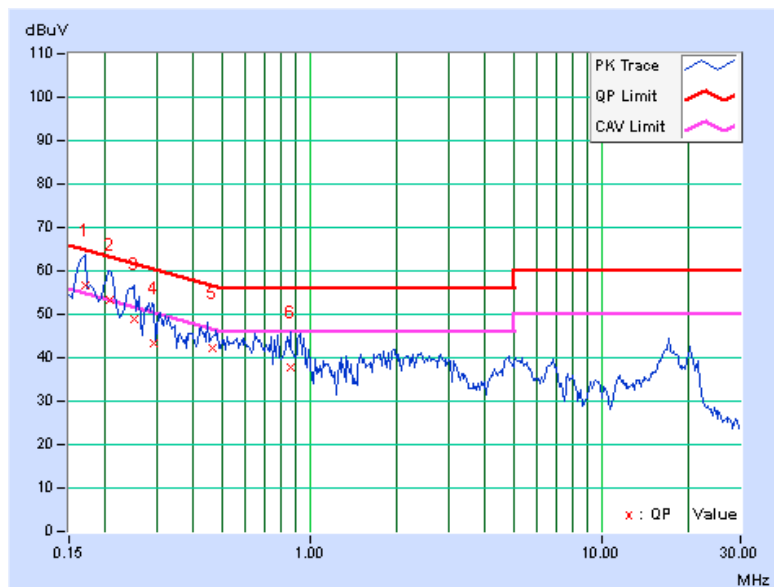

PHASE	Neutral (N)	DETECTOR FUNCTION	Quasi-Peak (QP) / Average (AV)
--------------	-------------	--------------------------	--------------------------------

No	Freq. [MHz]	Corr. Factor (dB)	Reading Value [dB (uV)]		Emission Level [dB (uV)]		Limit [dB (uV)]		Margin (dB)	
			Q.P.	AV.	Q.P.	AV.	Q.P.	AV.	Q.P.	AV.
1	0.16172	0.07	56.70	45.36	56.77	45.43	65.38	55.38	-8.61	-9.95
2	0.20469	0.07	50.85	40.12	50.92	40.19	63.42	53.42	-12.50	-13.23
3	0.23594	0.08	48.28	32.40	48.36	32.48	62.24	52.24	-13.88	-19.76
4	0.35313	0.12	41.88	30.35	42.00	30.47	58.89	48.89	-16.88	-18.41
5	0.50938	0.15	47.25	39.60	47.40	39.75	56.00	46.00	-8.60	-6.25
6	0.88828	0.17	40.48	33.63	40.65	33.80	56.00	46.00	-15.35	-12.20

REMARKS:

1. Q.P. and AV. are abbreviations of quasi-peak and average individually.
2. The emission levels of other frequencies were very low against the limit.
3. Margin value = Emission Level – Limit value
4. Correction Factor = Insertion loss + Cable loss
5. Emission Level = Correction Factor + Reading Value

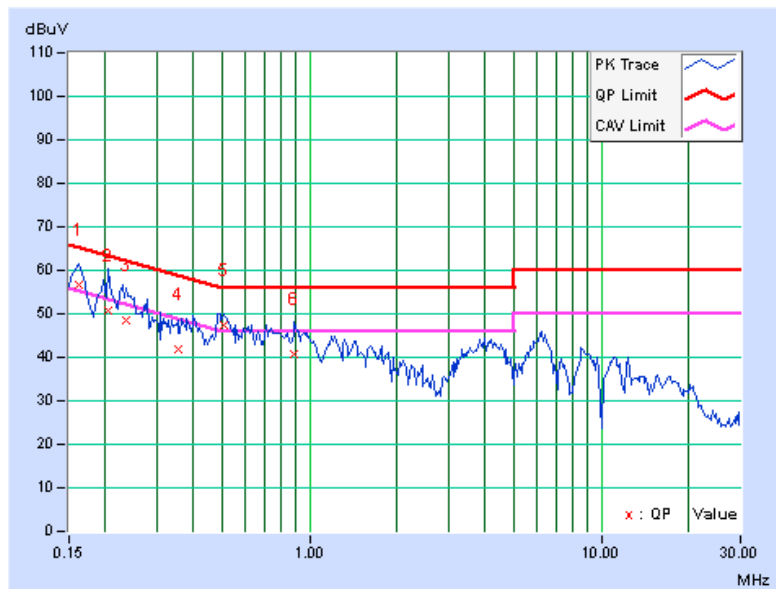



A D T

4.1.8 TEST RESULTS (MODE 2)

PHASE	Line (L)	DETECTOR FUNCTION	Quasi-Peak (QP) / Average (AV)
-------	----------	-------------------	--------------------------------

No	Freq. [MHz]	Corr. Factor (dB)	Reading Value [dB (uV)]		Emission Level [dB (uV)]		Limit [dB (uV)]		Margin (dB)	
			Q.P.	AV.	Q.P.	AV.	Q.P.	AV.	Q.P.	AV.
			1	0.15391	0.07	59.76	47.67	59.83	47.74	65.79
2	0.19687	0.08	54.73	41.29	54.81	41.37	63.74	53.74	-8.93	-12.37
3	0.22812	0.09	50.21	34.36	50.30	34.45	62.52	52.52	-12.22	-18.07
4	0.27500	0.10	46.79	33.46	46.89	33.56	60.97	50.97	-14.07	-17.40
5	0.35313	0.13	43.08	30.25	43.21	30.38	58.89	48.89	-15.68	-18.51
6	0.47031	0.14	40.44	26.56	40.58	26.70	56.51	46.51	-15.92	-19.80

REMARKS:

1. Q.P. and AV. are abbreviations of quasi-peak and average individually.
2. The emission levels of other frequencies were very low against the limit.
3. Margin value = Emission Level – Limit value
4. Correction Factor = Insertion loss + Cable loss
5. Emission Level = Correction Factor + Reading Value

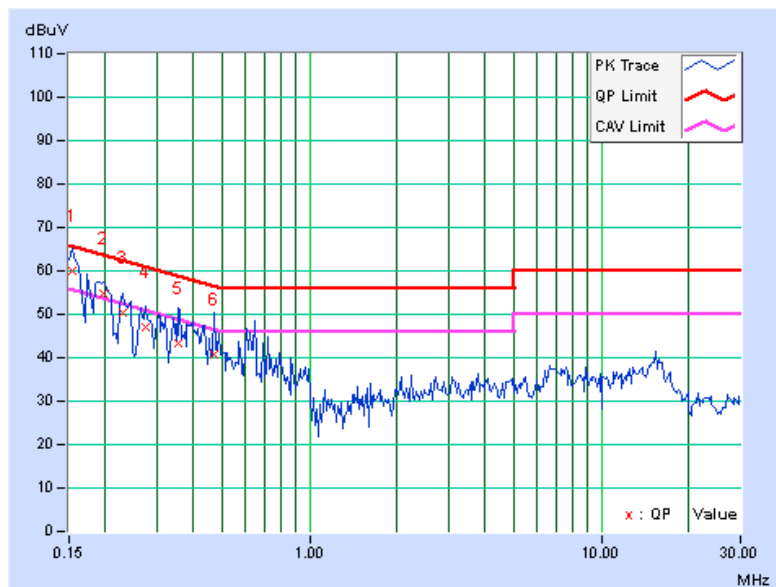

PHASE	Neutral (N)	DETECTOR FUNCTION	Quasi-Peak (QP) / Average (AV)
--------------	-------------	--------------------------	--------------------------------

No	Freq. [MHz]	Corr. Factor (dB)	Reading Value [dB (uV)]		Emission Level [dB (uV)]		Limit [dB (uV)]		Margin (dB)	
			Q.P.	AV.	Q.P.	AV.	Q.P.	AV.	Q.P.	AV.
1	0.16172	0.07	60.16	48.99	60.23	49.06	65.38	55.38	-5.15	-6.32
2	0.22812	0.08	51.13	35.29	51.21	35.37	62.52	52.52	-11.31	-17.15
3	0.32188	0.11	46.08	30.59	46.19	30.70	59.66	49.66	-13.47	-18.96
4	0.39219	0.14	45.70	32.90	45.84	33.04	58.02	48.02	-12.18	-14.98
5	0.48203	0.15	40.07	25.47	40.22	25.62	56.30	46.30	-16.09	-20.69
6	0.67344	0.16	35.59	20.25	35.75	20.41	56.00	46.00	-20.25	-25.59

REMARKS:

1. Q.P. and AV. are abbreviations of quasi-peak and average individually.
2. The emission levels of other frequencies were very low against the limit.
3. Margin value = Emission Level – Limit value
4. Correction Factor = Insertion loss + Cable loss
5. Emission Level = Correction Factor + Reading Value

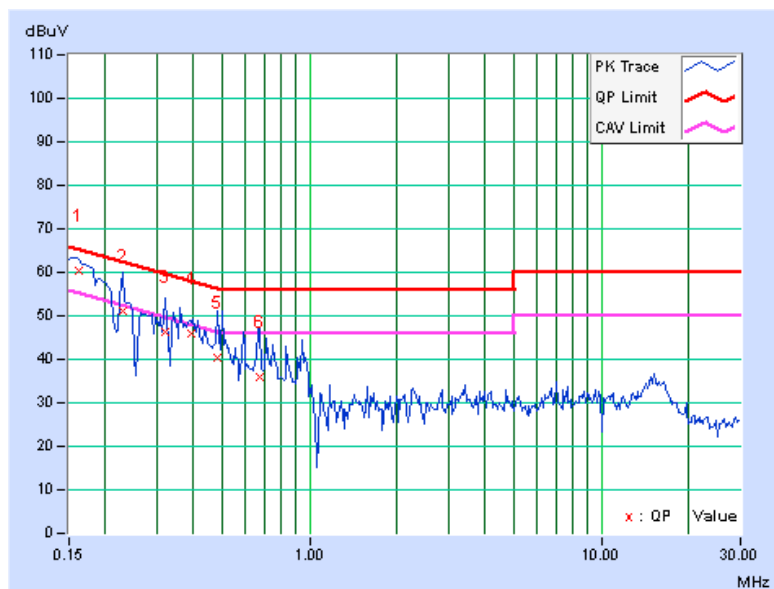

4.2 RADIATED EMISSION AND BANDEGE MEASUREMENT

4.2.1 LIMITS OF RADIATED EMISSION AND BANDEGE MEASUREMENT

Radiated emissions which fall in the restricted bands must comply with the radiated emission limits specified as below table. Other emissions shall be at least 30dB below the highest level of the desired power:

Frequencies (MHz)	Field strength (microvolts/meter)	Measurement distance (meters)
0.009-0.490	2400/F(kHz)	300
0.490-1.705	24000/F(kHz)	30
1.705-30.0	30	30
30-88	100	3
88-216	150	3
216-960	200	3
Above 960	500	3

NOTE:

1. The lower limit shall apply at the transition frequencies.
2. Emission level (dBuV/m) = 20 log Emission level (uV/m).
3. For frequencies above 1000MHz, the field strength limits are based on average detector, however, the peak field strength of any emission shall not exceed the maximum permitted average limits, specified above by more than 20dB under any condition of modulation.



A D T

4.2.2 TEST INSTRUMENTS

DESCRIPTION & MANUFACTURER	MODEL NO.	SERIAL NO.	CALIBRATED DATE	CALIBRATED UNTIL
MXE EMI Receiver Agilent	N9038A	MY51210105	Jan. 29,2013	Jan. 28,2014
Pre-Amplifier Mini-Circuits	ZFL-1000VH2 B	AMP-ZFL-03	Nov. 13, 2013	Nov. 12, 2014
Trilog Broadband Antenna SCHWARZBECK	VULB 9168	9168-360	Mar. 19, 2013	Mar. 18, 2014
RF Cable	NA	CHGCAB_001	Oct. 05, 2013	Oct. 04, 2014
Spectrum Analyzer R&S	FSV40	100964	July 15, 2013	July 14, 2014
Horn_Antenna AISI	AIH.8018	0000320091110	Nov. 18, 2013	Nov. 17, 2014
Pre-Amplifier Agilent	8449B	3008A02578	June 25, 2013	June 24, 2014
RF Cable	NA	RF104-201 RF104-203 RF104-204	Dec. 12, 2013	Dec. 11, 2014
Spectrum Analyzer Agilent	E4446A	MY48250253	Aug. 28, 2013	Aug. 27, 2014
Pre-Amplifier SPACEK LABS	SLKKa-48-6	9K16	Nov. 13, 2013	Nov. 12, 2014
Horn_Antenna SCHWARZBECK	BBHA 9170	9170-424	Oct. 08, 2013	Oct. 07, 2014
Software	ADT_Radiated _V8.7.07	NA	NA	NA
Antenna Tower & Turn Table CT	NA	NA	NA	NA

Note:

1. The calibration interval of the above test instruments is 12 months and the calibrations are traceable to NML/ROC and NIST/USA.
2. The horn antenna, preamplifier (model: 8449B) are used only for the measurement of emission frequency above 1GHz if tested.
- 3 The test was performed in 966 Chamber No. G.
4. The FCC Site Registration No. is 966073.
- 5 The VCCI Site Registration No. is G-137.
- 6 The CANADA Site Registration No. is IC 7450H-2.
- 7 Tested Date: Dec. 25, 2013 to Jan. 03, 2014

4.2.3 TEST PROCEDURES

- a. The EUT was placed on the top of a rotating table 0.8 meters above the ground at 3 meter chamber room for test. The table was rotated 360 degrees to determine the position of the highest radiation.
- b. The EUT was set 3 meters away from the interference-receiving antenna, which was mounted on the top of a variable-height antenna tower.
- c. The height of antenna is varied from one meter to four meters above the ground to determine the maximum value of the field strength. Both horizontal and vertical polarizations of the antenna are set to make the measurement.
- d. For each suspected emission, the EUT was arranged to its worst case and then the antenna was tuned to heights from 1 meter to 4 meters and the rotatable table was turned from 0 degrees to 360 degrees to find the maximum reading.
- e. The test-receiver system was set to quasi-peak detect function and specified bandwidth with maximum hold mode when the test frequency is below 1 GHz.
- f. The test-receiver system was set to peak and average detect function and specified bandwidth with maximum hold mode when the test frequency is above 1 GHz. If the peak reading value also meets average limit, measurement with the average detector is unnecessary.

Note:

1. The resolution bandwidth and video bandwidth of test receiver/spectrum analyzer is 120kHz for Quasi-peak detection (QP) at frequency below 1GHz.
2. The resolution bandwidth of test receiver/spectrum analyzer is 1 MHz and the video bandwidth is 3 MHz for Peak detection (PK) at frequency above 1GHz.
3. The resolution bandwidth of test receiver/spectrum analyzer is 1MHz and the video bandwidth is 3MHz for RMS Average (Duty cycle < 98%) for Average detection (AV) at frequency above 1GHz, then the measurement results was added to a correction factor ($10 \log(1/\text{duty cycle})$).
4. The resolution bandwidth of test receiver/spectrum analyzer is 1MHz and the video bandwidth is 10Hz (Duty cycle $\geq 98\%$) for Average detection (AV) at frequency above 1GHz.
5. All modes of operation were investigated and the worst-case emissions are reported.

4.2.4 DEVIATION FROM TEST STANDARD

No deviation

4.2.5 TEST SETUP

<Frequency Range below 1GHz>

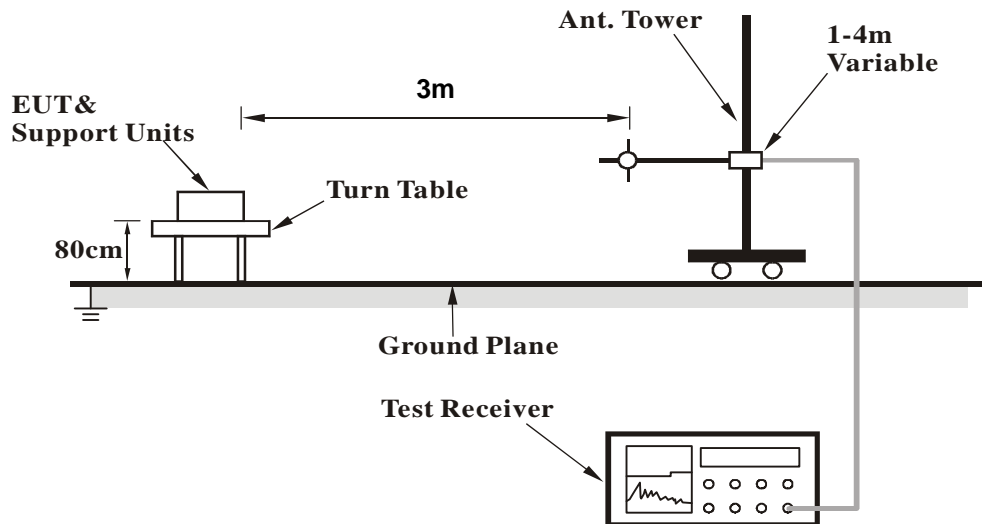

<Frequency Range above 1GHz>

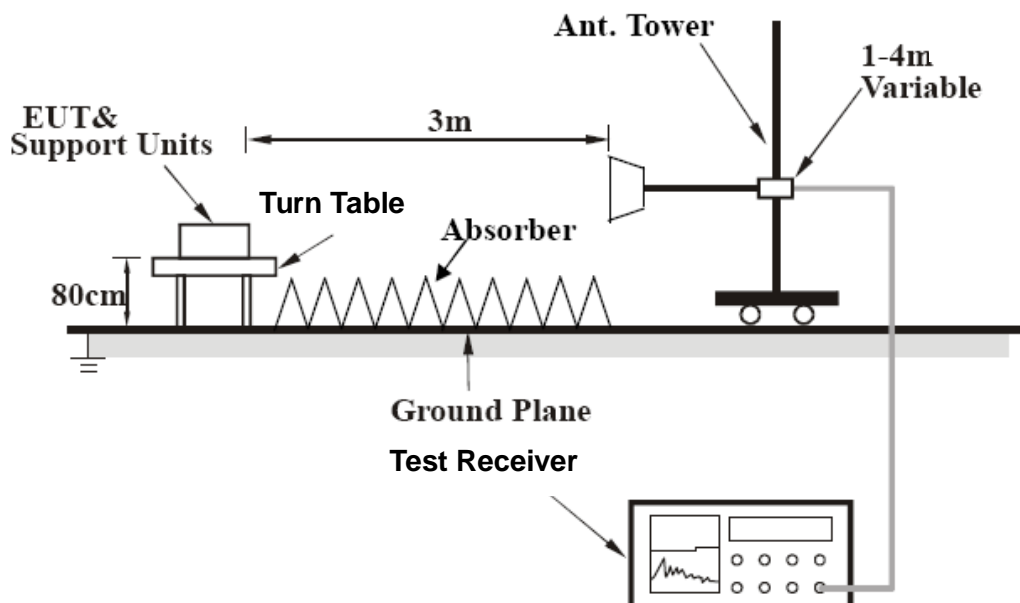

For the actual test configuration, please refer to the related item – Photographs of the Test Configuration.

4.2.6 EUT OPERATING CONDITIONS

Same as 4.1.6

4.2.7 TEST RESULTS

BELOW 1GHz WORST-CASE DATA

802.11n (HT20)

CHANNEL	TX Channel 6	DETECTOR FUNCTION	Quasi-Peak (QP)
FREQUENCY RANGE	Below 1GHz		

ANTENNA POLARITY & TEST DISTANCE: HORIZONTAL AT 3 M								
NO.	FREQ. (MHz)	EMISSION LEVEL (dBuV/m)	LIMIT (dBuV/m)	MARGIN (dB)	ANTENNA HEIGHT (m)	TABLE ANGLE (Degree)	RAW VALUE (dBuV)	CORRECTION FACTOR (dB/m)
1	103.77	35.5 QP	43.5	-8.0	2.00 H	299	52.83	-17.29
2	125.01	33.2 QP	43.5	-10.3	1.50 H	40	48.07	-14.83
3	162.41	32.2 QP	43.5	-11.3	1.50 H	274	45.40	-13.23
4	270.17	34.9 QP	46.0	-11.1	1.00 H	307	48.49	-13.55
5	286.13	33.9 QP	46.0	-12.1	1.00 H	286	46.87	-12.94
6	322.16	31.4 QP	46.0	-14.6	1.00 H	293	43.12	-11.71
ANTENNA POLARITY & TEST DISTANCE: VERTICAL AT 3 M								
NO.	FREQ. (MHz)	EMISSION LEVEL (dBuV/m)	LIMIT (dBuV/m)	MARGIN (dB)	ANTENNA HEIGHT (m)	TABLE ANGLE (Degree)	RAW VALUE (dBuV)	CORRECTION FACTOR (dB/m)
1	92.23	34.2 QP	43.5	-9.3	1.50 V	360	53.18	-18.98
2	109.30	39.0 QP	43.5	-4.6	1.00 V	40	55.10	-16.15
3	129.81	36.0 QP	43.5	-7.5	1.00 V	143	50.78	-14.74
4	162.44	31.1 QP	43.5	-12.5	1.00 V	244	44.29	-13.24
5	270.17	32.6 QP	46.0	-13.4	1.00 V	150	46.13	-13.55
6	400.01	28.7 QP	46.0	-17.3	2.00 V	304	38.58	-9.91

REMARKS:

1. Emission Level(dBuV/m) = Raw Value(dBuV) + Correction Factor(dB/m)
2. Correction Factor(dB/m) = Antenna Factor(dB/m) + Cable Factor(dB) – Pre-Amplifier Factor(dB)
3. The other emission levels were very low against the limit.
4. Margin value = Emission Level – Limit value



A D T

ABOVE 1GHz DATA

802.11b

CHANNEL	TX Channel 1	DETECTOR FUNCTION	Peak (PK)
FREQUENCY RANGE	1GHz ~ 25GHz		Average (AV)

ANTENNA POLARITY & TEST DISTANCE: HORIZONTAL AT 3 M								
NO.	FREQ. (MHz)	EMISSION LEVEL (dBuV/m)	LIMIT (dBuV/m)	MARGIN (dB)	ANTENNA HEIGHT (m)	TABLE ANGLE (Degree)	RAW VALUE (dBuV)	CORRECTION FACTOR (dB/m)
1	2390.00	52.9 PK	74.0	-21.1	1.19 H	20	20.45	32.45
2	2390.00	40.7 AV	54.0	-13.3	1.19 H	20	8.25	32.45
3	*2412.00	111.5 PK			1.19 H	20	78.97	32.53
4	*2412.00	108.8 AV			1.19 H	20	76.27	32.53
5	2487.00	55.7 PK	74.0	-18.3	1.14 H	14	22.90	32.80
6	2487.00	46.9 AV	54.0	-7.1	1.14 H	14	14.10	32.80
7	4824.00	57.7 PK	74.0	-16.3	1.64 H	145	17.26	40.44
8	4824.00	53.5 AV	54.0	-0.5	1.64 H	145	13.06	40.44
9	5000.00	53.9 PK	74.0	-20.1	1.00 H	174	13.11	40.79
10	5000.00	45.2 AV	54.0	-8.8	1.00 H	174	4.41	40.79
ANTENNA POLARITY & TEST DISTANCE: VERTICAL AT 3 M								
NO.	FREQ. (MHz)	EMISSION LEVEL (dBuV/m)	LIMIT (dBuV/m)	MARGIN (dB)	ANTENNA HEIGHT (m)	TABLE ANGLE (Degree)	RAW VALUE (dBuV)	CORRECTION FACTOR (dB/m)
1	2390.00	51.9 PK	74.0	-22.1	1.08 V	264	19.45	32.45
2	2390.00	38.9 AV	54.0	-15.1	1.08 V	264	6.45	32.45
3	*2412.00	108.1 PK			1.08 V	264	75.57	32.53
4	*2412.00	103.8 AV			1.08 V	264	71.27	32.53
5	2487.00	52.0 PK	74.0	-22.0	1.56 V	264	19.20	32.80
6	2487.00	40.8 AV	54.0	-13.2	1.56 V	264	8.00	32.80
7	4824.00	55.3 PK	74.0	-18.7	1.00 V	83	14.86	40.44
8	4824.00	49.5 AV	54.0	-4.5	1.00 V	83	9.06	40.44
9	5000.00	53.2 PK	74.0	-20.8	1.00 V	95	12.41	40.79
10	5000.00	43.5 AV	54.0	-10.5	1.00 V	95	2.71	40.79

REMARKS:

1. Emission Level(dBuV/m) = Raw Value(dBuV) + Correction Factor(dB/m)
2. Correction Factor(dB/m) = Antenna Factor(dB/m) + Cable Factor(dB) – Pre-Amplifier Factor(dB)
3. The other emission levels were very low against the limit.
4. Margin value = Emission Level – Limit value
5. " * ": Fundamental frequency.



A D T

CHANNEL	TX Channel 6	DETECTOR FUNCTION	Peak (PK)
FREQUENCY RANGE	1GHz ~ 25GHz		Average (AV)

ANTENNA POLARITY & TEST DISTANCE: HORIZONTAL AT 3 M

NO.	FREQ. (MHz)	EMISSION LEVEL (dBuV/m)	LIMIT (dBuV/m)	MARGIN (dB)	ANTENNA HEIGHT (m)	TABLE ANGLE (Degree)	RAW VALUE (dBuV)	CORRECTION FACTOR (dB/m)
1	2390.00	54.6 PK	74.0	-19.4	1.20 H	360	22.15	32.45
2	2390.00	42.3 AV	54.0	-11.7	1.20 H	360	9.85	32.45
3	*2437.00	116.6 PK			1.20 H	360	83.98	32.62
4	*2437.00	112.8 AV			1.20 H	360	80.18	32.62
5	2483.50	57.0 PK	74.0	-17.0	1.20 H	360	24.21	32.79
6	2483.50	43.8 AV	54.0	-10.2	1.20 H	360	11.01	32.79
7	4874.00	56.6 PK	74.0	-17.4	1.35 H	80	16.04	40.56
8	4874.00	53.3 AV	54.0	-0.7	1.35 H	80	12.74	40.56
9	7311.00	57.5 PK	74.0	-16.5	1.24 H	157	9.18	48.32
10	7311.00	45.5 AV	54.0	-8.5	1.24 H	157	-2.82	48.32

ANTENNA POLARITY & TEST DISTANCE: VERTICAL AT 3 M

NO.	FREQ. (MHz)	EMISSION LEVEL (dBuV/m)	LIMIT (dBuV/m)	MARGIN (dB)	ANTENNA HEIGHT (m)	TABLE ANGLE (Degree)	RAW VALUE (dBuV)	CORRECTION FACTOR (dB/m)
1	*2437.00	105.5 PK			1.21 V	124	72.88	32.62
2	*2437.00	100.8 AV			1.21 V	124	68.18	32.62
3	4874.00	56.4 PK	74.0	-17.6	1.38 V	76	15.84	40.56
4	4874.00	53.2 AV	54.0	-0.8	1.38 V	76	12.64	40.56
5	7311.00	59.6 PK	74.0	-14.4	1.09 V	156	11.28	48.32
6	7311.00	47.7 AV	54.0	-6.3	1.09 V	156	-0.62	48.32

REMARKS:

1. Emission Level(dBuV/m) = Raw Value(dBuV) + Correction Factor(dB/m)
2. Correction Factor(dB/m) = Antenna Factor(dB/m) + Cable Factor(dB) – Pre-Amplifier Factor(dB)
3. The other emission levels were very low against the limit.
4. Margin value = Emission Level – Limit value
5. " * ": Fundamental frequency.



A D T

CHANNEL	TX Channel 11	DETECTOR FUNCTION	Peak (PK)
FREQUENCY RANGE	1GHz ~ 25GHz		Average (AV)

ANTENNA POLARITY & TEST DISTANCE: HORIZONTAL AT 3 M

NO.	FREQ. (MHz)	EMISSION LEVEL (dBuV/m)	LIMIT (dBuV/m)	MARGIN (dB)	ANTENNA HEIGHT (m)	TABLE ANGLE (Degree)	RAW VALUE (dBuV)	CORRECTION FACTOR (dB/m)
1	*2462.00	113.3 PK			1.16 H	17	80.60	32.70
2	*2462.00	110.7 AV			1.16 H	17	78.00	32.70
3	2483.50	57.5 PK	74.0	-16.5	1.16 H	17	24.70	32.80
4	2483.50	45.8 AV	54.0	-8.2	1.16 H	17	13.00	32.80
5	4924.00	57.9 PK	74.0	-16.1	1.33 H	142	17.20	40.70
6	4924.00	53.4 AV	54.0	-0.6	1.33 H	142	12.70	40.70
7	7386.00	57.9 PK	74.0	-16.1	1.23 H	155	9.70	48.20
8	7386.00	47.7 AV	54.0	-6.3	1.23 H	155	-0.50	48.20

ANTENNA POLARITY & TEST DISTANCE: VERTICAL AT 3 M

NO.	FREQ. (MHz)	EMISSION LEVEL (dBuV/m)	LIMIT (dBuV/m)	MARGIN (dB)	ANTENNA HEIGHT (m)	TABLE ANGLE (Degree)	RAW VALUE (dBuV)	CORRECTION FACTOR (dB/m)
1	*2462.00	106.8 PK			1.18 V	332	74.09	32.71
2	*2462.00	102.1 AV			1.18 V	332	69.39	32.71
3	4924.00	54.9 PK	74.0	-19.1	1.00 V	83	14.24	40.66
4	4924.00	49.2 AV	54.0	-4.8	1.00 V	83	8.54	40.66
5	7386.00	58.1 PK	74.0	-15.9	1.03 V	77	9.86	48.24
6	7386.00	48.1 AV	54.0	-5.9	1.03 V	77	-0.14	48.24

REMARKS:

1. Emission Level(dBuV/m) = Raw Value(dBuV) + Correction Factor(dB/m)
2. Correction Factor(dB/m) = Antenna Factor(dB/m) + Cable Factor(dB) – Pre-Amplifier Factor(dB)
3. The other emission levels were very low against the limit.
4. Margin value = Emission Level – Limit value
5. " * ": Fundamental frequency.

802.11g

CHANNEL	TX Channel 1	DETECTOR FUNCTION	Peak (PK)
FREQUENCY RANGE	1GHz ~ 25GHz		Average (AV)

ANTENNA POLARITY & TEST DISTANCE: HORIZONTAL AT 3 M

NO.	FREQ. (MHz)	EMISSION LEVEL (dBuV/m)	LIMIT (dBuV/m)	MARGIN (dB)	ANTENNA HEIGHT (m)	TABLE ANGLE (Degree)	RAW VALUE (dBuV)	CORRECTION FACTOR (dB/m)
1	1100.00	47.8 PK	74.0	-26.2	1.18 H	106	20.85	26.95
2	1100.00	43.1 AV	54.0	-10.9	1.18 H	106	16.15	26.95
3	2390.00	54.2 PK	74.0	-19.8	1.00 H	308	21.75	32.45
4	2390.00	39.2 AV	54.0	-14.8	1.00 H	308	6.75	32.45
5	*2412.00	101.2 PK			1.00 H	308	68.67	32.53
6	*2412.00	90.8 AV			1.00 H	308	58.27	32.53
7	2487.00	48.8 PK	74.0	-25.2	1.00 H	329	16.00	32.80
8	2487.00	35.9 AV	54.0	-18.1	1.00 H	329	3.10	32.80
9	4824.00	58.9 PK	74.0	-15.1	1.00 H	58	18.46	40.44
10	4824.00	44.2 AV	54.0	-9.8	1.00 H	58	3.76	40.44

ANTENNA POLARITY & TEST DISTANCE: VERTICAL AT 3 M

NO.	FREQ. (MHz)	EMISSION LEVEL (dBuV/m)	LIMIT (dBuV/m)	MARGIN (dB)	ANTENNA HEIGHT (m)	TABLE ANGLE (Degree)	RAW VALUE (dBuV)	CORRECTION FACTOR (dB/m)
1	1100.00	40.2 PK	74.0	-33.8	1.00 V	21	13.25	26.95
2	1100.00	36.8 AV	54.0	-17.2	1.00 V	21	9.85	26.95
3	2390.00	73.1 PK	74.0	-0.9	1.17 V	208	40.65	32.45
4	2390.00	51.2 AV	54.0	-2.8	1.17 V	208	18.75	32.45
5	*2412.00	113.9 PK			1.17 V	208	81.37	32.53
6	*2412.00	103.6 AV			1.17 V	208	71.07	32.53
7	2487.00	55.7 PK	74.0	-18.3	1.13 V	216	22.90	32.80
8	2487.00	46.3 AV	54.0	-7.7	1.13 V	216	13.50	32.80
9	4824.00	51.7 PK	74.0	-22.3	1.02 V	83	11.26	40.44
10	4824.00	39.7 AV	54.0	-14.3	1.02 V	83	-0.74	40.44

REMARKS:

1. Emission Level(dBuV/m) = Raw Value(dBuV) + Correction Factor(dB/m)
2. Correction Factor(dB/m) = Antenna Factor(dB/m) + Cable Factor(dB) – Pre-Amplifier Factor(dB)
3. The other emission levels were very low against the limit.
4. Margin value = Emission Level – Limit value
5. " * ": Fundamental frequency.



A D T

CHANNEL	TX Channel 6	DETECTOR FUNCTION	Peak (PK)
FREQUENCY RANGE	1GHz ~ 25GHz		Average (AV)

ANTENNA POLARITY & TEST DISTANCE: HORIZONTAL AT 3 M

NO.	FREQ. (MHz)	EMISSION LEVEL (dBuV/m)	LIMIT (dBuV/m)	MARGIN (dB)	ANTENNA HEIGHT (m)	TABLE ANGLE (Degree)	RAW VALUE (dBuV)	CORRECTION FACTOR (dB/m)
1	2390.00	54.9 PK	74.0	-19.1	1.01 H	307	22.45	32.45
2	2390.00	39.1 AV	54.0	-14.9	1.01 H	307	6.65	32.45
3	*2437.00	110.5 PK			1.01 H	307	77.88	32.62
4	*2437.00	100.3 AV			1.01 H	307	67.68	32.62
5	2483.50	56.0 PK	74.0	-18.0	1.01 H	307	23.21	32.79
6	2483.50	42.0 AV	54.0	-12.0	1.01 H	307	9.21	32.79
7	4874.00	58.6 PK	74.0	-15.4	1.02 H	65	18.04	40.56
8	4874.00	43.7 AV	54.0	-10.3	1.02 H	65	3.14	40.56
9	7311.00	59.3 PK	74.0	-14.7	1.75 H	143	10.98	48.32
10	7311.00	46.2 AV	54.0	-7.8	1.75 H	143	-2.12	48.32

ANTENNA POLARITY & TEST DISTANCE: VERTICAL AT 3 M

NO.	FREQ. (MHz)	EMISSION LEVEL (dBuV/m)	LIMIT (dBuV/m)	MARGIN (dB)	ANTENNA HEIGHT (m)	TABLE ANGLE (Degree)	RAW VALUE (dBuV)	CORRECTION FACTOR (dB/m)
1	2390.00	66.3 PK	74.0	-7.7	1.16 V	215	33.85	32.45
2	2390.00	48.7 AV	54.0	-5.3	1.16 V	215	16.25	32.45
3	*2437.00	119.6 PK			1.16 V	215	86.98	32.62
4	*2437.00	109.1 AV			1.16 V	215	76.48	32.62
5	2483.50	64.3 PK	74.0	-9.7	1.16 V	214	31.51	32.79
6	2483.50	50.1 AV	54.0	-3.9	1.16 V	214	17.31	32.79
7	4874.00	60.1 PK	74.0	-13.9	1.00 V	84	19.54	40.56
8	4874.00	45.0 AV	54.0	-9.0	1.00 V	84	4.44	40.56
9	7311.00	63.7 PK	74.0	-10.3	1.04 V	76	15.38	48.32
10	7311.00	50.1 AV	54.0	-3.9	1.04 V	76	1.78	48.32

REMARKS:

1. Emission Level(dBuV/m) = Raw Value(dBuV) + Correction Factor(dB/m)
2. Correction Factor(dB/m) = Antenna Factor(dB/m) + Cable Factor(dB) – Pre-Amplifier Factor(dB)
3. The other emission levels were very low against the limit.
4. Margin value = Emission Level – Limit value
5. " * ": Fundamental frequency.



A D T

CHANNEL	TX Channel 11	DETECTOR FUNCTION	Peak (PK)
FREQUENCY RANGE	1GHz ~ 25GHz		Average (AV)

ANTENNA POLARITY & TEST DISTANCE: HORIZONTAL AT 3 M

NO.	FREQ. (MHz)	EMISSION LEVEL (dBuV/m)	LIMIT (dBuV/m)	MARGIN (dB)	ANTENNA HEIGHT (m)	TABLE ANGLE (Degree)	RAW VALUE (dBuV)	CORRECTION FACTOR (dB/m)
1	*2462.00	105.2 PK			1.01 H	308	72.49	32.71
2	*2462.00	94.6 AV			1.01 H	308	61.89	32.71
3	2483.50	64.4 PK	74.0	-9.6	1.01 H	308	31.61	32.79
4	2483.50	43.5 AV	54.0	-10.5	1.01 H	308	10.71	32.79
5	4924.00	59.0 PK	74.0	-15.0	1.00 H	64	18.34	40.66
6	4924.00	44.3 AV	54.0	-9.7	1.00 H	64	3.64	40.66
7	7386.00	59.6 PK	74.0	-14.4	1.78 H	146	11.36	48.24
8	7386.00	46.6 AV	54.0	-7.4	1.78 H	146	-1.64	48.24

ANTENNA POLARITY & TEST DISTANCE: VERTICAL AT 3 M

NO.	FREQ. (MHz)	EMISSION LEVEL (dBuV/m)	LIMIT (dBuV/m)	MARGIN (dB)	ANTENNA HEIGHT (m)	TABLE ANGLE (Degree)	RAW VALUE (dBuV)	CORRECTION FACTOR (dB/m)
1	*2462.00	114.3 PK			1.14 V	221	81.59	32.71
2	*2462.00	104.1 AV			1.14 V	221	71.39	32.71
3	2483.50	73.6 PK	74.0	-0.4	1.14 V	221	40.81	32.79
4	2483.50	53.1 AV	54.0	-0.9	1.14 V	221	20.31	32.79
5	4924.00	52.1 PK	74.0	-21.9	1.05 V	94	11.44	40.66
6	4924.00	39.9 AV	54.0	-14.1	1.05 V	94	-0.76	40.66
7	7386.00	63.8 PK	74.0	-10.2	1.00 V	70	15.56	48.24
8	7386.00	50.4 AV	54.0	-3.6	1.00 V	70	2.16	48.24

REMARKS:

1. Emission Level(dBuV/m) = Raw Value(dBuV) + Correction Factor(dB/m)
2. Correction Factor(dB/m) = Antenna Factor(dB/m) + Cable Factor(dB) – Pre-Amplifier Factor(dB)
3. The other emission levels were very low against the limit.
4. Margin value = Emission Level – Limit value
5. " * ": Fundamental frequency.



A D T

802.11n (HT20)

CHANNEL	TX Channel 1	DETECTOR FUNCTION	Peak (PK)
FREQUENCY RANGE	1GHz ~ 25GHz		Average (AV)

ANTENNA POLARITY & TEST DISTANCE: HORIZONTAL AT 3 M

NO.	FREQ. (MHz)	EMISSION LEVEL (dBuV/m)	LIMIT (dBuV/m)	MARGIN (dB)	ANTENNA HEIGHT (m)	TABLE ANGLE (Degree)	RAW VALUE (dBuV)	CORRECTION FACTOR (dB/m)
1	2390.00	70.5 PK	74.0	-3.5	1.19 H	19	38.05	32.45
2	2390.00	50.1 AV	54.0	-3.9	1.19 H	19	17.65	32.45
3	*2412.00	111.6 PK			1.19 H	19	79.07	32.53
4	*2412.00	100.8 AV			1.19 H	19	68.27	32.53
5	4824.00	52.3 PK	74.0	-21.7	1.49 H	125	11.86	40.44
6	4824.00	40.7 AV	54.0	-13.3	1.49 H	125	0.26	40.44

ANTENNA POLARITY & TEST DISTANCE: VERTICAL AT 3 M

NO.	FREQ. (MHz)	EMISSION LEVEL (dBuV/m)	LIMIT (dBuV/m)	MARGIN (dB)	ANTENNA HEIGHT (m)	TABLE ANGLE (Degree)	RAW VALUE (dBuV)	CORRECTION FACTOR (dB/m)
1	2390.00	73.2 PK	74.0	-0.8	1.07 V	219	40.75	32.45
2	2390.00	52.6 AV	54.0	-1.4	1.07 V	219	20.15	32.45
3	*2412.00	115.9 PK			1.07 V	219	83.37	32.53
4	*2412.00	104.7 AV			1.07 V	219	72.17	32.53
5	4824.00	53.9 PK	74.0	-20.1	1.03 V	100	13.46	40.44
6	4824.00	41.0 AV	54.0	-13.0	1.03 V	100	0.56	40.44

REMARKS:

1. Emission Level(dBuV/m) = Raw Value(dBuV) + Correction Factor(dB/m)
2. Correction Factor(dB/m) = Antenna Factor(dB/m) + Cable Factor(dB) – Pre-Amplifier Factor(dB)
3. The other emission levels were very low against the limit.
4. Margin value = Emission Level – Limit value
5. " * ": Fundamental frequency.



A D T

CHANNEL	TX Channel 6	DETECTOR FUNCTION	Peak (PK)
FREQUENCY RANGE	1GHz ~ 25GHz		Average (AV)

ANTENNA POLARITY & TEST DISTANCE: HORIZONTAL AT 3 M

NO.	FREQ. (MHz)	EMISSION LEVEL (dBuV/m)	LIMIT (dBuV/m)	MARGIN (dB)	ANTENNA HEIGHT (m)	TABLE ANGLE (Degree)	RAW VALUE (dBuV)	CORRECTION FACTOR (dB/m)
1	2390.00	67.5 PK	74.0	-6.5	1.19 H	360	35.05	32.45
2	2390.00	44.8 AV	54.0	-9.2	1.19 H	360	12.35	32.45
3	*2437.00	119.5 PK			1.19 H	360	86.88	32.62
4	*2437.00	108.3 AV			1.19 H	360	75.68	32.62
5	2483.50	66.3 PK	74.0	-7.7	1.19 H	360	33.51	32.79
6	2483.50	46.1 AV	54.0	-7.9	1.19 H	360	13.31	32.79
7	4874.00	53.5 PK	74.0	-20.5	1.00 H	144	12.94	40.56
8	4874.00	42.3 AV	54.0	-11.7	1.00 H	144	1.74	40.56
9	7311.00	58.6 PK	74.0	-15.4	1.06 H	152	10.28	48.32
10	7311.00	46.2 AV	54.0	-7.8	1.06 H	152	-2.12	48.32

ANTENNA POLARITY & TEST DISTANCE: VERTICAL AT 3 M

NO.	FREQ. (MHz)	EMISSION LEVEL (dBuV/m)	LIMIT (dBuV/m)	MARGIN (dB)	ANTENNA HEIGHT (m)	TABLE ANGLE (Degree)	RAW VALUE (dBuV)	CORRECTION FACTOR (dB/m)
1	2390.00	63.1 PK	74.0	-10.9	1.08 V	213	30.65	32.45
2	2390.00	45.3 AV	54.0	-8.7	1.08 V	213	12.85	32.45
3	*2437.00	120.3 PK			1.08 V	213	87.68	32.62
4	*2437.00	110.1 AV			1.08 V	213	77.48	32.62
5	2483.50	60.3 PK	74.0	-13.7	1.08 V	213	27.51	32.79
6	2483.50	46.1 AV	54.0	-7.9	1.08 V	213	13.31	32.79
7	4874.00	63.6 PK	74.0	-10.4	1.00 V	83	23.04	40.56
8	4874.00	45.9 AV	54.0	-8.1	1.00 V	83	5.34	40.56
9	7311.00	66.4 PK	74.0	-7.6	1.03 V	79	18.08	48.32
10	7311.00	53.5 AV	54.0	-0.5	1.03 V	79	5.18	48.32

REMARKS:

1. Emission Level(dBuV/m) = Raw Value(dBuV) + Correction Factor(dB/m)
2. Correction Factor(dB/m) = Antenna Factor(dB/m) + Cable Factor(dB) – Pre-Amplifier Factor(dB)
3. The other emission levels were very low against the limit.
4. Margin value = Emission Level – Limit value
5. " * ": Fundamental frequency.



A D T

CHANNEL	TX Channel 11	DETECTOR FUNCTION	Peak (PK)
FREQUENCY RANGE	1GHz ~ 25GHz		Average (AV)

ANTENNA POLARITY & TEST DISTANCE: HORIZONTAL AT 3 M

NO.	FREQ. (MHz)	EMISSION LEVEL (dBuV/m)	LIMIT (dBuV/m)	MARGIN (dB)	ANTENNA HEIGHT (m)	TABLE ANGLE (Degree)	RAW VALUE (dBuV)	CORRECTION FACTOR (dB/m)
1	*2462.00	115.2 PK			1.19 H	360	82.49	32.71
2	*2462.00	104.7 AV			1.19 H	360	71.99	32.71
3	2483.50	73.0 PK	74.0	-1.0	1.19 H	360	40.21	32.79
4	2483.50	53.0 AV	54.0	-1.0	1.19 H	360	20.21	32.79
5	4924.00	52.5 PK	74.0	-21.5	1.48 H	137	11.84	40.66
6	4924.00	41.0 AV	54.0	-13.0	1.48 H	137	0.34	40.66
7	7386.00	59.1 PK	74.0	-14.9	1.09 H	158	10.86	48.24
8	7386.00	46.6 AV	54.0	-7.4	1.09 H	158	-1.64	48.24

ANTENNA POLARITY & TEST DISTANCE: VERTICAL AT 3 M

NO.	FREQ. (MHz)	EMISSION LEVEL (dBuV/m)	LIMIT (dBuV/m)	MARGIN (dB)	ANTENNA HEIGHT (m)	TABLE ANGLE (Degree)	RAW VALUE (dBuV)	CORRECTION FACTOR (dB/m)
1	*2462.00	116.3 PK			1.06 V	217	83.59	32.71
2	*2462.00	105.2 AV			1.06 V	217	72.49	32.71
3	2483.50	73.2 PK	74.0	-0.8	1.06 V	217	40.41	32.79
4	2483.50	52.1 AV	54.0	-1.9	1.06 V	217	19.31	32.79
5	4924.00	53.8 PK	74.0	-20.2	1.00 V	94	13.14	40.66
6	4924.00	41.0 AV	54.0	-13.0	1.00 V	94	0.34	40.66
7	7386.00	66.5 PK	74.0	-7.5	1.00 V	73	18.26	48.24
8	7386.00	53.5 AV	54.0	-0.5	1.00 V	73	5.26	48.24

REMARKS:

1. Emission Level(dBuV/m) = Raw Value(dBuV) + Correction Factor(dB/m)
2. Correction Factor(dB/m) = Antenna Factor(dB/m) + Cable Factor(dB) – Pre-Amplifier Factor(dB)
3. The other emission levels were very low against the limit.
4. Margin value = Emission Level – Limit value
5. " * ": Fundamental frequency.



A D T

802.11n (HT40)

CHANNEL	TX Channel 3	DETECTOR FUNCTION	Peak (PK)
FREQUENCY RANGE	1GHz ~ 25GHz		Average (AV)

ANTENNA POLARITY & TEST DISTANCE: HORIZONTAL AT 3 M

NO.	FREQ. (MHz)	EMISSION LEVEL (dBuV/m)	LIMIT (dBuV/m)	MARGIN (dB)	ANTENNA HEIGHT (m)	TABLE ANGLE (Degree)	RAW VALUE (dBuV)	CORRECTION FACTOR (dB/m)
1	2390.00	70.2 PK	74.0	-3.8	1.11 H	226	37.75	32.45
2	2390.00	53.0 AV	54.0	-1.0	1.11 H	226	20.55	32.45
3	*2422.00	114.7 PK			1.11 H	226	82.13	32.57
4	*2422.00	103.2 AV			1.11 H	226	70.63	32.57
5	4844.00	52.0 PK	74.0	-22.0	1.61 H	132	11.52	40.48
6	4844.00	38.7 AV	54.0	-15.3	1.61 H	132	-1.78	40.48
7	7266.00	58.3 PK	74.0	-15.7	1.00 H	0	9.95	48.35
8	7266.00	45.7 AV	54.0	-8.3	1.00 H	0	-2.65	48.35

ANTENNA POLARITY & TEST DISTANCE: VERTICAL AT 3 M

NO.	FREQ. (MHz)	EMISSION LEVEL (dBuV/m)	LIMIT (dBuV/m)	MARGIN (dB)	ANTENNA HEIGHT (m)	TABLE ANGLE (Degree)	RAW VALUE (dBuV)	CORRECTION FACTOR (dB/m)
1	2390.00	70.4 PK	74.0	-3.6	1.09 V	219	37.95	32.45
2	2390.00	53.4 AV	54.0	-0.6	1.09 V	219	20.95	32.45
3	*2422.00	112.4 PK			1.09 V	219	79.83	32.57
4	*2422.00	100.4 AV			1.09 V	219	67.83	32.57
5	4844.00	50.5 PK	74.0	-23.5	1.06 V	186	10.02	40.48
6	4844.00	37.5 AV	54.0	-16.5	1.06 V	186	-2.98	40.48
7	7266.00	59.0 PK	74.0	-15.0	1.00 V	0	10.65	48.35
8	7266.00	45.7 AV	54.0	-8.3	1.00 V	0	-2.65	48.35

REMARKS:

1. Emission Level(dBuV/m) = Raw Value(dBuV) + Correction Factor(dB/m)
2. Correction Factor(dB/m) = Antenna Factor(dB/m) + Cable Factor(dB) – Pre-Amplifier Factor(dB)
3. The other emission levels were very low against the limit.
4. Margin value = Emission Level – Limit value
5. " * ": Fundamental frequency.



A D T

CHANNEL	TX Channel 6	DETECTOR FUNCTION	Peak (PK)
FREQUENCY RANGE	1GHz ~ 25GHz		Average (AV)

ANTENNA POLARITY & TEST DISTANCE: HORIZONTAL AT 3 M

NO.	FREQ. (MHz)	EMISSION LEVEL (dBuV/m)	LIMIT (dBuV/m)	MARGIN (dB)	ANTENNA HEIGHT (m)	TABLE ANGLE (Degree)	RAW VALUE (dBuV)	CORRECTION FACTOR (dB/m)
1	2390.00	63.7 PK	74.0	-10.3	1.27 H	32	31.25	32.45
2	2390.00	42.8 AV	54.0	-11.2	1.27 H	32	10.35	32.45
3	*2437.00	111.2 PK			1.27 H	32	78.58	32.62
4	*2437.00	97.3 AV			1.27 H	32	64.68	32.62
5	2483.50	66.4 PK	74.0	-7.6	1.27 H	32	33.61	32.79
6	2483.50	45.8 AV	54.0	-8.2	1.27 H	32	13.01	32.79
7	4874.00	51.4 PK	74.0	-22.6	1.59 H	126	10.84	40.56
8	4874.00	38.2 AV	54.0	-15.8	1.59 H	126	-2.36	40.56
9	7311.00	58.1 PK	74.0	-15.9	1.00 H	4	9.78	48.32
10	7311.00	45.7 AV	54.0	-8.3	1.00 H	4	-2.62	48.32

ANTENNA POLARITY & TEST DISTANCE: VERTICAL AT 3 M

NO.	FREQ. (MHz)	EMISSION LEVEL (dBuV/m)	LIMIT (dBuV/m)	MARGIN (dB)	ANTENNA HEIGHT (m)	TABLE ANGLE (Degree)	RAW VALUE (dBuV)	CORRECTION FACTOR (dB/m)
1	2390.00	66.1 PK	74.0	-7.9	1.09 V	220	33.65	32.45
2	2390.00	47.9 AV	54.0	-6.1	1.09 V	220	15.45	32.45
3	*2437.00	114.8 PK			1.09 V	220	82.18	32.62
4	*2437.00	102.5 AV			1.09 V	220	69.88	32.62
5	2483.50	73.5 PK	74.0	-0.5	1.09 V	220	40.71	32.79
6	2483.50	51.3 AV	54.0	-2.7	1.09 V	220	18.51	32.79
7	4874.00	51.5 PK	74.0	-22.5	1.57 V	84	10.94	40.56
8	4874.00	38.8 AV	54.0	-15.2	1.57 V	84	-1.76	40.56
9	7311.00	58.8 PK	74.0	-15.2	1.00 V	0	10.48	48.32
10	7311.00	45.8 AV	54.0	-8.2	1.00 V	0	-2.52	48.32

REMARKS:

1. Emission Level(dBuV/m) = Raw Value(dBuV) + Correction Factor(dB/m)
2. Correction Factor(dB/m) = Antenna Factor(dB/m) + Cable Factor(dB) – Pre-Amplifier Factor(dB)
3. The other emission levels were very low against the limit.
4. Margin value = Emission Level – Limit value
5. " * ": Fundamental frequency.



A D T

CHANNEL	TX Channel 9	DETECTOR FUNCTION	Peak (PK)
FREQUENCY RANGE	1GHz ~ 25GHz		Average (AV)

ANTENNA POLARITY & TEST DISTANCE: HORIZONTAL AT 3 M

NO.	FREQ. (MHz)	EMISSION LEVEL (dBuV/m)	LIMIT (dBuV/m)	MARGIN (dB)	ANTENNA HEIGHT (m)	TABLE ANGLE (Degree)	RAW VALUE (dBuV)	CORRECTION FACTOR (dB/m)
1	*2452.00	107.1 PK			1.25 H	33	74.42	32.68
2	*2452.00	93.9 AV			1.25 H	33	61.22	32.68
3	2483.50	67.4 PK	74.0	-6.6	1.25 H	33	34.61	32.79
4	2483.50	49.7 AV	54.0	-4.3	1.25 H	33	16.91	32.79
5	4904.00	51.7 PK	74.0	-22.3	1.61 H	122	11.07	40.63
6	4904.00	38.3 AV	54.0	-15.7	1.61 H	122	-2.33	40.63
7	7356.00	58.7 PK	74.0	-15.3	1.00 H	0	10.43	48.27
8	7356.00	46.0 AV	54.0	-8.0	1.00 H	0	-2.27	48.27

ANTENNA POLARITY & TEST DISTANCE: VERTICAL AT 3 M

NO.	FREQ. (MHz)	EMISSION LEVEL (dBuV/m)	LIMIT (dBuV/m)	MARGIN (dB)	ANTENNA HEIGHT (m)	TABLE ANGLE (Degree)	RAW VALUE (dBuV)	CORRECTION FACTOR (dB/m)
1	*2452.00	111.4 PK			1.05 V	241	78.72	32.68
2	*2452.00	99.8 AV			1.05 V	241	67.12	32.68
3	2483.50	69.7 PK	74.0	-4.3	1.05 V	241	36.91	32.79
4	2483.50	53.3 AV	54.0	-0.7	1.05 V	241	20.51	32.79
5	4904.00	51.2 PK	74.0	-22.8	1.57 V	75	10.57	40.63
6	4904.00	38.6 AV	54.0	-15.4	1.57 V	75	-2.03	40.63
7	7356.00	58.5 PK	74.0	-15.5	1.00 V	0	10.23	48.27
8	7356.00	45.5 AV	54.0	-8.5	1.00 V	0	-2.77	48.27

REMARKS:

1. Emission Level(dBuV/m) = Raw Value(dBuV) + Correction Factor(dB/m)
2. Correction Factor(dB/m) = Antenna Factor(dB/m) + Cable Factor(dB) – Pre-Amplifier Factor(dB)
3. The other emission levels were very low against the limit.
4. Margin value = Emission Level – Limit value
5. " * ": Fundamental frequency.

4.3 6dB BANDWIDTH MEASUREMENT

4.3.1 LIMITS OF 6dB BANDWIDTH MEASUREMENT

The minimum of 6dB Bandwidth Measurement is 0.5 MHz.

4.3.2 TEST INSTRUMENTS

DESCRIPTION & MANUFACTURER	MODEL NO.	SERIAL NO.	CALIBRATED DATE	CALIBRATED UNTIL
Spectrum Analyzer R&S	FSP40	100036	Jan. 21, 2013	Jan. 20, 2014

Note:

1. The calibration interval of the above test instruments is 12 months and the calibrations are traceable to NML/ROC and NIST/USA.
2. Tested date : Jan. 02, 2014

4.3.3 TEST PROCEDURE

1. Set resolution bandwidth (RBW) = 100kHz
2. Set the video bandwidth (VBW) $\geq 3 \times$ RBW, Detector = Peak.
3. Trace mode = max hold.
4. Sweep = auto couple.
5. Measure the maximum width of the emission that is constrained by the frequencies associated with the two amplitude points (upper and lower) that are attenuated by 6 dB relative to the maximum level measured in the fundamental emission

4.3.4 DEVIATION FROM TEST STANDARD

No deviation

4.3.5 TEST SETUP

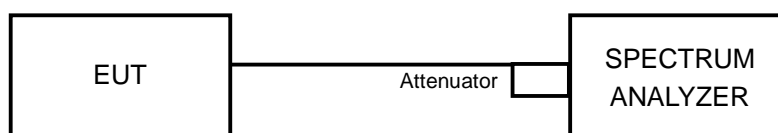

4.3.6 EUT OPERATING CONDITIONS

The software provided by client to enable the EUT under transmission condition continuously at lowest, middle and highest channel frequencies individually.



A D T

4.3.7 TEST RESULTS

802.11b

CHANNEL	CHANNEL FREQUENCY (MHz)	6dB BANDWIDTH (MHz)	MINIMUM LIMIT (MHz)	PASS / FAIL
1	2412	8.51	0.5	PASS
6	2437	7.94	0.5	PASS
11	2462	8.77	0.5	PASS

802.11g

CHANNEL	CHANNEL FREQUENCY (MHz)	6dB BANDWIDTH (MHz)	MINIMUM LIMIT (MHz)	PASS / FAIL
1	2412	16.37	0.5	PASS
6	2437	16.43	0.5	PASS
11	2462	16.38	0.5	PASS

802.11n (HT20)

CHANNEL	CHANNEL FREQUENCY (MHz)	6dB BANDWIDTH (MHz)			MINIMUM LIMIT (MHz)	PASS / FAIL
		CHAIN 0	CHAIN 1	CHAIN 2		
1	2412	17.72	17.68	17.71	0.5	PASS
6	2437	17.66	17.69	17.64	0.5	PASS
11	2462	17.67	17.64	17.65	0.5	PASS

802.11n (HT40)

CHANNEL	CHANNEL FREQUENCY (MHz)	6dB BANDWIDTH (MHz)			MINIMUM LIMIT (MHz)	PASS / FAIL
		CHAIN 0	CHAIN 1	CHAIN 2		
3	2422	36.40	36.03	36.13	0.5	PASS
6	2437	36.22	36.51	36.51	0.5	PASS
9	2452	36.24	36.47	36.13	0.5	PASS



A D T

SPECTRUM PLOT OF WORST VALUE

802.11b / CH6

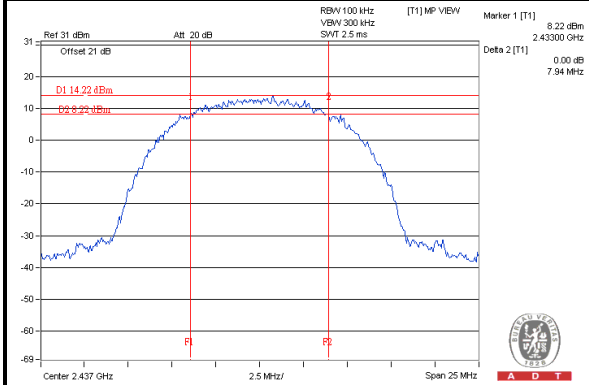

802.11g / CH1

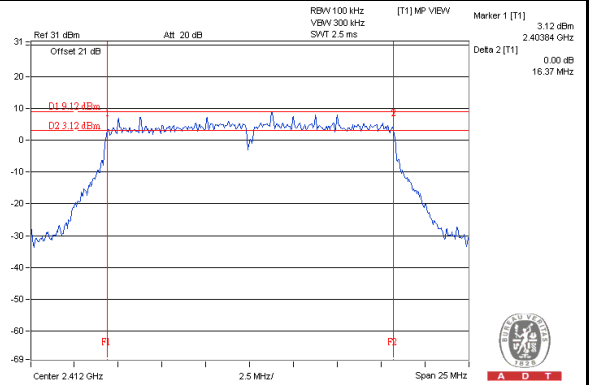

802.11n (HT20)_Chain 1 / CH11

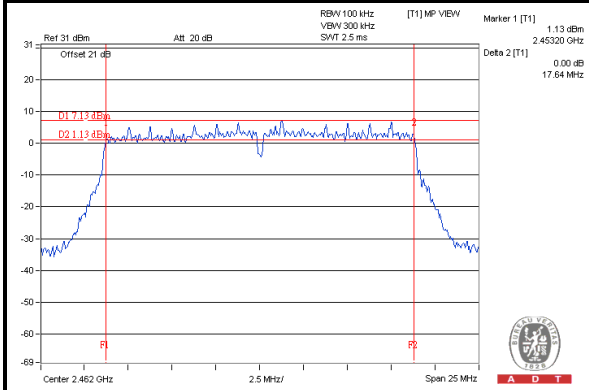

802.11n (HT40)_Chain 1 / CH3

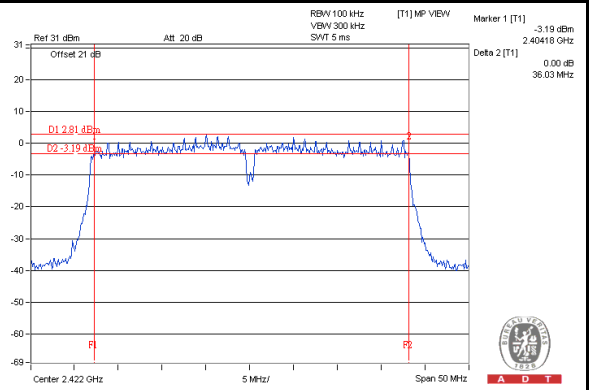



A D T

4.4 CONDUCTED OUTPUT POWER MEASUREMENT

4.4.1 LIMITS OF MAXIMUM OUTPUT POWER MEASUREMENT

For systems using digital modulation in the 2400–2483.5 MHz bands: 1 Watt (30dBm)

Per KDB 662911 D01 Multiple Transmitter Output v01r02 Method of conducted output power measurement on IEEE 802.11 devices,

Array Gain = 0 dB (i.e., no array gain) for $NANT \leq 4$;

Array Gain = 0 dB (i.e., no array gain) for channel widths ≥ 40 MHz for any NANT;

Array Gain = $5 \log(NANT/NSS)$ dB or 3 dB, whichever is less for 20-MHz channel widths with $NANT \geq 5$.

For power measurements on all other devices: Array Gain = $10 \log(NANT/NSS)$ dB.

4.4.2 INSTRUMENTS

DESCRIPTION & MANUFACTURER	MODEL NO.	SERIAL NO.	CALIBRATED DATE	CALIBRATED UNTIL
Power meter Anritsu	ML2495A	0824006	May 20, 2013	May 19, 2014
Power sensor Anritsu	MA2411B	0738172	May 20, 2013	May 19, 2014

Note:

1. The calibration interval of the above test instruments is 12 months and the calibrations are traceable to NML/ROC and NIST/USA.
2. Tested date : Jan. 02, 2014

4.4.3 TEST PROCEDURES

Method PM is used to perform output power measurement, trigger and gating function of wide band power meter is enabled to measure max output power of TX on burst. Duty factor is not added to measured value.

4.4.4 DEVIATION FROM TEST STANDARD

No deviation.



A D T

4.4.5 TEST SETUP

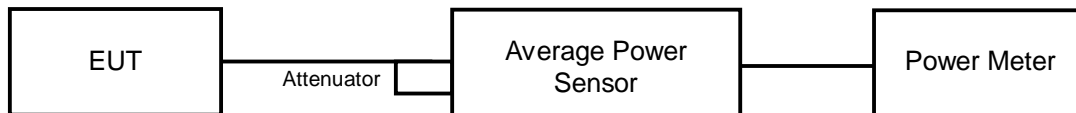

4.4.6 EUT OPERATING CONDITIONS

Same as Item 4.3.6



A D T

4.4.7 TEST RESULTS

802.11b

CHANNEL	FREQUENCY (MHz)	AVERAGE POWER (mW)	AVERAGE POWER (dBm)	LIMIT (dBm)	PASS/FAIL
1	2412	154.170	21.88	30	PASS
6	2437	184.077	22.65	30	PASS
11	2462	218.273	23.39	30	PASS

802.11g

CHANNEL	FREQUENCY (MHz)	AVERAGE POWER (mW)	AVERAGE POWER (dBm)	LIMIT (dBm)	PASS/FAIL
1	2412	108.143	20.34	30	PASS
6	2437	412.098	26.15	30	PASS
11	2462	101.859	20.08	30	PASS

802.11n (HT20)

CHANNEL	FREQUENCY (MHz)	AVERAGE POWER (dBm)			TOTAL POWER (mW)	TOTAL POWER (dBm)	LIMIT (dBm)	PASS / FAIL
		CHAIN 0	CHAIN 1	CHAIN 2				
1	2412	18.74	18.72	18.82	225.498	23.53	30	PASS
6	2437	23.73	23.76	23.65	705.471	28.48	30	PASS
11	2462	18.86	18.61	18.65	222.806	23.48	30	PASS

802.11n (HT40)

CHANNEL	FREQUENCY (MHz)	AVERAGE POWER (dBm)			TOTAL POWER (mW)	TOTAL POWER (dBm)	LIMIT (dBm)	PASS / FAIL
		CHAIN 0	CHAIN 1	CHAIN 2				
3	2422	16.79	16.76	16.72	142.166	21.53	30	PASS
6	2437	19.42	19.62	19.25	263.260	24.20	30	PASS
9	2452	15.46	15.73	15.54	108.377	20.35	30	PASS

4.5 POWER SPECTRAL DENSITY MEASUREMENT

4.5.1 LIMITS OF POWER SPECTRAL DENSITY MEASUREMENT

The Maximum of Power Spectral Density Measurement is 8dBm.

4.5.2 TEST INSTRUMENTS

DESCRIPTION & MANUFACTURER	MODEL NO.	SERIAL NO.	CALIBRATED DATE	CALIBRATED UNTIL
Spectrum Analyzer R&S	FSP 40	100036	Jan. 21, 2013	Jan. 20, 2014

Note:

1. The calibration interval of the above test instruments is 12 months and the calibrations are traceable to NML/ROC and NIST/USA.
2. Tested date : Jan. 02, 2014

4.5.3 TEST PROCEDURE

1. Set the RBW = 30 kHz, VBW =100 kHz, Detector = power averaging (RMS).
2. Ensure that the number of measurement points in the sweep $\geq 2 \times$ span/RBW
3. Sweep time = auto couple,
4. Employ trace averaging (RMS) mode over a minimum of 100 traces.
5. Use the peak marker function to determine the maximum amplitude level.

4.5.4 DEVIATION FROM TEST STANDARD

No deviation

4.5.5 TEST SETUP

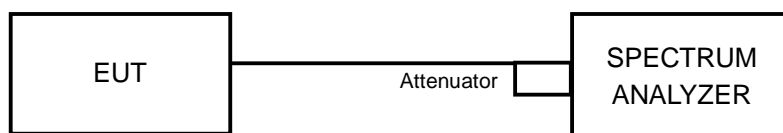

4.5.6 EUT OPERATING CONDITION

Same as Item 4.3.6



A D T

4.5.7 TEST RESULTS

802.11b

CHANNEL	FREQUENCY (MHz)	PSD (dBm)	LIMIT (dBm)	PASS /FAIL
1	2412	-7.32	8	PASS
6	2437	-6.19	8	PASS
11	2462	-5.95	8	PASS

802.11g

CHANNEL	FREQUENCY (MHz)	PSD (dBm)	LIMIT (dBm)	PASS /FAIL
1	2412	-10.14	8	PASS
6	2437	-5.15	8	PASS
11	2462	-10.64	8	PASS

802.11n (HT20)

TX CHAIN	CHANNEL	FREQUENCY (MHz)	PSD (dBm)	10 log (N=3) dB	TOTAL PSD (dBm)	LIMIT (dBm)	PASS /FAIL
0	1	2412	-12.26	4.77	-7.49	4.43	PASS
	6	2437	-8.06	4.77	-3.29	4.43	PASS
	11	2462	-13.20	4.77	-8.43	4.43	PASS
1	1	2412	-12.92	4.77	-8.15	4.43	PASS
	6	2437	-8.23	4.77	-3.46	4.43	PASS
	11	2462	-13.30	4.77	-8.53	4.43	PASS
2	1	2412	-13.05	4.77	-8.28	4.43	PASS
	6	2437	-8.60	4.77	-3.83	4.43	PASS
	11	2462	-13.07	4.77	-8.30	4.43	PASS

NOTE: 1. Directional gain = $10 \log[(10^{G1/20} + 10^{G2/20} + 10^{G3/20})^2 / 3] = 9.57\text{dBi} > 6\text{dBi}$, so the power density limit shall be reduced to $8 - (9.57 - 6) = 4.43\text{dBm}$.



A D T

802.11n (HT40)

TX CHAIN	CHANNEL	FREQ. (MHz)	PSD W/O DUTY FACTOR (dBm)	10 log (N=3) dB	DUTY FACTOR (dB)	TOTAL PSD WITH DUTY FACTOR (dBm)	LIMIT (dBm)	PASS /FAIL
0	3	2422	-18.06	4.77	0.1	-13.19	4.43	PASS
	6	2437	-15.65	4.77	0.1	-10.78	4.43	PASS
	9	2452	-19.63	4.77	0.1	-14.76	4.43	PASS
1	3	2422	-18.08	4.77	0.1	-13.21	4.43	PASS
	6	2437	-16.21	4.77	0.1	-11.34	4.43	PASS
	9	2452	-19.08	4.77	0.1	-14.21	4.43	PASS
2	3	2422	-18.30	4.77	0.1	-13.43	4.43	PASS
	6	2437	-16.28	4.77	0.1	-11.41	4.43	PASS
	9	2452	-18.81	4.77	0.1	-13.94	4.43	PASS

NOTE: 1. Directional gain = $10 \log[(10^{G1/20} + 10^{G2/20} + 10^{G3/20})^2 / 3] = 9.57\text{dBi} > 6\text{dBi}$, so the power density limit shall be reduced to $8-(9.57-6) = 4.43\text{dBm}$.
 2. Refer to section 3.4 for duty cycle spectrum plot.



A D T

SPECTRUM PLOT OF WORST VALUE

802.11b / CH11

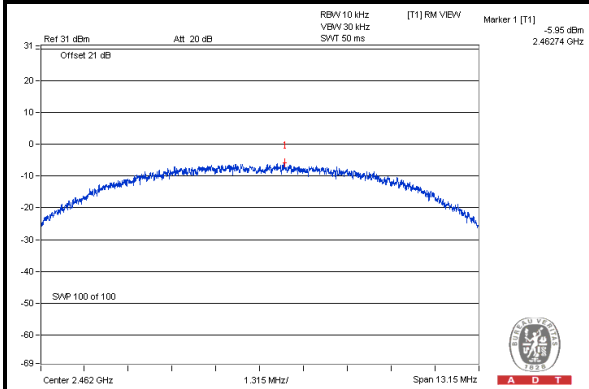

802.11g / CH6

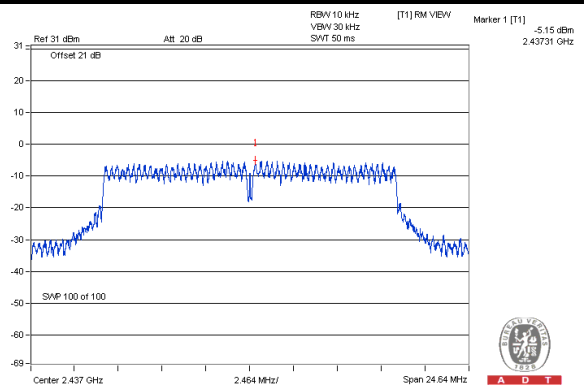

802.11n (HT20) Chain 0 / CH6

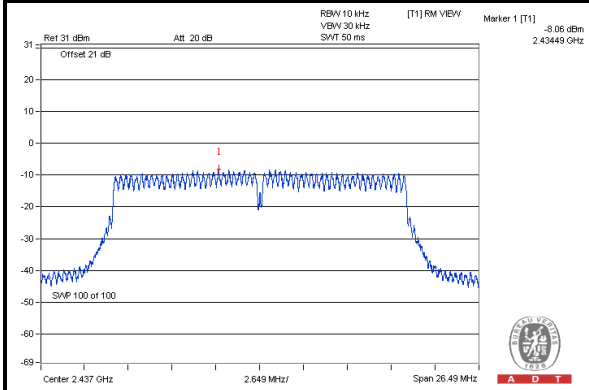

802.11n (HT40) Chain 0 / CH6

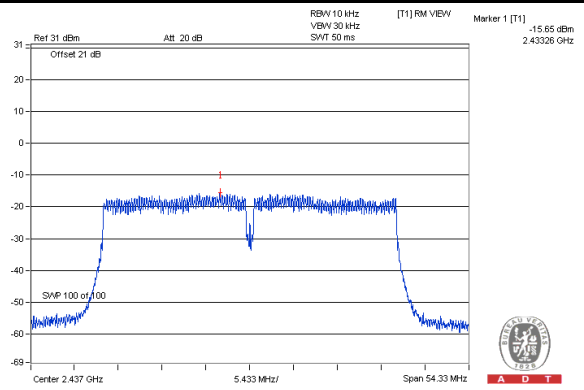

4.6 CONDUCTED OUT-BAND EMISSION MEASUREMENT

4.6.1 LIMITS OF CONDUCTED OUT-BAND EMISSION MEASUREMENT

Below 30dB of the highest emission level of operating band (in 100kHz Resolution Bandwidth).

4.6.2 TEST INSTRUMENTS

DESCRIPTION & MANUFACTURER	MODEL NO.	SERIAL NO.	CALIBRATED DATE	CALIBRATED UNTIL
Spectrum Analyzer R&S	FSP 40	100036	Jan. 21, 2013	Jan. 20, 2014

Note:

1. The calibration interval of the above test instruments is 12 months and the calibrations are traceable to NML/ROC and NIST/USA.
2. Tested date : Jan. 02, 2014

4.6.3 TEST PROCEDURE

Measurement Procedure - Reference Level

1. Set the RBW = 100 kHz.
2. Set the VBW \geq 300 kHz.
3. Detector = peak.
4. Sweep time = auto couple.
5. Trace mode = max hold.
6. Allow trace to fully stabilize.
7. Use the peak marker function to determine the maximum power level in any 100 kHz band segment within the fundamental EBW.

Measurement Procedure –Unwanted Emission Level

1. Set RBW = 100 kHz.
2. Set VBW \geq 300 kHz.
3. Set span to encompass the spectrum to be examined
4. Detector = peak.
5. Trace Mode = max hold.
6. Sweep = auto couple.

4.6.4 DEVIATION FROM TEST STANDARD

No deviation

4.6.5 TEST SETUP

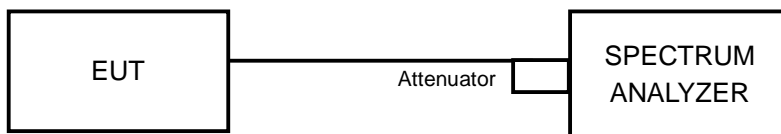

4.6.6 EUT OPERATING CONDITION

Same as Item 4.3.6

4.6.7 TEST RESULTS

The spectrum plots are attached on the following pages. D1 line indicates the highest level, and D2 line indicates the 30dB offset below D1. It shows compliance with the requirement.



A D T

802.11b:

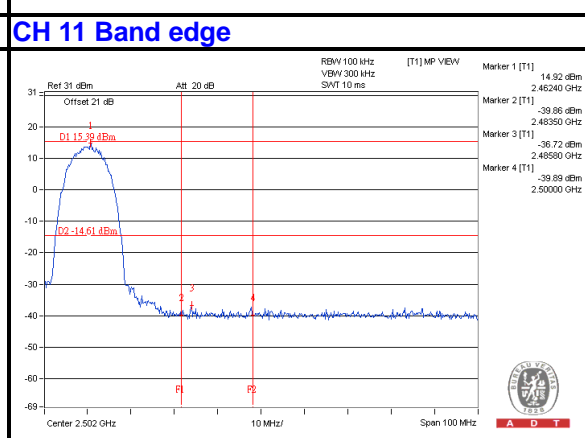
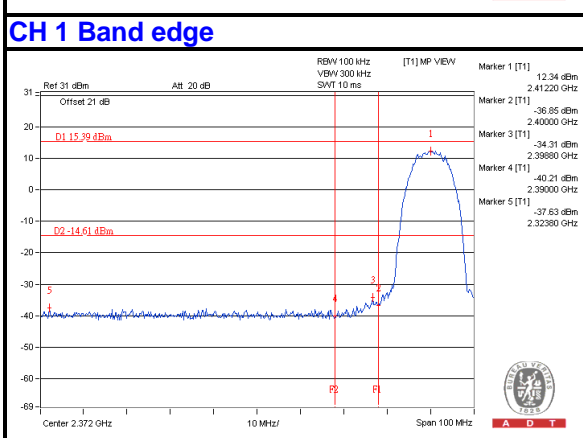
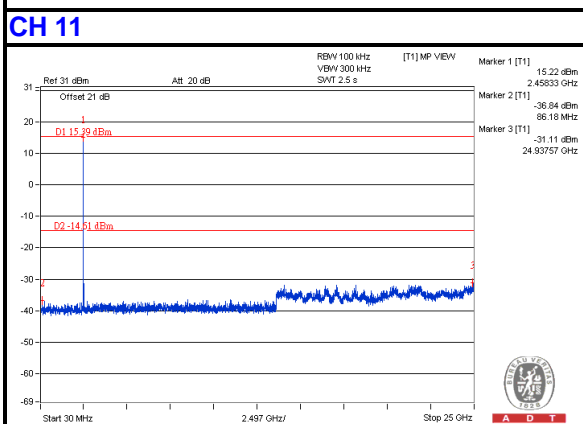
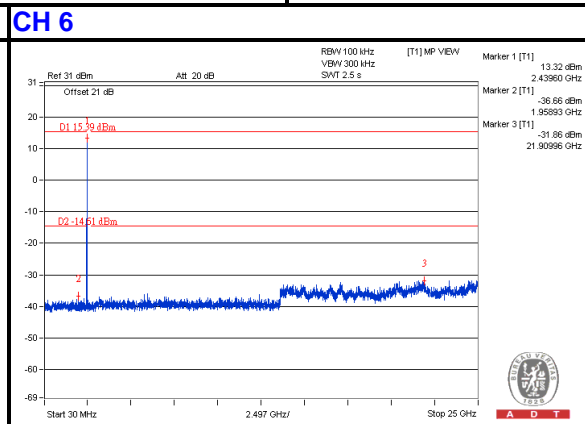
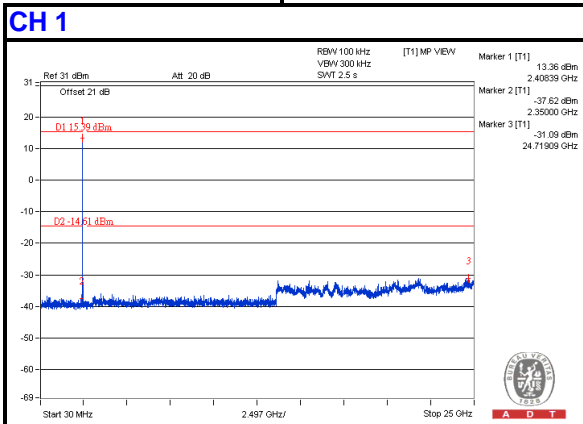
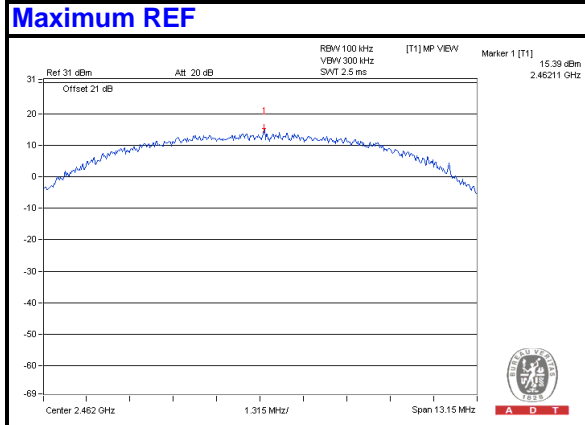



A D T

802.11g:

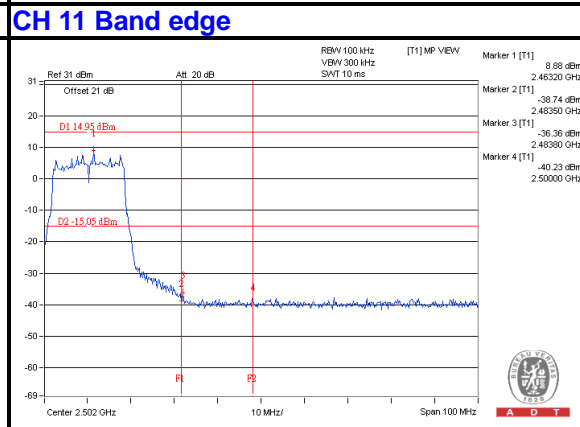
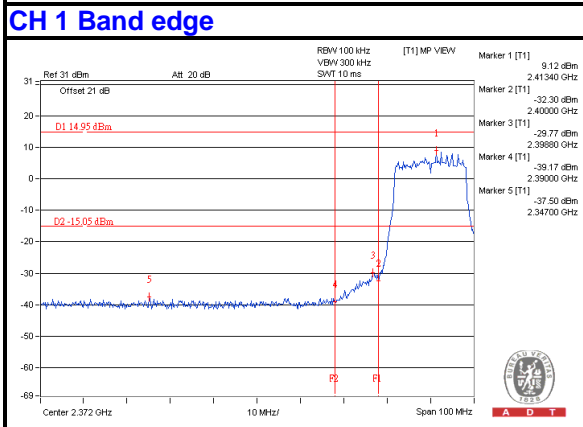
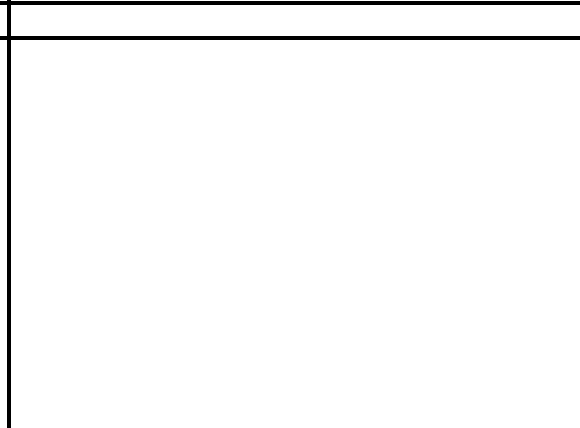
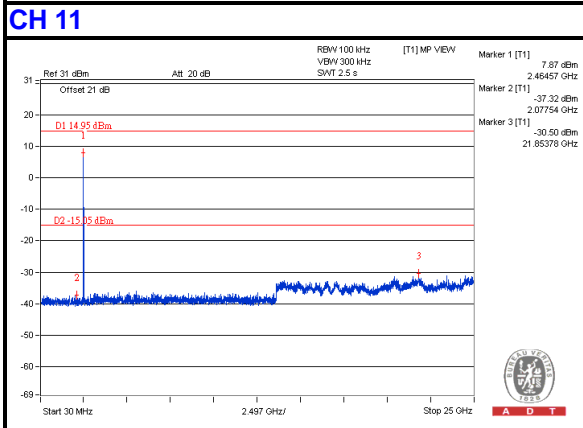
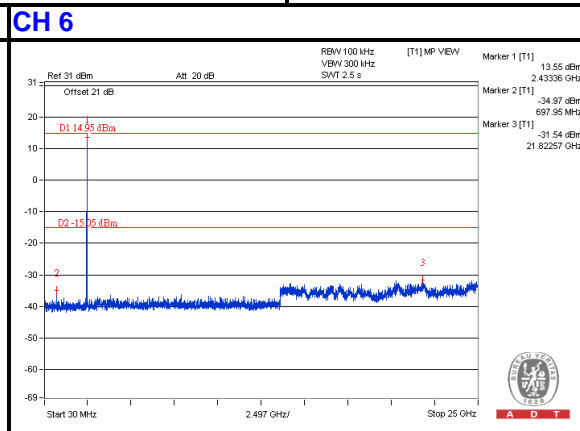
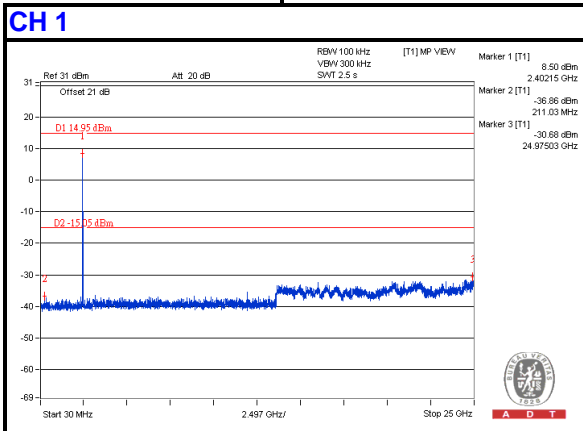
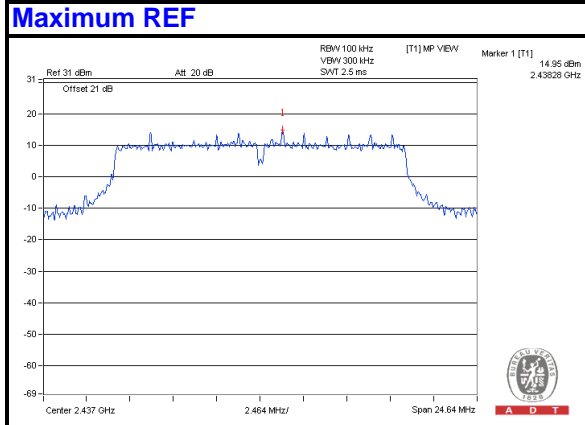



A D T

802.11n (HT20):

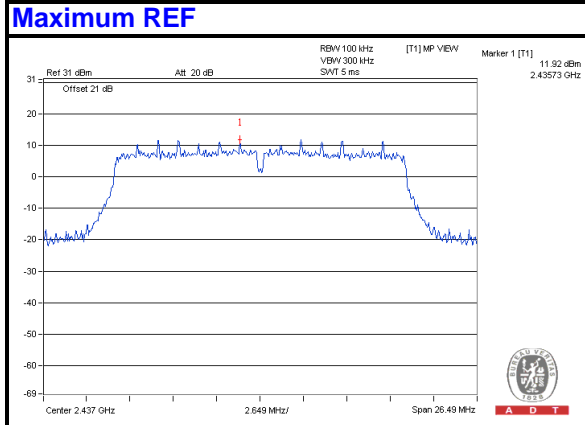

Chain(0)

CH 1

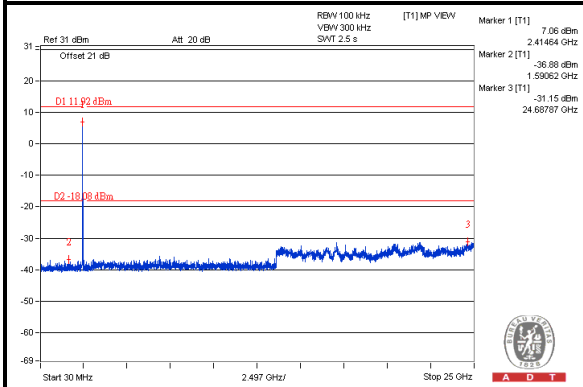

CH 6

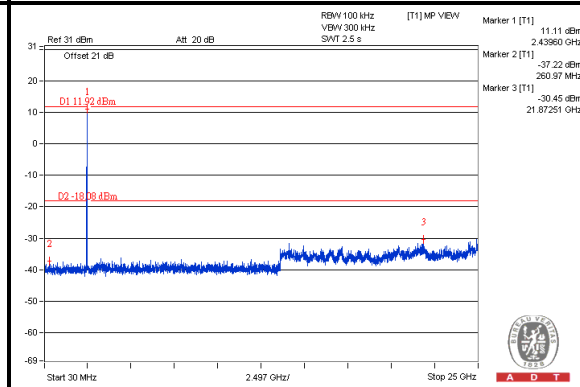

CH 11

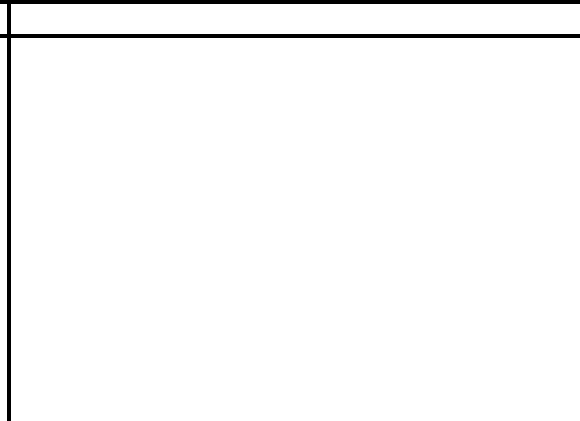
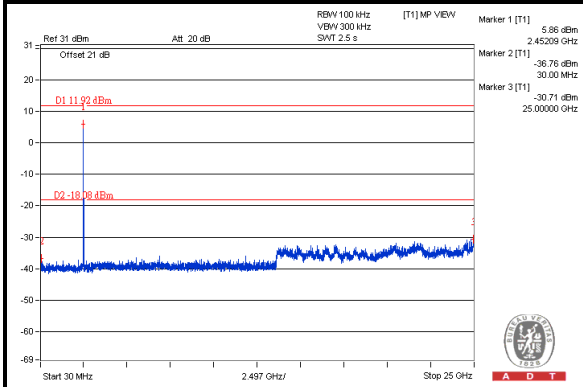

CH 1 Band edge

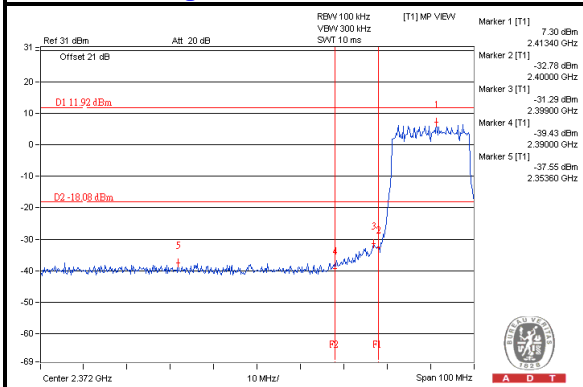

CH 11 Band edge

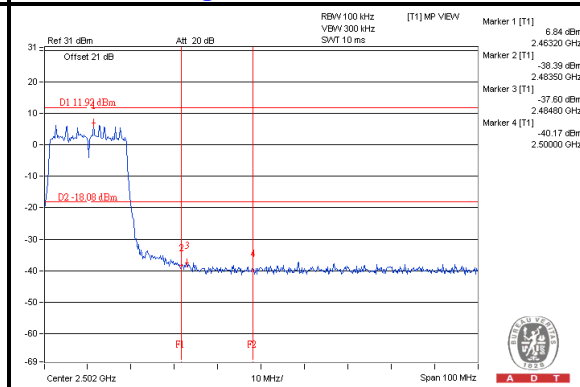



A D T

Chain(1)

CH 1

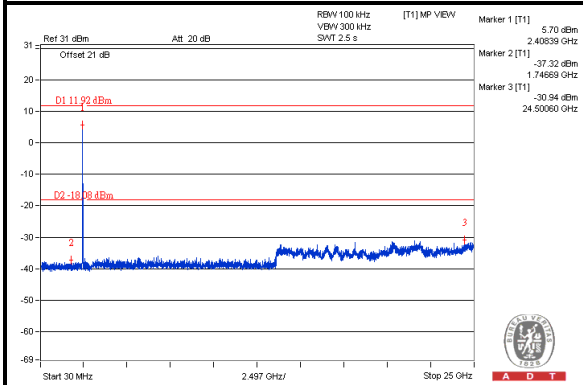

CH 6

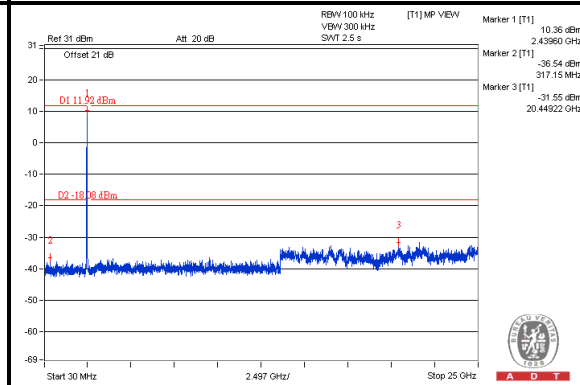

CH 11

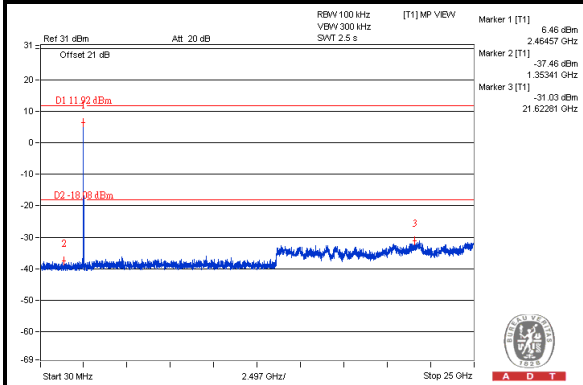

CH 1 Band edge

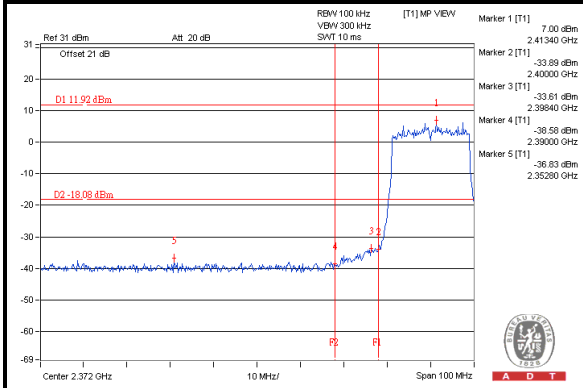

CH 11 Band edge

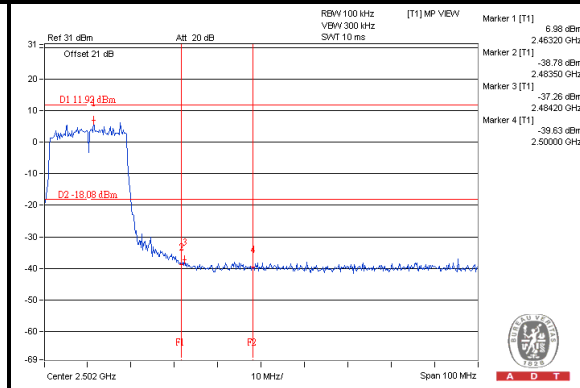



A D T

Chain(2)

CH 1

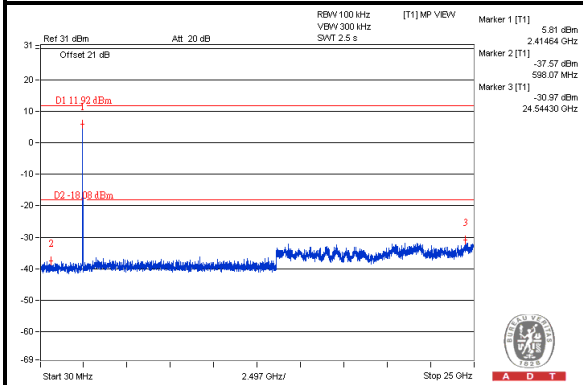

CH 6

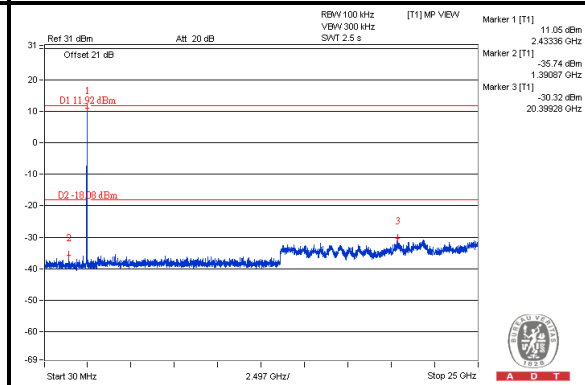

CH 11

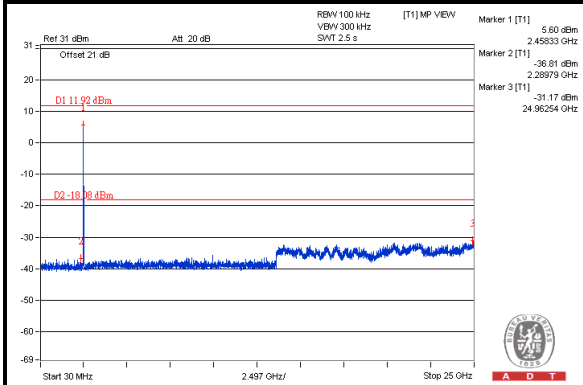

CH 1 Band edge

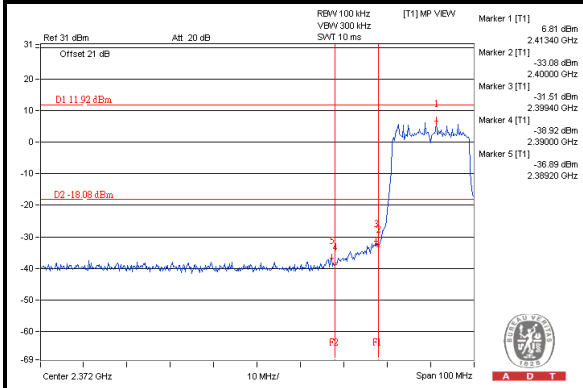

CH 11 Band edge

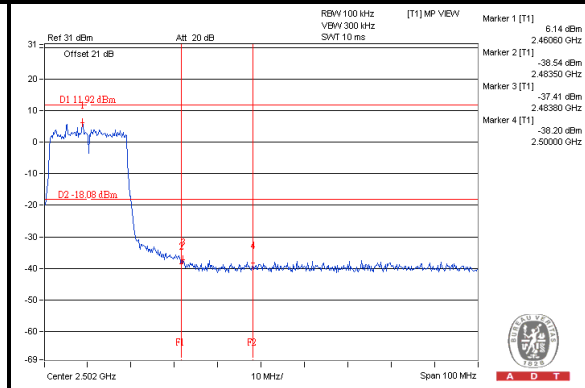



A D T

802.11n (HT40):

Maximum REF

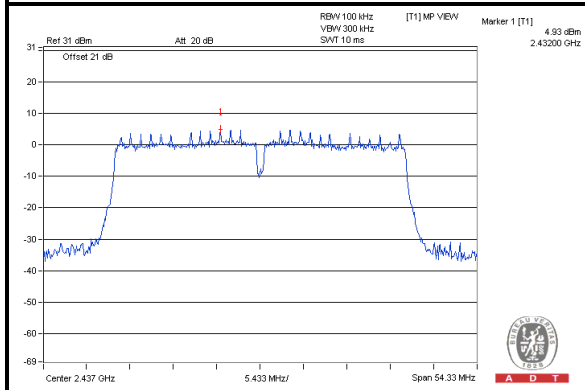

Chain(0)

CH 3

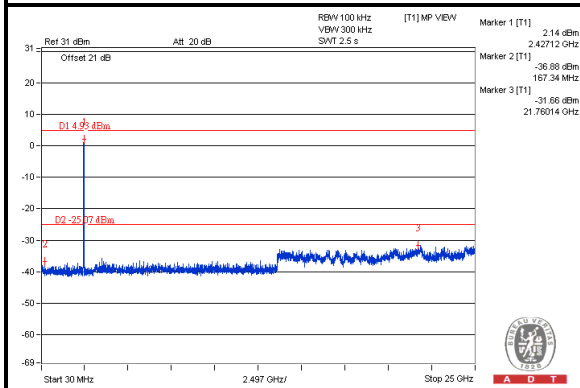

CH 6

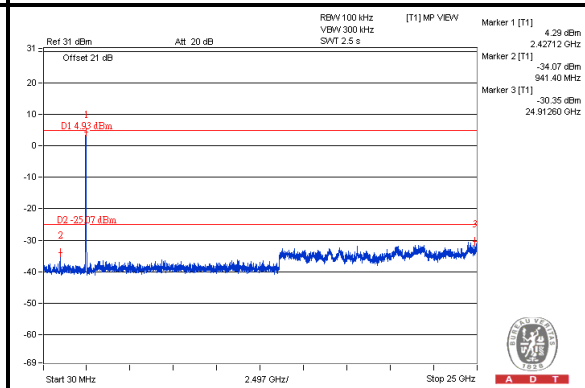

CH 9

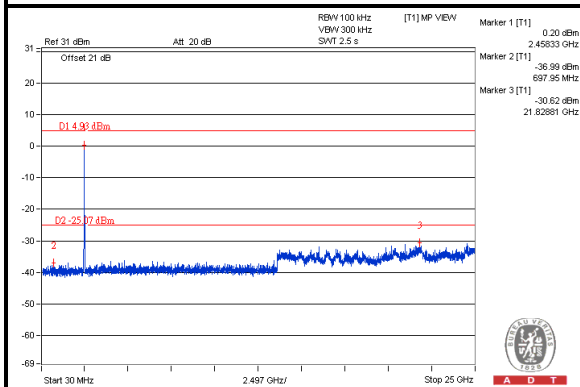

CH 3 Band edge

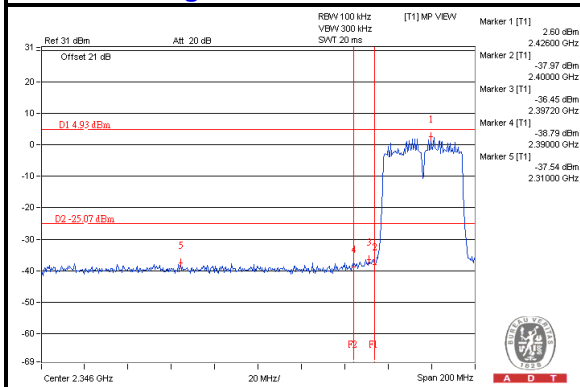

CH 9 Band edge

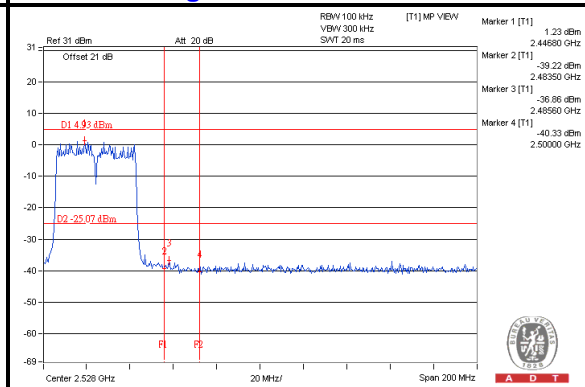



A D T

Chain(1)

CH 3

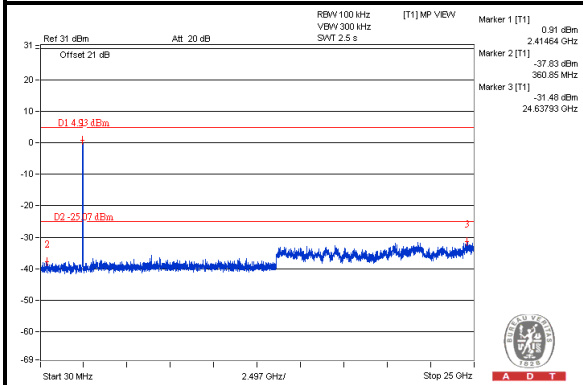

CH 6

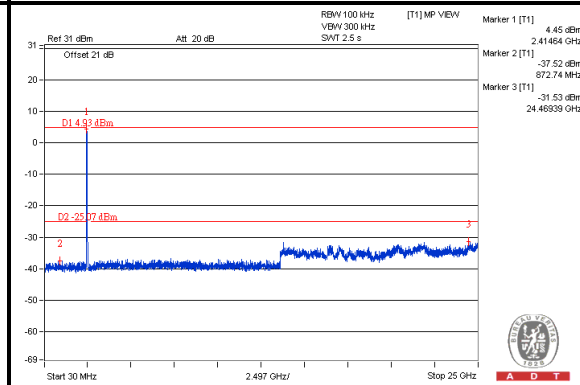

CH 9

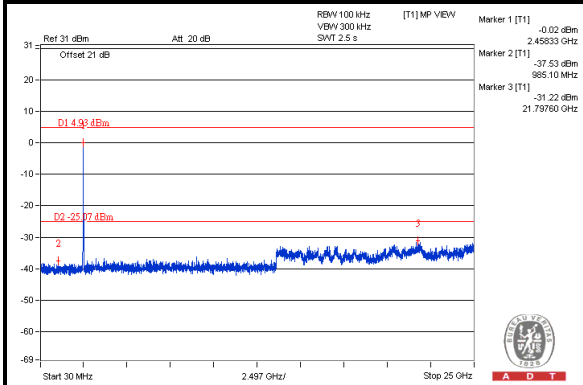

CH 3 Band edge

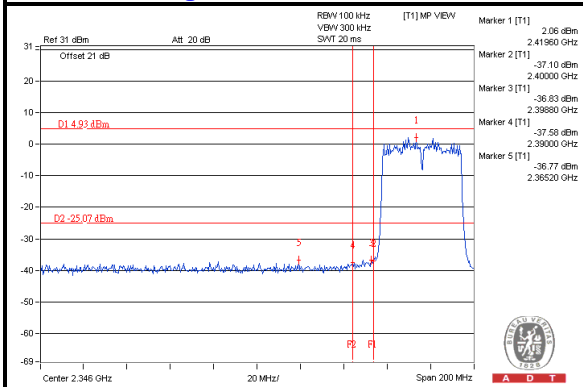

CH 9 Band edge

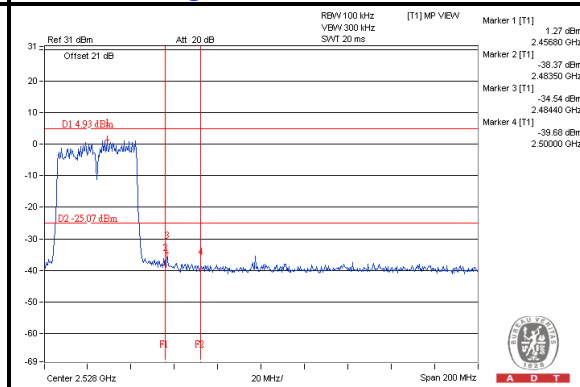



A D T

Chain(2)

CH 3

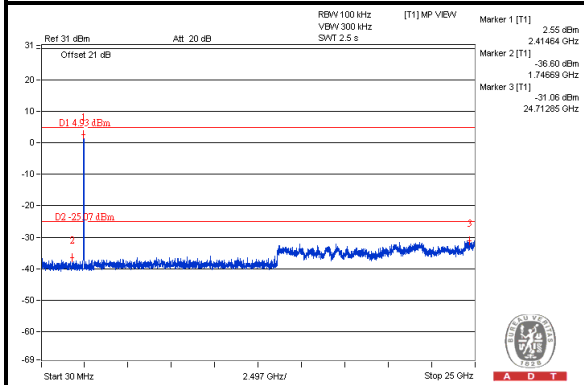

CH 6

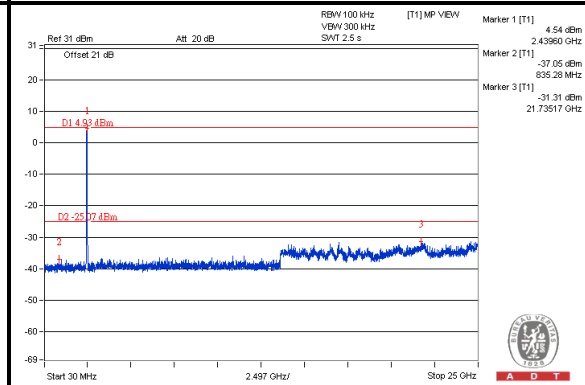

CH 9

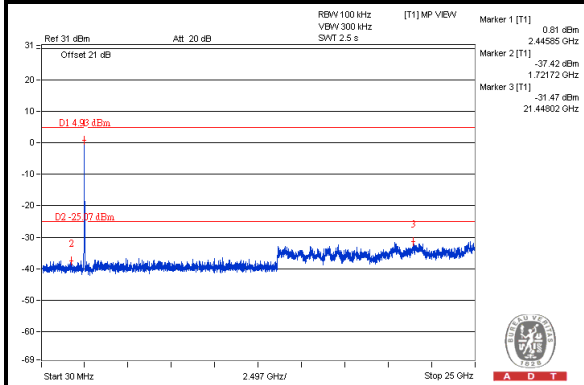

CH 3 Band edge

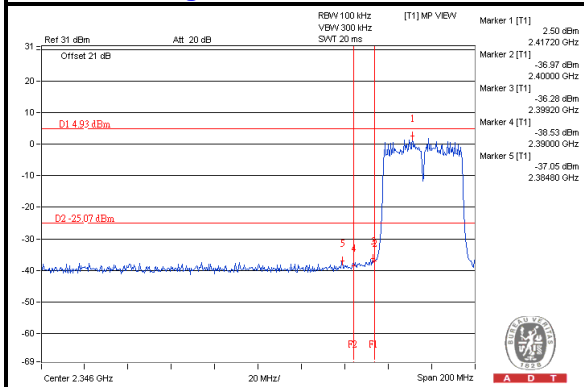

CH 9 Band edge

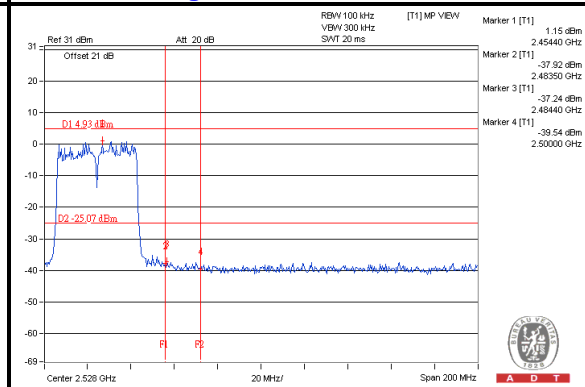



A D T

5. TEST TYPES AND RESULTS (FOR 5GHz, 5.725~5.850GHz Band)

5.1 CONDUCTED EMISSION MEASUREMENT

5.1.1 LIMITS OF CONDUCTED EMISSION MEASUREMENT

FREQUENCY OF EMISSION (MHz)	CONDUCTED LIMIT (dBµV)	
	Quasi-peak	Average
0.15-0.5	66 to 56	56 to 46
0.5-5	56	46
5-30	60	50

- NOTE:** 1. The lower limit shall apply at the transition frequencies.
2. The limit decreases in line with the logarithm of the frequency in the range of 0.15 to 0.50 MHz.

5.1.2 TEST INSTRUMENTS

DESCRIPTION & MANUFACTURER	MODEL NO.	SERIAL NO.	CALIBRATED DATE	CALIBRATED UNTIL
Test Receiver ROHDE & SCHWARZ	ESCS 30	100287	Feb. 28, 2013	Feb. 27, 2014
Line-Impedance Stabilization Network (for EUT) ROHDE & SCHWARZ	NSLK-8127	5127-523	Oct. 02, 2013	Oct. 01, 2014
Line-Impedance Stabilization Network (for Peripheral) ROHDE & SCHWARZ	ENV216	100071	Nov. 13, 2013	Nov. 12, 2014
RF Cable (JYEBAO)	5DFB	COACAB-001	May 27, 2013	May 26, 2014
50 ohms Terminator	50	3	Oct. 17, 2013	Oct. 16, 2014
50 ohms Terminator	N/A	EMC-04	Oct. 17, 2013	Oct. 16, 2014
Software ADT	BV ADT_Cond_V7.3.7 .3	NA	NA	NA

Note:

1. The calibration interval of the above test instruments is 12 months and the calibrations are traceable to NML/ROC and NIST/USA.
2. The test was performed in Shielded Room No. A.
- 3 The VCCI Con A Registration No. is C-817.
4. Tested Date: Dec. 25, 2013

5.1.3 TEST PROCEDURES

- a. The EUT was placed 0.4 meters from the conducting wall of the shielded room with EUT being connected to the power mains through a line impedance stabilization network (LISN). Other support units were connected to the power mains through another LISN.
- b. The two LISNs provide 50 ohm/ 50uH of coupling impedance for the measuring instrument.
- c. Both lines of the power mains connected to the EUT were checked for maximum conducted interference.
- d. The frequency range from 150kHz to 30MHz was searched. Emission levels under (Limit – 20dB) were not recorded.

NOTE:

1. The resolution bandwidth of test receiver is 9kHz for Quasi-peak detection (QP) & Average detection (AV).

5.1.4 DEVIATION FROM TEST STANDARD

No deviation

5.1.5 TEST SETUP

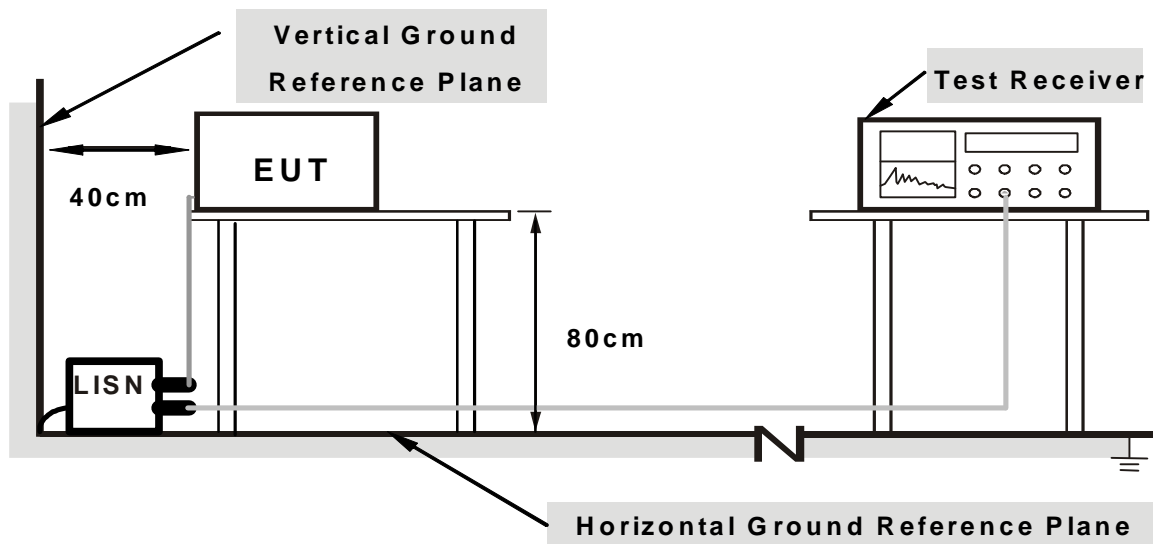

Note: 1.Support units were connected to second LISN.

For the actual test configuration, please refer to the related item – Photographs of the Test Configuration.

5.1.6 EUT OPERATING CONDITIONS

Same as the 4.1.6

5.1.7 TEST RESULTS (MODE 1)

PHASE	Line (L)	DETECTOR FUNCTION	Quasi-Peak (QP) / Average (AV)
--------------	----------	--------------------------	--------------------------------

No	Freq.	Corr.	Reading Value		Emission Level		Limit		Margin	
	[MHz]	Factor (dB)	[dB (uV)]		[dB (uV)]		[dB (uV)]		(dB)	
			Q.P.	AV.	Q.P.	AV.	Q.P.	AV.	Q.P.	AV.
1	0.15781	0.07	55.33	42.33	55.40	42.40	65.58	55.58	-10.18	-13.18
2	0.19297	0.08	51.85	32.60	51.93	32.68	63.91	53.91	-11.98	-21.23
3	0.23203	0.09	47.73	29.36	47.82	29.45	62.38	52.38	-14.56	-22.93
4	0.26328	0.10	44.46	32.90	44.56	33.00	61.33	51.33	-16.77	-18.33
5	0.45859	0.14	41.94	34.14	42.08	34.28	56.72	46.72	-14.63	-12.43
6	0.68125	0.16	37.73	30.60	37.89	30.76	56.00	46.00	-18.11	-15.24

REMARKS:

1. Q.P. and AV. are abbreviations of quasi-peak and average individually.
2. The emission levels of other frequencies were very low against the limit.
3. Margin value = Emission Level – Limit value
4. Correction Factor = Insertion loss + Cable loss
5. Emission Level = Correction Factor + Reading Value

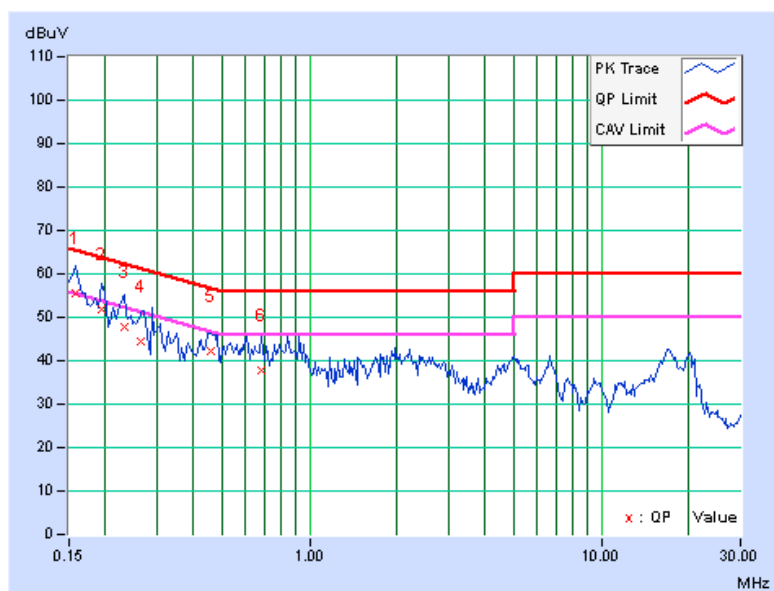



A D T

PHASE	Neutral (N)	DETECTOR FUNCTION	Quasi-Peak (QP) / Average (AV)
--------------	-------------	--------------------------	--------------------------------

No	Freq. [MHz]	Corr. Factor (dB)	Reading Value [dB (uV)]		Emission Level [dB (uV)]		Limit [dB (uV)]		Margin (dB)	
			Q.P.	AV.	Q.P.	AV.	Q.P.	AV.	Q.P.	AV.
1	0.15391	0.07	54.63	35.45	54.70	35.52	65.79	55.79	-11.09	-20.27
2	0.20438	0.07	48.77	41.27	48.84	41.34	63.43	53.43	-14.59	-12.09
3	0.25547	0.09	44.89	37.95	44.98	38.04	61.58	51.58	-16.60	-13.54
4	0.38047	0.13	44.36	37.33	44.49	37.46	58.27	48.27	-13.78	-10.81
5	0.51116	0.15	46.97	37.66	47.12	37.81	56.00	46.00	-8.88	-8.19
6	0.78281	0.17	42.76	35.26	42.93	35.43	56.00	46.00	-13.07	-10.57

REMARKS:

1. Q.P. and AV. are abbreviations of quasi-peak and average individually.
2. The emission levels of other frequencies were very low against the limit.
3. Margin value = Emission Level – Limit value
4. Correction Factor = Insertion loss + Cable loss
5. Emission Level = Correction Factor + Reading Value

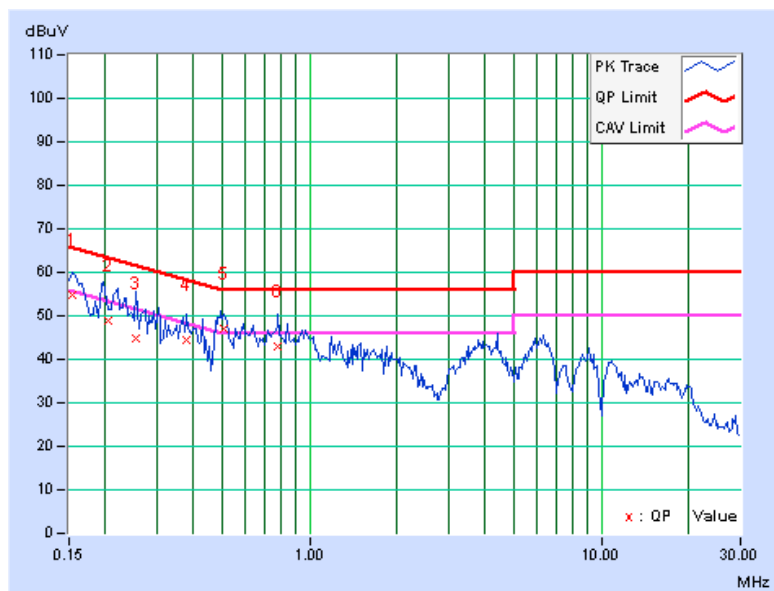

5.1.8 TEST RESULTS (MODE 2)

PHASE	Line (L)	DETECTOR FUNCTION	Quasi-Peak (QP) / Average (AV)
--------------	----------	--------------------------	--------------------------------

No	Freq. [MHz]	Corr. Factor (dB)	Reading Value [dB (uV)]		Emission Level [dB (uV)]		Limit [dB (uV)]		Margin (dB)	
			Q.P.	AV.	Q.P.	AV.	Q.P.	AV.	Q.P.	AV.
			1	0.15781	0.07	59.22	48.00	59.29	48.07	65.58
2	0.19297	0.08	53.85	40.52	53.93	40.60	63.91	53.91	-9.98	-13.31
3	0.23984	0.09	48.54	35.33	48.63	35.42	62.10	52.10	-13.47	-16.68
4	0.32188	0.12	43.54	30.23	43.66	30.35	59.66	49.66	-16.00	-19.31
5	0.42344	0.14	40.01	26.94	40.15	27.08	57.38	47.38	-17.23	-20.30
6	0.55625	0.15	33.71	21.74	33.86	21.89	56.00	46.00	-22.14	-24.11

REMARKS:

1. Q.P. and AV. are abbreviations of quasi-peak and average individually.
2. The emission levels of other frequencies were very low against the limit.
3. Margin value = Emission Level – Limit value
4. Correction Factor = Insertion loss + Cable loss
5. Emission Level = Correction Factor + Reading Value

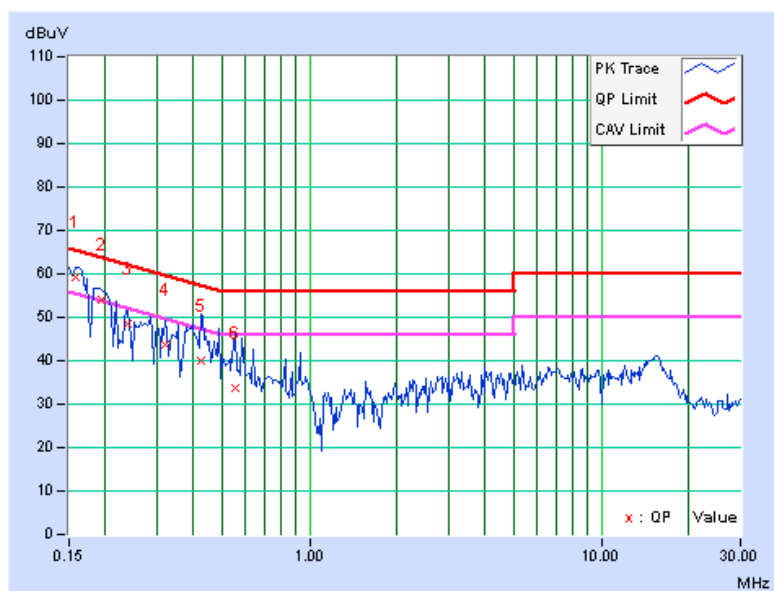

PHASE	Neutral (N)	DETECTOR FUNCTION	Quasi-Peak (QP) / Average (AV)
--------------	-------------	--------------------------	--------------------------------

No	Freq. [MHz]	Corr. Factor (dB)	Reading Value [dB (uV)]		Emission Level [dB (uV)]		Limit [dB (uV)]		Margin (dB)	
			Q.P.	AV.	Q.P.	AV.	Q.P.	AV.	Q.P.	AV.
			1	0.15781	0.07	58.88	47.14	58.95	47.21	65.58
2	0.18906	0.07	54.17	38.76	54.24	38.83	64.08	54.08	-9.84	-15.25
3	0.23203	0.08	48.44	33.71	48.52	33.79	62.38	52.38	-13.86	-18.59
4	0.30234	0.11	44.64	32.74	44.75	32.85	60.18	50.18	-15.43	-17.33
5	0.39219	0.14	44.20	31.55	44.34	31.69	58.02	48.02	-13.68	-16.33
6	0.52891	0.15	37.67	25.11	37.82	25.26	56.00	46.00	-18.18	-20.74

REMARKS:

1. Q.P. and AV. are abbreviations of quasi-peak and average individually.
2. The emission levels of other frequencies were very low against the limit.
3. Margin value = Emission Level – Limit value
4. Correction Factor = Insertion loss + Cable loss
5. Emission Level = Correction Factor + Reading Value

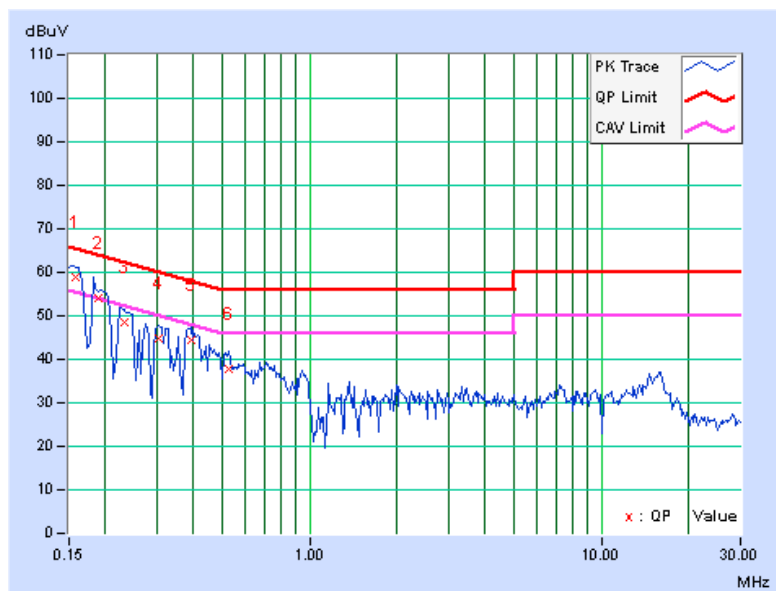



A D T

5.2 RADIATED AND BANDEGE EMISSION MEASUREMENT

5.2.1 LIMITS OF RADIATED AND BANDEGE EMISSION MEASUREMENT

Radiated emissions which fall in the restricted bands must comply with the radiated emission limits specified as below table. Other emissions shall be at least 30dB below the highest level of the desired power:

Frequencies (MHz)	Field strength (microvolts/meter)	Measurement distance (meters)
0.009-0.490	2400/F(kHz)	300
0.490-1.705	24000/F(kHz)	30
1.705-30.0	30	30
30-88	100	3
88-216	150	3
216-960	200	3
Above 960	500	3

NOTE:

1. The lower limit shall apply at the transition frequencies.
2. Emission level (dBuV/m) = 20 log Emission level (uV/m).
3. For frequencies above 1000MHz, the field strength limits are based on average detector, however, the peak field strength of any emission shall not exceed the maximum permitted average limits, specified above by more than 20dB under any condition of modulation.



A D T

5.2.2 TEST INSTRUMENTS

DESCRIPTION & MANUFACTURER	MODEL NO.	SERIAL NO.	CALIBRATED DATE	CALIBRATED UNTIL
MXE EMI Receiver Agilent	N9038A	MY51210105	Jan. 29,2013	Jan. 28,2014
Pre-Amplifier Mini-Circuits	ZFL-1000VH2 B	AMP-ZFL-03	Nov. 13, 2013	Nov. 12, 2014
Trilog Broadband Antenna SCHWARZBECK	VULB 9168	9168-360	Mar. 19, 2013	Mar. 18, 2014
RF Cable	NA	CHGCAB_001	Oct. 05, 2013	Oct. 04, 2014
Spectrum Analyzer R&S	FSV40	100964	July 15, 2013	July 14, 2014
Horn_Antenna AISI	AIH.8018	0000320091110	Nov. 18, 2013	Nov. 17, 2014
Pre-Amplifier Agilent	8449B	3008A02578	June 25, 2013	June 24, 2014
RF Cable	NA	RF104-201 RF104-203 RF104-204	Dec. 12, 2013	Dec. 11, 2014
Spectrum Analyzer Agilent	E4446A	MY48250253	Aug. 28, 2013	Aug. 27, 2014
Pre-Amplifier SPACEK LABS	SLKKa-48-6	9K16	Nov. 13, 2013	Nov. 12, 2014
Horn_Antenna SCHWARZBECK	BBHA 9170	9170-424	Oct. 08, 2013	Oct. 07, 2014
Software	ADT_Radiated _V8.7.07	NA	NA	NA
Antenna Tower & Turn Table CT	NA	NA	NA	NA

Note:

1. The calibration interval of the above test instruments is 12 months and the calibrations are traceable to NML/ROC and NIST/USA.
2. The horn antenna, preamplifier (model: 8449B) are used only for the measurement of emission frequency above 1GHz if tested.
- 3 The test was performed in 966 Chamber No. G.
4. The FCC Site Registration No. is 966073.
- 5 The VCCI Site Registration No. is G-137.
- 6 The CANADA Site Registration No. is IC 7450H-2.
- 7 Tested Date: Dec. 25, 2013 to Jan. 07, 2014

5.2.3 TEST PROCEDURES

- a. The EUT was placed on the top of a rotating table 0.8 meters above the ground at 3 meter chamber room for test. The table was rotated 360 degrees to determine the position of the highest radiation.
- b. The EUT was set 3 meters away from the interference-receiving antenna, which was mounted on the top of a variable-height antenna tower.
- c. The height of antenna is varied from one meter to four meters above the ground to determine the maximum value of the field strength. Both horizontal and vertical polarizations of the antenna are set to make the measurement.
- d. For each suspected emission, the EUT was arranged to its worst case and then the antenna was tuned to heights from 1 meter to 4 meters and the rotatable table was turned from 0 degrees to 360 degrees to find the maximum reading.
- e. The test-receiver system was set to quasi-peak detect function and specified bandwidth with maximum hold mode when the test frequency is below 1 GHz.
- f. The test-receiver system was set to peak and average detect function and specified bandwidth with maximum hold mode when the test frequency is above 1 GHz. If the peak reading value also meets average limit, measurement with the average detector is unnecessary.

Note:

1. The resolution bandwidth and video bandwidth of test receiver/spectrum analyzer is 120kHz for Quasi-peak detection (QP) at frequency below 1GHz.
2. The resolution bandwidth of test receiver/spectrum analyzer is 1 MHz and the video bandwidth is 3 MHz for Peak detection (PK) at frequency above 1GHz.
3. The resolution bandwidth of test receiver/spectrum analyzer is 1MHz and the video bandwidth is 3MHz for RMS Average (Duty cycle < 98%) for Average detection (AV) at frequency above 1GHz, then the measurement results was added to a correction factor ($10 \log(1/\text{duty cycle})$).
4. The resolution bandwidth of test receiver/spectrum analyzer is 1MHz and the video bandwidth is 10Hz (Duty cycle $\geq 98\%$) for Average detection (AV) at frequency above 1GHz.
5. All modes of operation were investigated and the worst-case emissions are reported.

5.2.4 DEVIATION FROM TEST STANDARD

No deviation

5.2.5 TEST SETUP

<Frequency Range below 1GHz>

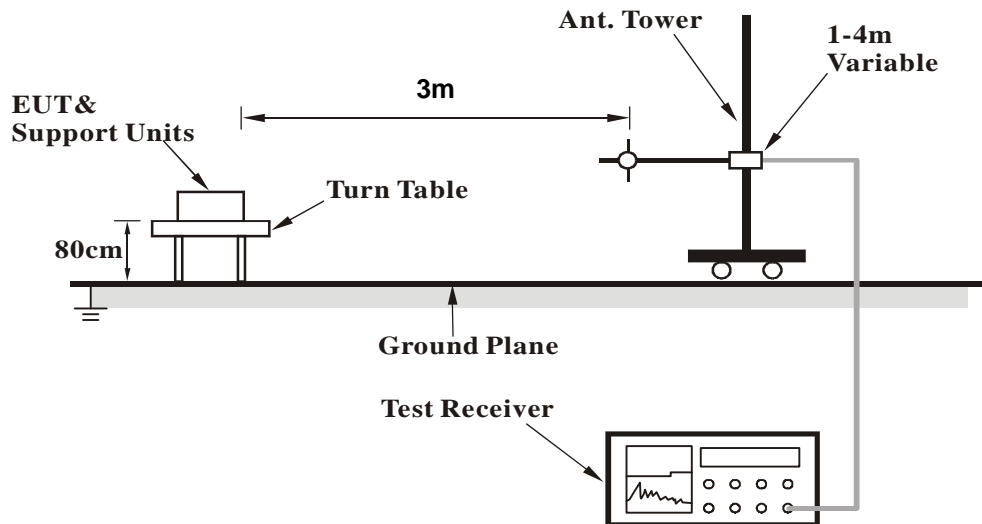

<Frequency Range above 1GHz>

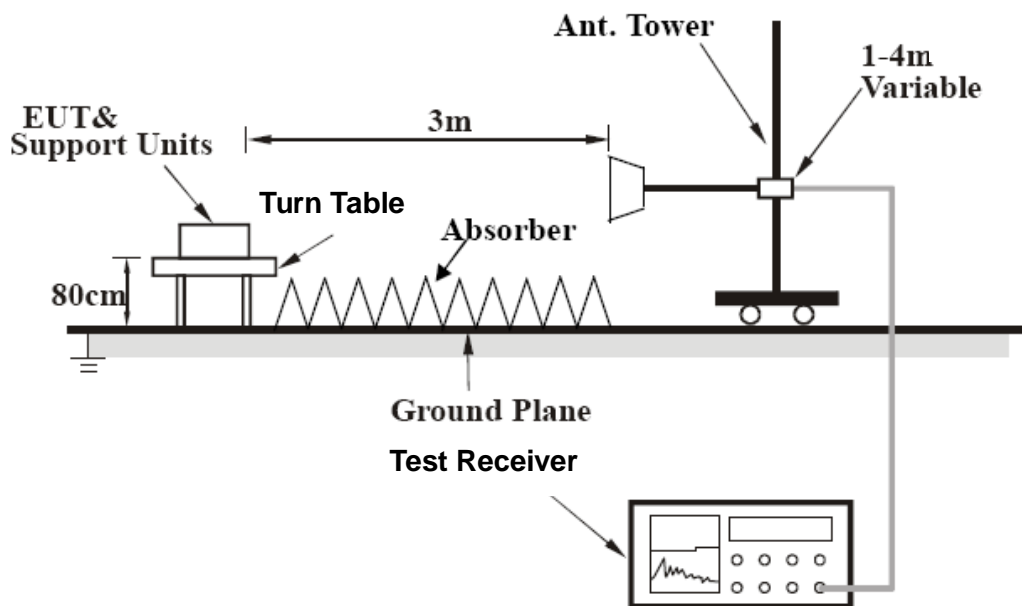

For the actual test configuration, please refer to the related item – Photographs of the Test Configuration.

5.2.6 EUT OPERATING CONDITIONS

Same as the 4.1.6

5.2.7 TEST RESULTS

BELOW 1GHz WORST-CASE DATA

802.11ac (VHT40)

CHANNEL	TX Channel 159	DETECTOR FUNCTION	Quasi-Peak (QP)
FREQUENCY RANGE	Below 1GHz		

ANTENNA POLARITY & TEST DISTANCE: HORIZONTAL AT 3 M								
NO.	FREQ. (MHz)	EMISSION LEVEL (dBuV/m)	LIMIT (dBuV/m)	MARGIN (dB)	ANTENNA HEIGHT (m)	TABLE ANGLE (Degree)	RAW VALUE (dBuV)	CORRECTION FACTOR (dB/m)
1	103.81	35.4 QP	43.5	-8.1	2.00 H	302	52.72	-17.29
2	125.00	33.9 QP	43.5	-9.6	1.50 H	33	48.74	-14.83
3	162.57	32.0 QP	43.5	-11.5	1.50 H	241	45.28	-13.28
4	270.10	33.8 QP	46.0	-12.2	1.50 H	271	47.35	-13.55
5	286.13	33.8 QP	46.0	-12.2	1.00 H	271	46.78	-12.94
6	322.27	32.6 QP	46.0	-13.4	1.00 H	324	44.32	-11.72
ANTENNA POLARITY & TEST DISTANCE: VERTICAL AT 3 M								
NO.	FREQ. (MHz)	EMISSION LEVEL (dBuV/m)	LIMIT (dBuV/m)	MARGIN (dB)	ANTENNA HEIGHT (m)	TABLE ANGLE (Degree)	RAW VALUE (dBuV)	CORRECTION FACTOR (dB/m)
1	92.30	34.1 QP	43.5	-9.4	1.50 V	351	53.08	-18.98
2	109.34	38.2 QP	43.5	-5.3	1.50 V	237	54.30	-16.13
3	130.10	35.7 QP	43.5	-7.8	1.00 V	189	50.46	-14.75
4	162.23	31.6 QP	43.5	-12.0	1.00 V	139	44.74	-13.19
5	269.64	32.5 QP	46.0	-13.5	1.00 V	200	46.10	-13.59
6	400.00	30.4 QP	46.0	-15.6	1.50 V	299	40.31	-9.91

REMARKS:

1. Emission Level(dBuV/m) = Raw Value(dBuV) + Correction Factor(dB/m)
2. Correction Factor(dB/m) = Antenna Factor(dB/m) + Cable Factor(dB) – Pre-Amplifier Factor(dB)
3. The other emission levels were very low against the limit.
4. Margin value = Emission Level – Limit value

ABOVE 1GHz DATA

802.11a

CHANNEL	TX Channel 149	DETECTOR FUNCTION	Peak (PK)
FREQUENCY RANGE	1GHz ~ 40GHz		Average (AV)

ANTENNA POLARITY & TEST DISTANCE: HORIZONTAL AT 3 M								
NO.	FREQ. (MHz)	EMISSION LEVEL (dBuV/m)	LIMIT (dBuV/m)	MARGIN (dB)	ANTENNA HEIGHT (m)	TABLE ANGLE (Degree)	RAW VALUE (dBuV)	CORRECTION FACTOR (dB/m)
1	*5745.00	112.2 PK			1.18 H	147	102.70	9.50
2	*5745.00	102.6 AV			1.18 H	147	93.10	9.50
3	11490.00	63.9 PK	74.0	-10.1	1.00 H	84	48.00	15.90
4	11490.00	50.6 AV	54.0	-3.4	1.00 H	84	34.70	15.90
ANTENNA POLARITY & TEST DISTANCE: VERTICAL AT 3 M								
NO.	FREQ. (MHz)	EMISSION LEVEL (dBuV/m)	LIMIT (dBuV/m)	MARGIN (dB)	ANTENNA HEIGHT (m)	TABLE ANGLE (Degree)	RAW VALUE (dBuV)	CORRECTION FACTOR (dB/m)
1	*5745.00	120.6 PK			1.00 V	193	111.10	9.50
2	*5745.00	110.6 AV			1.00 V	193	101.10	9.50
3	11490.00	63.5 PK	74.0	-10.5	1.00 V	267	47.60	15.90
4	11490.00	49.3 AV	54.0	-4.7	1.00 V	267	33.40	15.90

REMARKS:

1. Emission Level(dBuV/m) = Raw Value(dBuV) + Correction Factor(dB/m)
2. Correction Factor(dB/m) = Antenna Factor(dB/m) + Cable Factor(dB) – Pre-Amplifier Factor(dB)
3. The other emission levels were very low against the limit.
4. Margin value = Emission Level – Limit value
5. " * ": Fundamental frequency.
6. The limit value is defined as per 15.247.



A D T

CHANNEL	TX Channel 157	DETECTOR FUNCTION	Peak (PK)
FREQUENCY RANGE	1GHz ~ 40GHz		Average (AV)

ANTENNA POLARITY & TEST DISTANCE: HORIZONTAL AT 3 M

NO.	FREQ. (MHz)	EMISSION LEVEL (dBuV/m)	LIMIT (dBuV/m)	MARGIN (dB)	ANTENNA HEIGHT (m)	TABLE ANGLE (Degree)	RAW VALUE (dBuV)	CORRECTION FACTOR (dB/m)
1	*5785.00	119.5 PK			1.12 H	175	109.90	9.60
2	*5785.00	107.4 AV			1.12 H	175	97.80	9.60
3	11570.00	66.1 PK	74.0	-7.9	1.23 H	66	50.20	15.90
4	11570.00	53.3 AV	54.0	-0.7	1.23 H	66	37.40	15.90

ANTENNA POLARITY & TEST DISTANCE: VERTICAL AT 3 M

NO.	FREQ. (MHz)	EMISSION LEVEL (dBuV/m)	LIMIT (dBuV/m)	MARGIN (dB)	ANTENNA HEIGHT (m)	TABLE ANGLE (Degree)	RAW VALUE (dBuV)	CORRECTION FACTOR (dB/m)
1	*5785.00	119.7 PK			1.00 V	191	110.10	9.60
2	*5785.00	110.1 AV			1.00 V	191	100.50	9.60
3	11570.00	63.7 PK	74.0	-10.3	1.05 V	273	47.80	15.90
4	11570.00	49.3 AV	54.0	-4.7	1.05 V	273	33.40	15.90

REMARKS:

1. Emission Level(dBuV/m) = Raw Value(dBuV) + Correction Factor(dB/m)
2. Correction Factor(dB/m) = Antenna Factor(dB/m) + Cable Factor(dB) – Pre-Amplifier Factor(dB)
3. The other emission levels were very low against the limit.
4. Margin value = Emission Level – Limit value
5. " * ": Fundamental frequency.
6. The limit value is defined as per 15.247.



A D T

CHANNEL	TX Channel 165	DETECTOR FUNCTION	Peak (PK)
FREQUENCY RANGE	1GHz ~ 40GHz		Average (AV)

ANTENNA POLARITY & TEST DISTANCE: HORIZONTAL AT 3 M								
NO.	FREQ. (MHz)	EMISSION LEVEL (dBuV/m)	LIMIT (dBuV/m)	MARGIN (dB)	ANTENNA HEIGHT (m)	TABLE ANGLE (Degree)	RAW VALUE (dBuV)	CORRECTION FACTOR (dB/m)
1	*5825.00	119.9 PK			1.08 H	188	110.20	9.70
2	*5825.00	107.6 AV			1.08 H	188	97.90	9.70
3	11650.00	66.9 PK	74.0	-7.1	1.22 H	67	50.70	16.20
4	11650.00	53.6 AV	54.0	-0.4	1.22 H	67	37.40	16.20

ANTENNA POLARITY & TEST DISTANCE: VERTICAL AT 3 M								
NO.	FREQ. (MHz)	EMISSION LEVEL (dBuV/m)	LIMIT (dBuV/m)	MARGIN (dB)	ANTENNA HEIGHT (m)	TABLE ANGLE (Degree)	RAW VALUE (dBuV)	CORRECTION FACTOR (dB/m)
1	*5825.00	117.9 PK			1.00 V	190	108.20	9.70
2	*5825.00	108.3 AV			1.00 V	190	98.60	9.70
3	11650.00	64.0 PK	74.0	-10.0	1.08 V	286	47.80	16.20
4	11650.00	49.4 AV	54.0	-4.6	1.08 V	286	33.20	16.20

REMARKS:

1. Emission Level(dBuV/m) = Raw Value(dBuV) + Correction Factor(dB/m)
2. Correction Factor(dB/m) = Antenna Factor(dB/m) + Cable Factor(dB) – Pre-Amplifier Factor(dB)
3. The other emission levels were very low against the limit.
4. Margin value = Emission Level – Limit value
5. " * ": Fundamental frequency.
6. The limit value is defined as per 15.247.



A D T

802.11ac (VHT20)

CHANNEL	TX Channel 149	DETECTOR FUNCTION	Peak (PK)
FREQUENCY RANGE	1GHz ~ 40GHz		Average (AV)

ANTENNA POLARITY & TEST DISTANCE: HORIZONTAL AT 3 M

NO.	FREQ. (MHz)	EMISSION LEVEL (dBuV/m)	LIMIT (dBuV/m)	MARGIN (dB)	ANTENNA HEIGHT (m)	TABLE ANGLE (Degree)	RAW VALUE (dBuV)	CORRECTION FACTOR (dB/m)
1	*5745.00	115.9 PK			1.00 H	6	106.40	9.50
2	*5745.00	106.1 AV			1.00 H	6	96.60	9.50
3	11490.00	66.7 PK	74.0	-7.3	1.03 H	71	50.80	15.90
4	11490.00	53.7 AV	54.0	-0.3	1.03 H	71	37.80	15.90

ANTENNA POLARITY & TEST DISTANCE: VERTICAL AT 3 M

NO.	FREQ. (MHz)	EMISSION LEVEL (dBuV/m)	LIMIT (dBuV/m)	MARGIN (dB)	ANTENNA HEIGHT (m)	TABLE ANGLE (Degree)	RAW VALUE (dBuV)	CORRECTION FACTOR (dB/m)
1	*5745.00	119.5 PK			1.00 V	177	110.00	9.50
2	*5745.00	110.1 AV			1.00 V	177	100.60	9.50
3	11490.00	63.2 PK	74.0	-10.8	1.00 V	268	47.30	15.90
4	11490.00	48.7 AV	54.0	-5.3	1.00 V	268	32.80	15.90

REMARKS:

1. Emission Level(dBuV/m) = Raw Value(dBuV) + Correction Factor(dB/m)
2. Correction Factor(dB/m) = Antenna Factor(dB/m) + Cable Factor(dB) – Pre-Amplifier Factor(dB)
3. The other emission levels were very low against the limit.
4. Margin value = Emission Level – Limit value
5. " * ": Fundamental frequency.
6. The limit value is defined as per 15.247.



A D T

CHANNEL	TX Channel 157	DETECTOR FUNCTION	Peak (PK)
FREQUENCY RANGE	1GHz ~ 40GHz		Average (AV)

ANTENNA POLARITY & TEST DISTANCE: HORIZONTAL AT 3 M								
NO.	FREQ. (MHz)	EMISSION LEVEL (dBuV/m)	LIMIT (dBuV/m)	MARGIN (dB)	ANTENNA HEIGHT (m)	TABLE ANGLE (Degree)	RAW VALUE (dBuV)	CORRECTION FACTOR (dB/m)
1	*5785.00	115.7 PK			1.01 H	6	106.10	9.60
2	*5785.00	106.0 AV			1.01 H	6	96.40	9.60
3	11570.00	66.8 PK	74.0	-7.2	1.25 H	70	50.90	15.90
4	11570.00	53.6 AV	54.0	-0.4	1.25 H	70	37.70	15.90

ANTENNA POLARITY & TEST DISTANCE: VERTICAL AT 3 M								
NO.	FREQ. (MHz)	EMISSION LEVEL (dBuV/m)	LIMIT (dBuV/m)	MARGIN (dB)	ANTENNA HEIGHT (m)	TABLE ANGLE (Degree)	RAW VALUE (dBuV)	CORRECTION FACTOR (dB/m)
1	*5785.00	118.1 PK			1.00 V	176	108.50	9.60
2	*5785.00	108.6 AV			1.00 V	176	99.00	9.60
3	11570.00	62.7 PK	74.0	-11.3	1.02 V	252	46.80	15.90
4	11570.00	48.5 AV	54.0	-5.5	1.02 V	252	32.60	15.90

REMARKS:

1. Emission Level(dBuV/m) = Raw Value(dBuV) + Correction Factor(dB/m)
2. Correction Factor(dB/m) = Antenna Factor(dB/m) + Cable Factor(dB) – Pre-Amplifier Factor(dB)
3. The other emission levels were very low against the limit.
4. Margin value = Emission Level – Limit value
5. " * ": Fundamental frequency.
6. The limit value is defined as per 15.247.



A D T

CHANNEL	TX Channel 165	DETECTOR FUNCTION	Peak (PK)
FREQUENCY RANGE	1GHz ~ 40GHz		Average (AV)

ANTENNA POLARITY & TEST DISTANCE: HORIZONTAL AT 3 M								
NO.	FREQ. (MHz)	EMISSION LEVEL (dBuV/m)	LIMIT (dBuV/m)	MARGIN (dB)	ANTENNA HEIGHT (m)	TABLE ANGLE (Degree)	RAW VALUE (dBuV)	CORRECTION FACTOR (dB/m)
1	*5825.00	115.2 PK			1.00 H	0	105.50	9.70
2	*5825.00	105.5 AV			1.00 H	0	95.80	9.70
3	11650.00	67.2 PK	74.0	-6.8	1.25 H	68	51.00	16.20
4	11650.00	53.4 AV	54.0	-0.6	1.25 H	68	37.20	16.20

ANTENNA POLARITY & TEST DISTANCE: VERTICAL AT 3 M								
NO.	FREQ. (MHz)	EMISSION LEVEL (dBuV/m)	LIMIT (dBuV/m)	MARGIN (dB)	ANTENNA HEIGHT (m)	TABLE ANGLE (Degree)	RAW VALUE (dBuV)	CORRECTION FACTOR (dB/m)
1	*5825.00	118.2 PK			1.00 V	174	108.50	9.70
2	*5825.00	108.3 AV			1.00 V	174	98.60	9.70
3	11650.00	62.8 PK	74.0	-11.2	1.05 V	239	46.60	16.20
4	11650.00	48.4 AV	54.0	-5.6	1.05 V	239	32.20	16.20

REMARKS:

1. Emission Level(dBuV/m) = Raw Value(dBuV) + Correction Factor(dB/m)
2. Correction Factor(dB/m) = Antenna Factor(dB/m) + Cable Factor(dB) – Pre-Amplifier Factor(dB)
3. The other emission levels were very low against the limit.
4. Margin value = Emission Level – Limit value
5. " * ": Fundamental frequency.
6. The limit value is defined as per 15.247.



A D T

802.11ac (VHT40)

CHANNEL	TX Channel 151	DETECTOR FUNCTION	Peak (PK)
FREQUENCY RANGE	1GHz ~ 40GHz		Average (AV)

ANTENNA POLARITY & TEST DISTANCE: HORIZONTAL AT 3 M

NO.	FREQ. (MHz)	EMISSION LEVEL (dBuV/m)	LIMIT (dBuV/m)	MARGIN (dB)	ANTENNA HEIGHT (m)	TABLE ANGLE (Degree)	RAW VALUE (dBuV)	CORRECTION FACTOR (dB/m)
1	*5755.00	113.6 PK			1.01 H	4	104.00	9.60
2	*5755.00	102.4 AV			1.01 H	4	92.80	9.60
3	11510.00	65.9 PK	74.0	-8.1	1.26 H	91	50.00	15.90
4	11510.00	53.4 AV	54.0	-0.6	1.26 H	91	37.50	15.90

ANTENNA POLARITY & TEST DISTANCE: VERTICAL AT 3 M

NO.	FREQ. (MHz)	EMISSION LEVEL (dBuV/m)	LIMIT (dBuV/m)	MARGIN (dB)	ANTENNA HEIGHT (m)	TABLE ANGLE (Degree)	RAW VALUE (dBuV)	CORRECTION FACTOR (dB/m)
1	*5755.00	117.4 PK			1.00 V	172	107.80	9.60
2	*5755.00	107.9 AV			1.00 V	172	98.30	9.60
3	11510.00	62.8 PK	74.0	-11.2	1.02 V	229	46.90	15.90
4	11510.00	48.2 AV	54.0	-5.8	1.02 V	229	32.30	15.90

REMARKS:

1. Emission Level(dBuV/m) = Raw Value(dBuV) + Correction Factor(dB/m)
2. Correction Factor(dB/m) = Antenna Factor(dB/m) + Cable Factor(dB) – Pre-Amplifier Factor(dB)
3. The other emission levels were very low against the limit.
4. Margin value = Emission Level – Limit value
5. " * ": Fundamental frequency.
6. The limit value is defined as per 15.247.



A D T

CHANNEL	TX Channel 159	DETECTOR FUNCTION	Peak (PK)
FREQUENCY RANGE	1GHz ~ 40GHz		Average (AV)

ANTENNA POLARITY & TEST DISTANCE: HORIZONTAL AT 3 M

NO.	FREQ. (MHz)	EMISSION LEVEL (dBuV/m)	LIMIT (dBuV/m)	MARGIN (dB)	ANTENNA HEIGHT (m)	TABLE ANGLE (Degree)	RAW VALUE (dBuV)	CORRECTION FACTOR (dB/m)
1	*5795.00	113.3 PK			1.06 H	11	103.70	9.60
2	*5795.00	102.1 AV			1.06 H	11	92.50	9.60
3	11590.00	68.1 PK	74.0	-5.9	1.24 H	66	52.20	15.90
4	11590.00	53.4 AV	54.0	-0.6	1.24 H	66	37.50	15.90

ANTENNA POLARITY & TEST DISTANCE: VERTICAL AT 3 M

NO.	FREQ. (MHz)	EMISSION LEVEL (dBuV/m)	LIMIT (dBuV/m)	MARGIN (dB)	ANTENNA HEIGHT (m)	TABLE ANGLE (Degree)	RAW VALUE (dBuV)	CORRECTION FACTOR (dB/m)
1	*5795.00	116.1 PK			1.00 V	172	106.50	9.60
2	*5795.00	106.7 AV			1.00 V	172	97.10	9.60
3	11590.00	62.8 PK	74.0	-11.2	1.00 V	216	46.90	15.90
4	11590.00	48.0 AV	54.0	-6.0	1.00 V	216	32.10	15.90

REMARKS:

1. Emission Level(dBuV/m) = Raw Value(dBuV) + Correction Factor(dB/m)
2. Correction Factor(dB/m) = Antenna Factor(dB/m) + Cable Factor(dB) – Pre-Amplifier Factor(dB)
3. The other emission levels were very low against the limit.
4. Margin value = Emission Level – Limit value
5. " * ": Fundamental frequency.
6. The limit value is defined as per 15.247.



A D T

802.11ac (VHT80)

CHANNEL	TX Channel 155	DETECTOR FUNCTION	Peak (PK)
FREQUENCY RANGE	1GHz ~ 40GHz		Average (AV)

ANTENNA POLARITY & TEST DISTANCE: HORIZONTAL AT 3 M								
NO.	FREQ. (MHz)	EMISSION LEVEL (dBuV/m)	LIMIT (dBuV/m)	MARGIN (dB)	ANTENNA HEIGHT (m)	TABLE ANGLE (Degree)	RAW VALUE (dBuV)	CORRECTION FACTOR (dB/m)
1	5133.00	59.1 PK	74.0	-14.9	1.00 H	80	51.30	7.80
2	5133.00	46.2 AV	54.0	-7.8	1.00 H	80	38.40	7.80
3	*5775.00	111.1 PK			1.01 H	2	101.50	9.60
4	*5775.00	100.4 AV			1.01 H	2	90.80	9.60
5	11550.00	67.1 PK	74.0	-6.9	1.24 H	67	51.20	15.90
6	11550.00	53.5 AV	54.0	-0.5	1.24 H	67	37.60	15.90

ANTENNA POLARITY & TEST DISTANCE: VERTICAL AT 3 M								
NO.	FREQ. (MHz)	EMISSION LEVEL (dBuV/m)	LIMIT (dBuV/m)	MARGIN (dB)	ANTENNA HEIGHT (m)	TABLE ANGLE (Degree)	RAW VALUE (dBuV)	CORRECTION FACTOR (dB/m)
1	5133.00	60.9 PK	74.0	-13.1	1.82 V	245	53.10	7.80
2	5133.00	53.8 AV	54.0	-0.2	1.82 V	245	46.00	7.80
3	*5775.00	116.1 PK			1.00 V	179	106.50	9.60
4	*5775.00	105.1 AV			1.00 V	179	95.50	9.60
5	11550.00	62.4 PK	74.0	-11.6	1.00 V	215	46.50	15.90
6	11550.00	47.7 AV	54.0	-6.3	1.00 V	215	31.80	15.90

REMARKS:

1. Emission Level(dBuV/m) = Raw Value(dBuV) + Correction Factor(dB/m)
2. Correction Factor(dB/m) = Antenna Factor(dB/m) + Cable Factor(dB) – Pre-Amplifier Factor(dB)
3. The other emission levels were very low against the limit.
4. Margin value = Emission Level – Limit value
5. " * ": Fundamental frequency.
6. The limit value is defined as per 15.247.

5.3 6dB BANDWIDTH MEASUREMENT

5.3.1 LIMITS OF 6dB BANDWIDTH MEASUREMENT

The minimum of 6dB Bandwidth Measurement is 0.5 MHz.

5.3.2 TEST INSTRUMENTS

DESCRIPTION & MANUFACTURER	MODEL NO.	SERIAL NO.	CALIBRATED DATE	CALIBRATED UNTIL
Spectrum Analyzer R&S	FSP40	100036	Jan. 21, 2013	Jan. 20, 2014

Note:

1. The calibration interval of the above test instruments is 12 months and the calibrations are traceable to NML/ROC and NIST/USA.
2. Tested date : Jan. 02, 2014

5.3.3 TEST PROCEDURE

1. Set resolution bandwidth (RBW) = 100kHz
2. Set the video bandwidth (VBW) $\geq 3 \times$ RBW, Detector = Peak.
3. Trace mode = max hold.
4. Sweep = auto couple.
5. Measure the maximum width of the emission that is constrained by the frequencies associated with the two amplitude points (upper and lower) that are attenuated by 6 dB relative to the maximum level measured in the fundamental emission

5.3.4 DEVIATION FROM TEST STANDARD

No deviation

5.3.5 TEST SETUP

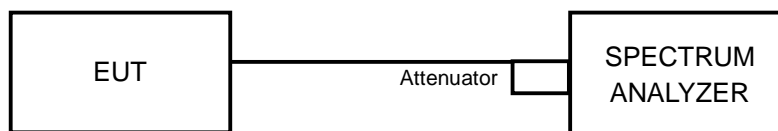



A D T

5.3.6 EUT OPERATING CONDITIONS

The software provided by client to enable the EUT under transmission condition continuously at lowest, middle and highest channel frequencies individually.



A D T

5.3.7 TEST RESULTS

802.11a

CHANNEL	CHANNEL FREQUENCY (MHz)	6dB BANDWIDTH (MHz)	MINIMUM LIMIT (MHz)	PASS / FAIL
149	5745	16.41	0.5	PASS
157	5785	16.40	0.5	PASS
165	5825	16.41	0.5	PASS

802.11ac (VHT20)

CHANNEL	CHANNEL FREQUENCY (MHz)	6dB BANDWIDTH (MHz)			MINIMUM LIMIT (MHz)	PASS / FAIL
		CHAIN 0	CHAIN 1	CHAIN 2		
149	5745	17.66	17.70	17.68	0.5	PASS
157	5785	17.68	17.70	17.70	0.5	PASS
165	5825	17.67	17.67	17.67	0.5	PASS

802.11ac (VHT40)

CHANNEL	CHANNEL FREQUENCY (MHz)	6dB BANDWIDTH (MHz)			MINIMUM LIMIT (MHz)	PASS / FAIL
		CHAIN 0	CHAIN 1	CHAIN 2		
151	5755	36.45	36.47	36.46	0.5	PASS
159	5795	36.42	36.47	36.44	0.5	PASS

802.11ac (VHT80)

CHANNEL	CHANNEL FREQUENCY (MHz)	6dB BANDWIDTH (MHz)			MINIMUM LIMIT (MHz)	PASS / FAIL
		CHAIN 0	CHAIN 1	CHAIN 2		
155	5775	75.91	76.27	76.44	0.5	PASS



A D T

SPECTRUM PLOT OF WORST VALUE

802.11a / CH157

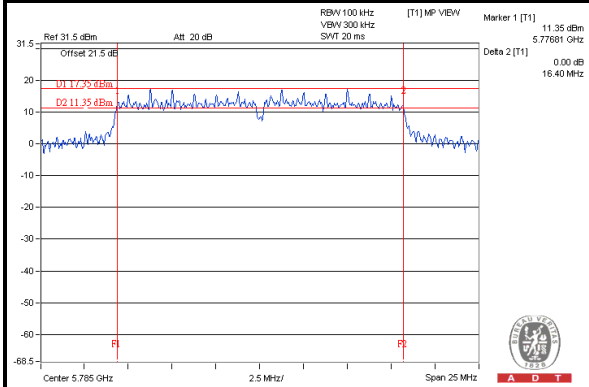

802.11ac (VHT20)_Chain 0 / CH149

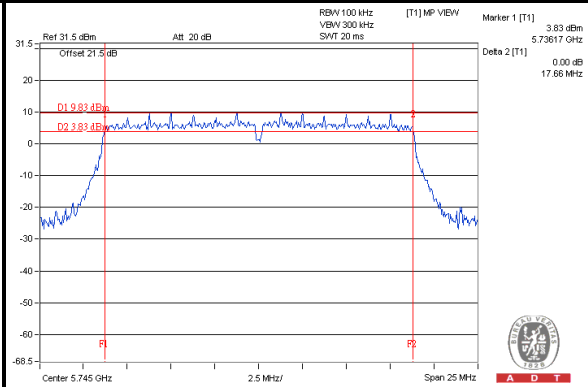

802.11ac (VHT40)_Chain 0 / CH159

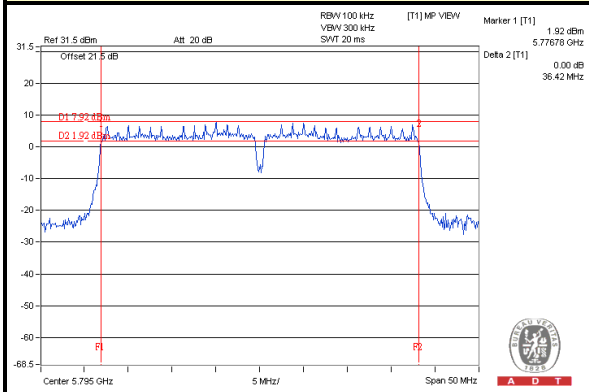

802.11ac (VHT80)_Chain 0 / CH155

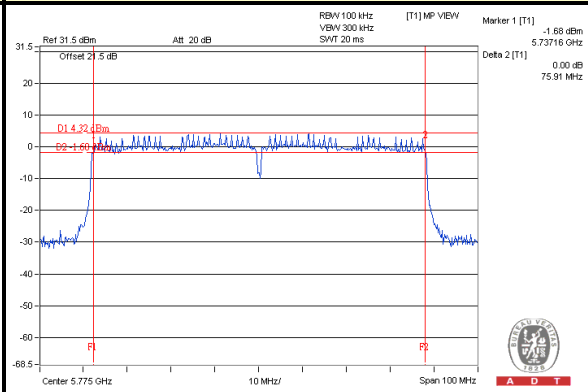

5.4 CONDUCTED OUTPUT POWER MEASUREMENT

5.4.1 LIMITS OF CONDUCTED OUTPUT POWER MEASUREMENT

For systems using digital modulation in the 5725 –5850 MHz band: 1 Watt (30dBm)

Per KDB 662911 D01 Multiple Transmitter Output v01r02 Method of conducted output power measurement on IEEE 802.11 devices,

Array Gain = 0 dB (i.e., no array gain) for NANT \leq 4;

Array Gain = 0 dB (i.e., no array gain) for channel widths \geq 40 MHz for any NANT;

Array Gain = $5 \log(\text{NANT}/\text{NSS})$ dB or 3 dB, whichever is less for 20-MHz channel widths with NANT \geq 5.

For power measurements on all other devices: Array Gain = $10 \log(\text{NANT}/\text{NSS})$ dB.

5.4.2 INSTRUMENTS

DESCRIPTION & MANUFACTURER	MODEL NO.	SERIAL NO.	CALIBRATED DATE	CALIBRATED UNTIL
Power meter Anritsu	ML2495A	0824006	May 20, 2013	May 19, 2014
Power sensor Anritsu	MA2411B	0738172	May 20, 2013	May 19, 2014

Note:

1. The calibration interval of the above test instruments is 12 months and the calibrations are traceable to NML/ROC and NIST/USA.
2. Tested date : Jan. 02, 2014

5.4.3 TEST PROCEDURES

Method PM is used to perform output power measurement, trigger and gating function of wide band power meter is enabled to measure max output power of TX on burst. Duty factor is not added to measured value.



A D T

5.4.4 DEVIATION FROM TEST STANDARD

No deviation.

5.4.5 TEST SETUP

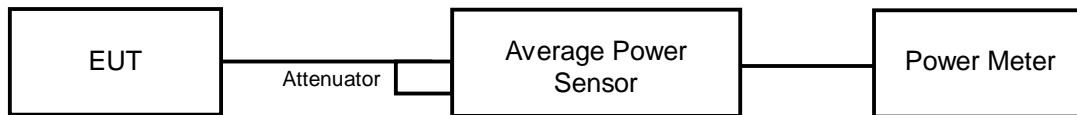

5.4.6 EUT OPERATING CONDITIONS

Same as Item 5.3.6

5.4.7 TEST RESULTS

802.11a

CHANNEL	FREQUENCY (MHz)	AVERAGE POWER (mW)	AVERAGE POWER (dBm)	LIMIT (dBm)	PASS/FAIL
149	5745	395.367	25.97	30	PASS
157	5785	503.501	27.02	30	PASS
165	5825	278.612	24.45	30	PASS

802.11ac (VHT20)

CHANNEL	FREQUENCY (MHz)	AVERAGE POWER (dBm)			TOTAL POWER (mW)	TOTAL POWER (dBm)	LIMIT (dBm)	PASS / FAIL
		CHAIN 0	CHAIN 1	CHAIN 2				
149	5745	20.85	21.02	20.39	357.489	25.53	25.61	PASS
157	5785	19.42	19.77	18.98	261.408	24.17	25.61	PASS
165	5825	19.47	19.75	18.86	259.831	24.15	25.61	PASS

NOTE: 1. Directional gain = $10 \log[(10^{G1/20} + 10^{G2/20} + 10^{G3/20})^2 / 3]$ = 10.39dBi > 6dBi , so the power limit shall be reduced to $30-(10.39-6) = 25.61$ dBm.

802.11ac (VHT40)

CHANNEL	FREQUENCY (MHz)	AVERAGE POWER (dBm)			TOTAL POWER (mW)	TOTAL POWER (dBm)	LIMIT (dBm)	PASS / FAIL
		CHAIN 0	CHAIN 1	CHAIN 2				
151	5755	20.24	20.84	20.12	329.823	25.18	25.61	PASS
159	5795	20.67	21.21	20.43	359.219	25.55	25.61	PASS

NOTE: 1. Directional gain = $10 \log[(10^{G1/20} + 10^{G2/20} + 10^{G3/20})^2 / 3]$ = 10.39dBi > 6dBi , so the power limit shall be reduced to $30-(10.39-6) = 25.61$ dBm.

802.11ac (VHT80)

CHANNEL	FREQUENCY (MHz)	AVERAGE POWER (dBm)			TOTAL POWER (mW)	TOTAL POWER (dBm)	LIMIT (dBm)	PASS / FAIL
		CHAIN 0	CHAIN 1	CHAIN 2				
155	5775	20.25	20.91	20.84	350.574	25.45	25.61	PASS

NOTE: 1. Directional gain = $10 \log[(10^{G1/20} + 10^{G2/20} + 10^{G3/20})^2 / 3]$ = 10.39dBi > 6dBi , so the power limit shall be reduced to $30-(10.39-6) = 25.61$ dBm.

5.5 POWER SPECTRAL DENSITY MEASUREMENT

5.5.1 LIMITS OF POWER SPECTRAL DENSITY MEASUREMENT

The Maximum of Power Spectral Density Measurement is 8dBm.

5.5.2 TEST INSTRUMENTS

DESCRIPTION & MANUFACTURER	MODEL NO.	SERIAL NO.	CALIBRATED DATE	CALIBRATED UNTIL
Spectrum Analyzer R&S	FSP 40	100036	Jan. 21, 2013	Jan. 20, 2014

Note:

1. The calibration interval of the above test instruments is 12 months and the calibrations are traceable to NML/ROC and NIST/USA.
2. Tested date : Jan. 02, 2014

5.5.3 TEST PROCEDURE

1. Set the RBW = 30 kHz, VBW = 100 kHz, Detector = power averaging (RMS).
2. Ensure that the number of measurement points in the sweep $\geq 2 \times$ span/RBW
3. Sweep time = auto couple,
4. Employ trace averaging (RMS) mode over a minimum of 100 traces.
5. Use the peak marker function to determine the maximum amplitude level.

5.5.4 DEVIATION FROM TEST STANDARD

No deviation

5.5.5 TEST SETUP

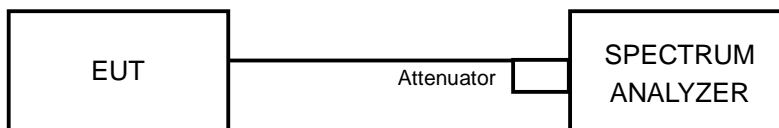

5.5.6 EUT OPERATING CONDITION

Same as Item 4.3.6



A D T

5.5.7 TEST RESULTS

802.11a

CHANNEL	FREQUENCY (MHz)	PSD (dBm)	LIMIT (dBm)	PASS /FAIL
149	5745	-4.31	8	PASS
157	5785	-3.29	8	PASS
165	5825	-5.93	8	PASS

802.11ac (VHT20)

TX CHAIN	CHANNEL	FREQUENCY (MHz)	PSD (dBm)	10 log (N=3) dB	TOTAL PSD (dBm)	LIMIT (dBm)	PASS /FAIL
0	149	5745	-9.35	4.77	-4.58	3.61	PASS
	157	5785	-11.24	4.77	-6.47	3.61	PASS
	165	5825	-10.84	4.77	-6.07	3.61	PASS
1	149	5745	-9.45	4.77	-4.68	3.61	PASS
	157	5785	-10.34	4.77	-5.57	3.61	PASS
	165	5825	-10.83	4.77	-6.06	3.61	PASS
2	149	5745	-10.05	4.77	-5.28	3.61	PASS
	157	5785	-11.18	4.77	-6.41	3.61	PASS
	165	5825	-11.54	4.77	-6.77	3.61	PASS

NOTE: 1. Directional gain = $10 \log[(10^{G1/20} + 10^{G2/20} + 10^{G3/20})^2 / 3] = 10.39\text{dBi} > 6\text{dBi}$, so the power density limit shall be reduced to $8-(10.39-6) = 3.61\text{dBm}$.

802.11ac (VHT40)

TX CHAIN	CHANNEL	FREQUENCY (MHz)	PSD (dBm)	10 log (N=3) dB	TOTAL PSD (dBm)	LIMIT (dBm)	PASS /FAIL
0	151	5755	-12.30	4.77	-7.53	3.61	PASS
	159	5795	-12.36	4.77	-7.59	3.61	PASS
1	151	5755	-11.88	4.77	-7.11	3.61	PASS
	159	5795	-11.93	4.77	-7.16	3.61	PASS
2	151	5755	-12.77	4.77	-8.00	3.61	PASS
	159	5795	-12.58	4.77	-7.81	3.61	PASS

NOTE: 1. Directional gain = $10 \log[(10^{G1/20} + 10^{G2/20} + 10^{G3/20})^2 / 3] = 10.39\text{dBi} > 6\text{dBi}$, so the power density limit shall be reduced to $8-(10.39-6) = 3.61\text{dBm}$.



A D T

802.11ac (VHT80)

TX CHAIN	CHANNEL	FREQ. (MHz)	PSD W/O DUTY FACTOR (dBm)	10 log (N=3) dB	DUTY FACTOR (dB)	TOTAL PSD WITH DUTY FACTOR (dBm)	LIMIT (dBm)	PASS /FAIL
0	155	5775	-16.59	4.77	0.16	-11.66	3.61	PASS
1	155	5775	-15.84	4.77	0.16	-10.91	3.61	PASS
2	155	5775	-15.95	4.77	0.16	-11.02	3.61	PASS

NOTE: 1. Directional gain = $10 \log[(10^{G1/20} + 10^{G2/20} + 10^{G3/20})^2 / 3] = 10.39\text{dBi} > 6\text{dBi}$, so the power density limit shall be reduced to $8-(10.39-6) = 3.61\text{dBm}$.

2. Refer to section 3.4 for duty cycle spectrum plot.



A D T

SPECTRUM PLOT OF WORST VALUE

802.11a / CH157

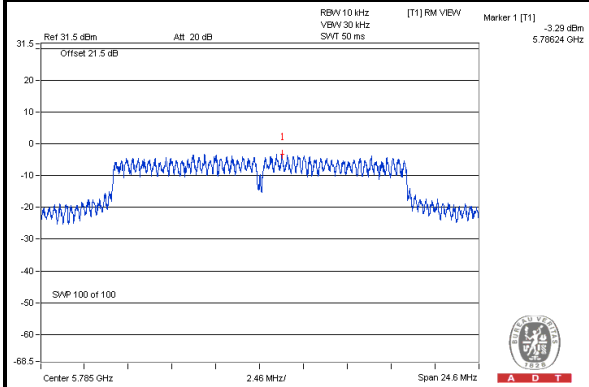

802.11ac (VHT20) Chain 0 / CH149

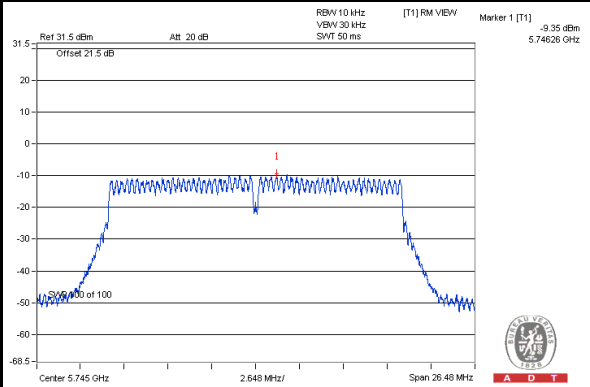

802.11ac (VHT40) Chain 1 / CH151

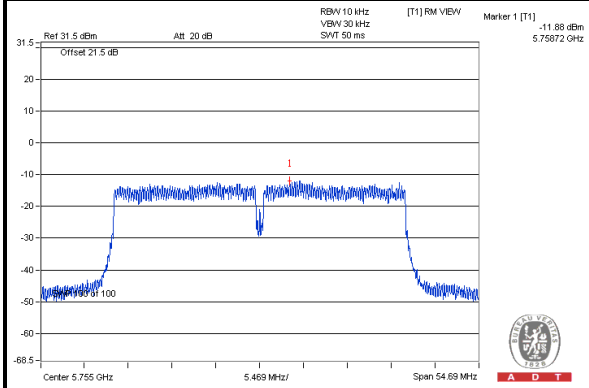

802.11ac (VHT80) Chain 1 / CH155

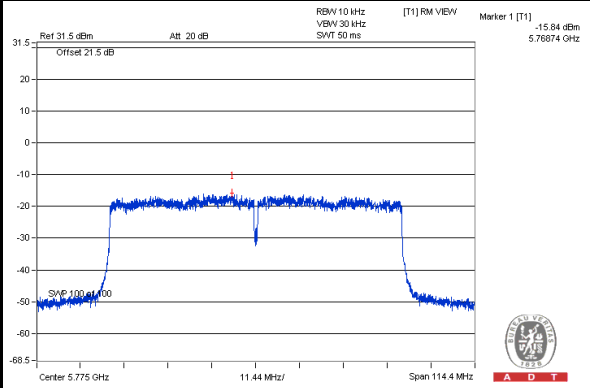

5.6 CONDUCTED OUT-BAND EMISSION MEASUREMENT

5.6.1 LIMITS OF CONDUCTED OUT-BAND EMISSION MEASUREMENT

Below 30dB of the highest emission level of operating band (in 100kHz Resolution Bandwidth).

5.6.2 TEST INSTRUMENTS

DESCRIPTION & MANUFACTURER	MODEL NO.	SERIAL NO.	CALIBRATED DATE	CALIBRATED UNTIL
Spectrum Analyzer R&S	FSP 40	100036	Jan. 21, 2013	Jan. 20, 2014

Note:

1. The calibration interval of the above test instruments is 12 months and the calibrations are traceable to NML/ROC and NIST/USA.
2. Tested date : Jan. 02, 2014

5.6.3 TEST PROCEDURE

Measurement Procedure - Reference Level

1. Set the RBW = 100 kHz.
2. Set the VBW \geq 300 kHz.
3. Detector = peak.
4. Sweep time = auto couple.
5. Trace mode = max hold.
6. Allow trace to fully stabilize.
7. Use the peak marker function to determine the maximum power level in any 100 kHz band segment within the fundamental EBW.

Measurement Procedure –Unwanted Emission Level

1. Set RBW = 100 kHz.
2. Set VBW \geq 300 kHz.
3. Set span to encompass the spectrum to be examined
4. Detector = peak.
5. Trace Mode = max hold.
6. Sweep = auto couple.

5.6.4 DEVIATION FROM TEST STANDARD

No deviation

5.6.5 TEST SETUP

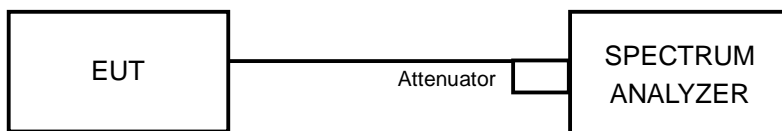

5.6.6 EUT OPERATING CONDITION

Same as Item 4.3.6

5.6.7 TEST RESULTS

The spectrum plots are attached on the following pages. D1 line indicates the highest level, and D2 line indicates the 30dB offset below D1. It shows compliance with the requirement.



A D T

802.11a:

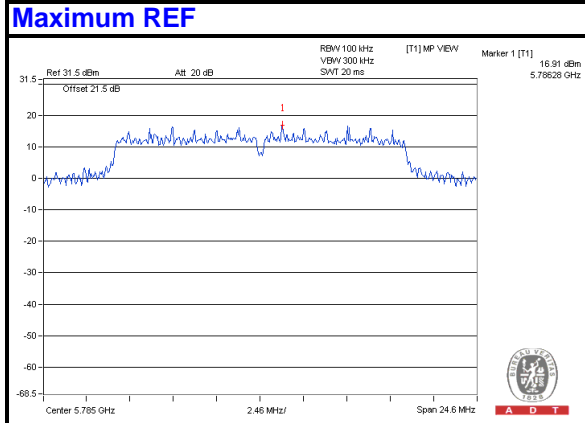

CH 149

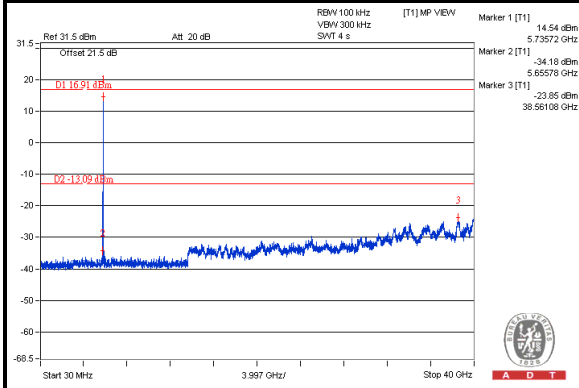

CH 157

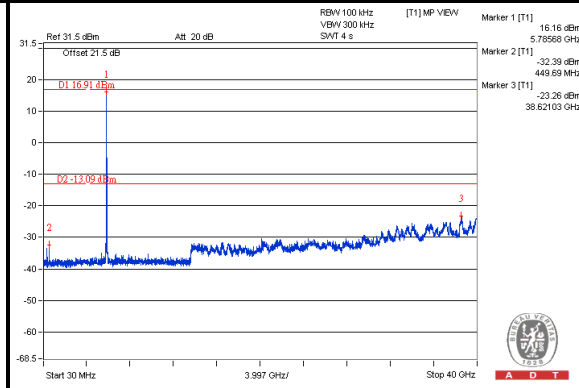

CH 165

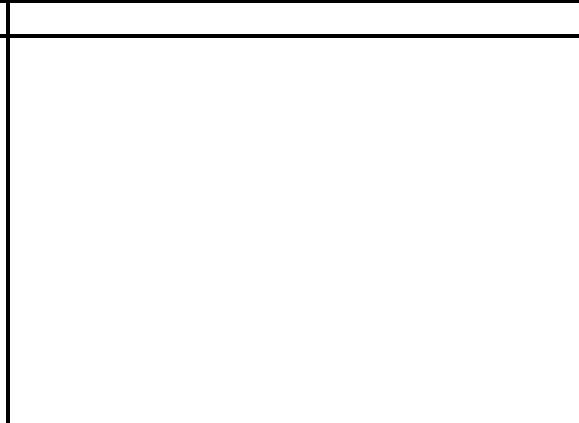
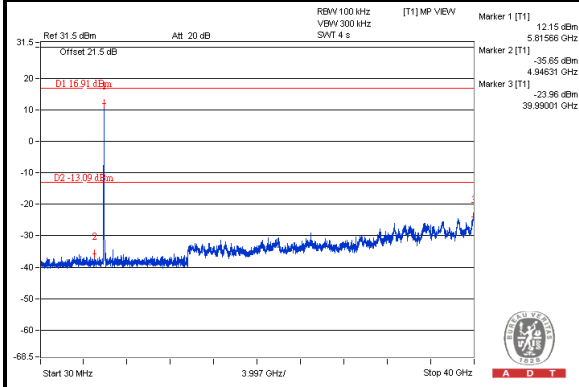

CH 149 Band edge

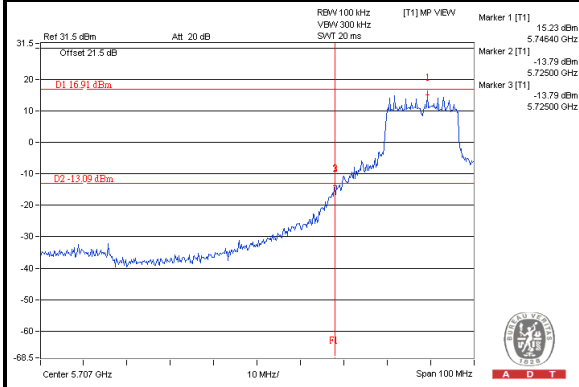

CH 165 Band edge

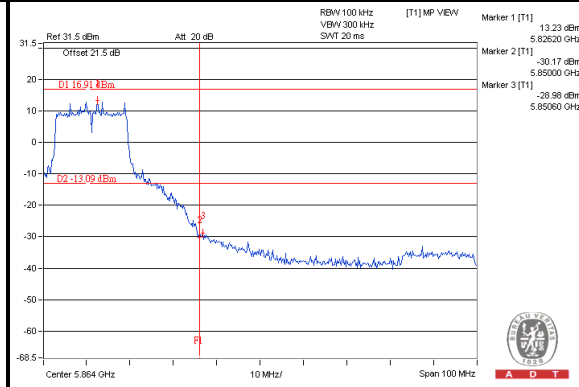



A D T

802.11ac (VHT20):

Maximum REF

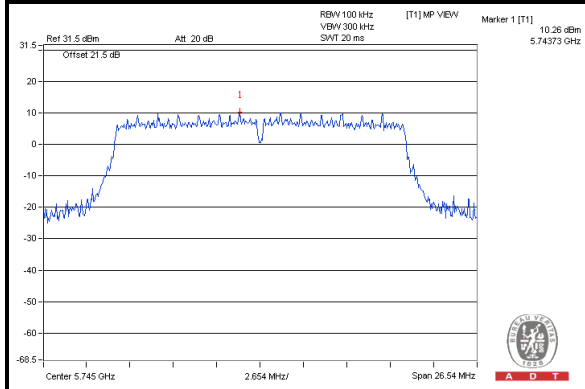

Chain(0)

CH 149

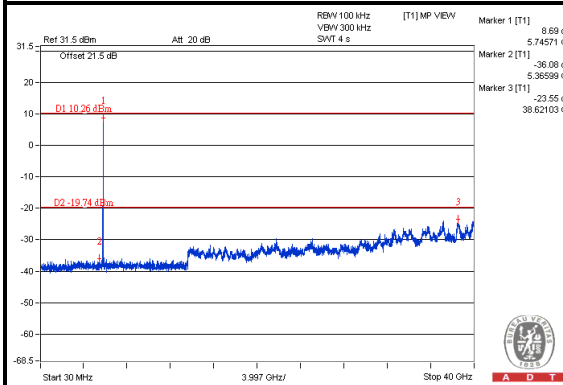

CH 157

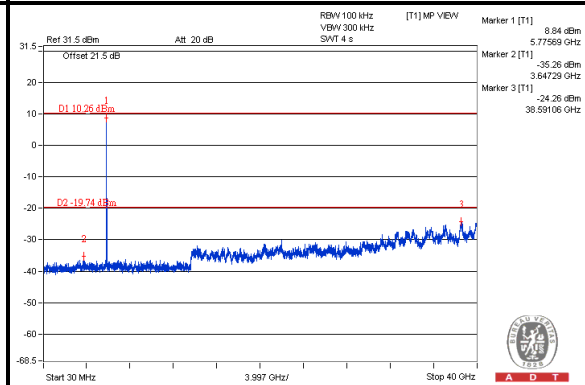

CH 165

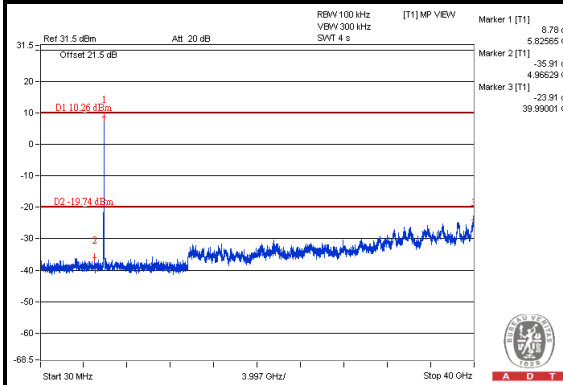

CH 149 Band edge

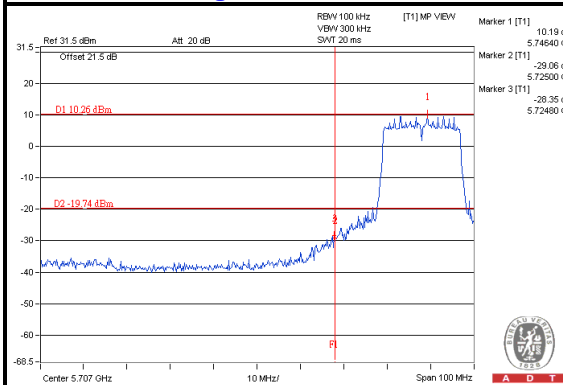

CH 165 Band edge

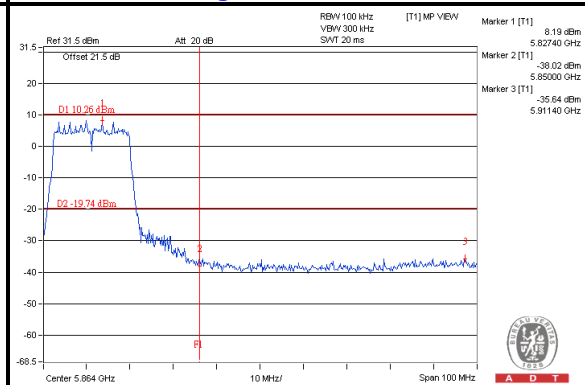



A D T

Chain(1)

CH 149

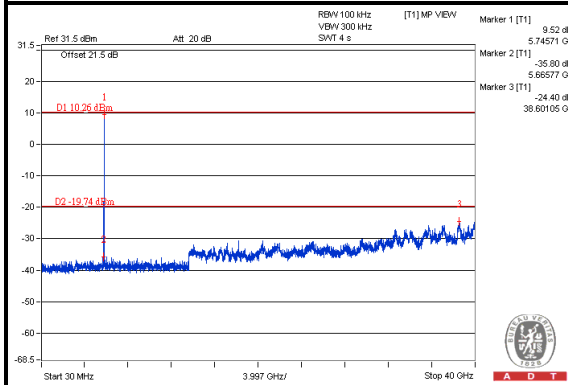

CH 157

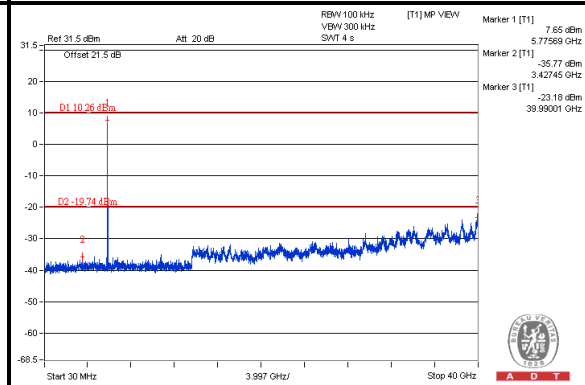

CH 165

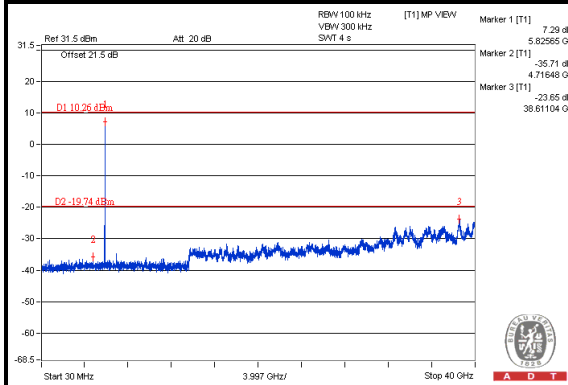

CH 149 Band edge

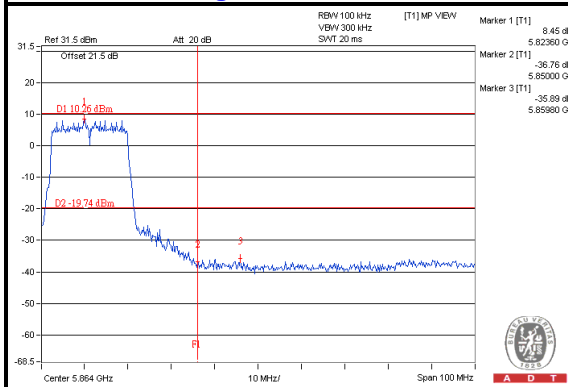

CH 165 Band edge

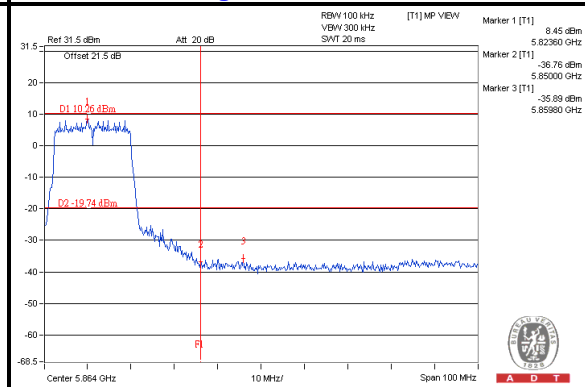



A D T

Chain(2)

CH 149

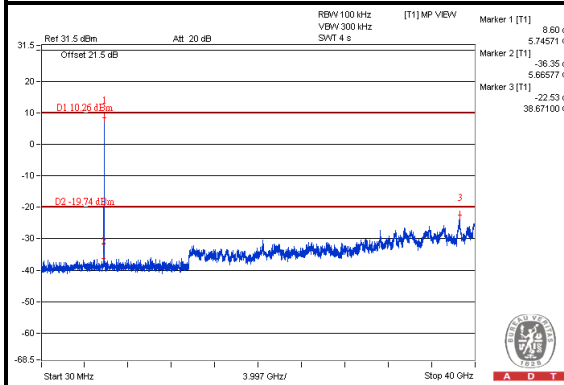

CH 157

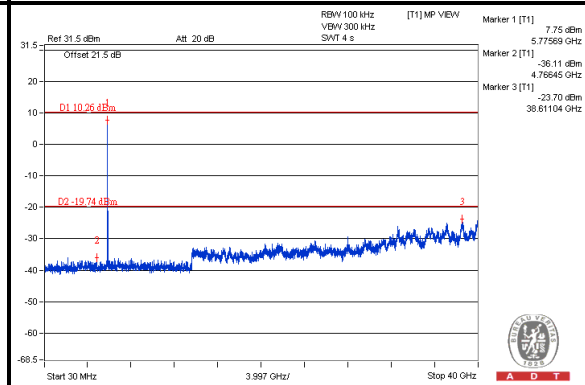

CH 165

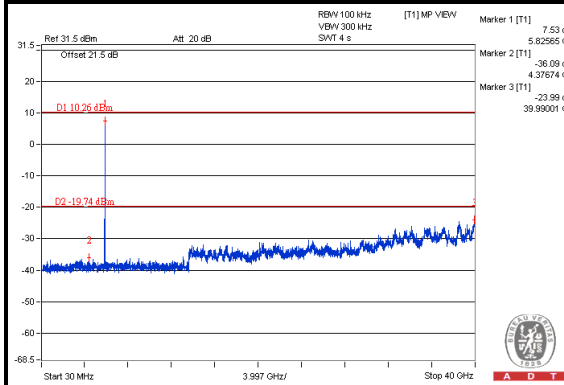

CH 149 Band edge

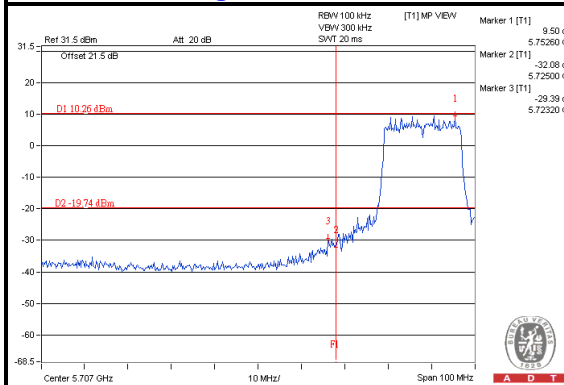

CH 165 Band edge

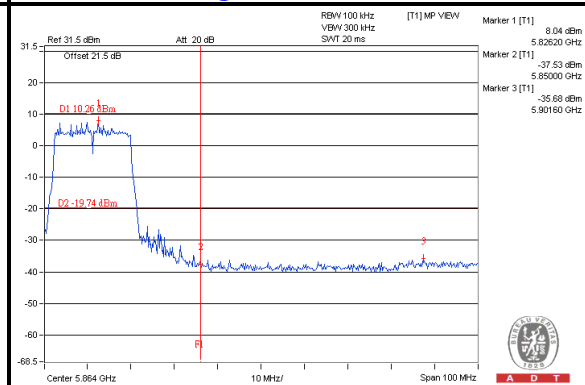



A D T

802.11ac (VHT40):

Maximum REF

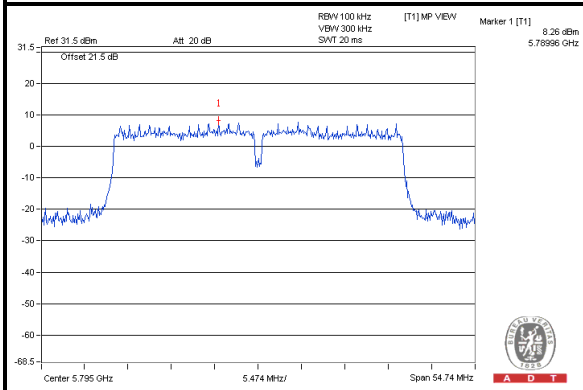

Chain(0)

CH 151

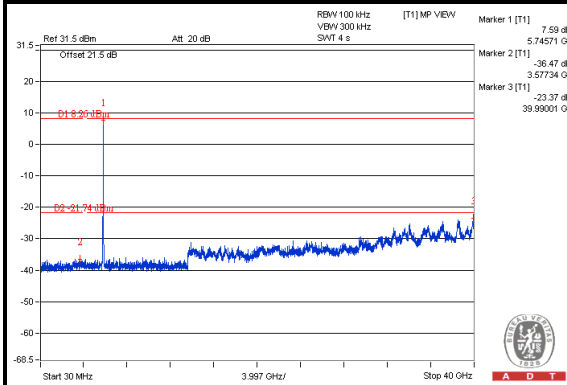

CH 159

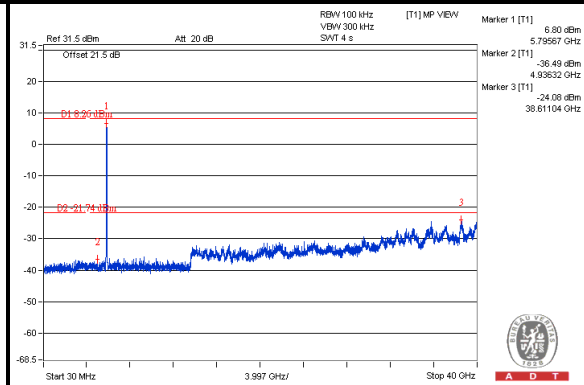

CH 151 Band edge

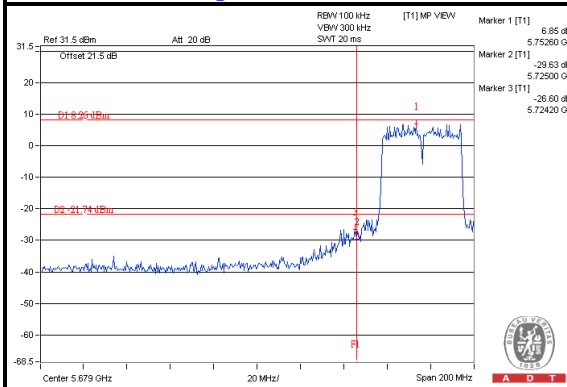

CH 159 Band edge

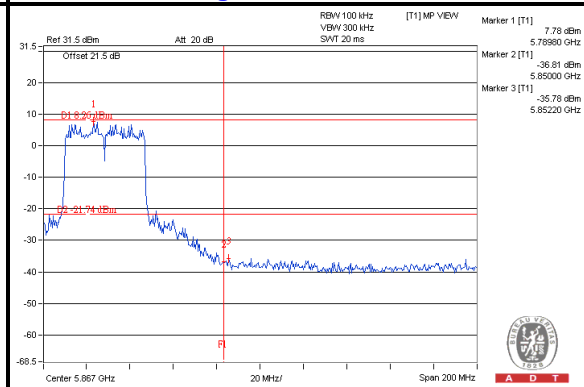



A D T

Chain(1)

CH 151

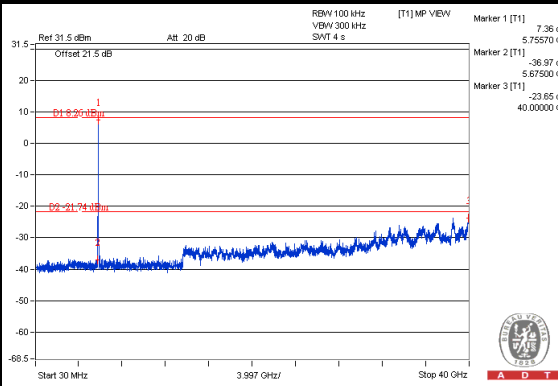

CH 159

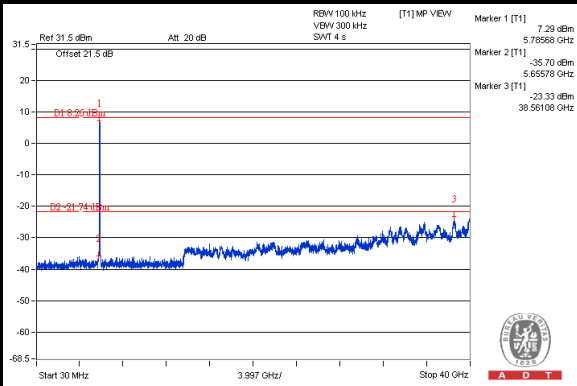

CH 151 Band edge

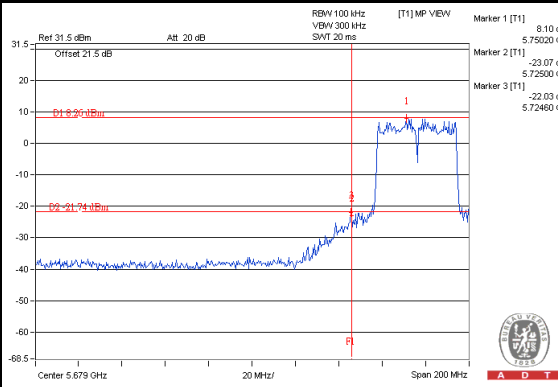

CH 159 Band edge

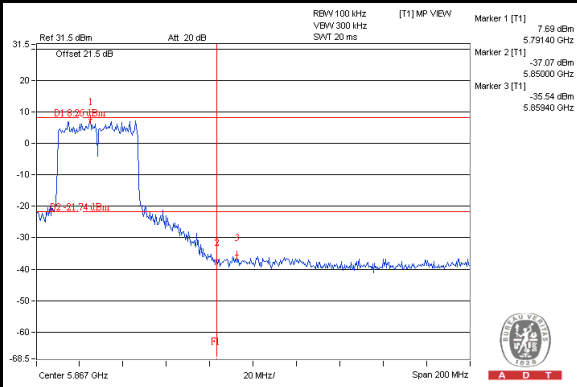



A D T

Chain(2)

CH 151

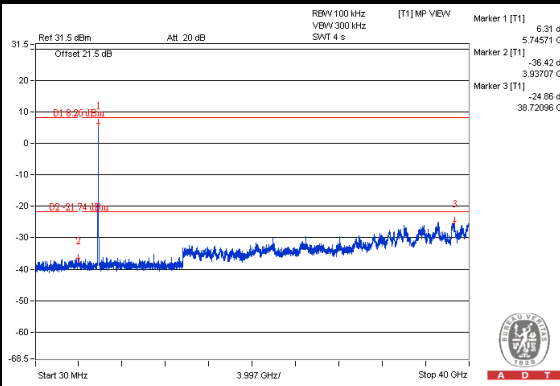

CH 159

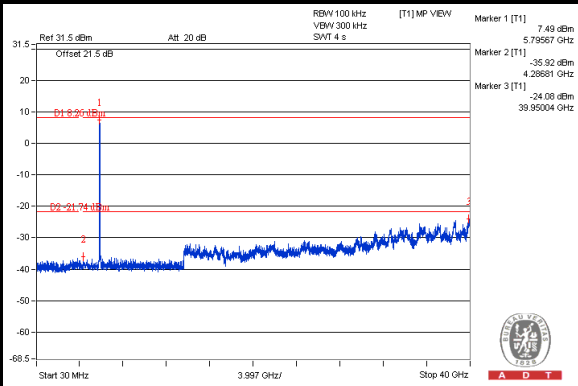

CH 151 Band edge

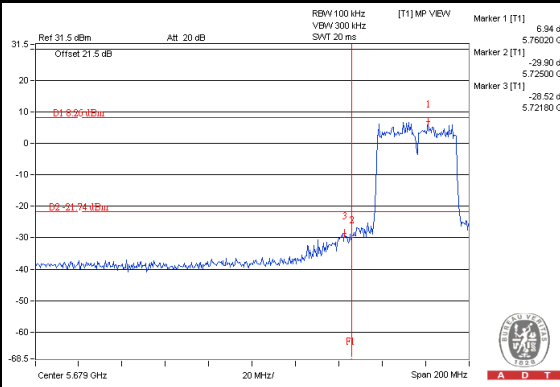

CH 159 Band edge

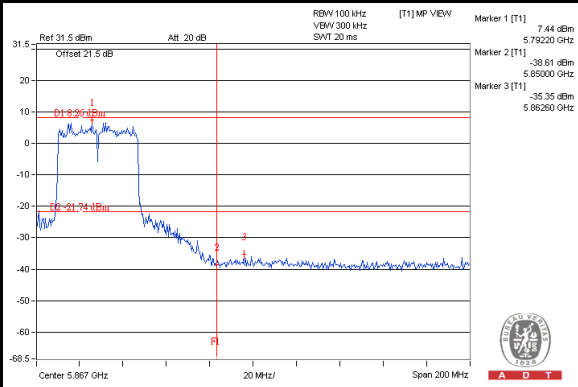



A D T

802.11ac (VHT80):

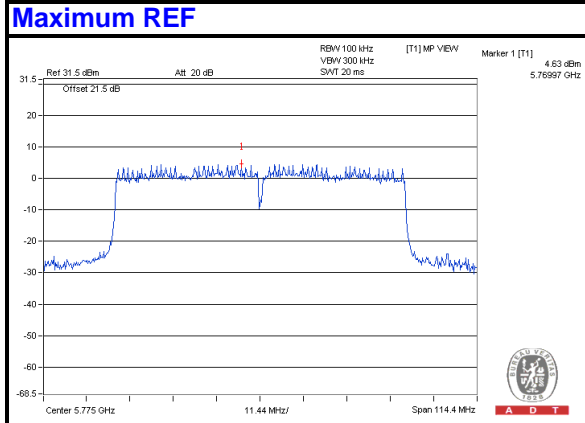

Chain(0) CH 155

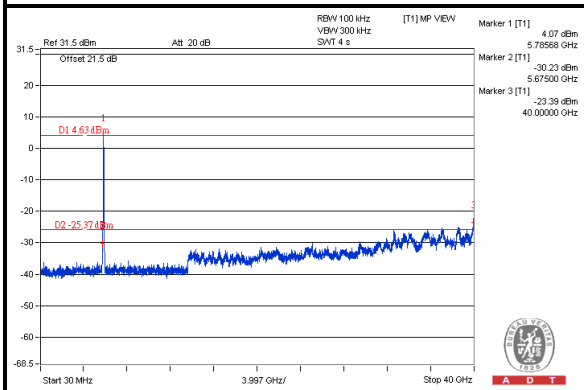

CH 155 Band edge (Left)

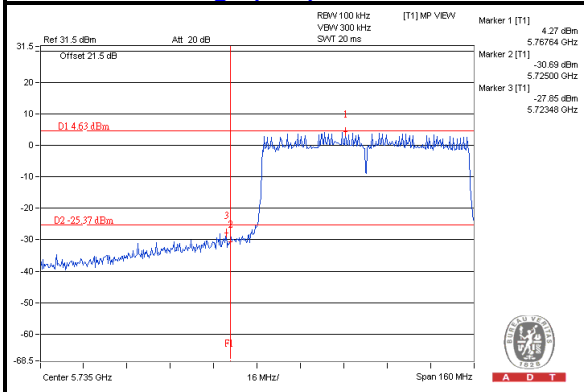

CH 155 Band edge (Right)

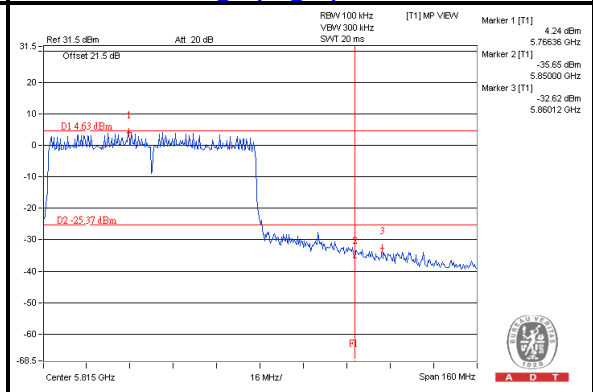



A D T

Chain(1) CH 155

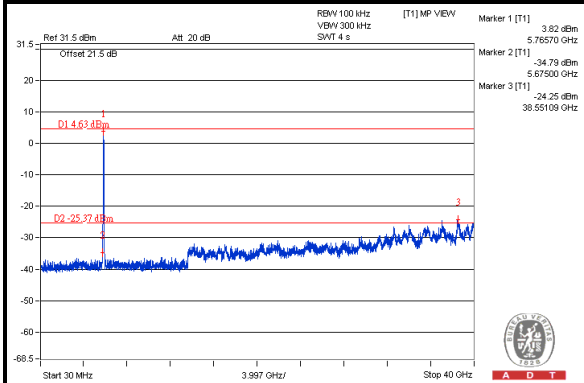

CH 155 Band edge (Left)

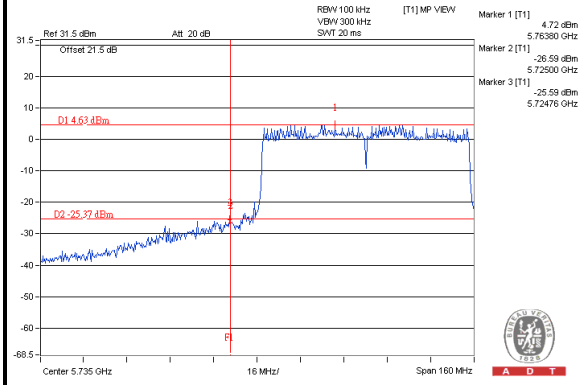

CH 155 Band edge (Right)

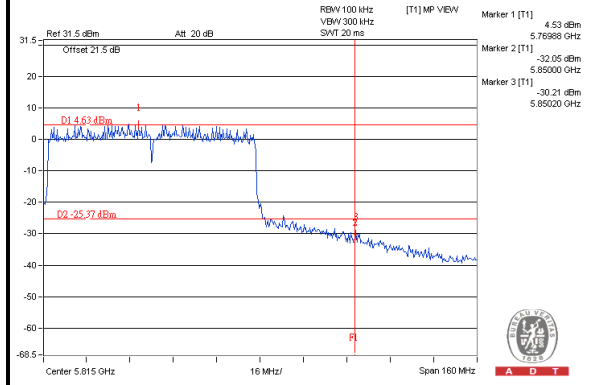



A D T

Chain(2) CH 155

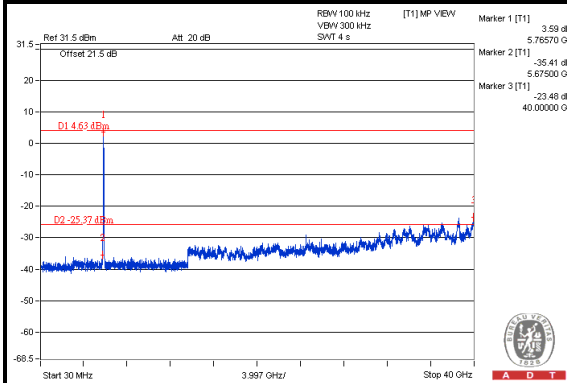

CH 155 Band edge (Left)

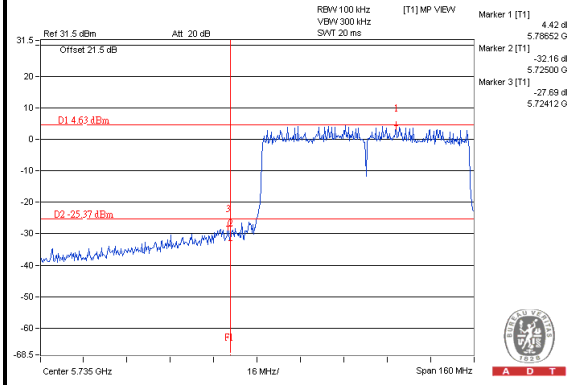

CH 155 Band edge (Right)

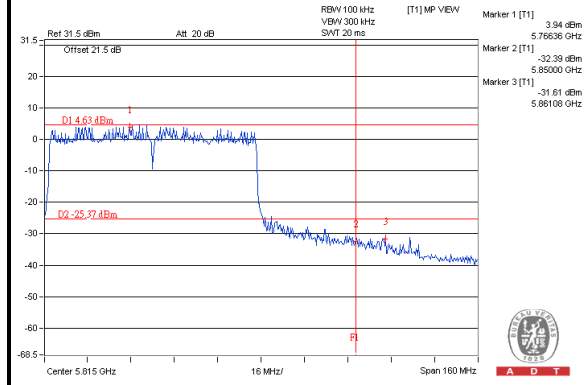



A D T

6. PHOTOGRAPHS OF THE TEST CONFIGURATION

Please refer to the attached file (Test Setup Photo).



7. INFORMATION ON THE TESTING LABORATORIES

We, Bureau Veritas Consumer Products Services (H.K.) Ltd., Taoyuan Branch, were founded in 1988 to provide our best service in EMC, Radio, Telecom and Safety consultation. Our laboratories are accredited and approved according to ISO/IEC 17025.

If you have any comments, please feel free to contact us at the following:

Linko EMC/RF Lab:

Tel: 886-2-26052180

Fax: 886-2-26052943

Hsin Chu EMC/RF Lab:

Tel: 886-3-5935343

Fax: 886-3-5935342

Hwa Ya EMC/RF/Safety/Telecom Lab:

Tel: 886-3-3183232

Fax: 886-3-3270892

Email: service.adt@tw.bureauveritas.com

Web Site: www.bureauveritas-adt.com

The address and road map of all our labs can be found in our web site also.



A D T

8. APPENDIX A - MODIFICATIONS RECORDERS FOR ENGINEERING CHANGES TO THE EUT BY THE LAB

No modifications were made to the EUT by the lab during the test.

--- END ---