

# FCC Co-Location Test Report

**FCC ID** : XU8TEW817DTR  
**Equipment** : AC750 Wireless Travel Router  
**Model No.** : TEW-817DTR  
**Brand Name** : TRENDnet  
**Applicant** : TRENDnet, Inc.  
**Address** : 20675 Manhattan Place, Torrance, CA 90501,  
USA  
**Standard** : 47 CFR FCC Part 15.247  
47 CFR FCC Part 15.407  
**Received Date** : Sep. 04, 2014  
**Tested Date** : Sep. 10, 2014

We, International Certification Corp., would like to declare that the tested sample has been evaluated and in compliance with the requirement of the above standards. The test results contained in this report refer exclusively to the product. It may be duplicated completely for legal use with the approval of the applicant. It shall not be reproduced except in full without the written approval of our laboratory.

Approved & Reviewed by:

  
\_\_\_\_\_  
Gary Chang / Manager



---

## Table of Contents

<b>1</b>	<b>GENERAL DESCRIPTION .....</b>	<b>5</b>
1.1	Information.....	5
1.2	The Equipment List .....	7
1.3	Test Standards .....	8
1.4	Measurement Uncertainty .....	8
<b>2</b>	<b>TEST CONFIGURATION .....</b>	<b>9</b>
2.1	Testing Condition .....	9
2.2	The Worst Test Modes and Channel Details .....	9
<b>3</b>	<b>TRANSMITTER TEST RESULTS.....</b>	<b>10</b>
3.1	Unwanted Emissions into Restricted Frequency Bands .....	10
<b>4</b>	<b>TEST LABORATORY INFORMATION .....</b>	<b>17</b>

---

## Release Record

Report No.	Version	Description	Issued Date
FR4N1401	Rev. 01	Initial issue	Mar. 06, 2015
FR4N1401	Rev. 02	Removed model of antenna. (Page 5)	Mar. 27, 2015

---

## Summary of Test Results

FCC Rules	Test Items	Measured	Result
15.247(d) 15.407(b) 15.209	Radiated Emissions	[dBuV/m at 3m]: 31.85MHz 35.72 (Margin -4.28dB) – PK	Pass

# 1 General Description

## 1.1 Information

### 1.1.1 Specification of the Equipment under Test (EUT)

RF General Information					
Frequency Range (MHz)	IEEE Std. 802.11	Ch. Freq. (MHz)	Channel Number	Transmit Chains (N <sub>TX</sub> )	Data Rate / MCS
2400-2483.5	b	2412-2462	1-11 [11]	1 <sup>NOTE 4</sup>	1-11 Mbps
2400-2483.5	g	2412-2462	1-11 [11]	1 <sup>NOTE 4</sup>	6-54 Mbps
2400-2483.5	n (HT20)	2412-2462	1-11 [11]	2	MCS 0-15
2400-2483.5	n (HT40)	2422-2452	3-9 [7]	2	MCS 0-15

Note 1: RF output power specifies that Maximum Peak Conducted Output Power.  
 Note 2: 802.11b uses a combination of DSSS-DBPSK, DQPSK, CCK modulation.  
 Note 3: 802.11g/n uses a combination of OFDM-BPSK, QPSK, 16QAM, 64QAM modulation.  
 Note 4: 802.11b/g is transmitting signal through chain 0 only.

RF General Information					
Frequency Range (MHz)	IEEE Std. 802.11	Ch. Freq. (MHz)	Channel Number	Transmit Chains (N <sub>TX</sub> )	Data Rate / MCS
5150-5250	a	5180-5240	36-48 [4]	1	6-54 Mbps
5150-5250	n (HT20)	5180-5240	36-48 [4]	1	MCS 0-7
5150-5250	n (HT40)	5190-5230	38-46 [2]	1	MCS 0-7
5150-5250	ac (VHT20)	5180-5240	36-48 [4]	1	MCS 0-8
5150-5250	ac (VHT40)	5190-5230	38-46 [2]	1	MCS 0-9
5150-5250	ac (VHT80)	5210	42 [1]	1	MCS 0-9

Note 1: RF output power specifies that Maximum Conducted Output Power.  
 Note 2: 802.11a/n/ac uses a combination of OFDM-BPSK, QPSK, 16QAM, 64QAM, 256QAM modulation.

RF General Information					
Frequency Range (MHz)	IEEE Std. 802.11	Ch. Freq. (MHz)	Channel Number	Transmit Chains (N <sub>TX</sub> )	Data Rate / MCS
5725-5850	a	5745-5825	149-165 [5]	1	6-54 Mbps
5725-5850	n (HT20)	5745-5825	149-165 [5]	1	MCS 0-7
5725-5850	n (HT40)	5755-5795	151-159 [2]	1	MCS 0-7
5725-5850	ac (VHT20)	5745-5825	149-165 [5]	1	MCS 0-8
5725-5850	ac (VHT40)	5755-5795	151-159 [2]	1	MCS 0-9
5725-5850	ac (VHT80)	5775	155 [1]	1	MCS 0-9

Note 1: RF output power specifies that Maximum Conducted Output Power.  
 Note 2: 802.11a/n/ac uses a combination of OFDM-BPSK, QPSK, 16QAM, 64QAM, 256QAM modulation.

### 1.1.2 Antenna Details

Ant. No.	Type	Connector	Operating Frequencies (MHz) / Antenna Gain (dBi)				
			2400~2483.5	5150~5250	5250~5350	5470~5725	5725~5850
1	PIFA	N/A	2	3	3	3	3

### 1.1.3 Accessories

N/A

## 1.2 The Equipment List

<b>Test Item</b>	Radiated Emission				
<b>Test Site</b>	966 chamber1 / (03CH01-WS)				
<b>Test Date</b>	Sep. 10, 2014				
<b>Instrument</b>	<b>Manufacturer</b>	<b>Model No.</b>	<b>Serial No.</b>	<b>Calibration Date</b>	<b>Calibration Until</b>
Spectrum Analyzer	R&S	FSV40	101498	Jan. 25, 2014	Jan. 24, 2015
Receiver	R&S	ESR3	101658	Jan. 10, 2014	Jan. 09, 2015
Bilog Antenna	SCHWARZBECK	VULB9168	VULB9168-522	Jan. 03, 2014	Jan. 02, 2015
Horn Antenna 1G-18G	SCHWARZBECK	BBHA 9120 D	BBHA 9120 D 1096	Feb. 13, 2014	Feb. 12, 2015
Horn Antenna 18G-40G	SCHWARZBECK	BBHA 9170	BBHA 9170517	Dec. 27, 2013	Dec. 26, 2014
Amplifier	Burgeon	BPA-530	100219	Nov. 22, 2013	Nov. 21, 2014
Preamplifier	Agilent	83017A	MY39501308	Dec. 16, 2013	Dec. 15, 2014
Preamplifier	EMC	EMC184045B	980192	Aug. 26, 2014	Aug. 25, 2015
RF Cable	HUBER+SUHNER	SUCOFLEX104	MY16014/4	Dec. 16, 2013	Dec. 15, 2014
RF Cable	HUBER+SUHNER	SUCOFLEX104	MY16019/4	Dec. 16, 2013	Dec. 15, 2014
RF Cable	HUBER+SUHNER	SUCOFLEX104	MY16139/4	Dec. 16, 2013	Dec. 15, 2014
LF cable 3M	Woken	CFD400NL-LW	CFD400NL-001	Dec. 16, 2013	Dec. 15, 2014
LF cable 10M	Woken	CFD400NL-LW	CFD400NL-002	Dec. 16, 2013	Dec. 15, 2014
Measurement Software	AUDIX	e3	6.120210g	NA	NA

Note: Calibration Interval of instruments listed above is one year.

Loop Antenna	R&S	HFH2-Z2	100330	Nov. 15, 2012	Nov. 14, 2014
--------------	-----	---------	--------	---------------	---------------

Note: Calibration Interval of instruments listed above is two year.

### 1.3 Test Standards

According to the specification of EUT, the EUT must comply with following standards and KDB documents.

47 CFR FCC Part 15.247

47 CFR FCC Part 15.407

ANSI C63.10-2009

FCC KDB 789033 D02 General UNII Test Procedures New Rules v01

FCC KDB 644545 D03 Guidance for IEEE 802 11ac New Rules v01

FCC KDB 558074 D01 DTS Meas Guidance v03r02

FCC KDB 662911 D01 Multiple Transmitter Output v02r01

FCC KDB 412172 D01 Determining ERP and EIRP v01

### 1.4 Measurement Uncertainty

ISO/IEC 17025 requires that an estimate of the measurement uncertainties associated with the emissions test results be included in the report. The measurement uncertainties given below are based on a 95% confidence level (based on a coverage factor (k=2))

Measurement Uncertainty	
Parameters	Uncertainty
Radiated emission	±2.49 dB



## 2 Test Configuration

### 2.1 Testing Condition

Test Item	Test Site	Ambient Condition	Tested By
Radiated Emissions	03CH01-WS	22°C / 61%	Aska Huang

- FCC site registration No.: 657002
- IC site registration No.: 10807A-1

### 2.2 The Worst Test Modes and Channel Details

Test item	Modulation Mode	Test Channel	Data rate (Mbps) / MCS	Test Configuration
Radiated Emissions	2.4G 11n 20 + 5G 11a	CH6 + CH157	MCS 0 + MCS 0	---

**NOTE:** The selected channel is the maximum power channel of each band

## 3 Transmitter Test Results

### 3.1 Unwanted Emissions into Restricted Frequency Bands

#### 3.1.1 Limit of Unwanted Emissions into Restricted Frequency Bands

Restricted Band Emissions Limit			
Frequency Range (MHz)	Field Strength (uV/m)	Field Strength (dBuV/m)	Measure Distance (m)
0.009~0.490	2400/F(kHz)	48.5 - 13.8	300
0.490~1.705	24000/F(kHz)	33.8 - 23	30
1.705~30.0	30	29	30
30~88	100	40	3
88~216	150	43.5	3
216~960	200	46	3
Above 960	500	54	3

**Note 1:**  
Qusai-Peak value is measured for frequency below 1GHz except for 9–90 kHz, 110–490 kHz frequency band. Peak and average value are measured for frequency above 1GHz. The limit on average radio frequency emission is as above table. The limit on peak radio frequency emissions is 20 dB above the maximum permitted average emission limit

**Note 2:**  
Measurements may be performed at a distance other than what is specified provided. When performing measurements at a distance other than that specified, the results shall be extrapolated to the specified distance using an extrapolation factor as below, Frequency at or above 30 MHz: 20 dB/decade Frequency below 30 MHz: 40 dB/decade.

#### 3.1.2 Test Procedures

1. Measurement is made at a semi-anechoic chamber that incorporates a turntable allowing a EUT rotation of 360°. A continuously-rotating, remotely-controlled turntable is installed at the test site to support the EUT and facilitate determination of the direction of maximum radiation for each EUT emission frequency. The EUT is placed at a height of 0.8 m test table above the ground plane.
2. Measurement is made with the antenna positioned in both the horizontal and vertical planes of polarization. The measurement antenna is varied in height (1m ~ 4m) above the reference ground plane to obtain the maximum signal strength. Distance between EUT and antenna is 3 m.
3. This investigation is performed with the EUT rotated 360°, the antenna height scanned between 1 m and 4 m, and the antenna rotated to repeat the measurements for both the horizontal and vertical antenna polarizations.

**Note:**

1. 120kHz measurement bandwidth of test receiver and Quasi-peak detector is for radiated emission below 1GHz.
2. RBW=1MHz, VBW=3MHz and Peak detector is for peak measured value of radiated emission above 1GHz.
3. RBW=1MHz, VBW=1/T and Peak detector is for average measured value of radiated emission above 1GHz.

### 3.1.3 Test Setup

#### Radiated Emissions below 1 GHz

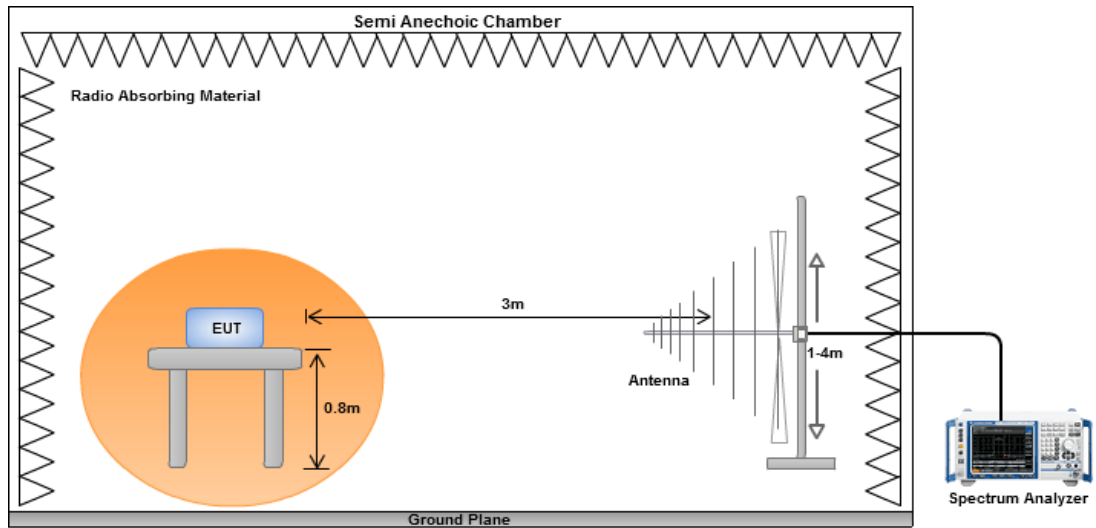

#### Radiated Emissions above 1 GHz

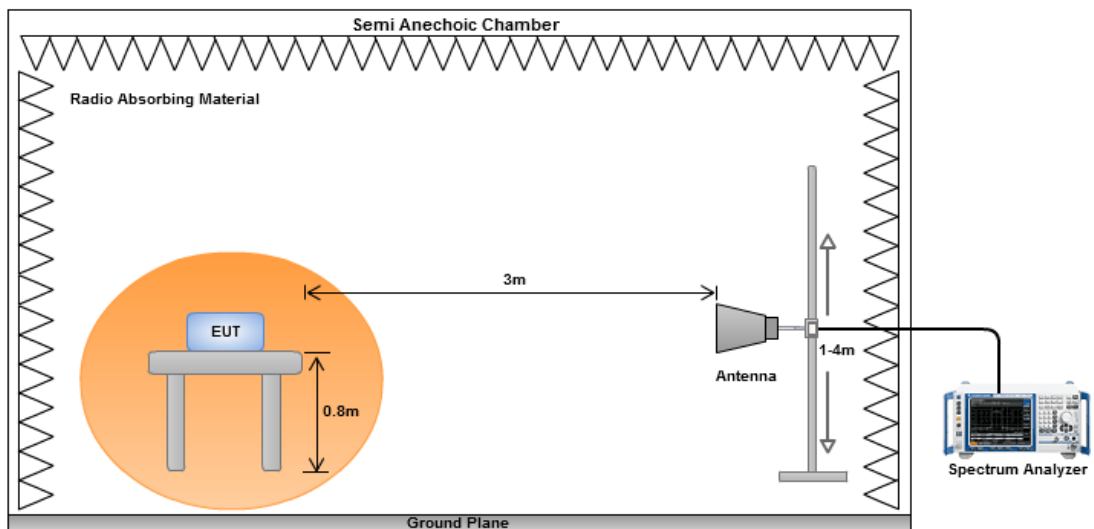

#### Conducted Emission

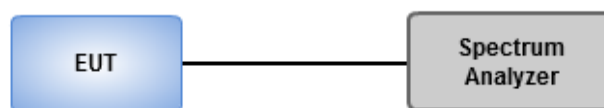

### 3.1.4 Transmitter Radiated Unwanted Emissions (Below 1GHz)

<b>Modulation</b>	2.4G 11n 20 + 5G 11a	<b>Test Channel</b>	CH6 + CH157	
<b>Polarization</b>	Horizontal			

  

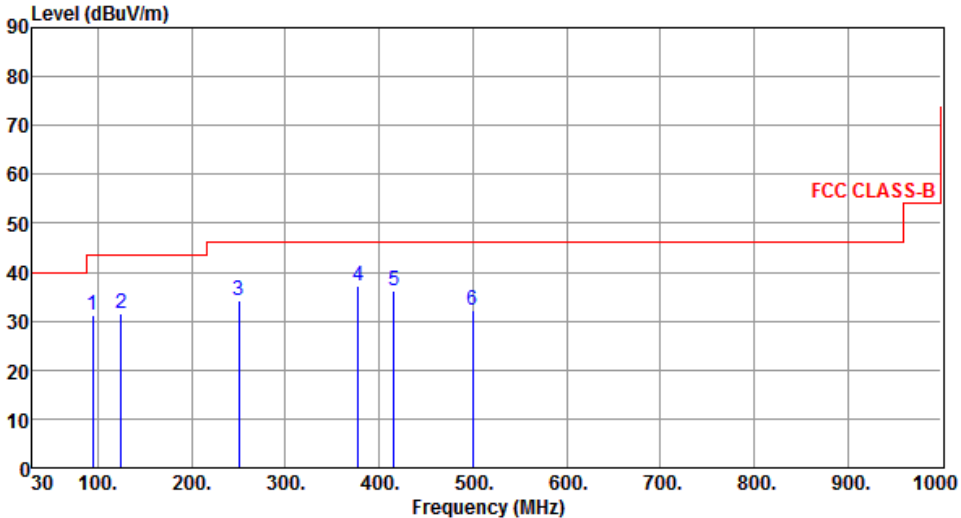

	Freq. MHz	Emission level dBuV/m	Limit dBuV/m	Margin dB	SA reading dBuV	Factor dB	Remark	ANT High cm	Turn Table deg
1	94.62	31.17	43.50	-12.33	53.65	-22.48	Peak	---	---
2	125.16	31.68	43.50	-11.82	50.39	-18.71	Peak	---	---
3	250.06	34.30	46.00	-11.70	52.23	-17.93	Peak	---	---
4	377.83	37.07	46.00	-8.93	51.35	-14.28	Peak	---	---
5	415.68	36.34	46.00	-9.66	49.64	-13.30	Peak	---	---
6	500.16	32.11	46.00	-13.89	43.66	-11.55	Peak	---	---

Note 1: Emission Level (dBuV/m) = SA Reading (dBuV/m) + Factor\* (dB)  
\*Factor includes antenna factor , cable loss and amplifier gain  
Note 2: Margin (dB) = Emission level (dBuV/m) – Limit (dBuV/m).

<b>Modulation</b>	2.4G 11n 20 + 5G 11a	<b>Test Channel</b>	CH6 + CH157
<b>Polarization</b>	Vertical		

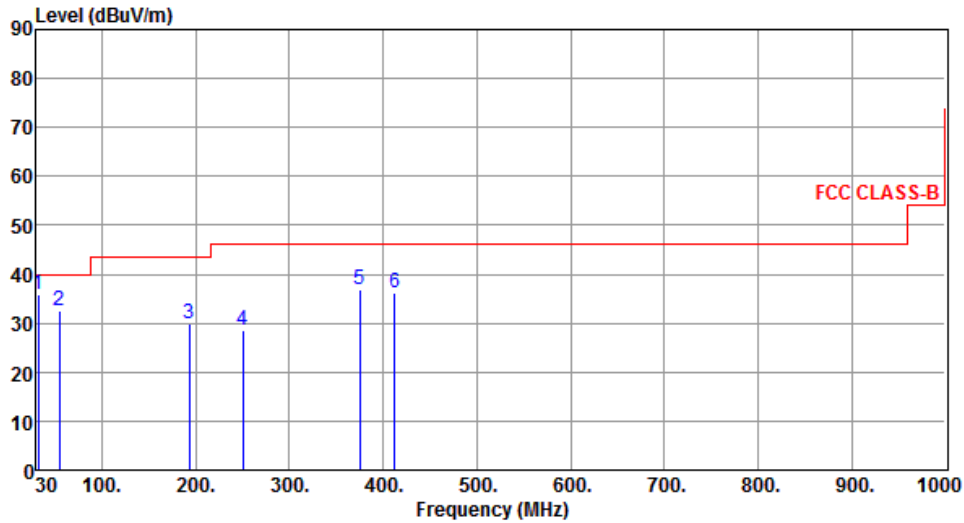

	Freq. MHz	Emission level dBuV/m	Limit dBuV/m	Margin dB	SA reading dBuV	Factor dB	Remark	ANT High cm	Turn Table deg
1	31.85	35.72	40.00	-4.28	53.31	-17.59	Peak	---	---
2	54.53	32.51	40.00	-7.49	49.33	-16.82	Peak	---	---
3	193.36	30.01	43.50	-13.49	49.62	-19.61	Peak	---	---
4	250.13	28.46	46.00	-17.54	46.39	-17.93	Peak	---	---
5	375.26	36.96	46.00	-9.04	51.30	-14.34	Peak	---	---
6	412.28	36.29	46.00	-9.71	49.65	-13.36	Peak	---	---

Note 1: Emission Level (dBuV/m) = SA Reading (dBuV/m) + Factor\* (dB)

\*Factor includes antenna factor , cable loss and amplifier gain

Note 2: Margin (dB) = Emission level (dBuV/m) – Limit (dBuV/m).

### 3.1.5 Transmitter Radiated Unwanted Emissions (Above 1GHz)

<b>Modulation</b>	2.4G 11n 20 + 5G 11a	<b>Test Channel</b>	CH6 + CH157	
<b>Polarization</b>	Horizontal			

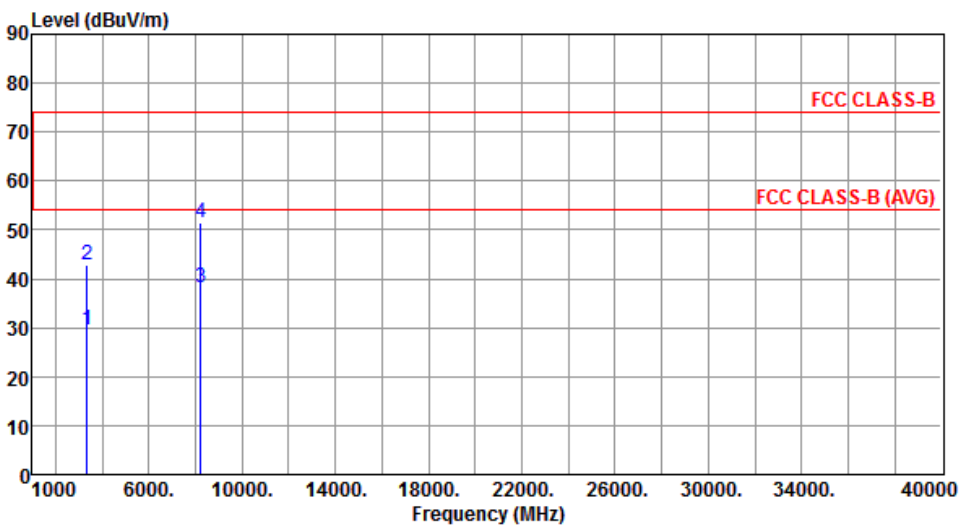

The graph plots Level (dBuV/m) on the y-axis (0 to 90) against Frequency (MHz) on the x-axis (1000 to 40000). Two horizontal red lines represent FCC CLASS-B (at ~75 dBuV/m) and FCC CLASS-B (AVG) (at ~55 dBuV/m). Two vertical blue lines indicate emission peaks: peak 2 at 3348 MHz and peak 4 at 8222 MHz. Peak 4 is significantly higher than the FCC CLASS-B limit.

	Freq. MHz	Emission level dBuV/m	Limit dBuV/m	Margin dB	SA reading dBuV	Factor dB	Remark	ANT High cm	Turn Table deg
1	3348.00	29.58	54.00	-24.42	30.15	-0.57	Average	---	---
2	3348.00	42.74	74.00	-31.26	43.31	-0.57	Peak	---	---
3	8222.00	38.36	54.00	-15.64	27.88	10.48	Average	---	---
4	8222.00	51.33	74.00	-22.67	40.85	10.48	Peak	---	---

Note 1: Emission Level (dBuV/m) = SA Reading (dBuV/m) + Factor\* (dB)  
\*Factor includes antenna factor , cable loss and amplifier gain  
Note 2: Margin (dB) = Emission level (dBuV/m) – Limit (dBuV/m).

<b>Modulation</b>	2.4G 11n 20 + 5G 11a	<b>Test Channel</b>	CH6 + CH157
<b>Polarization</b>	Vertical		

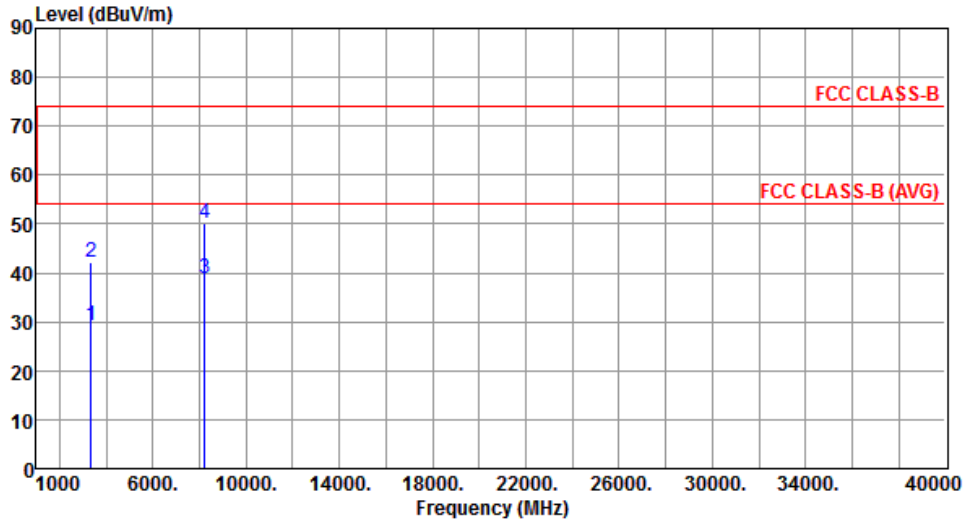

	Freq. MHz	Emission level dBuV/m	Limit dBuV/m	Margin dB	SA reading dBuV	Factor dB	Remark	ANT High cm	Turn Table deg
1	3348.00	29.09	54.00	-24.91	29.66	-0.57	Average	---	---
2	3348.00	42.10	74.00	-31.90	42.67	-0.57	Peak	---	---
3	8222.00	38.70	54.00	-15.30	28.22	10.48	Average	---	---
4	8222.00	50.09	74.00	-23.91	39.61	10.48	Peak	---	---

Note 1: Emission Level (dBuV/m) = SA Reading (dBuV/m) + Factor\* (dB)

\*Factor includes antenna factor , cable loss and amplifier gain

Note 2: Margin (dB) = Emission level (dBuV/m) – Limit (dBuV/m).

### 3.1.6 Conducted Emissions

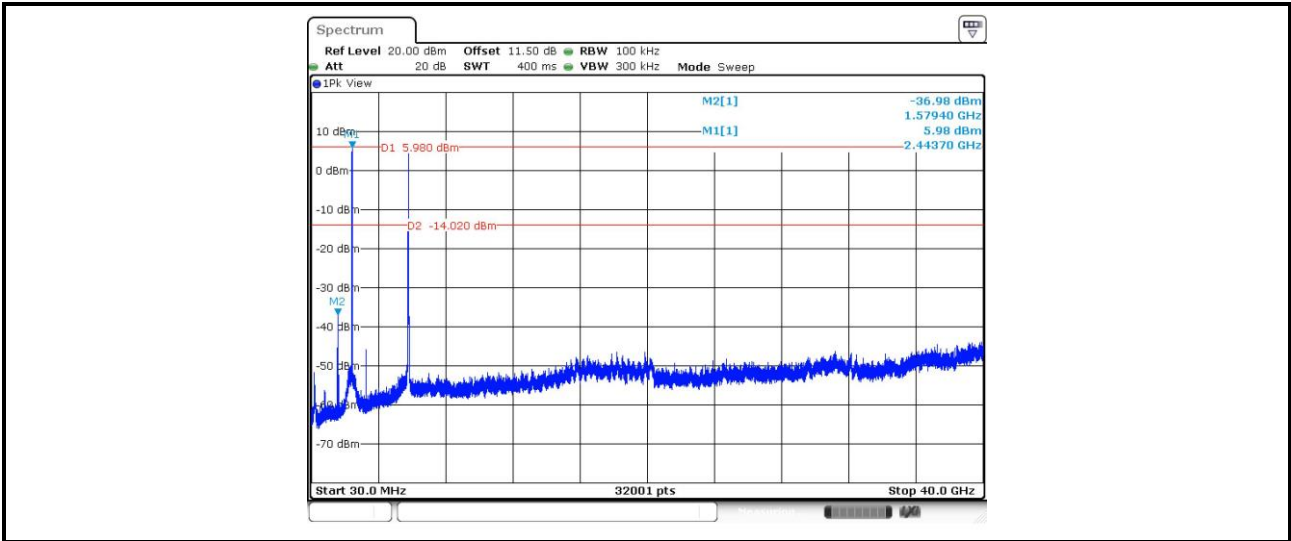



## 4 Test laboratory information

Established in 2012, ICC provides foremost EMC & RF Testing and advisory consultation services by our skilled engineers and technicians. Our services employ a wide variety of advanced edge test equipment and one of the widest certification extents in the business.

International Certification Corp, it is our definitive objective is to institute long term, trust-based associations with our clients. The expectation we set up with our clients is based on outstanding service, practical expertise and devotion to a certified value structure. Our passion is to grant our clients with best EMC / RF services by oriented knowledgeable and accommodating staff.

Our Test sites are located at Linkou District and Kwei Shan Hsiang. Location map can be found on our website <http://www.icertifi.com.tw>.

### **Linkou**

Tel: 886-2-2601-1640

No. 30-2, Ding Fwu Tsuen, Lin Kou  
District, New Taipei City, Taiwan,  
R.O.C.

### **Kwei Shan**

Tel: 886-3-271-8666

No. 3-1, Lane 6, Wen San 3rd  
St., Kwei Shan Hsiang, Tao Yuan  
Hsien 333, Taiwan, R.O.C.

### **Kwei Shan Site II**

Tel: 886-3-271-8640

No. 14-1, Lane 19, Wen San 3rd  
St., Kwei Shan Hsiang, Tao Yuan  
Hsien 333, Taiwan, R.O.C.

If you have any suggestion, please feel free to contact us as below information

Tel: 886-3-271-8666

Fax: 886-3-318-0155

Email: ICC\_Service@icertifi.com.tw

==END==